

FM Stereo FM-AM Receiver

Operating instructions _____	GB
使用説明書 _____	CT
使用说明书 _____	CS

STR-V323

WARNING

To prevent fire or shock hazard, do not expose the unit to rain or moisture.

To avoid electrical shock, do not open the cabinet. Refer servicing to qualified personnel only.

Do not install the appliance in a confined space, such as a bookcase or built-in cabinet.

Precautions

On safety

- Should any solid object or liquid fall into the cabinet, unplug the receiver and have it checked by qualified personnel before operating it any further.

On power sources

- Before operating the receiver, check that the operating voltage is identical with your local power supply. The operating voltage is indicated on the nameplate at the rear of the receiver.
- The receiver is not disconnected from the AC power source (MAINS) as long as it is connected to the wall outlet, even if the receiver itself has been turned off.
- If you are not going to use the receiver for a long time, be sure to disconnect the receiver from the wall outlet. To disconnect the AC power cord, grasp the plug itself; never pull the cord.
- Should the AC power cord need to be changed, have it done at a qualified service shop only.

On placement

- Place the receiver in a location with adequate ventilation to prevent heat build-up and prolong the life of the receiver.
- Do not place the receiver near heat sources, or in a place subject to direct sunlight, excessive dust or mechanical shock.
- Do not place anything on top of the cabinet that might block the ventilation holes and cause malfunctions.

On operation

- Before connecting other components, be sure to turn off and unplug the receiver.

On cleaning

- Clean the cabinet, panel and controls with a soft cloth slightly moistened with a mild detergent solution. Do not use any type of abrasive pad, scouring powder or solvent such as alcohol or benzine.

If you have any question or problem concerning your receiver, please consult your nearest Sony dealer.

About This Manual

The instructions in this manual is for model STR-V323. Check your model number by looking at the upper right corner of the front panel.

Conventions

The instructions in this manual describe the controls on the receiver. You can also use the controls on the remote if they have the same or similar names as those on the receiver.

- A “Quick Reference Guide” is supplied on page 25.
- The “Remote Button Descriptions” section on page 24 provides an overview of the remote buttons.
- The following icons are used in this manual:



Indicates that you can use only the remote to do the task.



Indicates hints and tips for making the task easier.

This receiver has the Dolby Surround system.

Manufactured under license from Dolby Laboratories Licensing Corporation. “Dolby”, “Pro Logic” and the double-D  symbol are trademarks of Dolby Laboratories Licensing Corporation.

TABLE OF CONTENTS

Getting Started

- Unpacking 4
- Hookup Overview 4
- Aerial Hookups 5
- Audio Component Hookups 6
- Video Component Hookups 6
- Speaker System Hookups 7
- AC Hookups 9
- Before You Use Your Receiver 9

Receiver Operations

- Selecting a Component 10
- Receiving Broadcasts 12
- Presetting Radio Stations 13
- Recording 14
- Using the Sleep Timer 14

Using Surround Sound

- Choosing a Sound Field 15
- Getting the Most Out of Dolby Pro Logic Surround Sound 16

Additional Information

- Troubleshooting 19
- Specifications 20
- Glossary 21

Index 22

Rear Panel Descriptions 23

Remote Button Descriptions 24

Quick Reference Guide 25

GB

Unpacking

Check that you received the following items with the receiver:

- FM wire aerial (1)
- AM loop aerial (1)
- Remote commander (remote) (1)
- Size AA (R6) batteries (2)

Inserting batteries into the remote

Insert two size AA (R6) batteries in accordance with the + and - markings on the battery compartment. When using the remote, point it at the remote sensor  on the receiver.

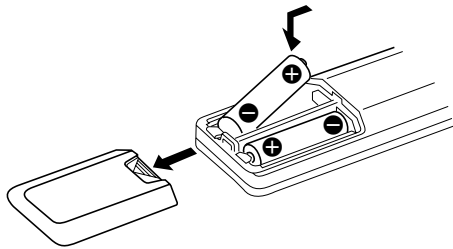

When to replace batteries

Under normal use, the batteries should last for about 6 months. When the remote no longer operates the receiver, replace both batteries with new ones.

Notes

- Do not leave the remote in an extremely hot or humid place.
- Do not use a new battery with an old one.
- Do not expose the remote sensor to direct sunlight or lighting apparatuses. Doing so may cause a malfunction.
- If you don't use the remote for an extended period of time, remove the batteries to avoid possible damage from battery leakage and corrosion.

Hookup Overview

The receiver allows you to connect and control the following audio/video components. Follow the hookup procedures for the components that you want to connect to the receiver on the pages specified. To learn the locations and names of each jack, see "Rear Panel Descriptions" on page 23.

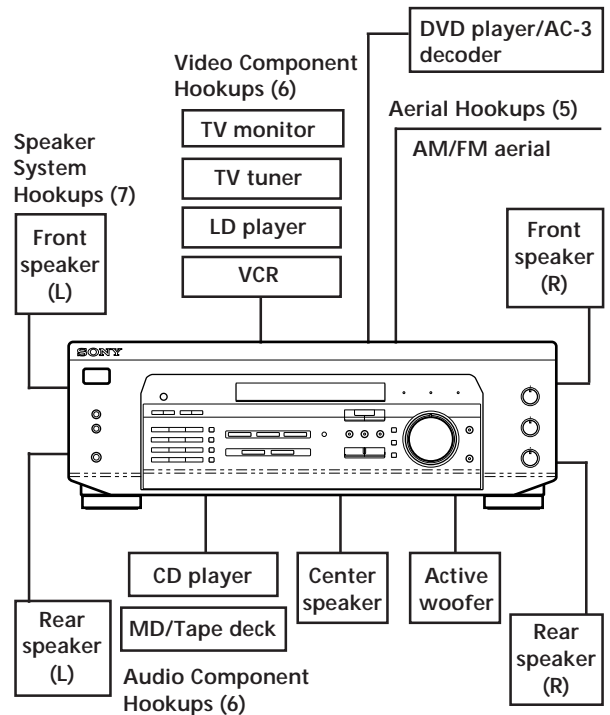

Before you get started

- Turn off the power to all components before making any connections.
- Do not connect the AC power cords until all of the connections are completed.
- Be sure to make connections firmly to avoid hum and noise.
- When connecting an audio/video cable, be sure to match the color-coded pins to the appropriate jacks on the components: Yellow (video) to Yellow; White (left, audio) to White; and Red (right, audio) to Red.

Aerial Hookups

Overview

This section describes how to connect AM and FM aerials to the receiver. If you want to receive radio broadcasts with the receiver, complete these connections first, then go to the following pages. For specific locations of the terminals, see the illustration below.

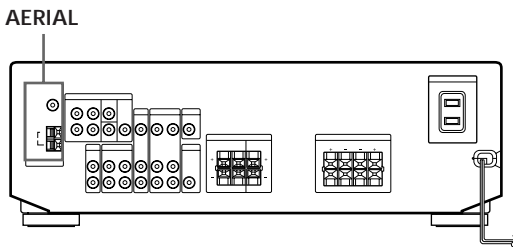

What aerials will I need?

- FM wire aerial (supplied) (1)
- AM loop aerial (supplied) (1)



Hookups

FM wire aerial

After connecting the wire aerial, keep it as horizontal as possible.

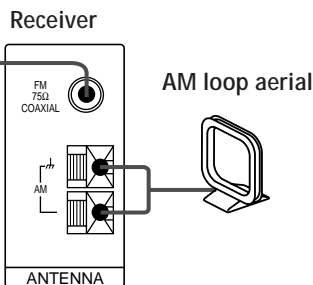

💡 If you have poor FM reception

Use a 75-ohm coaxial cable (not supplied) to connect the receiver to an outdoor FM aerial as shown below.

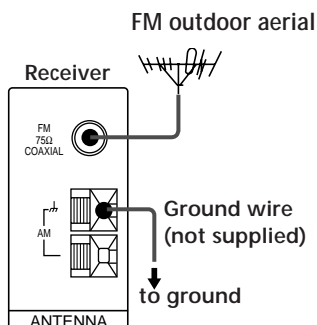

💡 If you have poor AM reception

Connect a 6 to 15-meter (20 to 50 ft.) insulated wire (not supplied) to the AM aerial terminal in addition to the AM loop aerial. Try to extend the wire outdoors and keep it horizontal.

Connecting a ground wire

If you connect the receiver to an outdoor aerial, ground it against lightning as shown in the illustration in the left column. To prevent a gas explosion, do not connect the ground wire to a gas pipe.

Where do I go next?

If you want to connect other components, go on to the next section. If you're only planning to use the receiver to listen to the radio, go to "Speaker System Hookups" on page 7.

Audio Component Hookups

Overview

This section describes how to connect your audio components to the receiver. If you want to use the receiver as an amplifier, complete these connections. For specific locations of the jacks, see the illustration below.

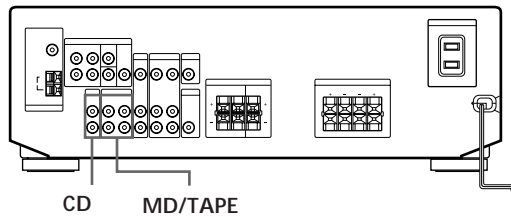

What cords will I need?

Audio cords (not supplied) (1 for CD player; 2 for each MD recorder or tape deck)

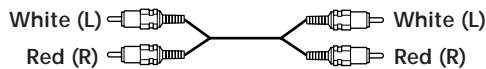

Hookups

The arrow \Rightarrow indicates signal flow.

CD player

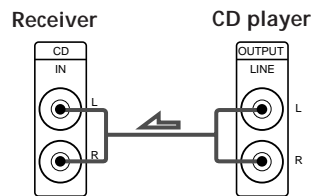

MD deck or Tape deck

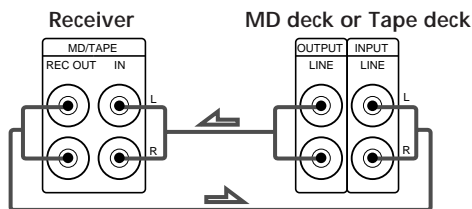

Where do I go next?

Go on to the next section to connect video components to enjoy surround sound when watching/listening to TV programmes or video tapes.

Video Component Hookups

Overview

This section describes how to connect video components to the receiver. For specific locations of the jacks, see the illustration below.

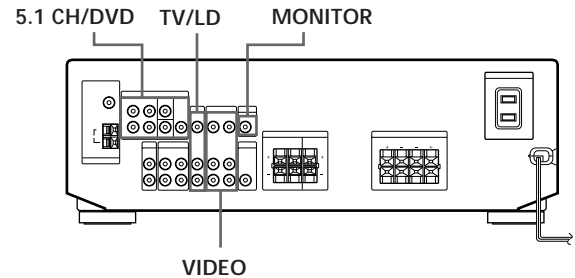

What cables will I need?

- Audio/video cable (not supplied) (1 for each TV tuner or LD player; 2 for the VCR)

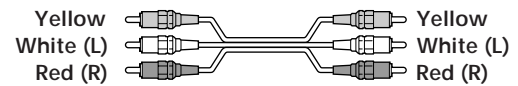

- Video cable (not supplied) (1 for a TV monitor)

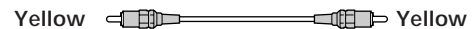

Hookups

The arrow \Rightarrow indicates signal flow.

You can listen to the sound from VCR or TV/LD by connecting the audio signal from VCR or TV/LD to the receiver.

TV/LD

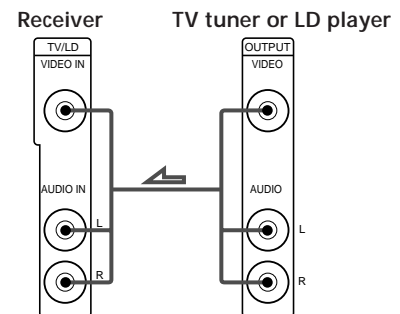

MONITOR

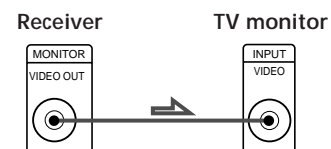

VCR

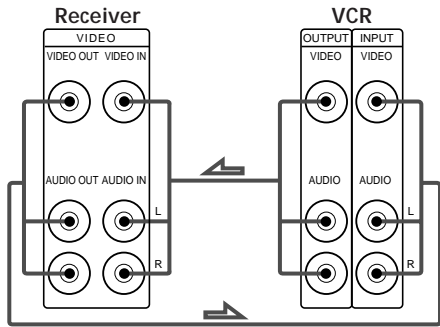

Use the function buttons (TV/LD, CD, MD/TAPE etc) to select the VIDEO AUDIO OUT signal. You can record this audio signal by connecting a recording component such as a cassette deck (to the VIDEO AUDIO OUT jack).

DVD player/AC-3 decoder

What cables will I need?

- Audio cable (not supplied) (1 for each 5.1 CH/DVD FRONT and REAR jacks)

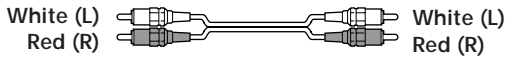

- Monaural audio cable (not supplied) (1 for each 5.1 CH/DVD CENTER and WOOFER jacks)

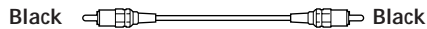

- Video cable (not supplied) (1 for the 5.1 CH/DVD VIDEO IN jack)



You can play decoded Dolby Digital AC-3 soundtracks through the speakers connected to the amplifier. If you have a Dolby Digital AC-3 decoder you can amplify a decoded Dolby Digital AC-3 soundtrack with the following connections.

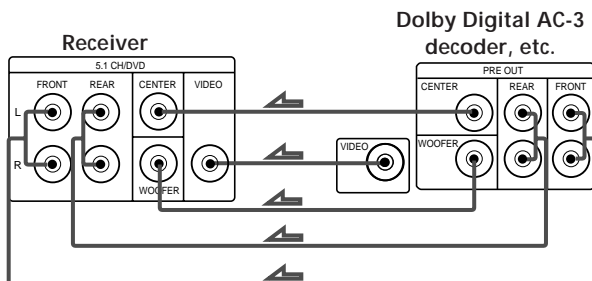

Where do I go next?

Go on to the next section to connect the speakers.

Speaker System Hookups

Overview

This section describes how to connect your speakers to the receiver. Although front (left and right) speakers are required, centre and rear speakers are optional. Adding centre and rear speakers will enhance the surround effects. Connecting an active woofer will increase bass response. For specific locations of the terminals, see the illustration below.

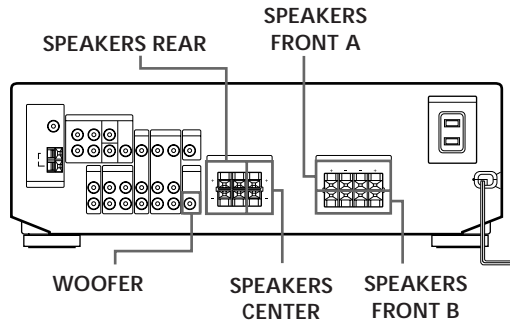

For optimum surround sound effect, place your speakers as shown below.

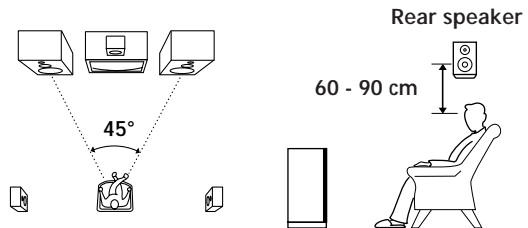

What cords will I need?

Speaker cord (not supplied) (1 for each speaker)

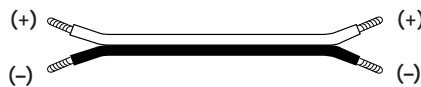

Twist the stripped ends of the cord about 15 mm (2/3 inch). Be sure to match the speaker cord to the appropriate terminal on the components: + to + and - to -. If the cords are reversed, the sound will be distorted and will lack bass.

(continued)

Hookups

Front speakers

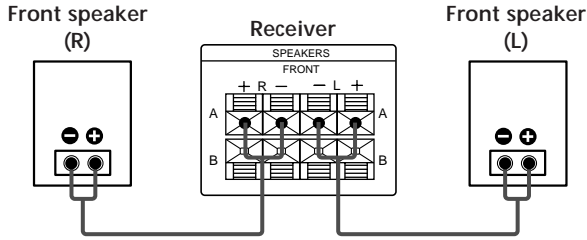

Rear and centre speakers

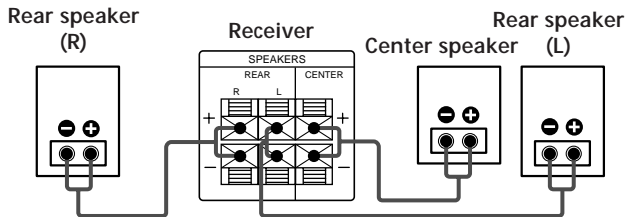

To avoid short-circuiting the speakers
Short-circuiting of the speakers may damage the receiver. To prevent this, make sure to take the following precautions when connecting the speakers. Make sure the stripped ends of each speaker cord does not touch another speaker terminal or the stripped end of another speaker cord.

Examples of poor conditions of the speaker cord:

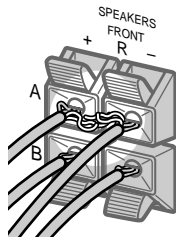

Stripped speaker cord is touching another speaker terminal.

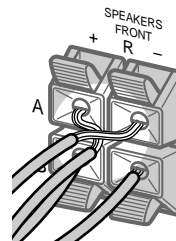

Stripped cords are touching each other due to excessive removal of insulation

After connecting all the components, speakers and AC power cord, output a test tone to check that all the speakers are connected correctly. For details on outputting a test tone, refer to "Adjusting the speaker volume", on page 17.

If you have connected rear speakers, be sure to press the 5.1 CH/DVD button and turn off sound filed on the receiver before outputting a test tone so that the tone is output individually from the left and right rear speakers.

If no sound is heard from a speaker while outputting a test tone or a test tone is output from a speaker other than the one whose name is currently displayed on the receiver, the speaker may be short-circuited. If this happens, check the speaker connection again.

Active woofer

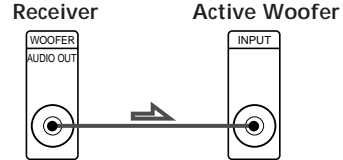

Note

Do not connect any other componet.

- 💡 If you have an additional front speaker system
Connect them to the SPEAKERS FRONT B terminals.
- 💡 If your TV monitor uses separate speakers
You can connect one of them to the SPEAKERS CENTER terminals for use with Dolby Pro Logic Surround sound (see page 16).

Selecting the speaker system

To drive the speakers, select the speaker system as follows:

To drive	Depress SPEAKERS button
Speaker system A (connected to the SPEAKERS FRONT A terminals)	A
Speaker system B (connected to the SPEAKERS FRONT B terminals)	B
Both speaker systems A and B (series connection)	A+B

Notes

- If you want to enjoy the surround sound, be sure to connect the front speakers to the SPEAKERS FRONT A terminal.
- No sound is heard when you press SPEAKERS A+B without connecting speaker system B.

Where do I go next?

To complete your system, go to "AC Hookups" on this page.

AC Hookups

Connecting the mains lead

Connect the mains lead from this receiver and from your audio/video components to a wall outlet. If you connect other audio components to the SWITCHED AC OUTLET on the receiver, the receiver can supply power to the connected components so you can turn on/off the whole system when you turn on/off the receiver.

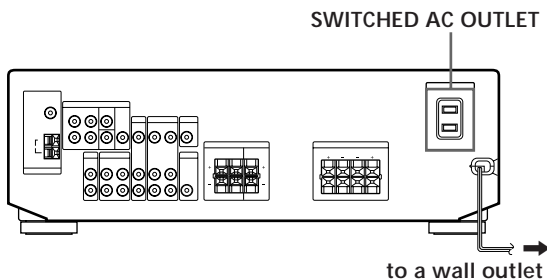
**Caution**

Make sure that the power consumption of the component connected to the receiver's AC outlet does not exceed 100 watts. Do not connect high-wattage electrical home appliances such as electric irons, fans, or TVs to this outlet.

Where do I go next?

Before you use the receiver, go to the next section to make sure that all the controls are set to the appropriate positions.

Before You Use Your Receiver

Before turning on the receiver, make sure that you have:

- Turned MASTER VOLUME to the leftmost position (0).
- Selected the appropriate speaker system. (See "Selecting the speaker system" on previous page.)
- Set BALANCE to the center position.

Before you use your receiver for the first time or when you want to clear the receiver's memory, do the procedure below:

I/⏻ (power)

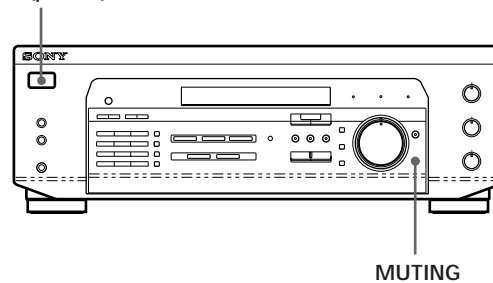

- 1 Turn off the receiver.
- 2 Press I/⏻ (power) for more than 4 seconds. "INITIAL" appears in the display and the items including the following are reset or cleared:
 - All preset stations are reset to their factory settings.
 - All sound field parameters are reset to their factory settings.
 - All index names (of preset stations and programme sources) are cleared.
 - All adjustments made with the SET UP button are reset to their factory settings.
 - The sound field memorized for each programme source and preset station is cleared.

Turn on the receiver and check the following indicator.

- Press MUTING or MUTING on the remote if the MUTING indicator turns on.

Selecting a Component

To listen to or watch a connected component, first select the function on the receiver or with the remote. Before you begin, make sure you have:

- Connected all components securely and correctly as indicated on pages 5 to 9.
- Turned MASTER VOLUME to the leftmost position (0) to avoid damaging your speakers.

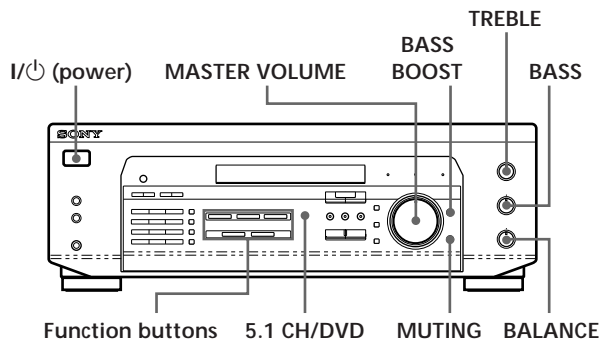

- 1 Press I/⏻ (power) to turn on the receiver.
- 2 Press a function button to select the component you want to use:

To listen to or watch	Press
Radio programmes	TUNER
Compact discs (CD)	CD
MiniDiscs (MD) or audio tapes	MD/TAPE
TV programmes or Laserdisc	TV/LD
Video tapes	VIDEO
DVD player/AC-3 decoder	5.1 CH/DVD

- 3 Turn on the component, for example, a CD player, and then start playing.
To tune in radio stations on this receiver, see "Receiving Broadcasts" on page 12.
- 4 Turn MASTER VOLUME to adjust the volume.
To adjust the volume of the TV's speakers, use the volume control on the TV.

To	Do this
Mute the sound	Press MUTE or MUTE on the remote. Press again to restore the sound.
Reinforce the bass	Press BASS BOOST or BASS BOOST on the remote to turn on the BASS BOOST indicator.
Adjust the balance	Turn the BALANCE control left or right.
Adjust the tone quality	Adjust the BASS and TREBLE controls.

When you listen with headphones
Connect the headphones to the PHONES jack and set the SPEAKERS buttons to OFF.

Watching/listening to video programmes

When you watch/listen to TV or video programmes, we recommend you play audio portion through the receiver instead of your TV's speaker. This lets you take advantage of the receiver's surround sound effects, like Dolby Pro Logic Surround and lets you use the receiver's remote to control the audio.

Turn off the speakers on your TV before you start so you can enjoy the surround sound from your receiver.

To watch/listen to TV programmes, turn on the TV, TV tuner and the receiver and press TV/LD on the receiver.

To watch videos, do the following:

- 1 Press VIDEO to select the VCR.
- 2 Turn on the TV and set the TV's video input to match your video component.
- 3 Turn on the VCR, and start playback.

Using the remote

The remote lets you operate the receiver and the Sony components that are connected to it.

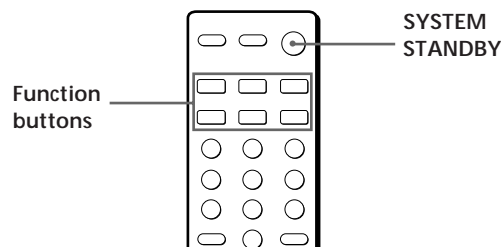

- 1** Press one of the Function buttons to select the component you want to use.
The Function buttons on the remote are factory-set as follows:

To listen to or watch	Press
Radio programmes	TUNER
Compact discs (CD)	CD
MiniDiscs (MD) or audio tapes	MD/TAPE (INITIAL-MD MODE)
TV programmes	TV
VHS Video tapes (VTR-3 mode)	VIDEO
DVD Player/AC-3 decoder	5.1 CH

If you want to change the factory setting of a button, see the next section.

The receiver and the selected component turn on.

If the component does not turn on

Press the power switch on the component.

- 2** Start playing.
Refer to "Remote Button Descriptions" on page 24 for details.

To turn off the components

Press SYSTEM STANDBY. You can turn off the video and audio components connected to the SWITCHED AC OUTLET at the same time.

Note

Press SYSTEM STANDBY together with the TUNER button to set SYSTEM STANDBY switch to turn only the receiver on or off. Press SYSTEM STANDBY together with the 5.1 CH button to return the SYSTEM STANDBY switch to normal operation.

Changing the factory setting of a function button

If the factory settings of the FUNCTION buttons don't match your system components, you can change them. For example, if you have two CD players and you don't have a tape deck or an MD recorder, you can assign the MD/TAPE button to your second CD player.

Note that the settings of the TUNER button cannot be changed.

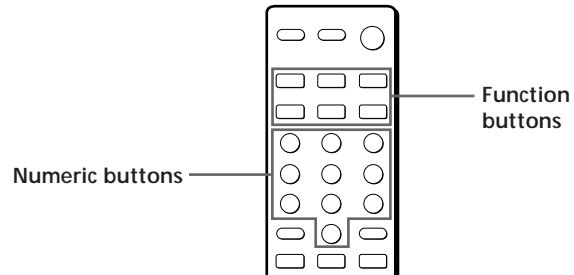

- 1 Hold down the Function button whose function you want to change (MD/TAPE, for example).
- 2 Press the corresponding numeric button of the component you want to assign to the Function button (1 - CD player, for example).

The numeric buttons are assigned to select the functions as follows:

Numeric button	Operates
1	CD player
2	DAT deck
3	MD deck
4	Tape deck A
5	Tape deck B
6	LD player
7	VCR (remote control mode VTR 1*)
8	VCR (remote control mode VTR 2*)
9	VCR (remote control mode VTR 3*)
0	TV
Enter	DVD

* Sony VCRs are operated with a VTR 1, 2 or 3 setting. These correspond to Beta, 8mm and VHS respectively.

Now you can use the MD/TAPE button to control a second CD player.

To reset the setting to the factory setting
Repeat the above procedure.

Receiving Broadcasts

This receiver lets you enter a station's frequency directly by using the numeric buttons (direct tuning). If you don't know the frequency of the station you want, see "Receiving broadcasts by scanning stations (automatic tuning)" on this page.

Before you begin, make sure you have:

- Connected an FM or AM aerial to the receiver as indicated on page 5.
- Selected the appropriate speaker system. (See "Selecting the speaker system" on page 8.)

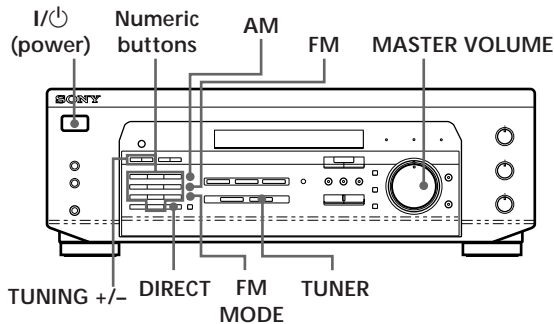

- 1 Press I/⏻ (power) to turn on the receiver.
- 2 Press TUNER.
The last received station is tuned in.
- 3 Press FM or AM to select FM or AM stations.
- 4 Press DIRECT.
- 5 Press the numeric buttons to enter the frequency.

Example 1: FM 102.50 MHz Example 2: AM 1350 kHz

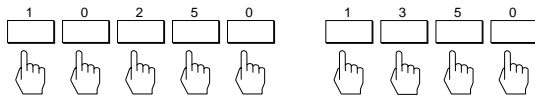

- 6 When you tune in AM stations, adjust the direction of the AM loop aerial for optimum reception.

To receive other stations
Repeat Steps 3 to 5.

If the STEREO indicator remains off
Press FM MODE when an FM stereo broadcast is received.

If an FM stereo programme is distorted
The STEREO indicator flashes. Press FM MODE to change to monaural (MONO). You will not have the stereo effect but the distortion will be reduced. To return to stereo mode, press this button again.

If you cannot tune in a station and the entered numbers are flashing
Make sure you've entered the right frequency. If not, press DIRECT and re-enter the frequency you want. If the entered numbers still flash, the frequency is not used in your area.

To watch FM simulcast TV programmes
Make sure that you tune in the simulcast programme both on the TV (or the VCR) and on the receiver.

If you enter a frequency not covered by the tuning interval
The entered value is automatically rounded up or down to the closest covered value.

Tuning intervals for direct tuning are:
FM: 50 kHz intervals
AM: 9 kHz intervals

Receiving broadcasts by scanning stations (automatic tuning)

If you don't know the frequency of the radio station you want, you can have the receiver scan all the receivable stations to locate the one you want.

- 1 Press TUNER.
The last received station is tuned in.
- 2 Press FM or AM to select FM or AM.
- 3 Press TUNING + or -.
Press the + button for a higher frequency; press the - button for a lower one. When you tune past either end of the band, the receiver automatically jumps to the opposite end. Every time a station is received, the receiver stops scanning. To continue scanning, press the button again.

Presetting Radio Stations

You'll most likely want to preset the receiver with the radio stations you listen to often so that you don't have to tune in the station every time. The receiver can store a total of 30 FM or AM stations. You can store the stations on preset numbers combining 3 characters (A, B, C) and numbers (0 - 9). For example, you can store a station as preset number A1, B6 or C9, etc.

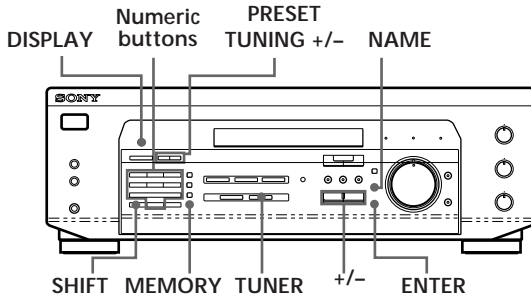

- 1 Press TUNER.
The last received station is tuned in.
- 2 Tune in the station you want.
If you are not familiar with how to tune in a station, see "Receiving Broadcasts" on the previous page.
- 3 Press MEMORY.
"MEMORY" appears for a few seconds.
Do steps 4 and 5 before "MEMORY" goes out.
- 4 Press SHIFT to select a character (A, B or C).
Each time you press SHIFT, the letter "A," "B" or "C" appears in the display.
If "MEMORY" disappears, start again from step 3.
- 5 While MEMORY is displayed, press the number you want to use (0 to 9).
- 6 Repeat Steps 2 to 5 to preset other stations.

To change a preset station

Preset a new station on the number you want to change.

Note

If the mains lead is disconnected for about one week, the preset stations will be cleared from the receiver's memory, and you will have to preset the stations again.

Tuning preset stations (preset tuning)

You can tune directly to a preset station by entering its preset number. If you don't know which stations are preset on which numbers, you can tune by scanning the preset stations.

- 1 Press TUNER.
The last received station is tuned in.
- 2 Press SHIFT to select a character (A, B or C), then press the number.
For example, select A and then press 7 to tune in the station preset as A7.



You can tune by scanning the preset stations

First press TUNER and then press PRESET TUNING + or - to select the station you want. Each time you press the buttons, the preset numbers change as follows:

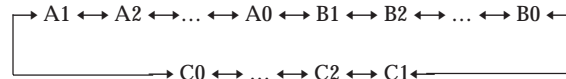

Naming preset stations

You can store names, up to 8 characters long, for your preset stations. Once you name a preset station, the name appears in the display instead of the frequency when you tune to that preset.

The characters you can use include letters, numbers and symbols.

- 1 Tune to the preset station you want to name.
- 2 Press NAME.
The cursor blinks in the display.
- 3 Use + or - to select the character you desire.
- 4 Press NAME to move the cursor into position for the next character.
- 5 Repeat steps 3 and 4 to enter up to 8 characters.
- 6 Press ENTER to store the names.

If you make a mistake

Press NAME repeatedly so that the character you want to change blinks in the display, then use + or - to select the desired character.

To display index names

Press DISPLAY repeatedly to display index names and program source (or frequency if you select TUNER).

Notes

- You can also enter a name of up to 8 characters for programme sources. Select the programme sources you want and repeat steps 2 to 6.
- To clear programme source name, press NAME and then press the same programme source button. Press ENTER to delete the name (except TUNER).

Recording

This receiver makes it easy to record to and from the components connected to the receiver. You don't have to connect playback and recording components directly: once you select a programme source on the receiver, you can record and edit as you normally would using the controls on each component. Before you begin, make sure you've connected all components properly.

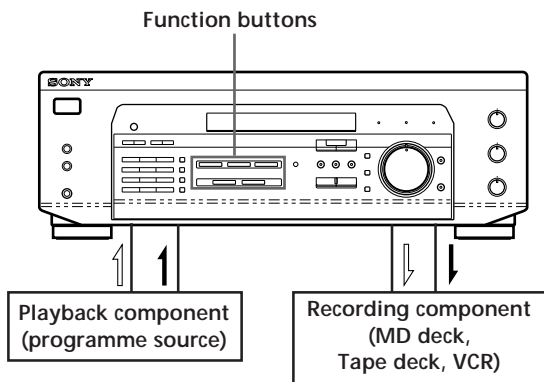

↔: Audio signal flow
 →: Video signal flow

Recording on a MiniDisc or audio tape

You can record on a MiniDisc or cassette tape using the receiver. See the instruction manual of your MD recorder or tape deck if you need help.

- 1 Press one of the function buttons to select the programme source.
- 2 Set the component to be ready for playing. For example, insert a CD into the CD player.
- 3 Insert a blank disc or tape into the recording deck and adjust the recording level, if necessary.
- 4 Start recording on the recording deck and then start playing the component.

Recording on a video tape

You can record from a TV or a LD player using the receiver. You can also add audio from a variety of audio sources when editing a video tape. See your VCR's instruction manual if you need help.

- 1 Press TV/LD to select the programme source.
- 2 Set the component to be ready for playing. For example, turn on the TV and TV tuner.
- 3 Insert a blank video tape into the VCR for recording.
- 4 Start recording on the VCR.

💡 You can replace audio while editing a video tape
 At the point you want to start adding different sound, press another function button (for example, CD) and start playback. The sound from the selected component will be recorded over the original audio.

To resume recording the original sound, press the TV/LD function button.

Note

You cannot record the audio and video signal during 5.1 CH/DVD mode.

Using the Sleep Timer

You can set the amplifier to turn off automatically at a time you specify.

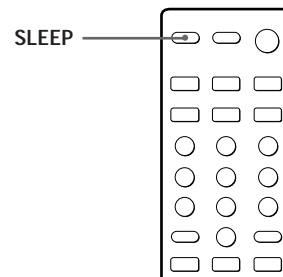

Press SLEEP on the remote while the power is on. Each time you press SLEEP, the time changes as shown below.

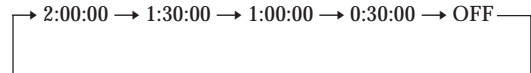

The display dims after you specify the time.

💡 You can check the time remaining before the amplifier turns off
 Press SLEEP on the remote. The remaining time appears in the display.

Choosing a Sound Field

You can take advantage of surround sound simply by selecting one of the pre-programmed sound field according to the type of music you wish to play.

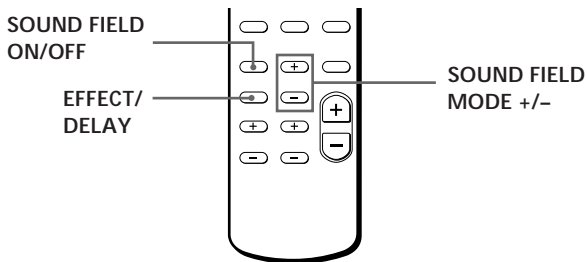
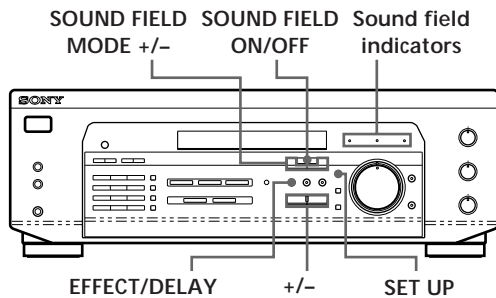

- 1 Press SOUND FIELD ON/OFF to turn on the sound field. One of the sound field indicators lights up.
- 2 Press SOUND FIELD MODE +/- repeatedly until the sound field you want appears in the display. Select the appropriate sound field as follows:

Type	MODE (Sound field)	Effects
CINEMA	PRO LOGIC*	Decodes programmes processed with Dolby Pro Logic Surround.
	C(inema) STUDIO	Reproduces the sound characteristics of a movie theatre. Good for watching standard movies.
VIRTUAL	V DOLBY	Uses front speakers to create surround sound effects.
	V SURR**	Uses front speakers and centre speaker to create surround sound effects.
MUSIC	HALL	Reproduces the acoustics of a rectangular concert hall. Great for soft acoustic sounds.

* "DOLBY" appears in the display.

** When using 5.1 CH/DVD only.

When you use the remote
Each time you press SOUND FIELD MODE +/-, sound field changes as follows:

When selecting programme source

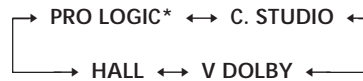

When using 5.1 CH/DVD

C. STUDIO ↔ V SURR

* "DOLBY" appears in the display.

To turn off sound field
Press SOUND FIELD ON/OFF.

The receiver memorizes the last sound field selected for each programme source (Sound Field Link)
Whenever you select a programme source, the sound field that was last applied is automatically applied again. For example, if you listen to CD with HALL as the sound field, change to different programme source, then return to CD, HALL will be applied again. In the case of the tuner, the sound fields for AM or FM band and for all the preset stations are memorized separately.

You can find Dolby Surround-encoded software by looking at the packaging
However, some videos and laser discs may use Dolby Surround sound even if it's not indicated on the package.

Note

Make sure to select speaker A with the SPEAKERS A button, otherwise, you can't obtain the surround effect.

Adjusting the Effect Level (except PRO LOGIC)

You can make the surround sound more prominent by increasing the EFFECT level. This control lets you adjust the "presence" of the surround effect in six steps (1-6).

- 1 Start playing a programme source.
- 2 Press EFFECT/DELAY. The effect level ("EFFECT 1" ... "EFFECT 6") appears on the display.
- 3 Press +/- to select the level you prefer.

When you use the remote
Each time you press EFFECT/DELAY, the effect level changes as follows:



Note

Changing the effect level may not produce major variations in the surround effect when used with certain playback sources.

Getting the Most Out of Dolby Pro Logic Surround Sound

To obtain the best possible Dolby Pro Logic Surround sound, first select the centre mode according to the speaker system you have. Then, adjust each speaker volume and delay time.

Note that you must have at least one additional pair of speakers and/or one centre speaker to do the following adjustments.

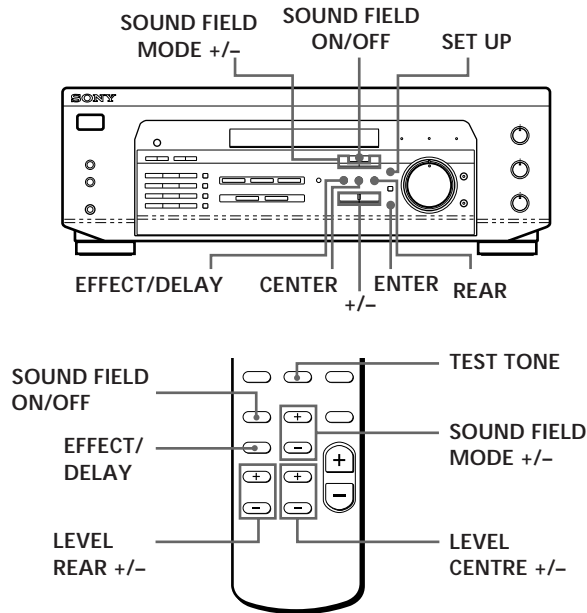

Selecting the centre mode

The receiver offers you four centre modes: Phantom, Normal, Wide and 3 Stereo. Each mode is designed for a different speaker configuration. Select the mode that best suits your speaker's system configuration:

- 1 Press SOUND FIELD ON/OFF to turn on sound field.
- 2 Press SOUND FIELD MODE +/- repeatedly to select the Dolby surround sound field (PRO LOGIC or C.STUDIO mode).
- 3 Press SET UP repeatedly until "CTR MODE" appears on the display.
- 4 Press +/- repeatedly until the centre mode you want appears on the display. Select the centre mode as follows:

If you have	Select	So that
Front and rear speakers, no centre speaker	PHANTOM	The sound of the centre channel is output from the front speakers.
Front and rear speakers, and a small centre speaker	NORMAL	The bass sound of the centre channel is output from the front speakers (because a small speaker cannot produce enough bass).
Front and rear speakers, and a large centre speaker	WIDE	For "complete" Dolby Pro Logic Surround sound.
Front and centre speakers, no rear speaker	3 STEREO (3 Channel Logic)	The sound of the rear channel is output from the front speakers.

Adjusting the speaker volume

The test tone feature lets you set the volume of your speakers to the same level. (If all of your speakers have equal performance, you don't have to adjust the speaker volume.)

Using the controls on the remote lets you test the speaker connection and adjust the volume level from your listening position.

- 1** Press SOUND FIELD ON/OFF to turn on the sound field.
Press SOUND FIELD MODE +/- repeatedly to select "PRO LOGIC".
- 2** Press TEST TONE on the remote.
You will hear the test tone from each speaker sequentially.
- 3** Adjust the volume level so that the test tone from each speaker is at the same level from your listening position.
 - To adjust the level of centre speaker, press LEVEL CENTER + or - on the remote.
 - To adjust the level of rear speakers, press LEVEL REAR + or - on the remote.
- 4** Press TEST TONE on the remote to turn off the test tone.



You can adjust all speakers at one time
Adjust MASTER VOL on the remote or MASTER VOLUME on the receiver.



You can also adjust the volume level with the controls on the receiver
After pressing TEST TONE on the remote:

- Press CENTER to select the centre speaker.
Press +/- to adjust the level.
- Press REAR to select the rear speaker.
Press +/- to adjust the level.



You can increase the output level of the rear speakers
The adjustment range of the rear speakers is preset from -15 to +10, but you can shift the range up 5 levels (-10 to +15).

- Press SET UP repeatedly until "REAR SET UP" appears on the display.
- Press +/- repeatedly until "GAIN UP" appears on the display.

The values for the rear level remain fixed at -15 to +10 in the display, but you will be able to hear the difference in the actual output level.

To reset the rear level adjustment range, repeat this procedure to display "NORMAL".

Adjusting the delay time

You can make the surround sound more effective by delaying the output from the rear speakers (delay time). You can select from three delay times, S (15 mS), M (20 mS), and L (30 mS). For example, if you've placed the rear speakers in a large room or apart from your listening position, set the delay time shorter.

- 1** Start playing a programme source encoded with Dolby Surround sound.
- 2** Press EFFECT/DELAY or EFFECT/DELAY on the remote repeatedly to choose the delay time parameter. The current delay time appears in the display, such as "DELAY S," "DELAY M" or "DELAY L."

Note

Select the PRO LOGIC mode when you adjust the delay time using EFFECT/DELAY on the receiver.

(continued)

Adjustable parameters for each sound field when selecting programme source

Sound field mode	Type	MODE	Parameters				Test tone output
			DELAY	EFFECT	REAR	CENTER	
Off	--	--					No sound
On	CINEMA	PRO LOGIC	●		● ^{a)}	● ^{b)}	Depends on centre mode (see page 16)
		C STUDIO		●	● ^{a)}	● ^{b)}	
	VIRTUAL	V DOLBY		●			No sound
	MUSIC	HALL		●	●	▶	From the front and the rear speakers alternately

Adjustable parameters for each sound field when using 5.1 CH/DVD

Sound field mode	Type	MODE	Parameters				Test tone output
			DELAY	EFFECT	REAR	CENTER	
Off	--	--			●	●	In the following order: front (L), centre, front (R), rear (R) and rear (L)
On	CINEMA	C STUDIO		●	●	●	
	VIRTUAL	V SURR		●		●	From the front and the centre speakers alternately

a) Adjustable only when the centre mode is set to PHANTOM, NORMAL or WIDE (see page 16).

b) Adjustable only when the centre mode is set to 3 STEREO, NORMAL or WIDE (see page 16).

Note

To adjust the speaker volume using a test tone as described on page 17, select the PRO LOGIC sound field. The test tone output in all other sound fields is used for verifying whether there is output from speakers or not.

Troubleshooting

If you experience any of the following difficulties while using the receiver, use this troubleshooting guide to help you remedy the problem. Should any problem persist, consult your nearest Sony dealer.

There's no sound or only a very low-level sound is heard.

- ➔ Check that the speakers and components are connected securely.
- ➔ Make sure you select the correct component on the receiver.
- ➔ Make sure you set the SPEAKERS selector correctly (see page 8).
- ➔ Press MUTING or MUTING on the remote if the MUTING indicator turns on.
- ➔ The protective device on the receiver has been activated because of a short circuit ("PROTECT" flashes). Turn off the receiver, eliminate the short-circuit problem and turn on the power again.

The left and right sounds are unbalanced or reversed.

- ➔ Check that the speakers and components are connected correctly and securely.
- ➔ Adjust the BALANCE control.

Severe hum or noise is heard.

- ➔ Check that the speakers and components are connected securely.
- ➔ Check that the connecting cords are away from a transformer or motor, and at least 3 meters away from a TV set or fluorescent light.
- ➔ Place your TV away from the audio components.
- ➔ Make sure you connect a ground wire to the antenna ground terminal.
- ➔ The plugs and jacks are dirty. Wipe them with a cloth slightly moistened with alcohol.

No sound is heard from the centre speaker.

- ➔ Select the appropriate centre mode (see page 16).
- ➔ Adjust the speaker volume appropriately (see page 17).

No sound or only a very low-level sound is heard from the rear speakers.

- ➔ Select the appropriate centre mode (see page 16).
- ➔ Adjust the speaker volume appropriately (see page 17).
- ➔ Make sure you turn on the sound field surround mode function.

Radio stations cannot be tuned in.

- ➔ Check that the antennas are connected securely. Adjust the antennas and connect an outdoor antenna if necessary.
- ➔ The signal strength of the stations is too weak (when you tune in with automatic tuning). Use direct tuning.
- ➔ No stations have been preset or the preset stations have been cleared (when you tune in with scanning preset stations). Preset the stations (see page 13).

Surround effect cannot be obtained.

- ➔ Make sure you turn on the sound field function.
- ➔ Make sure that the front speakers are connected to the SPEAKERS A terminal.
- ➔ Make sure that SPEAKERS A and B buttons are depressed when two sets of front speakers are used.

No picture or an unclear picture is seen on the TV screen.

- ➔ Select the appropriate function on the receiver.
- ➔ Place your TV away from the audio components.

Recording cannot be made.

- ➔ Check that the components are connected correctly.
- ➔ You cannot record audio from a programme source connected to the 5.1 CH/DVD jacks.

The remote does not function.

- ➔ Point the remote at the remote sensor  on the receiver.
- ➔ Remove the obstacles in the path of the remote and the receiver.
- ➔ Replace both batteries in the remote with new ones if they are weak.
- ➔ Make sure you select the correct function on the remote.

Specifications

Amplifier section

Power output

Stereo mode Rated power:
(8 ohms at 1 kHz, THD 0.7%)
80 W + 80 W

Reference power:
(8 ohms 20 Hz - 20 kHz,
less than 0.09% total
harmonic distortion)
70 W + 70 W

Surround mode Rated power:
and 5.1 CH/DVD (8 ohms at 1 kHz,
(Reference) THD 0.7%)

Front: 80 W/ch
Center: (Pro Logic mode)
80 W
Rear: 80 W/ch

Reference power:
(8 ohms 20 Hz - 20 kHz,
less than 0.09% total
harmonic distortion)
Front: 70 W/ch
Center: (Pro Logic mode)
70 W
Rear: 70 W/ch

RMS power:
(8 ohms at 1 kHz, THD 10%)
Front: 100 W/ch
Center: (Pro Logic mode)
100 W
Rear: 100 W/ch

Frequency response TV/LD, CD, MD/TAPE,
VIDEO, 5.1 CH/DVD:
10 Hz - 50 kHz ± 1 dB

Inputs

	Sensitivity	Impedance	S/N
CD, 5.1 CH/ DVD, MD/TAPE, TV/LD, VIDEO	250 mV	50 kilohms	80 dB

Outputs

MD/TAPE REC OUT:
Voltage: 250 mV,
Impedance: 10 kilohms
VIDEO AUDIO OUT:
Voltage: 250 mV,
Impedance: 10 kilohms
WOOFER:
Voltage: 2 V
Impedance: 1 kilohms
PHONES: Accepts low
and high impedance
headphones

Muting

Full mute

BASS BOOST

+10 dB at 70 Hz

TONE

± 8 dB at 100 Hz and 10
kHz

Tuner section

FM stereo, FM/AM superheterodyne tuner

FM tuner section

Tuning range 87.5 - 108.0 MHz

Antenna terminals 75 ohms, unbalanced

Intermediate frequency 10.7 MHz

Sensitivity Mono: 18.3 dBf, 4.5 μ V
Stereo: 38.3 dBf, 45 μ V

Usable sensitivity 11.2 dBf, 1 μ V (IHF)

S/N Mono: 76 dB
Stereo: 70 dB

Harmonic distortion at 1 kHz Mono: 0.3 %
Stereo: 0.5 %

Separation 45 dB at 1 kHz

Frequency response 30 Hz - 15 kHz $^{+0.5}_{-2}$ dB

Selectivity 60 dB at 400 kHz

AM tuner section

Tuning range 531 - 1602 kHz (9 kHz
step)

Antenna Loop aerial

Intermediate frequency 450 kHz

Usable sensitivity 50 dB/m (at 999 kHz)

S/N 54 dB (at 50 mV/m)

Harmonic distortion 0.5 % (50 mV/m, 400 Hz)

Selectivity At 9 kHz: 35 dB

Video section

Inputs VIDEO, TV/LD,
5.1 CH/DVD:
1 Vp-p 75 ohms

Outputs VIDEO, MONITOR :
1 Vp-p 75 ohms

General

System Tuner section: PLL
quartz-locked digital
synthesizer system
Preamplifier section:
Low-noise NF type
equalizer
Power amplifier section:
Pure-complementary
SEPP

Power requirements 220 - 230 V AC, 50/60 Hz

Power consumption 235 W

AC outlets 1 switched 100 W max

Dimensions 430 x 144 x 306 mm

Mass (Approx.) 8.1 kg (17 lb 13 oz)

Supplied accessories FM wire antenna (1)
AM loop antenna (1)
Remote commander
(remote) (1)
Size AA (R6) batteries
(2)

The specification measured is under 230 V
AC, 50 Hz condition.

Design and specifications are subject to
change without notice.

Glossary

Centre mode

Setting of speakers to enhance Dolby Pro Logic Surround mode. To obtain the best possible surround sound, select one of the following four centre modes according to your speaker system.

- **NORMAL mode**
Select NORMAL mode if you have front and rear speakers and a small centre speaker. Since a small speaker cannot produce enough bass, the bass sound of the centre channel is output from the front speakers.

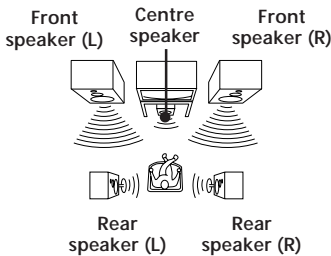

- **WIDE mode**
Select WIDE mode if you have front and rear speakers and a large centre speaker. With the WIDE mode, you can take full advantage of Dolby Surround sound.

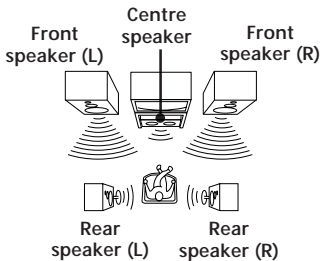

- **PHANTOM mode**
Select PHANTOM mode if you have front and rear speakers but no centre speaker. The sound of the centre channel is output from the front speakers.

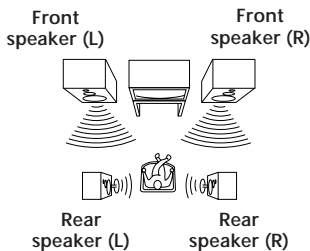

- **3 STEREO mode**
Select 3 STEREO mode if you have front and centre speakers but no rear speaker. The sound of the rear channel is output from the front speakers to let you experience some of the surround sound without using rear speakers.

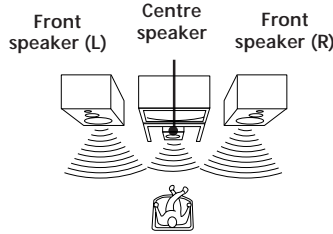

- **Delay time**
Time lag between the surround sound output from front speakers and rear speakers. By adjusting the delay time of the rear speakers, you can obtain the feeling of presence. Make the delay time longer when you have placed the rear speakers in a small room or close to your listening position, and make it shorter when you have placed them in a large room or apart from your listening position.

- **Direct tuning**
Tuning method to let you directly enter a station's frequency using the numeric buttons. Use this method if you know the frequency of the station you want.

- **Dolby Pro Logic Surround**
As one method of decoding Dolby Surround, Dolby Pro Logic Surround produces four channels from two channel sound. Compared with the former Dolby Surround system, Dolby Pro Logic Surround reproduces left-to-right panning more naturally and localizes sounds more precisely. To take full advantage of Dolby Pro Logic Surround, you should have one pair of rear speakers and a centre speaker. The rear speakers output monaural sound.

- **5.1 CH/DVD**
These jacks are used to input decoded Dolby Digital (AC-3) audio signals, allowing you to enjoy 5.1 channel surround sound. Use these jacks to connect a Dolby Digital (AC-3) decoder or a DVD player with a built-in AC-3 decoder.

- **Preset station**
A radio broadcasting station that is stored in memory of the receiver. Once you "preset" stations, you no longer have to tune in the stations. Each preset station is assigned its own preset number, which lets you tune them in quickly.

Surround sound
Sound that consists of three elements: direct sound, early reflected sound (early reflections) and reverberative sound (reverberation). The acoustics where you hear the sound affect the way these three sound elements are heard. These sound elements are combined in such a way that you can actually feel the size and the type of a concert hall.

- **Types of sound**
Early reflections Reverberation

- **Transition of sound from rear speakers**

- **Test tone**
Signal given out by the receiver for adjusting the speaker volume. The test tone will come out as follows:

- **In a system with a centre speaker (NORMAL/WIDE/3 STEREO modes)**
The test tone is output from the front L (left), centre, front R (right), and rear speakers in succession.

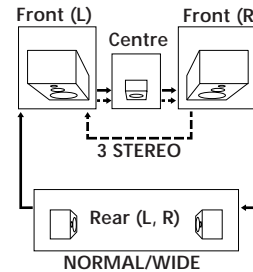

- **In a system without a centre speaker (PHANTOM mode)**
The test tone is output from the front and the rear speakers alternately.

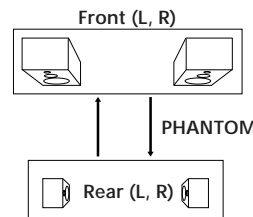

A, B

- Adjusting
 - delay time 17
 - effect level 15
 - speaker volume 17
 - tone 10
 - volume 10
- Aerial hookups 5
- Audio component hookups 6
- Automatic tuning 12

C

- Center mode 16, 21
 - NORMAL mode 16, 21
 - PHANTOM mode 16, 21
 - 3 STEREO mode 16, 21
 - WIDE mode 16, 21
- Connecting. *See* Hookups

D

- Delay time 16, 21
- Direct tuning 12, 21
- Dolby Pro Logic
 - Surround 16, 21
 - center mode 16, 21
- Dubbing. *See* Recording

E, F, G

- Editing. *See* Recording
- Effect level 15

H, I, J, K, L, M

- Hookups
 - aerials 5
 - audio components 6
 - mains lead 9
 - overview 4
 - speakers 7
 - video component 6

N, O

- Naming preset stations 13
- NORMAL mode 16, 21

P

- PHANTOM mode 16, 21
- Preset station 13
- Presetting
 - radio stations 13
- Preset tuning 13
- Programme source
 - selecting 10

Q

- Quick reference guide 25

R

- Rear panel 5, 6, 7, 9, 23
- Receiving broadcasts
 - directly 12
 - using preset stations 13
- Recording
 - on a tape 14
 - on a video tape 14
- Remote buttons 10, 14, 24

S

- Scanning
 - preset stations 13
 - radio stations 12
- Selecting a programme source 10
 - using the remote 10
- Speakers
 - connection 7
 - placement 7
 - selecting speaker system 8
- Storing radio stations. *See* Presetting
- Surround sound 16, 21

T

- Test tone 17, 21
- 3 STEREO mode 16, 21
- Troubleshooting 19
- Tuning. *See* Receiving broadcasts

U

- Unpacking 4

V

- Video component hookups 6

W, X, Y, Z

- Watching/listening to video programmes 10
- WIDE mode 16, 21

Rear Panel Descriptions

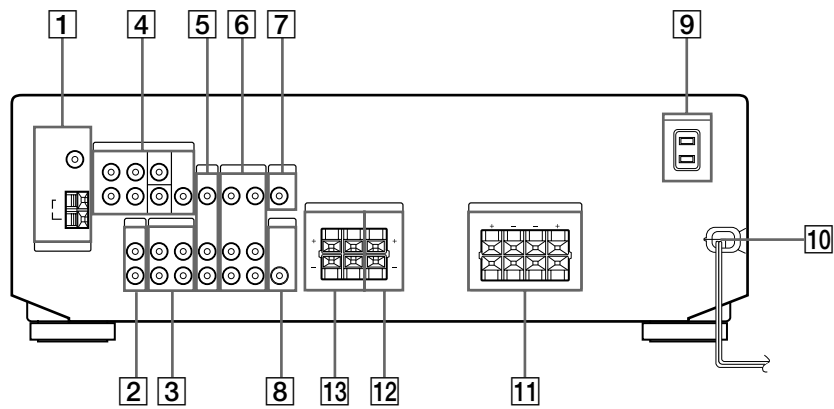

1 ANTENNA (AM or FM)

2 CD

3 MD/TAPE

4 5.1 CH/DVD

5 TV/LD

6 VIDEO

7 MONITOR

8 WOOFER

9 SWITCHED AC OUTLET

10 Mains lead

11 SPEAKERS FRONT (A/B)

12 SPEAKERS CENTER

13 SPEAKERS REAR

Remote Button Descriptions

For buttons not described on previous pages and buttons with names different from the buttons on the main unit.

Remote Button	Operates	Function
0-9	Receiver	Selects preset numbers.
	CD player/MD recorder/DVD player	Selects track numbers. 0 selects track 10.
	TV/VCR/LD	Selects channel numbers.
>10	CD player/Tape deck/MD recorder	Selects track numbers over 10.
CH/PRESET +/-	Receiver	Scans and selects preset stations.
	TV/VCR/LD	Selects preset channels.
D. SKIP	CD player	Skips discs (CD player with multi-disc changer only).
DISC	CD player	Select discs (Mega storage CD player only).
◀◀/▶▶	CD player/DVD player	Searches tracks (forward or backward).
	Tape deck/MD recorder/VCR	Fastforwards or rewinds.
◀◀/▶▶	CD player/MD recorder	Skips tracks.
⏸	CD player/Tape deck/MD recorder/VCR/DVD player	Pauses play or record. (Also starts recording with components in record standby.)
▶	CD player/Tape deck/MD recorder/VCR/DVD player	Starts play.
■	CD player/Tape deck/MD recorder/VCR/DVD player	Stops play.
◀	Tape deck	Starts play on the reverse side.
●	Tape deck	Sets tape decks to the record standby mode.
● + ▶	Tape deck/MD recorder/VCR	Starts recording when pressed with ▶ (or ◀ on tape deck).

Remote Button	Operates	Function
ENTER	TV/VCR/LD	Changes channels when used with 0-9.
TV/VIDEO	TV/VCR	Selects input signal: TV input or video input.
AV I/⏻ (power)	TV/VCR/LD Player/DVD player	Turns on or off the power.
-/- -	TV	Selects the channel entry mode, either one or two digit (in Europe only).
POSITION	TV	Changes the position of the small picture.*
SWAP	TV	Swaps the small and the large picture.*
P IN P	TV	Activates the picture-in-picture function.*
MASTER VOL +/-	TV	Normally, adjusts the master volume of the receiver.
MUTING	TV	Normally, mutes the sound from the receiver.
ANT TV/VTR	VCR	Selects output signal from the aerial terminal: TV signal or VCR programme.

* Only for Sony TVs with the picture-in-picture function

Note

Some Sony equipment cannot be controlled by this remote as shown in the table above.

Receiving Broadcasts (direct tuning)

Example: Receiving FM
102.50 MHz

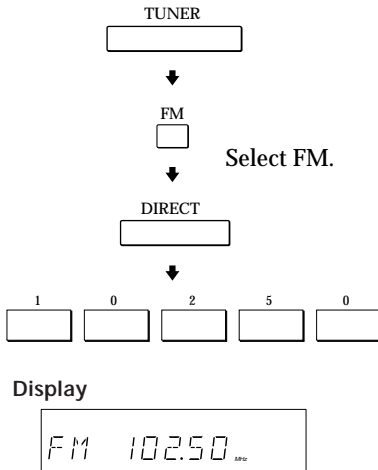

Presetting Radio Stations

Example: Presetting a
station as A7

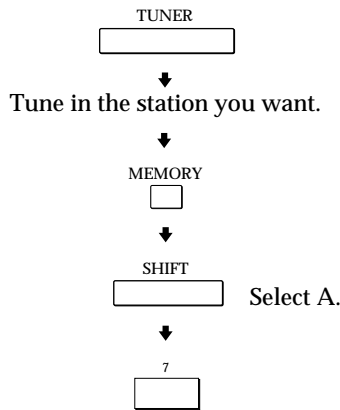

Selecting a Component

Example 1: Playing a CD

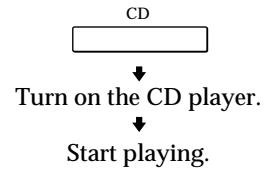

Example 2: Watching a video
tape



Scanning Radio Stations (automatic tuning)

Example: Scanning FM
stations

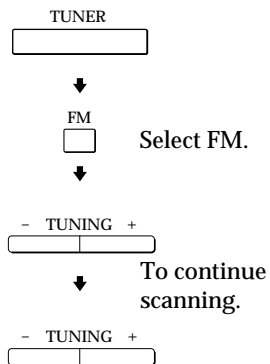

Receiving Preset Stations

Example: Receiving the
station number A7

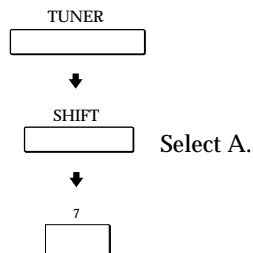

Scanning Preset Stations

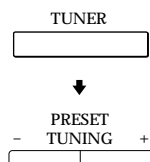

Using Pre- programmmed Sound Fields

Example: Watching the
video tape of a
Dolby Surround-
encoded movie

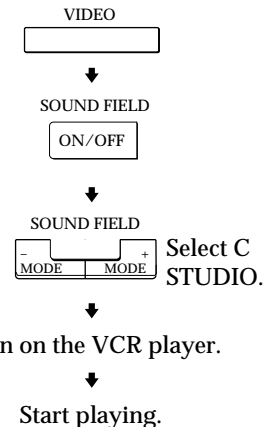

Free Manuals Download Website

<http://myh66.com>

<http://usermanuals.us>

<http://www.somanuals.com>

<http://www.4manuals.cc>

<http://www.manual-lib.com>

<http://www.404manual.com>

<http://www.luxmanual.com>

<http://aubethermostatmanual.com>

Golf course search by state

<http://golfingnear.com>

Email search by domain

<http://emailbydomain.com>

Auto manuals search

<http://auto.somanuals.com>

TV manuals search

<http://tv.somanuals.com>