

# ***Multi Channel AV Receiver***

---

## Operating Instructions

### Owner's Record

The model and serial numbers are located on the rear of the unit. Record the serial number in the space provided below. Refer to them whenever you call upon your Sony dealer regarding this product.

Model No. \_\_\_\_\_ Serial No. \_\_\_\_\_

## ***STR-DG710***

## WARNING

### To reduce the risk of fire or electric shock, do not expose this apparatus to rain or moisture.

To prevent fire, do not cover the ventilation of the apparatus with newspapers, table-cloths, curtains, etc. And don't place lighted candles on the apparatus.

To prevent fire or shock hazard, do not place objects filled with liquids, such as vases, on the apparatus.

Do not install the appliance in a confined space, such as a bookcase or built-in cabinet.

Install this system so that the power cord can be unplugged from the wall socket immediately in the event of trouble.



Don't throw away batteries with general house waste; dispose of them correctly as chemical waste.

## For customers in the United States

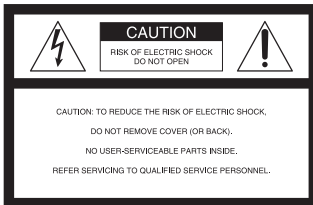

This symbol is intended to alert the user to the presence of uninsulated "dangerous voltage" within the product's enclosure that may be of sufficient magnitude to constitute a risk of electric shock to persons.



This symbol is intended to alert the user to the presence of important operating and maintenance (servicing) instructions in the literature accompanying the appliance.

## WARNING

This equipment has been tested and found to comply with the limits for a Class B digital device, pursuant to Part 15 of the FCC Rules. These limits are designed to provide reasonable protection against harmful interference in a residential installation. This equipment generates, uses, and can radiate radio frequency energy and, if not installed and used in accordance with the instructions, may cause harmful interference to radio communications. However, there is no guarantee that interference will not occur in a particular installation. If this equipment does cause harmful interference to radio or television reception, which can be determined by turning the equipment off and on, the user is encouraged to try to correct the interference by one or more of the following measures:

- Reorient or relocate the receiving antenna.
- Increase the separation between the equipment and receiver.
- Connect the equipment into an outlet on a circuit different from that to which the receiver is connected.
- Consult the dealer or an experienced radio/TV technician for help.

## CAUTION

You are cautioned that any changes or modification not expressly approved in this manual could void your authority to operate this equipment.

## Note to CATV system installer:

This reminder is provided to call CATV system installer's attention to Article 820-40 of the NEC that provides guidelines for proper grounding and, in particular, specifies that the cable ground shall be connected to the grounding system of the building, as close to the point of cable entry as practical.

## About This Manual

- The instructions in this manual are for model STR-DG710. Check your model number by looking at the lower right corner of the front panel. In this manual, models of area code U is used for illustration purposes unless stated otherwise. Any difference in operation is clearly indicated in the text, for example, “Models of area code CA only”.
- The instructions in this manual describe the controls on the supplied remote. You can also use the controls on the receiver if they have the same or similar names as those on the remote.

### About area codes

The area code of the receiver you purchased is shown on the lower right portion of the rear panel (see the illustration below).

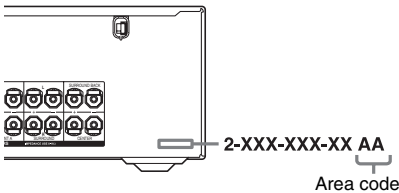

Any differences in operation, according to the area code, are clearly indicated in the text, for example, “Models of area code AA only”.

This receiver incorporates Dolby\* Digital and Pro Logic Surround and the DTS\*\* Digital Surround System.

- \* Manufactured under license from Dolby Laboratories.  
“Dolby”, “Pro Logic”, “Surround EX”, and the double-D symbol are trademarks of Dolby Laboratories.
- \*\* “DTS”, “DTS-ES | Neo:6” are registered trademarks of DTS, Inc. “96/24” is a trademark of DTS, Inc.

This receiver incorporates High-Definition Multimedia Interface (HDMI™) technology. HDMI, the HDMI logo and High-Definition Multimedia Interface are trademarks or registered trademarks of HDMI Licensing LLC.

XM is a registered trademark of XM Satellite Radio Inc.

---

# Table of Contents

---

## Getting Started

Description and location of parts.....	5
1: Installing speakers .....	14
2: Connecting speakers.....	15
3a: Connecting the audio components.....	16
3b: Connecting the video components .....	17
4: Connecting the antennas (aerials).....	25
5: Preparing the receiver and the remote .....	26
6: Selecting the speaker system.....	27
7: Calibrating the appropriate settings automatically (AUTO CALIBRATION).....	28
8: Adjusting the speaker levels and balance (TEST TONE).....	31

---

## Playback

Selecting a component.....	33
Listening/Watching a component .....	34

---

## Amplifier Operations

Navigating through menus.....	36
Adjusting the level (LEVEL menu).....	40
Adjusting the equalizer (EQ menu).....	41
Settings for the surround sound (SUR menu).....	41
Settings for the tuner (TUNER menu).....	43
Settings for the audio (AUDIO menu).....	43
Settings for the video (VIDEO menu).....	44
Settings for the system (SYSTEM menu) .....	45
Calibrating the appropriate settings automatically (A. CAL menu).....	49

---

## Enjoying Surround Sound

Enjoying Dolby Digital and DTS Surround sound (AUTO FORMAT DIRECT) .....	49
Selecting a pre-programmed sound field.....	51
Using only the front speakers (2CH STEREO).....	54

Listening to the sound without any adjustment (ANALOG DIRECT).....	54
Resetting sound fields to the initial settings .....	55

---

## Tuner Operations

Listening to FM/AM radio.....	55
Presetting radio stations .....	57
Listening to the XM Radio .....	60
Presetting XM Radio stations .....	64

---

## Other Operations

Switching between digital and analog audio (INPUT MODE) .....	67
Enjoying the DIGITAL MEDIA PORT (DMPORT) .....	68
Listening to digital sound from other inputs (DIGITAL ASSIGN).....	71
Naming inputs.....	72
Changing the display .....	73
Using the Sleep Timer .....	73
Recording using the receiver.....	74

---

## Using the Remote

Changing button assignments .....	74
-----------------------------------	----

---

## Additional Information

Glossary .....	75
Precautions.....	77
Troubleshooting .....	78
Specifications.....	82
Index .....	Back cover

## Description and location of parts

### Front panel

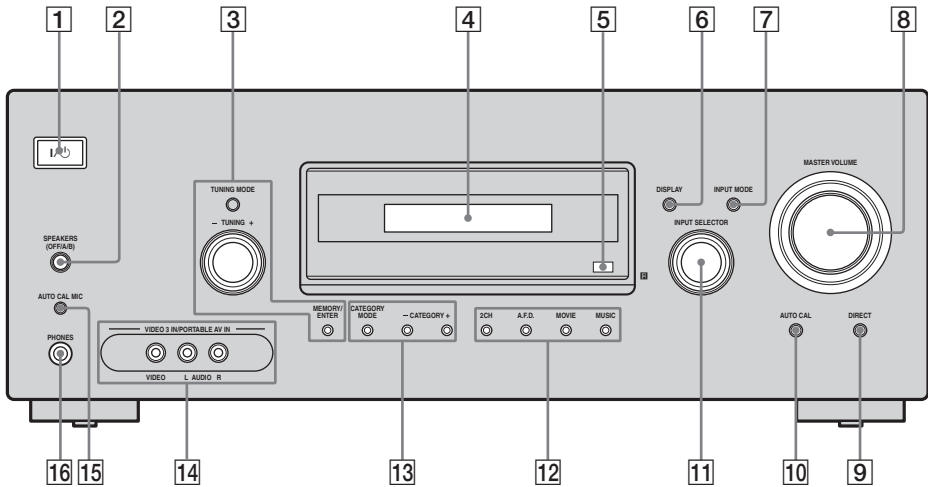

Name	Function
1 <b>I/O</b> <b>(on/standby)</b>	Press to turn the receiver on or off (page 26, 34, 35, 55, 82).
2 <b>SPEAKERS (OFF/A/B)</b>	Press to select the front speaker system (page 27).
3 <b>TUNING MODE</b> <b>TUNING +/-</b> <b>MEMORY/ENTER</b>	Press or turn to operate the tuner (FM/AM/XM) (page 55).
4 <b>Display</b>	The current status of the selected component or a list of selectable items appears here (page 7).
5 <b>Remote sensor</b>	Receives signals from remote commander.
6 <b>DISPLAY</b>	Press to select information displayed on the display (page 73).

Name	Function
7 <b>INPUT MODE</b>	Press to select the input mode when the same components are connected to both digital and analog jacks (page 67).
8 <b>MASTER VOLUME</b>	Turn to adjust the volume level of all speakers at the same time (page 32, 33, 34, 35).
9 <b>DIRECT</b>	Press to listen to high quality analog sound (page 54).
10 <b>AUTO CAL</b>	Press to activate the Auto Calibration function (page 29).
11 <b>INPUT SELECTOR</b>	Turn to select the input source to play back (page 33, 34, 35, 54, 56, 58, 59, 67, 72, 74).

*continued*

<b>Name</b>	<b>Function</b>
<b>12</b> <b>2CH</b> <b>A.F.D.</b> <b>MOVIE</b> <b>MUSIC</b>	Press to select a sound field (page 49).
<b>13</b> <b>CATEGORY MODE</b> <b>CATEGORY +/-</b>	Used when listening to XM Radio (page 60).
<b>14</b> <b>VIDEO 3 IN/ PORTABLE AV IN jacks</b>	Connects to a portable audio/video component such as a camcorder or video game (page 24, 33).
<b>15</b> <b>AUTO CAL MIC jack</b>	Connects to the supplied optimizer microphone for the Auto Calibration function (page 28).
<b>16</b> <b>PHONES jack</b>	Connects to headphones (page 78).

## About the indicators on the display

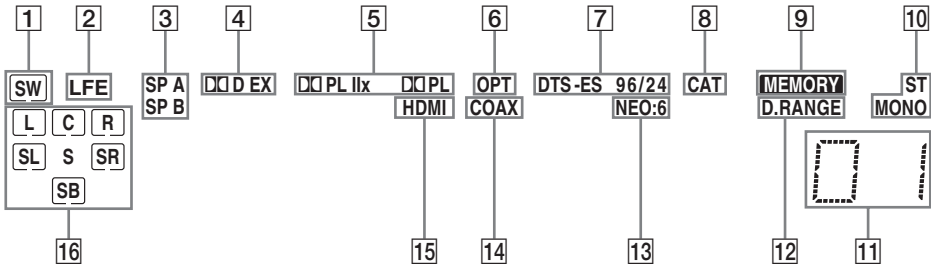

Name	Function
1 SW	Lights up when sub woofer selection is set to "YES" (page 45) and the audio signal is output from the SUB WOOFER jack.
2 LFE	Lights up when the disc being played back contains an LFE (Low Frequency Effect) channel and the LFE channel signal is actually being reproduced.
3 SP A/SP B	Lights up according to the speaker system used. However, these indicators do not light up if the speaker output is turned off or if headphones are connected.
4 D D/ D EX	"D D" lights up when the receiver is decoding Dolby Digital signals. "D D EX" lights up when the receiver is decoding Dolby Digital Surround EX signals. <b>Note</b> When playing a Dolby Digital format disc, be sure that you have made digital connections and that INPUT MODE is not set to "ANALOG" (page 67).

Name	Function
5 PL/ PLII/ PLIIX	"PL" lights up when the receiver applies Pro Logic processing to 2 channel signals in order to output the center and surround channel signals. "PLII" lights up when the Pro Logic II Movie/Music/Game decoder is activated. "PLIIX" lights up when the Pro Logic IIX Movie/Music/Game decoder is activated. However, these indicators do not light up if both the center and surround speakers are set to "NO" (page 39) and you select a sound field using the A.F.D. button. <b>Note</b> Dolby Pro Logic IIX decoding does not function for DTS format signals or for signals with a sampling frequency of more than 48 kHz.
6 OPT	Lights up when INPUT MODE is set to "AUTO IN" and the source signal is a digital signal being input through the OPTICAL jack, or when INPUT MODE is set to "OPT IN" (page 67).



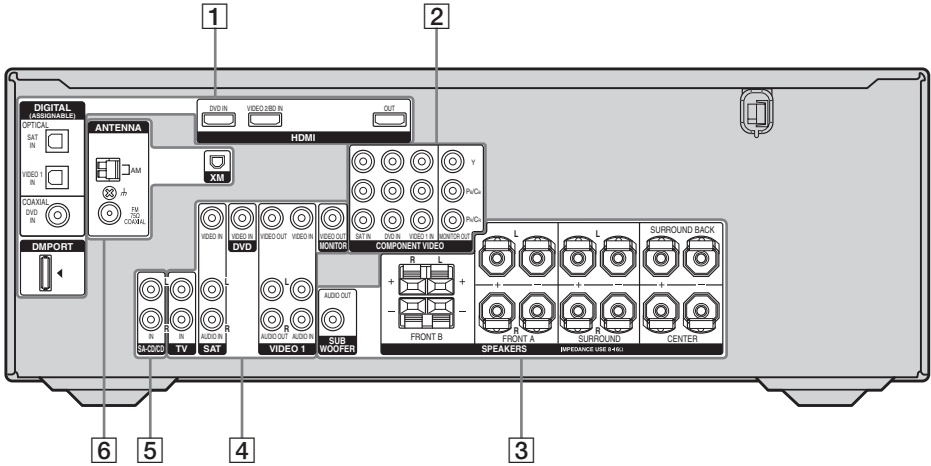

Name	Function
<b>7 DTS/ DTS-ES/ DTS 96/24</b>	<p>“DTS” lights up when the receiver is decoding DTS signals. “DTS-ES” lights up when the receiver is decoding DTS-ES signals. “DTS 96/24” lights up when the receiver is decoding DTS 96/24 (96 kHz/24 bit) signals.</p> <p><b>Note</b> When playing a DTS format disc, be sure that you have made digital connections and that INPUT MODE is not set to “ANALOG” (page 67).</p>
<b>8 CAT</b>	Lights up when “ALL CAT” mode is changed to “ONE CAT” mode during XM Radio operation (page 63).
<b>9 MEMORY</b>	Lights up when a memory function, such as Preset Memory (page 58), etc., is activated.
<b>10 Tuner indicators</b>	Lights up when using the receiver to tune in radio stations (page 55), etc.
<b>11 Preset station indicators</b>	Lights up when using the receiver to tune in radio stations you have preset. For details on presetting radio stations, see page 57.
<b>12 D.RANGE</b>	Lights up when dynamic range compression is activated (page 37).
<b>13 NEO:6</b>	Lights up when DTS Neo:6 Cinema/Music decoder is activated (page 50).
<b>14 COAX</b>	Lights up when INPUT MODE is set to “AUTO IN” and the source signal is a digital signal being input through the COAXIAL jack, or when INPUT MODE is set to “COAX IN” (page 67)
<b>15 HDMI</b>	Lights up when the receiver recognizes a component connected via a HDMI IN jack (page 18).

Name	Function
<b>16 Playback channel indicators</b>	<p>The letters (L, C, R, etc.) indicate the channels being played back. The boxes around the letters vary to show how the receiver downmixes the source sound (based on the speaker settings).</p> <p><b>L</b> Front Left  <b>R</b> Front Right  <b>C</b> Center (monaural)  <b>SL</b> Surround Left  <b>SR</b> Surround Right  <b>S</b> Surround (monaural or the surround components obtained by Pro Logic processing)  <b>SB</b> Surround back (the surround back components obtained by 6.1 channel decoding)</p> <p><b>Example:</b> Recording format (Front/ Surround): 3/2.1 Output channel: When surround speakers are set to “NO” (page 39) Sound Field: A.F.D. AUTO</p>
	<p>The diagram shows a top-down view of a speaker layout. At the top is a box labeled 'SW'. Below it are three boxes labeled 'L', 'C', and 'R' from left to right. Below 'L' is a box labeled 'SL', and below 'R' is a box labeled 'SR'.</p>







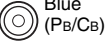

## 1 DIGITAL INPUT/OUTPUT section

	<b>OPTICAL IN jacks</b>	Connects to a DVD player, etc. The <b>COAXIAL</b> jack provides a better quality of loud sound (page 21, 23).
	<b>COAXIAL IN jack</b>	
	<b>HDMI IN/OUT jacks*</b>	Connects to a DVD player, etc. The image and the sound are output to a TV or a projector (page 18).
	<b>DMPort jack</b>	Connects to a <b>DIGITAL MEDIA PORT</b> adapter (page 69).



## 2 COMPONENT VIDEO INPUT/OUTPUT section

	<b>Green (Y) COMPONENT VIDEO INPUT/OUTPUT jacks*</b>	Connects to a DVD player, TV, or a satellite tuner. You can enjoy high quality image (page 20–23).
	<b>Blue (P<sub>B</sub>/C<sub>B</sub>) COMPONENT VIDEO INPUT/OUTPUT jacks*</b>	
	<b>Red (P<sub>R</sub>/C<sub>R</sub>) COMPONENT VIDEO INPUT/OUTPUT jacks*</b>	

## 3 SPEAKERS section

		Connects to speakers (page 15).
		
		Connects to a sub woofer (page 15).

## 4 VIDEO/AUDIO INPUT/OUTPUT section

	<b>White (L) AUDIO IN/OUT jacks</b>	Connects to a VCR, a DVD player, etc. (page 20–24).
	<b>Red (R) AUDIO IN/OUT jacks</b>	
	<b>Yellow VIDEO IN/OUT jacks*</b>	

## 5 AUDIO INPUT section

	<b>White (L) AUDIO IN jacks</b>	Connects to a CD player, etc. (page 16).
	<b>Red (R) AUDIO IN jacks</b>	

continued

## 6 ANTENNA section

	FM ANTENNA jack	Connects to the FM wire antenna (aerial) supplied with this receiver (page 25).
	AM ANTENNA terminals	Connects to the AM loop antenna (aerial) supplied with this receiver (page 25).
	XM ANTENNA jack	Connects to the XM Connect-and-Play antenna (not supplied) (page 61).

\* You can watch the selected input image when you connect the MONITOR OUT or HDMI OUT jack to a TV or projector (page 20).

## Remote commander



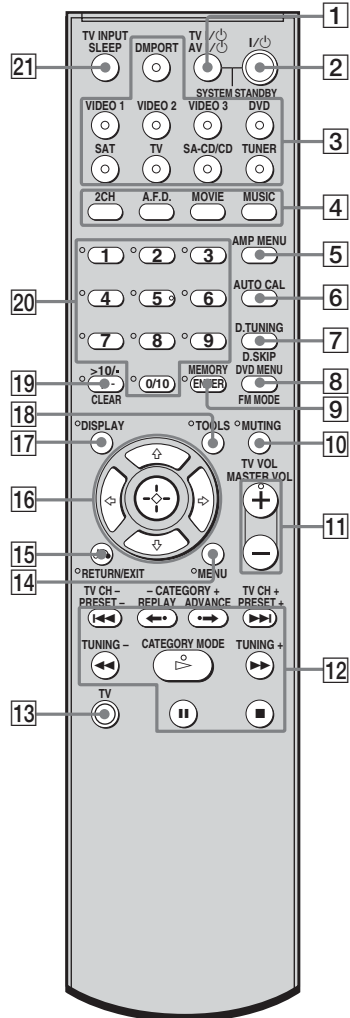





You can use the supplied remote RM-AAU014 to operate the receiver and to control the Sony audio/video components that the remote is assigned to operate (page 74).











Name	Function
<b>1</b> TV I/⏻ (on/standby)	Press TV I/⏻ and TV (13) at the same time to turn the TV on or off.
<b>AV I/⏻ (on/standby)</b>	Press to turn on or off the Sony audio/video components that the remote is assigned to operate (page 74). If you press I/⏻ (2) at the same time, it will turn off the receiver and other components (SYSTEM STANDBY). <b>Note</b> The function of the AV I/⏻ switch changes automatically each time you press the input buttons (3).
<b>2</b> I/⏻ (on/standby)	Press to turn the receiver on or off. To turn off all components, press I/⏻ and AV I/⏻ (1) at the same time (SYSTEM STANDBY).
<b>3</b> Input buttons	Press one of the buttons to select the component you want to use. When you press any of the input buttons, the receiver turns on. The buttons are factory assigned to control Sony components as follows. You can change the button assignments following the steps in "Changing button assignments" on page 74.
<b>Button</b>	<b>Assigned Sony component</b>
DMPORT	DIGITAL MEDIA PORT adapter
VIDEO 1	VCR (VTR mode 3)
VIDEO 2	VCR (VTR mode 2)
VIDEO 3	Not assigned
DVD	DVD player
SAT	Digital Satellite Receiver
TV	TV
SA-CD/CD	Super Audio CD/ CD player
TUNER	Built-in tuner

Name	Function
<b>4</b> 2CH A.F.D. MOVIE MUSIC	Press to select a sound field.
<b>5</b> AMP MENU	Press to display the menu of the receiver. Then, use ↑, ↓, ←, → and ⊕ (16) to perform menu operations.
<b>6</b> AUTO CAL	Press to activate the Auto Calibration function.
<b>7</b> D.TUNING D.SKIP	Press to enter direct tuning mode. Press to skip a disc when using a multi-disc changer.
<b>8</b> DVD MENU FM MODE	Press to display the menu of the DVD player on the TV screen. Then, use ↑, ↓, ←, → and ⊕ (16) to perform menu operations. Press to select the FM monaural or stereo reception.
<b>9</b> ENTER MEMORY	Press to enter the value after selecting a channel, disc or track using the numeric buttons of the TV, VCR or satellite tuner. Press to store a station.
<b>10</b> MUTING	Press to activate the muting function. Press MUTING and TV (13) at the same time to activate the TV's muting function.
<b>11</b> TV VOL + <sup>a)</sup> /– MASTER VOL + <sup>a)</sup> /–	Press TV VOL +/– and TV (13) at the same time to adjust the TV volume level. Press to adjust the volume level of all speakers at the same time.
<b>12</b> ⏮/⏭ <sup>b)</sup>	Press to skip a track of the CD player, DVD player or blu-ray disc player.
<b>REPLAY</b> ←–/ <b>ADVANCE</b> →→	Press to replay the previous scene or fast forward the current scene of the VCR, DVD player or blu-ray disc player.

continued

Name	Function
 b)	Press to – search tracks in the forward/ reverse direction of the DVD player. – start fast forward/rewind of the VCR, CD player or blu- ray disc player.
 a)b)	Press to start playback of the VCR, CD player, DVD player, or blu-ray disc player.
 b)	Press to pause playback or recording of the VCR, CD player, DVD player or blu-ray disc player. (Also starts recording with components in recording standby.)
 b)	Press to stop playback of the VCR, CD player, DVD player or blu-ray disc player.
<b>TV CH +/-</b>	Press TV CH +/- and TV (13) at the same time to select preset TV channels.
<b>CATEGORY +/-</b>	Press to select the category for XM Radio (page 63).
<b>PRESET +/-</b>	Press to select – preset stations. – preset channels of the VCR or satellite tuner.
<b>TUNING +/-</b>	Press to scan a station.
<b>CATEGORY MODE</b>	Press to select the category mode for XM Radio (page 63).
<b>13 TV</b>	Press TV and the button you want at the same time to activate the buttons with orange printing.
<b>14 MENU</b>	Press to display the menu of the VCR, DVD player, satellite tuner or blu-ray disc player on the TV screen. Press MENU and TV (13) at the same time to display the TV's menu. Then, use  ,  ,  ,  and  (16) to perform menu operations.

Name	Function
<b>15 RETURN/ EXIT</b> 	Press to – return to the previous menu. – exit the menu while the menu or on-screen guide of the VCR, DVD player, satellite tuner or blu-ray disc player is displayed on the TV screen. Press RETURN/EXIT and TV (13) at the same time to return to the previous menu or exit the TV's menu while the menu is displayed on the TV screen.
<b>16</b>  	After pressing AMP MENU (5), DVD MENU (8), or MENU (14), press  ,  ,  or  to select the settings. Then, press  to enter the selection for DVD MENU or MENU. Press  also to enter the selection of the receiver, VCR, satellite tuner, CD player, DVD player or blu-ray disc player.
<b>17 DISPLAY</b>	Press to select information displayed on the TV screen of the VCR, satellite tuner, CD player, DVD player or blu-ray disc player. Press DISPLAY and TV (13) at the same time to display TV's information on the TV screen.
<b>18 TOOLS</b>	Press to display options applicable to the entire disc (e.g. disc protection), recorder (e.g. audio settings during recording), or multiple items on a list menu (e.g. erasing multiple titles). Press TOOLS and TV (13) at the same time to display options applicable to the TV.

Name	Function
<b>19</b> <b>-/--</b>	Press <b>-/--</b> and TV ( <b>13</b> ) at the same time to select the channel entry mode, either one or two digits of the TV.
<b>&gt;10/-</b>	Press to select – track numbers over 10 of the VCR, satellite tuner or CD player. – channel numbers of the Digital CATV terminal.
<b>CLEAR</b>	Press to clear a mistake when you press the incorrect numeric button.
<b>20</b> <b>Numeric buttons (number 5<sup>a</sup>)</b>	Press to – preset/tune to preset stations. – select track numbers of the CD player, DVD player or blu-ray disc player. Press 0/10 to select track number 10. – select channel numbers of the VCR or satellite tuner. Press the numeric buttons and TV ( <b>13</b> ) at the same time to select the TV channels.
<b>21</b> <b>TV INPUT</b>	Press TV INPUT and TV ( <b>13</b> ) at the same time to select the input signal (TV input or video input).
<b>SLEEP</b>	Press to activate the Sleep Timer function and the duration which the receiver turns off automatically.

<sup>a)</sup>The number 5, MASTER VOL +, TV VOL +, and  $\triangleright$  buttons have tactile dots. Use the tactile dots as references when operating the receiver.

<sup>b)</sup>This button is also available for DIGITAL MEDIA PORT adapter operation. For details on the function of the button, refer to the operating instructions supplied with the DIGITAL MEDIA PORT adapter.

## Notes

- Some functions explained in this section may not work depending on the model.
- The above explanation is intended to serve as an example only. Therefore, depending on the component, the above operation may not be possible or may operate differently than described.

# 1: Installing speakers

This receiver allows you to use a 6.1 channel system (6 speakers and one sub woofer).

## Enjoying a 5.1/6.1 channel system

To fully enjoy theater-like multi channel surround sound requires five speakers (two front speakers, a center speaker, and two surround speakers) and a sub woofer (5.1 channel).

### Example of a 5.1 channel speaker system configuration

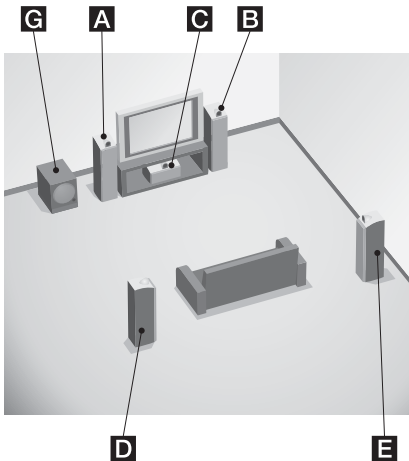

- A** Front speaker (left)
- B** Front speaker (right)
- C** Center speaker
- D** Surround speaker (left)
- E** Surround speaker (right)
- G** Sub woofer

You can enjoy high fidelity reproduction of DVD software recorded sound in the Surround EX format if you connect one additional surround back speaker (6.1 channel) (see “Using the surround back decoding mode (SB DEC)” on page 42).

### Example of a 6.1 channel speaker system configuration

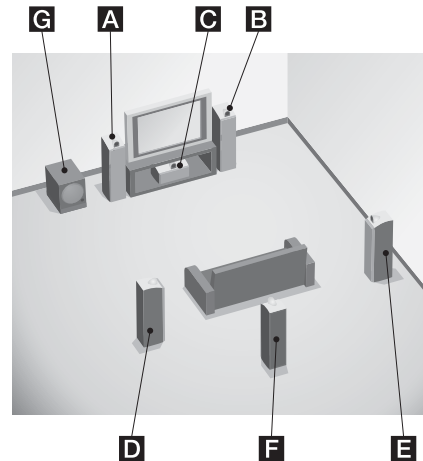

- A** Front speaker (left)
- B** Front speaker (right)
- C** Center speaker
- D** Surround speaker (left)
- E** Surround speaker (right)
- F** Surround back speaker
- G** Sub woofer

#### Tip

Since the sub woofer does not emit highly directional signals, you can place it wherever you want.

## 2: Connecting speakers

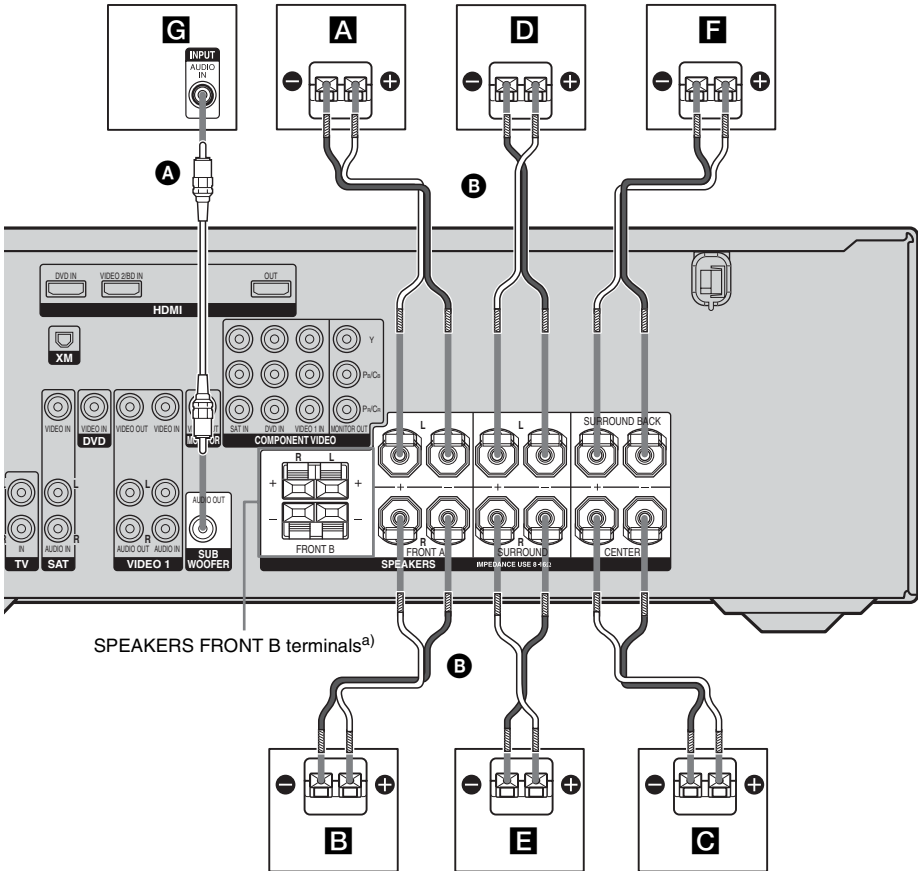

**A** Monaural audio cord (not supplied)

**B** Speaker cords (not supplied)

**A** Front speaker A (left)

**B** Front speaker A (right)

**C** Center speaker

**D** Surround speaker (left)

**E** Surround speaker (right)

**F** Surround back speaker

**G** Sub woofer<sup>b)</sup>

<sup>a)</sup> If you have an additional front speaker system, connect them to the SPEAKERS FRONT B terminals. You can select the front speakers you want to use with SPEAKERS (OFF/A/B) on the receiver (page 27).

<sup>b)</sup> When you connect a sub woofer with an auto standby function, turn off the function when watching movies. If the auto standby function is set to on, it turns to standby mode automatically based on the level of the input signal to a sub woofer, then sound may not be output.

# 3a: Connecting the audio components

## Connecting a Super Audio CD/CD player

The following illustration shows how to connect a Super Audio CD/CD player. After connecting your Super Audio CD/CD player, proceed to “3b: Connecting the video components” (page 17).

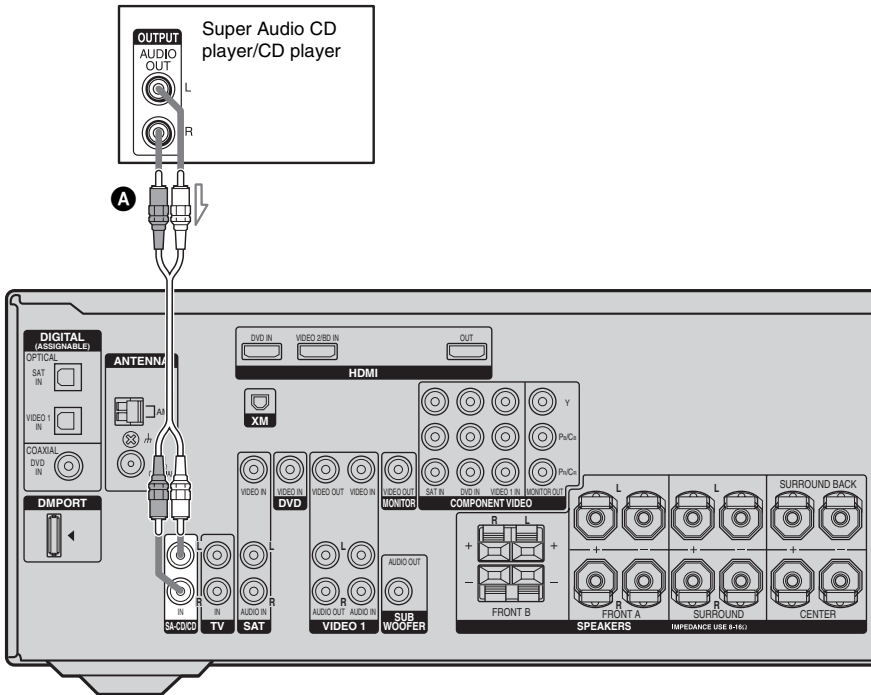

**A** Audio cord (not supplied)



## 3b: Connecting the video components

### How to connect your components

This section describes how to connect your video components to this receiver. Before you begin, refer to “Component to be connected” below for the pages which describe how to connect each component.

After connecting all your components, proceed to “4: Connecting the antennas (aerials)” (page 25).

### Component to be connected

Component	Page
With HDMI jack	18
TV	20
DVD player/DVD recorder	21
Satellite tuner/Set-top box	23
VCR	24
Camcorder, video game, etc.	24

### If you want to connect several digital components, but cannot find an unused input

See “Listening to digital sound from other inputs (DIGITAL ASSIGN)” (page 71).

### Video input/output jacks to be connected

The image quality depends on the connecting jack. Refer to the illustration that follows. Select the connection according to the jacks on your components.

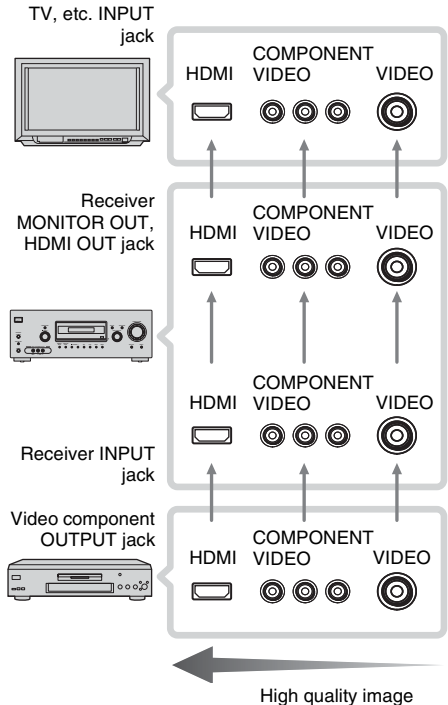

## Connecting components with HDMI jacks

HDMI is the abbreviated name for High-Definition Multimedia Interface. It is an interface which transmits video and audio signals in digital format.

## HDMI feature

A digital audio signal transmitted by HDMI can be output from the speakers on this receiver. This signal supports Dolby Digital, DTS, and linear PCM.

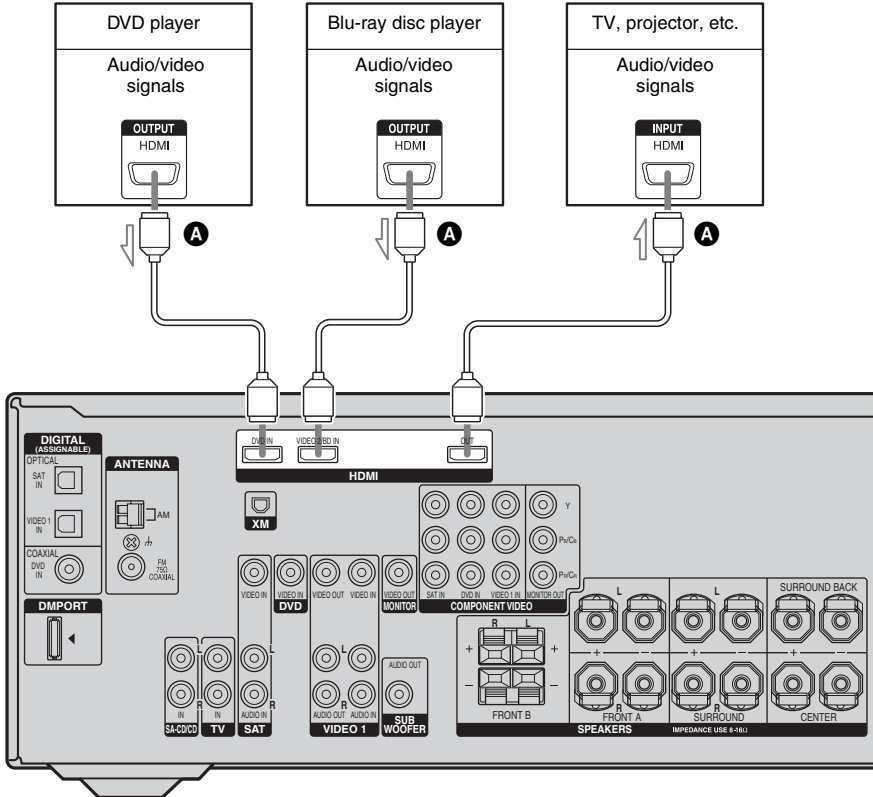

### **A** HDMI cable (not supplied)

We recommend that you use a Sony HDMI cable.

## Notes on HDMI connections

- Check the setup of the connected component if an image is poor or the sound does not come out of a component connected via the HDMI cable.
- An audio signal input to the HDMI IN jack is output from the speaker output jack and HDMI OUT jack. It is not output from any other audio jacks.
- Video signals input to the HDMI IN jack can only be output from the HDMI OUT jack. The video input signals cannot be output from the VIDEO OUT jacks or MONITOR OUT jacks.
- When you want to listen to the sound from the TV speaker, set “AUDIO” to “TV+AMP” in the VIDEO menu (page 44). If set to “AMP”, the sound is not output from the TV speaker.
- The multi/stereo area audio signals of a Super Audio CD are not output.
- Audio signals (sampling frequency, bit length, etc.) transmitted from a HDMI jack may be suppressed by the connected component. Check the setup of the connected component if an image is poor or the sound does not come out of a component connected via the HDMI cable.
- Sound may be interrupted when the sampling frequency or the number of channels of audio output signals from the playback component is switched.
- When the connected component is not compatible with copyright protection technology (HDCP), the image and/or the sound from the HDMI OUT jack may be distorted or may not be output. In this case, check the specification of the connected component.
- Set the resolution of the image of the playback component to 720p or 1080i when you output 96 kHz multi-channel sound over a HDMI connection.
- Refer to the operating instructions of each component connected for details.

- We do not recommend using a HDMI-DVI conversion cable. When you connect a HDMI-DVI conversion cable to a DVI-D component, the sound and/or the image may not be output.

## Notes

- Be sure to turn on the receiver when the video and audio signals of a playback component are being output to a TV via the receiver. Unless the power is turned on, neither video nor audio signals will be transmitted.
- Be sure to change the factory setting of the VIDEO 2 input button on the remote so that you can use the button to control your blu-ray disc player. For details, see “Changing button assignments” (page 74).
- You can also rename the VIDEO 2 input so that it can be displayed on the receiver’s display. For details, see “Naming inputs” (page 72).

## Connecting a TV

The image from a video component connected to this receiver can be displayed on a TV screen.

It is not necessary to connect all the cords. Connect audio and video cords according to the jacks of your components.

### Note

Be sure to turn on the receiver when the video and audio signals of a playback component are being output to a TV via the receiver. Unless the power is turned on, neither video nor audio signals will be transmitted.

### Tips

- You can watch the selected input image when you connect the MONITOR OUT jack to a TV or projector.
- The sound of the TV is output from the speakers connected to the receiver if you connect the audio output jack of the TV and the TV IN jacks of the receiver.

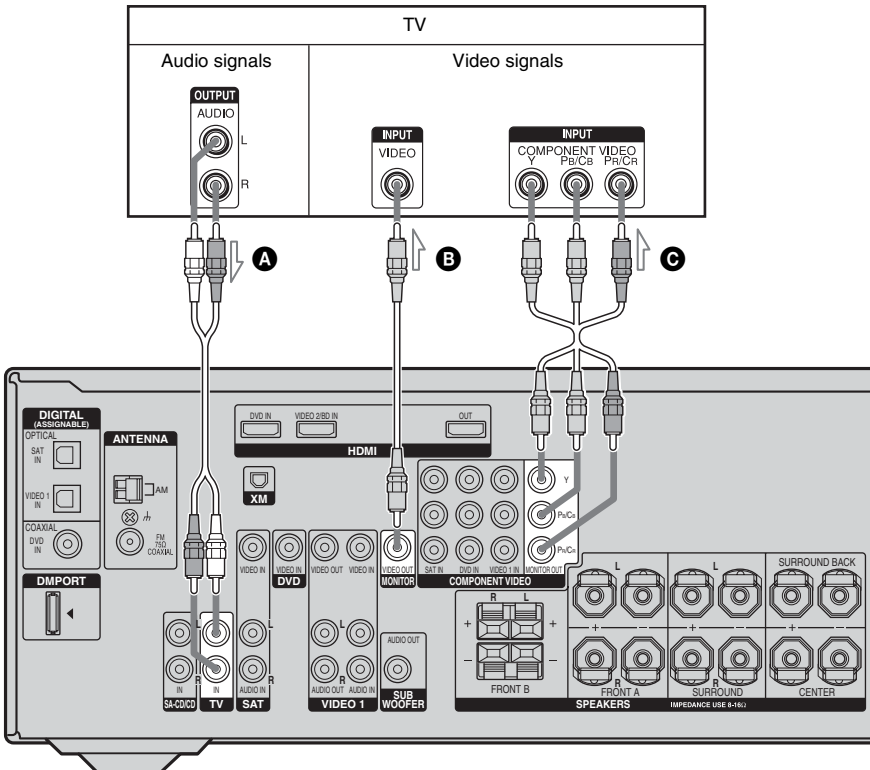

- Ⓐ Audio cord (not supplied)
- Ⓑ Video cord (not supplied)
- Ⓒ Component video cord (not supplied)

## Connecting a DVD player/DVD recorder

The following illustration shows how to connect a DVD player/DVD recorder. It is not necessary to connect all the cords. Connect audio and video cords according to the jacks of your components.

### Note

To input multi channel digital audio from the DVD player, set the digital audio output setting on the DVD player. Refer to the operating instructions supplied with the DVD player.

### Tip

All the digital audio jacks are compatible with 32 kHz, 44.1 kHz, 48 kHz, and 96 kHz sampling frequencies.

## Connecting a DVD player

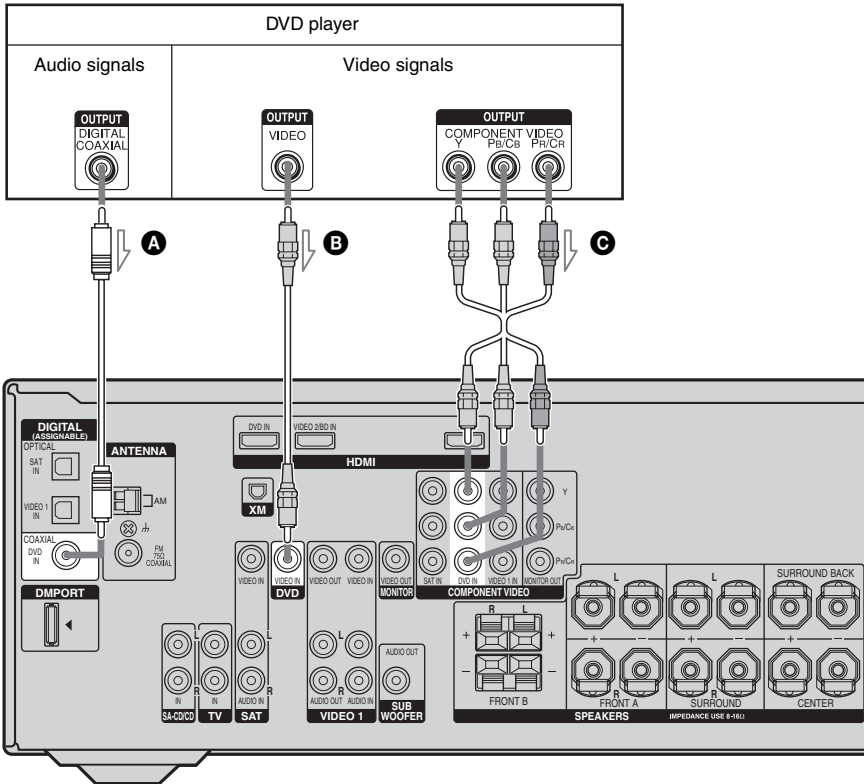

- A** Coaxial digital cord (not supplied)
- B** Video cord (not supplied)
- C** Component video cord (not supplied)

continued

# Connecting a DVD recorder

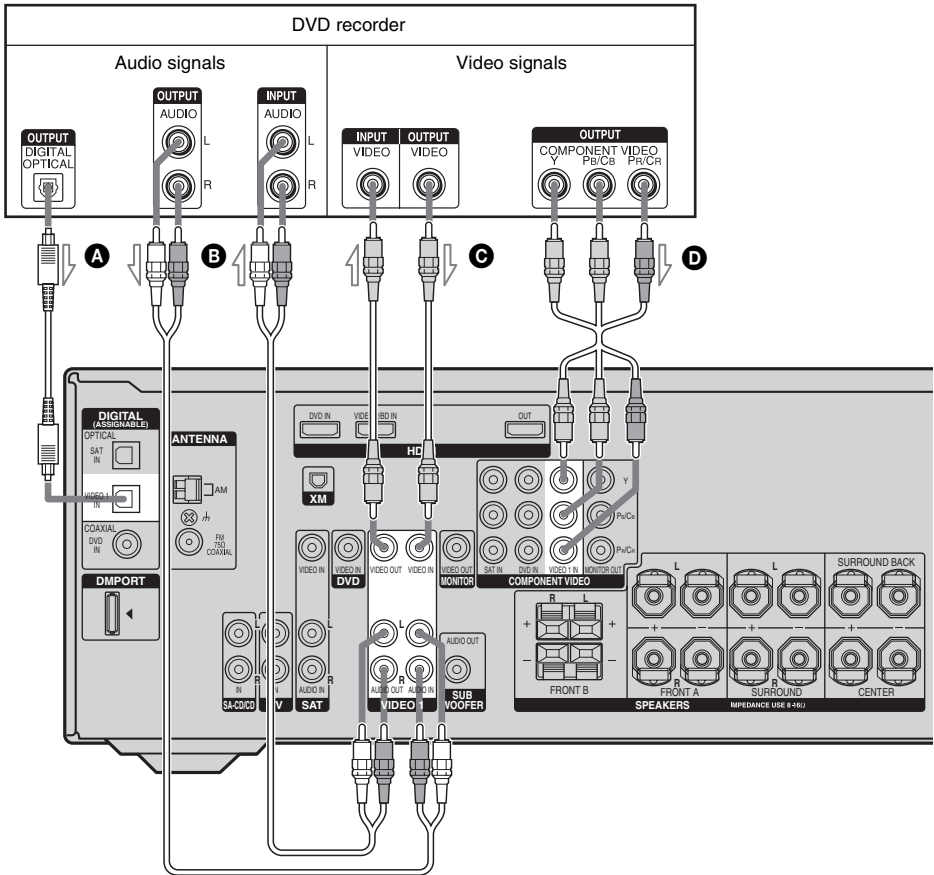

- A** Optical digital cord (not supplied)
- B** Audio cord (not supplied)
- C** Video cord (not supplied)
- D** Component video cord (not supplied)

## Notes

- Be sure to change the factory setting of the VIDEO 1 input button on the remote so that you can use the button to control your DVD recorder. For details, see “Changing button assignments” (page 74).
- You can also rename the VIDEO 1 input so that it can be displayed on the receiver’s display. For details, see “Naming inputs” (page 72).
- When connecting optical digital cords, insert the plugs straight in until they click into place.
- Do not bend or tie optical digital cords.

## Tip

All the digital audio jacks are compatible with 32 kHz, 44.1 kHz, 48 kHz, and 96 kHz sampling frequencies.

## Connecting a satellite tuner/ set-top box

The following illustration shows how to connect a satellite tuner or a set-top box. It is not necessary to connect all the cords. Connect audio and video cords according to the jacks of your components.

### Notes

- When connecting optical digital cords, insert the plugs straight in until they click into place.
- Do not bend or tie optical digital cords.

### Tip

All the digital audio jacks are compatible with 32 kHz, 44.1 kHz, 48 kHz, and 96 kHz sampling frequencies.

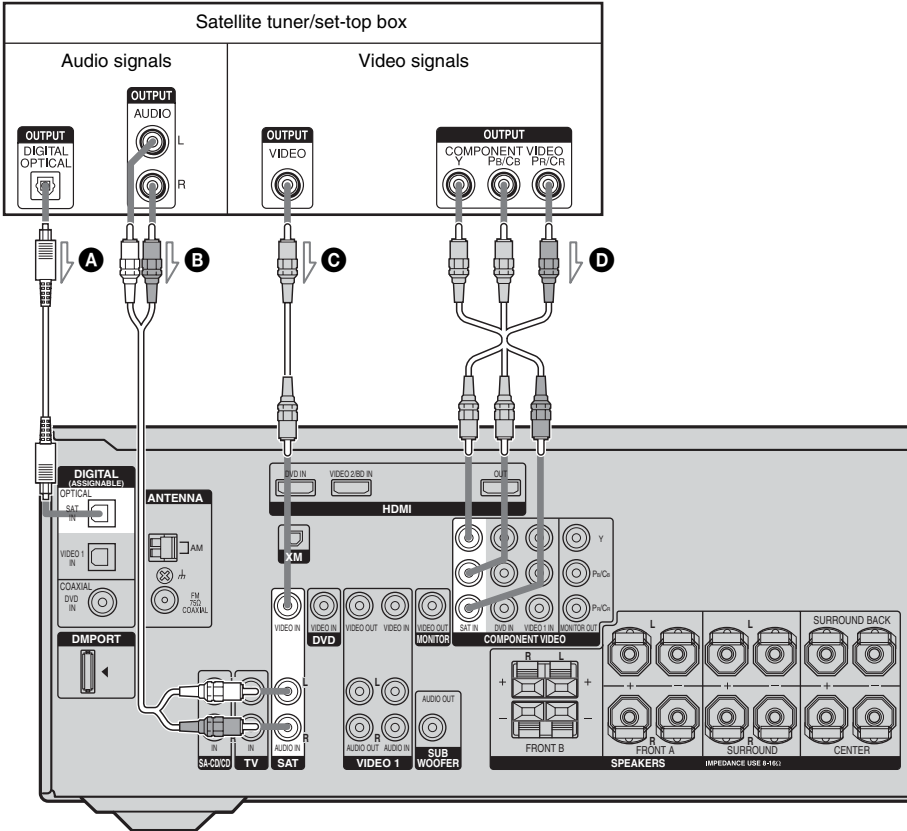

- A** Optical digital cord (not supplied)
- B** Audio cord (not supplied)
- C** Video cord (not supplied)
- D** Component video cord (not supplied)

## Connecting components with analog video and audio jack

The following illustration shows how to connect a component which has analog jacks such as a VCR, etc.

It is not necessary to connect all the cords.  
Connect audio and video cords according to the jacks of your components.

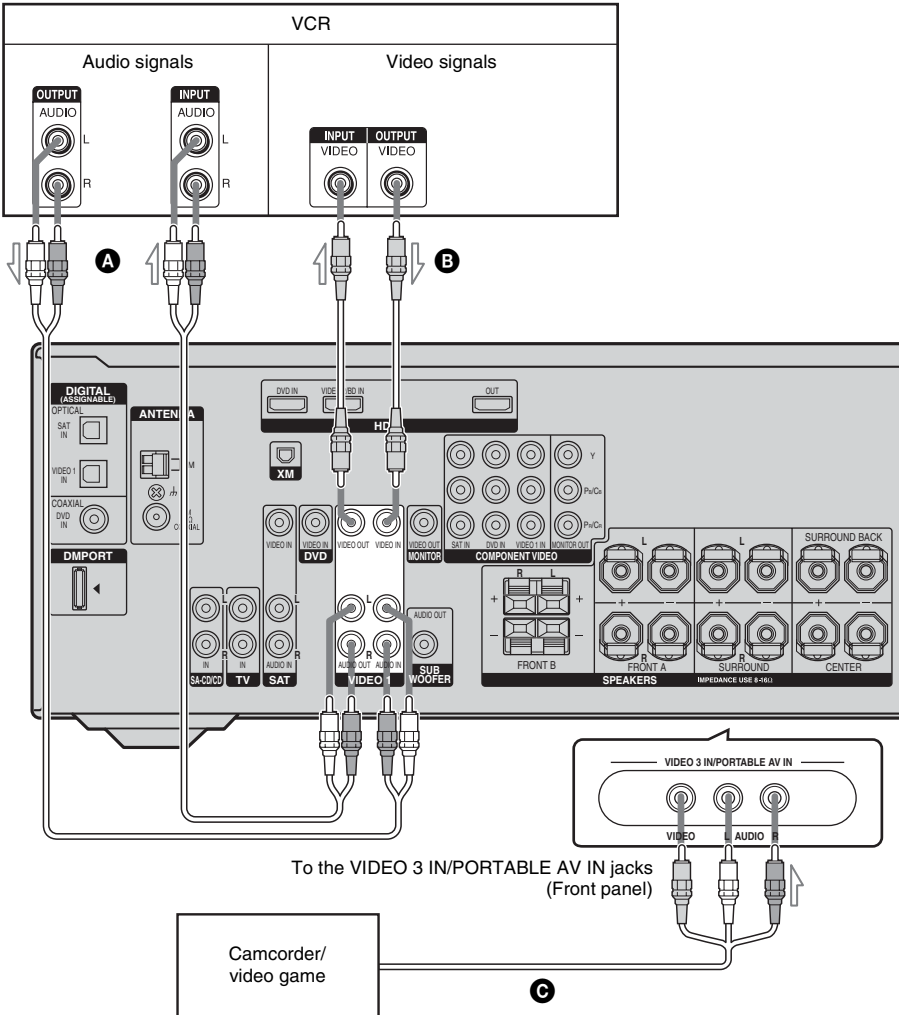



## 4: Connecting the antennas (aerials)

Connect the supplied AM loop antenna (aerial) and FM wire antenna (aerial).

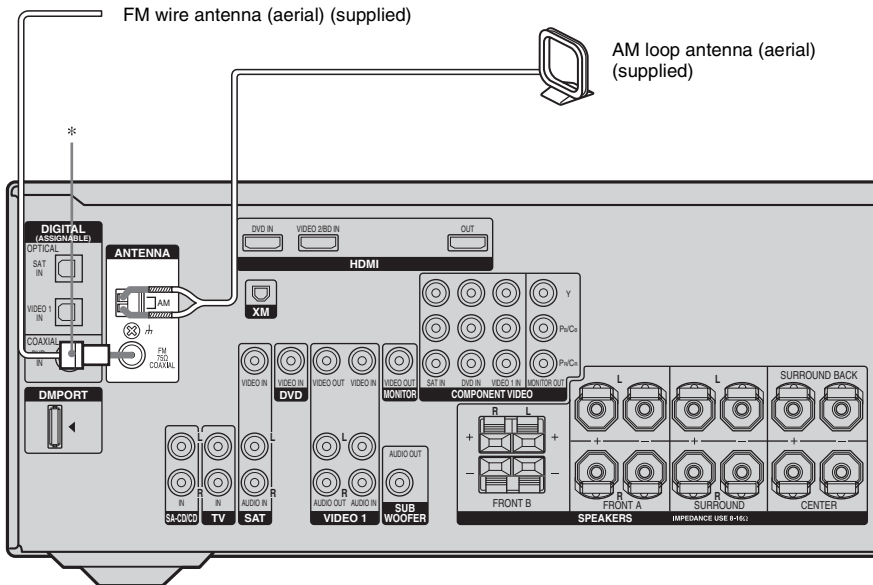

\* The shape of the connector varies depending on the area code of this receiver.

### Notes

- To prevent noise pickup, keep the AM loop antenna (aerial) away from the receiver and other components.
- Be sure to fully extend the FM wire antenna (aerial).
- After connecting the FM wire antenna (aerial), keep it as horizontal as possible.

## 5: Preparing the receiver and the remote

### Connecting the AC power cord (mains lead)

Connect the AC power cord (mains lead) to a wall outlet.

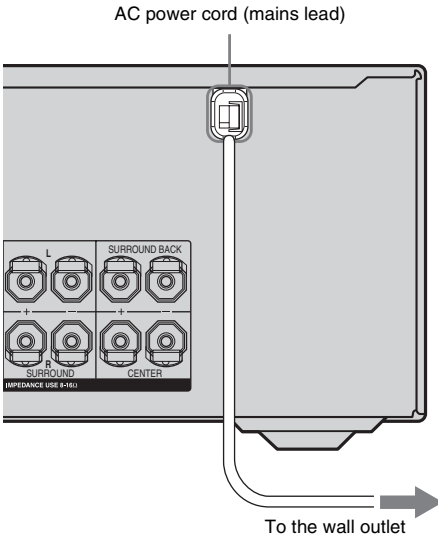

### Performing initial setup operations

Before using the receiver for the first time, initialize the receiver by performing the following procedure. This procedure can also be used to return settings you have made to their factory defaults.

Be sure to use the buttons on the receiver for this operation.

## 1,2

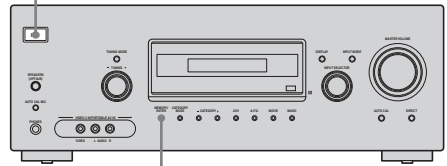

## 3

- 1 Press I/⏻ to turn off the receiver.**
- 2 Hold down I/⏻ for 5 seconds.** “PUSH” and “ENTER” appears on the display alternately.
- 3 Press MEMORY/ENTER.**

After “CLEARING” appears on the display for a while, “CLEARED” appears.

The following items are reset to their factory settings.

- All settings in the LEVEL, EQ, SUR, TUNER, AUDIO, VIDEO and SYSTEM menus.
- The sound field memorized for each input and preset station.
- All sound field parameters.
- All preset stations.
- All index names for inputs and preset stations.
- MASTER VOLUME is set to “VOL MIN”.
- Input is set to “DVD”.

## Inserting batteries into the remote

Insert two R6 (size-AA) batteries in the RM-AAU014 remote commander. Observe the correct polarity when installing batteries.

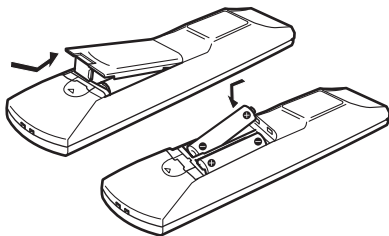

### Notes

- Do not leave the remote in an extremely hot or humid place.
- Do not use a new battery with old ones.
- Do not mix alkaline batteries and other kinds of batteries.
- Do not expose the remote sensor to direct sunlight or lighting apparatuses. Doing so may cause a malfunction.
- If you do not intend to use the remote for an extended period of time, remove the batteries to avoid possible damage from battery leakage and corrosion.
- When you replace the batteries, the remote buttons may be reset to their factory settings. If this happens, reassign the buttons again (page 74).

### Tip

Under normal conditions, the batteries should last for about 3 months. When the remote no longer operates the receiver, replace all the batteries with new ones.

## 6: Selecting the speaker system

You can select the front speakers you want to drive.

Be sure to use the buttons on the receiver for this operation.

SPEAKERS (OFF/A/B)

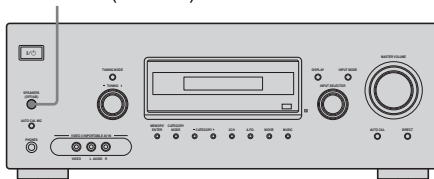

**Press SPEAKERS (OFF/A/B) repeatedly to select the front speaker system you want to drive.**

To select	Light up
The speakers connected to the SPEAKERS FRONT A terminals	SP A
The speakers connected to the SPEAKERS FRONT B terminals	SP B

To turn off the speaker output, press SPEAKERS (OFF/A/B) repeatedly until the “SP A” and “SP B” indicators on the display do not light up.

### Note

You cannot switch the front speaker system by pressing SPEAKERS (OFF/A/B) when the headphones are connected to the receiver.

# 7: Calibrating the appropriate settings automatically

## (AUTO CALIBRATION)

The DCAC (Digital Cinema Auto Calibration) function allows you to perform automatic calibration such as:

- Checking the connection between each speaker and the receiver.
- Adjusting the speaker level.
- Measuring the distance of each speaker from your listening position.

You can also adjust the speaker levels and balance manually. For details, see “8: Adjusting the speaker levels and balance (TEST TONE)” (page 31).

### Before you perform Auto Calibration

Before you perform Auto Calibration, install and connect the speakers (page 14, 15).

- The AUTO CAL MIC jack is used for the supplied optimizer microphone only. Do not connect other microphones to this jack. Doing so may damage the receiver and the microphone.
- During calibration, the sound that comes out of the speakers is very loud. Pay attention to the presence of children or to the effect on your neighborhood.
- Perform Auto Calibration in a quiet environment to avoid the effect of noise and to get a more accurate measurement.
- If there are any obstacles in the path between the optimizer microphone and the speakers, the calibration cannot be performed correctly. Remove any obstacles from the measurement area to avoid measurement error.

### Notes

- The Auto Calibration function does not work when headphones are connected.
- Make sure SPEAKERS (OFF/A/B) is not set to off.

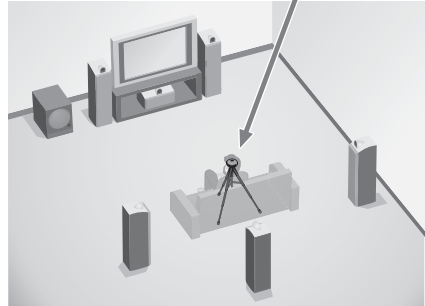
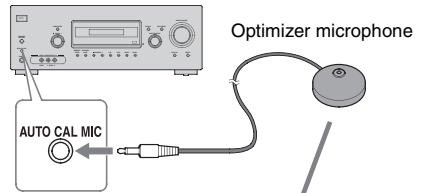

**1** Connect the supplied optimizer microphone to the AUTO CAL MIC jack.

**2** Set up the optimizer microphone.

Place the optimizer microphone at your listening position. You can also use a stool or tripod so that the optimizer microphone remains at the same height as your ears.

## Performing Auto Calibration

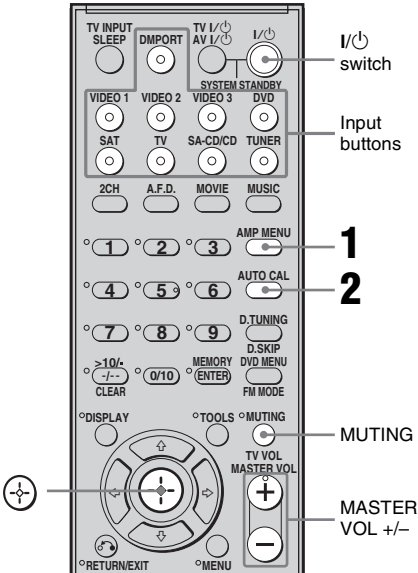

- 1 Press AMP MENU.**
- 2 Press AUTO CAL.**

Measurement starts in 5 seconds and the display changes as follows:  
 A.CAL [5] → A.CAL [4] → A.CAL [3]  
 → A.CAL [2] → A.CAL [1]  
 While the time is counting down, stand away from the measurement area to avoid measurement error.

### 3 Measurement starts.

The measurement process will take a few minutes to complete.  
 The table below shows the display when measurement starts.

#### Measurement for Display

Environment noise level	NOISE.CHK
Speaker connection	MEASURE and SP DET. appears alternately*
Speaker level	MEASURE and GAIN appears alternately*
Speaker distance	MEASURE and DISTANCE appears alternately*

\* The corresponding speaker indicator lights up in the display during measurement.

### 4 Measurement ends.

“COMPLETE” appears on the display and the settings are registered.

### 5 Disconnect the optimizer microphone from the AUTO CAL MIC jack.

#### Note

Auto Calibration cannot detect the sub woofer. Therefore, all sub woofer settings will be maintained.

#### Tip

During the measurement process, Auto Calibration is canceled when you do the following.

- Press I/O, input buttons or MUTING.
- Change the volume level.
- Press AUTO CAL again.

## Error and warning codes

### When error codes appear

When an error is detected during Auto Calibration, an error code will appear on the display cyclically after each measurement process as follows:

Error code → blank display → (error code → blank display)<sup>a)</sup> → PUSH → blank display → ENTER

<sup>a)</sup> Appears when there are more than one error code.

### To rectify the error

- 1 Record down the error code.
- 2 Press ⊕.
- 3 Press I/⏻ to turn off the receiver.  
For details, see “Error codes and remedies” below.
- 4 Rectify the error.
- 5 Turn on the receiver and perform Auto Calibration again (page 29).

### Error codes and remedies

Error code	Cause and remedy
ERROR 10	The environment is too noisy. Make sure the environment is quiet during Auto Calibration.
ERROR 11	The speakers are placed too near the optimizer microphone. Place your speakers further away from the optimizer microphone.
ERROR 12	None of the speakers are detected. Make sure that the optimizer microphone is connected properly and perform Auto Calibration again.
ERROR 20	Front speakers are not detected or only one front speaker is detected. Check the front speaker connection.
ERROR 21	Only one surround speaker is detected. Check the surround speaker connection.

Error code	Cause and remedy
ERROR 23	Surround back speaker is detected but surround speakers are not connected. Be sure to connect the surround speakers.

### When warning codes appear

During Auto Calibration, the warning code provides information on the measurement result. The warning code will appear on the display cyclically as follows:

Warning code → blank display → (warning code → blank display)<sup>b)</sup> → PUSH → blank display → ENTER

<sup>b)</sup> Appears when there are more than one warning code.

You can choose to ignore the warning code as the Auto Calibration function will automatically adjust the settings. You can also change the settings manually.

### To change the settings manually

- 1 Record down the warning code.
- 2 Press ⊕.
- 3 Press I/⏻ to turn off the receiver.
- 4 Follow the solution provided in the “Warning codes and solutions” below.
- 5 Turn on the receiver and perform Auto Calibration again (page 29).



## **5 Press $\uparrow/\downarrow$ repeatedly to select “T. TONE Y”.**

The test tone is output from each speaker in sequence as follows:

Front left → Center → Front right →  
Surround right → Surround back →  
Surround left → Sub woofer

## **6 Adjust the speaker levels and balance using the LEVEL menu so that the level of the test tone sounds the same from each speaker.**

For details, see “Adjusting the level (LEVEL menu)” (page 40).

### **Tips**

- To adjust the level of all speakers at the same time, press MASTER VOL +/- . You can also use MASTER VOLUME on the receiver.
- The adjusted value is shown on the display during adjustment.

## **7 Repeat steps 1 to 5 to select “T. TONE N”.**

You can also press any input buttons.  
The test tone turns off.

## **When a test tone is not output from the speakers**

- The speaker cords may not be connected securely.
- The speaker cords may have the short-circuit problem.

### **Note**

The test tone does not work when ANALOG DIRECT is selected.



## Selecting a component

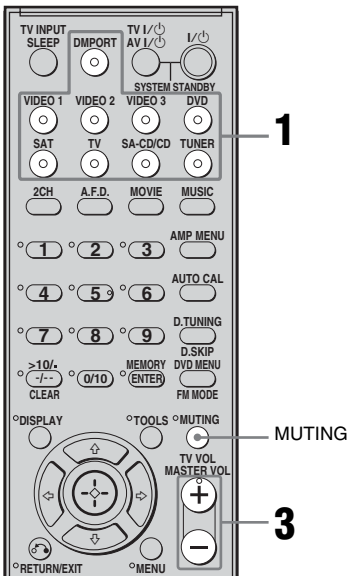

### 1 Press the input button to select a component.

You can also use INPUT SELECTOR on the receiver.

The selected input appears on the display.

Selected input [Display]	Components that can be played back
DMPORT [DMPORT]	DIGITAL MEDIA PORT adapter connected to the DMPORT jack
VIDEO 1 [VIDEO 1]	VCR, etc., connected to the VIDEO 1 jack
VIDEO 2 [VIDEO 2/BD]*	Blu-ray disc player, etc., connected to the VIDEO 2/BD jack
VIDEO 3 [VIDEO 3/PORTABLE AV]*	Camcorder, video game, etc., connected to the VIDEO 3 IN/PORTABLE AV IN jack
DVD [DVD]	DVD player, etc., connected to DVD jack

Selected input [Display]	Components that can be played back
SAT [SAT]	Satellite tuner, etc. connected to the SAT jack
TV [TV]	TV, etc. connected to the TV jack
SA-CD/CD [SA-CD/CD]	Super Audio CD/CD player, etc., connected to the SA-CD/CD jack
TUNER [FM or AM band]	Built-in radio tuner
TUNER [XM RADIO]	For details, see page 60.

\* "VIDEO 2/BD" and "VIDEO 3/PORTABLE AV" scroll across the display, then "VIDEO 2" and "VIDEO 3" appear respectively.

### 2 Turn on the component and start playback.

### 3 Press MASTER VOL +/- to adjust the volume.

You can also use MASTER VOLUME on the receiver.

### To activate the muting function

Press MUTING.

The muting function will be canceled when you do the following.

- Press MUTING again.
- Increase the volume.
- Turn off the receiver.

### To avoid damaging your speakers

Before you turn off the receiver, be sure to turn down the volume level.

# Listening/Watching a component

## Listening to a Super Audio CD/CD

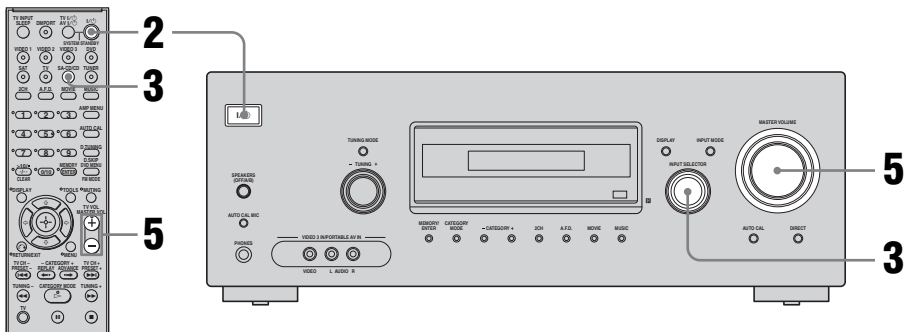

### Notes

- The operation is described for a Sony Super Audio CD player.
- Refer to the operating instructions supplied with the Super Audio CD player or CD player.

### Tip

You can select the sound field to suit the music. Refer to page 51 for details.

Recommended sound fields:

Classical: HALL

Jazz: JAZZ

Live concert: CONCERT

**1** Turn on the Super Audio CD player/CD player, then place the disc on the tray.

**2** Turn on the receiver.

**3** Press SA-CD/CD.

You can also use INPUT SELECTOR on the receiver to select "SA-CD/CD".

**4** Play back the disc.

**5** Adjust to a suitable volume.

**6** After you have finished listening to the Super Audio CD/CD, eject the disc and turn off the receiver and Super Audio CD player/CD player.

## Watching a DVD

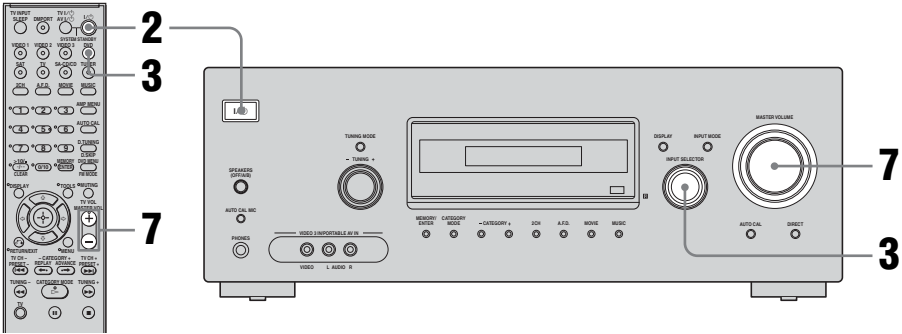

### Notes

- Refer to the operating instructions supplied with the TV and DVD player.
- Check the following if you cannot listen to multi channel sound.
  - Be sure this receiver is connected to the DVD player via a digital connection.
  - Be sure the digital audio output of the DVD player is set up properly.

### Tips

- Select the sound format of the disc to be played, if necessary.
- You can select the sound field to suit the movie/music. Refer to page 51 for details.  
Recommended sound fields:  
Movie: C.ST.EX  
Music: CONCERT

**1** Turn on the TV and DVD player.

**2** Turn on the receiver.

**3** Press DVD.

You can also use INPUT SELECTOR on this receiver to select “DVD”.

**4** Switch the input of the TV so that an image of the DVD is displayed.

**5** Set up the DVD player.

Refer to “Quick Setup Guide” supplied with the receiver.

**6** Play back the disc.

**7** Adjust to a suitable volume.

**8** After you have finished watching the DVD, eject the disc and turn off the receiver, TV and DVD player.

## Amplifier Operations

### Navigating through menus

By using the amplifier menus, you can make various adjustments to customize the receiver.

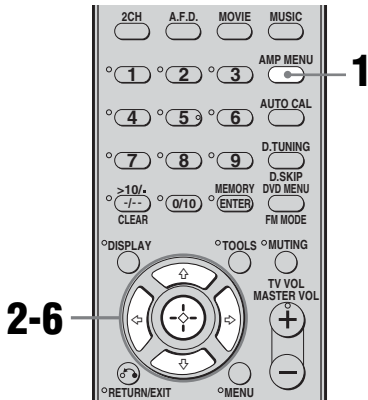

#### To return to the previous display

Press ←.

#### To exit the menu

Press AMP MENU.

#### Note

Some parameters and settings may appear dimmed on the display. This means that they are either unavailable or fixed and unchangeable.

- 1 Press AMP MENU.**  
“1-LEVEL” appears on the display.
- 2 Press ↑/↓ repeatedly to select the menu you want.**
- 3 Press ⊕ or → to enter the menu.**
- 4 Press ↑/↓ repeatedly to select the parameter you want to adjust.**
- 5 Press ⊕ or → to enter the parameter.**
- 6 Press ↑/↓ repeatedly to select the setting you want.**  
The setting is entered automatically.

## Overview of the menus

The following options are available in each menu. For details on navigating through menus, see page 36.

Menu [Display]	Parameters [Display]	Settings	Initial setting
LEVEL [1-LEVEL] (page 40)	Test tone <sup>a)</sup> [T. TONE]	T. TONE Y, T. TONE N	T. TONE N
	Front speaker balance <sup>a)</sup> [FRT BAL]	BAL. L +1 to BAL. L +8, BALANCE, BAL. R +1 to BAL. R +8	BALANCE
	Center speaker level [CNT LVL]	CNT -10 dB to CNT +10 dB (1 dB step)	CNT 0 dB
	Surround left speaker level [SL LVL]	SUR L -10 dB to SUR L +10 dB (1 dB step)	SUR L 0 dB
	Surround right speaker level [SR LVL]	SUR R -10 dB to SUR R +10 dB (1 dB step)	SUR R 0 dB
	Surround back speaker level [SB LVL]	SB -10 dB to SB +10 dB (1 dB step)	SB 0 dB
	Sub woofer level [SW LVL]	SW -10 dB to SW +10 dB (1 dB step)	SW 0 dB
	Dynamic range compressor <sup>a)</sup> [D. RANGE]	COMP. OFF, COMP. STD, COMP. MAX	COMP. OFF
EQ [2-EQ] (page 41)	Equalizer <sup>a)</sup> [EQ]	EQ ON, EQ OFF	EQ OFF
	Front speaker bass level [BASS LVL]	BASS -6 dB to BASS +6 dB (1 dB step)	BASS 0 dB
	Front speaker treble level [TRE LVL]	TRE -6 dB to TRE +6 dB (1 dB step)	TRE 0 dB
SUR [3-SUR] (page 41)	Sound field selection <sup>a)</sup> [S.F. SELCT]	2CH ST., A.F.D. AUTO, DOLBY PL, PLII MV, PLII MS, PLII GM, PLIIX MV, PLIIX MS, PLIIX GM, NEO6 CIN, NEO6 MUS, MULTI ST., C.ST.EX A, C.ST.EX B, C.ST.EX C, PORTABLE, HALL, JAZZ, CONCERT	2CH ST. for: TUNER, SA-CD/CD, TV, DMPORT; A.F.D. AUTO for: DVD, SAT, VIDEO 1, 2, 3
	Surround back decoding mode <sup>a)</sup> [SB DEC]	SB OFF, SB AUTO, SB ON	SB AUTO
	Effect level <sup>a)</sup> [EFFECT]	EFCT. MIN, EFCT. STD, EFCT. MAX	EFCT. STD
TUNER [4-TUNER] (page 43)	FM station receiving mode <sup>a)</sup> [FM MODE]	FM AUTO, FM MONO	FM AUTO
	Naming preset stations <sup>a)</sup> [NAME IN]		

<b>Menu [Display]</b>	<b>Parameters [Display]</b>	<b>Settings</b>	<b>Initial setting</b>
AUDIO [5-AUDIO] (page 43)	Digital audio input decoding priority <sup>a)</sup> [DEC. PRI.]	DEC. AUTO, DEC. PCM	DEC. AUTO for: SAT, DVD, TV, VIDEO 1, 2, 3; DEC. PCM for: SA-CD/CD
	Digital broadcast language selection <sup>a)</sup> [DUAL]	DUAL M/S, DUAL M, DUAL S, DUAL M+S	DUAL M
	Synchronizes audio and video output <sup>a)</sup> [A.V. SYNC.]	A.V.SYNC. Y, A.V.SYNC. N	A.V.SYNC. N
	Digital audio input assignment <sup>a)</sup> [D. ASSIGN]	VD1- VD1, VD1- VD2, VD1- VD3, VD1- DVD, VD1- TV, VD1- CD, DVD- VD1, DVD- VD2, DVD- VD3, DVD- DVD, DVD- SAT, DVD- TV, DVD- CD, SAT- VD2, SAT- VD3, SAT- DVD, SAT- SAT, SAT- TV, SAT- CD	VD1- VD1 for: VIDEO 1; DVD- DVD for: DVD; SAT- SAT for: SAT
	Naming inputs <sup>a)</sup> [NAME IN]		
VIDEO [6-VIDEO] (page 44)	DIGITAL MEDIA PORT video input assignment <sup>a)</sup> [DMPort V.]	-NONE, -VIDEO 1, -VIDEO 3, -DVD, -SAT	-NONE
	HDMI AUDIO <sup>a)</sup> [AUDIO]	AMP, TV+AMP	AMP
	HDMI CONTROL <sup>a)</sup> [CONTROL]	CTRL ON, CTRL OFF	CTRL OFF
	Naming inputs <sup>a)</sup> [NAME IN]		

<b>Menu [Display]</b>	<b>Parameters [Display]</b>	<b>Settings</b>	<b>Initial setting</b>
SYSTEM [7-SYSTEM] (page 45)	Sub woofer <sup>a)</sup> [SW SPK]	YES, NO	YES
	Front speakers <sup>a)</sup> [FRT SPK]	LARGE, SMALL	LARGE
	Center speaker <sup>a)</sup> [CNT SPK]	LARGE, SMALL, NO	LARGE
	Surround speakers <sup>a)</sup> [SUR SPK]	LARGE, SMALL, NO	LARGE
	Surround back speaker <sup>a)</sup> [SB SPK]	YES, NO	YES
	Front speaker distance <sup>a)</sup> [FRT DIST.]	DIST. 3 ft. to DIST. 23 ft. (1 ft. step)	DIST. 10 ft.
	Center speaker distance <sup>a)</sup> [CNT DIST.]	DIST. ■■ ft. between front speaker distance and 5 ft. (1 ft. step)	DIST. 10 ft.
	Surround left speaker distance <sup>a)</sup> [SL DIST.]	DIST. ■■ ft. between front speaker distance and 15 ft. (1 ft. step)	DIST. 10 ft.
	Surround right speaker distance <sup>a)</sup> [SR DIST.]	DIST. ■■ ft. between front speaker distance and 15 ft. (1 ft. step)	DIST. 10 ft.
	Surround back speaker distance <sup>a)</sup> [SB DIST.]	DIST. ■■ ft. between front speaker distance and 15 ft. (1 ft. step)	DIST. 10 ft.
	Surround speaker position <sup>a)</sup> [SUR POS.]	SIDE/LO, SIDE/HI, BEHD/LO, BEHD/HI	SIDE/LO
	Speaker crossover frequency <sup>a)</sup> [CRS. FREQ]	CRS > 40 Hz to CRS > 160 Hz	CRS > 100 Hz
	Brightness of the display <sup>a)</sup> [DIMMER]	0% dim, 40% dim, 70% dim	0% dim
A. CAL [8-A. CAL] (page 49)	Auto Calibration <sup>a)</sup> [AUTO CAL]	A.CAL YES, A.CAL NO	A.CAL NO

<sup>a)</sup>For details, refer to the page in the parentheses.

# Adjusting the level

## (LEVEL menu)

You can use the LEVEL menu to adjust the balance and level of each speaker. These settings are applied to all sound fields. Select “1-LEVEL” in the amplifier menus. For details on adjusting the parameters, see “Navigating through menus” (page 36) and “Overview of the menus” (page 37).

## LEVEL menu parameters

### ■ T. TONE (Test tone)

Lets you adjust the speaker levels and balance while listening to the test tone from your listening position. For details, see “8: Adjusting the speaker levels and balance (TEST TONE)” (page 31).

### ■ FRT BAL (Front speaker balance)

Lets you adjust the balance between front left and right speakers.

### ■ CNT LVL (Center speaker level)

### ■ SL LVL (Surround left speaker level)

### ■ SR LVL (Surround right speaker level)

### ■ SB LVL (Surround back speaker level)

### ■ SW LVL (Sub woofer level)

### ■ D. RANGE (Dynamic range compressor)

Lets you compress the dynamic range of the sound track. This may be useful when you want to watch movies at low volumes late at night. Dynamic range compression is possible with Dolby Digital sources only.

- COMP. OFF

The dynamic range is not compressed.

- COMP. STD

The dynamic range is compressed as intended by the recording engineer.

- COMP. MAX

The dynamic range is compressed dramatically.

### Tip

Dynamic range compressor lets you compress the dynamic range of the soundtrack based on the dynamic range information included in the Dolby Digital signal.

“COMP. STD” is the standard setting, but it only enacts light compression. Therefore, we recommend using the “COMP. MAX” setting. This greatly compresses the dynamic range and lets you view movies late at night at low volumes. Unlike analog limiters, the levels are predetermined and provide a very natural compression.



## Adjusting the equalizer (EQ menu)

You can use the EQ menu to adjust the tonal quality (bass/treble level) of the front speakers.

Select “2-EQ” in the amplifier menus. For details on adjusting the parameters, see “Navigating through menus” (page 36) and “Overview of the menus” (page 37).

### EQ menu parameters

#### ■ EQ (Equalizer)

Lets you turn the equalizer on or off.

- EQ ON  
The equalizer is turned on.
- EQ OFF  
The equalizer is turned off.

#### ■ BASS LVL (Front speaker bass level)

#### ■ TRE LVL (Front speaker treble level)

## Settings for the surround sound (SUR menu)

You can use the SUR menu to select the sound field you want for your listening pleasure.

Select “3-SUR” in the amplifier menus. For details on adjusting the parameters, see “Navigating through menus” (page 36) and “Overview of the menus” (page 37).

### SUR menu parameters

#### ■ S.F. SELCT (Sound field selection)

Lets you select the sound field you want. For details, see “Enjoying Surround Sound” (page 49).

#### Note

The receiver lets you apply the last selected sound field to an input whenever it is selected (Sound Field Link). For example, if you select “HALL” for the SA-CD/CD input, then change to a different input and then return to SA-CD/CD, “HALL” will automatically be applied again.

#### ■ SB DEC (Surround back decoding mode)

Lets you select the surround back decoding mode. For details, see “Using the surround back decoding mode (SB DEC)” (page 42).

#### ■ EFFECT (Effect level)

Lets you adjust the “presence” of the surround effect for sound fields selected with the MOVIE or MUSIC buttons (except “PORTABLE” sound field) and for “HP THEA” sound field.

- EFCT. MIN  
The surround effect is minimum.
- EFCT. STD  
The surround effect is standard.
- EFCT. MAX  
The surround effect is maximum.

## Using the surround back decoding mode (SB DEC)

By decoding the surround back signal of DVD software (etc.) recorded in Dolby Digital Surround EX, DTS-ES Matrix, DTS-ES Discrete 6.1, etc., format, you can enjoy the surround sound intended by the filmmakers. Select the surround back decoding mode using “SB DEC” on the SUR menu (page 41).

## Types of the surround back decoding functions

### ■ SB AUTO

When the input stream contains the 6.1 channel decode flag<sup>a)</sup>, the appropriate decoding is performed on the surround back signal.

Input stream	Output channel	Surround back decoding
Dolby Digital 5.1	5.1	—
Dolby Digital Surround EX <sup>b)</sup>	6.1	Matrix decoder that conforms to Dolby Digital EX
DTS 5.1	5.1	—
DTS-ES Matrix 6.1 <sup>c)</sup>	6.1	DTS Matrix decoding
DTS-ES Discrete 6.1 <sup>d)</sup>	6.1	DTS Discrete decoding

### ■ SB ON

To decode the surround back signal regardless of the 6.1 channel decode flag<sup>a)</sup>, Dolby Digital EX is applied when the output channel is 6.1.

Input stream	Output channel	Surround back decoding
Dolby Digital 5.1	6.1	Matrix decoder that conforms to Dolby Digital EX
Dolby Digital Surround EX <sup>b)</sup>	6.1	Matrix decoder that conforms to Dolby Digital EX
DTS 5.1	6.1	Matrix decoder that conforms to Dolby Digital EX
DTS-ES Matrix 6.1 <sup>c)</sup>	6.1	Matrix decoder that conforms to Dolby Digital EX
DTS-ES Discrete 6.1 <sup>d)</sup>	6.1	Matrix decoder that conforms to Dolby Digital EX

### ■ SB OFF

Surround back decoding is not performed.

<sup>a)</sup> A 6.1 channel decode flag is information recorded in software such as DVDs.

<sup>b)</sup> A Dolby Digital DVD that includes a Surround EX flag. The Dolby Corporation web page can help you distinguish Surround EX films.

<sup>c)</sup> Software encoded with a flag to denote it has both DTS-ES Matrix and 5.1 channel signals.

<sup>d)</sup> Software encoded with both 5.1 channel signals and an extension stream designed for returning those signals to 6.1 discrete channels. Discrete 6.1 channel signals are DVD specific signals not used in movie theaters.

## Notes

- There may be no sound from the surround back speaker in Dolby Digital EX mode. Some discs have no Dolby Digital Surround EX flag even though the packages have Dolby Digital EX logos. In this case, select “SB ON”.
- You can select the surround back decoding mode only when A.F.D. mode is selected. However, this function is canceled when Dolby Pro Logic IIx is selected.

## Settings for the tuner

### (TUNER menu)

You can use the TUNER menu to set the FM station receiving mode and to name preset stations.

Select “4-TUNER” in the amplifier menus. For details on adjusting the parameters, see “Navigating through menus” (page 36) and “Overview of the menus” (page 37).

### TUNER menu parameters

#### ■ FM MODE (FM station receiving mode)

- FM AUTO  
This receiver will decode the signal as stereo signal when the radio station is broadcast in stereo.
- FM MONO  
This receiver will decode the signal as mono signal regardless of the broadcast signal.

#### ■ NAME IN (Naming preset stations)

Lets you set the name of preset stations. For details, see “Naming preset stations” (page 59).

## Settings for the audio

### (AUDIO menu)

You can use the AUDIO menu to make settings for the audio to suit your preference. Select “5-AUDIO” in the amplifier menus. For details on adjusting the parameters, see “Navigating through menus” (page 36) and “Overview of the menus” (page 37).

### AUDIO menu parameters

#### ■ DEC. PRI. (Digital audio input decoding priority)

Lets you specify the input mode for the digital signal input to the DIGITAL IN and HDMI IN jacks.

- DEC. AUTO  
Automatically switches the input mode between DTS, Dolby Digital, or PCM.
- DEC. PCM  
When signals from the DIGITAL IN jack are selected, PCM signals are given priority (to prevent interruption when playback starts). However, when other signals are input, there may be no sound, depending on the format. In this case, set this item to “DEC. AUTO”. When signals from the HDMI IN jack are selected, only PCM signals are output from the connected player. When signals in any other format are received, set this item to “DEC. AUTO”.

#### Note

When set to “DEC. AUTO” and the sound from the digital audio jacks (for a CD, etc.) is interrupted when playback starts, set to “DEC. PCM”.

## ■ DUAL (Digital broadcast language selection)

Lets you select the language you want to listen to during digital broadcast. This feature only functions for Dolby Digital sources.

- DUAL M/S (Main/Sub)  
Sound of the main language will be output through the front left speaker and sound of the sub language will be output through the front right speaker simultaneously.
- DUAL M (Main)  
Sound of the main language will be output.
- DUAL S (Sub)  
Sound of the sub language will be output.
- DUAL M+S (Main + Sub)  
Mixed sound of both the main and sub languages will be output.

## ■ A.V. SYNC. (Synchronizes audio and video output)

- A.V.SYNC. Y (Yes) (Delay time: 68 ms)  
The audio output is delayed so that the time gap between the audio output and visual display is minimized.
- A.V.SYNC. N (No) (Delay time: 0 ms)  
The audio output is not delayed.

### Notes

- This parameter is useful when you use a large LCD or plasma TV or a projector.
- This parameter is valid only when you use a sound field selected with the 2CH or A.F.D. buttons.
- This parameter is not valid when
  - PCM 96 kHz, DTS 96/24 or DTS 2048 signals are input.
  - the receiver is performing DTS-ES Matrix 6.1 decoding.
  - ANALOG DIRECT function is selected.

## ■ D. ASSIGN (Digital audio input assignment)

Lets you assign the digital audio input to other input source. For details, see “Listening to digital sound from other inputs (DIGITAL ASSIGN)” (page 71).

## ■ NAME IN (Naming inputs)

Lets you set the name of inputs. For details, see “Naming inputs” (page 72).

## Settings for the video (VIDEO menu)

You can use the VIDEO menu to assign the composite video input to DMPORT input and to name inputs.

Select “6-VIDEO” in the amplifier menus. For details on adjusting the parameters, see “Navigating through menus” (page 36) and “Overview of the menus” (page 37).

### VIDEO menu parameters

#### ■ DMPORT V. (DIGITAL MEDIA PORT video assignment)

Lets you assign the composite video input to DMPORT input so that you can view the images on the TV screen. For details, see “Watching a connected component through DMPORT connection” (page 70).

#### ■ AUDIO (HDMI AUDIO)

Lets you set the HDMI audio output from the playback component connected to the receiver via a HDMI connection.

##### • AMP

The HDMI audio signals from the playback component is only output to speakers connected to the receiver. Multi-channel sound can be played back as it is.

##### Note

Audio signals are not output from the TV’s speakers.

- **TV+AMP**

The sound is output from TV's speaker and the speakers connected to the receiver.

### Notes

- The sound quality of the playback component depends on the TV's sound quality, such as the number of channels, and the sampling frequency, etc. When the TV has stereo speakers, the sound output from the receiver is also stereo as that of the TV, even if you play back multi-channel source.
- When you connect the receiver to a video component (projector, etc.), sound may not be output from the receiver. In this case, select "AMP".

### ■ CONTROL (HDMI CONTROL)

Lets you turn the HDMI CONTROL function on or off. For details, refer to the HDMI CONTROL Guide supplied with the receiver.

### ■ NAME IN (Naming inputs)

Lets you set the name of inputs. For details, see "Naming inputs" (page 72).

## Settings for the system (SYSTEM menu)

You can use the SYSTEM menu to set the size and distance of the speakers connected to this system.

Select "7-SYSTEM" in the amplifier menus. For details on adjusting the parameters, see "Navigating through menus" (page 36) and "Overview of the menus" (page 37).

### SYSTEM menu parameters

#### ■ SW SPK (Sub woofer)

- YES  
If you have connected a sub woofer, select "YES".
- NO  
If you have not connected a sub woofer, select "NO". This activates the bass redirection circuitry and outputs the LFE signals from other speakers.

#### Tip

In order to take full advantage of the Dolby Digital bass redirection circuitry, we recommend setting the sub woofer's cut off frequency as high as possible.

#### ■ FRT SPK (Front speakers)

- LARGE  
If you connect large speakers that will effectively reproduce bass frequencies, select "LARGE". Normally, select "LARGE". When the sub woofer is set to "NO", the front speakers are automatically set to "LARGE".
- SMALL  
If the sound is distorted, or you feel a lack of surround effects when using multi channel surround sound, select "SMALL" to activate the bass redirection circuitry and output the front channel bass frequencies from the sub woofer. When the front speakers are set to "SMALL", the center and surround speakers are also automatically set to "SMALL" (unless previously set to "NO").

*continued*

## ■ CNT SPK (Center speaker)

- LARGE

If you connect a large speaker that will effectively reproduce bass frequencies, select “LARGE”. Normally, select “LARGE”. However, if the front speakers are set to “SMALL”, you cannot set the center speaker to “LARGE”.

- SMALL

If the sound is distorted, or you feel a lack of surround effects when using multi channel surround sound, select “SMALL” to activate the bass redirection circuitry and output the center channel bass frequencies from the front speakers (if set to “LARGE”) or sub woofer.

- NO

If you have not connected a center speaker, select “NO”. The sound of the center channel will be output from the front speakers.

## ■ SUR SPK (Surround speakers)

The surround back speaker will be set to the same setting.

- LARGE

If you connect large speakers that will effectively reproduce bass frequencies, select “LARGE”. Normally, select “LARGE”. However, if the front speakers are set to “SMALL”, you cannot set the surround speakers to “LARGE”.

- SMALL

If the sound is distorted, or you feel a lack of surround effects when using multi channel surround sound, select “SMALL” to activate the bass redirection circuitry and output the surround channel bass frequencies from the sub woofer or other “LARGE” speakers.

- NO

If you have not connected surround speakers, select “NO”.

## ■ SB SPK (Surround back speaker)

When the surround speakers are set to “NO”, the surround back speaker is also automatically set to “NO” and the setting cannot be changed.

- YES

If you have connected a surround back speaker, select “YES”.

- NO

If you have not connected a surround back speaker, select “NO”.

### Tip

The “LARGE” and “SMALL” settings for each speaker determine whether the internal sound processor will cut the bass signal from that channel. When the bass is cut from a channel, the bass redirection circuitry sends the corresponding bass frequencies to the sub woofer or other “LARGE” speakers.

However, since bass sounds have a certain amount of directionality, it is best not to cut them, if possible. Therefore, even when using small speakers, you can set them to “LARGE” if you want to output the bass frequencies from that speaker. On the other hand, if you are using a large speaker, but prefer not to have bass frequencies output from that speaker, set it to “SMALL”.

If the overall sound level is lower than you prefer, set all speakers to “LARGE”. If there is not enough bass, you can use the equalizer to boost the bass levels. For details, see page 37.

**■ FRT DIST. (Front speaker distance)**

Lets you set the distance from your listening position to the front speakers (A). If both front speakers are not placed an equal distance from your listening position, set the distance as the average distance between the front speakers.

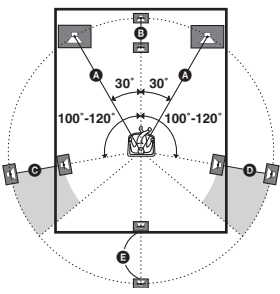

**■ CNT DIST. (Center speaker distance)**

Lets you set the distance from your listening position to the center speaker. Center speaker distance should be set from a distance equal to the front speaker distance (A) to a distance 5 feet closer to your listening position (B).

**■ SL DIST. (Surround left speaker distance)**

Lets you set the distance from your listening position to the surround left speaker. Surround left speaker distance should be set from a distance equal to the front speaker distance (A) to a distance 15 feet closer to your listening position (C).

**■ SR DIST. (Surround right speaker distance)**

Lets you set the distance from your listening position to the surround right speaker. Surround right speaker distance should be set from a distance equal to the front speaker distance (A) to a distance 15 feet closer to your listening position (D).

**■ SB DIST. (Surround back speaker distance)**

Lets you set the distance from your listening position to the surround back speaker. Surround back speaker distance should be set from a distance equal to the front speaker distance (A) to a distance 15 feet closer to your listening position (E).

**Tip**

The receiver lets you to input the speaker position in terms of distance. However, it is not possible to set the center speaker further than the front speakers. Also, the center speaker cannot be set more than 5 feet closer from the front speakers. Likewise, the surround and surround back speakers can not be set further away from the listening position than the front speakers. And they can be no more than 15 feet closer. This is because incorrect speaker placement is not conducive to the enjoyment of surround sound.

Please note that, setting the speaker distance closer than the actual location of the speakers will cause a delay in the output of the sound from that speaker. In other words, the speaker will sound like it is further away.

For example, setting the center speaker distance 3-6 feet closer than the actual speaker position will create a fairly realistic sensation of being “inside” the screen. If you cannot obtain a satisfactory surround effect because the surround speakers are too close, setting the surround speaker distance closer (shorter) than the actual distance will create a larger sound stage.

Adjusting these parameter while listening to the sound often results in much better surround sound. Give it a try!

## ■ SUR POS. (Surround speaker position)

Lets you specify the location of your surround speakers for proper implementation of the surround effects in the Cinema Studio EX modes (page 52). This setup item is not available when the surround speakers are set to “NO” (page 39).

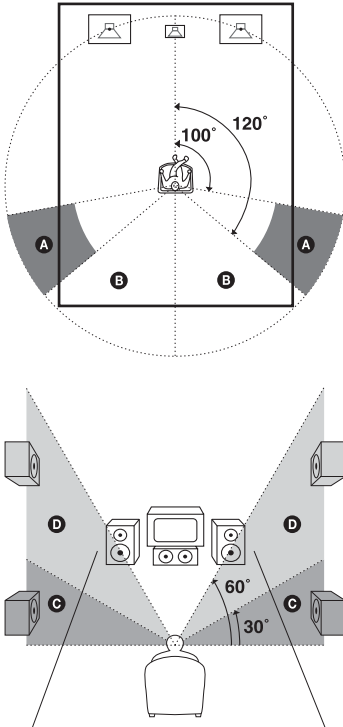

- **SIDE/LO**  
Select if the location of your surround speakers corresponds to sections **A** and **C**.
- **SIDE/HI**  
Select if the location of your surround speakers corresponds to sections **A** and **D**.
- **BEHD/LO**  
Select if the location of your surround speakers corresponds to sections **B** and **C**.
- **BEHD/HI**  
Select if the location of your surround speakers corresponds to sections **B** and **D**.

## Tip

Surround speaker position is designed specifically for implementation of the Cinema Studio EX modes. For other sound fields, speaker position is not so critical.

Those sound fields were designed under the premise that the surround speakers would be located behind the listening position, but presentation remains fairly consistent even with the surround speakers positioned at a rather wide angle. However, if the speakers are pointing toward the listener from the immediate left and right of the listening position, the surround effects become unclear unless set to “SIDE/LO” or “SIDE/HI”.

Nevertheless, each listening environment has many variables, such as wall reflections, and you may obtain better results using “BEHD/HI” if your speakers are located high above the listening position, even if they are located to the immediate left and right.

Therefore, although it may result in a setting contrary to the above explanation, we recommend that you play back multi channel surround encoded software and select the setting that provides a good sense of spaciousness and that best succeeds in forming a cohesive space between the surround sound from the surround speakers and the sound of the front speakers. If you are not sure which sounds best, select “BEHD/LO” or “BEHD/HI” and then use the speaker distance parameter and speaker level adjustments to obtain proper balance.

## ■ CRS. FREQ (Speaker crossover frequency)

Lets you set the bass crossover frequency of the speakers that have been set to “SMALL” on the SYSTEM menu. This setup item is only available when at least one speaker is set to “SMALL” and the corresponding speaker indicator flashes on the display.

## ■ DIMMER (Brightness of the display)

Lets you adjust the brightness in 3 steps.



# Calibrating the appropriate settings automatically

## (A. CAL menu)

For details, see “7: Calibrating the appropriate settings automatically (AUTO CALIBRATION)” (page 28).

# Enjoying Surround Sound

## Enjoying Dolby Digital and DTS Surround sound (AUTO FORMAT DIRECT)

The Auto Format Direct (A.F.D.) mode allows you to listen to higher fidelity sound and select the decoding mode for listening to a 2 channel stereo sound as multi channel sound.

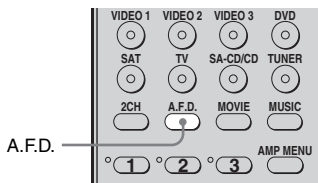

**Press A.F.D. repeatedly to select the sound field you want.**

For details, see “Types of A.F.D. mode” (page 50).

## Types of A.F.D. mode

<b>Decoding mode</b>	<b>A.F.D. mode [Display]</b>	<b>Multi channel audio after decoding</b>	<b>Effect</b>
(Detecting automatically)	A.F.D. AUTO [A.F.D. AUTO]	(Detecting automatically)	Presents the sound as it was recorded/ encoded without adding any surround effects. However, this receiver will generate a low frequency signal for output to the sub woofer when there is no LFE signals.
Dolby Pro Logic	PRO LOGIC [DOLBY PL]	4 channel	Performs Dolby Pro Logic decoding. The source recorded in 2 channel format is decoded into 4.1 channels.
Dolby Pro Logic II	PRO LOGIC II MOVIE [PLII MV]	5 channel	Performs Dolby Pro Logic II Movie mode decoding. This setting is ideal for movies encoded in Dolby Surround. In addition, this mode can reproduce sound in 5.1 channel for watching videos of overdubbed or old movies.
	PRO LOGIC II MUSIC [PLII MS]	5 channel	Performs Dolby Pro Logic II Music mode decoding. This setting is ideal for normal stereo sources such as CDs.
	PRO LOGIC II GAME [PLII GM]	5 channel	Performs Dolby Pro Logic II Game mode decoding. This setting is ideal for game softwares.
Dolby Pro Logic IIx*	PRO LOGIC IIx MOVIE [PLIIX MV]	6 channel	Performs Dolby Pro Logic IIx Movie mode decoding. This setting expands Dolby Pro Logic II Movie or Dolby Digital 5.1 to discrete 6.1 movie channels.
	PRO LOGIC IIx MUSIC [PLIIX MS]	6 channel	Performs Dolby Pro Logic IIx Music mode decoding. This setting is ideal for normal stereo sources such as CDs.
	PRO LOGIC IIx GAME [PLIIX GM]	6 channel	Performs Dolby Pro Logic IIx Game mode decoding.
Neo:6	Neo:6 Cinema [NEO6 CIN]	6 channel	Performs DTS Neo:6 Cinema mode decoding.
	Neo:6 Music [NEO6 MUS]	6 channel	Performs DTS Neo:6 Music mode decoding. This setting is ideal for normal stereo sources such as CDs.
(Multi Stereo)	MULTI STEREO [MULTI ST.]	(Multi Stereo)	Outputs 2 channel left/right signals from all speakers. However, sound may not be output from certain speakers depending on the speaker settings.

\* You cannot select this decoding mode if there is no surround back speaker connected to the receiver.

## If you connect a sub woofer

This receiver will generate a low frequency signal for output to the sub woofer when there is no LFE signal, which is a low-pass sound effect output from a sub woofer to a 2 channel signal. However, the low frequency signal is not generated for “NEO6 CIN” or “NEO6 MUS” when all speakers are set to “LARGE”.

### Notes

- This function does not work when ANALOG DIRECT is selected.
- DTS Neo:6 does not work for DTS 2CH audio, the sound is played back as 2 channel.
- Dolby Pro Logic IIx decoding does not function for DTS format signals or for signals with a sampling frequency of more than 48 kHz.

### Tip

When a multi channel signal is input, only Dolby Pro Logic IIx decoding is effective. When you select decoding modes other than Dolby Pro Logic IIx, multi channel sound (being encoded) is output.

## Selecting a pre-programmed sound field

You can take advantage of surround sound simply by selecting one of the receiver’s pre-programmed sound fields. They bring the exciting and powerful sound of movie theaters and concert halls into your home.

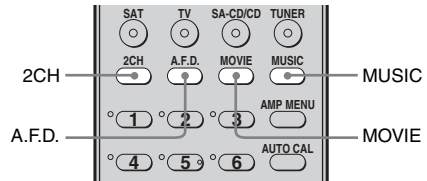

**Press MOVIE repeatedly to select a sound field for movies or press MUSIC repeatedly to select a sound field for music.**

For details, see “Types of sound field available” (page 52).

## Types of sound field available

Sound field for	Sound field [Display]	Effect
Movie	CINEMA STUDIO EX A <b>DCS</b> [C.ST.EX A]	Reproduces the sound characteristics of the Sony Pictures Entertainment "Cary Grant Theater" cinema production studio. This is a standard mode, great for watching almost any type of movie.
	CINEMA STUDIO EX B <b>DCS</b> [C.ST.EX B]	Reproduces the sound characteristics of the Sony Pictures Entertainment "Kim Novak Theater" cinema production studio. This mode is ideal for watching science-fiction or action movies with lots of sound effects.
	CINEMA STUDIO EX C <b>DCS</b> [C.ST.EX C]	Reproduces the sound characteristics of the Sony Pictures Entertainment scoring stage. This mode is ideal for watching musicals or films where orchestra music is featured in the soundtrack.
Music	PORTABLE AUDIO [PORTABLE]	Reproduces a clear enhanced sound image from your portable audio device. This mode is ideal for MP3 and other compressed music.
	HALL [HALL]	Reproduces the acoustics of a classical concert hall.
	JAZZ CLUB [JAZZ]	Reproduces the acoustics of a jazz club.
	LIVE CONCERT [CONCERT]	Reproduces the acoustics of a 300-seat live house.
Headphone*	HEADPHONE 2CH [HP 2CH]	This mode is selected automatically if you use headphones when 2 channel mode (page 54)/A.F.D. mode (page 50) is selected. Standard 2 channel stereo sources completely bypass the sound field processing and multi channel surround formats are downmixed to 2 channels.
	HEADPHONE DIRECT [HP DIR]	Outputs the analog signals without processing by the tone, sound field, etc.
	HEADPHONE THEATER <b>DCS</b> [HP THEA]	This mode is selected automatically if you use headphones when a sound field for movie/music is selected. It allows you to experience a theater-like environment while listening through a pair of headphones.

\* You can only select this sound field if the headphones are connected to the receiver.

## About DCS (Digital Cinema Sound)

Sound fields with **DCS** mark use DCS technology.

DCS is a unique sound reproduction technology for home theater developed by Sony, in cooperation with Sony Pictures Entertainment, for enjoying the exciting and powerful sound of movie theaters at home. With this “Digital Cinema Sound” developed by integrating a DSP (Digital signal processor) and measured data, the ideal sound field intended by film makers can be experienced at home.

## About CINEMA STUDIO EX modes

CINEMA STUDIO EX modes are suitable for watching motion picture DVDs (etc.), with multi channel surround effects. You can reproduce the sound characteristics of Sony Pictures Entertainment’s dubbing studio in your home.

The CINEMA STUDIO EX modes consist of the following three elements.

- Virtual Multi Dimension  
Creates 5 sets of virtual speakers from a single pair of actual surround speakers.
- Screen Depth Matching  
Creates the sensation that the sound is coming from inside the screen like in theaters.
- Cinema Studio Reverberation  
Reproduces the type of reverberation found in theaters.



The CINEMA STUDIO EX modes integrate these three elements simultaneously.

## Notes

- The effects provided by the virtual speakers may cause increased noise in the playback signal.
- When listening with sound fields that employ the virtual speakers, you will not be able to hear any sound coming directly from the surround speakers.
- This function does not work when:
  - ANALOG DIRECT is selected.
  - signals with a sampling frequency of more than 48 kHz is input.
- When one of the sound fields for music is selected, no sound is output from the sub woofer if all the speakers are set to “LARGE” on the SYSTEM menu. However, the sound will be output from the sub woofer if
  - the digital input signal contains LFE signals.
  - the front and surround speakers are set to “SMALL”.
  - the sound field for movie is selected.

## Tip

You can identify the encoding format of DVD software, etc., by looking at the logo on the package.

-  : Dolby Digital discs
-  : Dolby Surround encoded programs
-  : DTS Digital Surround encoded programs

## To turn off the surround effect for movie/music

Press 2CH to select “2CH ST.” or press A.F.D. repeatedly to select “A.F.D. AUTO”.

## Using only the front speakers (2CH STEREO)

In this mode, the receiver outputs the sound from the front left/right speakers only. There is no sound from the sub woofer. Standard 2 channel stereo sources completely bypass the sound field processing and multi channel surround formats are downmixed to 2 channel.

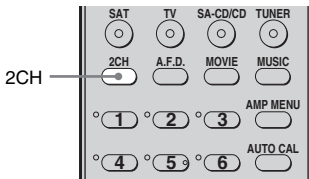

### Press 2CH.

#### Note

No sound is output from the sub woofer in the 2CH STEREO mode. To listen to 2 channel stereo sources using the front left/right speakers and a sub woofer, select "A.F.D. AUTO" (page 50).

## Listening to the sound without any adjustment (ANALOG DIRECT)

You can switch the audio of the selected input to two channel analog input. This function enables you to enjoy high quality analog sources.

When using this function, only the volume and front speaker balance can be adjusted.

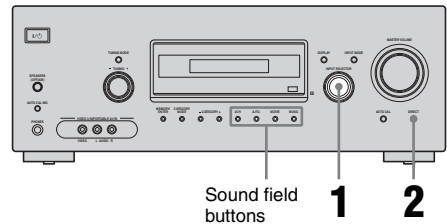

### 1 Turn INPUT SELECTOR on the receiver to select the input you want to listen to in analog audio.

You can also use the input buttons on the remote.

### 2 Press DIRECT on the receiver.

The analog audio is output.

## To cancel ANALOG DIRECT

Press DIRECT on the receiver again.

You can also press any sound field buttons.

#### Notes

- When headphones are connected, "HP DIR" appears on the display.
- This function is not available when DMPORT input is selected.

# Resetting sound fields to the initial settings

Be sure to use the buttons on the receiver for this operation.

**1,2**

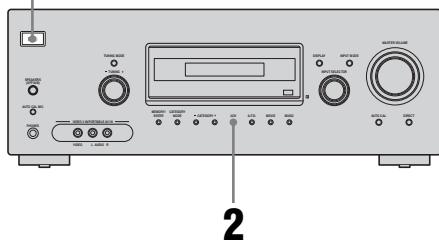

**1** Press I/⏻ to turn off the power.

**2** While holding down 2CH, press I/⏻.

“S.F. CLR.” appears on the display and all sound fields are reset to their initial setting.

## Tuner Operations

### Listening to FM/AM radio

You can listen to FM and AM broadcasts through the built-in tuner. Before operation, make sure you have connected the FM and AM antennas (aerials) to the receiver (page 25).

#### Tip

The tuning scale for direct tuning differs depending on the area code as shown in the following table. For details on area codes, see page 3.

Area code	FM	AM
U, CA	100 kHz	10 kHz*

\* The AM tuning scale can be changed (page 82).

## Automatic tuning

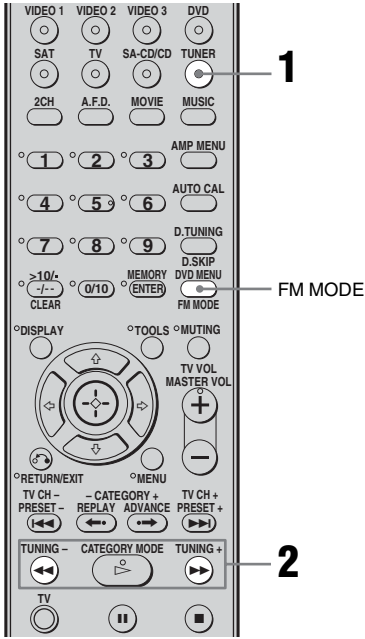

**1** Press TUNER repeatedly to select the FM or AM band.

**2** Press TUNING + or TUNING –.

Press TUNING + to scan from low to high; press TUNING – to scan from high to low.

The receiver stops scanning whenever a station is received.

## Using the controls on the receiver

**1** Turn INPUT SELECTOR to select the FM or AM band.

**2** Press TUNING MODE repeatedly to select “AUTO T.”.

**3** Turn TUNING +/-.

## In case of poor FM stereo reception

If the FM stereo reception is poor and “ST” flashes on the display, select monaural audio so that the sound will be less distorted.

Press FM MODE repeatedly until the “MONO” indicator lights up on the display.

To return to stereo mode, press FM MODE repeatedly until the “MONO” indicator on the display does not light up.

## Direct tuning

Enter the frequency of a station directly by using the numeric buttons.

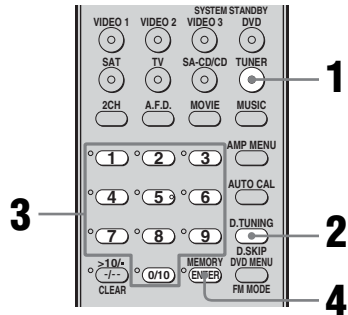

**1** Press TUNER repeatedly to select the FM or AM band.

You can also use INPUT SELECTOR on the receiver.

**2** Press D.TUNING.

**3** Press the numeric buttons to enter the frequency.

Example 1: FM 102.50 MHz

Select 1 → 0 → 2 → 5 → 0

Example 2: AM 1,350 kHz

Select 1 → 3 → 5 → 0

If you have tuned in an AM station, adjust the direction of the AM loop antenna (aerial) for optimum reception.

**4** Press ENTER.

You can also use MEMORY/ENTER on the receiver.



## If you cannot tune in a station

Make sure you have entered the right frequency. If not, repeat steps 2 to 4. If you still cannot tune in a station, the frequency is not used in your area.

## Presetting radio stations

You can preset up to 30 FM stations and 30 AM stations. Then you can easily tune in the stations you often listen to.

### Presetting radio stations

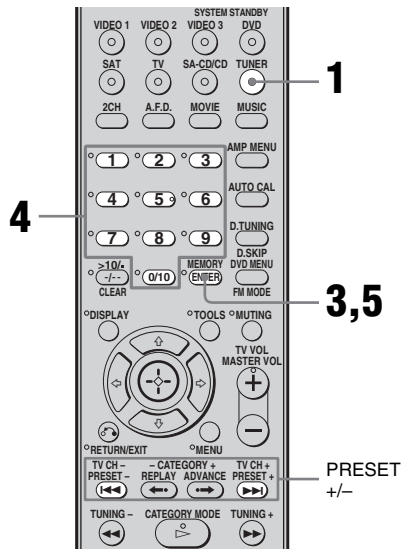

### 1 Press TUNER repeatedly to select the FM or AM band.

You can also use INPUT SELECTOR on the receiver.

### 2 Tune in the station that you want to preset using Automatic Tuning (page 56) or Direct Tuning (page 56).

Switch the FM reception mode, if necessary (page 56).

### 3 Press MEMORY.

You can also use MEMORY/ENTER on the receiver.

“MEMORY” lights up for a few seconds.

Perform steps 4 and 5 before

“MEMORY” goes out.

### 4 Press the numeric buttons to select a preset number.

You can also press PRESET + or

PRESET – to select a preset number.

If “MEMORY” goes out before you select the preset number, start again from step 3.

### 5 Press ENTER.

You can also use MEMORY/ENTER on the receiver.

The station is stored as the selected preset number.

If “MEMORY” goes out before you press ENTER, start again from step 3.

### 6 Repeat steps 1 to 5 to preset another station.

## Tuning to preset stations

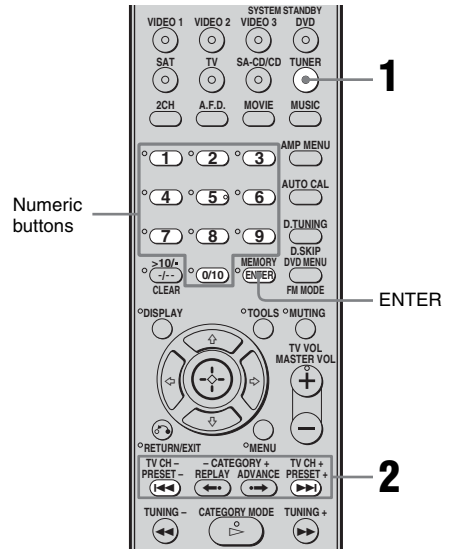

**1** Press TUNER repeatedly to select the FM or AM band.

**2** Press PRESET + or PRESET – repeatedly to select the preset station you want.

Each time you press the button, you can select a preset station as follows:

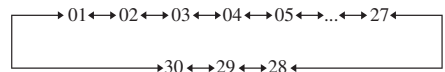

You can also press the numeric buttons to select the preset station you want. Then, press ENTER to enter the selection.

## Using the controls on the receiver

- 1 Turn INPUT SELECTOR to select the FM or AM band.
- 2 Press TUNING MODE repeatedly to select “PRESET T.”.
- 3 Turn TUNING +/- to select the preset station you want.

## Naming preset stations

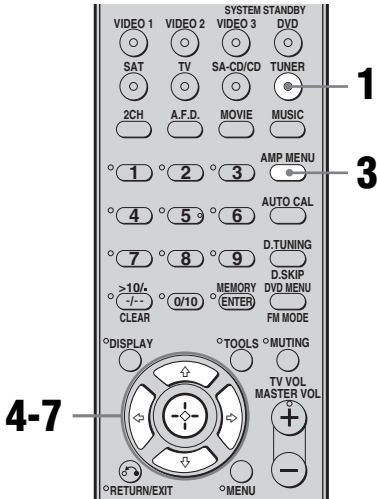

### 1 Press TUNER repeatedly to select the FM or AM band.

You can also use INPUT SELECTOR on the receiver.

### 2 Tune in the preset station you want to create an index name for (page 58).

### 3 Press AMP MENU.

“1-LEVEL” appears on the display.

### 4 Press $\uparrow/\downarrow$ repeatedly to select “4-TUNER”.

### 5 Press $\leftarrow$ or $\rightarrow$ to enter the menu.

### 6 Press $\uparrow/\downarrow$ repeatedly to select “NAME IN”.

### 7 Press $\leftarrow$ or $\rightarrow$ to enter the parameter.

The cursor flashes and you can select a character. Follow the procedure given in “To create an index name” below.

## To create an index name

### 1 Use $\uparrow/\downarrow/\leftarrow/\rightarrow$ to create an index name.

Press  $\uparrow/\downarrow$  to select a character, then press  $\leftarrow/\rightarrow$  to move the cursor to the next position.

### If you made a mistake

Press  $\leftarrow/\rightarrow$  until the character you want to change flashes, then press  $\uparrow/\downarrow$  to select the correct character.

### Tip

You can select the character type as follows by pressing  $\uparrow/\downarrow$ .

Alphabet (upper case)  $\rightarrow$  Numbers  $\rightarrow$  Symbols

### 2 Press $\leftarrow$ .

The entered name is registered.

# Listening to the XM Radio

## About XM Satellite Radio

XM Satellite Radio offers an extraordinary variety of commercial-free music, plus the best in sports, news, talk and entertainment. XM is broadcast in superior digital audio from coast to coast. From rock to reggae, from classical to hip hop, XM has something for every music fan. XM's dedication to playing the richest selection of music is matched by its passion for live sporting events, talk radio, up-to-the-minute news, stand-up comedy, children's programming, and much more. For U.S. customers, information about XM Satellite Radio is available online at [www.xmradio.com](http://www.xmradio.com). For Canadian customers, information about XM Canada is online at [www.xmradio.ca](http://www.xmradio.ca).

## XM Satellite Radio Terms and Conditions

Hardware and required monthly subscription sold separately. Other fees and taxes, including a one-time activation fee may apply. Subscription fee is consumer only. All fees and programming subject to change. Channels with frequent explicit language are indicated with an XL. Channel blocking is available for XM radio receivers by calling 1-800-XMRADIO (US residents) and 1-877-GET-XMSR (Canadian residents).

For a full listing of the XM commercial-free channels and advertising-supported channels, visit [lineup.xmradio.com](http://lineup.xmradio.com) (US residents) or [xmradio.ca](http://xmradio.ca) (Canadian residents).

Subscriptions subject to Customer Agreement available at [xmradio.com](http://xmradio.com) (US residents) and [xmradio.ca](http://xmradio.ca) (Canadian residents). Only available in the 48 contiguous United States and Canada.

©2006 XM Satellite Radio Inc. All rights reserved. All other trademarks are the property of their respective owners.

## To activate XM Satellite Radio

Once you have installed the XM Mini-Tuner Dock, inserted the XM Mini-Tuner, connected the XM Dock to your XM Ready® home audio system, and installed the antenna, you are ready to subscribe and begin receiving XM programming. There are three places to find your eight character XM Radio ID: on the XM Mini-Tuner, on the XM Mini-Tuner package, and on XM Channel 0. Record the Radio ID in the following eight squares for reference.

□□□□□□□□

### Note

The XM radio ID does not use the letters "I", "O", "S" or "F". Activate your XM Satellite Radio service in the U.S. online at <http://activate.xmradio.com> or call 1-800-XM-RADIO (1-800-967-2346). You will need a major credit card. XM will send a signal from the satellites to activate the full channel lineup. Activation normally takes 10 to 15 minutes, but during peak busy periods you may need to keep your XM Ready home audio system on for up to an hour. When you can access the full channel lineup on your XM Ready home audio system you are done. For more information or to subscribe in Canada, visit XM on the Web at [www.xmradio.ca](http://www.xmradio.ca) or call XM's Listener Care at 1-877-GET-XMSR (1-877-438-9677).

## Connecting the XM Radio

Before operating the system, connect the XM Connect-and-Play antenna to the XM jack.

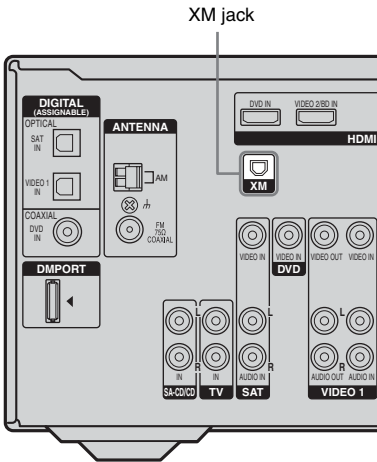

### Note

To ensure optimal reception of XM's satellite signal, move your antenna to various window locations around your home to see where the best reception will be received. Most XM customers place the antenna in a south-facing window with a clear view to the sky.

## Checking the XM Radio ID

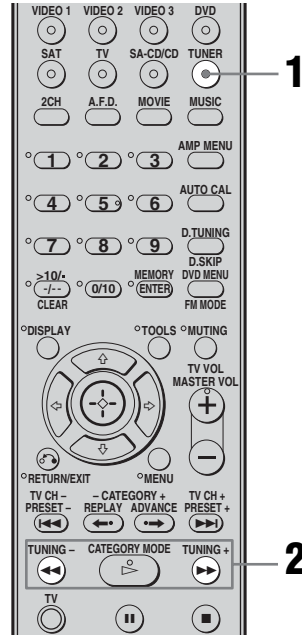

- 1 Press TUNER repeatedly to select “XM RADIO”.**  
 You can also use INPUT SELECTOR on the receiver.
- 2 Press TUNING + or TUNING – to select channel 0.**  
 You can also press TUNING MODE on the receiver to select “AUTO T.”, and then turn TUNING +/- to select channel 0.
- 3 Check the XM Radio ID on the display and write it in the space provided here.**

ID: \_\_\_\_\_

If you cannot read the characters or numbers on the display, refer to the following table.

*continued*

Display	Description
2	2 (two)
5	5 (five)
6	6 (six)
8	8 (eight)
0	0 (zero)
A	A
B	B
D	D
G	G
H	H
K	K
M	M
Q	Q
Z	Z

## Receiving XM Radio broadcasts

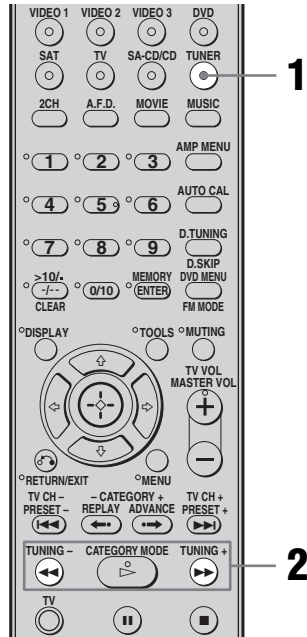

### 1 Press TUNER repeatedly to select “XM RADIO”.

You can also use INPUT SELECTOR on the receiver.

### 2 Press TUNING + or TUNING - to select a channel.

You can also press TUNING MODE on the receiver to select “AUTO T.”, and then turn TUNING +/- to select a channel.

## Selecting channels from a category (CATEGORY TUNING)

You can select a channel from one category or all the categories by changing the category mode.

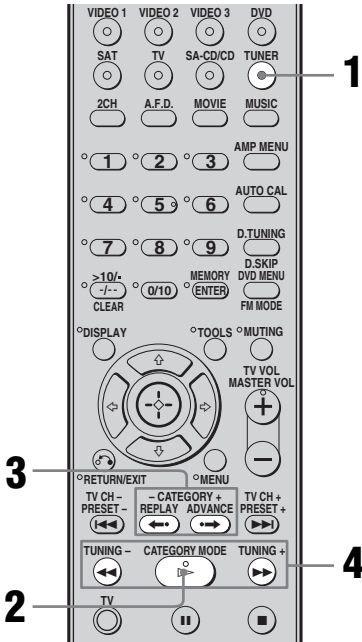

### 1 Press TUNER repeatedly to select "XM RADIO".

You can also use INPUT SELECTOR on the receiver.

### 2 Press CATEGORY MODE repeatedly to select the "ONE CAT".

- **ALL CAT**: You can select a channel from all the categories. The initial setting is "ALL CAT".
- **ONE CAT**: You can select a channel from one category. "CAT" is displayed on the display when you set to "ONE CAT" mode.

### 3 Press CATEGORY + or CATEGORY - to select the category you want.

The category is selected and the channel with the lowest number in the specified category is selected.

### 4 Press TUNING + or TUNING - to select the channel.

You can also press TUNING MODE on the receiver to select "AUTO T.", and then turn TUNING +/- to select the channel.

#### Notes

- When you select a channel in the "ONE CAT" mode, the channel you selected may not be the one in the category you want. This is because one channel may belong to more than one category.
- If you press CATEGORY + or CATEGORY - in the "ALL CAT" mode, the first channel of the next or previous category is selected (CATEGORY SKIP).

## Selecting channels by inputting the channel number directly (DIRECT TUNING)

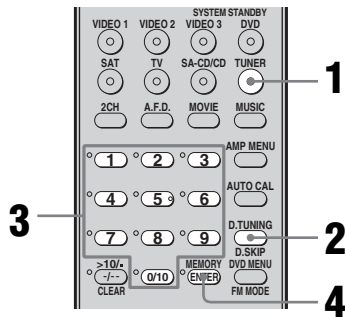

### 1 Press TUNER repeatedly to select "XM RADIO".

You can also use INPUT SELECTOR on the receiver.

### 2 Press D.TUNING.

**3** Press the numeric buttons to enter the channel number.

**4** Press ENTER.

You can also use MEMORY/ENTER on the receiver.

The selected channel is tune in.

## Displaying the XM-RADIO information on the front panel display

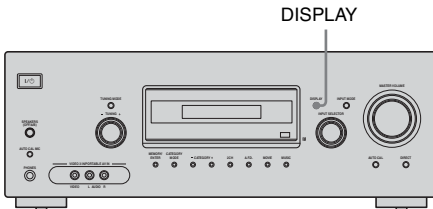

**Press DISPLAY on the receiver repeatedly.**

Each time you press DISPLAY while tuning in the channel, the display changes cyclically as follows:

Channel name → Channel number →  
Category → Artist name/Feature →  
Song/Program title → Sound field type

### Tip

The preset number is always displayed at the right end of the display.

## Presetting XM Radio stations

You can select the channels you want directly by presetting them using the preset numbers. You can preset up to 30 XM Radio channels.

## Presetting channels using the preset numbers

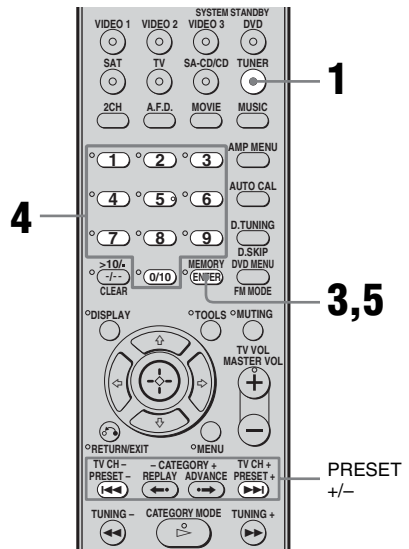

**1** Press TUNER repeatedly to select “XM RADIO”.

You can also use INPUT SELECTOR on the receiver.

**2** Tune in the channel you want to preset.

For details on selecting channels, see “Listening to the XM Radio” (page 60).

**3** Press MEMORY.

You can also use MEMORY/ENTER on the receiver.



## 4 Press the numeric buttons to enter the preset number.

You can also select the number by pressing PRESET + or PRESET -.

You can also turn TUNING +/- on the receiver.

Preset numbers from 1 to 30 are available, and channel 1 is preset for all the preset numbers when you purchase the receiver.

## 5 Press ENTER.

You can also use MEMORY/ENTER on the receiver.

## 6 Repeat steps 2 to 5 to preset another channel.

## 2 Press PRESET + or PRESET - repeatedly to select the preset channel you want.

You can also press the numeric buttons to select the preset channel you want. Then press ENTER to enter the selection.

You can also press TUNING MODE on the receiver to select "PRESET T.", and then turn TUNING +/-.

You can select preset channels from 1 to 30.

### Note

The preset channel information will be updated depending on the service provided by the XM Satellite Radio Inc. that you have subscribed to.

## Selecting the channel by using the preset numbers

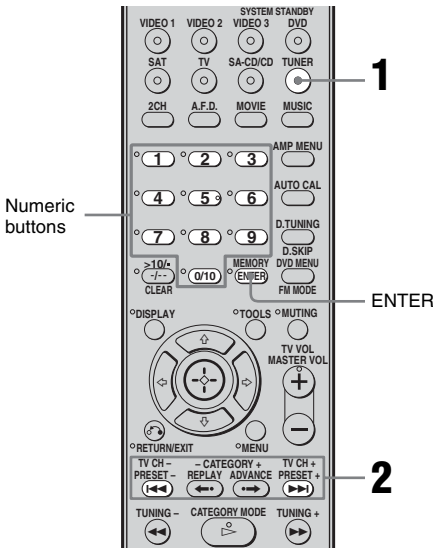

## 1 Press TUNER repeatedly to select "XM RADIO".

## XM Radio messages list

Message appears	Explanation	Remedies
ANTENNA	The XM antenna is not connected or transmission is not being received properly.	Make sure that the antenna is securely connected. Try to disconnect the antenna then reconnect, or turn off the power then turn back on.
UPDATING	The encryption code is being updated.	Wait until the encryption code has been updated.
NO SIGNL	The signal is too weak.	Adjust the antenna so that the signal is as strong as possible.
LOADING	The audio channel or information is being acquired.	Wait until the audio channel or information has been acquired.
OFF AIR	The selected channel is off the air.	Make sure that you selected the channel properly. Try to select another channel.
----	There is no characteristic information such as an artist name, song title or program title available.	—
--	The preset number entered is an invalid number.	Enter a number from 1 to 30.
XM --- CH	The selected channel is not available.	—

# Switching between digital and analog audio (INPUT MODE)

When you connect components to both digital and analog audio input jacks (SAT) on the receiver, you can fix the audio input mode.

## 1 Turn INPUT SELECTOR on the receiver to select the input.

You can also use the input buttons on the remote.

## 2 Press INPUT MODE repeatedly on the receiver to select the audio input mode.

The selected audio input mode appears on the display.

## Audio input modes

- **AUTO IN**  
Gives priority to digital audio signals when there are both digital and analog connections. If there are no digital audio signals, analog audio signals are selected.
- **HDMI IN**  
Specifies the digital audio signals input to the HDMI jack.
- **COAX IN**  
Specifies the digital audio signals input to the DIGITAL COAXIAL jack.
- **OPT IN**  
Specifies the digital audio signals input to the DIGITAL OPTICAL jack.
- **ANALOG**  
Specifies the analog audio signals input to the AUDIO IN (L/R) jacks.

## Notes

- Some audio input modes may not be set up depending on the input.
- When the ANALOG DIRECT function is being used, the audio input mode is set to "ANALOG" automatically. You cannot select other modes.

# Enjoying the DIGITAL MEDIA PORT (DMPORT)

The DIGITAL MEDIA PORT (DMPORT) allows you to enjoy sound from a network system such as a portable audio source or computer.

By connecting a DIGITAL MEDIA PORT adapter (not supplied), you can enjoy sound from the connected component on the receiver.

For details, refer to the operating instructions supplied with the DIGITAL MEDIA PORT adapter.

## Notes

- Do not connect an adapter other than the DIGITAL MEDIA PORT adapter.
- Do not connect or disconnect the DIGITAL MEDIA PORT adapter while the receiver is turned on.
- Depending on the DIGITAL MEDIA PORT adapter, video output may not be possible.
- The DIGITAL MEDIA PORT adapters are available for purchase depending on the area.

## Connecting the DIGITAL MEDIA PORT adapter

You can listen to the sound from the component connected through the DIGITAL MEDIA PORT adapter to the DMPORT jack on the receiver.

You can also view the images on the TV screen by connecting the video output of the DIGITAL MEDIA PORT adapter to the receiver.

To view the images, proceed to “Watching a connected component through DMPORT connection” on page 70.

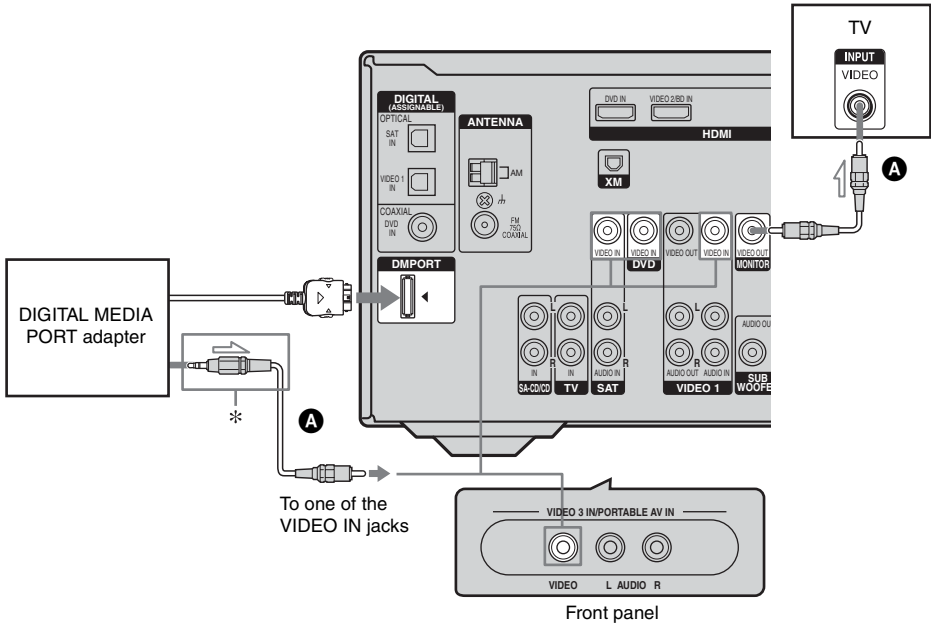

\* The type of connector varies depending on the DIGITAL MEDIA PORT adapter.  
For details, refer to the operating instructions supplied with the DIGITAL MEDIA PORT adapter.

**A** Video cord (not supplied)

## To detach the DIGITAL MEDIA PORT adapter from DMPORT jack

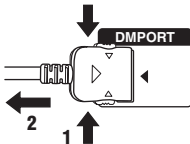

Press and hold both sides of the connector and then pull out the connector.

## Notes

- When connecting the DIGITAL MEDIA PORT adapter, be sure the connector is inserted with the arrow mark facing towards the arrow mark on the DMPORT jack.
- Be sure to make DMPORT connections firmly, insert the connector straight in.
- As the connector of the DIGITAL MEDIA PORT adapter is fragile, be sure to handle with care when placing or moving the receiver.

## Listening to a connected component through DMPORT connection

### 1 Press DMPORT.

You can also use the INPUT SELECTOR on the receiver to select "DMPORT".

### 2 Start playback of the connected component.

The sound is played back on the receiver. For details, refer to the operating instructions supplied with the DIGITAL MEDIA PORT adapter.

## Watching a connected component through DMPORT connection

You need to assign a composite video input to DMPORT input so that you can view the images on the TV screen.

### 1 Press AMP MENU.

"1-LEVEL" appears on the display.

### 2 Press $\uparrow/\downarrow$ repeatedly to select "6-VIDEO".

### 3 Press $\odot$ or $\rightarrow$ to enter the menu.

### 4 Press $\uparrow/\downarrow$ repeatedly to select "DMPORT V.".

### 5 Press $\odot$ or $\rightarrow$ to enter the parameter.

### 6 Press $\uparrow/\downarrow$ repeatedly to select the composite video input you want to assign to DMPORT input.

Initial setting: -NONE

The assignable composite video input are VIDEO 1, VIDEO 3, DVD and SAT inputs.

For example, select "-VIDEO 1".

When you press DMPORT, the images from the component connected to the VIDEO 1 VIDEO IN jack through DIGITAL MEDIA PORT adapter will appear on the TV screen.

## To return to the previous display

Press  $\leftarrow$ .

### Notes

- Depending on the type of DIGITAL MEDIA PORT adapter, you can operate the connected component by using the remote. For details on the remote button operation, see page 10.
- Be sure you have made the video connection from DIGITAL MEDIA PORT adapter to the receiver (page 69).
- Be sure you have connected the MONITOR OUT jack of the receiver to the TV (page 69).
- Depending on the DIGITAL MEDIA PORT adapter, video output may not be possible.

### Tip

When listening to MP3 or other compressed music using a portable audio source, you can enhance the sound. Press MUSIC repeatedly to select "PORTABLE" (page 51).

# Listening to digital sound from other inputs

## (DIGITAL ASSIGN)

You can reassign digital audio input that has OPTICAL or COAXIAL (SAT IN, VIDEO 1 IN, DVD IN) signals to another input when they are not currently being used.

For example, to output the sound source for the DVD player using the OPTICAL IN jack on the receiver:

- Connect the optical output jack of the DVD player to the OPTICAL VIDEO 1 IN jack of the receiver.
- Assign “VD1” to “DVD” in the “D. ASSIGN” setting.

### 1 Press AMP MENU.

“1-LEVEL” appears on the display.

### 2 Press $\uparrow/\downarrow$ repeatedly to select “5-AUDIO”.

### 3 Press $\oplus$ or $\rightarrow$ to enter the menu.

### 4 Press $\uparrow/\downarrow$ repeatedly to select “D. ASSIGN”.

### 5 Press $\oplus$ or $\rightarrow$ to enter the parameter.

### 6 Press $\uparrow/\downarrow$ repeatedly to select a vacant digital audio input (“VD1” in the example).

### 7 Press $\oplus$ or $\rightarrow$ to enter your selection.

### 8 Press $\uparrow/\downarrow$ repeatedly to select the input (“DVD” in the example) you want to assign to the digital audio input jack selected in step 6.

When “DVD” input is selected, the sound of the DVD player will become a digital sound through the OPTICAL VIDEO 1 IN jack.

The input you can assign varies for each audio input. For details, see the following “Assignable inputs for digital audio input”.

## Assignable inputs for digital audio input

The initial setting is marked with an underscore.

Digital audio input	Assignable inputs	Display
VIDEO 1 OPTICAL	VIDEO 1	<u>VD1- VD1</u>
	VIDEO 2	VD1- VD2
	VIDEO 3	VD1- VD3
	DVD	VD1- DVD
	TV	VD1- TV
	SA-CD/CD	VD1- CD
DVD COAXIAL	VIDEO 1	DVD- VD1
	VIDEO 2	DVD- VD2
	VIDEO 3	DVD- VD3
	DVD	<u>DVD- DVD</u>
	SAT	DVD- SAT
	TV	DVD- TV
SAT OPTICAL	SA-CD/CD	DVD- CD
	VIDEO 2	SAT- VD2
	VIDEO 3	SAT- VD3
	DVD	SAT- DVD
	SAT	<u>SAT- SAT</u>
	TV	SAT- TV
	SA-CD/CD	SAT- CD

continued

## Notes

- You cannot reassign more than one digital audio input to the same input.
- You cannot use the digital audio input as the original input when it has been reassigned to another input.
- When you assign the digital audio input, the INPUT MODE setting may change automatically (page 67).

## Naming inputs

You can enter a name of up to 8 characters for inputs and display it on the receiver's display. This is convenient for labeling the jacks with the names of the connected components.

### **1 Press the input button to select the input you want to create an index name for.**

You can also use INPUT SELECTOR on the receiver.

### **2 Press AMP MENU.**

"1-LEVEL" appears on the display.

### **3 Press $\uparrow/\downarrow$ repeatedly to select "5-AUDIO" or "6-VIDEO".**

### **4 Press $\odot$ or $\rightarrow$ to enter the menu.**

### **5 Press $\uparrow/\downarrow$ to select "NAME IN".**

### **6 Press $\odot$ or $\rightarrow$ to enter the parameter.**

The cursor flashes and you can select a character. Follow the procedure given in "To create an index name" (page 59).



## Changing the display

You can check the sound field, etc., by changing the information on the display. Be sure to use the buttons on the receiver for this operation.

### Press DISPLAY repeatedly.

Each time you press the button, the display changes cyclically as follows.

### All inputs except the FM and AM band and XM Radio

Index name of the input<sup>a)</sup> → Selected input  
→ Sound field currently applied

### FM and AM band

Preset station name<sup>a)</sup> → Frequency → Sound field currently applied

### XM Radio

Channel name → Channel number →  
Category name → Artist name/Feature →  
Song/program title → Sound field currently applied

<sup>a)</sup>Index name appears only when you have assigned one to the input or preset station (page 59, 72).  
Index name does not appear when only blank spaces have been entered, or it is the same as the input name.

### Note

Character or marks may not be displayed for some languages.

## Using the Sleep Timer

You can set the receiver to turn off automatically at a specified time.

### Press SLEEP repeatedly while the power is on.

Each time you press the button, the display changes cyclically as follows:

2-00-00 → 1-30-00 → 1-00-00 → 0-30-00  
→ OFF

When sleep timer is activated, the display dims.

### Note

If you press any buttons on the remote or receiver after the display dims, the display brightens up. After a while, the display dims again if no button is pressed.

### Tip

To check the remaining time before the receiver turns off, press SLEEP. The remaining time appears on the display. If you press SLEEP again, the sleep timer will be canceled.

# Recording using the receiver

## Recording onto a recording media

You can record from a video component using the receiver. See the operating instructions supplied with your recording component.

### **1 Press one of the input buttons to select the playback component.**

You can also use INPUT SELECTOR on the receiver.

### **2 Prepare the playback component for playing.**

For example, insert the video tape you want to copy into the VCR.

### **3 Prepare the recording component.**

Insert a blank video tape, etc. into the recording component (VIDEO 1) for recording.

### **4 Start recording on the recording component, then start playback on the playback component.**

#### Notes

- Some sources contain copy guards to prevent recording. In this case, you may not be able to record from the source.
- When DMPOR input is selected and you have assigned VIDEO 1 input to DMPOR input, no video signals are output from the VIDEO 1 VIDEO OUT jack.

## Using the Remote

### Changing button assignments

You can change the factory settings of the input buttons to suit the components in your system. For example, if you connect a DVD recorder to the VIDEO 1 jacks on the receiver, you can set the VIDEO 1 button on this remote to control the DVD recorder.

#### **1 Hold down the input button of which you want to change the assignment.**

Example: Hold down VIDEO 1.

#### **2 Referring to the table below, press the corresponding button for the category you want.**

Example: Press 4.

Now you can use the VIDEO 1 button to control the DVD recorder.

## Categories and the corresponding buttons

Categories	Press
VCR (command mode VTR 3) <sup>a)</sup>	1
VCR (command mode VTR 2) <sup>a)</sup>	2
DVD player/DVD recorder (command mode DVD1) <sup>b)</sup>	3
DVD recorder (command mode DVD3) <sup>b)</sup>	4
CD player	5
Euro Digital Satellite Receiver	6
DVR (Digital CATV terminal)	7
DSS (Digital Satellite Receiver)	8
Blu-ray disc player (command mode BD1) <sup>c)</sup>	9
Blu-ray disc recorder (command mode BD3) <sup>c)</sup>	0/10
TV	-/--
Not assigned	ENTER/ MEMORY

<sup>a)</sup> Sony VCRs are operated with a VTR 2 or VTR 3 setting which corresponds to 8 mm and VHS respectively.

<sup>b)</sup> Sony DVD recorders are operated with a DVD1 or DVD3 setting. For details, refer to the operating instructions supplied with the DVD recorders.

<sup>c)</sup> For details on the BD1 or BD3 setting, refer to the operating instructions supplied with the blu-ray disc player or blu-ray disc recorder.

## To clear all remote button assignments

Press **I/⏪**, **DMPORT** and **MASTER VOL** – at the same time.

The remote is reset to its factory settings.

## Additional Information

### Glossary

#### ■ Component video

A format for transmitting video signal information consisting of three separate signals: luminance Y, chrominance Pb, and chrominance Pr. High quality pictures, such as DVD video or HDTV pictures, are transmitted more faithfully. The three jacks are color - coded green, blue and red.

#### ■ Composite video

A standard format for transmitting video signal information. The luminance signal Y and chrominance signal C are combined and transmitted together.

#### ■ Dolby Digital

Digital audio encoding/decoding technology developed by Dolby Laboratories, Inc. It consists of front (left/right), center, surround (left/right) and sub woofer channels. It is a designated audio standard for DVD-video and also known as 5.1 channel surround. Since surround information is recorded and reproduced in stereo, more realistic sound with fuller presence is delivered than with Dolby surround.

#### ■ Dolby Digital Surround EX

Acoustic technology developed by Dolby Laboratories, Inc. Surround back information is matrixed into regular left and right surround channels so that the sound can be reproduced in 6.1 channel. Active scenes, especially, are recreated with a more dynamic and realistic sound field.

## ■ Dolby Pro Logic II

This technology converts 2 channel stereo recorded audio into 5.1 channel for playback. There is a MOVIE mode for movies and MUSIC mode for stereo sources such as music. Old movies encoded in the traditional stereo format can be enhanced with 5.1 channel surround sound.

## ■ Dolby Pro Logic IIx

Technology for 7.1 channel (or 6.1 channel) playback. Along with audio encoded in Dolby Digital Surround EX, 5.1 channel Dolby Digital encoded audio can be reproduced in 7.1 channel (or 6.1 channel). Furthermore, existing stereo recorded content can also be reproduced in 7.1 channel (or 6.1 channel).

## ■ Dolby Surround (Dolby Pro Logic)

Audio processing technology developed by Dolby Laboratories, Inc. Center and mono surround information is matrixed into two stereo channels. When reproduced, audio is decoded and output in 4 channel surround sound. This is the most common audio processing method for DVD-video.

## ■ DTS 96/24

A high sound quality digital signal format. It records audio at a sampling frequency and bit rate of 96kHz/24bit which is the highest possible for DVD-video. The number of playback channels varies depending on the software.

## ■ DTS Digital Surround

Digital audio encoding/decoding technology for theaters developed by DTS, Inc. It compresses audio less than Dolby Digital, delivering a higher quality sound reproduction.

## ■ DTS-ES

Format for 6.1 channel playback with surround back information. There are two modes, "Discrete 6.1" which records all channels independently, and "Matrix 6.1" which matrixes surround back channel into LS (left surround) and RS (right surround) channels. It is ideal for playback of motion picture soundtracks.

## ■ DTS Neo:6

This technology converts 2 channel stereo recorded audio for 6.1 channel playback. There are two modes to select according to the playback source or your preference, CINEMA for movies, and MUSIC for stereo sources such as music.

## ■ HDMI (High-Definition Multimedia Interface)

HDMI is an interface that supports both video and audio on a single digital connection. The HDMI connection carries standard to high definition video signals and multi-channel audio signals to audio/video components, such as HDMI equipped TVs, in digital form without degradation. The HDMI specification supports HDCP (High-bandwidth Digital Contents Protection), a copy protection technology that incorporates coding technology for digital video signals.

## ■ Sampling frequency

To convert analog audio to digital, analog data should be quantified. This process is called sampling, and the number of times per second the analog data is quantified is called the sampling frequency. A standard music CD stores data quantified at 44,100 times per second, which is expressed as a sampling frequency of 44.1 kHz. Generally speaking, a higher sampling frequency means better sound quality.

# Precautions

## On safety

Should any solid object or liquid fall into the cabinet, unplug the receiver and have it checked by qualified personnel before operating it any further.

## On power sources

- Before operating the receiver, check that the operating voltage is identical with your local power supply.  
The operating voltage is indicated on the nameplate on the back of the receiver.
- The unit is not disconnected from the AC power source (mains) as long as it is connected to the wall outlet, even if the unit itself has been turned off.
- If you are not going to use the receiver for a long time, be sure to disconnect the receiver from the wall outlet. To disconnect the AC power cord (mains lead), grasp the plug itself; never pull the cord.
- One blade of the plug is wider than the other for the purpose of safety and will fit into the wall outlet only one way. If you are unable to insert the plug fully into the outlet, contact your dealer.
- The AC power cord (mains lead) must be changed only at a qualified service shop.

## On heat buildup

Although the receiver heats up during operation, this is not a malfunction. If you continuously use this receiver at a large volume, the cabinet temperature of the top, side and bottom rises considerably. To avoid burning yourself, do not touch the cabinet.

## On placement

- Place the receiver in a location with adequate ventilation to prevent heat buildup and prolong the life of the receiver.
- Do not place the receiver near heat sources, or in a place subject to direct sunlight, excessive dust, or mechanical shock.
- Do not place anything on top of the cabinet that might block the ventilation holes and cause malfunctions.
- Do not place the receiver near equipment such as a television, VCR, or tape deck. If the receiver is being used in combination with a television, VCR, or tape deck, and is placed too close to that equipment, noise may result, and picture quality may suffer. This is especially likely when using an indoor antenna (aerial). Therefore, we recommend using an outdoor antenna (aerial).
- Use caution when placing the receiver on surfaces that have been specially treated (with wax, oil, polish, etc.) as staining or discoloration of the surface may result.

## On operation

Before connecting other components, be sure to turn off and unplug the receiver.

## On cleaning

Clean the cabinet, panel, and controls with a soft cloth slightly moistened with a mild detergent solution. Do not use any type of abrasive pad, scouring powder, or solvent, such as alcohol or benzine.

If you have any questions or problems concerning your receiver, please consult your nearest Sony dealer.

---

# Troubleshooting

If you experience any of the following difficulties while using the receiver, use this troubleshooting guide to help you remedy the problem.

## Audio

---

### **There is no sound, no matter which component is selected, or only a very low-level sound is heard.**

- Check that the speakers and components are connected securely.
- Check that both the receiver and all components are turned on.
- Check that MASTER VOLUME is not set to “VOL MIN”.
- Check that the SPEAKERS (OFF/A/B) is not set to “OFF”.
- Check that headphones are not connected.
- Press MUTING to cancel the muting function.
- Check that you have selected the correct component with the input buttons.
- The protective device on the receiver has been activated. Turn off the receiver, eliminate the short-circuit problem, and turn on the power again.

---

### **There is no sound from a specific component.**

- Check that the component is connected correctly to the audio input jacks for that component.
- Check that the cord(s) used for the connection is (are) fully inserted into the jacks on both the receiver and the component.

---

### **There is no sound from one of the front speakers.**

- Connect a pair of headphones to the PHONES jack to verify that sound is output from the headphones. If only one channel is output from the headphones, the component may not be connected to the receiver correctly. Check that all the cords are fully inserted into the jacks on both the receiver and the component. If both channels are output from the headphones, the front speaker may not be connected to the receiver correctly. Check the connection of the front speaker which is not outputting any sound.
- Make sure you have connected to both the L and R jacks of an analog component, and not only to either the L or R jack. Use an audio cord (not supplied).

---

### **There is no sound from analog 2 channel sources.**

- Check that the INPUT MODE is not set to “COAX IN” or “OPT IN” for the selected input (page 67).

---

### **There is no sound from digital sources (from COAXIAL or OPTICAL input jack).**

- Check that the INPUT MODE is not set to “ANALOG”. Check that the INPUT MODE is not set to “COAX IN” for the sources from the OPTICAL input jack, or to “OPT IN” for the sources from the COAXIAL input jack (page 67).
- Check that ANALOG DIRECT is not set to on.

---

**The source sound input from the HDMI jack is not output from the receiver or the TV speaker.**

- Check the HDMI connection.
- You cannot listen to the Super Audio CD by connecting HDMI.
- Depending on the playback component, you may need to set up the component. Refer to the operating instructions supplied with each component.

---

**The left and right sounds are unbalanced or reversed.**

- Check that the speakers and components are connected correctly and securely.
- Adjust the balance parameters using the LEVEL menu.

---

**There is severe hum or noise.**

- Check that the speakers and components are connected securely.
- Check that the connecting cords are away from a transformer or motor, and at least 10 feet away from a TV set or fluorescent light.
- Move your audio components away from the TV.
- The plugs and jacks are dirty. Wipe them with a cloth slightly moistened with alcohol.

---

**There is no sound, or only a very low-level sound is heard from the center/surround/surround back speakers.**

- Select a CINEMA STUDIO EX mode (page 52).
- Adjust the speaker level (page 31).
- Make sure the center/surround speakers are set to either “SMALL” or “LARGE” (page 39).
- Make sure the surround back speaker is set to “YES” (page 39).

---

**There is no sound from the surround back speaker.**

- Some discs have no Dolby Digital Surround EX flag even though the packages have Dolby Digital Surround EX logos. In this case, select “SB ON” (page 37).

---

**There is no sound from the sub woofer.**

- Check that the sub woofer is connected correctly and securely.
- Make sure you have turned on your sub woofer.
- Make sure the sub woofer is set to “YES” (page 39).
- There is no sound from the sub woofer depending on the sound field.

---

**The surround effect cannot be obtained.**

- Make sure the sound field function is on (press MOVIE, or MUSIC).
- Sound fields do not function for signals with a sampling frequency of more than 48 kHz.

---

**Dolby Digital or DTS multi channel sound is not reproduced.**

- Check that the DVD, etc. you are playing is recorded in Dolby Digital or DTS format.
- When connecting the DVD player, etc., to the digital input jacks of this receiver, check the audio setting (the settings for the audio output) of the connected component.

## Video

---

### There is no picture or an unclear picture appears on the TV screen.

- Select the appropriate input using the input buttons.
- Set your TV to the appropriate input mode.
- Move your audio components away from the TV.
- Assign the composite video input to the DMPORT input correctly.
- Depending on the DIGITAL MEDIA PORT adapter, video output may not be possible.

---

### The source image input to the HDMI jack on the receiver is not output from the TV.

- Check the HDMI connection.
- Depending on the playback component, you may need to set up the component. Refer to the operating instructions supplied with each component.

---

### Recording cannot be carried out.

- Check that the components are connected correctly.
  - Select the source component using the input buttons.
- 

## Tuner

---

### The FM reception is poor.

- Use a 75-ohm coaxial cable (not supplied) to connect the receiver to an outdoor FM antenna (aerial) as shown below. If you connect the receiver to an outdoor antenna (aerial), ground it against lightning. To prevent a gas explosion, do not connect the ground wire to a gas pipe.

Outdoor FM antenna (aerial)

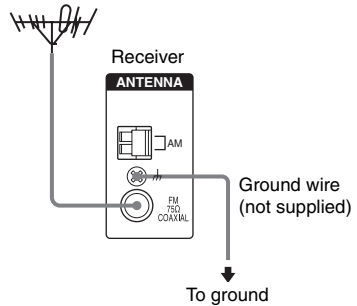

---

### Radio stations cannot be tuned in.

- Check that the antennas (aerials) are connected securely. Adjust the antennas (aerials) and connect an external antenna (aerial), if necessary.
  - The signal strength of the stations is too weak (when tuning in with automatic tuning). Use direct tuning.
  - Make sure you set the tuning interval correctly (when tuning in AM stations with direct tuning).
  - No stations have been preset or the preset stations have been cleared (when tuning by scanning preset stations). Preset the stations (page 57).
  - Press DISPLAY repeatedly on the receiver so that the frequency appears on the display.
-



## Remote commander

---

### The remote does not function.

- Point the remote at the remote sensor on the receiver.
  - Remove any obstacles in the path between the remote and the receiver.
  - Replace all the batteries in the remote with new ones, if they are weak.
  - Make sure you select the correct input on the remote.
- 

## Error messages

If there is a malfunction, the display shows a message. You can check the condition of the system by the message. Refer to the following table to solve the problem. If any problem persists, consult your nearest Sony dealer.

If an error message appears while you perform Auto Calibration, see “Error and warning codes” (page 30) to solve the problem.

---

### DEC. EROR

Appears when a signal the receiver cannot decode (ex. DTS-CD) is input and “DEC. PRI.” on the AUDIO menu is set to “DEC. PCM”. Set it to “DEC. AUTO” (page 38).

---

### PROTECT

Irregular current is output from the speakers. The receiver will automatically turn off after a few seconds. Check the speaker connection and turn on the power again.

---

## If you are unable to remedy the problem using the troubleshooting guide

Clearing the receiver’s memory may remedy the problem (page 26). However, note that all memorized settings will be reset to their factory settings and you will have to readjust all settings on the receiver.

## If the problem persist

Consult your nearest Sony dealer. Note that if service personnel changes some parts during repair, these parts may be retained.

## Reference sections for clearing the receiver’s memory

To clear	See
All memorized settings	page 26
Customized sound fields	page 55

---

# Specifications

## AUDIO POWER SPECIFICATIONS

### POWER OUTPUT AND TOTAL HARMONIC DISTORTION: (Models of area code U only)

With 8 ohm loads, both channels driven, from 20 – 20,000 Hz; rated 95 watts per channel minimum RMS power, with no more than 0.09% total harmonic distortion from 250 milliwatts to rated output.

#### Amplifier section

Models of area code U, CA<sup>1)</sup>

Minimum RMS Output Power (8 ohms, 20 Hz – 20 kHz, THD 0.09%)

95 W + 95 W

Stereo Mode Output Power (8 ohms, 1 kHz, THD 1%)

105 W + 105 W

Surround Mode Output Power<sup>2)</sup> (8 ohms, 1 kHz, THD 10%)

140 W/ch

<sup>1)</sup>Measured under the following conditions:

Area code	Power requirements
U, CA	120 V AC, 60 Hz

<sup>2)</sup>Reference power output for front, center, surround and surround back speakers. Depending on the sound field settings and the source, there may be no sound output.

Frequency response

Analog 10 Hz – 70 kHz  
+0.5/-2 dB (with sound field and equalizer bypassed)

Inputs

Analog Sensitivity: 500 mV/50 kohms  
S/N<sup>3)</sup>: 96 dB  
(A, 500 mV<sup>4)</sup>)  
Digital (Coaxial) Impedance: 75 ohms  
S/N: 100 dB  
(A, 20 kHz LPF)  
Digital (Optical) S/N: 100 dB  
(A, 20 kHz LPF)

Outputs (Analog)

AUDIO OUT Voltage: 500 mV/10 kohms  
SUB WOOFER Voltage: 2 V/1 kohm  
Equalizer  
Gain levels ±6 dB, 1 dB step

<sup>3)</sup>INPUT SHORT (with sound field and equalizer bypassed).

<sup>4)</sup>Weighted network, input level.

#### FM tuner section

Tuning range 87.5 - 108.0 MHz  
Antenna FM wire antenna  
Antenna terminals 75 ohms, unbalanced  
Intermediate frequency 10.7 MHz

#### AM tuner section

Tuning range

Area code	Tuning scale	
	10 kHz step	9 kHz step
U, CA	530 – 1,710 kHz <sup>5)</sup>	531 – 1,710 kHz <sup>5)</sup>

Antenna Loop antenna  
Intermediate frequency 450 kHz

<sup>5)</sup>You can change the AM tuning scale to 9 kHz or 10 kHz. After tuning in any AM station, turn off the receiver. While holding down TUNING MODE, press I/⏪. All preset stations will be erased when you change the tuning scale. To reset the scale to 10 kHz (or 9 kHz), repeat the procedure.

## Video section

### Inputs/Outputs

- Video: 1 Vp-p/75 ohms  
COMPONENT VIDEO:  
Y: 1 Vp-p/75 ohms  
PB/CB: 0.7 Vp-p/75 ohms  
PR/CR: 0.7 Vp-p/75 ohms  
80 MHz HD Pass Through

## General

### Power requirements

Area code	Power requirements
U, CA	120 V AC, 60 Hz

### Power output (DIGITAL MEDIA PORT)

- DC OUT 5 V, 700 mA

### Power consumption

Area code	Power consumption
U	250 W
CA	340 VA

### Power consumption (during standby mode)

- 0.3 W (when  
“CONTROL” in VIDEO  
menu is set to “CTRL  
OFF”)

### Dimensions (w/h/d) (Approx.)

- 430 × 157.5 × 310 mm  
(16 7/8 × 6 2/8 × 12 2/8  
inches) including  
projecting parts and  
controls

### Mass (Approx.)

- 7.8 kg (17 lb 4 oz)

## Supplied accessories

- FM wire antenna (aerial) (1)  
AM loop antenna (aerial) (1)  
Remote commander RM-AAU014 (1)  
R6 (size-AA) batteries (2)  
Optimizer microphone (ECM-AC2 or  
ECM-AC2a) (1)

For details on the area code of the component you are using, see page 3.

Design and specifications are subject to change without notice.

# Index

## Numerics

- 2 channel 54
- 2CH STEREO 54
- 5.1 channel 14
- 6.1 channel 14

## A

- AUTO CALIBRATION 28
- AUTO FORMAT DIRECT (A.F.D.) 49

## B

- Blu-ray disc player
  - connecting 18

## C

- Camcorder
  - connecting 24
- CD player
  - connecting 16
  - playback 34

## D

- DIGITAL ASSIGN 71
- Digital Cinema Sound (DCS) 53
- DIGITAL MEDIA PORT
  - connecting 69
  - input 33
  - video assign 70
- Dolby Digital 75
- DTS 76
- DVD player
  - connecting 21
  - playback 35
- DVD recorder
  - connecting 21

## E

- Error messages 81

## H

- HDMI
  - connecting 18

## I

- Initial setup 26
- INPUT MODE 67

## M

- Menu
  - A. CAL 49
  - AUDIO 43
  - EQ 41
  - LEVEL 40
  - SUR 41
  - SYSTEM 45
  - TUNER 43
  - VIDEO 44
- Muting 33

## N

- Naming 59, 72

## R

- Recording onto a recording media 74

## S

- Satellite tuner
  - connecting 23
- SB DEC 42
- Selecting
  - component 33
  - sound field 51
  - speaker system 27
- Set-top box
  - connecting 23
- Sleep Timer 73
- Sound fields
  - resetting 55
  - selecting 51
- Speakers
  - connecting 15
- Super Audio CD player
  - connecting 16
  - playback 34

## T

- TEST TONE 31
- Tuner
  - connecting 25
- Tuning
  - automatically 56
  - directly 56
  - to preset stations 58
- TV
  - connecting 20

## V

- VCR
  - connecting 24
- Video game
  - connecting 24

## X

- XM Radio 60



\* 2 8 9 8 6 3 7 1 1 \* (2)

## Free Manuals Download Website

<http://myh66.com>

<http://usermanuals.us>

<http://www.somanuals.com>

<http://www.4manuals.cc>

<http://www.manual-lib.com>

<http://www.404manual.com>

<http://www.luxmanual.com>

<http://aubethermostatmanual.com>

Golf course search by state

<http://golfingnear.com>

Email search by domain

<http://emailbydomain.com>

Auto manuals search

<http://auto.somanuals.com>

TV manuals search

<http://tv.somanuals.com>