

# ***Multi Channel AV Receiver***

---

## Operating Instructions

### Owner's Record

The model and serial numbers are located on the rear of the unit. Record the serial number in the space provided below. Refer to them whenever you call upon your Sony dealer regarding this product.

Model No. \_\_\_\_\_ Serial No. \_\_\_\_\_

## ***STR-DG810***

## WARNING

### To reduce the risk of fire or electric shock, do not expose this apparatus to rain or moisture.

To prevent fire, do not cover the ventilation of the apparatus with newspapers, table-cloths, curtains, etc. And don't place lighted candles on the apparatus.

To prevent fire or shock hazard, do not place objects filled with liquids, such as vases, on the apparatus.

Do not install the appliance in a confined space, such as a bookcase or built-in cabinet.

Install this system so that the power cord can be unplugged from the wall socket immediately in the event of trouble.



Don't throw away batteries with general house waste; dispose of them correctly as chemical waste.

## For customers in the United States

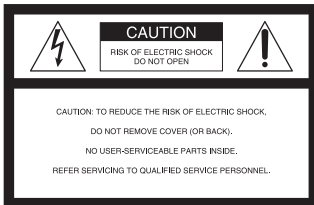

This symbol is intended to alert the user to the presence of uninsulated "dangerous voltage" within the product's enclosure that may be of sufficient magnitude to constitute a risk of electric shock to persons.



This symbol is intended to alert the user to the presence of important operating and maintenance (servicing) instructions in the literature accompanying the appliance.

## WARNING

This equipment has been tested and found to comply with the limits for a Class B digital device, pursuant to Part 15 of the FCC Rules. These limits are designed to provide reasonable protection against harmful interference in a residential installation. This equipment generates, uses, and can radiate radio frequency energy and, if not installed and used in accordance with the instructions, may cause harmful interference to radio communications. However, there is no guarantee that interference will not occur in a particular installation. If this equipment does cause harmful interference to radio or television reception, which can be determined by turning the equipment off and on, the user is encouraged to try to correct the interference by one or more of the following measures:

- Reorient or relocate the receiving antenna.
- Increase the separation between the equipment and receiver.
- Connect the equipment into an outlet on a circuit different from that to which the receiver is connected.
- Consult the dealer or an experienced radio/TV technician for help.

## CAUTION

You are cautioned that any changes or modification not expressly approved in this manual could void your authority to operate this equipment.

## Note to CATV system installer:

This reminder is provided to call CATV system installer's attention to Article 820-40 of the NEC that provides guidelines for proper grounding and, in particular, specifies that the cable ground shall be connected to the grounding system of the building, as close to the point of cable entry as practical.

## About This Manual

- The instructions in this manual are for model STR-DG810. Check your model number by looking at the lower right corner of the front panel. In this manual, models of area code U is used for illustration purposes unless stated otherwise. Any difference in operation is clearly indicated in the text, for example, “Models of area code CA only”.
- The instructions in this manual describe the controls on the supplied remote. You can also use the controls on the receiver if they have the same or similar names as those on the remote.

### About area codes

The area code of the receiver you purchased is shown on the lower left portion of the rear panel (see the illustration below).

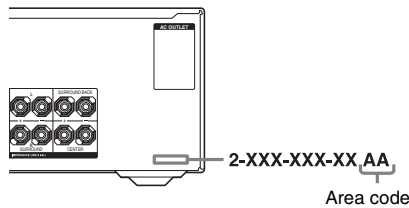

Any differences in operation, according to the area code, are clearly indicated in the text, for example, “Models of area code AA only”.

This receiver incorporates Dolby\* Digital and Pro Logic Surround and the DTS\*\* Digital Surround System.

- \* Manufactured under license from Dolby Laboratories.  
“Dolby”, “Pro Logic”, “Surround EX”, and the double-D symbol are trademarks of Dolby Laboratories.
- \*\* “DTS” and “DTS-ES | Neo:6” are registered trademarks of DTS, Inc. “96/24” is a trademark of DTS, Inc.

This receiver incorporates High-Definition Multimedia Interface (HDMI™) technology. HDMI, the HDMI logo and High-Definition Multimedia Interface are trademarks or registered trademarks of HDMI Licensing LLC.

XM is a registered trademark of XM Satellite Radio Inc.

This product is manufactured under license from Neural Audio Corporation.

Sony Corporation hereby grants the user a non-exclusive, non-transferable, limited license right to use this product under the US and foreign patents pending and other related technology owned by Neural Audio Corporation.

“Neural” and “Neural Audio” and “Neural Surround” are trademarks of Neural Audio Corporation.

## Note for the supplied remote

### (RM-AAP016)

The AUX button on the remote is not available for receiver operation.

---

# Table of Contents

---

## Getting Started

Description and location of parts.....	5
1: Installing speakers .....	15
2: Connecting speakers.....	16
3a: Connecting the audio components.....	17
3b: Connecting the video components .....	18
4: Connecting the antennas.....	26
5: Preparing the receiver and the remote .....	27
6: Selecting the speaker system.....	28
7: Calibrating the appropriate settings automatically (AUTO CALIBRATION).....	29
8: Adjusting the speaker levels and balance (TEST TONE).....	34

---

## Playback

Selecting a component.....	35
Listening/Watching a component .....	37

---

## Amplifier Operations

Navigating through menus.....	39
Adjusting the level (LEVEL menu).....	43
Adjusting the equalizer (EQ menu).....	44
Settings for the surround sound (SUR menu).....	44
Settings for the tuner (TUNER menu).....	46
Settings for the audio (AUDIO menu).....	46
Settings for the video (VIDEO menu).....	47
Settings for the system (SYSTEM menu)...	48

---

## Enjoying Surround Sound

Enjoying Dolby Digital and DTS surround sound (AUTO FORMAT DIRECT).....	52
Selecting a pre-programmed sound field ...	54
Using only the front speakers (2CH STEREO) .....	57
Listening to the sound without any adjustment (ANALOG DIRECT).....	57
Resetting sound fields to the initial settings .....	58

---

## Tuner Operations

Listening to FM/AM radio.....	58
Presetting radio stations .....	60
Listening to the XM Radio .....	63
Presetting XM Radio stations .....	68

---

## Other Operations

Switching the audio input mode (INPUT MODE) .....	71
Enjoying the DIGITAL MEDIA PORT (DMPORT) .....	72
Listening to digital sound from other inputs (DIGITAL ASSIGN) .....	75
Naming inputs.....	76
Changing the display .....	77
Using the Sleep Timer .....	77
Recording using the receiver.....	78

---

## Using the Remote

Programming the remote .....	79
------------------------------	----

---

## Additional Information

Glossary .....	84
Precautions.....	86
Troubleshooting .....	87
Specifications.....	91
Index .....	93

## Description and location of parts

### Front panel

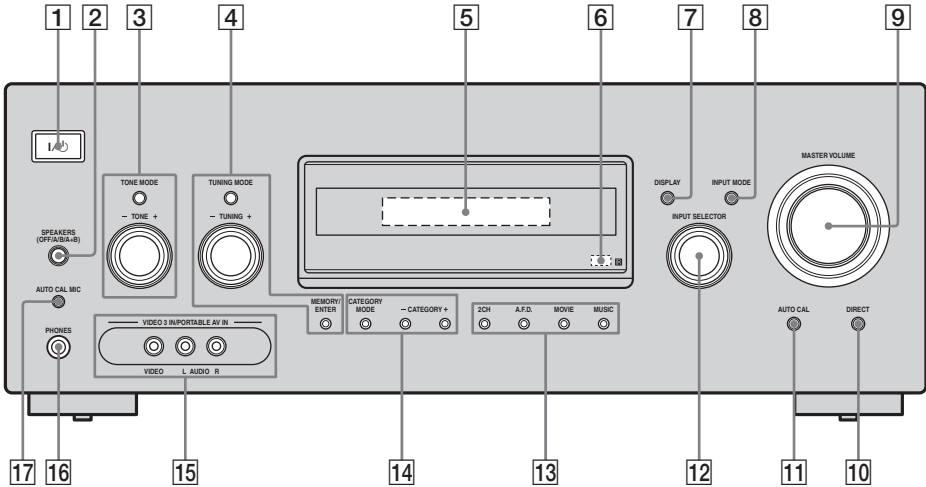

Name	Function
<b>1</b> I/⏻ (on/standby)	Press to turn the receiver on or off (page 27, 37, 38, 58, 91).
<b>2</b> SPEAKERS (OFF/A/B/A+B)	Press to select OFF, A, B, A+B of the front speakers (page 28).
<b>3</b> TONE MODE TONE +/-	Adjusts the tonal quality (bass/treble level) of the front speakers. Press TONE MODE repeatedly to select "BASS LVL" or "TRE LVL", then turn TONE +/- to adjust the level (page 40).
<b>4</b> TUNING MODE TUNING +/- MEMORY/ENTER	Press to operate a tuner (FM/AM/XM) (page 58, 63).

Name	Function
<b>5</b> Display	The current status of the selected component or a list of selectable items appears here (page 7).
<b>6</b> Remote sensor	Receives signals from remote commander.
<b>7</b> DISPLAY	Press to select information displayed on the display (page 67, 77).
<b>8</b> INPUT MODE	Press to select the input mode when the same components are connected to both digital and analog jacks (page 71).
<b>9</b> MASTER VOLUME	Turn to adjust the volume level of all speakers at the same time (page 34, 36, 37, 38).

*continued*

<b>Name</b>	<b>Function</b>
<b>10 DIRECT</b>	Press to listen to high quality analog sound (page 57).
<b>11 AUTO CAL</b>	Press to activate the Auto Calibration function (page 30).
<b>12 INPUT SELECTOR</b>	Turn to select the input source to playback (page 35, 37, 38, 57, 59, 64, 71, 74, 76, 78).
<b>13 MOVIE MUSIC A.F.D. 2CH</b>	Press to select a sound field (page 52, 54, 57).
<b>14 CATEGORY +/- CATEGORY MODE</b>	Used when listening to XM Radio (page 66).
<b>15 VIDEO 3 IN/ PORTABLE AV IN jacks</b>	Connect to a camcorder or video game (page 25, 36).
<b>16 PHONES jack</b>	Connects to headphones (page 87).
<b>17 AUTO CAL MIC jack</b>	Connects to the supplied optimizer microphone for the Auto Calibration function (page 29).

## About the indicators on the display

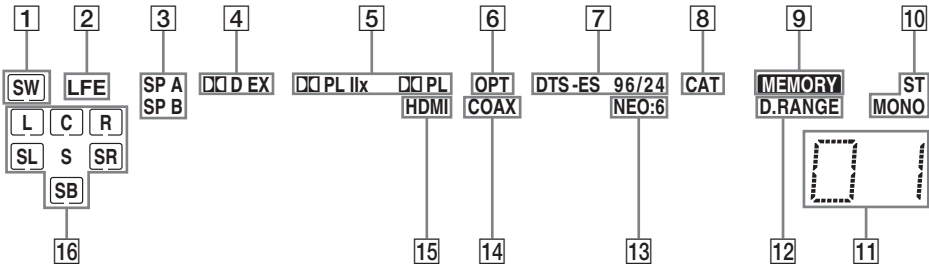

Name	Function
1 SW	Lights up when sub woofer is set to "YES" (page 42) and the audio signal is output from the SUB WOOFER jack.
2 LFE	Lights up when the disc being played back contains an LFE (Low Frequency Effect) channel and the LFE channel signal is actually being reproduced.
3 SP A/SP B	Lights up according to the speaker system used. However, these indicators do not light up if the speaker output is turned off or if headphones are connected.
4 D D/ D D EX	"D D" lights up when Dolby Digital signals are input. "D D EX" lights up when Dolby Digital Surround EX signals are decoded. <b>Note</b> When playing a Dolby Digital format disc, be sure that you have made digital connections and that INPUT MODE is not set to "ANALOG" (page 71).

Name	Function
5 D D PL/ D D PL II/ D D PL Iix	"D D PL" lights up when the receiver applies Pro Logic processing to 2 channel signals in order to output the center and surround channel signals. "D D PL II" lights up when the Pro Logic II Movie/Music/Game decoder is activated. "D D PL Iix" lights up when the Pro Logic Iix Movie/Music/Game decoder is activated. However, these indicators do not light up if both the center and surround speakers are set to "NO" (page 42) and you select a sound field using the A.F.D. button. <b>Note</b> Dolby Pro Logic Iix decoding does not function for DTS format signals or for signals with a sampling frequency of more than 48 kHz.
6 OPT	Lights up when INPUT MODE is set to "AUTO IN" and the source signal is a digital signal being input through the OPTICAL jack, or when INPUT MODE is set to "OPT IN" (page 71).

continued



Name	Function
<b>7 DTS/ DTS-ES/ DTS 96/24</b>	<p>“DTS” lights up when DTS signals are input. “DTS-ES” lights up when DTS-ES signals are input.</p> <p>“DTS 96/24” lights up when the receiver is decoding DTS 96 kHz/24 bit signals.</p> <p><b>Note</b></p> <p>When playing a DTS format disc, be sure that you have made digital connections and that INPUT MODE is not set to “ANALOG” (page 71).</p>
<b>8 CAT</b>	Lights up when you select category mode to “ONE CAT”. For details on presetting XM Radio station, see page 68.
<b>9 MEMORY</b>	Lights up when a memory function, such as Preset Memory (page 61), etc., is activated.
<b>10 Tuner indicators</b>	Lights up when using the receiver to tune in radio stations (page 58), etc.
<b>11 Preset station indicators</b>	Lights up when using the receiver to tune in radio stations you have preset. For details on presetting radio stations, see page 60.
<b>12 D.RANGE</b>	Lights up when dynamic range compression is activated (page 40).
<b>13 NEO:6</b>	Lights up when DTS Neo:6 Cinema/Music decoder is activated (page 53).
<b>14 COAX</b>	Lights up when INPUT MODE is set to “AUTO IN” and the source signal is a digital signal being input through the COAXIAL jack, or when INPUT MODE is set to “COAX IN” (page 71).
<b>15 HDMI</b>	Lights up when the receiver recognizes a component connected via an HDMI IN jack (page 19).

Name	Function
<b>16 Playback channel indicators</b>	<p>The letters (L, C, R, etc.) indicate the channels being played back. The boxes around the letters vary to show how the receiver downmixes the source sound (based on the speaker settings).</p> <p><b>L</b> Front Left</p> <p><b>R</b> Front Right</p> <p><b>C</b> Center (monaural)</p> <p><b>SL</b> Surround Left</p> <p><b>SR</b> Surround Right</p> <p><b>S</b> Surround (monaural or the surround components obtained by Pro Logic processing)</p> <p><b>SB</b> Surround back (the surround back components obtained by 6.1 channel decoding)</p> <p><b>Example:</b></p> <p>Recording format (Front/Surround): 3/2.1</p> <p>Output channel: When surround speakers are set to “NO” (page 42)</p> <p>Sound Field: A.F.D. AUTO</p>

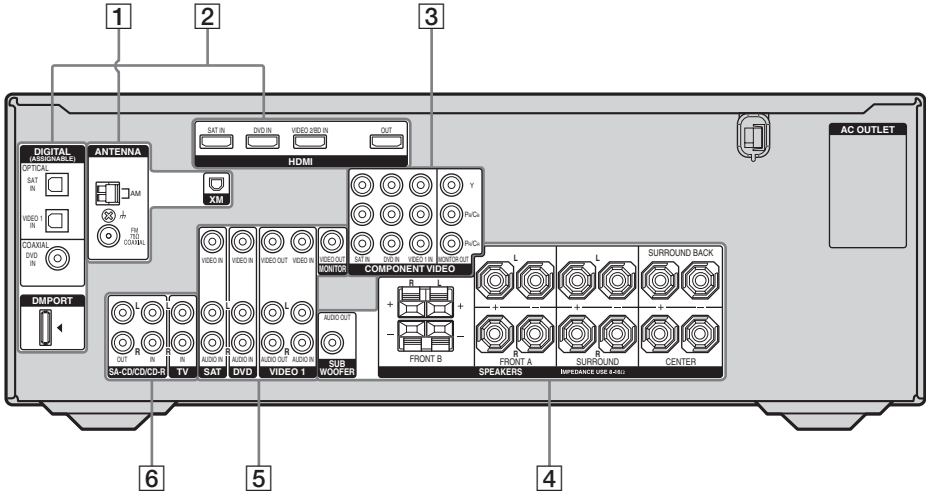









## 1 ANTENNA section

	<b>FM ANTENNA jack</b>	Connects to the FM wire antenna supplied with this receiver (page 26).
	<b>AM ANTENNA terminals</b>	Connects to the AM loop antenna supplied with this receiver (page 26).
	<b>XM jack</b>	Connects to the XM Connect-and-Play antenna (not supplied with this receiver) (page 63).

## 2 DIGITAL INPUT/OUTPUT section

	<b>OPTICAL IN jack</b>	Connects to a DVD player, etc. The COAXIAL jack provides a better quality of loud sound (page 22, 24).
	<b>COAXIAL IN jack</b>	
	<b>HDMI IN/OUT jack*</b>	Connects to a DVD player or a satellite tuner, etc. The image and the sound are output to TV or a projector (page 19).
	<b>DMPORT</b>	Connects to a DIGITAL MEDIA PORT adapter (page 73).

## 3 COMPONENT VIDEO INPUT/OUTPUT section

	<b>Green (Y) COMPONENT VIDEO INPUT/OUTPUT jack*</b>	Connects to a DVD player, TV or a satellite tuner, etc. You can enjoy high quality image (page 21 – 24).
	<b>Blue (Pb/Cb) COMPONENT VIDEO INPUT/OUTPUT jack*</b>	
	<b>Red (Pr/Cr) COMPONENT VIDEO INPUT/OUTPUT jack*</b>	

*continued*

#### 4 SPEAKER section

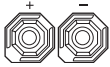

Connects to speakers (page 16).



Connects to sub woofer (page 16).

#### 5 VIDEO/AUDIO INPUT/OUTPUT section



White (L) AUDIO IN/ OUT jack  
Connects the video and audio jacks of a VCR or a DVD player (page 21 – 25).



Red (R)



Yellow VIDEO IN/ OUT jack\*

#### 6 AUDIO INPUT/OUTPUT section



White (L) AUDIO IN/ OUT jack  
Connects to a Super Audio CD player or CD player, etc. (page 17).



Red (R)

\* You can watch the selected input image when you connect the MONITOR OUT jack to a TV monitor (page 21).

## Remote commander

You can use the supplied remote to operate the receiver and to control the Sony audio/video components that the remote is assigned to operate. You can also program the remote to control non-Sony audio/video components. For details, see “Programming the remote” (page 79).



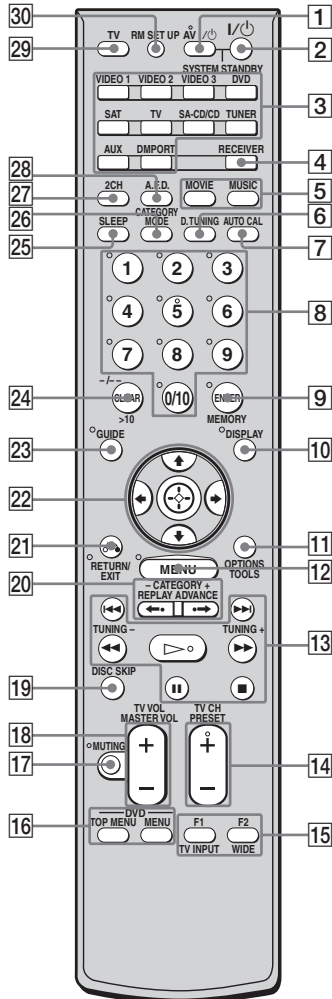







### RM-AAP016



























Name	Function
<b>1 AV I/⏻ (on/standby)</b>	<p>Press to turn on or off the audio/video components that the remote is programmed to operate.</p> <p>To turn the TV on or off, press TV (29) and then press AV I/⏻.</p> <p>If you press I/⏻ (2) at the same time, it will turn off the receiver and other components (SYSTEM STANDBY).</p> <p><b>Note</b></p> <p>The function of the AV I/⏻ switch changes automatically each time you press the input buttons (3).</p>
<b>2 I/⏻ (on/standby)</b>	<p>Press to turn the receiver on or off.</p> <p>To turn off all components, press I/⏻ and AV I/⏻ (1) at the same time (SYSTEM STANDBY).</p>

Name	Function
<b>3 Input buttons</b>	<p>Press one of the buttons to select the component you want to use. When you press any of the input buttons, the receiver turns on. The buttons are factory assigned to control Sony components as follows. You can program the remote to control non-Sony components by changing the code. For details see "Programming the remote" (page 79).</p>
Button	Assigned Sony component
VIDEO 1	VCR (VTR mode 3)
VIDEO 2	VCR (VTR mode 2)
VIDEO 3	VCR (VTR mode 1)
DVD	DVD player
SAT	Satellite tuner
TV	TV
SA-CD/CD	Super Audio CD/CD player
TUNER	Built-in tuner
AUX	Not assigned.
DMPORT	DIGITAL MEDIA PORT adapter
<b>4 RECEIVER</b>	Press to activate the receiver operation (page 39).
<b>5 MOVIE, MUSIC</b>	Press to select sound fields (MOVIE, MUSIC).
<b>6 D.TUNING</b>	Press to enter direct tuning mode.
<b>7 AUTO CAL</b>	Press to activate the Auto Calibration function.



Name	Function
<b>8</b> <b>Numeric buttons (number 5<sup>a</sup>)</b>	<p>Press to</p> <ul style="list-style-type: none"> <li>– preset/tune to preset stations.</li> <li>– select track numbers of the CD player, VCD player, DVD player, LD player, DAT deck, tape deck or MD deck. Press 0/10 to select track number 10.</li> <li>– select channel numbers of the VCR, satellite tuner, Blu-ray disc recorder, PSX, DVD/VHS COMBO or DVD/HDD COMBO.</li> </ul> <p>Press TV (29) and then press the numeric buttons to select the TV channels.</p>
<b>9</b> <b>ENTER</b>	<p>Press to enter the value after selecting a channel, disc or track using the numeric buttons of the VCR, CD player, VCD player, LD player, MD deck, DAT deck, tape deck, satellite tuner, Blu-ray disc recorder, or PSX.</p> <p>To enter the value of Sony TV, press TV (29) and then press ENTER.</p>
<b>MEMORY</b>	<p>Press to store a station during tuner operation.</p>
<b>10</b> <b>DISPLAY</b>	<p>Press to select information displayed on the TV screen of the VCR, VCD player, LD player, satellite tuner, CD player, DVD player, MD deck, Blu-ray disc recorder, PSX, DVD/VHS COMBO or DVD/HDD COMBO.</p> <p>To select information of Sony TV, press TV (29) and then press DISPLAY.</p>
<b>11</b> <b>OPTIONS TOOLS</b>	<p>Press to display and select items from the option menus for DVD player or DVD/VHS COMBO.</p> <p>To display the options of Sony TV, press TV (29) and then press OPTIONS TOOLS.</p>

Name	Function
<b>12</b> <b>MENU</b>	<p>Press to display the menus of the receiver, VCR, DVD player, satellite tuner, Blu-ray disc recorder, PSX, DVD/VHS COMBO or DVD/HDD COMBO on the TV screen.</p> <p>Then, use // and  to perform menu operations.</p> <p>To display the menus of Sony TV, press TV (29) and then press MENU.</p>
<b>13</b>   <b>b)</b>	<p>Press to skip tracks of the VCR, CD player, VCD player, LD player, DVD player, MD deck, DAT deck, tape deck, Blu-ray disc recorder, PSX, DVD/VHS COMBO or DVD/HDD COMBO.</p>
  <b>b)</b>	<p>Press to</p> <ul style="list-style-type: none"> <li>– search tracks in the forward/backward direction of the CD player, VCD player, DVD player, LD player, MD deck, Blu-ray disc recorder, PSX, DVD/VHS COMBO or DVD/HDD COMBO.</li> <li>– fast forward/rewind of the VCR, DAT deck or tape deck.</li> </ul>
 <b>a)b)</b>	<p>Press to start playback of the VCR, CD player, VCD player, LD player, DVD player, MD deck, DAT deck, tape deck, Blu-ray disc recorder, PSX, DVD/VHS COMBO or DVD/HDD COMBO.</p>
 <b>b)</b>	<p>Press to pause playback or recording of the VCR, CD player, VCD player, LD player, DVD player, MD deck, DAT deck, tape deck, Blu-ray disc recorder, PSX, DVD/VHS COMBO or DVD/HDD COMBO. (Also starts recording with components in recording standby.)</p>

Name	Function
■ <sup>b)</sup>	Press to stop playback of the VCR, CD player, VCD player, LD player, DVD player, MD deck, DAT deck, tape deck, Blu-ray disc recorder, PSX, DVD/VHS COMBO or DVD/HDD COMBO.
<b>TUNING +/-</b>	Press to scan a station.
<b>14 TV CH +<sup>a)</sup>/-</b>	Press TV (29), and then press TV CH +/- to select preset TV channels.
<b>PRESET +<sup>a)</sup>/-</b>	Press to select <ul style="list-style-type: none"> <li>- preset stations.</li> <li>- preset channels of the VCR, satellite tuner, Blu-ray disc recorder, DVD player, DVD/VHS COMBO or DVD/HDD COMBO.</li> </ul>
<b>15 F1, F2</b>	Press F1 or F2 to select a component <ul style="list-style-type: none"> <li>• DVD/HDD COMBO <ul style="list-style-type: none"> <li>F1: HDD mode</li> <li>F2: DVD mode</li> </ul> </li> <li>• DVD/VHS COMBO <ul style="list-style-type: none"> <li>F1: DVD mode</li> <li>F2: VHS mode</li> </ul> </li> </ul>
<b>WIDE</b>	Press TV (29), and then press WIDE to select the wide picture mode.
<b>TV INPUT</b>	Press TV (29) and then press TV INPUT to select the input signal (TV input or video input).
<b>16 DVD TOP MENU</b>	Press to display the menu or on-screen guide of the DVD player on the TV screen. Then, use  /  /  /  and  to perform menu operations.
<b>DVD MENU</b>	Press to display the menu of the DVD player on the TV screen. Then, use  /  /  /  and  to perform menu operations.
<b>17 MUTING</b>	Press to mute the sound (page 36). To mute the sound of the TV, press TV (29) and then press MUTING.

Name	Function
<b>18 TV VOL +/-</b>	Press TV (29) and then press TV VOL +/- to adjust the TV volume level.
<b>MASTER VOL +/-</b>	Press to adjust the volume level of all speakers at the same time.
<b>19 DISC SKIP</b>	Press to skip disc of the CD player, VCD player, DVD player or MD deck (multi-disc changer only).
<b>20 REPLAY ←·/ ADVANCE →·</b>	Press to replay the previous scene or fast forward the current scene of the DVD player, Blu-ray disc recorder, DVD/VHS COMBO or DVD/HDD COMBO.
<b>CATEGORY +/-</b>	Press to select XM Radio category you want.
<b>21 RETURN/ EXIT ↵</b>	Press to <ul style="list-style-type: none"> <li>- return to the previous menu.</li> <li>- exit the menu while the menu or on-screen guide of the VCD player, DVD player, LD player, Blu-ray disc recorder, PSX, DVD/VHS COMBO or satellite tuner is displayed on the TV screen.</li> </ul> <p>To return to the previous menu of Sony TV, press TV (29), and then press RETURN/EXIT ↵.</p>
<b>22</b>   /  /  / 	After pressing RECEIVER (4), press MENU (12) for receiver operation, then press  /  /  /  to select the settings. After pressing DVD TOP MENU (16) or DVD MENU (16), press  /  /  /  to select the settings, and then press  to enter the selection. Press  also to enter the selection of the receiver, VCR, satellite tuner, DVD player, Blu-ray disc recorder, PSX, DVD/VHS COMBO, or DVD/HDD COMBO.
<b>23 GUIDE</b>	Press to display the EPG (Electronic Program Guide) of the TV, DVD player, satellite tuner, Blu-ray disc recorder, PSX or DVD/HDD COMBO.

continued

Name	Function
<b>24</b> <b>-/--</b>	Press to select the channel entry mode, either one or two digits of the VCR or satellite tuner. To select the channel entry mode of the TV, press TV ( <b>29</b> ) and then press <b>-/--</b> .
<b>&gt;10</b>	Press to select track numbers over 10 of the VCR, VCD player, LD player, CD player, MD deck, tape deck, TV or satellite tuner.
<b>CLEAR</b>	Press to clear a mistake when you press the incorrect numeric button of the DVD player, satellite tuner, Blu-ray disc recorder, PSX, DVD/VHS COMBO or DVD/HDD COMBO.
<b>25</b> <b>SLEEP</b>	Press to activate the Sleep Timer function and the duration which the receiver turns off automatically.
<b>26</b> <b>CATEGORY MODE</b>	Press to select the category mode for XM radio.
<b>27</b> <b>2CH</b>	Press to select 2CH STEREO mode.
<b>28</b> <b>A.F.D.</b>	Press to select A.F.D. mode.
<b>29</b> <b>TV</b>	Press to light up the button. It changes the remote key function to activate the buttons with orange printing. It also activate the OPTIONS TOOLS ( <b>11</b> ), MENU ( <b>12</b> ), RETURN/EXIT  ( <b>21</b> ), DISPLAY ( <b>10</b> ),  ( <b>22</b> ) and  ( <b>22</b> ) buttons to perform menu operations for Sony TVs only.
<b>30</b> <b>RM SET UP</b>	Press to set-up the remote.

a) The number 5, PRESET +, TV CH +, and  buttons have tactile dots. Use the tactile dots as references when operating the receiver.

b) This button is also available for Sony DIGITAL MEDIA PORT adapter operation. For details on the function of the button, see the operating instructions supplied with the DIGITAL MEDIA PORT adapter.

## Notes

- The AUX on the remote is not available for receiver operation.
- Some functions explained in this section may not work depending on the model.
- The above explanation is intended to serve as an example only. Therefore, depending on the component, the above operation may not be possible or may operate differently than described.

# 1: Installing speakers

This receiver allows you to use a 6.1 channel system (6 speakers and one sub woofer).

## Enjoying a 5.1/6.1 channel system

To fully enjoy theater-like multi channel surround sound requires five speakers (two front speakers, a center speaker, and two surround speakers) and a sub woofer (5.1 channel).

### Example of a 5.1 channel speaker system configuration

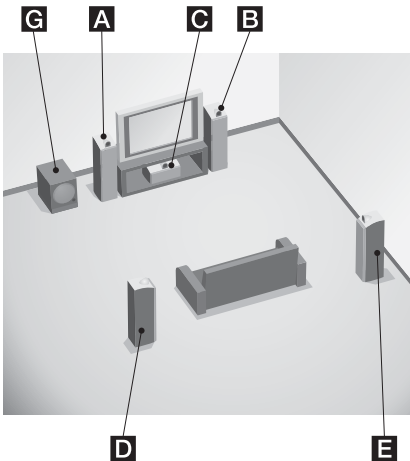

- A** Front speaker (Left)
- B** Front speaker (Right)
- C** Center speaker
- D** Surround speaker (Left)
- E** Surround speaker (Right)
- G** Sub woofer

You can enjoy high fidelity reproduction of DVD software recorded sound in the Surround EX format if you connect one additional surround back speaker (6.1 channel) (see “Using the surround back decoding mode” on page 45).

### Example of a 6.1 channel speaker system configuration

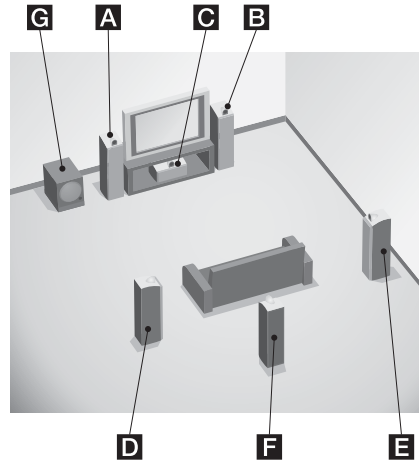

- A** Front speaker (Left)
- B** Front speaker (Right)
- C** Center speaker
- D** Surround speaker (Left)
- E** Surround speaker (Right)
- F** Surround back speaker
- G** Sub woofer

#### Tips

- When you connect a 6.1 channel speaker system, place the surround back speaker behind the listening position.
- Since the sub woofer does not emit highly directional signals, you can place it wherever you want.

## 2: Connecting speakers

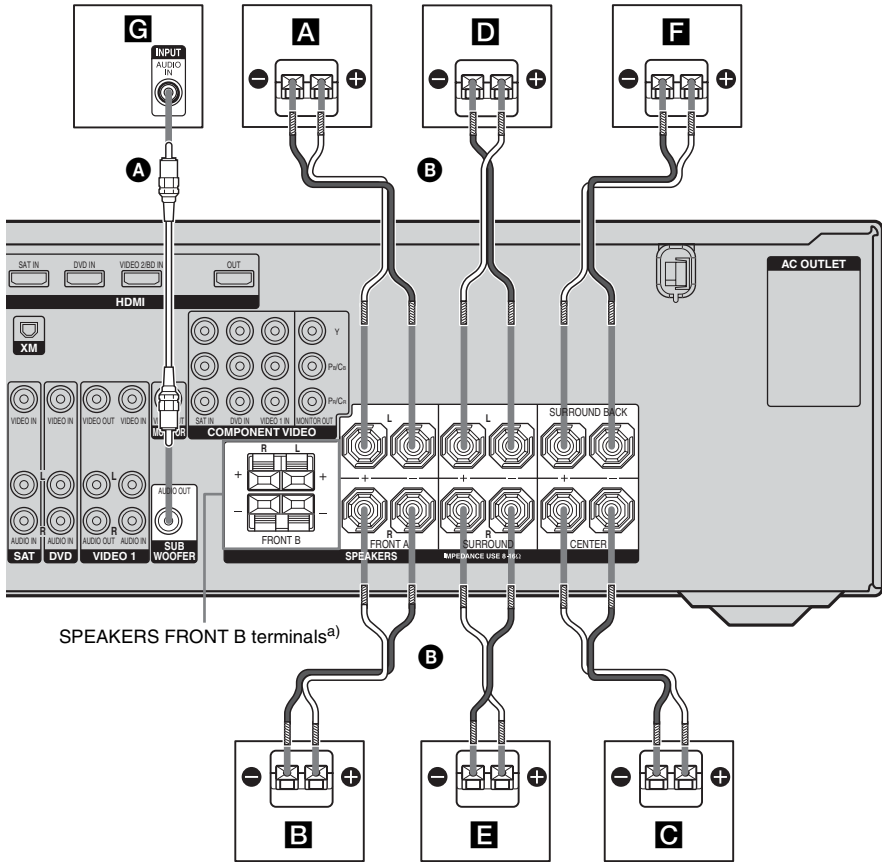

SPEAKERS FRONT B terminals<sup>a)</sup>

- A** Monaural audio cord (not supplied)
- B** Speaker cords (not supplied)

- A** Front speaker A (Left)
- B** Front speaker A (Right)
- C** Center speaker
- D** Surround speaker (Left)
- E** Surround speaker (Right)
- F** Surround back speaker
- G** Sub woofer<sup>b)</sup>

<sup>a)</sup> If you have an additional front speaker system, connect them to the SPEAKERS FRONT B terminal. You can select the front speakers you want to use with the SPEAKERS (OFF/A/B/A+B) button. For details, see “6: Selecting the speaker system” (page 28).

<sup>b)</sup> When you connect a sub woofer with an auto standby function, turn off the function when watching movies. If the auto standby function is set to ON, it turns to standby mode automatically based on the level of the input signal to a sub woofer, then sound may not be output.



## 3a: Connecting the audio components

### Connecting a Super Audio CD/CD player/CD recorder

The following illustration shows how to connect a Super Audio CD player, CD player or CD recorder.

After connecting your Super Audio CD player, CD player or CD recorder, proceed to “3b: Connecting the video components” (page 18) or “4: Connecting the antennas” (page 26).

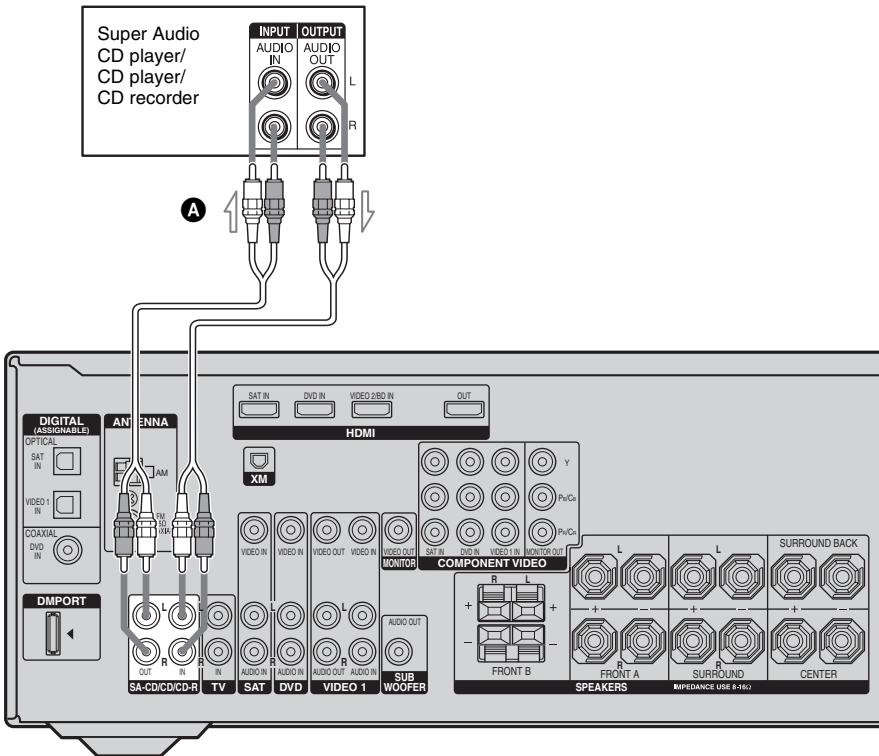

**A** Audio cord (not supplied)

# 3b: Connecting the video components

## How to hook up your components

This section describes how to hook up your components to this receiver. Before you begin, refer to “Component to be connected” below for the pages which describe how to connect each component.

After hooking up all your components, proceed to “4: Connecting the antennas” (page 26).

## Component to be connected

Component	Page
With HDMI jack	19
TV monitor	21
DVD player/DVD recorder	22
Satellite tuner/Set-top box	24
VCR	25
Camcorder, video game, etc.	25

## Video input/output jack to be connected

The image quality depends on the connecting jack. Refer to the illustration that follows. Select the connection according to the jacks on your components.

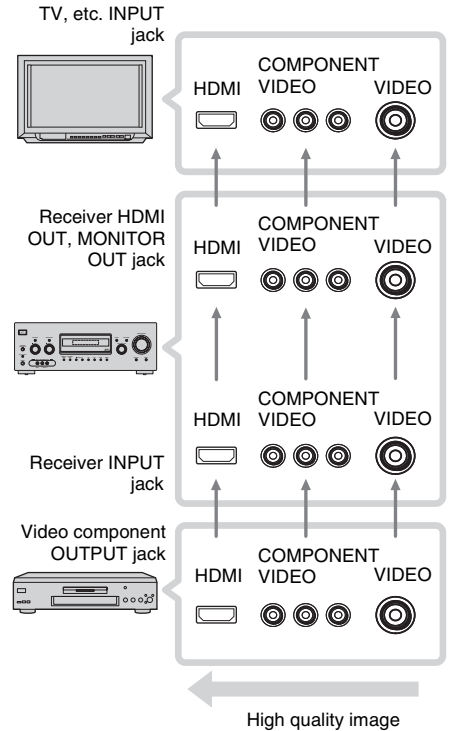

## Notes

- Connect image display components such as a TV or a projector to the HDMI OUT or MONITOR OUT jack on the receiver.
- Be sure to turn on the receiver when the video and audio of a playback component are being output to a TV through the receiver. If the power supply of the receiver is not on, neither video nor audio is transmitted.

## Connecting components with HDMI jacks

HDMI is the abbreviated name for High-Definition Multimedia Interface. It is an interface which transmits video and audio signals in digital format.

## HDMI feature

A digital audio signals transmitted by HDMI can be output from the speakers connected to the receiver. This signal supports Dolby Digital, DTS and linear PCM.

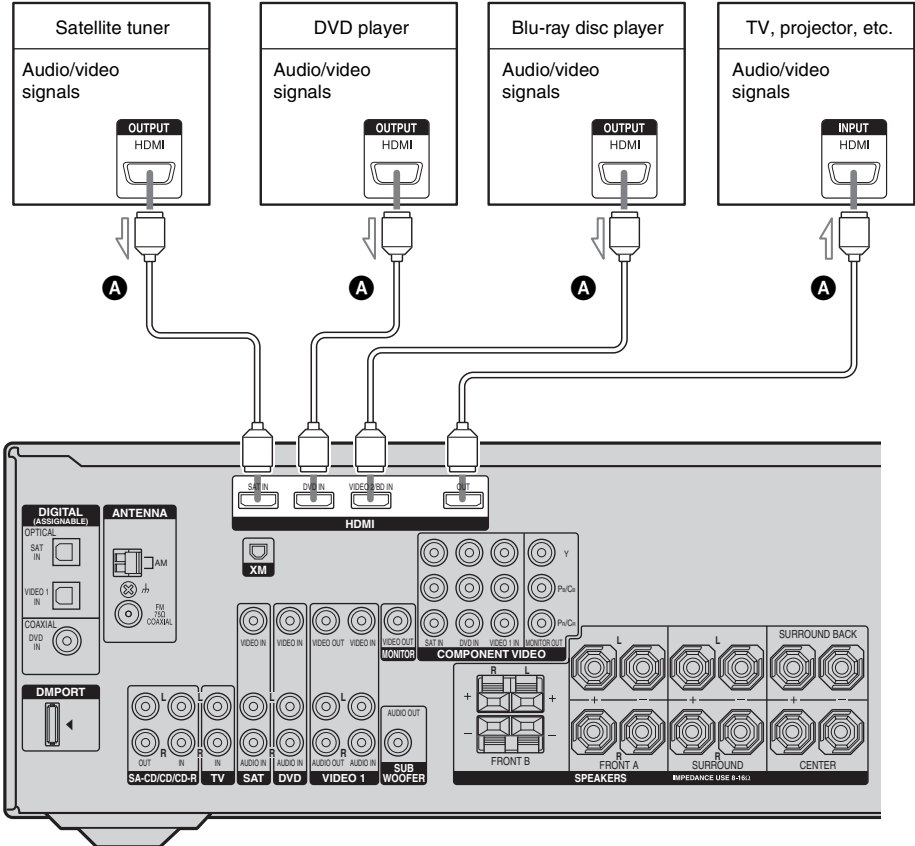

**A** HDMI cable (not supplied)

We recommend that you use a Sony HDMI cable.

*continued*

## If you connect a Blu-ray disc player

- Be sure to program the VIDEO 2 input button on the remote so that you can use the button to control your Blu-ray disc player. For details, see “Programming the remote” (page 79).
- You can also rename the VIDEO 2 input so that it can be displayed on the receiver’s display. For details, see “Naming inputs” (page 76).

## Notes on HDMI connections

- Use a HDMI cable with the HDMI logo (made by Sony).
- An audio signal input to the HDMI IN jack is output from the SPEAKERS jacks and HDMI OUT jack. It is not output from any other audio jacks.
- Video signals input to the HDMI IN jack can only be output from the HDMI OUT jack. The video input signals cannot be output from the VIDEO OUT jacks or MONITOR OUT jacks.
- When you want to listen to the sound from the TV speaker, set “HDMI AUDIO” to “TV+AMP” in the Video Settings menu (page 47). If you connect playback multi channel software, set to “AMP”. However, the sound will not output from the TV speaker.
- The multi/stereo area audio signals of a Super Audio CD are not output.
- Be sure to turn on the receiver when video and audio signals of a playback component are being output to a TV through this receiver. Unless the power is on, neither video nor audio signals will be transmitted.
- Audio signals (sampling frequency, bit length, etc.) transmitted from an HDMI jack may be suppressed by the connected component. Check the setup of the connected component if the image is poor or the sound does not come out of a component connected via the HDMI cable.
- Sound may be interrupted when the sampling frequency or the number of channels of audio output signals from the playback component is switched.
- When the connected component is not compatible with copyright protection technology (HDCP), the image and/or the sound from the HDMI OUT jack may be distorted or may be not output. In this case, check the specification of the connected component.
- Set the resolution of the image of the playback component to 720p or 1080i when you output 96 kHz multi-channel sound over a HDMI connection.
- We do not recommend using an HDMI-DVI conversion cable. When you connect an HDMI-DVI conversion cable to a DVI-D component, the sound and/or the image may not be output.
- Refer to the operating instructions of each component connected for details.

## Connecting a TV

The image from a visual component connected to this receiver can be displayed on a TV screen.

It is not necessary to connect all the cords. Connect audio and video cords according to the jacks of your components.

### Notes

- Connect image display components such as a TV or a projector to the MONITOR OUT jack on the receiver.
- Be sure to turn on the receiver when the video and audio of a playback component are being output to a TV via the receiver. If the power supply of the receiver is not turned on, neither video nor audio is transmitted.

### Tips

- You can watch the selected input image when you connect the MONITOR OUT jack to a TV.
- The sound of the TV is output from the speakers connected to the receiver if you connect the audio output jack of the TV to the TV IN jacks of this receiver.

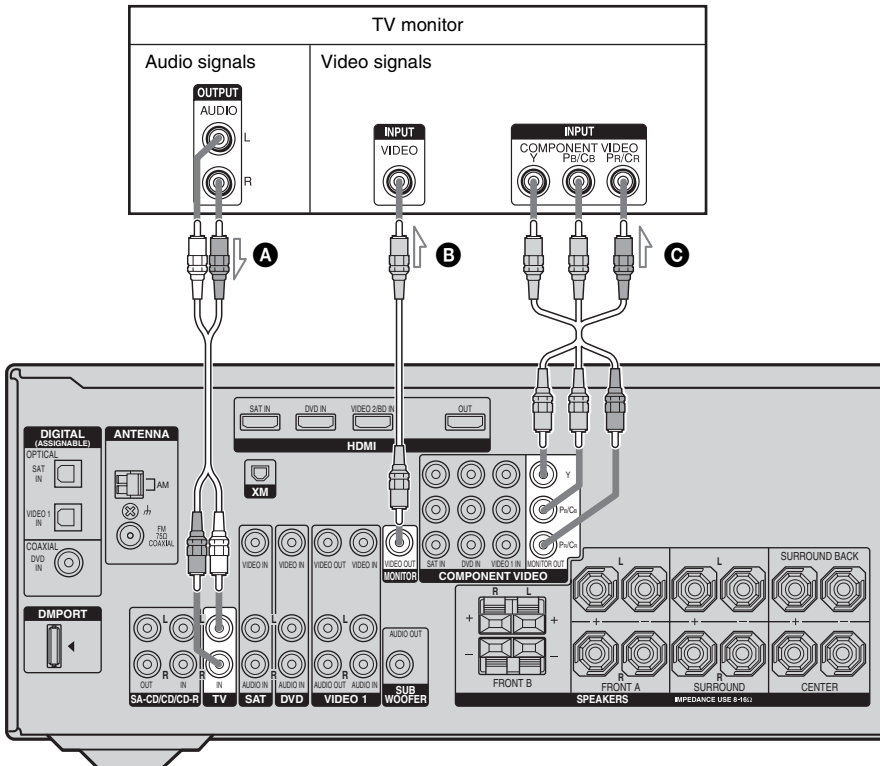

- A** Audio cord (not supplied)
- B** Video cord (not supplied)
- C** Component video cord (not supplied)

## Connecting a DVD player/DVD recorder

The following illustration shows how to connect a DVD player and DVD recorder. It is not necessary to connect all the cords. Connect audio and video cords according to the jacks of your components.

### Note

To input multi channel digital audio from the DVD player, set the digital audio output setting on the DVD player. Refer to the operating instructions supplied with the DVD player.

### Tip

All the digital audio jacks are compatible with 32 kHz, 44.1 kHz, 48 kHz, and 96 kHz sampling frequencies.

## Connecting a DVD player

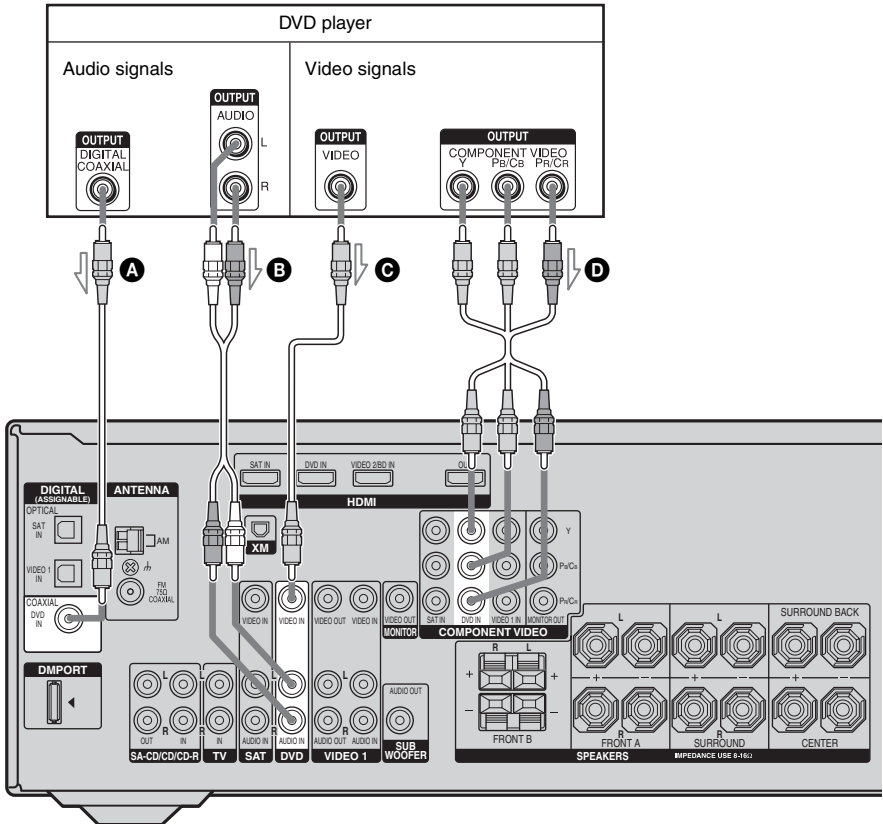

- A** Coaxial digital cord (not supplied)
- B** Audio cord (not supplied)
- C** Video cord (not supplied)
- D** Component video cord (not supplied)

# Connecting a DVD recorder

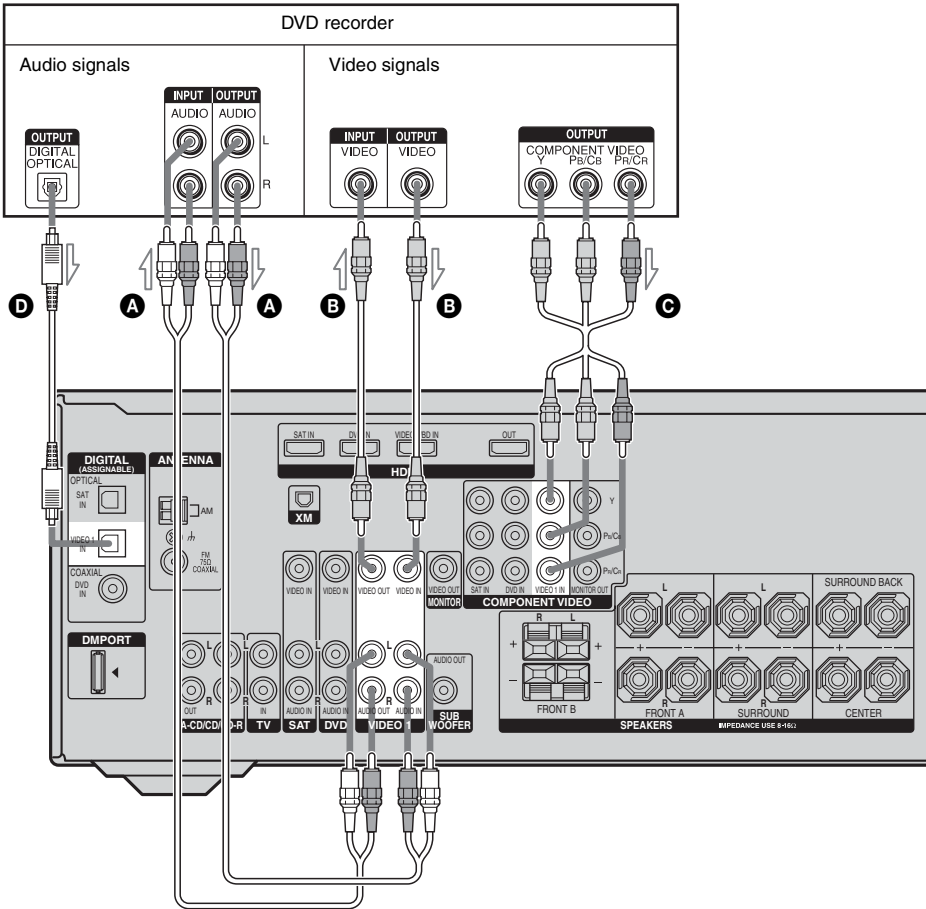

- A** Audio cord (not supplied)
- B** Video cord (not supplied)
- C** Component video cord (not supplied)
- D** Optical digital cord (not supplied)

## Notes

- Be sure to change the factory setting of the VIDEO 1 input button on the remote so that you can use the button to control your DVD recorder. For details, see “Programming the remote” (page 79).
- You can also rename the VIDEO 1 input so that it can be displayed on the receiver’s display. For details, see “Naming inputs” (page 76).
- When connecting optical digital cords, insert the plugs straight in until they click into place.
- Do not bend or tie optical digital cords.

## Tip

All the digital audio jacks are compatible with 32 kHz, 44.1 kHz, 48 kHz, and 96 kHz sampling frequencies.

## Connecting a satellite tuner/ set-top box

The following illustration shows how to connect a satellite tuner or set-top box. It is not necessary to connect all the cords. Connect audio and video cords according to the jacks of your components.

### Notes

- When connecting optical digital cords, insert the plugs straight in until they click into place.
- Do not bend or tie optical digital cords.

### Tip

All the digital audio jacks are compatible with 32 kHz, 44.1 kHz, 48 kHz, and 96 kHz sampling frequencies.

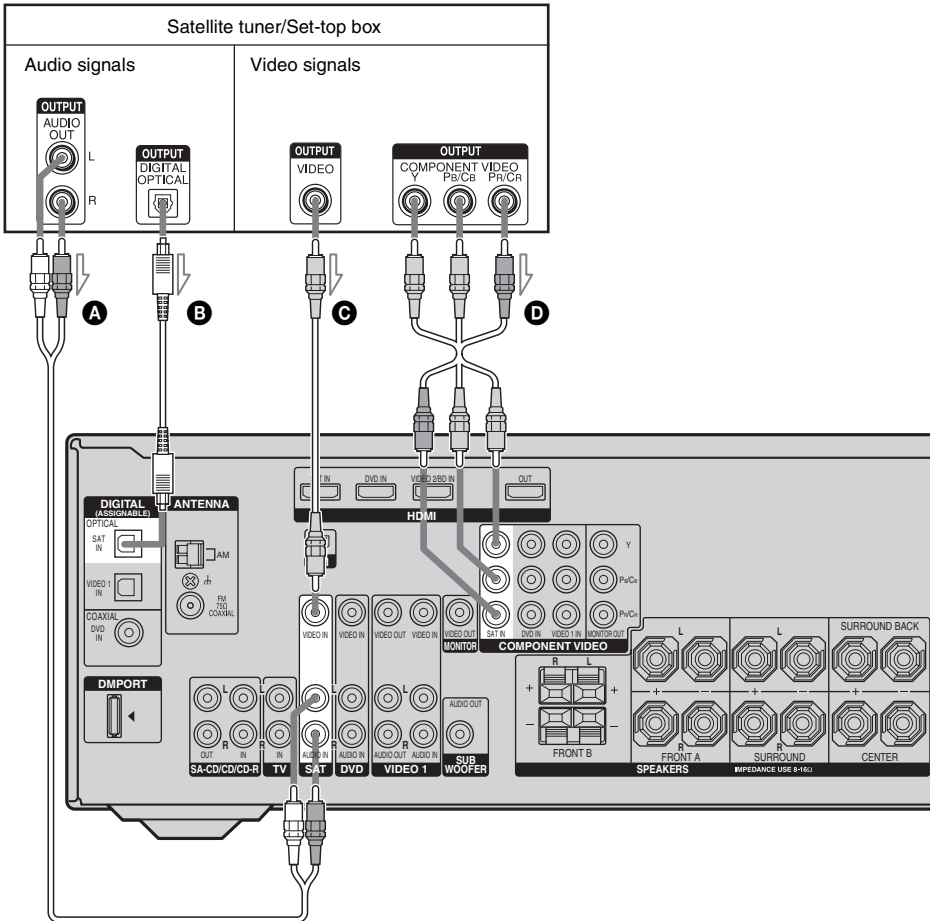

- A** Audio cord (not supplied)
- B** Optical digital cord (not supplied)
- C** Video cord (not supplied)
- D** Component video cord (not supplied)



## Connecting components with analog video and audio jack

The following illustration shows how to connect a component which has analog jacks such as a VCR, etc.

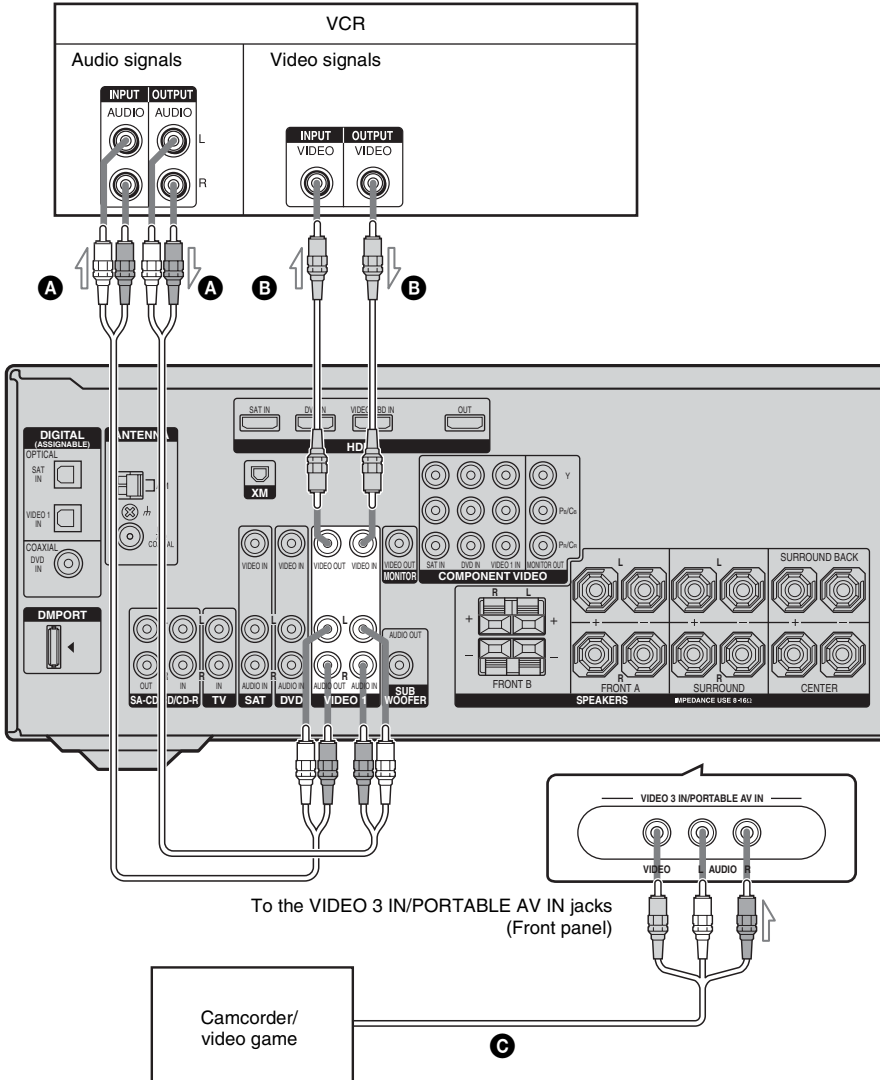

## 4: Connecting the antennas

Connect the supplied AM loop antenna and FM wire antenna.

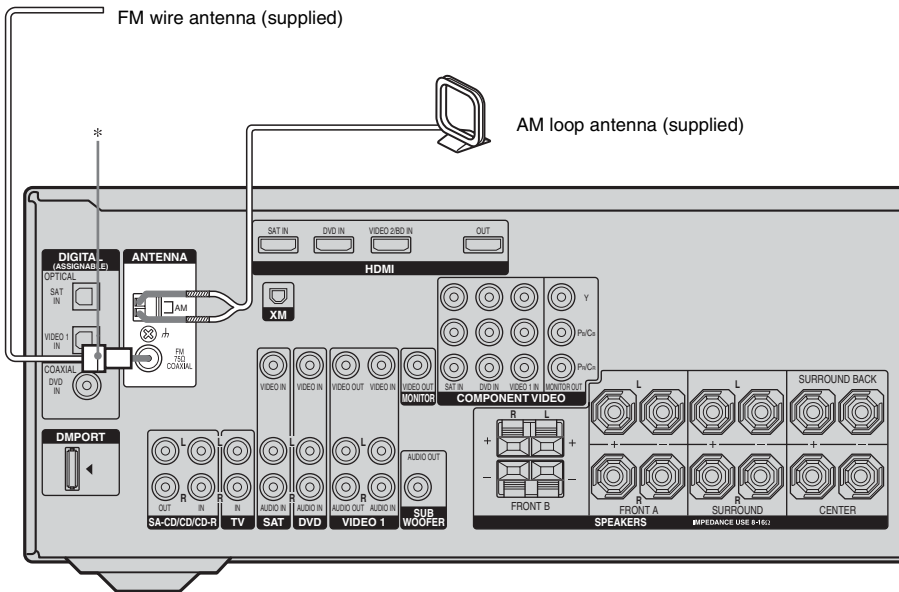

\* The shape of the connector varies depending on the area code of this receiver.

### Notes

- To prevent noise pickup, keep the AM loop antenna away from the receiver and other components.
- Be sure to fully extend the FM wire antenna.
- After connecting the FM wire antenna, keep it as horizontal as possible.

## 5: Preparing the receiver and the remote

### Connecting the AC power cord

Connect the AC power cord to a wall outlet.

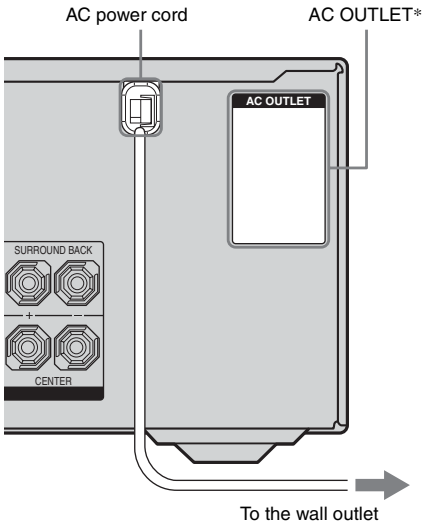

\* The configuration, shape, number of AC outlets and the information described on the label will vary according to area.

#### Notes

- The AC OUTLET(s) on the rear of the receiver is a switched outlet, which supplies power to the connected component only while the receiver is turned on.
- Make sure that the total power consumption of the component(s) connected to the receiver's AC OUTLET(s) does not exceed the wattage stated on the rear panel. Do not connect high-wattage electrical home appliances such as electric irons, fans, or TVs to this outlet. This may cause a malfunction.

### Performing initial setup operations

Before using the receiver for the first time, initialize the receiver by performing the following procedure. This procedure can also be used to return settings you have made to their factory defaults.

Be sure to use the buttons on the receiver for this operation.

## 1,2

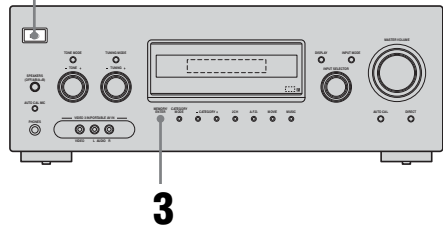

- 1 Press I/⏻ to turn off the receiver.**
- 2 Hold down I/⏻ for 5 seconds.** “PUSH” and “ENTER” appears on the display alternately.
- 3 Press MEMORY/ENTER.**

After “CLEARING” appears on the display for a while, “CLEARED” appears.

The following items are reset to their factory settings.

- All settings in the LEVEL, EQ, SUR, TUNER, AUDIO, VIDEO, SYSTEM and A. CAL menus.
- The sound field memorized for each input and preset station.
- All sound field parameters.
- All preset stations.
- All index names for inputs and preset stations.
- MASTER VOLUME is set to “VOL MIN”.
- Input is set to “DVD”.

## Inserting batteries into the remote

Insert two R6 (size-AA) batteries in the RM-AAP016 remote commander. Observe the correct polarity when installing batteries.

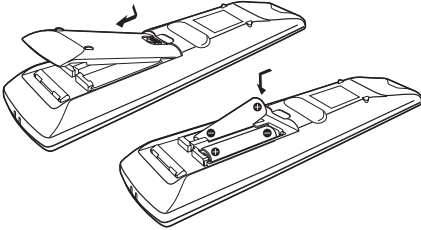

### Notes

- Do not leave the remote in an extremely hot or humid place.
- Do not use a new battery with old ones.
- Do not mix alkaline batteries and other kinds of batteries.
- Do not expose the remote sensor to direct sunlight or lighting apparatuses. Doing so may cause a malfunction.
- If you do not intend to use the remote for an extended period of time, remove the batteries to avoid possible damage from battery leakage and corrosion.
- When you replace the batteries, the remote buttons may be reset to their factory settings. If this happens, reassign the buttons again (page 79).

### Tip

Under normal conditions, the batteries should last for about 3 months. When the remote no longer operates the receiver, replace all the batteries with new ones.

## 6: Selecting the speaker system

You can select the front speakers you want to drive.

Be sure to use the buttons on the receiver for this operation.

SPEAKERS (OFF/A/B/A+B)

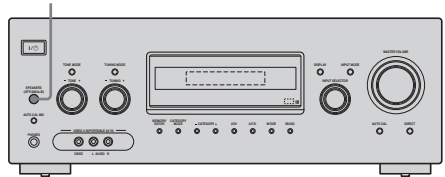

**Press SPEAKERS (OFF/A/B/A+B) repeatedly to select the front speaker system you want to drive.**

To select	Light up
The speakers connected to the SPEAKERS FRONT A terminals	SP A
The speakers connected to the SPEAKERS FRONT B terminals	SP B
The speakers connected to both the SPEAKERS FRONT A and B terminals (parallel connection)	SP A and SP B

To turn off the speaker output, press SPEAKERS (OFF/A/B/A+B) repeatedly until the “SP A” and “SP B” indicators on the display do not light up.

## 7: Calibrating the appropriate settings automatically (AUTO CALIBRATION)

The DCAC (Digital Cinema Auto Calibration) function allows you to perform Automatic Calibration, such as checking the connection between each speaker and the receiver, adjusting the speaker level, and measuring the distance of each speaker from your listening position automatically. Refer also to the “Quick Setup Guide” supplied with the receiver.

You can also adjust the speaker levels and balance manually. For details, see “8: Adjusting the speaker levels and balance (TEST TONE)” (page 34).

### Before you perform Auto Calibration

Before you perform Auto Calibration, install and connect the speakers (page 15, 16).

- The AUTO CAL MIC jack is used for the supplied optimizer microphone only. Do not connect other microphones to this jack. Doing so may damage the receiver and the microphone.
- During calibration, the sound that comes out of the speakers is very loud. Pay attention to the presence of children or to the effect on your neighborhood.
- Perform Auto Calibration in a quiet environment to avoid the effect of noise and to get a more accurate measurement.
- If there are any obstacles in the path between the optimizer microphone and the speakers, the calibration cannot be performed correctly. Remove any obstacles from the measurement area to avoid measurement error.

### Notes

- The Auto Calibration function does not work in the following cases.
  - The ANALOG DIRECT function is being used.
  - Headphones are connected.
- If the Muting function is on when we perform Auto Calibration, it will turn off automatically.

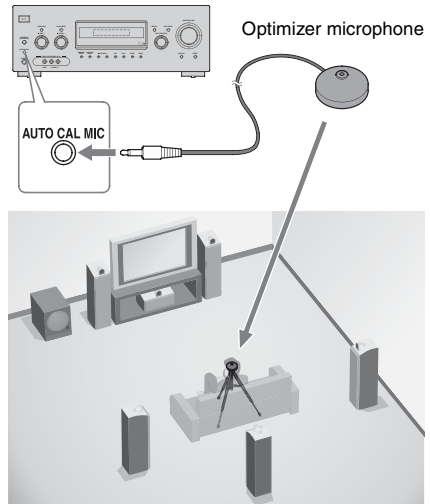

- 1 Connect the supplied optimizer microphone to the AUTO CAL MIC jack on the front panel.**
- 2 Set up the optimizer microphone.**

Place the optimizer microphone at your listening position. You can also use a stool or tripod so that the optimizer microphone remains at the same height as your ears.

### Tip

When you face the speaker towards the optimizer microphone, you will get a more accurate measurement.

## On setting up the active sub woofer

- When a sub woofer is connected, turn on the sub woofer and turn up the volume beforehand. Turn the VOLUME knob to just before the mid-point.
- If you connect a sub woofer with a crossover frequency function, set the value to the maximum.
- If you connect a sub woofer with an auto standby function, set this function to off (deactivated).

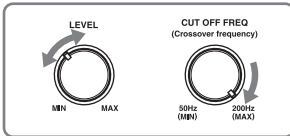

### Note

Depending on the characteristics of the sub woofer you are using, the setup distance value may be further away from the actual position.

## Performing Auto Calibration

The Auto Calibration function allows you to measure the following:

- Speakers connection
- Speakers polarity
- Distance of each speaker from your listening position
- Speaker size
- Speaker level
- Frequency characteristics\*

- \*• DTS 96/24 signals are always played back as 48 kHz when you correct signals.
- The measurement result is not utilized when input signals of which the sampling frequency is more than 96 kHz are being received.

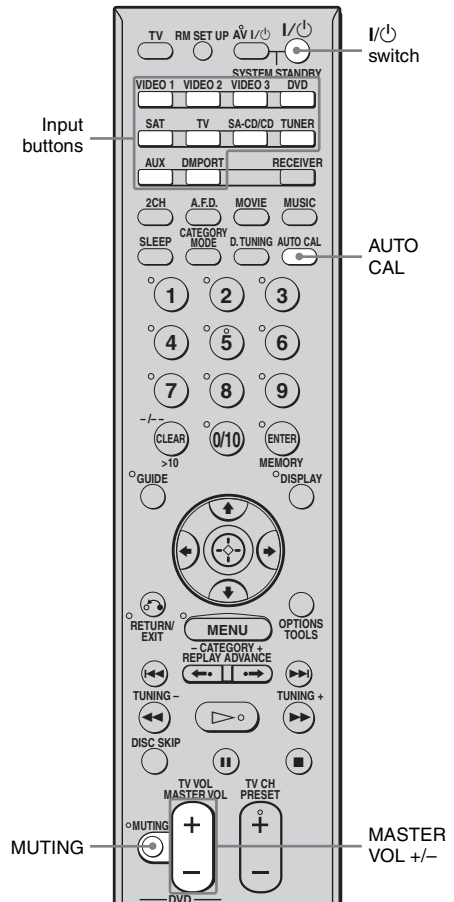

### Press AUTO CAL.

You can also select “A. CAL YES” in the A. CAL menu.

Measurement starts in 5 seconds and the display changes as follows:

A.CAL [5] → A.CAL [4] → A.CAL [3] → A.CAL [2] → A.CAL [1]

The measurement process will take approximately 30 seconds to complete.

The table below shows the display when measurement starts.

Measurement for	Display
Speaker existance	TONE
Speaker gain, distance, frequency response	T.S.P.
Subwoofer gain and distance	WOOFER

### Note

You cannot measure the speaker height of the surround speakers and the surround back speakers. Set this value using "SUR POS." parameters in the SYSTEM menu (page 42).

### Tips

- The Auto Calibration function will be canceled when you do the following during the measurement process:
  - Press I/⏸, input buttons or MUTING on the remote.
  - Press SPEAKERS (OFF/A/B/A+B) or turn the INPUT SELECTOR on the receiver.
  - Change the volume level.
  - Press AUTO CAL again.
  - Connect the headphones.
- The measurement may not be performed correctly or Auto Calibration cannot be performed when special speakers, such as dipole speakers are used.

## Confirming/saving the measurement results

### 1 Confirm the measurement result.

When the measurement ends, a beep sounds and the measurement result appears on the display.

Measurement result	Display	Explanation
When the measurement process completes properly	SAVE	Proceed to step 2.
When the measurement process fails	ERROR XXXX	See "When error codes appear" (page 32).

### 2 Press RECEIVER and then press $\uparrow/\downarrow$ repeatedly to select the item. Then, press .

Item	Explanation
RETRY	Performs the Auto Calibration again.
SAVE	Saves the measurement results and exits the setting process.
WARN CHK	Displays warning concerning the measurement results. See "When you select "WARN CHK"" (page 32).
PHASE	Displays the phase of each speaker (in phase/out of phase). See "When you select "PHASE"" (page 33).
DISTANCE	Displays the measurement result for speaker distance.
LEVEL	Displays the measurement result for speaker level.
EXIT	Exits the setting process without saving the measurement results.

*continued*

### 3 Save the measurement result.

Select "SAVE" in step 2.

The measurement results are saved and you can select the calibration type in the A. CAL menu.

For details on calibration type, see page 33.

#### Tip

The size of a speaker (LARGE/SMALL) is determined by the low frequency characteristics. The measurement results may vary, depending on the position of the optimizer microphone and speakers, and the shape of the room. It is recommended that you follow the measurement results. However, you can change those settings in the SYSTEM menu (page 42). Save the measurement results first, then try to change the settings if you want.

### When error codes appear

Try the remedies and perform the Auto Calibration again.

Error code	Cause and remedies
ERROR 31	SPEAKERS (OFF/A/B/A+B) is set to off. Set it to others and perform the Auto Calibration again.
ERROR 32	None of the speakers were detected. Make sure that the optimizer microphone is connected properly and perform the Auto Calibration again. If the optimizer microphone is connected properly but the error code appears, the optimizer microphone cable may be damaged or improperly connected.
ERROR F 33	<ul style="list-style-type: none"><li>• None of the front speakers are connected or only one front speaker is connected.</li><li>• The optimizer microphone is not connected.</li></ul>
ERROR SR 33	<ul style="list-style-type: none"><li>• Either the left or right surround speakers is not connected.</li><li>• Surround back speakers are connected even though surround speakers are not connected. Connect the surround speaker to the SPEAKERS SURROUND terminals.</li></ul>

### • CODE 31

1 Press RECEIVER, then press ⊕, then follow the instructions from step 1 of "Performing Auto Calibration".

### • CODE 32, 33

1 Press RECEIVER, then press ⊕, "RETRY Y" appears on the display.

2 Press ⊕ again.

3 Follow the instructions from step 2 of "Performing Auto Calibration".

### When you select "WARN CHK"

If a warning on the measurement result is present, detailed information is displayed.

Press ⊕ to return to step 2 of "Confirming/saving the measurement results".

Warning code	Explanation
WARN 40	The Auto Calibration has completed. However, the noise level is high. You may be able to perform the Auto Calibration properly if you try it again, even though the measurement cannot be performed in all environments. Try to perform the Auto Calibration in a quiet environment.
WARN 41	The sound input from the optimizer microphone is out of the acceptable range. It is louder than the loudest sound that can be measured. Try to perform the Auto Calibration when the environment is quiet enough to allow proper measurement.
WARN 42	The volume of the receiver is out of the acceptable range. Try to perform the Auto Calibration when the environment is quiet enough to allow proper measurement.
WARN 43	The distance and position of a sub woofer cannot be detected. This may be caused by noise. Try to perform the Auto Calibration in a quiet environment.
NO WARN	There is no warning information.



## When you select “PHASE”

You can check the phase of each speaker (in phase/out of phase).

**Press  $\uparrow/\downarrow$  repeatedly to select a speaker, then press  $\odot$  to return to step 2 in “Confirming/saving the measurement results”.**

Display	Explanation
■■■* IN	The speaker is in phase.
■■■* OUT	The speaker is out of phase. The “+” and “-” terminals of the speaker may be connected the other way around. However, depending on the speakers, “■■■* OUT” appears on the display even though the speakers are connected properly. This is because of the speakers’ specifications. In this case, you can continue to use the receiver.

\* ■■■ represent a speaker channel

FL	Front left
FR	Front right
C	Center
SL	Surround left
SR	Surround right
SB	Surround back
SW	Sub woofer

### Tip

Depending on the position of the sub woofer, the measurement results for polarity may vary. However, there will be no problems even if you continue to use the receiver with that value.

## A. CAL menu parameters

You can use the A. CAL menu to make settings for the Auto Calibration function to suit your preference.

Select “8-A. CAL” in the amplifier menus. For details on adjusting the parameters, see “Navigating through menus” (page 39) and “Overview of the menus” (page 40).

### ■ AUTO CAL (Auto Calibration on/off)

- A.CAL NO  
The Auto Calibration function is turned off.
- A.CAL YES  
The Auto Calibration function start.

### ■ CAL TYPE (Calibration type)\*

- ENGINEER  
Sets the frequency characteristics to a set that matches that of the Sony listening room standard.
- FLAT  
Makes the measurement of frequency from each speaker flat.
- FRT REF  
Adjusts the characteristics of all the speakers to match the characteristics of the front speaker.

### ■ CAL LOAD (Preset measurement loading)\*

- LOAD YES  
Select this when you want to load the saved Auto Calibration result.
- LOAD NO  
Select this when you do not want to load the saved Auto Calibration result.

\* You can select this parameter only when you have performed the Auto Calibration and saved the settings.

## 8: Adjusting the speaker levels and balance (TEST TONE)

You can adjust the speaker levels and balance while listening to the test tone from your listening position.

### Tip

The receiver employs a test tone with a frequency centered at 800 Hz.

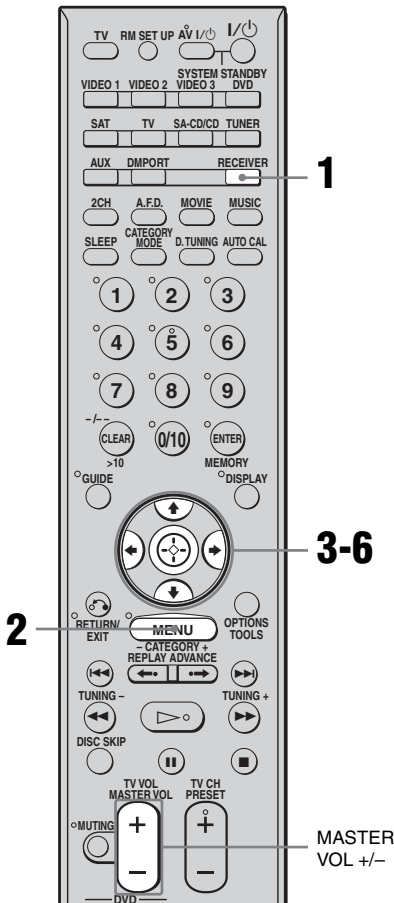

### 1 Press RECEIVER.

The RECEIVER indicator lights up and receiver operation is activated.

### 2 Press MENU.

“1-LEVEL” appears on the display.

### 3 Press or to enter the menu.

### 4 Press / repeatedly to select “T. TONE”.

### 5 Press or to enter the parameter.

### 6 Press / repeatedly to select “T. TONE Y”.

The test tone is output from each speaker in sequence as follows:

Front left → Center → Front right → Surround right → Surround back → Surround left → Sub woofer

### 7 Adjust the speaker levels and balance using the LEVEL menu so that the level of the test tone sounds the same from each speaker.

For details, see “Adjusting the level (LEVEL menu)” (page 43).

### Tips

- To adjust the level of all speakers at the same time, press MASTER VOL +/- . You can also use MASTER VOLUME on the receiver.
- The adjusted value are shown on the display during adjustment.

### 8 Repeat steps 1 to 6 to select “T. TONE N”.

You can also press any input buttons. The test tone turns off.

## When a test tone is not output from the speakers

- The speaker cords may not be connected securely.
- The speaker cords may have the short-circuit problem.

### Note

The test tone does not work when ANALOG DIRECT is selected.

## Playback

## Selecting a component

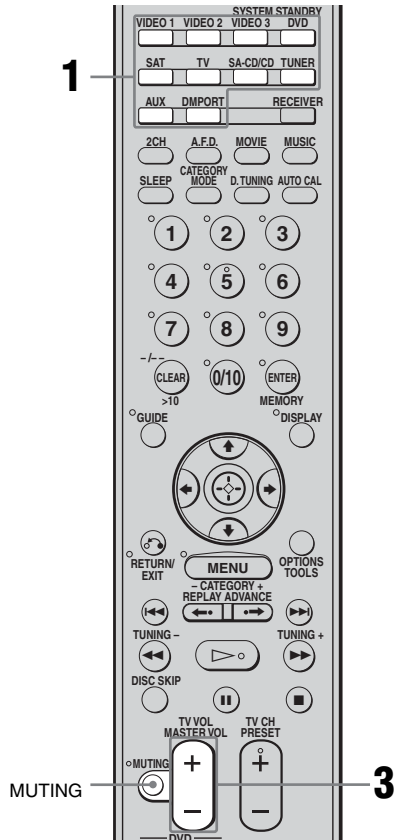

### 1 Press the input button to select a component.

You can also use INPUT SELECTOR on the receiver.

*continued*

35<sup>US</sup>

The selected input appears on the display.

<b>Selected input [Display]</b>	<b>Components that can be played back</b>
VIDEO 1 [VIDEO 1]	VCR, etc., connected to the VIDEO 1 jack
VIDEO 2 [VIDEO 2/BD]*	Blu-ray disc player, etc., connected to the VIDEO 2/BD jack
VIDEO 3 [VIDEO 3/ PORTABLE AV]*	Camcorder, video game, etc., connected to the VIDEO 3 IN/ PORTABLE AV IN jack
DVD [DVD]	DVD player, etc., connected to DVD jack
SAT [SAT]	Satellite tuner, set-top box, etc., connected to SAT jack
TV [TV]	TV, etc., connected to TV jack
SA-CD/CD [SA-CD/CD/ CD-R]*	Super Audio CD player, CD player, etc., connected to the SA-CD/ CD/CD-R jack
TUNER [FM or AM band]	Built-in radio tuner.
TUNER [XM RADIO]	For details, see page 63.
DMPORT [DMPORT]	DIGITAL MEDIA PORT adapter connected to DMPORT jack

\* “VIDEO 2/BD”, “VIDEO 3/PORTABLE AV” and “SA-CD/CD/CD-R” scroll across the display, then “VIDEO 2”, “VIDEO 3” and “SA-CD/CD” appear respectively.

## **2 Turn on the component and start playback.**

## **3 Press MASTER VOL +/- to adjust the volume.**

You can also use MASTER VOLUME on the receiver.

## **To mute the sound**

Press MUTING.

The muting function will be canceled when you do the following.

- Press MUTING again.
- Increase the volume.
- Turn off the receiver.

## **To avoid damaging your speakers**

Before you turn off the receiver, be sure to turn down the volume level.

# Listening/Watching a component

## Listening to a Super Audio CD/CD

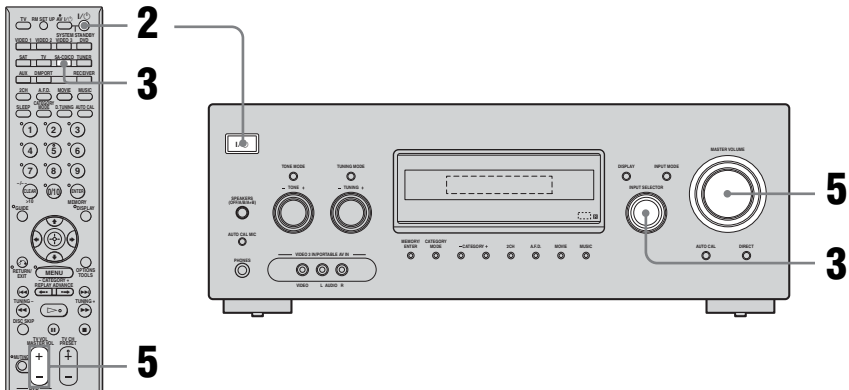

### Notes

- The operation is described for a Sony Super Audio CD player.
- Refer to the operating instructions supplied with the Super Audio CD player or CD player.

### Tips

- You can select the sound field to suit the music. Refer to page 54 for details.  
Recommended sound fields:  
Classical: HALL  
Jazz: JAZZ  
Live concert: CONCERT
- You can listen to the sound that was recorded in the 2 channel format from all speakers (multi channel). Refer to page 52 for details.

**1** Turn on the Super Audio CD player/CD player, then place the disc on the tray.

**2** Turn on the receiver.

**3** Press SA-CD/CD.

You can also use INPUT SELECTOR on the receiver to select "SA-CD/CD/CD-R".

**4** Playback the disc.

**5** Adjust to a suitable volume.

**6** After you have finished listening to the Super Audio CD/CD, eject the disc and turn off the receiver and Super Audio CD player/CD player.

## Watching a DVD

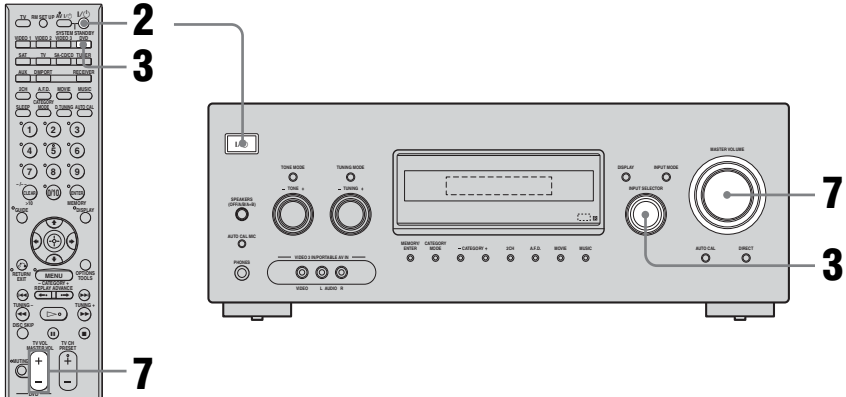

### Notes

- Refer to the operating instructions supplied with the TV and DVD player.
- Check the following if you cannot listen to multi channel sound.
  - Be sure the audio source corresponds to the multi channel format.
  - Be sure this receiver is connected to the DVD player via a digital connection.
  - Be sure the digital audio output of the DVD player is set up properly.

### Tips

- Select the sound format of the disc to be played, if necessary.
- You can select the sound field to suit the movie/music. Refer to page 54 for details.  
Recommended sound fields:  
Movie: C. ST. EX  
Music: CONCERT

**1** Turn on the TV and DVD player.

**2** Turn on the receiver.

**3** Press DVD.

You can also use INPUT SELECTOR on the receiver to select “DVD”.

**4** Switch the input of the TV so that an image of the DVD is displayed.

**5** Set up the DVD player.

Refer to “Quick Setup Guide” supplied with the receiver.

**6** Playback the disc.

**7** Adjust to a suitable volume.

**8** After you have finished watching the DVD, eject the disc and turn off the receiver, TV and DVD player.

## Amplifier Operations

# Navigating through menus

By using the amplifier menus, you can make various adjustments to customize the receiver.



### 1 Press RECEIVER.

The RECEIVER indicator lights up and receiver operation is activated.

### 2 Press MENU.

“1-LEVEL” appears on the display.

### 3 Press $\uparrow/\downarrow$ repeatedly to select the menu you want.

### 4 Press $\leftarrow/\rightarrow$ to enter the menu.

### 5 Press $\uparrow/\downarrow$ repeatedly to select the parameter you want to adjust.

### 6 Press $\leftarrow/\rightarrow$ or $\rightarrow$ to enter the parameter.

### 7 Press $\uparrow/\downarrow$ repeatedly to select the setting you want.

The setting is entered automatically.

### To return to the previous display

Press  $\leftarrow$ .

### To exit the menu

Press MENU.

However, if the RECEIVER button is light off, press RECEIVER and then press MENU.

### Note

Some parameters and settings may appear dimmed on the display. This means that they are either unavailable or fixed and unchangeable.

## Overview of the menus

The following options are available in each menu. For details on navigating through menus, see page 39.

Menu [Display]	Parameters [Display]	Settings	Initial setting
LEVEL (43) [1-LEVEL]	Test tone <sup>a)</sup> [T. TONE]	T. TONE N, T. TONE Y	T. TONE N
	Front speaker balance <sup>a)</sup> [FRT BAL]	BAL. L +1 to BAL. L +10, BALANCE, BAL. R +1 to BAL. R +10	BALANCE
	Center speaker level [CNT LVL]	CNT -10 dB to CNT +10 dB (1 dB step)	CNT 0 dB
	Surround left speaker level [SL LVL]	SUR L -10 dB to SUR L +10 dB (1 dB step)	SUR L 0 dB
	Surround right speaker level [SR LVL]	SUR R -10 dB to SUR R +10 dB (1 dB step)	SUR R 0 dB
	Surround back speaker level [SB LVL]	SB -10 dB to SB +10 dB (1 dB step)	SB 0 dB
	Sub woofer level [SW LVL]	SW -10 dB to SW +10 dB (1 dB step)	SW 0 dB
	Dynamic range compressor <sup>a)</sup> [D. RANGE]	COMP. OFF, COMP. STD, COMP. MAX	COMP. OFF
EQ (44) [2-EQ]	Equalizer on/off <sup>a)</sup> [EQ]	EQ ON, EQ OFF	EQ OFF
	Front speaker bass level [BASS LVL]	BASS -10 dB to BASS +10 dB (0.5 dB step)	BASS 0 dB
	Front speaker treble level [TRE LVL]	TRE -10 dB to TRE +10 dB (0.5 dB step)	TRE 0 dB
SURROUND (44) [3-SUR]	Sound field selection <sup>a)</sup> [S.F. SELCT]	2CH ST., A.F.D. AUTO, DOLBY PL, PLII MV, PLII MS, PLII GM, PLIIX MV, PLIIX MS, PLIIX GM, NEO6 CIN, NEO6 MUS, NEURAL, MULTI ST., C.ST.EX A, C.ST.EX B, C.ST.EX C, PORTABLE, HALL, JAZZ, CONCERT	A.F.D. AUTO for: VIDEO 1, VIDEO 2/BD, VIDEO 3/ PORTABLE AV, DVD, SAT; 2CH ST. for: TV, SA-CD/CD/ CD-R, FM or AM band, XM RADIO, DMPORT
	Surround back decoding mode <sup>a)</sup> [SB DEC]	SB OFF, SB AUTO, SB ON	SB AUTO
	Effect level <sup>a)</sup> [EFFECT]	EFCT. MIN, EFCT. STD, EFCT. MAX	EFCT. STD



<b>Menu [Display]</b>	<b>Parameters [Display]</b>	<b>Settings</b>	<b>Initial setting</b>
TUNER (46) [4-TUNER]	FM station receiving mode <sup>a)</sup> [FM MODE]	FM AUTO, FM MONO	FM AUTO
	Naming preset stations <sup>a)</sup> [NAME IN]		
AUDIO (46) [5-AUDIO]	Digital audio input decoding priority <sup>a)</sup> [DEC. PRI.]	DEC. PCM, DEC. AUTO	DEC. AUTO for: VIDEO 1, 2, 3, DVD, SAT, TV; DEC. PCM for: SA-CD/CD/CD-R
	Digital broadcast language selection <sup>a)</sup> [DUAL]	DUAL M/S, DUAL M, DUAL S, DUAL M+S	DUAL M
	Synchronizes audio with video output <sup>a)</sup> [A.V. SYNC.]	A.V. SYNC. 0 to A.V. SYNC. 20	A.V. SYNC. 0
	Digital Assign [D. ASSIGN]	VD1- VD1, VD1- VD2, VD1- VD3, VD1- DVD, VD1- TV, VD1- CD, DVD- VD1, DVD- VD2, DVD- VD3, DVD- DVD, DVD- SAT, DVD- TV, DVD- CD, SAT- VD2, SAT- VD3, SAT- DVD, SAT- SAT, SAT- TV, SAT- CD	VD1- VD1 for: VD1 OPT; DVD- DVD for: DVD COAX; SAT- SAT for: SAT OPT
	Naming inputs <sup>a)</sup> [NAME IN]		
VIDEO (47) [6-VIDEO]	DIGITAL MEDIA PORT video assign <sup>a)</sup> [DMPORT V.]	-NONE, -VIDEO1, -VIDEO3, -DVD, -SAT	-NONE
	HDMI AUDIO <sup>a)b)</sup> [AUDIO]	AMP, TV+AMP	AMP
	HDMI CONTROL <sup>a)b)</sup> [CONTROL]	CTRL ON, CTRL OFF	CTRL OFF
	Naming inputs <sup>a)</sup> [NAME IN]		

continued

<b>Menu [Display]</b>	<b>Parameters [Display]</b>	<b>Settings</b>	<b>Initial setting</b>
SYSTEM (48) [7-SYSTEM]	Sub woofer <sup>a)</sup> [SW SPK]	NO, YES	YES
	Front speakers <sup>a)d)</sup> [FRT SPK]	SMALL, LARGE	LARGE
	Center speaker <sup>a)d)</sup> [CNT SPK]	NO, SMALL, LARGE	LARGE
	Surround speakers <sup>a)d)</sup> [SUR SPK]	NO, SMALL, LARGE	LARGE
	Surround back speaker <sup>a)</sup> [SB SPK]	NO, YES	YES
	Front left speaker distance <sup>a)c)</sup> [FL DIST.]	DIST. 3 ft. to DIST. 22 ft. (1 ft. step)	DIST. 9 ft.
	Front right speaker distance <sup>a)c)</sup> [FR DIST.]	DIST. 3 ft. to DIST. 22 ft. (1 ft. step)	DIST. 9 ft.
	Center speaker distance <sup>a)c)</sup> [CNT DIST.]	DIST. 3 ft. to DIST. 22 ft. (1 ft. step)	DIST. 9 ft.
	Surround left speaker distance <sup>a)c)</sup> [SL DIST.]	DIST. 3 ft. to DIST. 22 ft. (1 ft. step)	DIST. 9 ft.
	Surround right speaker distance <sup>a)c)</sup> [SR DIST.]	DIST. 3 ft. to DIST. 22 ft. (1 ft. step)	DIST. 9 ft.
	Surround back speaker distance <sup>a)c)</sup> [SB DIST.]	DIST. 3 ft. to DIST. 22 ft. (1 ft. step)	DIST. 9 ft.
	Sub woofer distance <sup>a)</sup> [SW DIST.]	DIST. 3 ft. to DIST. 22 ft. (1 ft. step)	DIST. 9 ft.
	Surround speaker position <sup>a)</sup> [SUR POS.]	BEHD/HI, BEHD/LO, SIDE/HI, SIDE/LO	SIDE/LOW
	Speaker crossover frequency <sup>a)d)</sup> [CRS. FREQ]	CRS > 40 Hz to CRS > 160 Hz (10 Hz step)	CRS > 100 Hz
	Brightness of the display <sup>a)</sup> [DIMMER]	0% dim, 40% dim, 70% dim	0% dim
	AUTO CALIBRATION (33) [8-A. CAL]	Auto Calibration <sup>a)</sup> [AUTO CAL]	A. CAL NO, A. CAL YES
Calibration type <sup>a)</sup> [CAL TYPE]		ENGINEER, FLAT, FRT REF	FLAT
Calibration load <sup>a)c)</sup> [CAL LOAD]		LOAD NO, LOAD YES	LOAD YES

<sup>a)</sup>For details, refer to the page in the parentheses.

<sup>b)</sup>When you select this parameter, the “HDMI” indicator flashes in the display.

<sup>c)</sup>When you set “CAL LOAD” in A. CAL menu to “LOAD YES”, the setting is displayed as “■■■■■■” and you can adjust the setting in 1 inch increment.

<sup>d)</sup>This parameter is only available when at least one speaker is set to “SMALL” and “CAL LOAD” is set to “LOAD YES” in A. CAL menu.

# Adjusting the level

## (LEVEL menu)

You can use the LEVEL menu to adjust the balance and level of each speaker. These settings are applied to all sound fields. Select “1-LEVEL” in the amplifier menus. For details on adjusting the parameters, see “Navigating through menus” (page 39) and “Overview of the menus” (page 40).

## LEVEL menu parameters

### ■ T. TONE (Test tone)

Lets you adjust the speaker levels and balance while listening to the test tone from your listening position. For details, see “8: Adjusting the speaker levels and balance (TEST TONE)” on page 34.

### ■ FRT BAL (Front speaker balance)

Lets you adjust the balance between front left and right speakers.

### ■ CNT LVL (Center speaker level)

### ■ SL LVL (Surround left speaker level)

### ■ SR LVL (Surround right speaker level)

### ■ SB LVL (Surround back speaker level)

### ■ SW LVL (Sub woofer level)

### ■ D. RANGE (Dynamic range compressor)

Lets you compress the dynamic range of the sound track. This may be useful when you want to watch movies at low volumes late at night. Dynamic range compression is possible with Dolby Digital sources only.

- COMP. OFF  
The dynamic range is not compressed.
- COMP. STD  
The dynamic range is compressed as intended by the recording engineer.
- COMP. MAX  
The dynamic range is compressed dramatically.

### Tip

Dynamic range compressor lets you compress the dynamic range of the soundtrack based on the dynamic range information included in the Dolby Digital signal.

“COMP. STD” is the standard setting, but it only enacts light compression. Therefore, we recommend using the “COMP. MAX” setting. This greatly compresses the dynamic range and lets you view movies late at night at low volumes. Unlike analog limiters, the levels are predetermined and provide a very natural compression.

## Adjusting the equalizer (EQ menu)

You can use the EQ menu to adjust the tonal quality (bass/treble level) of the front speakers.

Select “2-EQ” in the amplifier menus. For details on adjusting the parameters, see “Navigating through menus” (page 39) and “Overview of the menus” (page 40).

### EQ menu parameters

#### ■ EQ (Equalizer on/off)

Lets you turn the equalizer on or off.

- EQ ON  
The equalizer is turned on.
- EQ OFF  
The equalizer is turned off.

#### ■ BASS LVL (Front speaker bass level)\*

#### ■ TRE LVL (Front speaker treble level)\*

\* You can adjust the front speaker bass and treble level with TONE MODE and TONE +/- on the receiver.

## Settings for the surround sound (SUR menu)

You can use the SUR menu to select the sound field you want for your listening pleasure.

Select “3-SUR” in the amplifier menus. For details on adjusting the parameters, see “Navigating through menus” (page 39) and “Overview of the menus” (page 40).

### SUR menu parameters

#### ■ S.F. SELCT (Sound field selection)

Lets you select the sound field you want. For details, see “Enjoying Surround Sound” (page 52).

#### Note

The receiver lets you apply the last selected sound field to an input whenever it is selected (Sound Field Link). For example, if you select HALL for the SA-CD/CD/CD-R input, then change to a different input and then return to SA-CD/CD/CD-R, HALL will automatically be applied again.

#### ■ SB DEC (Surround back decoding mode)

Lets you select the surround back decoding mode. For details, see “Using the surround back decoding mode” (page 45).

#### ■ EFFECT (Effect level)

Lets you adjust the “presence” of the surround effect for sound fields selected with the MOVIE or MUSIC buttons and for “HP THEA” sound field.

- EFCT. MIN  
The surround effect is minimum.
- EFCT. STD  
The surround effect is standard.
- EFCT. MAX  
The surround effect is maximum.

## Using the surround back decoding mode

### (SUR BACK DECODING)

By decoding the surround back signal of DVD software (etc.) recorded in Dolby Digital Surround EX, DTS-ES Matrix, DTS-ES Discrete 6.1, etc., format, you can enjoy the surround sound intended by the filmmakers. Select the surround back decoding mode using “SB DEC” in the SUR menu (page 44).

### Types of the surround back decoding functions

#### ■ SB OFF

Surround back decoding is not performed.

#### ■ SB AUTO

When the input stream contains the 6.1 channel decode flag<sup>a)</sup>, the appropriate decoding is performed on the surround back signal.

Input stream	Output channel	Surround back decoding
Dolby Digital 5.1	5.1	—
Dolby Digital Surround EX <sup>b)</sup>	6.1	Matrix decoder that conforms to Dolby Digital EX
DTS 5.1	5.1	—
DTS-ES Matrix 6.1 <sup>c)</sup>	6.1	DTS Matrix decoding
DTS-ES Discrete 6.1 <sup>d)</sup>	6.1	DTS Discrete decoding

#### ■ SB ON

To decode the surround back signal regardless of the 6.1 channel decode flag<sup>a)</sup>, Dolby Digital EX is applied when the output channel is 6.1.

Input stream	Output channel	Surround back decoding
Dolby Digital 5.1	6.1	Matrix decoder that conforms to Dolby Digital EX
Dolby Digital Surround EX <sup>b)</sup>	6.1	Matrix decoder that conforms to Dolby Digital EX
DTS 5.1	6.1	Matrix decoder that conforms to Dolby Digital EX
DTS-ES Matrix 6.1 <sup>c)</sup>	6.1	Matrix decoder that conforms to Dolby Digital EX
DTS-ES Discrete 6.1 <sup>d)</sup>	6.1	Matrix decoder that conforms to Dolby Digital EX

<sup>a)</sup> A 6.1 channel decode flag is information recorded in software such as DVDs.

<sup>b)</sup> A Dolby Digital DVD that includes a Surround EX flag. The Dolby Corporation web page can help you distinguish Surround EX films.

<sup>c)</sup> Software encoded with a flag to denote it has both DTS-ES Matrix and 5.1 channel signals.

<sup>d)</sup> Software encoded with both 5.1 channel signals and an extension stream designed for returning those signals to 6.1 discrete channels. Discrete 6.1 channel signals are DVD specific signals not used in movie theaters.

#### Notes

- There may be no sound from the surround back speaker in Dolby Digital EX mode. Some discs have no Dolby Digital Surround EX flag even though the packages have Dolby Digital EX logos. In this case, select “SB ON”.
- You can select the surround back decoding mode only when A.F.D. mode is selected except for Dolby Pro Logic IIx mode.

## Settings for the tuner

### (TUNER menu)

You can use the TUNER menu to set the FM station receiving mode and to name preset stations.

Select “4-TUNER” in the amplifier menus. For details on adjusting the parameters, see “Navigating through menus” (page 39) and “Overview of the menus” (page 40).

### TUNER menu parameters

#### ■ FM MODE (FM station receiving mode)

- FM AUTO  
This receiver will decode the signal as stereo signal when the radio station is broadcast in stereo.
- FM MONO  
This receiver will decode the signal as mono signal regardless of the broadcast signal.

#### ■ NAME IN (Naming preset stations)

Lets you set the name of preset stations. For details, see “Naming preset stations” (page 62).

## Settings for the audio

### (AUDIO menu)

You can use the AUDIO menu to make settings for the audio to suit your preference. Select “5-AUDIO” in the amplifier menus. For details on adjusting the parameters, see “Navigating through menus” (page 39) and “Overview of the menus” (page 40).

### AUDIO menu parameters

#### ■ DEC. PRI. (Digital audio input decoding priority)

Lets you specify the input mode for the digital signal input to the DIGITAL IN and HDMI IN jacks.

- DEC. PCM  
PCM signals are given priority (to prevent interruption when playback starts). However, when other signals are input, there may be no sound depending on the format. In this case, set to “DEC. AUTO”.  
When signals from the HDMI IN jack are selected, only PCM signals are output from the connected player. When signals in any other format are received, set this item to “DEC. AUTO”.
- DEC. AUTO  
Automatically switches the input mode between DTS, Dolby Digital, or PCM.

#### Note

When set to “DEC. AUTO” and the sound from the digital audio jacks (for a CD, etc.) is interrupted when playback starts, set to “DEC. PCM”.

## ■ DUAL (Digital broadcast language selection)

Lets you select the language you want to listen to during digital broadcast. This feature only functions for Dolby Digital sources.

- DUAL M/S (Main/Sub)  
Sound of the main language will be output through the front left speaker and sound of the sub language will be output through the front right speaker simultaneously.
- DUAL M (Main)  
Sound of the main language will be output.
- DUAL S (Sub)  
Sound of the sub language will be output.
- DUAL M+S (Main + Sub)  
Mixed sound of both the main and sub languages will be output.

## ■ A.V. SYNC. (Synchronizes audio with video output)

Lets you delay the audio output so that the time gap between the audio output and visual display is minimized. You can adjust from 0 (0 ms) to 20 (200 ms) in 1 (10 ms) steps.

### Notes

- This parameter is useful when you use a large LCD or plasma monitor or a projector.
- This parameter is not valid when
  - the multi-channel PCM signals are received via an HDMI IN jack.
  - ANALOG DIRECT function is being used.

## ■ D. ASSIGN (Digital audio input assignment)

Lets you assign the digital audio input to other input source. For details, see “Listening to digital sound from other inputs (DIGITAL ASSIGN)” (page 75).

## ■ NAME IN (Naming inputs)

Lets you set the name of inputs. For details, see “Naming inputs” (page 76).

# Settings for the video (VIDEO menu)

You can use the VIDEO menu to make various adjustments for HDMI settings, assign the composite video input to DMPORT input and to name inputs.

Select “6-VIDEO” in the amplifier menus. For details on adjusting the parameters, see “Navigating through menus” (page 39) and “Overview of the menus” (page 40).

## VIDEO menu parameters

### ■ DMPORT V. (DIGITAL MEDIA PORT video assign)

Lets you assign the composite video input to DMPORT input so that you can view the images in the TV. For details, see “Watching a connected component through DMPORT connection” (page 74).

### ■ AUDIO (HDMI AUDIO)\*

Lets you set the HDMI audio output from the playback component connected to the receiver via an HDMI connection.

- AMP  
The HDMI audio signals from the playback component is only output to speakers connected to the receiver. Multi-channel sound can be played back as it is.

### Note

Audio signals are not output from the TV’s speakers.

- **TV+AMP**

The sound is output from TV's speaker and the speakers connected to the receiver.

### Notes

- The sound quality of the playback component depends on the TV's sound quality, such as the number of channels, and the sampling frequency, etc. When the TV has stereo speakers, the sound output from the receiver is also stereo as that of the TV, even if you play multi-channel software.
- When you connect the receiver to a video component (projector, etc.), sound may not be output from the receiver. In this case, select "AMP".

### ■ CONTROL (HDMI CONTROL)\*

Lets you turn the HDMI CONTROL function on or off.

For details, refer to the HDMI CONTROL Guide supplied with the receiver.

### ■ NAME IN (Naming inputs)

Lets you set the name of inputs. For details, see "Naming inputs" (page 76).

\* When you select this parameter, the "HDMI" indicator flashes in the display.

## Settings for the system (SYSTEM menu)

You can use the SYSTEM menu to set the size and distance of the speakers connected to this system.

Select "7-SYSTEM" in the amplifier menus. For details on adjusting the parameters, see "Navigating through menus" (page 39) and "Overview of the menus" (page 40).

### SYSTEM menu parameters

#### ■ SW SPK (Sub woofer)

- NO  
If you have not connected a sub woofer, select "NO". This activates the bass redirection circuitry and outputs the LFE signals from other speakers.
- YES  
If you have connected a sub woofer, select "YES".

#### Tip

In order to take full advantage of the Dolby Digital bass redirection circuitry, we recommend setting the sub woofer's cut off frequency as high as possible.

#### ■ FRT SPK (Front speakers)

- SMALL  
If the sound is distorted, or you feel a lack of surround effects when using multi channel surround sound, select "SMALL" to activate the bass redirection circuitry and output the front channel bass frequencies from the sub woofer. When the front speakers are set to "SMALL", the center and surround speakers are also automatically set to "SMALL" (unless previously set to "NO").
- LARGE  
If you connect large speakers that will effectively reproduce bass frequencies, select "LARGE". Normally, select "LARGE". When the sub woofer is set to "NO", the front speakers are automatically set to "LARGE".



### ■ CNT SPK (Center speaker)

- NO

If you have not connected a center speaker, select “NO”. The sound of the center channel will be output from the front speakers.

- SMALL

If the sound is distorted, or you feel a lack of surround effects when using multi channel surround sound, select “SMALL” to activate the bass redirection circuitry and output the center channel bass frequencies from the front speakers (if set to “LARGE”) or sub woofer.

- LARGE

If you connect a large speaker that will effectively reproduce bass frequencies, select “LARGE”. Normally, select “LARGE”. However, if the front speakers are set to “SMALL”, you cannot set the center speaker to “LARGE”.

### ■ SUR SPK (Surround speakers)

The surround back speaker will be set to the same setting.

- NO

If you have not connected surround speakers, select “NO”.

- SMALL

If the sound is distorted, or you feel a lack of surround effects when using multi channel surround sound, select “SMALL” to activate the bass redirection circuitry and output the surround channel bass frequencies from the sub woofer or other speaker that is set to “LARGE”.

- LARGE

If you connect large speakers that will effectively reproduce bass frequencies, select “LARGE”. Normally, select “LARGE”. However, if the front speakers are set to “SMALL”, you cannot set the surround speakers to “LARGE”.

### ■ SB SPK (Surround back speaker)

When the surround speakers are set to “NO”, the surround back speaker is also automatically set to “NO” and the setting cannot be changed.

- NO

If you have not connected a surround back speaker, select “NO”.

- YES

If you connect a surround back speaker, select “YES”.

#### Tip

The “LARGE” and “SMALL” settings for each speaker determine whether the internal sound processor will cut the bass signal from that channel. When the bass is cut from a channel, the bass redirection circuitry sends the corresponding bass frequencies to the sub woofer or other “LARGE” speakers.

However, since bass sounds have a certain amount of directionality, it is best not to cut them, if possible. Therefore, even when using small speakers, you can set them to “LARGE” if you want to output the bass frequencies from that speaker. On the other hand, if you are using a large speaker, but prefer not to have bass frequencies output from that speaker, set it to “SMALL”.

If the overall sound level is lower than you prefer, set all speakers to “LARGE”. If there is not enough bass, you can use the equalizer to boost the bass levels. For details, see page 40.

### ■ FL DIST. (Front left speaker distance)

### ■ FR DIST. (Front right speaker distance)

Lets you set the distance from your listening position to the front speakers (A). If both front speakers are not placed an equal distance from your listening position, set the distance to the closest speaker.

## With only one surround back speaker

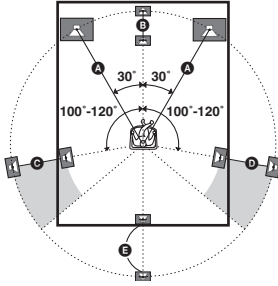

### ■ CNT DIST. (Center speaker distance)

Lets you set the distance from your listening position to the center speaker.

### ■ SL DIST. (Surround left speaker distance)

### ■ SR DIST. (Surround right speaker distance)

Lets you set the distance from your listening position to the surround speakers. If both surround speakers are not placed an equal distance from your listening position, set the distance to the closest speaker.

### ■ SB DIST. (Surround back speaker distance)<sup>a)</sup>

Lets you set the distance from your listening position to the surround back speaker.

### ■ SW DIST. (Sub woofer distance)

Lets you set the distance from your listening position to the sub woofer.

## Tips

- If you set up speakers using the Auto Calibration function, you can adjust the speaker distance in 1 inch increment.
- The distance between the center speaker and the listening position **B** cannot be more than 1.5 meters (5 feet) closer than the one between the listening position and the front speaker **A**. Place the speakers so that the difference in the length of **B** in the following diagram is no more than 1.5 meters (5 feet) closer than the length of **A**. Example: Adjust the distance **B** to 4.5 meters (15 feet) or more when the distance **A** is 6 meters (20 feet).

Also, the distance between the surround speakers/surround back speaker and the listening position **C** cannot be more than 4.5 meters (15 feet) closer than the distance between the listening position and the front speakers **A**. Place the speakers so that the difference in the length of **C** in the following diagram is no more than 4.5 meters (15 feet) closer than the length of **A**.

Example: Adjust the distance **C** to 1.5 meters (5 feet) or more when the distance **A** is 6 meters (20 feet).

This is important because incorrect speaker placement is not conducive to the enjoyment of surround sound. Place note that placing the speakers closer than the required will cause a delay in the output of the sound from that speaker. In other words, the speaker will sound like it is farther away.

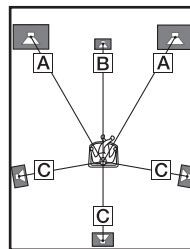

## ■ SUR POS. (Surround speaker position)

Lets you specify the location of your surround speakers for proper implementation of the surround effects in the Cinema Studio EX modes (page 55). This setup item is not available when the surround speakers are set to “NO” (page 42).

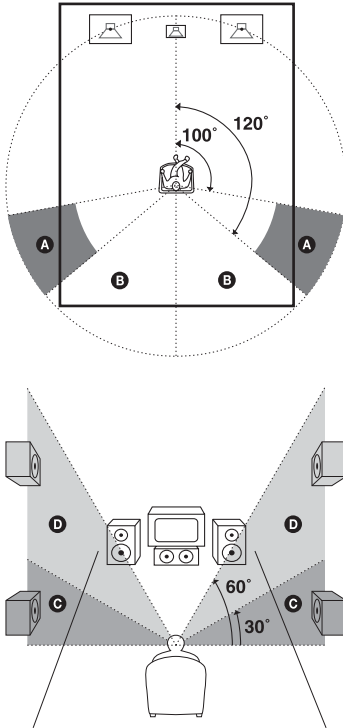

- **BEHD/HI**  
Select if the location of your surround speakers corresponds to sections **B** and **D**.
- **BEHD/LO**  
Select if the location of your surround speakers corresponds to sections **B** and **C**.
- **SIDE/HI**  
Select if the location of your surround speakers corresponds to sections **A** and **D**.
- **SIDE/LO**  
Select if the location of your surround speakers corresponds to sections **A** and **C**.

## Tip

Surround speaker position is designed specifically for implementation of the Cinema Studio EX modes. For other sound fields, speaker position is not so critical.

Those sound fields were designed under the premise that the surround speakers would be located behind the listening position, but presentation remains fairly consistent even with the surround speakers positioned at a rather wide angle. However, if the speakers are pointing toward the listener from the immediate left and right of the listening position, the surround effects become unclear unless set to “SIDE/LO” or “SIDE/HI”.

Nevertheless, each listening environment has many variables, such as wall reflections, and you may obtain better results using “BEHD/HI” if your speakers are located high above the listening position, even if they are located to the immediate left and right.

Therefore, although it may result in a setting contrary to the above explanation, we recommend that you playback multi channel surround encoded software and select the setting that provides a good sense of spaciousness and that best succeeds in forming a cohesive space between the surround sound from the surround speakers and the sound of the front speakers. If you are not sure which sounds best, select “BEHD/LO” or “BEHD/HI” and then use the speaker distance parameter and speaker level adjustments to obtain proper balance.

## ■ CRS. FREQ (Speaker crossover frequency)

Lets you set the bass crossover frequency of the speakers that have been set to “SMALL” on the SYSTEM menu. This setup item is only available when at least one speaker is set to “SMALL” and the corresponding speaker indicator flashes on the display.

## Note

When “CAL LOAD” is set to “LOAD YES” in the A. CAL menu, the parameter cannot be adjusted.

## ■ DIMMER (Brightness of the display)

Lets you adjust the brightness in 3 steps.

# Enjoying Dolby Digital and DTS surround sound (AUTO FORMAT DIRECT)

The Auto Format Direct (A.F.D.) mode allows you to listen to higher fidelity sound and select the decoding mode for listening to a 2 channel stereo sound as multi channel sound.

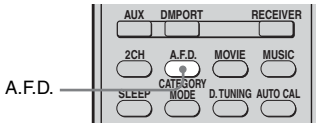

**Press A.F.D. repeatedly to select the sound field you want.**

For details, see “Types of A.F.D. mode” (page 53).

## Types of A.F.D. mode

Decoding mode	A.F.D. mode [Display]	Multi channel audio after decoding	Effect
(Detecting automatically)	A.F.D. AUTO [A.F.D. AUTO]	(Detecting automatically)	Presents the sound as it was recorded/ encoded without adding any surround effects. However, this receiver will generate a low frequency signal for output to the sub woofer when there is no LFE signals.
Dolby Pro Logic	PRO LOGIC [DOLBY PL]	4 channel	Performs Dolby Pro Logic decoding. The source recorded in 2 channel format is decoded into 4.1 channels.
Dolby Pro Logic II	PRO LOGIC II MOVIE [PLII MV]	5 channel	Performs Dolby Pro Logic II Movie mode decoding. This setting is ideal for movies encoded in Dolby Surround. In addition, this mode can reproduce sound in 5.1 channel for watching videos of overdubbed or old movies.
	PRO LOGIC II MUSIC [PLII MS]	5 channel	Performs Dolby Pro Logic II Music mode decoding. This setting is ideal for normal stereo sources such as CDs.
	PRO LOGIC II GAME [PLII GM]	5 channel	Performs Dolby Pro Logic II Game mode decoding. This setting is ideal for game softwares.
Dolby Pro Logic IIx	PRO LOGIC IIx MOVIE [PLIIX MV]	6 channel	Performs Dolby Pro Logic IIx Movie mode decoding. This setting expands Dolby Pro Logic II Movie or Dolby Digital 5.1 to discrete 6.1 movie channels.
	PRO LOGIC IIx MUSIC [PLIIX MS]	6 channel	Performs Dolby Pro Logic IIx Music mode decoding. This setting is ideal for normal stereo sources such as CDs.
	PRO LOGIC IIx GAME [PLIIX GM]	6 channel	Performs Dolby Pro Logic IIx Game mode decoding.
Neo:6	Neo:6 Cinema [NEO6 CIN]	6 channel	Performs DTS Neo:6 Cinema mode decoding.
	Neo:6 Music [NEO6 MUS]	6 channel	Performs DTS Neo:6 Music mode decoding. This setting is ideal for normal stereo sources such as CDs.
Neural Surround	NEURAL SURROUND [NEURAL]	6 channel	Outputs signals in the multi-channel surround format when the receiver receives PCM signals of 2 channels or an XM Radio Surround broadcast. When the receiver receives a stereo broadcast, the stereo sound is emphasized.
(Multi Stereo)	MULTI STEREO [MULTI ST.]	(Multi Stereo)	Outputs 2 channel left/right signals from all speakers. However, sound may not be output from certain speakers depending on the speaker settings.

*continued*

## If you connect a sub woofer

This receiver will generate a low frequency signal for output to the sub woofer when there is no LFE signal, which is a low-pass sound effect output from a sub woofer to a 2 channel signal. However, the low frequency signal is not generated for “NEO6 CIN” or “NEO6 MUS” when all speakers are set to “LARGE”.

### Notes

- This function does not work in the following cases.
  - Input signals of which the sampling frequency is more than 48 kHz are being received.
  - The multi-channel PCM signals are received via an HDMI IN jack.
- Dolby Pro Logic IIx decoding does not function for signals with a sampling frequency of more than 48 kHz.
- NEURAL SURROUND is activated as a PCM signal of which the sampling frequency is less than 48 kHz or a 2 channel analog signal. The NEURAL SURROUND processing will be turned off automatically when another type of signal is input. The beginning of the sound may be dropped out when the SURROUND processing is turned on/off.

### Tip

When a multi channel signal is input, only Dolby Pro Logic IIx decoding is effective. When you select decoding modes other than Dolby Pro Logic IIx, multi channel sound (being encoded) is output.

## Selecting a pre-programmed sound field

You can take advantage of surround sound simply by selecting one of the receiver’s pre-programmed sound fields. They bring the exciting and powerful sound of movie theaters and concert halls into your home.

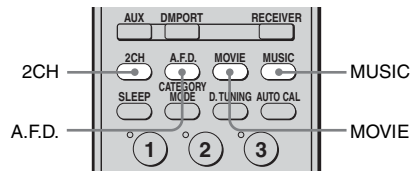

**Press MOVIE repeatedly to select a sound field for movies or press MUSIC repeatedly to select a sound field for music.**

For details, see “Types of sound field available” (page 55).

## Types of sound field available

Sound field for	Sound field [Display]	Effect
Movie	CINEMA STUDIO EX A <b>DCS</b> [C. ST. EX A]	Reproduces the sound characteristics of the Sony Pictures Entertainment "Cary Grant Theater" cinema production studio. This is a standard mode, great for watching almost any type of movie.
	CINEMA STUDIO EX B <b>DCS</b> [C. ST. EX B]	Reproduces the sound characteristics of the Sony Pictures Entertainment "Kim Novak Theater" cinema production studio. This mode is ideal for watching science-fiction or action movies with lots of sound effects.
	CINEMA STUDIO EX C <b>DCS</b> [C. ST. EX C]	Reproduces the sound characteristics of the Sony Pictures Entertainment scoring stage. This mode is ideal for watching musicals or films where orchestra music is featured in the soundtrack.
Music	PORTABLE AUDIO [PORTABLE]	Reproduces a clearer sound image from your portable audio device. This mode is ideal for MP3 and other compressed music.
	HALL [HALL]	Reproduces the acoustics of a classical concert hall.
	JAZZ CLUB [JAZZ]	Reproduces the acoustics of a jazz club.
	LIVE CONCERT [CONCERT]	Reproduces the acoustics of a 300-seat live house.
Headphone*	HEADPHONE 2CH [HP 2CH]	This mode is selected automatically if you use headphones when 2 channel mode (page 57)/A.F.D. mode (page 53) is selected. Standard 2 channel stereo sources completely bypass the sound field processing and multi channel surround formats are downmixed to 2 channels.
	HEADPHONE DIRECT [HP DIR]	Outputs the analog signals without processing by the equalizer, sound field, etc.
	HEADPHONE THEATER <b>DCS</b> [HP THEA]	This mode is selected automatically if you use headphones when sound field for movie/music is selected. It allows you to experience a theater-like environment while listening through a pair of headphones.

\* You can select this sound field mode if the headphones are connected to the receiver.

## About DCS (Digital Cinema Sound)

Sound fields with **DCS** mark use DCS technology.

DCS is a unique sound reproduction technology for home theater developed by Sony, in cooperation with Sony Pictures Entertainment, for enjoying the exciting and powerful sound of movie theaters at home. With this “Digital Cinema Sound” developed by integrating a DSP (Digital signal processor) and measured data, the ideal sound field intended by film makers can be experienced at home.

## About CINEMA STUDIO EX modes

CINEMA STUDIO EX modes are suitable for watching motion picture DVDs (etc.), with multi channel surround effects. You can reproduce the sound characteristics of Sony Pictures Entertainment’s dubbing studio in your home.

The CINEMA STUDIO EX modes consist of the following three elements.

- **Virtual Multi Dimension**  
Creates 5 sets of virtual speakers from a single pair of actual surround speakers.
- **Screen Depth Matching**  
Creates the sensation that the sound is coming from inside the screen like in theaters.
- **Cinema Studio Reverberation**  
Reproduces the type of reverberation found in theaters.



The CINEMA STUDIO EX modes integrate these three elements simultaneously.

## Notes

- The effects provided by the virtual speakers may cause increased noise in the playback signal.
- When listening with sound fields that employ the virtual speakers, you will not be able to hear any sound coming directly from the surround speakers.
- This function does not work in the following cases:
  - ANALOG DIRECT is selected.
  - Input signals of which the sampling frequency is more than 48 kHz are being received.
  - The multi-channel PCM signals are received via an HDMI IN jack.
- The surround back decoding mode does not function when a sound field for movie or music is selected (page 45).
- When one of the following sound fields is selected, no sound is output from the sub woofer if all the speakers are set to “LARGE” on the SYSTEM menu. However, the sound will be output from the sub woofer if the digital input signal contains LFE signals, or if the front or surround speakers are set to “SMALL”.
  - HALL
  - JAZZ
  - CONCERT

## Tip

You can identify the encoding format of DVD software, etc., by looking at the logo on the package.

-  : Dolby Digital discs
-  : Dolby Surround encoded programs
-  : DTS Digital Surround encoded programs

## To turn off the surround effect for movie/music

Press 2CH to select “2CH ST.” or press A.F.D. repeatedly to select “A.F.D. AUTO”.



## Using only the front speakers (2CH STEREO)

In this mode, the receiver outputs the sound from the front left/right speakers only. There is no sound from the sub woofer. Standard 2 channel stereo sources completely bypass the sound field processing and multi channel surround formats are downmixed to 2 channel.

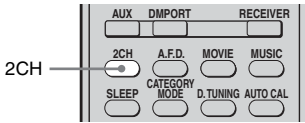

**Press 2CH.**

### Note

No sound is output from the sub woofer in the 2CH STEREO mode. To listen to 2 channel stereo sources using the front left/right speakers and a sub woofer, select "A.F.D. AUTO" (page 53).

## Listening to the sound without any adjustment (ANALOG DIRECT)

You can switch the audio of the selected input to two channel analog input. This function enables you to enjoy high quality analog sources.

When using this function, only the volume and front speaker balance can be adjusted.

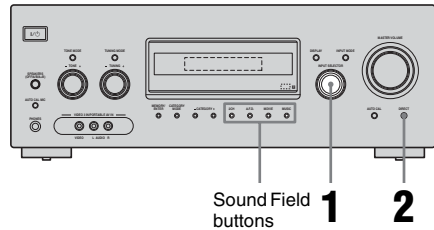

**1 Turn INPUT SELECTOR on the receiver to select the input you want to listen to in analog audio.**

You can also use the input buttons on the remote.

**2 Press DIRECT on the receiver.**

The analog audio is output.

### To cancel ANALOG DIRECT

Press DIRECT on the receiver.

You can also press any sound field buttons.

### Notes

- When headphones are connected, "HP DIR" appears on the display.
- This function is not available when DMPOR input is selected.

# Resetting sound fields to the initial settings

Be sure to use the buttons on the receiver for this operation.

**1,2**

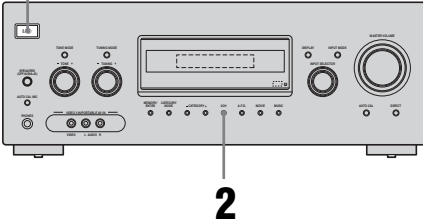

**1** Press I/O to turn off the power.

**2** While holding down 2CH, press I/O.

“SF. CLR.” appears on the display and all sound fields are reset to their initial setting.

## Tuner Operations

### Listening to FM/AM radio

You can listen to FM and AM broadcasts through the built-in tuner. Before operation, make sure you have connected the FM and AM antennas to the receiver (page 26).

#### Tip

The tuning scale for direct tuning differs depending on the area code as shown in the following table. For details on area codes, see page 3.

Area code	FM	AM
U, CA	100 kHz	10 kHz*

\* The AM tuning scale can be changed (page 91).

## Automatic tuning

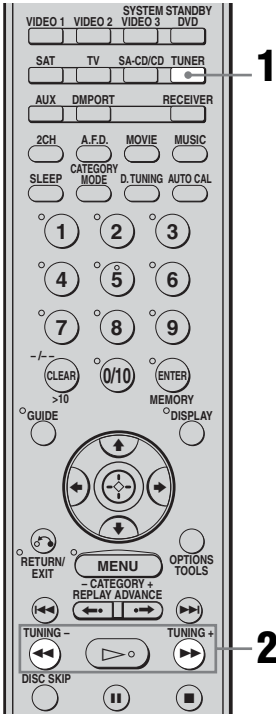

- 1** Press **TUNER** repeatedly to select the FM or AM band.
- 2** Press **TUNING +** or **TUNING -**.  
Press **TUNING +** to scan from low to high; press **TUNING -** to scan from high to low.  
The receiver stops scanning whenever a station is received.

### Using the controls on the receiver

- 1** Turn **INPUT SELECTOR** to select the FM or AM band.
- 2** Press **TUNING MODE** repeatedly to select "AUTO T".
- 3** Turn **TUNING +/-**.

## In case of poor FM stereo reception

If the FM stereo reception is poor and "ST" flashes on the display, select monaural audio so that the sound will be less distorted. For details, see "Settings for the tuner (TUNER menu)" (page 46).

## Direct tuning

Enter the frequency of a station directly by using the numeric buttons.

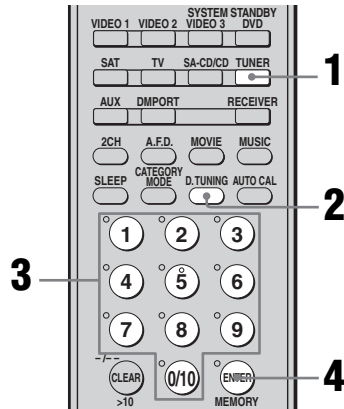

- 1** Press **TUNER** repeatedly to select the FM or AM band.  
You can also use **INPUT SELECTOR** on the receiver.
- 2** Press **D.TUNING**.
- 3** Press the numeric buttons to enter the frequency.  
Example 1: FM 102.50 MHz  
Select 1 → 0 → 2 → 5 → 0  
Example 2: AM 1,350 kHz  
Select 1 → 3 → 5 → 0  
If you have tuned in an AM station, adjust the direction of the AM loop antenna for optimum reception.

## 4 Press ENTER.

You can also use MEMORY/ENTER on the receiver.

### If you cannot tune in a station

Make sure you have entered the right frequency. If not, repeat steps 2 to 4. If you still cannot tune in a station, the frequency is not used in your area.

## Presetting radio stations

You can preset up to 30 FM stations and 30 AM stations. Then you can easily tune in the stations you often listen to.

### Presetting radio stations

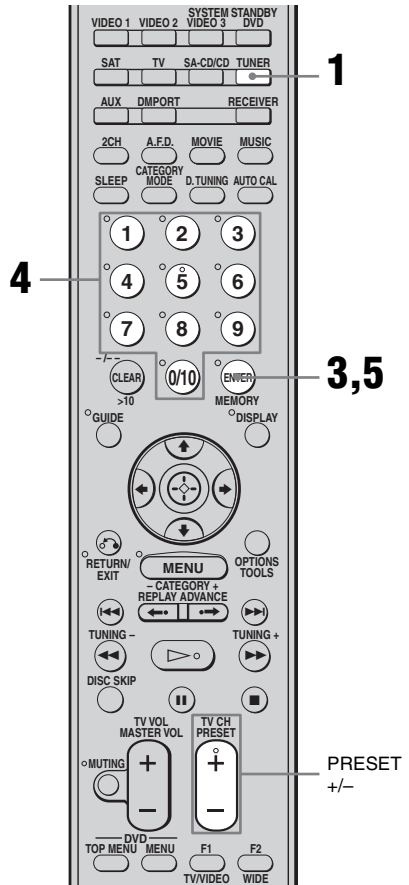

## 1 Press TUNER repeatedly to select the FM or AM band.

You can also use INPUT SELECTOR on the receiver.

## Tuning to preset stations

- 2** Tune in the station that you want to preset using **Automatic Tuning (page 59)** or **Direct Tuning (page 59)**.

Switch the FM reception mode, if necessary (page 59).

- 3** Press **MEMORY**.

You can also use **MEMORY/ENTER** on the receiver.

“MEMORY” lights up for a few seconds. Perform steps 4 and 5 before “MEMORY” goes out.

- 4** Press the numeric buttons to select a preset number.

You can also press **PRESET +** or **PRESET -** to select a preset number. If “MEMORY” goes out before you select the preset number, start again from step 3.

- 5** Press **ENTER**.

You can also use **MEMORY/ENTER** on the receiver.

The station is stored as the selected preset number.

If “MEMORY” goes out before you press **ENTER**, start again from step 3.

- 6** Repeat steps 1 to 5 to preset another station.

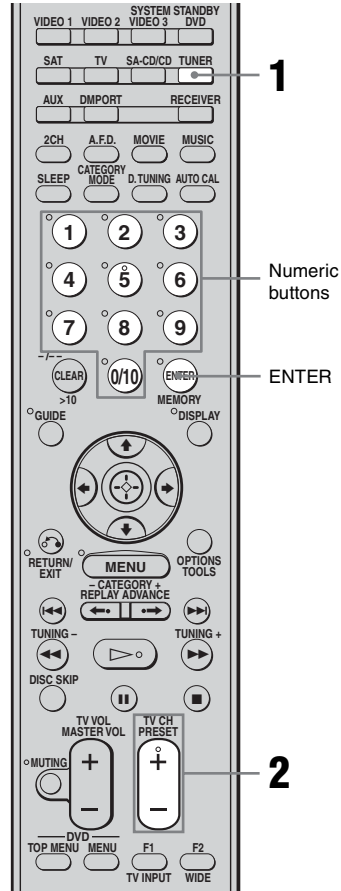

- 1** Press **TUNER** repeatedly to select the FM or AM band.

## 2 Press PRESET + or PRESET – repeatedly to select the preset station you want.

Each time you press the button, you can select a preset station as follows:

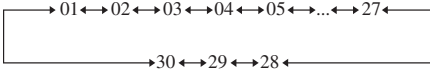

You can also press the numeric buttons to select the preset station you want. Then, press ENTER to enter the selection.

## Using the controls on the receiver

- 1 Turn INPUT SELECTOR to select the FM or AM band.
- 2 Press TUNING MODE repeatedly to select “PRESET T.”
- 3 Turn TUNING +/- to select the preset station you want.

## Naming preset stations

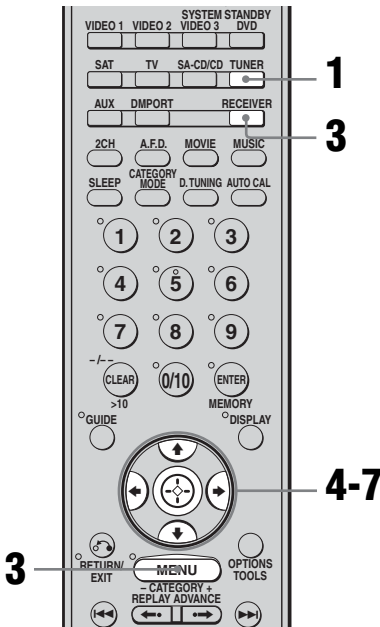

## 1 Press TUNER repeatedly to select the FM or AM band.

You can also use INPUT SELECTOR on the receiver.

## 2 Tune in the preset station you want to create an index name for (page 61).

## 3 Press RECEIVER, and then press MENU.

“1-LEVEL” appears on the display.

## 4 Press ↑/↓ repeatedly to select “4-TUNER”.

## 5 Press ⊕ or → to enter the menu.

## 6 Press ↑/↓ repeatedly to select “NAME IN”.

## 7 Press ⊖ or → to enter the parameter.

The cursor flashes and you can select a character. Follow the procedure given in “To create an index name” below.

## To create an index name

- 1 Use ↑/↓/←/→ to create an index name. Press ↑/↓ to select a character, then press ←/→ to move the cursor to the next position.

### If you made a mistake

Press ←/→ until the character you want to change flashes, then press ↑/↓ to select the correct character.

### Tips

- You can select the character type as follows by pressing ↑/↓.  
Alphabet (upper case) → Numbers → Symbols
- To enter a blank display, you can  
– press → without input a character.  
– press ↑/↓ repeatedly until a blank space appears in the display.

## 2 Press ⊕.

The entered name is registered.

# Listening to the XM Radio

## About XM Satellite Radio

XM Satellite Radio offers an extraordinary variety of commercial-free music, plus the best in sports, news, talk and entertainment. XM is broadcast in superior digital audio from coast to coast. From rock to reggae, from classical to hip hop, XM has something for every music fan. XM's dedication to playing the richest selection of music is matched by its passion for live sporting events, talk radio, up-to-the-minute news, stand-up comedy, children's programming, and much more. For U.S. customers, information about XM Satellite Radio is available online at [www.xmradio.com](http://www.xmradio.com). For Canadian customers, information about XM Canada is online at [www.xmradio.ca](http://www.xmradio.ca).

## XM Satellite Radio Terms and Conditions

Hardware and required monthly subscription sold separately. Other fees and taxes, including a one-time activation fee may apply. Subscription fee is consumer only. All fees and programming subject to change. Channels with frequent explicit language are indicated with an XL. Channel blocking is available for XM radio receivers by calling 1-800-XMRADIO (US residents) and 1-877-GET-XMSR (Canadian residents).

For a full listing of the XM commercial-free channels and advertising-supported channels, visit [lineup.xmradio.com](http://lineup.xmradio.com) (US residents) or [xmradio.ca](http://xmradio.ca) (Canadian residents).

Subscriptions subject to Customer Agreement available at [xmradio.com](http://xmradio.com) (US residents) and [xmradio.ca](http://xmradio.ca) (Canadian residents). Only available in the 48 contiguous United States and Canada. ©2006 XM Satellite Radio Inc. All rights reserved. All other trademarks are the property of their respective owners.

## To Activate XM Satellite Radio

Once you have installed the XM Mini-Tuner Dock, inserted the XM Mini-Tuner, connected the XM Dock to your XM Ready® home audio system, and installed the antenna, you are ready to subscribe and begin receiving XM programming. There are three places to find your eight character XM Radio ID: on the XM Mini-Tuner, on the XM Mini-Tuner package, and on XM Channel 0. Record the Radio ID in the following eight squares for reference.

□□□□□□□□

### Note

The XM Radio ID does not use the letters "I", "O", "S" or "F". Activate your XM Satellite Radio service in the U.S. online at <http://activate.xmradio.com> or call 1-800-XM-RADIO (1-800-967-2346). You will need a major credit card. XM will send a signal from the satellites to activate the full channel lineup. Activation normally takes 10 to 15 minutes, but during peak busy periods you may need to keep your XM Ready home audio system on for up to an hour. When you can access the full channel lineup on your XM Ready home audio system you are done. For more information or to subscribe in Canada, visit XM on the Web at [www.xmradio.ca](http://www.xmradio.ca) or call XM's Listener Care at 1-877-GET-XMSR (1-877-438-9677).

## Connecting the XM Radio

Before operating the receiver, connect the XM Connect-and-Play antenna to the XM jack.

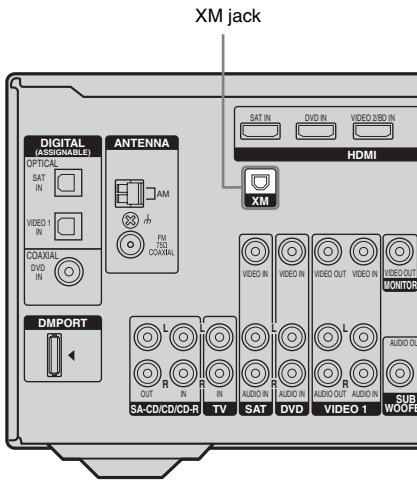

### Note

To ensure optimal reception of XM's satellite signal, move your antenna to various window locations around your home to see where the best reception will be received. Most XM customers place the antenna in a south-facing window with a clear view to the sky.

## Checking the XM Radio ID



### 1 Press TUNER repeatedly to select "XM RADIO".

You can also use INPUT SELECTOR on the receiver.

### 2 Press TUNING + or TUNING - to select a channel.

You can also press TUNING MODE on the receiver to select "AUTO T.", and then turn TUNING +/- to select channel 0.



### 3 Check the XM Radio ID on the display and write it in the space provided here.

ID: \_\_\_\_\_

If you cannot read the characters or numbers on the display clearly, refer to the following table.

Display	Description
2	2 (two)
5	5 (five)
6	6 (six)
8	8 (eight)
0	0 (zero)
A	A
B	B
D	D
G	G
H	H
K	K
M	M
Q	Q
Z	Z

## Receiving XM Radio broadcasts



### 1 Press TUNER repeatedly to select “XM RADIO”.

You can also use INPUT SELECTOR on the receiver.

### 2 Press TUNING + or TUNING – to select a channel.

You can also press TUNING MODE on the receiver to select “AUTO T.”, and then turn TUNING +/- to select a channel.

## Selecting channels from a category (CATEGORY TUNING)

You can select a channel from one category or all the categories by changing the category mode.

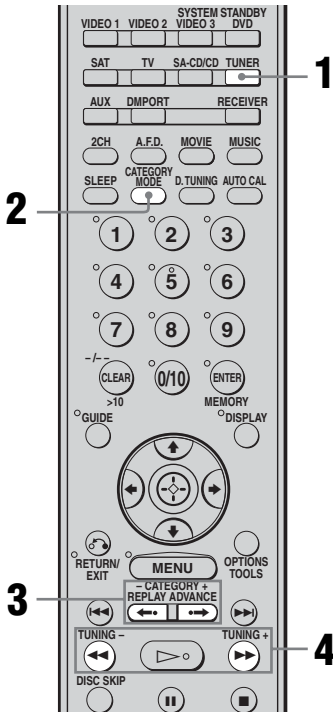

### 1 Press TUNER repeatedly to select “XM RADIO”.

You can also use INPUT SELECTOR on the receiver.

### 2 Press CATEGORY MODE repeatedly to select the “ONE CAT”.

- ALL CAT : You can select a channel from all categories. The initial setting is “ALL CAT.”
- ONE CAT : You can select a channel from one category. “CAT” is lights up on the display when “ONE CAT” is selected.

### 3 Press CATEGORY + or CATEGORY – to select the category you want.

The category is selected and the channel with the lowest number in the specified category is selected.

### 4 Press TUNING + or TUNING – to select the channel.

You can also press TUNING MODE on the receiver to select “AUTO T.”, and then turn TUNING +/- to select the channel.

#### Notes

- When you select a channel in the “ONE CAT” mode, the channel you selected may not be the one in the category you want. This is because one channel may belong to more than one category.
- If you press CATEGORY + or CATEGORY – in the “ALL CAT” mode, the first channel of the next or previous category is selected (CATEGORY SKIP).

## Selecting channels by inputting the channel number directly (DIRECT TUNING)

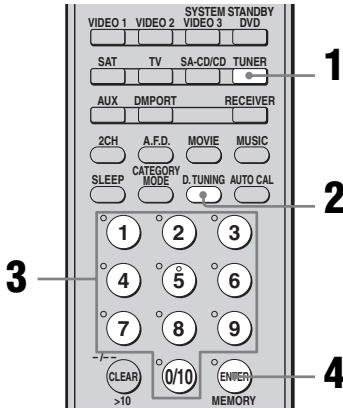

### 1 Press TUNER repeatedly to select “XM RADIO”.

You can also use INPUT SELECTOR on the receiver.

### 2 Press D.TUNING.

### 3 Press the numeric buttons to enter the channel number.

### 4 Press ENTER.

You can also use MEMORY/ENTER on the receiver.

The selected channel is tune in.

## Displaying the XM-RADIO information on the front panel display

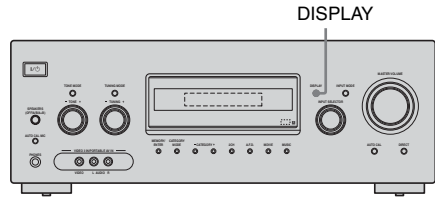

### Press DISPLAY on the receiver repeatedly.

Each time you press DISPLAY while tuning in the channel, the display changes cyclically as follows:

Channel name → Channel number →  
Category name → Artist name/Feature →  
Song/Program title → Sound field type

### Tip

The preset number is always displayed at the right end of the display.

# Presetting XM Radio stations

You can select the channels you want directly by presetting them using the preset numbers. You can preset up to 30 XM Radio channels.

## Presetting channels using the preset numbers

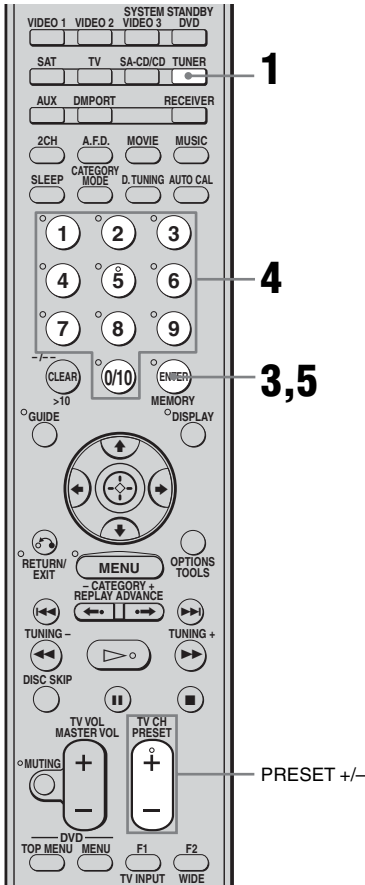

- 1 Press TUNER repeatedly to select “XM RADIO”.**  
You can also use INPUT SELECTOR on the receiver.
- 2 Tune in the channel you want to preset.**  
For details on selecting channels, see “Listening to the XM Radio” (page 63).
- 3 Press MEMORY.**  
You can also press MEMORY/ENTER on the receiver.
- 4 Press the numeric buttons to enter the preset number.**  
You can also select the number by pressing PRESET + or PRESET -. You can also turn TUNING +/- on the receiver.  
Preset numbers from 1 to 30 are available, and channel 1 is preset for all the preset numbers when you purchase the receiver.
- 5 Press ENTER.**  
You can also press MEMORY/ENTER on the receiver.
- 6 Repeat steps 2 to 5 to preset another channel.**

## Selecting the channel by using the preset numbers

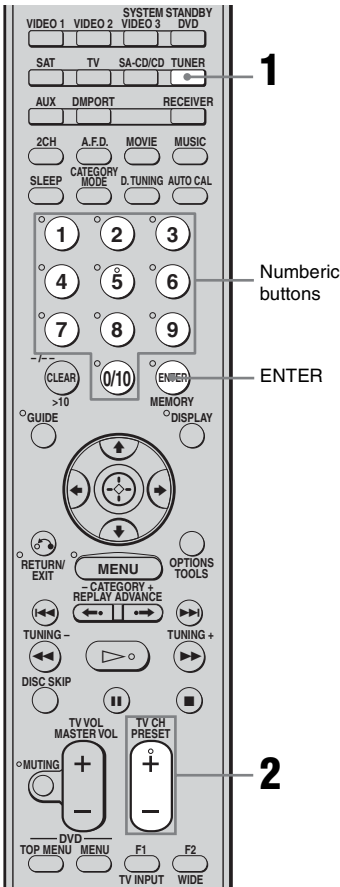

### 1 Press TUNER repeatedly to select “XM RADIO”.

You can also use INPUT SELECTOR on the receiver.

### 2 Press PRESET + or PRESET – repeatedly to select the preset channel you want.

You can also press the numeric buttons to select the preset channel you want. Then press ENTER to enter the selection. You can also press TUNING MODE on the receiver to select “PRESET T.”, and then turn TUNING +/- on the receiver.

You can select preset channels from 1 to 30.

#### Note

The preset channel information will be updated depending on the service provided by the XM Satellite Radio Inc. that you have subscribed to.

## XM Radio messages list

Message appears	Explanation	Remedies
ANTENNA	The XM antenna is not connected or transmission is not being received properly.	Make sure that the antenna is securely connected. Try to disconnect the antenna then reconnect, or turn off the power then turn back on.
UPDATING	The encryption code is being updated.	Wait until the encryption code has been updated.
NO SIGNL	The signal is too weak.	Make sure that the antenna is securely connected. Adjust the antenna so that the signal is as strong as possible.
LOADING	The audio channel or information is being acquired.	Wait until the audio channel or information has been acquired.
OFF AIR	The selected channel is off the air.	Make sure that you selected the channel properly. Try to select another channel.
----	There is no characteristic information such as an artist name, song title or program title available.	—
--	The preset number entered is invalid number.	Enter a number from 1 to 30.
XM ---- CH	The selected channel is not available.	—

# Switching the audio input mode

## (INPUT MODE)

You can select the audio input mode by setting the audio input mode when you connect components to both digital and analog audio input jacks on the receiver.

### 1 Turn INPUT SELECTOR on the receiver to select the input.

You can also use the input buttons on the remote.

### 2 Press INPUT MODE repeatedly on the receiver to select the audio input mode.

The selected audio input mode appears on the display.

## Audio input modes

- **AUTO IN**  
Gives priority to digital audio signals when there are both digital and analog connections. If there are no digital audio signals, analog audio signals are selected.
- **HDMI IN**  
Specifies the digital audio signals input to the HDMI jack.
- **COAX IN**  
Specifies the digital audio signals input to the DIGITAL COAXIAL jack.
- **OPT IN**  
Specifies the digital audio signals input to the DIGITAL OPTICAL jack.
- **ANALOG**  
Specifies the analog audio signals input to the AUDIO IN (L/R) jacks.

## Notes

- Some audio input modes may not be set up depending on the input.
- When the ANALOG DIRECT function is selected, audio input is set to “ANALOG” automatically and you cannot select other modes.

# Enjoying the DIGITAL MEDIA PORT (DMPORT)

The DIGITAL MEDIA PORT (DMPORT) allows you to enjoy sound from a network system such as a portable audio source or computer.

By connecting a DIGITAL MEDIA PORT adapter (not supplied), you can enjoy sound from the connected component on the receiver.

For details, see the operating instructions supplied with the DIGITAL MEDIA PORT adapter.

## Notes

- Do not connect an adapter other than the DIGITAL MEDIA PORT adapter.
- Do not connect or disconnect the DIGITAL MEDIA PORT adapter while the receiver is turned on.
- Depending on the DIGITAL MEDIA PORT adapter, video output may not be possible.
- The DIGITAL MEDIA PORT adapters are available for purchase depending on area.



## Connecting the DIGITAL MEDIA PORT adapter

You can listen to the sound from the component connected through the DIGITAL MEDIA PORT adapter to the DMPORT jack on the receiver.

You can also view the images on the TV screen by connecting the video output of the DIGITAL MEDIA PORT adapter to the receiver.

To view the images, proceed to “Watching a connected component through DMPORT connection” on page 74.

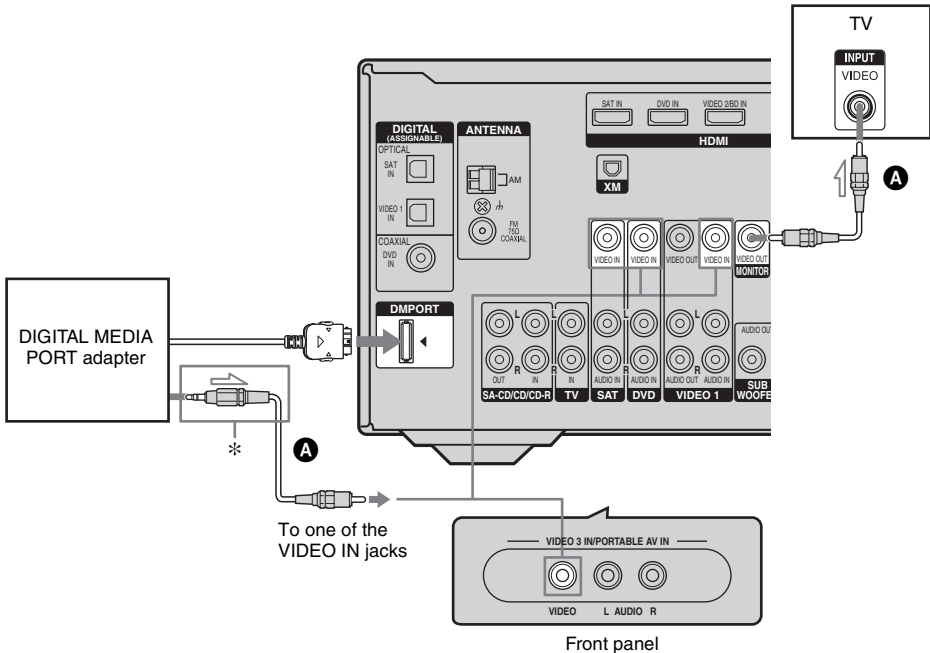

\* The type of connector varies depending on the DIGITAL MEDIA PORT adapter.  
For details, see the operating instructions supplied with the DIGITAL MEDIA PORT adapter.

**A** Video cord (not supplied)

## To detach the DIGITAL MEDIA PORT adapter from DMPORT jack

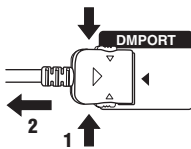

Press and hold both sides of the connector and then pull out the connector.

## Notes

- When connecting the DIGITAL MEDIA PORT adapter, be sure the connector is inserted with the arrow mark facing towards the arrow mark on the DMPORT jack.
- Be sure to make DMPORT connections firmly, insert the connector straight in.
- As the connector of the DIGITAL MEDIA PORT adapter is fragile, be sure to handle with care when placing or moving the receiver.

## Listening to a connected component through DMPORT connection

### 1 Press DMPORT.

You can also use the INPUT SELECTOR on the receiver to select "DMPORT".

### 2 Start playback of the connected component.

The sound is played back on the receiver. For details, see the operating instructions supplied with the DIGITAL MEDIA PORT adapter.

## Watching a connected component through DMPORT connection

You need to assign composite video input to DMPORT input so that you can view the images on the TV screen.

### 1 Press RECEIVER.

The RECEIVER indicator lights up and receiver operation is activated.

### 2 Press MENU.

"1-LEVEL" appears on the display.

### 3 Press $\uparrow/\downarrow$ repeatedly to select "6-VIDEO".

### 4 Press $\left(\begin{smallmatrix} \oplus \\ \ominus \end{smallmatrix}\right)$ or $\rightarrow$ to enter the menu.

### 5 Press $\uparrow/\downarrow$ repeatedly to select "DMPORT V.".

### 6 Press $\left(\begin{smallmatrix} \oplus \\ \ominus \end{smallmatrix}\right)$ or $\rightarrow$ to enter the parameter.

### 7 Press $\uparrow/\downarrow$ repeatedly to select the composite video input you want to assign to DMPORT input.

Initial setting: -NONE

The assignable composite video input are VIDEO 1, VIDEO 3, DVD and SAT inputs.

For example, select "-VIDEO 1".

When you press DMPORT, the images from the component connected to the VIDEO 1 VIDEO IN jack through DIGITAL MEDIA PORT adapter will appear on the TV screen.

## To return to the previous display

Press  $\leftarrow$ .

### Notes

- Depending on the type of DIGITAL MEDIA PORT adapter, you can operate the connected component by using the remote. For details on remote button operation, see page 10.
- Be sure you have made the video connection from DIGITAL MEDIA PORT adapter to the receiver (page 73).
- Be sure you have connected the MONITOR VIDEO OUT jack of the receiver to the TV (page 73).
- Depending on the DIGITAL MEDIA PORT adapter, video output may not be possible.

### Tip

When listening to MP3 or other compressed music using a portable audio source, you can enhance the sound. Press MUSIC repeatedly to select "PORTABLE" (page 54).

# Listening to digital sound from other inputs (DIGITAL ASSIGN)

You can reassign digital audio input that has OPTICAL or COAXIAL (SAT IN, VIDEO 1 IN, DVD IN) signals to another input when they are not currently being used.

For example, to output the sound source for the DVD player using the OPTICAL IN jack on the receiver:

- Connect the optical output jack of the DVD player to the OPTICAL VIDEO 1 IN jack of the receiver.
- Assign “VD1” to “DVD” in the “D. ASSIGN” setting.



**1** Press RECEIVER and then press MENU.

“1-LEVEL” appears on the display.

**2** Press  $\uparrow/\downarrow$  repeatedly to select “5-AUDIO”.

**3** Press  $\left(\oplus\right)$  or  $\rightarrow$  to enter the menu.

**4** Press  $\uparrow/\downarrow$  repeatedly to select “D. ASSIGN”.

**5** Press  $\left(\oplus\right)$  or  $\rightarrow$  to enter the parameter.

**6** Press  $\uparrow/\downarrow$  repeatedly to select the digital audio input you want to reassign (for example, “VD1”).

**7** Press  $\left(\oplus\right)$  or  $\rightarrow$  to enter your selection.

**8** Press  $\uparrow/\downarrow$  repeatedly to select the input you want the digital audio input selected in step 6 to be reassigned to (for example, “DVD”).

The input you can reassign to varies for each digital audio input. For details, see “Assignable inputs for digital audio input” below.

**To return to the previous display**

Press  $\leftarrow$ .

## Assignable inputs for digital audio input

The initial setting is marked with an underscore.

Digital audio input [Display]	Assignable inputs	Display	
VIDEO 1 OPTICAL [VD1 OPT]	VIDEO 1	<u>VD1- VD1</u>	
	VIDEO 2	VD1- VD2	
	VIDEO 3	VD1- VD3	
	DVD	VD1- DVD	
	TV	VD1- TV	
	SA-CD/CD	VD1- CD	
DVD COAXIAL [DVD COAX]	VIDEO 1	DVD- VD1	
	VIDEO 2	DVD- VD2	
	VIDEO 3	DVD- VD3	
	DVD	<u>DVD- DVD</u>	
	SAT	DVD- SAT	
	TV	DVD- TV	
	SA-CD/CD	DVD- CD	
	SAT OPTICAL [SAT OPT]	VIDEO 2	SAT-VD2
		VIDEO 3	SAT- VD3
DVD		SAT- DVD	
SAT		<u>SAT- SAT</u>	
TV		SAT- TV	
SA-CD/CD		SAT- CD	

### Notes

- You cannot reassign several digital audio inputs to the same input.
- You cannot use the digital audio input for the original input when it is reassigned to another input.
- When you reassign the digital audio input, the INPUT MODE setting may change automatically (page 71).
- You cannot reassign the digital audio input to TUNER, XM Radio and DMPORT.

## Naming inputs

You can enter a name of up to 8 characters for inputs and display it on the receiver's display. This is convenient for labeling the jacks with the names of the connected components.

### 1 Press the input button to select the input you want to create an index name for.

You can also use INPUT SELECTOR on the receiver.

### 2 Press RECEIVER and then press MENU.

"1-LEVEL" appears on the display.

### 3 Press $\uparrow/\downarrow$ repeatedly to select either "5-AUDIO" or "6-VIDEO".

### 4 Press $\odot$ or $\rightarrow$ to enter the menu.

### 5 Press $\uparrow/\downarrow$ to select "NAME IN".

### 6 Press $\odot$ or $\rightarrow$ to enter the parameter.

The cursor flashes and you can select a character. Follow the procedure given in "To create an index name" (page 62).

## Changing the display

You can check the sound field, etc., by changing the information on the display. Be sure to use the buttons on the receiver for this operation.

### Press DISPLAY repeatedly.

Each time you press the button, the display changes cyclically as follows.

### All inputs except the FM and AM band and XM Radio

Index name of the input<sup>a)</sup> → Selected input  
→ Sound field currently applied

### FM and AM band

Preset station name<sup>a)</sup> → Frequency → Sound field currently applied

### XM Radio

Channel name → Channel number →  
Category name → Artist name/Feature →  
Song/program title → Sound field currently applied

<sup>a)</sup> Index name appears only when you have assigned one to the input or preset station (page 62, 76). Index name does not appear when only blank spaces have been entered, or it is the same as the input name.

## Using the Sleep Timer

You can set the receiver to turn off automatically at a specified time.

### Press SLEEP repeatedly while the power is on.

Each time you press the button, the display changes cyclically as follows:

2-00-00 → 1-30-00 → 1-00-00 → 0-30-00  
→ OFF

When sleep timer is activated, the display dims.

### Note

If you press any buttons on the remote or receiver after the display dims, the display brightens up. After a while, the display dims again if no button is pressed.

### Tip

To check the remaining time before the receiver turns off, press SLEEP. The remaining time appears on the display. If you press SLEEP again, the sleep timer will be canceled.

# Recording using the receiver

## Recording onto a CD-R

You can record onto a CD-R using the receiver. See the operating instructions supplied with your CD recorder.

### 1 Press one of the input buttons to select the playback component.

You can also use INPUT SELECTOR on the receiver.

### 2 Prepare the playback component for playing.

For example, tune to the radio station you want to record (page 58).

### 3 Prepare the recording component.

Insert a blank CD-R into the CD recorder and adjust the recording level.

### 4 Start recording on the recording component, then start playback on the playback component.

#### Note

Sound adjustments do not affect the signal output from the SA-CD/CD/CD-R OUT jacks.

## Recording onto a recording media

You can record from a video component using the receiver. See the operating instructions supplied with your recording component.

### 1 Press one of the input buttons to select the playback component.

You can also use INPUT SELECTOR on the receiver.

### 2 Prepare the playback component for playing.

For example, insert the video tape you want to copy into the VCR.

### 3 Prepare the recording component.

Insert a blank video tape, etc. into the recording component (VIDEO 1) for recording.

### 4 Start recording on the recording component, then start playback on the playback component.

#### Notes

- Some sources contain copy guards to prevent recording. In this case, you may not be able to record from the source.
- When DMPORT input is selected and you have assigned VIDEO 1 input to DMPORT input, no video signals are output from the VIDEO 1 VIDEO OUT jack.

# Programming the remote

You can program the remote to control non-Sony components by changing the code. Once the control signals have been memorized, you can use those components as part of your system.

Furthermore, you can also program the remote for Sony components that the remote is unable to control. Note that the remote can only control components that accept infrared wireless control signals.

## 1 Press RM SET UP.

The RM SET UP indicator slowly flashes.

## 2 Press the input button for the component you want to control.

For example, if you are going to control a CD player, press SA-CD/CD. The RM SET UP indicator lights up.

## 3 Press the numeric buttons to enter the numeric code (or one of the codes if more than one code exists) corresponding to the component and the maker of the component you want to control (except TV).

See the tables on pages 80–84 for information on the numeric code(s) corresponding to the component and the maker of the component (the first digit and the last two digits of the numeric code correspond to the category and the maker's code respectively.)

## 4 Press ENTER.

Once the numeric code has been verified, the RM SET UP indicator slowly flashes twice and the remote automatically exits the programming mode.

## 5 Repeat steps 1 to 4 to control other components.

### Notes

- The indicator turns off while a valid button is pressed.
- In step 2, if several input buttons are pressed, only the last pressed button is valid.
- In step 2, if you press TUNER, you can only program the button to control a tuner (page 84).
- In step 3, if an input button is pressed, the new input is selected and the programming procedure returns to the beginning of step 3.
- For the numeric codes, only the last three numbers entered are valid.

### To program the remote to control a TV

#### 1 Press RM SET UP.

The RM SET UP indicator slowly flashes.

#### 2 Press TV.

#### 3 Press the numeric buttons to enter the numeric code (or one of the codes if more than one code exists) for TV. For details, see page 82.

#### 4 Press ENTER.

Once the numeric code has been verified, the RM SET UP indicator slowly flashes twice and the remote automatically exits the programming mode.

### To cancel programming

Press RM SET UP during any step. The RM SET UP indicator flashes 5 times in quick succession. The remote automatically exits the programming mode.

### To activate the input after programming

Press the programmed button to activate the input you want.

## If programming is unsuccessful, check the following:

- If the indicator does not light up in step 1, the batteries are weak. Replace both batteries.
- If the indicator flashes 5 times in quick succession while entering the numeric code, an error has occurred. Start again from step 1.

## To clear the memory of the remote

To clear all programmed, do the following to reset the remote to factory settings.

## While holding down MASTER VOL –, press and hold I/⏻ and then press AV I/⏻.

The indicator flashes 3 times, then goes off.

## The numeric codes corresponding to the component and the maker of the component

Use the numeric codes in the tables below to control non-Sony components and also Sony components that the remote is normally unable to control. Since the remote signal that a component accepts differs depending on the model and year of the component, more than one numeric code may be assigned to a component. If you fail to program your remote using one of the codes, try using other codes.

### Notes

- The numeric codes are based on the latest information available for each brand. There is a chance, however, that your component will not respond to some or all of the codes.
- All of the input buttons on this remote may not be available when used with your particular component.

## To control a CD player

Maker	Code(s)
SONY	101, 102, 103
DENON	104, 123
JVC	105, 106, 107
KENWOOD	108, 109, 110
MAGNAVOX	111, 116
MARANTZ	116
ONKYO	112, 113, 114
PANASONIC	115
PHILIPS	116
PIONEER	117
TECHNICS	115, 118, 119
YAMAHA	120, 121, 122

## To control a DAT deck

Maker	Code(s)
SONY	203
PIONEER	219

## To control an MD deck

Maker	Code(s)
SONY	301
DENON	302
JVC	303
KENWOOD	304

## To control a tape deck

Maker	Code(s)
SONY	201, 202
DENON	204, 205
KENWOOD	206, 207, 208, 209
NAKAMICHI	210
PANASONIC	216
PHILIPS	211, 212
PIONEER	213, 214
TECHNICS	215, 216
YAMAHA	217, 218



## To control an LD player

Maker	Code(s)
SONY	601, 602, 603
PIONEER	606

## To control a video CD player

Maker	Code(s)
SONY	605

## To control a DVD/VHS COMBO

Maker	Code(s)
SONY	411

## To control a DVD/HDD COMBO

Maker	Code(s)
SONY	403

## To control a VCR

Maker	Code(s)
SONY	701, 702, 703, 704, 705, 706
AIWA*	710, 750, 757, 758
AKAI	707, 708, 709, 759
BLAUPUNKT	740
EMERSON	711, 712, 713, 714, 715, 716, 750
FISHER	717, 718, 719, 720
GENERAL ELECTRIC (GE)	721, 722, 730
GOLDSTAR/LG	723, 753
GRUNDIG	724
HITACHI	722, 725, 729, 741
ITT/NOKIA	717
JVC	726, 727, 728, 736
MAGNAVOX	730, 731, 738
MITSUBISHI/MGA	732, 733, 734, 735
NEC	736
PANASONIC	729, 730, 737, 738, 739, 740
PHILIPS	729, 730, 731
PIONEER	729
RCA/PROSCAN	722, 729, 730, 731, 741, 747
SAMSUNG	742, 743, 744, 745
SANYO	717, 720, 746
SHARP	748, 749
TELEFUNKEN	751, 752
TOSHIBA	747, 756
ZENITH	754

\* If an AIWA VCR does not work even though you enter the code for AIWA, enter the code for Sony instead.

## To control a DVD player

<b>Maker</b>	<b>Code(s)</b>
SONY	401, 402, 403
RCA	414
SAMSUNG	416, 422
ZENITH	418, 420
PANASONIC	406, 408, 425
PHILIPS	407
PIONEER	409, 410
TOSHIBA	404, 421
DENON	405
BROKSONIC	424
HITACHI	416
JVC	415, 423
MITSUBISHI	419
ORITRON	417

## To control a DVD recorder

<b>Maker</b>	<b>Code(s)</b>
SONY	403

## To control a TV

<b>Maker</b>	<b>Code(s)</b>
SONY	501, 502
AIWA	501, 536, 539
AKAI	503
AOC	503
CENTURION	566
CORONADO	517
CURTIS-MATHES	503, 551, 566, 567
DAYTRON	517, 566
DAEWOO	504, 505, 506, 507, 515, 544
FISHER	508, 545
FUNAI	548
FUJITSU	528
GOLDSTAR/LG	503, 512, 515, 517, 534, 544, 556, 568
GRUNDIG	511, 533, 534
HITACHI	503, 513, 514, 515, 517, 519, 544, 557, 571
ITT/NOKIA	521, 522
J.C.PENNY	503, 510, 566
JVC	516, 552
KMC	517
MAGNAVOX	503, 515, 517, 518, 544, 566
MARANTZ	527
MITSUBISHI/MGA	503, 519, 527, 544, 566, 568
NEC	503, 517, 520, 540, 544, 554, 566
NORDMENDE	530, 558
NOKIA	521, 522, 573, 575
PANASONIC	509, 524, 553, 559, 572
PHILIPS	515, 518, 557, 570, 571
PHILCO	503, 504, 514, 517, 518
PIONEER	509, 525, 526, 540, 551, 555
PORTLAND	503
QUASAR	509, 535

<b>Maker</b>	<b>Code(s)</b>
RADIO SHACK	503, 510, 527, 565, 567
RCA/PROSCAN	503, 510, 523, 529, 544
SAMSUNG	503, 515, 517, 531, 532, 534, 544, 556, 557, 562, 563, 566, 569
SAMPO	566
SABA	530, 537, 547, 549, 558
SANYO	508, 545, 546, 560, 567
SCOTT	503, 566
SEARS	503, 508, 510, 517, 518, 551
SHARP	517, 535, 550, 561, 565
SYLVANIA	503, 518, 566
TELEFUNKEN	530, 537, 538, 547, 549, 558
THOMSON	530, 537, 547, 549
TOSHIBA	535, 539, 540, 541, 551
ZENITH	542, 543, 567
TEKNIKA	517, 518, 567
WARDS	503, 517, 566
YORK	566
GE	503, 509, 510, 544
LOEWE	515, 534, 556

## To control a satellite tuner

<b>Maker</b>	<b>Code(s)</b>
SONY	801, 802, 803, 804, 824, 825, 865
AMSTRAD	845, 846
BskyB	862
GENERAL ELECTRIC (GE)	866
GRUNDIG	859, 860
HUMAX	846, 847
THOMSON	857, 861, 864
PACE	848, 849, 850, 852, 862, 863, 864
PANASONIC	818, 855
PHILIPS	856, 857, 858, 859, 860, 864, 874
NOKIA	851, 853, 854, 864
RCA/PROSCAN	866, 871
BITA/HITACHI	868
HUGHES	867
JVC/Echostar/Dish Network	873
MITSUBISHI	872
SAMSUNG	875
TOSHIBA	869, 870

## To control a cable box

Maker	Code(s)
SONY	821, 822, 823
HAMLIN/REGAL	836, 837, 838, 839, 840
JERROLD/G.I./ MOTOROLA	806, 807, 808, 809, 810, 811, 812, 813, 814, 819
JERROLD	830, 831
OAK	841, 842, 843
PANASONIC	816, 826, 832, 833, 834, 835
PHILIPS	830, 831
PIONEER	828, 829
RCA	805
SCIENTIFIC ATLANTA	815, 816, 817
TOCOM/PHILIPS	830, 831
ZENITH	826, 827

## To control a tuner

Maker	Code(s)
SONY	002, 005

## To control a Blu-ray disc recorder

Maker	Code(s)
SONY	310, 311, 312

## To control a PSX

Maker	Code(s)
SONY	313, 314, 315

## Additional Information

## Glossary

### ■ Component video

A format for transmitting video signal information consisting of three separate signals: luminance Y, chrominance Pb, and chrominance Pr. High quality pictures, such as DVD video or HDTV pictures, are transmitted more faithfully. The three jacks are color-coded green, blue and red.

### ■ Composite video

A standard format for transmitting video signal information. The luminance signal Y and chrominance signal C are combined and transmitted together.

### ■ Dolby Digital

Digital audio encoding/decoding technology developed by Dolby Laboratories, Inc. It consists of front (left/right), center, surround (left/right) and sub woofer channels. It is a designated audio standard for DVD-video and also known as 5.1ch surround. Since surround information is recorded and reproduced in stereo, more realistic sound with fuller presence is delivered than with Dolby surround.

### ■ Dolby Digital Surround EX

Acoustic technology developed by Dolby Laboratories, Inc. Surround back information is matrixed into regular left and right surround channels so that the sound can be reproduced in 6.1ch. Active scenes, especially, are recreated with a more dynamic and realistic sound field.

### ■ Dolby Pro Logic II

This technology converts 2ch stereo recorded audio into 5.1ch for playback. There is a MOVIE mode for movies and MUSIC mode for stereo sources such as music. Old movies encoded in the traditional stereo format can be enhanced with 5.1ch surround sound.

### ■ Dolby Pro Logic IIx

Technology for 7.1ch (or 6.1ch) playback. Along with audio encoded in Dolby Digital Surround EX, 5.1ch Dolby Digital encoded audio can be reproduced in 7.1ch (or 6.1ch). Furthermore, existing stereo recorded content can also be reproduced in 7.1ch (or 6.1ch).

### ■ Dolby Surround (Dolby Pro Logic)

Audio processing technology developed by Dolby Laboratories, Inc. Center and mono surround information is matrixed into two stereo channels. When reproduced, audio is decoded and output in 4ch surround sound. This is the most common audio processing method for DVD-video.

### ■ DTS 96/24

A high sound quality digital signal format. It records audio at a sampling frequency and bit rate of 96kHz/24bit which is the highest possible for DVD-video. The number of playback channels varies depending on the software.

### ■ DTS Digital Surround

Digital audio encoding/decoding technology for theaters developed by Digital Theater Systems, Inc. It compresses audio less than Dolby Digital, delivering a higher quality sound reproduction.

### ■ DTS-ES

Format for 6.1ch playback with surround back information. There are two modes, "Discrete 6.1" which records all channels independently, and "Matrix 6.1" which matrixes surround back channel into LS and RS channels. It is ideal for playback of motion picture soundtracks.

### ■ DTS Neo:6

This technology converts 2ch stereo recorded audio for 6.1ch playback. There are two modes to select according to the playback source or your preference, CINEMA for movies, and MUSIC for stereo sources such as music.

### ■ HDMI (High-Definition Multimedia Interface)

HDMI is an interface that supports both video and audio on a single digital connection. The HDMI connection carries standard to high definition video signals and multi channel audio signals to audio/video components, such as HDMI equipped TVs, in digital form without degradation. The HDMI specification supports HDCP (High-bandwidth Digital Contents Protection), a copy protection technology that incorporates coding technology for digital video signals.

### ■ Sampling frequency

To convert analog audio to digital, analog data should be quantified. This process is called sampling, and the number of times per second the analog data is quantified is called the sampling frequency. A standard music CD stores data quantified at 44,100 times per second, which is expressed as a sampling frequency of 44.1 kHz. Generally speaking, a higher sampling frequency means better sound quality.

### ■ TSP (Time Stretched Pulse)

A TSP signal is a highly precise measuring signal that utilizes impulse energy, measuring a wide band, from low to high, in a short period.

The amount of energy used to measure signals is important to ensure measurement accuracy in a normal indoor environment. Using TSP signals makes it possible to measure signals effectively.

# Precautions

## On safety

Should any solid object or liquid fall into the cabinet, unplug the receiver and have it checked by qualified personnel before operating it any further.

## On power sources

- Before operating the receiver, check that the operating voltage is identical with your local power supply.

The operating voltage is indicated on the nameplate on the back of the receiver.

- The unit is not disconnected from the AC power source (mains) as long as it is connected to the wall outlet, even if the unit itself has been turned off.
- If you are not going to use the receiver for a long time, be sure to disconnect the receiver from the wall outlet. To disconnect the AC power cord, grasp the plug itself; never pull the cord.
- One blade of the plug is wider than the other for the purpose of safety and will fit into the wall outlet only one way. If you are unable to insert the plug fully into the outlet, contact your dealer.
- The AC power cord must be changed only at a qualified service shop.

## On heat buildup

Although the receiver heats up during operation, this is not a malfunction. If you continuously use this receiver at a large volume, the cabinet temperature of the top, side and bottom rises considerably. To avoid burning yourself, do not touch the cabinet.

## On placement

- Place the receiver in a location with adequate ventilation to prevent heat buildup and prolong the life of the receiver.
- Do not place the receiver near heat sources, or in a place subject to direct sunlight, excessive dust, or mechanical shock.
- Do not place anything on top of the cabinet that might block the ventilation holes and cause malfunctions.
- Do not place the receiver near equipment such as a television, VCR, or tape deck. (If the receiver is being used in combination with a television, VCR, or tape deck, and is placed too close to that equipment, noise may result, and picture quality may suffer. This is especially likely when using an indoor antenna. Therefore, we recommend using an outdoor antenna.)
- Use caution when placing the receiver on surfaces that have been specially treated (with wax, oil, polish, etc.) as staining or discoloration of the surface may result.

## On operation

Before connecting other components, be sure to turn off and unplug the receiver.

## On cleaning

Clean the cabinet, panel, and controls with a soft cloth slightly moistened with a mild detergent solution. Do not use any type of abrasive pad, scouring powder, or solvent, such as alcohol or benzene.

If you have any questions or problems concerning your receiver, please consult your nearest Sony dealer.

---

# Troubleshooting

If you experience any of the following difficulties while using the receiver, use this troubleshooting guide to help you remedy the problem.

## Audio

---

### **There is no sound, no matter which component is selected, or only a very low-level sound is heard.**

- Check that the speakers and components are connected securely.
- Check that all speakers cords are connected correctly.
- Check that both the receiver and all components are turned on.
- Check that MASTER VOLUME is not set to "VOLUME MIN".
- Check that the SPEAKERS (OFF/A/B/A+B) is not set to "OFF".
- Check that headphones are not connected.
- Press MUTING to cancel the muting function.
- Check that you have selected the correct component with the input buttons.
- The protective device on the receiver has been activated. Turn off the receiver, eliminate the short-circuit problem, and turn on the power again.

---

### **There is no sound from a specific component.**

- Check that the component is connected correctly to the audio input jacks for that component.
- Check that the cord(s) used for the connection is (are) fully inserted into the jacks on both the receiver and the component.

---

### **There is no sound from one of the front speakers.**

- Connect a pair of headphones to the PHONES jack to verify that sound is output from the headphones. If only one channel is output from the headphones, the component may not be connected to the receiver correctly. Check that all the cords are fully inserted into the jacks on both the receiver and the component. If both channels are output from the headphones, the front speaker may not be connected to the receiver correctly. Check the connection of the front speaker which is not outputting any sound.
- Make sure you have connected to both the L and R jacks of an analog component, and not only to either the L or R jack. Use an audio cord (not supplied).

---

### **There is no sound from analog 2 channel sources.**

- Check that the INPUT MODE is not set to "COAX IN", "OPT IN" or "HDMI IN" for the selected input (page 71).

---

### **There is no sound from digital sources (from COAXIAL or OPTICAL input jack).**

- Check that the INPUT MODE is not set to "ANALOG" or "HDMI IN" (page 71).
- Check that the ANALOG DIRECT function is not selected.
- Check that the DIGITAL ASSIGN function is not used to reassign the audio input of another source to be selected input (page 75).

---

**The source sound input from the HDMI jack on the receiver is not output from the receiver or TV speaker.**

- Check the setting of HDMI AUDIO in the VIDEO menu (page 41).
- Check the HDMI connection.
- You cannot listen to the Super Audio CD by connecting HDMI.
- Depending on the playback component, you may need to set up the component. Refer to the operating instructions supplied with the each component.

---

**The left and right sounds are unbalanced or reversed.**

- Check that the speakers and components are connected correctly and securely.
- Adjust the balance parameters using the LEVEL menu.

---

**There is severe hum or noise.**

- Check that the speakers and components are connected securely.
- Check that the connecting cords are away from a transformer or motor, and at least 10 feet away from a TV set or fluorescent light.
- Move your audio components away from the TV.
- The plugs and jacks are dirty. Wipe them with a cloth slightly moistened with alcohol.

---

**There is no sound, or only a very low-level sound is heard from the center/surround/surround back speakers.**

- Select a CINEMA STUDIO EX mode (page 55).
- Adjust the speaker level (page 34).
- Make sure the center/surround speakers are set to either “SMALL” or “LARGE” (page 42).
- Make sure the surround back speaker is set to “YES” (page 42).

---

**There is no sound from the surround back speaker.**

- Some discs have no Dolby Digital Surround EX flag even though the packages have Dolby Digital Surround EX logos. In this case, select “SB ON” (page 40).

---

**There is no sound from the sub woofer.**

- Check that the sub woofer is connected correctly and securely.
- Make sure you have turned on your sub woofer.
- Make sure the sub woofer is set to “YES” (page 42).
- There is no sound from the sub woofer depending on the sound field.
- When all speakers are set to “LARGE” and “NEO6 CIN” or “NEO6 MUS” is selected, there is no sound from the sub woofer.

---

**The surround effect cannot be obtained.**

- Make sure the sound field function is on (press MOVIE, or MUSIC).
- Sound fields do not function for signals with a sampling frequency of more than 48 kHz.

---

**Dolby Digital or DTS multi channel sound is not reproduced.**

- Check that the DVD, etc. you are playing is recorded in Dolby Digital or DTS format.
- When connecting the DVD player, etc., to the digital input jacks of this receiver, check the audio setting (the settings for the audio output) of the connected component.

---

**Recording cannot be carried out.**

- Check that the components are connected correctly.
  - Select the source component using the input buttons.
-



## Video

---

### **There is no picture or an unclear picture appears on the TV screen or monitor.**

- Select the appropriate input using the input buttons.
- Set your TV to the appropriate input mode.
- Move your audio components away from the TV.
- Assign the composite video input to DMPORT input correctly.
- Depending on the DIGITAL MEDIA PORT adaptor, video output may not be possible.

---

### **The source image input to the HDMI jack on the receiver is not output from the TV.**

- Check the HDMI connection.
- Depending on the playback component, you may need to set up the component. Refer to the operating instructions supplied with each component.

---

### **Recording cannot be carried out.**

- Check that the components are connected correctly.
- Select the source component using the input buttons.

## Tuner

---

### **The FM reception is poor.**

- Use a 75-ohm coaxial cable (not supplied) to connect the receiver to an outdoor FM antenna as shown below. If you connect the receiver to an outdoor antenna, ground it against lightning. To prevent a gas explosion, do not connect the ground wire to a gas pipe.

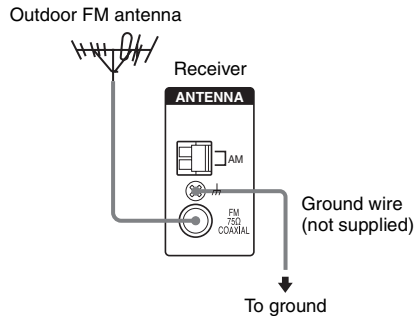

---

### **Radio stations cannot be tuned in.**

- Check that the antennas are connected securely. Adjust the antennas and connect an external antenna, if necessary.
- The signal strength of the stations is too weak (when tuning in with automatic tuning). Use direct tuning.
- Make sure you set the tuning interval correctly (when tuning in AM stations with direct tuning).
- No stations have been preset or the preset stations have been cleared (when tuning by scanning preset stations). Preset the stations (page 60).
- Press DISPLAY repeatedly on the receiver so that the frequency appears on the display.

## Remote commander

---

### The remote does not function.

- Point the remote at the remote sensor on the receiver.
  - Remove any obstacles in the path between the remote and the receiver.
  - Replace all the batteries in the remote with new ones, if they are weak.
  - Make sure you select the correct input on the remote.
  - When you operate a programmed non-Sony component, the remote may not function properly depending on the model and the maker of the component.
- 

## Error messages

If there is a malfunction, the display shows a message. You can check the condition of the system by the message. Refer to the following table to solve the problem. If any problem persists, consult your nearest Sony dealer. If an error message appears while you perform Auto Calibration, see “When error codes appear” (page 32) to solve the problem.

---

### PROTECT

Irregular current is output from the receiver. The receiver will automatically turn off after a few seconds. Check the speaker connection and turn on the power again.

---

## If you are unable to remedy the problem using the troubleshooting guide

Clearing the receiver’s memory may remedy the problem (page 27). However, note that all memorized settings will be reset to their factory settings and you will have to readjust all settings on the receiver.

### If the problem persist

Consult your nearest Sony dealer. Note that if service personnel changes some parts during repair, these parts may be retained.

## Reference sections for clearing the receiver’s memory

To clear	See
All memorized settings	page 27
Customized sound fields	page 58

# Specifications

## AUDIO POWER SPECIFICATIONS

### POWER OUTPUT AND TOTAL HARMONIC DISTORTION: (Models of area code U only)

With 8 ohm loads, both channels driven, from 20 – 20,000 Hz; rated 100 watts per channel minimum RMS power, with no more than 0.09% total harmonic distortion from 250 milliwatts to rated output.

#### Amplifier section

Models of area code U, CA<sup>1)</sup>

Minimum RMS Output Power (8 ohms, 20 Hz – 20 kHz, THD 0.09%)

100 W + 100 W

Stereo Mode Output Power (8 ohms, 1 kHz, THD 1%)

110 W + 110 W

Surround Mode Output Power<sup>2)</sup> (8 ohms, 1 kHz, THD 10%)

150 W/ch

<sup>1)</sup>Measured under the following conditions:

Area code	Power requirements
U, CA	120 V AC, 60 Hz

<sup>2)</sup>Reference power output for front, center, surround and surround back speakers. Depending on the sound field settings and the source, there may be no sound output.

#### Frequency response

Analog 10 Hz – 70 kHz,  
+0.5/-2 dB (with sound field and equalizer bypassed)

#### Input

Analog Sensitivity: 500 mV/50 kohms  
S/N<sup>3)</sup>: 96 dB  
(A, 500 mV<sup>4)</sup>)

Digital (Coaxial) Impedance: 75 ohms  
S/N: 100 dB  
(A, 20 kHz LPF)

Digital (Optical) S/N: 100 dB  
(A, 20 kHz LPF)

#### Output (analog)

AUDIO OUT Voltage: 500 mV/10 kohms

SUB WOOFER Voltage: 2 V/1 kohm

#### Equalizer

Gain levels ±10 dB, 1 dB step

<sup>3)</sup>INPUT SHORT (with sound field and equalizer bypassed).

<sup>4)</sup>Weighted network, input level.

#### FM tuner section

Tuning range 87.5 – 108.0 MHz

Antenna FM wire antenna

Antenna terminals 75 ohms, unbalanced

Intermediate frequency 10.7 MHz

#### AM tuner section

Tuning range

Area code	Tuning scale	
	10 kHz step	9 kHz step
U, CA	530 – 1,710 kHz <sup>5)</sup>	531 – 1,710 kHz <sup>5)</sup>

Antenna Loop antenna

Intermediate frequency 450 kHz

<sup>5)</sup>You can change the AM tuning scale to 9 kHz or 10 kHz. After tuning in any AM station, turn off the receiver. While holding down TUNING MODE, press I/⏏. All preset stations will be erased when you change the tuning scale. To reset the scale to 10 kHz (or 9 kHz), repeat the procedure.

## Video section

### Inputs/Outputs

Video: 1 Vp-p/75 ohms  
COMPONENT VIDEO:  
Y: 1 Vp-p/75 ohms  
P<sub>B</sub>/C<sub>B</sub>/B-Y: 0.7 Vp-p/  
75 ohms  
P<sub>R</sub>/C<sub>R</sub>/R-Y: 0.7 Vp-p/  
75 ohms  
80 MHz HD Pass Through

## General

### Power requirements

Area code	Power requirements
U, CA	120 V AC, 60 Hz

### Power output (DIGITAL MEDIA PORT)

DC OUT 5 V, 700 mA

### Power consumption

Area code	Power consumption
U	250 W
CA	340 VA

### Power consumption (during standby mode)

0.3 W (When  
“CONTROL” in VIDEO  
menu is set to “CTRL  
OFF”)

### AC outlets:

Area code	AC outlets
U, CA	1 switch, 120 W/1A MAX

### Dimensions (w/h/d) (Approx.)

430 × 157.5 × 316 mm  
(16 7/8 × 6 2/8 × 12 4/8  
inches) including  
projecting parts and  
controls

Mass (Approx.) 8.1 kg (17 lb 14 oz)

## Supplied accessories

FM wire antenna (1)  
AM loop antenna (1)  
Remote commander RM-AAP016 (1)  
R6 (size-AA) batteries (2)  
Optimizer microphone ECM-AC2 (1)

For details on the area code of the component you are using, see page 3.

Design and specifications are subject to change without notice.

# Index

## Numerics

- 2 channel 57
- 2CH STEREO 57
- 5.1 channel 15
- 6.1 channel 15

## A

- AUTO CALIBRATION 29
- AUTO FORMAT DIRECT 52

## C

- CD player
  - connecting 17
  - playback 37

## D

- DIGITAL ASSIGN 75
- Digital Cinema Sound (DCS) 56
- DIGITAL MEDIA PORT
  - connecting 73
  - input 35
  - video assign 74
- Dolby Digital 84
- DTS 85
- DVD player
  - connecting 22
  - playback 38
- DVD recorder
  - connecting 23

## E

- Error messages 90

## H

- HDMI
  - connecting 19

## I

- Initial setup 27
- INPUT MODE 71

## M

- Menu
  - A. CAL 33
  - AUDIO 46
  - EQ 44
  - LEVEL 43
  - SUR 44
  - SYSTEM 48
  - TUNER 46
  - VIDEO 47
- Muting 36

## N

- Naming 62, 76

## R

- Recording
  - onto a CD-R 78
  - onto a recording media 78
- Remote
  - programming 79

## S

- Satellite tuner
  - connecting 24
- Selecting
  - component 35
  - sound field 54
  - speaker system 28
- Sleep Timer 77
- Sound fields
  - resetting 58
  - selecting 54
- Speakers
  - connecting 16
- Super Audio CD player
  - connecting 17
  - playback 37
- SUR BACK DECODING 45

## T

- TEST TONE 34
- Tuner
  - connecting 26
- Tuning
  - automatically 59
  - directly 59
  - to preset stations 61
- TV
  - connecting 21

## V

- VCR
  - connecting 25
- Video game
  - connecting 25

## X

- XM radio 63







\* 2 8 9 8 6 3 9 1 1 \* (1)



## Free Manuals Download Website

<http://myh66.com>

<http://usermanuals.us>

<http://www.somanuals.com>

<http://www.4manuals.cc>

<http://www.manual-lib.com>

<http://www.404manual.com>

<http://www.luxmanual.com>

<http://aubethermostatmanual.com>

Golf course search by state

<http://golfingnear.com>

Email search by domain

<http://emailbydomain.com>

Auto manuals search

<http://auto.somanuals.com>

TV manuals search

<http://tv.somanuals.com>