

SOYO

OWNER'S MANUAL

MT-SYJCP32B1AB

PLASMA TV

Please read this manual carefully before operating your set.
Retain it for future reference.

WARNING / CAUTION



WARNING/CAUTION
RISK OF ELECTRIC SHOCK
DO NOT OPEN



TO REDUCE THE RISK OF ELECTRIC SHOCK DO NOT REMOVE COVER (OR BACK). NO USER SERVICEABLE PARTS INSIDE. REFER TO QUALIFIED SERVICE PERSONNEL.



The lightning flash with arrowhead symbol, within an equilateral triangle, is intended to alert the user to the presence of uninsulated “dangerous voltage” within the product’s enclosure that may be of sufficient magnitude to constitute a risk of electric shock to persons.



The exclamation point within an equilateral triangle is intended to alert the user to the presence of important operating and maintenance (servicing) instructions in the literature accompanying the appliance.

WARNING/CAUTION

TO REDUCE THE RISK OF FIRE AND ELECTRIC SHOCK, DO NOT EXPOSE THIS PRODUCT TO RAIN OR MOISTURE.

NOTE TO CABLE/TV INSTALLER

This reminder is provided to call the CATV system installer’s attention to Article 820-40 of the National Electric Code (U.S.A.). The code provides guidelines for proper grounding and, in particular, specifies that the cable ground shall be connected to the grounding system of the building, as close to the point of the cable entry as practical.

CAUTION

Do not attempt to modify this product in any way without written authorization from the dealer. Unauthorized modification could void the user’s authority to operate this product.

WARNING / CAUTION

To prevent fire or shock hazards, do not expose this product to rain or moisture.

FCC NOTICE

Class B digital device

This equipment has been tested and found to comply with the limits for a Class B digital device, pursuant to Part 15 of the FCC Rules.

These limits are designed to provide reasonable protection against harmful interference in a residential installation.

This equipment generates, uses and can radiate radio frequency energy and, if not installed and used in accordance with the instructions, may cause harmful interference to radio communications.

However, there is no guarantee that interference will not occur in a particular installation.

If this equipment does cause harmful interference to radio or television reception, which can be determined by turning the equipment off and on, the user is encouraged to try to correct the interference by one or more of the following measures:

- Reorient or relocate the receiving antenna.
- Increase the separation between the equipment and receiver.
- Connect the equipment to an outlet on a circuit different from that to which the receiver is connected.
- Consult the dealer or an experienced radio/TV technician for help.

Caution

Changes or modification not expressly approved by the party responsible for compliance could void the user's authority to operate the equipment.

On Disposal

- a. The fluorescent lamp used in this product contains a small amount of mercury.
- b. Do not dispose of this product with general household waste.
- c. Disposal of this product must be carried out in accordance to the regulations of your local authority.

Important Safety Instructions

1. Read these instructions.
2. Keep these instructions.
3. Heed all warnings.
4. Follow all instructions.
5. Do not use this apparatus near water.
6. Clean only with dry cloth.
7. Do not block any ventilation openings.
Install in accordance with the manufacturer's instructions.
8. Do not install near any heat sources such as radiators, heat registers, stoves, or other apparatus (including amplifiers) that produce heat.
9. Do not defeat the safety purpose of the polarized or grounding-type plug. A polarized plug has two blades with one wider than the other. A grounding type plug has two blades and a third grounding prong. The wide blade or the third prong are provided for your safety. If the provided plug does not fit into your outlet, consult an electrician for replacement of the obsolete outlet.
10. Protect the power cord from being walked on or pinched particularly at plugs, convenience receptacles, and the point where they exit from the apparatus.
11. Only use attachments/accessories specified by the manufacturer.
12. Use only with the cart, stand, tripod, bracket, or table specified by the manufacturer, or sold with the apparatus. When a cart is used, use caution when moving the cart/apparatus combination to avoid injury from tip-over.



13. Unplug this apparatus during lightning storms or when unused for long periods of time.
14. Refer all servicing to qualified service personnel. Servicing is required when the apparatus has been damaged in any way, such as power-supply cord or plug is damaged, liquid has been spilled or objects have fallen into the apparatus, the apparatus has been exposed to rain or moisture, does not operate normally, or has been dropped.
15. Do not expose this apparatus to dripping or splashing and ensure that no objects filled with liquids, such as vases, are placed on the apparatus.

Important Safety Instructions

16. To completely disconnect this apparatus from the AC Mains, disconnect the mains plug from the AC receptacle.
17. The mains plug of the power supply cord shall remain readily operable.
18. This apparatus shall be connected to a Mains socket outlet with a protective earthing connection.

NOTE

Prolonged use of headphones at a high volume may cause health damage on your ears.



The lightning flash with arrowhead symbol within an equilateral triangle, is intended to alert the user to the presence of uninsulated "dangerous voltage " within the product's enclosure that may be of sufficient magnitude to constitute a risk of electric shock to persons.



The exclamation point within an equilateral triangle is intended to alert the user to the presence of important operating and maintenance (servicing) instructions in the literature accompanying the product.

WARNING: To reduce the risk of fire or electric shock, do not expose this apparatus to rain or moisture .

Contents

WARNING / CAUTION	3-4
Important Safety Instructions	5-6
Contents	7-8
Accessories	9
Supplied Accessories	9
Installing Batteries	9
Controls	10-13
Front Panel	10
Rear Panel	11
Remote Control	12-13
Installation	14
Wall mount Installation	14
Desktop Pedestal Installation	14
Connections	15-24
Antenna Connection	15
VCR Connection	16-17
DVD Connection	18-19
HDSTB Connection	20-21
External A/V Source	22
Digital Audio Out	22
PC Connection	23
Resolution	24
Basic Operation	25-26
Turning On or Off	25
Channel Selection	25
Volume Adjustment	25
Sound Mute	25
Quick View	25
Input Selection	26
Language Selection	26
On Screen Menus	27
Setting up TV Channel	28-30
Auto Scan	28
Add/Delete Channel	29
EPG(Electronic Program Guide)	30
Picture Controls	31-33
Auto Picture Controls	31
Manual Picture Controls	32
Color Temperature	33
Advanced Video	34-39
Dynamic Noise Reduce	34
Black Level Extender	35
White Peak Limiter	36

Contents

CTI	37
Flesh Tone	38
Adaptive Luma Control	39
Sound Controls	40-42
Auto Sound Controls	40
Manual Sound Controls	41
Auto Volume Control	42
Stereo/SAP Broadcast Setup	42
Time Setting	44-47
Time Zone Setting	43
Auto Time Setting	44
Manual Time Setting	45
Auto On/Off Time Setting	46
Sleep Timer	47
Captions	49-50
Closed Caption-Analog	48
Closed Caption-Digital	49
Closed Caption Options	50
Reset	51
Reset Default	51
Parental Control	52-60
Enter the your password	52
Set Password	52
Rating Enable/Disable	53
TV Ratings for USA	54-55
Movie Ratings	56
TV Rating English for Canada	57
TV Rating French for Canada	58
Downloadable Rating	59
Clean All	60
Setting the PC Mode	61-65
Auto Picture Controls	61
Manual Picture Controls	62
Color Temperature	63
Auto Adjustment	64
Manual Adjustment	65
Special Functions	66
Picture Format	66
Specification	67
Troubleshooting	68
Warranty Card	70
Registration Card	71-72

Accessories

Supplied Accessories

Ensure that the following accessories are included with your product.

If an accessory is missing, please contact the dealer where you purchased the product.

User must use shielded signal interface cables with ferrite cores to maintain standard compliance for the product.

1. Remote
2. Batteries
3. Power Cord
4. Owner's Manual

Installing Batteries



1

Open the battery cover on the back side.

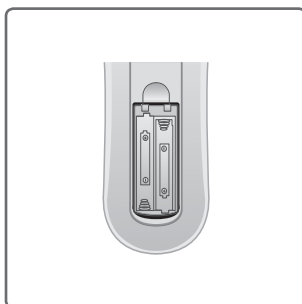

2

Insert two batteries in correct polarity, match (+ with +), and match (- with -).
Don't mix old batteries with new batteries.



3

Close the battery cover.

Controls

Front Panel

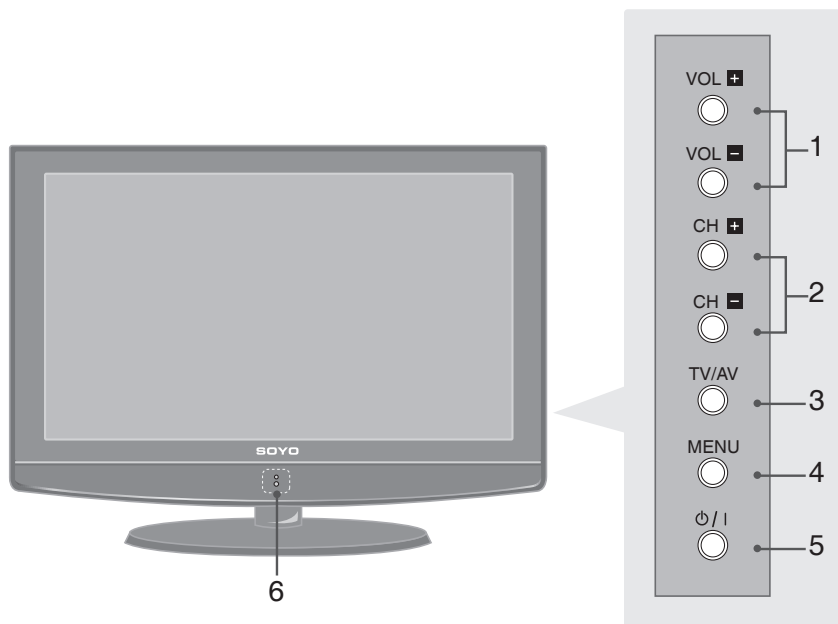

- 1. VOL + /VOL -**
Adjusts menu setting.
Adjusts sound level.
- 2. CH + /CH -**
Select a channel.
- 3. TV/AV**
Selects the **TV**, **AV**, **S-Video**, **YPbPr**, **VGA** or **HDMI** mode.
- 4. MENU**
Display on screen menus.
- 5. POWER**
Switches the set on or off.
- 6. Power Indicator**
Illuminates in bright blue when the TV is in standby mode.
Illuminates in dark blue when the TV is switched on.
Remote control sensor
Accepts the IR signal of remote controller.

NOTE

Here shown may be somewhat different from your set.

Controls

Rear Panel

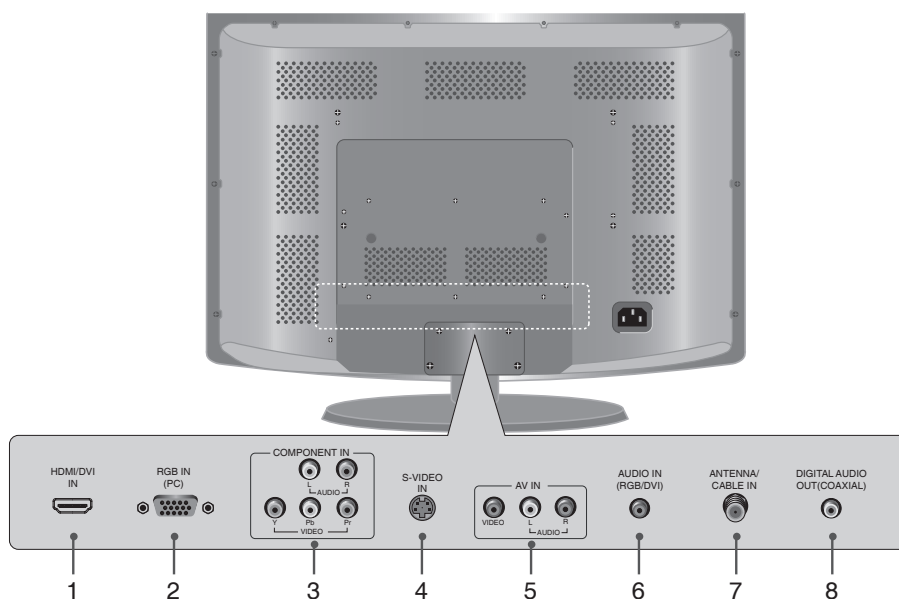

1. HDMI/DVI IN

Connect to the HDMI jack for device with HDMI output. (This input can also be used as a DVI connection with an HDMI to DVI adaptor and separate analog audio inputs.)

2. RGB IN (PC)

Connect to the video output jack on your PC.

3. COMPONENT IN

Video/Audio inputs for Component.

4. S-VIDEO IN

Connect the output of an S-VIDEO device to the S-VIDEO input.

5. AV IN

Connect RCA cable to an appropriate external A/V device such as VCR, DVD or Camcorder.

6. AUDIO IN (RGB/DVI)

Connect to the audio output jack on your PC.

7. ANTENNA/CABLE IN

Connect to your antenna or cable box for TV signal.

8. DIGITAL AUDIO OUT (COAXIAL)

Connect digital audio to various types of equipment.

Controls

Remote Control

- All the functions can be controlled with the remote control handset.
- Some functions can also be adjusted with the buttons on the side panel of the set.
- Before you use remote control handset, please install the batteries.

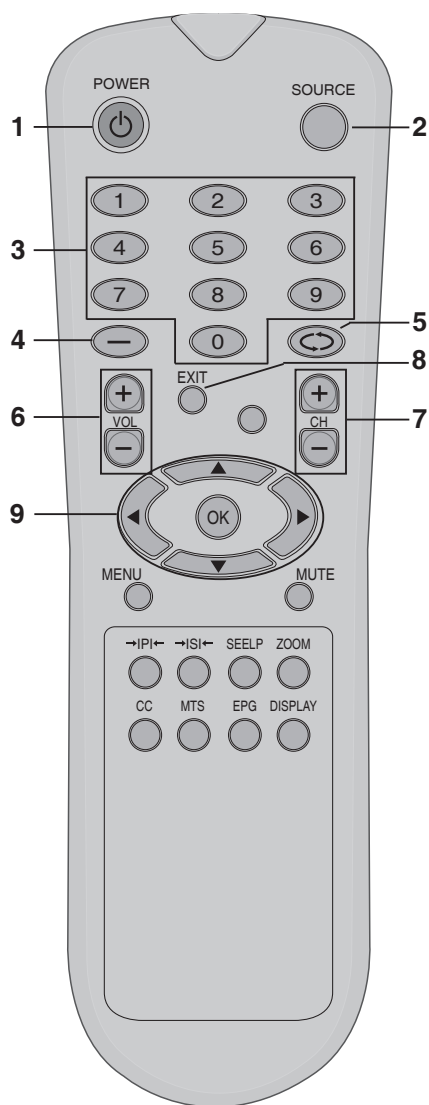

1. POWER

Switches the set on or off.

2. SOURCE

Selects the **TV, AV, S-Video, YPbPr, VGA** or **HDMI** mode.

3. NUMBER BUTTONS

Selects channel numbers.

4. Hyphen(—)

Press to select DTV channels.

For example, to select channel '10-1', press '10' then press '—' and '1'.

5. ↶

Switch to the previous channel number.

6. VOL+ / VOL-

Adjusts sound level.

7. CH+ / CH-

Select a channel.

8. EXIT

Clear all on-screen menus and return to TV viewing from any menu.

9. Navigational Controls

Adjusts menu settings.

Selects menu item.

Accepts your selection.

Controls

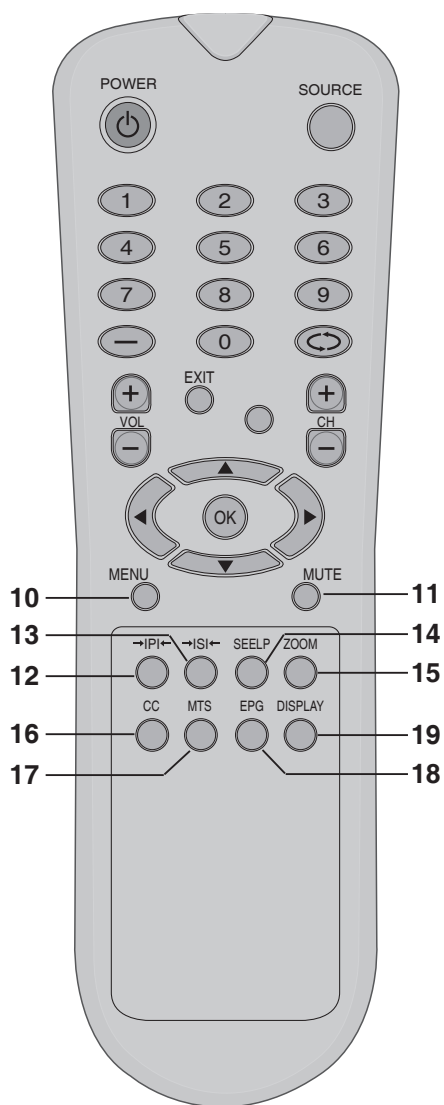

- 10. MENU**
Display on screen menus.
- 11. MUTE**
Switches the sound on or off.
- 12. →PI←**
Recalls your preferred picture setting.
- 13. →SI←**
Recalls your preferred sound setting.
- 14. SLEEP**
Sets the sleep timer.
- 15. ZOOM**
Selects your desired picture format.
- 16. CC**
Select the Caption menu directly.
- 17. MTS**
Select MTS sound : Mono, Stereo and SAP in Analog Channel.
Change the audio language in DTV Channel.
- 18. EPG**
Displays the program guide.
- 19. DISPLAY**
Shows the present screen information.

Installation

Wall mount Installation

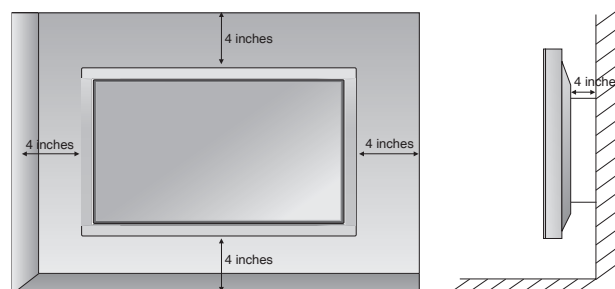
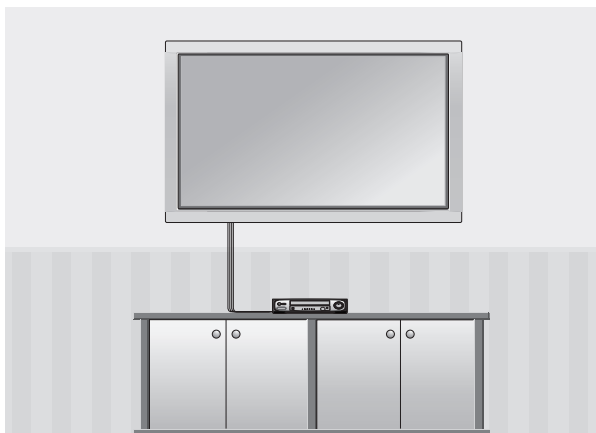

The set can be installed on a wall as shown above.
For proper ventilation, allow a clearance of 4 inches on all four sides from the wall.
Detailed instructions are available from your dealer, refer to the optional Wall Mounting Bracket Installation and Setup Guide. (Wall Mount Sold Separately)

Desktop Pedestal Installation

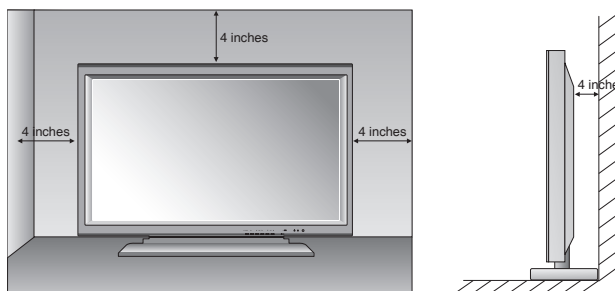

The set can be mounted on a desk as shown above.
For proper ventilation, allow a clearance of 4 inches on each side from the wall.
Detailed instructions are available from your dealer, refer to the optional Desktop Stand Installation and Setup Guide.

Connections

Antenna Connection

Multi-family Dwellings/ Apartments
(Connect to wall antenna socket)



Wall Antenna Socket

RF Coaxial Wire (75 ohm)

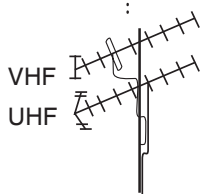

Outdoor Antenna



Single-family Dwellings /Houses
(Connect to wall jack for outdoor antenna)

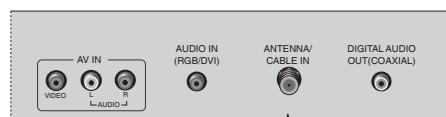

Turn clockwise to tighten.



Be careful not to bend the bronze wire when connecting to an antenna port.

* Separately purchase a RF Coaxial Wire(75 ohm)

NOTE

- To improve the picture quality in a poor signal area, please purchase a signal amplifier and install properly.
- If the antenna is not installed properly, contact your dealer for assistance.

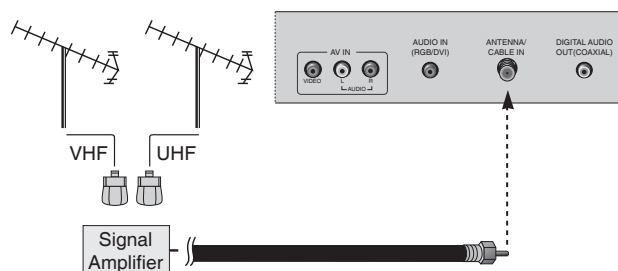

Connections

VCR Connection

- To avoid picture noise (interference), leave an adequate distance between the TV and the VCR.

A When connecting with an antenna

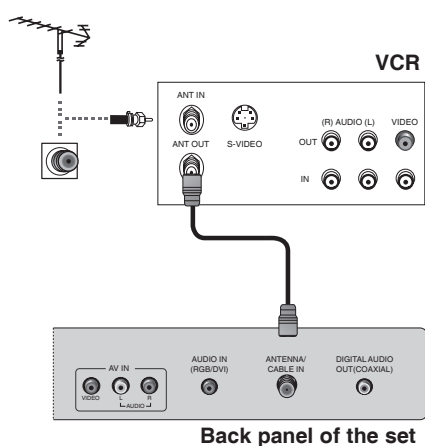

1. Connect the Antenna out socket of the VCR to the Antenna input socket on the TV.
2. Press the **PLAY** button on the VCR and match the appropriate input selection between the TV and VCR for viewing.

A When connecting with an RCA cable

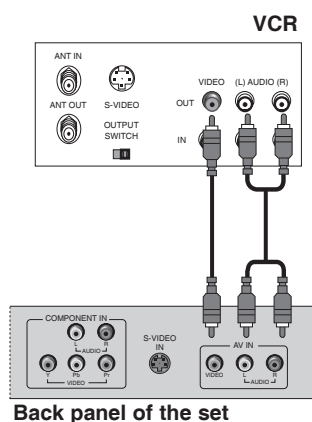

1. Connect the AUDIO/VIDEO jacks between TV and VCR. Match the jack colors (Video = yellow, Audio Left = white, and Audio Right = red)
2. Insert a video tape into the VCR and press **PLAY** on the VCR.
3. Select the **AV** input source with using the **SOURCE** button on the remote control.
4. Refer to the VCR manual for operating instructions.

Connections

A When connecting with an S-Video cable

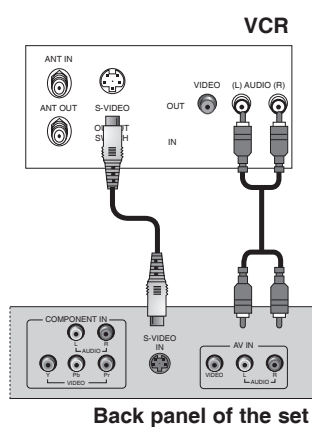

1. Connect the **S-VIDEO** output of the VCR to the **S-VIDEO** input on the set. The picture quality is improved; compared to normal composite (RCA cable) input.
2. Connect the audio outputs of the VCR to the **AV AUDIO L, R** input jacks on the set.
3. Insert a video tape into the VCR and press **PLAY** on the VCR.
4. Select the **S-Video** input source with using the **SOURCE** button on the remote control.
5. Refer to the VCR manual for operating instructions.

Connections

DVD Connection

A When connecting with a S-Video cable

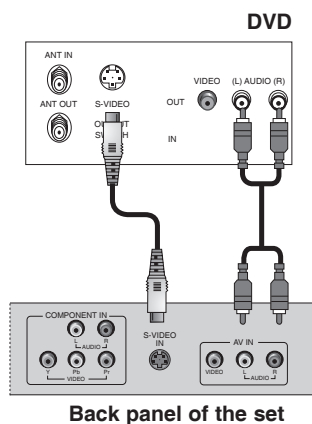

1. Connect the **S-VIDEO** output of the DVD to the **S-VIDEO** input on the set.
2. Connect the audio outputs of the DVD to the **AV AUDIO L, R** input jacks on the set.
3. Turn on the DVD player, insert a DVD.
4. Select **S-Video** input source with using the **SOURCE** button on the remote control.
5. Refer to the DVD player's manual for operating instructions.

A When connecting with a Component cable

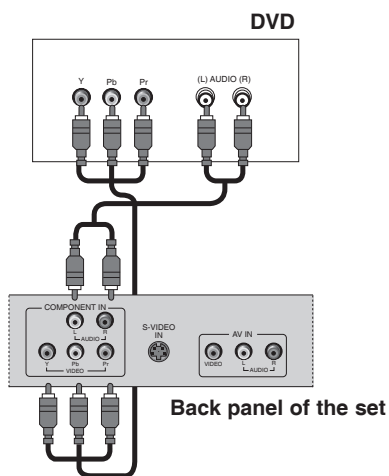

1. Connect the video outputs (Y, PB, PR) of the DVD to the **COMPONENT VIDEO(Y, Pb, Pr)** jacks on the set.
2. Connect the audio outputs of the DVD to the **COMPONENT AUDIO L, R** jacks on the set.
3. Turn on the DVD player, insert a DVD.
4. Select **YPbPr** source with using the **SOURCE** button on the remote control.
5. Refer to the DVD player's manual for operating instructions.

Connections

A When connecting with a HDMI cable

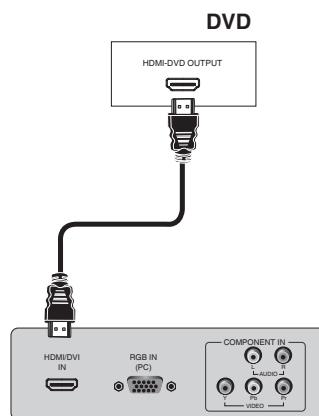

Back panel of the set

1. Connect the **HDMI** output of the DVD to the **HDMI/DVI IN** jack on the set.
2. Select **HDMI** input source with using the **SOURCE** button on the remote control.
3. Refer to the DVD player's manual for operating instructions.

Connections

HDSTB Connection

- This TV can receive Digital Over-the-air/Cable signals without an external digital set-top box. However, if you do receive Digital signals from a digital set-top box or other digital external device, refer to the figure as shown below.

A When connecting with a D-Sub 15 pin cable

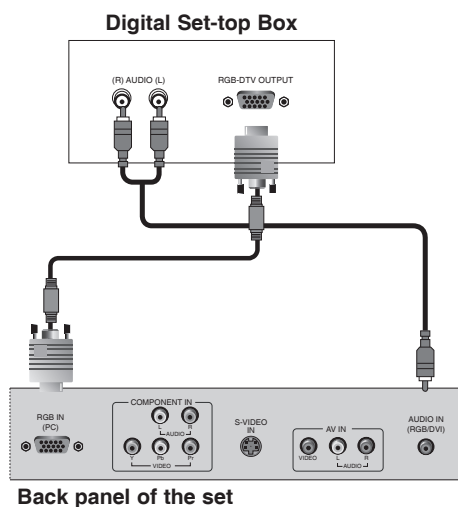

1. Connect the **RGB** output of the digital set-top box to the **RGB IN (PC)** jack on the set.
2. Connect the audio outputs of the set-top box to the **AUDIO IN (RGB/DVI)** jack on the set.
3. Turn on the digital set-top box.
4. Select **VGA** input source with using the **SOURCE** button on the remote control.
5. Refer to the digital set-top box manual for operating instructions.

A When connecting with a HDMI cable

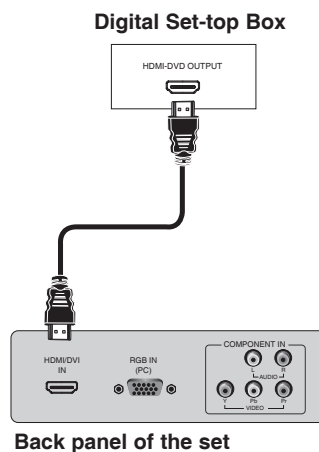

1. Connect the **HDMI** output of the digital set-top box to the **HDMI/DVI IN** jack on the set.
2. Turn on the digital set-top box.
3. Select **HDMI** input source with using the **SOURCE** button on the remote control.
4. Refer to the digital set-top box manual for operating instructions.

Connections

A When connecting with a Component cable

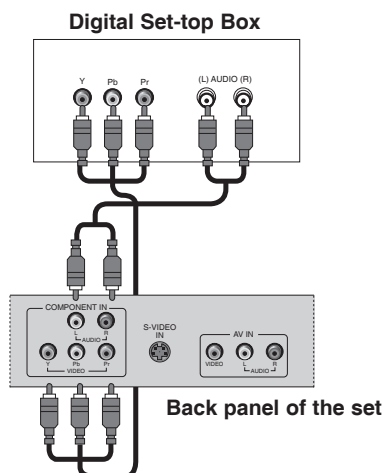

1. Connect the video outputs (Y, PB, PR) of the digital set-top box to the **COMPONENT VIDEO(Y, Pb, Pr)** jacks on the set.
2. Connect the audio outputs of the digital set-top box to the **COMPONENT AUDIO L, R** jacks on the set.
3. Turn on the digital set-top box.
4. Select **YPbPr** source with using the **SOURCE** button on the remote control.
5. Refer to the digital set-top box manual for operating instructions.

A When connecting with a HDMI to DVI cable

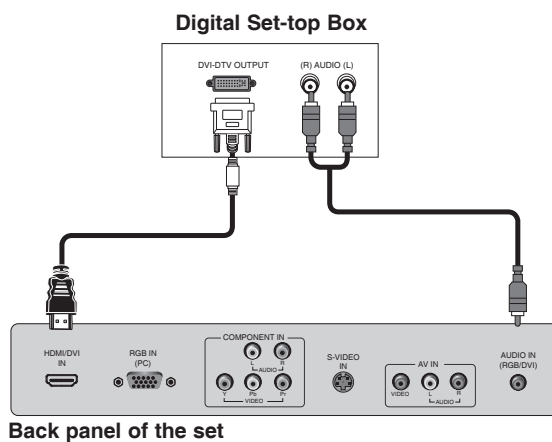

1. Connect the DVI output of the digital set-top box to the **HDMI/DVI IN** jack on the set.
2. Connect the audio outputs of the set-top box to the **AUDIO IN (RGB/DVI)** jack on the set.
3. Turn on the digital set-top box.
4. Select **HDMI** input source with using the **SOURCE** button on the remote control.
5. Refer to the digital set-top box manual for operating instructions.

Connections

External A/V Source

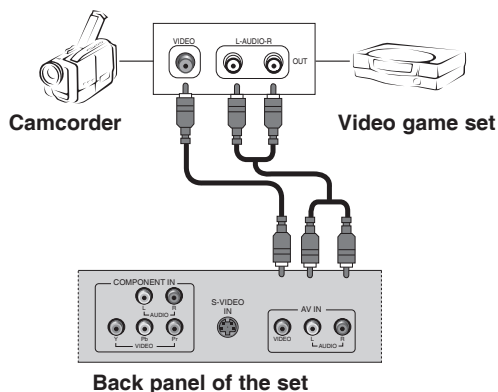

1. Connect the AUDIO/VIDEO jacks between TV and external equipment. Match the jack colors (Video = yellow, Audio Left = white, and Audio Right = red)
2. Select the **AV** input source with using the **SOURCE** button on the remote control.
3. Operate the corresponding external equipment.
4. Refer to the external equipment manual for operating instructions.

Digital Audio Out

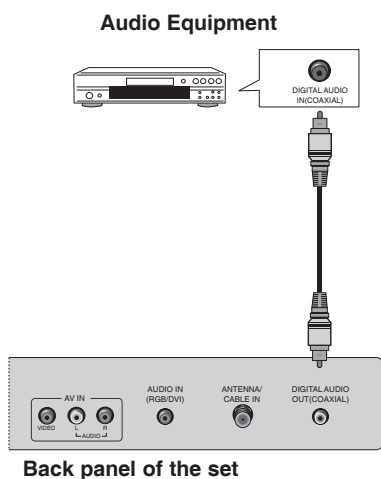

1. Connect one end of the coaxial cable to the TV's SPDIF OUT port.
2. Connect the other end of the coaxial cable to the digital audio input on the audio equipment.
3. Refer to the external audio equipment manual for operation.

Connections

PC Connection

A When connecting with a D-Sub 15 pin cable

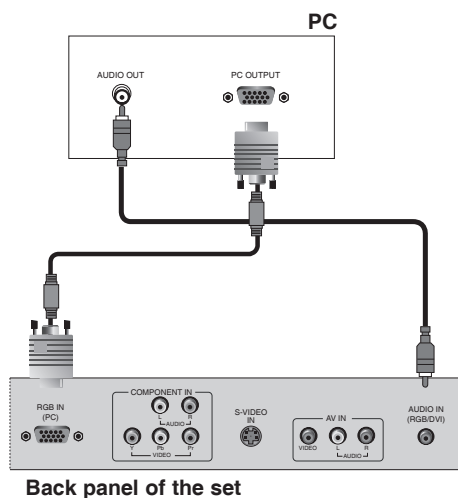

1. Connect the **RGB** output of the PC to the **RGB IN(PC)** jack on the set.
2. Connect the PC audio outputs to the **AUDIO IN (RGB/DVI)** jack on the set.
3. Turn on the PC and the set.
4. Select **VGA** input source with using the **SOURCE** button on the remote control.

A When connecting with a HDMI to DVI cable

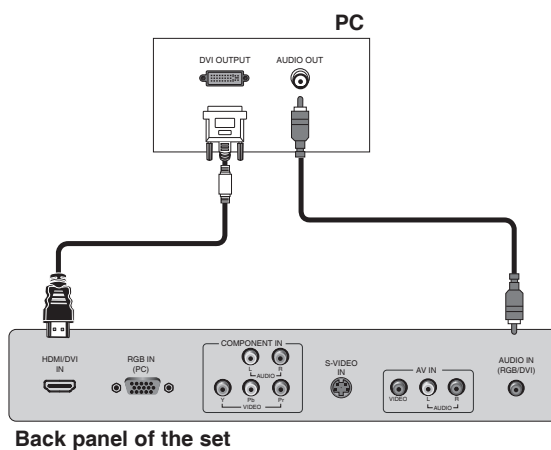

1. Connect the DVI output of the PC to the **HDMI/DVI IN** jack on the set.
2. Connect the PC audio outputs to the **AUDIO IN (RGB/DVI)** jack on the set.
3. Turn on the PC and the set.
4. Select **HDMI** input source with using the **SOURCE** button on the remote control.

Connections

Resolution

Resolution	Horizontal Frequency (kHz)	Vertical Frequency (Hz)
640 x 350	37.86	85.08
640 x 400	37.86	85.08
640 x 480	31.47	59.94
	37.86	72.81
	37.50	75.00
	43.27	85.01
800 x 600	35.16	56.25
	37.88	60.32
	48.08	72.19
	46.88	75.00
	53.67	85.00
1024 x 768	48.36	60.00
	56.48	70.07
	60.02	75.03

NOTE

- a. The synchronization input form is separate.
- b. If the resolution is not supported, 'Not Support!' message will be displayed.

Basic Operation

Turning On or Off

Standby Setup: The AC power cord must be set up and connected to have the TV in standby mode ready to be turned on. Press the **ON/OFF** button on the side panel of the TV to go into standby mode.

1. If the TV is in standby mode, press the **POWER** button on the remote or the TV itself to turn the TV on.
2. Press the **POWER** button again on the remote controller or the TV itself to turn the TV off.

Channel Selection

You can select a channel number with the **CH+** / **CH-** button or **NUMBER** buttons.

Volume Adjustment

Press the **VOL+** / **VOL-** button to adjust the sound level.

Sound Mute

Press the **MUTE** button. The sound is switched off and the mute display appears. To cancel mute mode, press the **MUTE** or **VOL+** / **VOL-** button again.

Quick View

Press the  button to view the last channel you were watching.

Basic Operation

Input Selection

1. Press the **SOURCE** button to change the input mode.
2. Press the **D** or **E** button to select your desired mode.
3. Press the **OK** button to change your selected mode.

Input Source	
√	TV
	AV
	S-Video
	YPbPr
	VGA
	HDMI

Language Selection

1. Press the **MENU** button and then press the **Down** or **Up** button to select the **Setup**.
2. Press the **OK** button and then press the **Down** or **Up** button to select **OSD Language**.
3. Press the **Left** or **Right** button to select desired your language.
4. All the on screen menu will appear in the selected language.

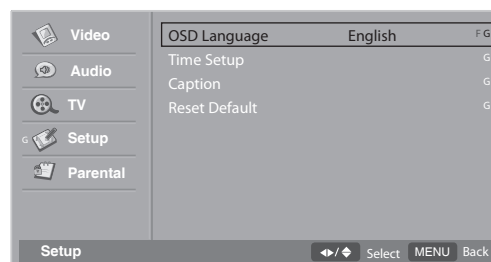

On Screen Menus

Your TV's OSD(On Screen Display) may differ slightly from what is shown in this manual.

1. Press the **MENU** button and then use **Down** or **Up** button to select each menu.
2. Press the **OK** button and then **Down, Up, Left or Right** button to display the available menus.

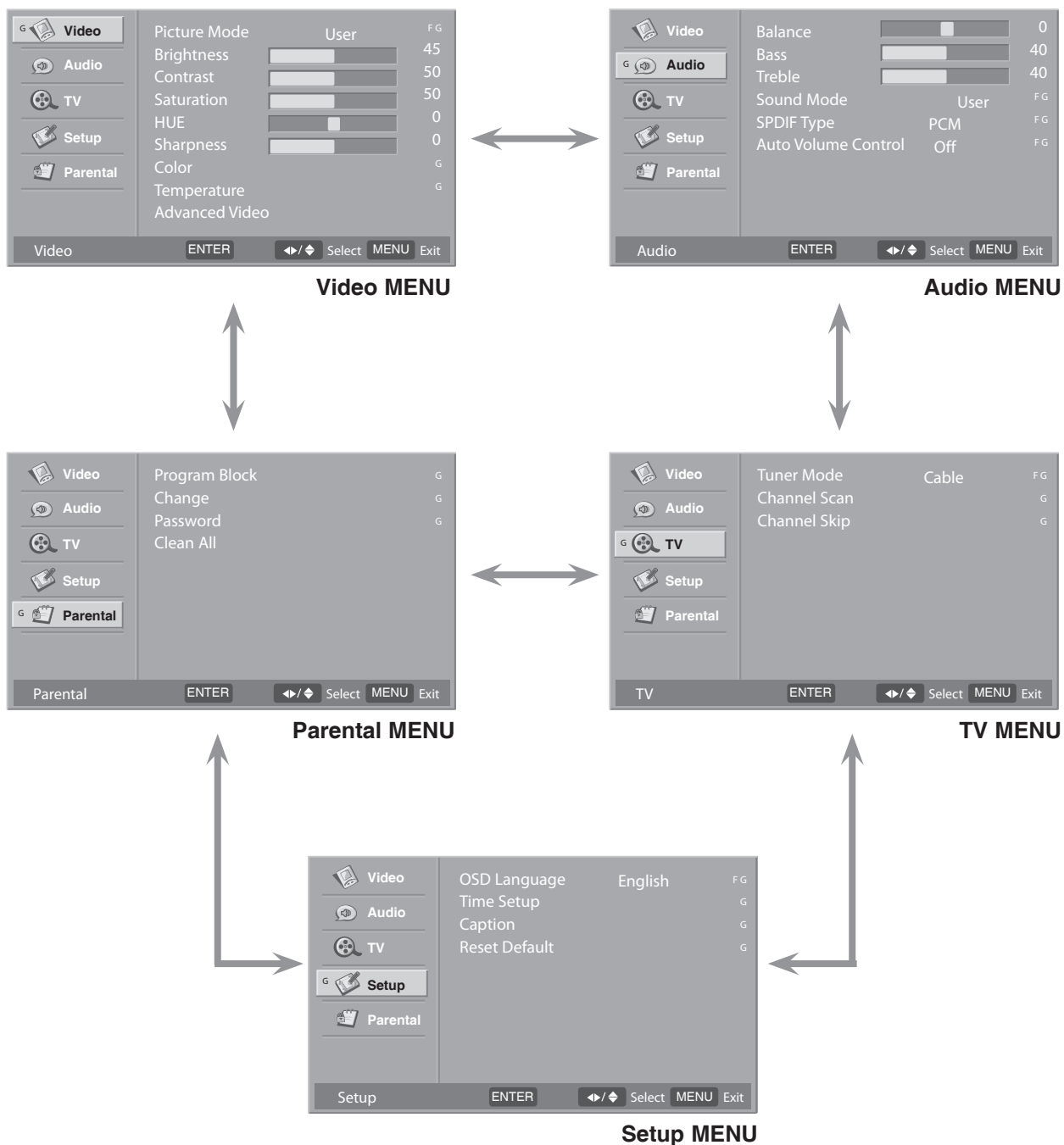

Setting up TV Channel

Auto Scan

Automatically find all channels available through Antenna or Cable and stores them in memory on the channel list.

1. Press the **MENU** button and then press the Down or Up button to select the **TV**.
2. Press the **OK** button and then press the Down or Up button to select **Tuner Mode**.
3. Press the Down or Up button to select **Antenna** or **Cable**.
4. Press the Down or Up button to select **Channel Scan**.
5. Press the **OK** button to start auto search. The TV will begin memorizing all of the available channels.
6. Press the **MENU** button at any time to interrupt the memorization process.

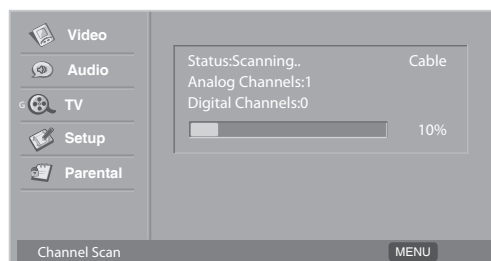
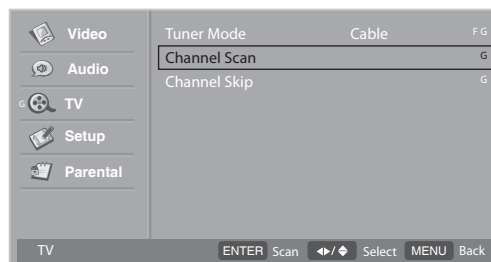
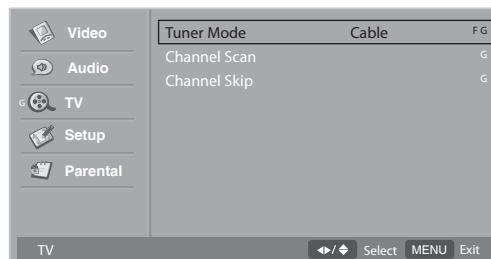

Setting up TV Channel

Add/Delete Channel

You can manually store the channel in whatever order you desire.

1. Press the **MENU** button and then press the Down or Up button to select the **TV**.
2. Press the **OK** button and then press the Down or Up button to select **Channel Skip**.
3. Press the **OK** button and then press the Down or Up button to select channel you want to add or delete. If you want to skip the selected channel, press the **OK** button.
4. Save the other channels in the same method.
5. Press the **MENU** button to return to the previous menu.

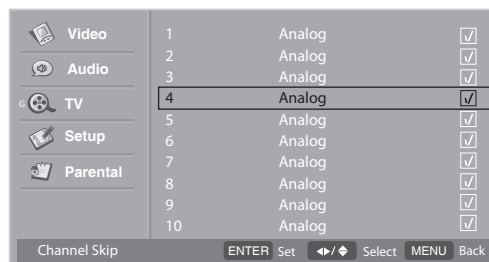
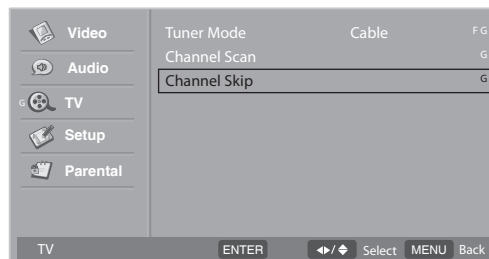

Setting up TV Channel

EPG(Electronic Program Guide)

Displays Broadcasting guide of received channel.

1. Press the **EPG** button to display the EPG.
The EPG appears on the screen.
2. Press the **Left** or **Right** button to change channel and displays broadcasting guide in the bottom of screen.

Sunday, 3-February-2008 9:00:00 PM		
7 F	7-1 ABC D-2	G8
Today	9:00 PM	HD
Today	10:00 PM	
Today	11:00 PM	
Tomorrow	12:00 AM	ABC
Tomorrow	12:50 AM	HD1
E		
9:01 PM-10:09 PM Sun, 3-Feb		Not Rated

Picture Controls

Auto Picture Controls

Picture Mode adjusts the set for the best picture appearance. Select the preset value in the Picture Mode menu.

1. Press the **MENU** button and then press the Down or Up button to select the **Video**.
2. Press the **OK** button and then press the Down or Up button to select **Picture Mode**.
3. Press the Down or Up button to select **Soft**, **Standard**, **Vivid** or **User**.
4. Press the **MENU** button to return to the previous menu.

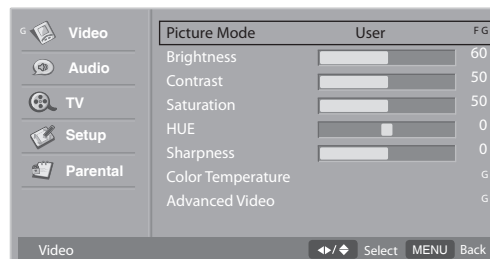

Soft

Select this option to display with a soft image.

Standard

The most general and natural screen display status.

Vivid

Select this option to display with a sharp image.

User

Select this option to use the user-defined setting.

NOTE

- If you want to select **Picture Mode** directly, press the **→|PI|←** button.
- Every time you press the button, it will switch between **Soft**, **Standard**, **Vivid** or **User**.
- When you adjust **Brightness**, **Contrast**, **Saturation**, **HUE** or **Sharpness**, **Picture Mode** changes to **User**.

Picture Controls

Manual Picture Controls

You can adjust picture **Brightness**, **Contrast**, **Saturation**, **HUE** and **Sharpness** to the levels you prefer.

1. Press the **MENU** button and then press the Down or Up button to select the **Video**.
2. Press the **OK** button and then press the Down or Up button to select desired picture option. (**Brightness**, **Contrast**, **Saturation**, **HUE**, **Sharpness**)
3. Press the **OK** button and then press the Down or Up button to make appropriate adjustments.
4. Press the **MENU** button to return to the previous menu.

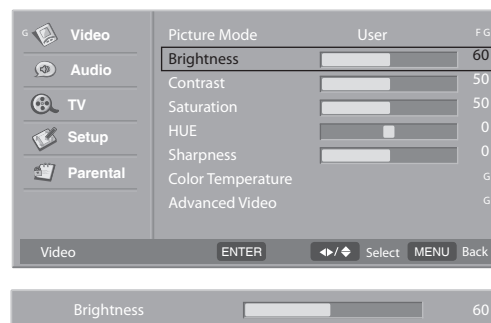

Brightness

Increases or decreases amount of white in the your picture.

Contrast

Adjusts the difference between the light and dark levels in the picture.

Saturation

Adjusts intensity of all colors.

HUE

Adjusts the balance between red and green levels.

Sharpness

Adjusts the level of sharpness in the edges between the light and dark areas of the picture. The lower the level, the softer the image.

Picture Controls

Color Temperature

You can adjust to color temperature you prefer.

1. Press the **MENU** button and then press the Down or Up button to select the **Video**.
2. Press the **OK** button and then press the Down or Up button to select **Color Temperature**.
3. Press the **OK** button and then press the Left or Right button to select **Cool**, **Standard**, **Warm** or **User**.
4. Press the Down or Up button to select desired color item.
5. Press the **OK** button and then press the Left or Right button to make appropriate adjustments.
6. Press the **MENU** button to return to the previous menu.

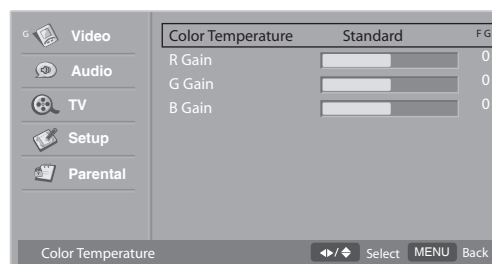
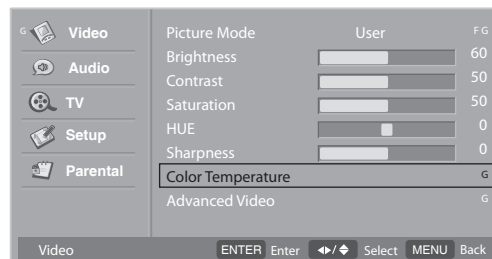

NOTE

- When you adjust **R Gain**, **G Gain** or **B Gain**, **Color Temperature** change to **User**.

Advanced Video

Dynamic Noise Reduce

Use this feature to diminish picture artifacts caused by the digitizing of image motion content that may be present in the picture.

1. Press the **MENU** button and then press the Down or Up button to select the **Video**.
2. Press the **OK** button and then press the Down or Up button to select **Advanced Video**.
3. Press the **OK** button and then press the Down or Up button to select **DNR**.
4. Press the Left or Right button to select **Off**, **Low**, **Medium**, **Strong** or **Auto**.
5. Press the **MENU** button to return to the previous menu.

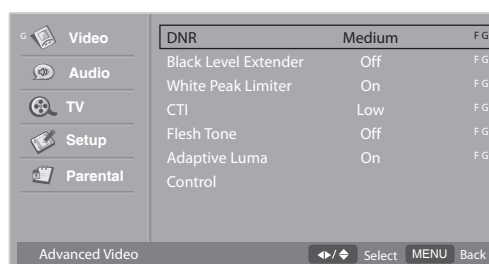
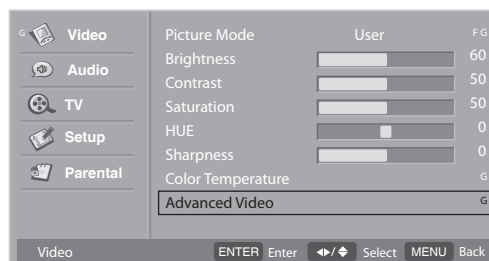

Off

Turns the screen noise reduction function off.

Low

Reduces screen noise at a low level.

Medium

Reduces screen noise at a medium level.

Strong

Reduces screen noise at a high level.

Auto

Adjusts automatically screen noise according to received signal.

Advanced Video

Black Level Extender

Use this feature to increase the picture reproduction performance in the dark areas of the picture.

1. Press the **MENU** button and then press the Down or Up button to select the **Video**.
2. Press the **OK** button and then press the Down or Up button to select **Advanced Video**.
3. Press the **OK** button and then press the Down or Up button to select **Black Level Extender**.
4. Press the Left or Right button to select **On** or **Off**.
5. Press the **MENU** button to return to the previous menu.

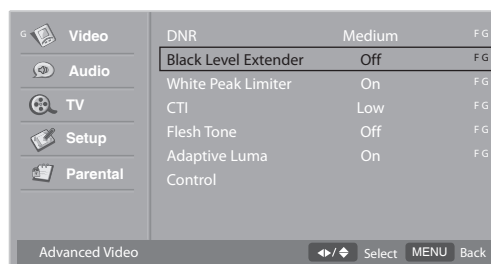
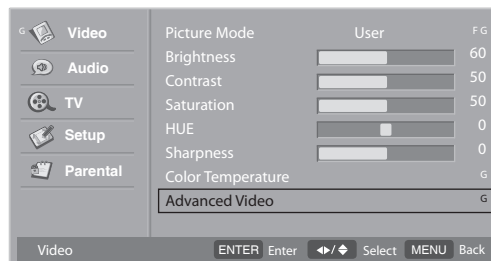

Advanced Video

White Peak Limiter

Use this feature to limit excessive white in bright areas of the picture, caused by a lower sync level for a channel being received from the antenna or cable.

1. Press the **MENU** button and then press the Down or Up button to select the **Video**.
2. Press the **OK** button and then press the Down or Up button to select **Advanced Video**.
3. Press the **OK** button and then press the Down or Up button to select **White Peak Limiter**.
4. Press the Left or Right button to select **On** or **Off**.
5. Press the **MENU** button to return to the previous menu.

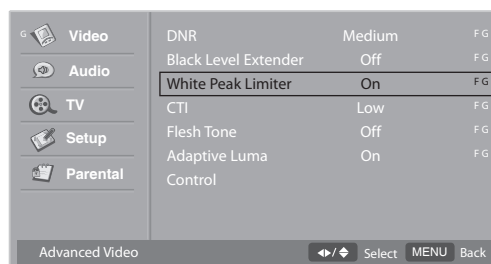
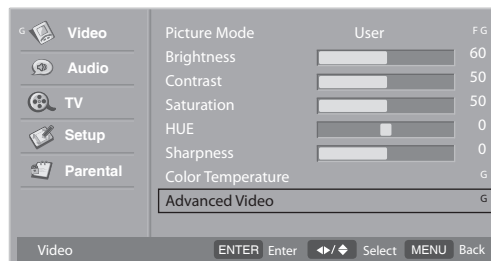

Advanced Video

CTI(Color Transient Intensity)

This feature can be used to reduce the time taken to transition from one color to another. The effect will be seen as sharpening the border between colors.

1. Press the **MENU** button and then press the Down or up button to select the **Video**.
2. Press the **OK** button and then press the Down or Up button to select **Advanced Video**.
3. Press the **OK** button and then press the Down or Up button to select **CTI**.
4. Press the Left or Right button to select **Off**, **Low**, **Medium** or **Strong**.
5. Press the **MENU** button to return to the previous menu.

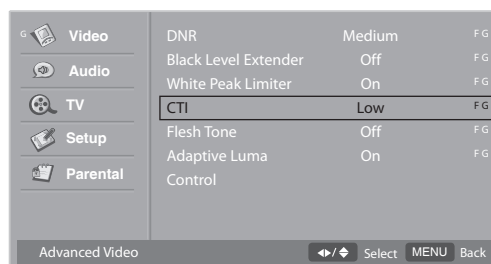
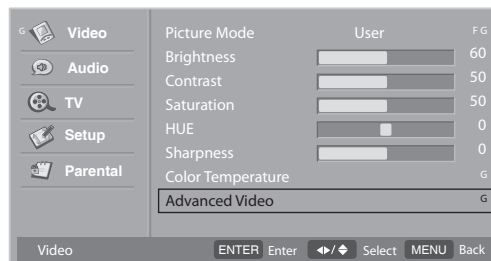

Advanced Video

Flesh Tone

In some cases, activation of this feature can result in a more pleasing production of sky and flesh color.

1. Press the **MENU** button and then press the Down or Up button to select the **Video**.
2. Press the **OK** button and then press the Down or Up button to select **Advanced Video**.
3. Press the **OK** button and then press the Down or Up button to select **Flesh Tone**.
4. Press the Left or Right button to select **On** or **Off**.
5. Press the **MENU** button to return to the previous menu.

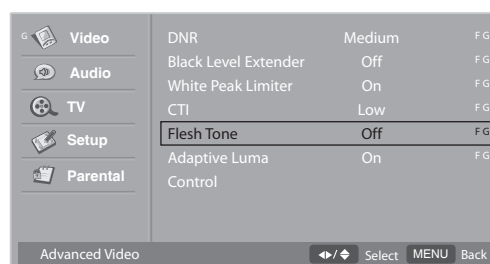
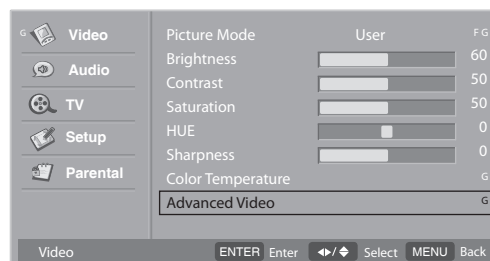

NOTE

- **Flesh Tone** can not adjust in PC mode.

Advanced Video

Adaptive Luma Control

Large areas of darkness in a picture will result in a lower Average Picture Level (APL) and the overall picture will look too dark; activation of this feature will raise the APL to counteract this effect.

1. Press the **MENU** button and then press the Down or Up button to select the **Video**.
2. Press the **OK** button and then press the Down or Up button to select **Advanced Video**.
3. Press the **OK** button and then press the Down or Up button to select **Adaptive Luma Control**.
4. Press the Left or Right button to select **On** or **Off**.
5. Press the **MENU** button to return to the previous menu.

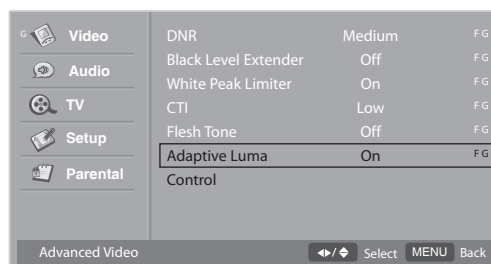
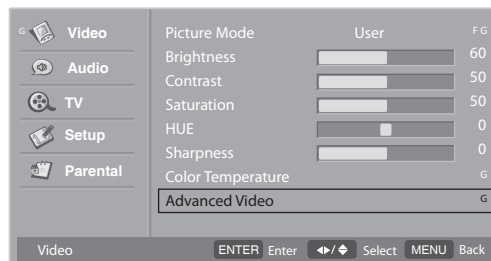

Sound Controls

Auto Sound Controls

Sound Mode lets you enjoy the best sound without any special adjustment because the set sets the appropriate sound options.

1. Press the **MENU** button and then press the Down or Up button to select the **Audio**.
2. Press the **OK** button and then press the Down or Up button to select **Sound Mode**.
3. Press the Left or Right button to select **Voice**, **Concert**, **Jazz** or **User**.
4. Press the **MENU** button to return to the previous menu.

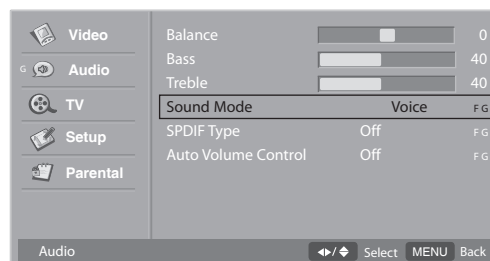

Voice

Select this option to watch a show that is mostly dialog.

Concert

Select this option to enjoy the original sound when listening to the music.

Jazz

Select this option to highlight bass yet also emphasize instruments such as the piano and guitar.

User

Select this option to use the user-defined audio settings.

NOTE

- If you want to select **Sound Mode** directly, press the **→|←** button.
- Every time you press the button, it will switch between **Voice**, **Concert**, **Jazz** and **User**.
- When you adjust **Bass** or **Treble**, **Sound Mode** changes to **User**.

Sound Controls

Manual Sound Controls

This is the function to adjust the audio condition in the way the user wants.

1. Press the **MENU** button and then press the Down or up button to select the **Audio**.
2. Press the **OK** button and then press the Down or Up button to select desired picture option. (**Bass, Treble, Balance**)
3. Press the **OK** button and then press the Left or Right button to make appropriate adjustments.
4. Press the **MENU** button to return to the previous menu.

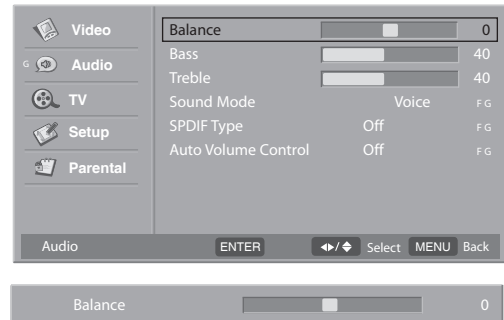

Bass

This adjusts the range of the low pitch sound.

Treble

This adjusts the range of the high pitch sound.

Balance

Adjust the sound balance of speaker to the levels you prefer.

Sound Controls

Auto Volume Control

This function automatically keeps on an equal volume level even if you change programs.

1. Press the **MENU** button and then press the Down or Up button to select the **Audio**.
2. Press the **OK** button and then press the Down or Up button to select **Auto Volume Control**.
3. Press the Left or Right button to select **On** or **Off**.
4. Press the **MENU** button to return to the previous menu.

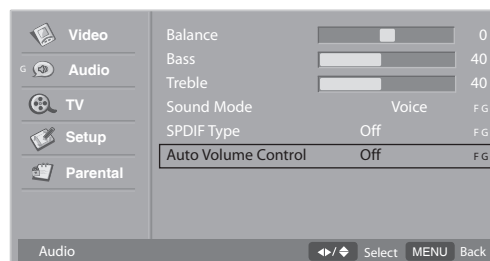

Stereo/SAP Broadcast Setup

This TV can receive MTS stereo programs and any SAP (Secondary Audio Program) that accompanies the stereo program if the station transmits an additional sound signal as well as the original one and when you select Stereo or SAP on the remote control.

Mono sound is automatically received if the broadcast is only in Mono; even though Stereo or SAP has been selected.

Select Mono if you want to listen to the mono sound in remote areas during stereo/SAP broadcasting. Stereo or SAP can be received in Analog channel.

1. Use the **MTS** button to select your desired MTS mode in analog signal.
Each time you press the **MTS** button, Mono, Stereo, or SAP appear in turn.
If other languages available on the digital signal, select them with the **MTS** button.
2. Press **EXIT** button to save and return to TV viewing.

Time Setting

Time Zone Setting

You can set the Time Zone for your local area.
This is operated from the Auto Synchronization.

1. Press the **MENU** button and then press the Down or Up button to select the **Setup**.
2. Press the **OK** button and then press the Down or Up button to select **Time Setup**.
3. Press the **OK** button and then press the Down or Up button to select **Time Zone**.
4. Press the Left or Right button to select your viewing area time zone.
(Eastern Time, Indiana, Central Time, Mountain Time, Arizona, Pacific Time, Alaska, Hawaii)
5. Press the **MENU** button to return to the previous menu.

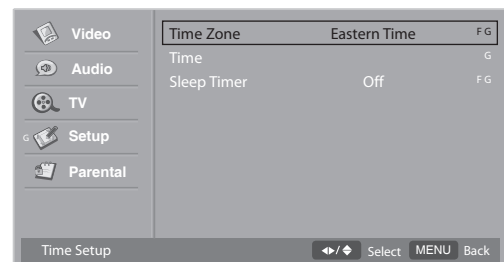
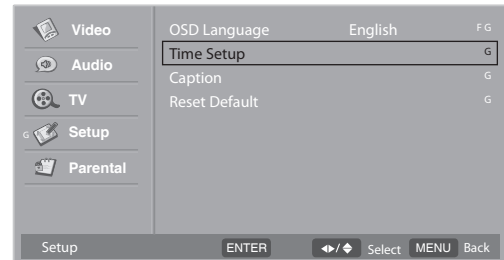

Time Setting

Auto Time Setting

The time is set automatically from a digital channel signal. The digital channel signal includes information for the current time provided by the broadcasting station. Set the time manually if the current time is set incorrectly by the Auto Synchronization function.

1. Press the **MENU** button and then press the Down or Up button to select the **Setup**.
2. Press the **OK** button and then press the Down or Up button to select **Time Setup**.
3. Press the **OK** button and then press the Down or Up button to select **Time**.
4. Press the **OK** button and then press the Down or Up button to select **Auto Synchronization**.
5. Press the Left or Right button to select **On**.
6. Press the **MENU** button to return to the previous menu.

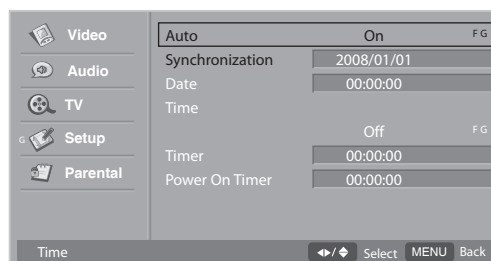
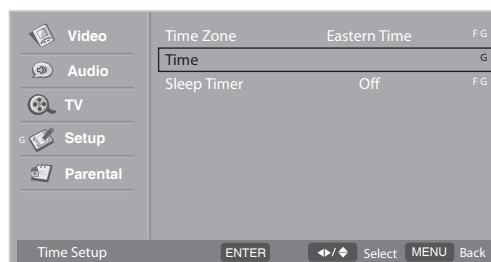

NOTE

- If **Auto Synchronization** is selected to **On**, **Date** and **Time** menus are cannot be adjusted.

Time Setting

Manual Time Setting

If the current time setting is wrong, reset the clock manually.

1. Press the **MENU** button and then press the Down or Up button to select the **Setup**.
2. Press the **OK** button and then press the Down or Up button to select **Time Setup**.
3. Press the **OK** button and then press the Down or Up button to select **Time**.
4. Press the **OK** button and then press the Down or Up button to select **Auto Synchronization**.
5. Press the Left or Right button to select **Off**.
6. Press the Down or Up button to select **Date** or **Time**.
7. Press the Left or Right button to move the position and use number buttons to set present date or time.
8. Press the **MENU** button to return to the previous menu.

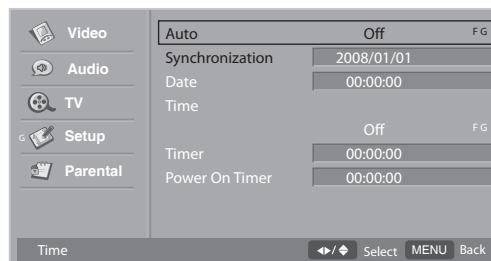
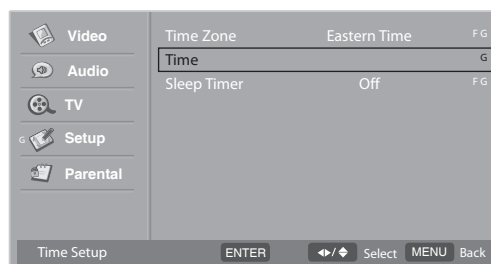
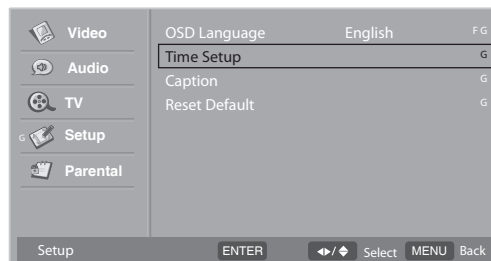

Time Setting

Auto On/Off Time Setting

The timer function operates only if the current time has been set.
The TV turns on/off automatically with the Power On/Off Timer function.

1. Press the **MENU** button and then press the Down or Up button to select the **Setup**.
2. Press the **OK** button and then press the Down or Up button to select **Time Setup**.
3. Press the **OK** button and then press the Down or Up button to select **Time**.
4. Press the **OK** button and then press the Down or Up button to select **Timer**.
5. Press the Left or Right button to select **On**.
If **Timer** is selected to **Off**, **Power On Timer** and **Power Off Timer** menu are cannot be adjusted.
6. Press the Down or Up button to select **Power On Timer** or **Power Off Timer**.
7. Press the Left or Right button to move the position and use number buttons to set TV on or off time.
8. Press the **MENU** button to return to the previous menu.

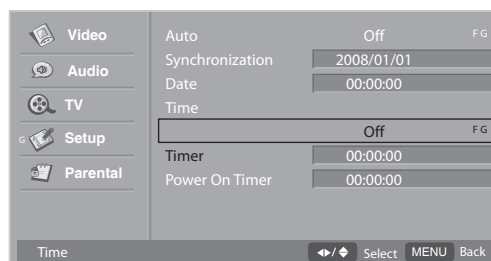
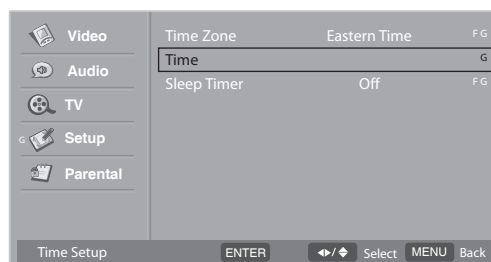
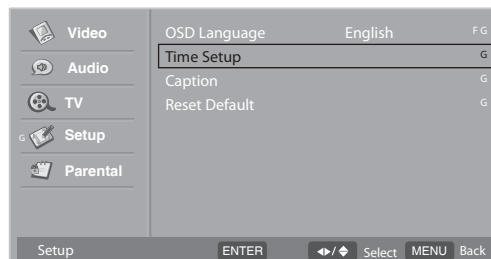

Time Setting

Sleep Timer

You don't have to remember to switch the set off before you go to sleep. The sleep timer automatically switches the set to standby after the preset time elapses.

1. Press the **MENU** button and then press the Down or Up button to select the **Setup**.
2. Press the **OK** button and then press the Down or Up button to select **Time Setup**.
3. Press the **OK** button and then press the Down or Up button to select **Sleep Timer**.
4. Press the Left or Right button to select desired sleep time.
The timer begins to count down from the number of minutes selected.
5. Press the **MENU** button to return to the previous menu.

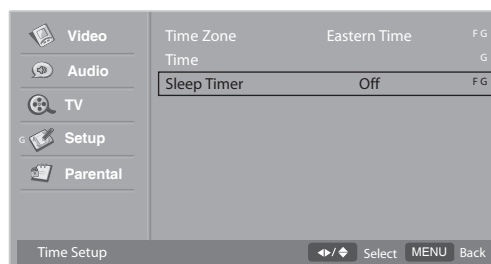
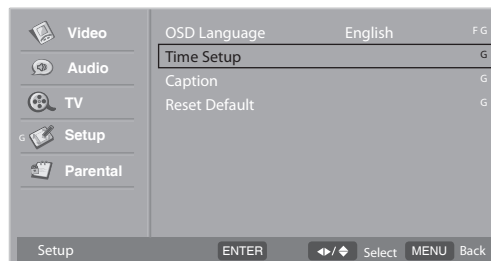

NOTE

- If you want to select **Sleep Timer** directly, press the **SLEEP** button.
- Every time you press the button, it will switch between **Off, 5, 10, 15, 30, 45, 60, 90, 120, 180** and **240**.

Captions

Closed Caption-Analog

The Analog Caption function operates when watching regular analog channels. Analog caption displays information at any position on the screen and is usually the program's dialog.

1. Press the **MENU** button and then press the Down or Up button to select the **Setup**.
2. Press the **OK** button and then press the Down or Up button to select **Caption**.
3. Press the **OK** button and then press the Down or Up button to select **Analog Closed Caption**.
4. Press the Left or Right button repeatedly to select **Off**, **CC1**, **CC2**, **CC3**, **CC4**, **TEXT1**, **TEXT2**, **TEXT3** or **TEXT4**.
5. Press the **MENU** button to return to the previous menu.

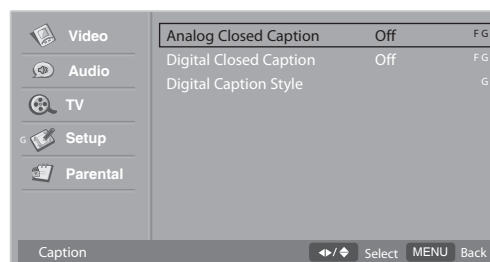
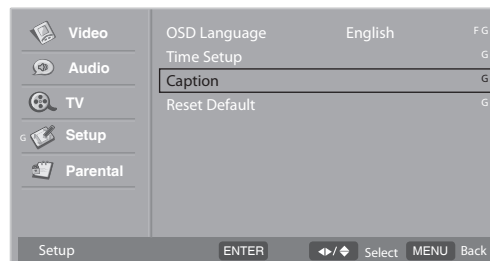

Caption

The term for the words that scroll across the bottom of the TV screen; usually the audio portion of the program provided for the hearing impaired.

TEXT

The term for the words that appear in a large black frame and almost cover the entire screen; usually messages provided by the broadcaster.

NOTE

- If you want to select **Caption** directly, press the **CC** button.

Captions

Closed Caption-Digital

The Digital Caption function operates on digital channels. Choose the language you want the DTV captions to appear in.

1. Press the **MENU** button and then press the Down or Up button to select the **Setup**.
2. Press the **OK** button and then press the Down or Up button to select **Caption**.
3. Press the **OK** button and then press the Down or Up button to select **Digital Closed Caption**.
4. Press the Left or Right button repeatedly to select **Off**, **SERVICE1**, **SERVICE2**, **SERVICE3**, **SERVICE4**, **SERVICE5** or **SERVICE6**.
5. Press the **MENU** button to return to the previous menu.

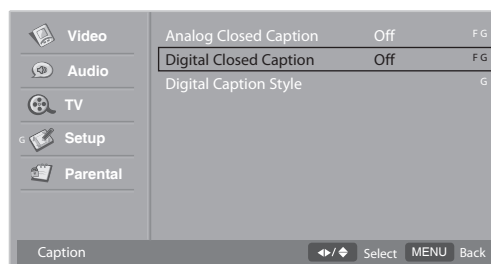

Captions

Closed Caption Options

Customize the DTV captions that appear on your screen.

1. Press the **MENU** button and then press the Down or Up button to select the **Setup**.
2. Press the **OK** button and then press the Down or Up button to select **Caption**.
3. Press the **OK** button and then press the Down or Up button to select **Digital Caption Style**.
4. Press the **OK** button and then press the Down or Up button to select **Caption Style**.
5. Press the Left or Right button to select **Custom**.
6. Press the Down or Up button to select desired caption option.
(**Font Size, Font Color, Font Opacity, Background Color, Background Opacity, Window Color, Window Opacity**)
7. Press the Left or Right button to customize your preference.
8. Press the **MENU** button to return to the previous menu.

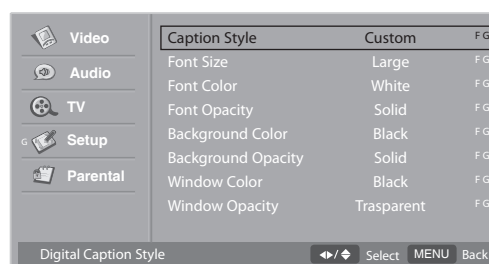
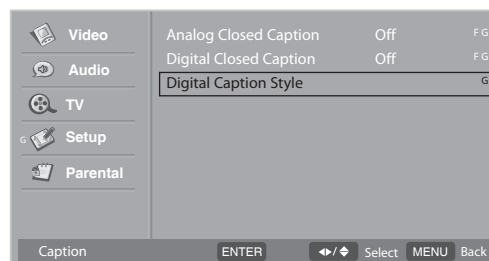

Font Size

Set the size the words will appear in.

Font Color

Choose a color for the text.

Font Opacity

Specify the opacity for the text color.

Background Color

Select a background color.

Background Opacity

Select the opacity for the background color.

Window Color

Select a color for the edges.

Window Opacity

Select the opacity for the edges.

NOTE

- If **Caption Style** is selected to **As Broadcaster**, Caption Options are cannot be adjusted.

Reset

Reset Default

Use to quickly reset all the menu options to their original factory preset values.
This function deletes all TV channel.

1. Press the **MENU** button and then press the Down or Up button to select the **Setup**.
2. Press the **OK** button and then press the Down or Up button to select **Reset Default**.
3. Press the **OK** button and then press the Left or Right button to select **OK**.
4. Press the **OK** button to reset.
5. Reset the menu options to original values.
6. Press the **MENU** button to return to the previous menu.

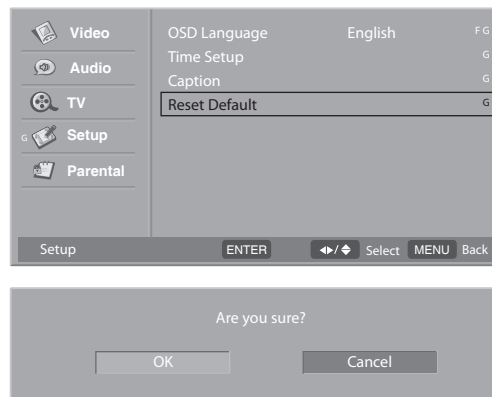

Parental Control

Enter the your password

Parental Control can be used to block specific channels, ratings and other viewing sources. Set up blocking schemes to block specific channels, ratings, and external viewing sources. A password is required to gain access to this menu.

1. Press the **MENU** button and then press the **Down** Or **Up** button to select the **Parental**.
2. Press the **OK** button and then enter password as requested.
3. The TV is set up with the initial password "0-0-0-0".



Set Password

Change the password by inputting a new password twice.

1. After inputting the password, press the **Down** Or **Up** button to select **Change Password**.
2. Press the **OK** button and then select any 4 digits for your new password and enter the them on the **New Password**.
3. As soon as the 4 digits are entered, re-enter the same 4 digits on the **Confirm Password**.
4. Then your changed password has been memorized.
5. Press the **MENU** button to return to the previous menu.

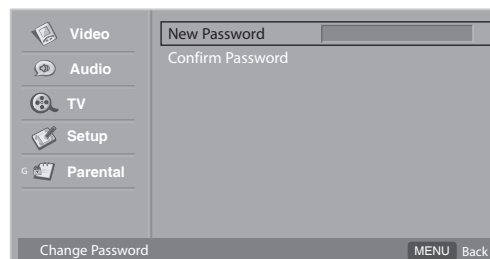
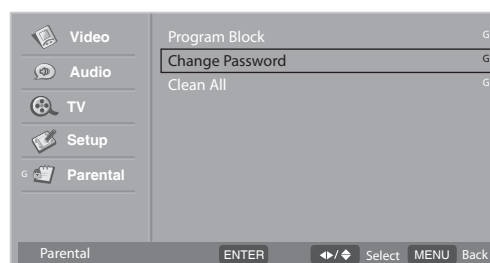

Parental Control

Rating Enable/Disable

Enables or disables the blocking scheme you set up previously.

1. After inputting the password, press the **Down** Or **Up** button to choose **Program Block**.
2. Press the **OK** button and then press the **Down** Or **Up** button to select **Rating Enable**.
3. Press the **Left** Or **Right** button to select **On** or **Off**.
When you select **On**, the Program Block menus are enable.
4. Press the **MENU** button to return to the previous menu.

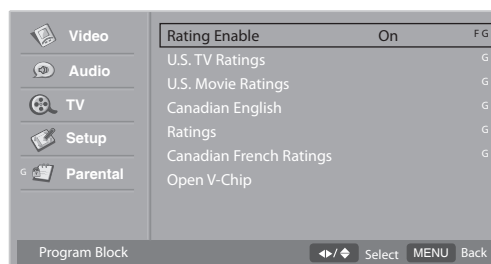
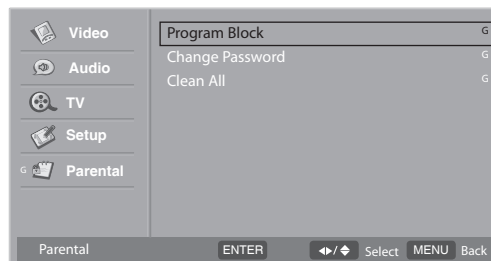

Parental Control

TV Ratings for USA

Prevents children from watching certain TV programs, according to the rating limits set. The children rating does not apply to other TV programs. Unless you block certain TV programs intended for mature audiences in the TV Rating - sub menu, your children can view those programs.

1. After inputting the password, press the **Down** Or **Up** button to choose **Program Block**.
2. Press the **OK** button and then press the **Down** Or **Up** button to select **U.S. TV Ratings**.
3. Press the **OK** button.
4. Press the **Down** Or **Up** Or **Left** Or **Right** buttons to choose and **OK** button to set up the menu options for U.S. TV Ratings.
5. Press the **MENU** button to return to the previous menu.

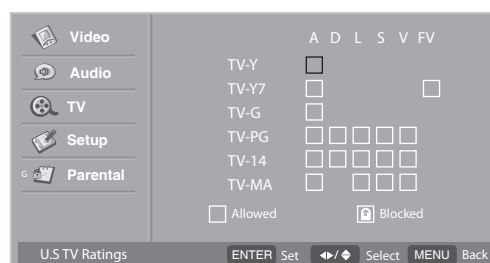
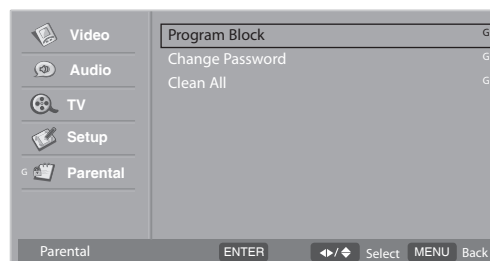

Parental Control

TV (FCC) Age Categories

TV-MA

Mature audiences only.
This program may contain mature themes, profane language, graphic violence and explicit sexual content.

TV-14

Parents strongly cautioned.
This program may contain sophisticated themes, sexual content, strong language and more intense violence.

TV-PG

Parental guidance suggested.
The program may contain infrequent coarse language, limited violence, some suggestive sexual dialog and situations.

TV-G

General audience.
This contains little or no violence, no strong language, and little or no sexual dialog or situations.

TV-Y7

Directed for older children.
Themes and elements in this program may include mild physical or comedic violence, or may frighten children under the age of seven.

TV-Y

All children.
The themes and elements in this program are specifically designed for a very young audience, including children from ages two – six.

TV (FCC) Content Sub-Categories:

- D:** Dialog...sexual innuendo.
- L:** Offensive language.
- S:** Sexual Situation
- V:** Violence.
- FV:** Fantasy or cartoon violence.

Parental Control

Movie Ratings

Blocks movies according to the movie ratings limits specified, so children cannot view certain movies. You can set the ratings limit by blocking out all the movies with the ratings above a specified level. Keep in mind that the movie ratings limit only applies to movies shown on TV, not TV programs, such as soap operas.

1. After inputting the password, press the **Down** or **Up** button to choose **Program Block**.
2. Press the **OK** button and then press the **Down** or **Up** button to select **U.S. Movie Ratings**.
3. Press the **OK** button.
4. Press the **Down** or **Up** buttons to choose and **OK** button to set up the menu options for U.S. Movie Ratings.
5. Press the **MENU** button to return to the previous menu.

The MPAA Rating System (Movies)

G

General Audience.

PG

Parental guidance suggested.

PG-13

Parents strongly cautioned.

R

Restricted.

NC-17

No one 17 and under admitted.

X

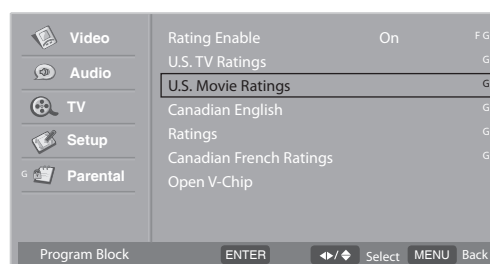
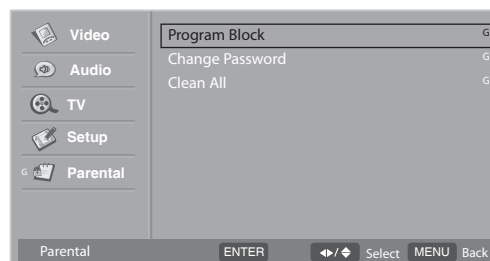

NOTE

- If you set PG-13 : G and PG movies will be available, PG-13, R, NC-17 and X will be blocked.

Parental Control

TV Rating English for Canada

Selecting canadian english language rating system.

1. After inputting the password, press the **Down** or **Up** button to choose **Program Block**.
2. Press the **OK** button and then press the **Down** or **Up** button to select **Canadian English Ratings**.
3. Press the **OK** button.
4. Press the **Down** or **Up** buttons to choose and **OK** button to set up the menu options for Canadian English Ratings.
5. Press the **MENU** button to return to the previous menu.

Canadian English Ratings

C

Children

C8+

Children eight years and older

G

General programming, suitable for all audiences

PG

Parental Guidance

14+

Viewers 14 years and older

18+

Adult programming

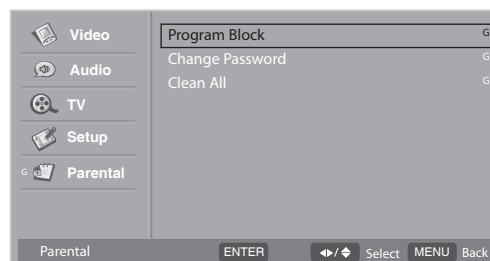

Parental Control

TV Rating French for Canada

Selecting canadian french language rating system.

1. After inputting the password, press the **Down** Or **Up** button to choose **Program Block**.
2. Press the **OK** button and then press the **Down** Or **Up** button to select **Canadian French Ratings**.
3. Press the **OK** button.
4. Press the **Down** or **Up** buttons to choose and **OK** button to set up the menu options for Canadian French Ratings.
5. Press the **MENU** button to return to the previous menu.

Canadian French Ratings

G

General

8 ans+

General-Not convenient for little children

13 ans+

Not convenient for children of 13 years and younger

16 ans+

Not convenient for children of 16 years and younger

18 ans+

This programs is only for adult

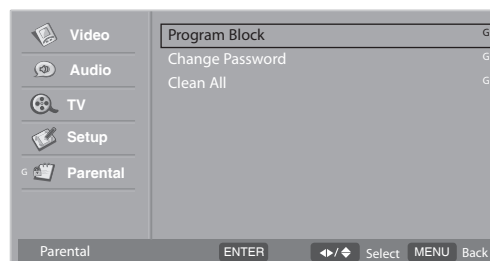

Parental Control

Downloadable Rating

Your TV's OSD (On Screen Display) may differ slightly from what is shown in this manual.

1. After inputting the password, press the **Down** or **Up** button to choose **Program Block**.
2. Press the **OK** button and then press the **Down** or **Up** button to select **Open V-Chip**.
3. Press the **OK** button twice.
4. Press the **Down** or **Up** buttons to choose the menu options for Open V-Chip.
5. Press the **OK** button.
6. Press the **MENU** button to return to the previous menu.

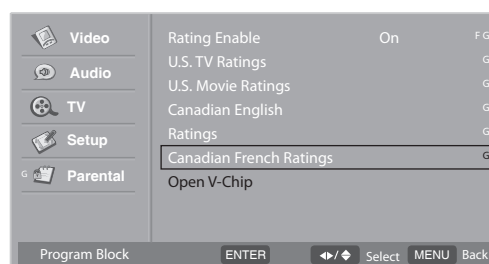
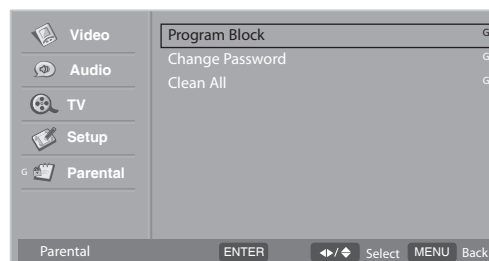

NOTE

- This function may become available in the future and will be available only for digital channel signal.
- This function operates only when TV has received Region5 Rating data.

Parental Control

Clean All

Use to quickly clean the Program Block menu options.

1. After inputting the password, press the **Down** or **Up** button to choose **Clean All**.
2. Press the **OK** button and then press the **Left** or **Right** button to select **OK**.
3. Press the **OK** button to clean the Program Block menu options.
4. Press the **MENU** button to return to the previous menu.

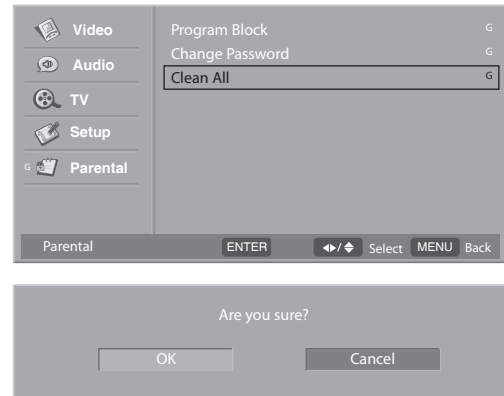

Setting the PC Mode

Auto Picture Controls

Picture Mode adjusts the set for the best picture appearance. Select the preset value in the Picture Mode menu.

1. Press the **MENU** button and then press the **Down** or **Up** button to select the **Video**.
2. Press the **OK** button and then press the **Down** or **Up** button to select **Picture Mode**.
3. Press the **Left** or **Right** button to select **Soft**, **Standard**, **Vivid** or **User**.
4. Press the **MENU** button to return to the previous menu.

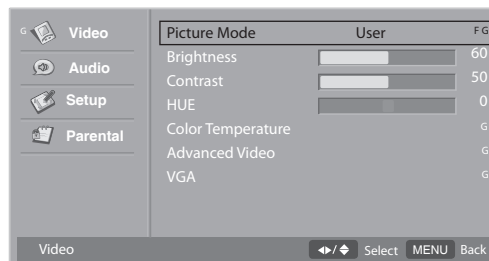

Soft

Select this option to display with a soft image.

Standard

The most general and natural screen display status.

Vivid

Select this option to display with a sharp image.

User

Select this option to use the user-defined setting.

NOTE

- Select the **VGA** mode by pressing **SOURCE** button.
- If you want to select **Picture Mode** directly, press the **PI** button.
- Every time you press the button, it will switch between **Soft**, **Standard**, **Vivid** or **User**.
- When you adjust **Brightness**, **Contrast**, **HUE**, **Picture Mode** changes to **User**.

Setting the PC Mode

Manual Picture Controls

You can adjust picture Brightness, Contrast and HUE to the levels you prefer.

1. Press the **MENU** button and then press the Down or Up button to select the **Video**.
2. Press the **OK** button and then press the Down or Up button to select desired picture option. (**Brightness, Contrast, HUE**)
3. Press the **OK** button and then press the Left or Right button again to make appropriate adjustments.
4. Press the **MENU** button to return to the previous menu.

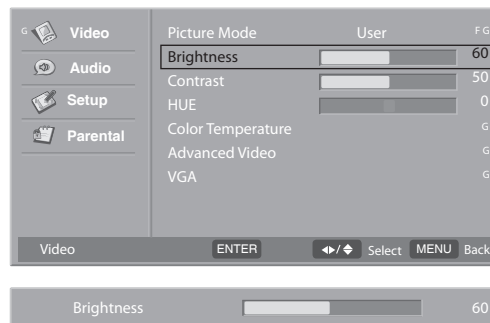

Brightness

Increases or decreases amount of white in the your picture.

Contrast

Adjusts the difference between the light and dark levels in the picture.

HUE

Adjusts the balance between red and green levels.

NOTE

- Select the **VGA** mode by pressing **SOURCE** button.

Setting the PC Mode

Color Temperature

You can adjust to color temperature you prefer.

1. Press the **MENU** button and then press the Down or Up button to select the **Video**.
2. Press the **OK** button and then press the Down or Up button to select **Color Temperature**.
3. Press the **OK** button and then press the Left or Right button to select **Cool**, **Standard**, **Warm** or **User**.
4. Press the Down or Up button to select desired color item.
5. Press the **OK** button and then press the Left or Right button to make appropriate adjustments.
6. Press the **MENU** button to return to the previous menu.

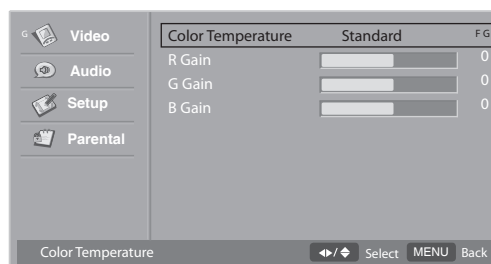
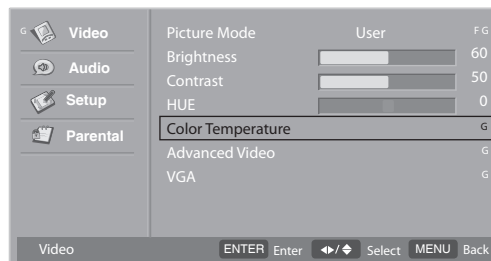

NOTE

- When you adjust **R Gain**, **G Gain** or **B Gain**, **Color Temperature** change to **User**.

Setting the PC Mode

Auto Adjustment

This function is for the automatic adjustment of the screen position, clock, phase and scale in pc mode. The displayed image will disappear for a few seconds while the auto configuration is in progress. Although the image is still not correct, your set is functioning properly but needs further adjustment.

1. Press the **MENU** button and then press the Down or Up button to select the **Video**.
2. Press the **OK** button and then press the Down or Up button to select **VGA**.
3. Press the **OK** button and then press the Down or Up button to select **Auto Adjust**.
4. Press the **OK** button to start auto adjust.
5. If picture needs to be adjusted more after Auto Adjust, you can adjust manually.

For more information on Manual Adjust, refer to the next page.

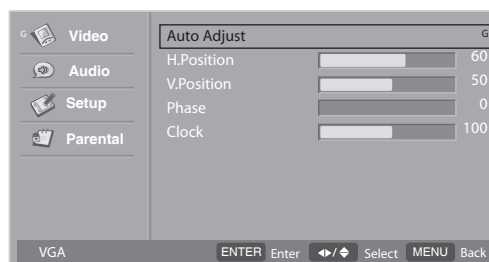
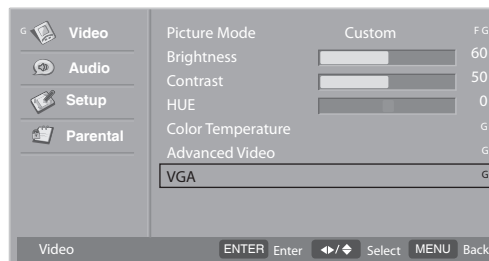

Setting the PC Mode

Manual Adjustment

If the picture isn't clear after auto adjustment and especially if characters are still trembling, adjust the picture phase manually.

To correct the screen size, adjust **Clock**.

1. Press the **MENU** button and then press the Down or Up button to select the **Video**.
2. Press the **OK** button and then press the Down or Up button to select **VGA**.
3. Press the **OK** button and then press the Down or Up button to select **H.Position** or **V.Position**.
4. Press the **OK** button and then press the Left or Right button to make appropriate adjustments.
5. Press the Down or Up button to select **Phase** or **Clock**.
6. Press the **OK** button and then press the Left or Right button to make appropriate adjustments.
7. Press the **MENU** button to return to the previous menu.

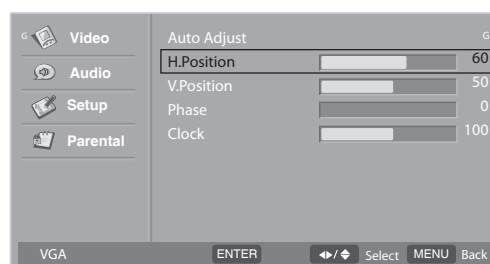
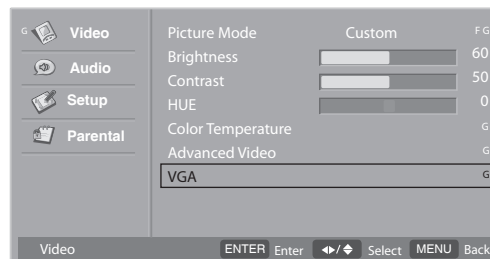

H.Position

This function is to adjust horizontal position of screen.

V.Position

This function is to adjust vertical position of screen.

Phase

This function allows you to remove any horizontal noise and clear or sharpen the image of characters.

Clock

This function is to minimize any vertical bars or stripes visible on the screen background.
And the horizontal screen size will also change.

Special Functions

Picture Format

You can watch the screen in various picture formats; 4:3, ZOOM, Auto, Full.

If a fixed image is displayed on the screen for a long time, that fixed image may become imprinted on the screen and remain visible.

Repeatedly press the **ZOOM** button to select your desired picture format.

A 4:3

Following selection will lead you to view a picture with an original 4:3 aspect ratio, with gray bars appearing at both the left and right sides.

A ZOOM

When your set receives the wide screen signal, when selected it will adjust the picture horizontally, in nonlinear proportion, to fill the entire screen.

A Auto

When your set receives the wide screen signal, it will change automatically the picture format that has been sent.

A Full

You can enjoy the cinema or general TV program through the 16:9 mode.

The screen 16:9 is viewed just like that but the screen 4:3 is magnified to the left and right so that the screen 16:9 is full.

NOTE

- You can only select **4:3**, **Zoom**, **Auto** and **Full** below 480p.
- You can only select **4:3** and **Full** above 720p.
- You can only select **4:3** and **Full** in **VGA** mode.

Specification

Model		PT32U44K
Dimension	Horizontal	918.0 mm
	Height	698.0 mm
	Thickness	296.0 mm
Weight		21.5 kg
Contrast Ration		1,800:1 (25/100 White Window)
Brightness		500 cd/m ²
Panel Resolution		852 (H) x 480 (V)
Display Color		16.7M colors
Audio Output		5W + 5W
Consumption		205W
External Port		<ul style="list-style-type: none"> ◦HDMI / DVI IN ◦RGB IN(PC) ◦COMPONENT IN ◦S-VIDEO IN ◦AV IN ◦AUDIO IN (RGB / DVI) ◦ANTENNA / CABLE IN ◦DIGITAL AUDIO OUT (COAXIAL)

Troubleshooting

Problem	Check Point
No picture on screen.	<ul style="list-style-type: none"> o Check whether the set is turned on. o Power cord inserted into wall outlet? o Plug another product's power cord into the wall outlet where the set's power cord was plugged in.
The remote control doesn't work.	<ul style="list-style-type: none"> o Check to see if there is any object between the set and the remote control causing obstruction. o Check to see if the batteries are installed with the correct polarities. o Install new batteries.
Picture appears slowly, after switching on.	<ul style="list-style-type: none"> o This is normal as the image is muted during the start up process of the set. Please contact your service center, if the picture has not appeared after five minutes.
No or Poor color	<ul style="list-style-type: none"> o Select color in the Picture menu and press the <small>Left</small> or <small>Right</small> button.
Horizontal/Vertical bars or picture shaking	<ul style="list-style-type: none"> o Check for local interference such as an electrical appliance or power tool.
Unusual sound from inside the set.	<ul style="list-style-type: none"> o A change in ambient humidity or temperature may result in an unusual noise at the time of switching off or on of the set and does not indicate a fault with the set.

MEMO



SOYO End-User One Year Limited Warranty

SOYO, Inc. warrants all SOYO brand products you have purchased from SOYO or from a SOYO authorized reseller / retailer to be free from defects in materials and workmanship under normal use during the warranty period and subject to the terms and conditions set forth below, in the continental United States, Hawaii, Alaska and Canada. If the Product becomes defective during the warranty period SOYO will, at its option, repair or replace the product. SOYO may use new or reconditioned components or parts to repair the Product, or replace the Product with new or reconditioned Product of the same or functionally equivalent model.

SOYO FPD (Flat Panel Display) TV Standard Limited Warranty: Subject to the exclusions set forth below:

One year from the purchase date by the original retail purchaser (the "Customer") (except for refurbished or Demo Products which have a separate warranty policy) parts and labor only.

Return Merchandise Authorization Shipping: The customer will pay shipping to SOYO and SOYO will pay shipping to the customer during the standard warranty period.

Dead on Arrival (DOA): Customer must contact SOYO within fifteen (15) days of purchase of any Product which is DOA. SOYO will issue a Return Merchandise Authorization (RMA) number to process the replacement. SOYO will replace the DOA unit with a brand new replacement, once the DOA unit has been received at SOYO. SOYO will cover the shipping cost both ways.

Shipping Damages: All shipping damages must be reported to SOYO within five (5) business days upon receipt of the Products. SOYO is not responsible for any shipping damages reported after such period.

Repaired or Replaced Products: All repaired or replaced parts or Products shall be warranted only for the remainder of the original warranty period.

Obtaining Warranty Service:

If you purchased a SOYO Product in the continental United States, Hawaii, Alaska or Canada, you are entitled to warranty service during the warranty period, subject to the terms and conditions set forth within.

Service is available for all SOYO Products purchased and located in the continental United States, Hawaii, Alaska or Canada.

You must contact SOYO Technical Support Department at (909) 292-2545

A SOYO Technician will attempt to resolve the issue over the telephone. If the issue cannot be resolved over the telephone, a Return Merchandise Authorization (RMA) number will be issued for the return of the Product. The RMA number will only be valid for a period of thirty (30) days from date of issue.

When you return your product, you must prepay any shipping charges, export taxes, customs duties, and taxes or any other charges associated with the return of the product to SOYO. Additionally you may want to purchase insurance to cover the replacement value of the Product being shipped should it become lost or stolen.

When Shipping a Product for service we recommend selecting a service which you can track the delivery of the Product.

All returned Products must be accompanied by the following items: (i) the original shipping and packaging materials, (ii) a brief description of the problem, and (iii) proof of purchase including a copy of the invoice or receipt which shows the date of purchase, model number of the SOYO product and name and address of reseller or retailer.

SOYO reserves the right to refuse and return, freight collect, Product(s) that are not covered by SOYO warranty; or products delivered to SOYO with an expired RMA number.

SOYO will use its best efforts to service Products within thirty (30) days after receipt of the RMA. Once the service is completed, SOYO at its expense will ship via ground carrier and will retain all risk of loss until delivery to the customer's location as evidenced by signature collected by carrier. The customer may designate only one location within the continental United States, Hawaii, Alaska or Canada for return shipment. SOYO is not responsible for shipping or other delays beyond their control.

EXCLUSIONS TO WARRANTY – This limited warranty does not extend to any product not purchased from SOYO or SOYO authorized resellers. This limited warranty also does not extend to any Product that has been damaged or rendered defective (1) due to normal wear and tear; (2) as a result of use of the Product other than for normal intended use, or other misuse, abuse or negligence to the Product; (3) by the use of parts not manufactured or sold by SOYO; (4) by modification of the Product; (5) as a result of service by anyone other than SOYO or a SOYO authorized service provider; (6) improper transportation or packaging when shipping the product (7) improper installation of third-party products; (8) improper operating environment (including improper temperature and humidity); (9) unusual physical or electrical stress or interference, failure or fluctuation of electrical power, lightning, static electricity, fire, or acts of god.

Other Limitations

EXCEPT FOR THE WARRANTIES SET FORTH HEREIN, SOYO DISCLAIMS ALL OTHER WARRANTIES, EXPRESSED OR IMPLIED OR STATUTORY, INCLUDING BUT NOT LIMITED TO THE IMPLIED WARRANTIES OF MERCHANTABILITY OR FITNESS FOR A PARTICULAR PURPOSE. ANY IMPLIED WARRANTIES THAT MAY BE IMPOSED BY APPLICABLE LAW ARE LIMITED TO THE TERMS OF THIS LIMITED WARRANTY. IN NO EVENT SHALL SOYO BE LIABLE FOR ANY INDIRECT, INCIDENTAL, SPECIAL OR CONSEQUENTIAL DAMAGES OF ANY KIND, INCLUDING BUT NOT LIMITED TO LOSS OF BUSINESS, REVENUE, PROFITS, INFORMATION, DATA OR USE, WHETHER IN AN ACTION IN CONTRACT OR TORT OR BASED ON A WARRANTY, ARISING OUT OF OR IN CONNECTION WITH THE USE OR PERFORMANCE OF THE PRODUCT, EVEN IF SOYO HAS BEEN ADVISED OF THE POSSIBILITY OF SUCH DAMAGE. YOU AGREE THAT REPAIR OR REPLACEMENT, AS APPLICABLE, UNDER THE WARRANTY SERVICE DESCRIBED HEREIN IS YOUR SOLE AND EXCLUSIVE REMEDY WITH RESPECT TO ANY BREACH OF THE SOYO LIMITED WARRANTY SET FORTH HEREIN. IF, DESPITE THE FORGOING LIMITATIONS, FOR ANY REASON SOYO BECOMES LIABLE TO YOU FOR DAMAGES INCURRED BY YOU IN CONNECTION WITH THIS AGREEMENT, THEN THE LIABILITY OF SOYO WILL BE LIMITED TO THE AMOUNT EQUAL TO THE INVOICE AMOUNT PAID BY YOU TO SOYO OR AN AUTHORIZED SOYO RESELLER FOR THE PRODUCT. The terms and conditions are subject to change without notice. Some states or provinces / jurisdictions do not allow the exclusion or limitation of incidental or consequential damages for consumer Products, and some states or provinces / jurisdictions do not allow limitations on how long an implied warranty last. In such states or provinces / jurisdictions, the exclusions or limitations of this limited warranty may not apply. This limited warranty gives you specific legal rights. You may also have other rights that vary from state to state provinces / jurisdictions. You are advised to consult applicable state and provincial laws for a determination of your rights.

For more detail information and tips please check http://www.soyo.com/content/Warranty_Policy/42

For information regarding purchasing an **Extended Warranty**, visit http://www.soyo.com/content/Extended_Warranty_Order_Form/44



PRODUCT REGISTRATION

IMPORTANT! Please fill out and return within the next 10 days.

This is your SOYO Product Registration Card. Proper registration can serve as proof of purchase in the event your original receipt becomes misplaced or lost. Returning this card will not affect warranty coverage, but may expedite the processing of warranty claims. The additional information will also help us to develop new products that best meet your needs and desires.

Part 1

MR. MRS. MS. MISS

FIRST NAME:	INITIAL:	LAST NAME:
STREET:		APT NO.:
CITY:	STATE:	ZIP CODE:
EMAIL ADDRESS:		

Part 2

DATE OF PURCHASE (MM/DD/YYYY): / /	
MODEL NUMBER:	SERIAL NUMBER (on back of unit):
DID YOU PURCHASE AN EXTENDED SERVICE PLAN FOR THIS PRODUCT? <input type="checkbox"/> YES <input type="checkbox"/> NO	
WHERE DID YOU PURCHASE THIS PRODUCT?	

Part 3

WHERE DID YOU FIRST LEARN ABOUT THIS SOYO PRODUCT? (CHECK ONE ONLY)

<input type="checkbox"/> Salesperson	<input type="checkbox"/> Friend/Relative	<input type="checkbox"/> Magazine Article / Review
<input type="checkbox"/> SOYO Website	<input type="checkbox"/> Magazine Advertisement	<input type="checkbox"/> Newspaper Advertisement
<input type="checkbox"/> In-Store Display	<input type="checkbox"/> Sunday Insert	<input type="checkbox"/> Product Carton
<input type="checkbox"/> Online Product Review	<input type="checkbox"/> Online Advertisement	<input type="checkbox"/> Other

WHAT WERE THE TWO MOST IMPORTANT FACTORS THAT INFLUENCED YOUR SELECTION OF THIS PRODUCT? (TWO ONLY)

<input type="checkbox"/> SOYO Reputation	<input type="checkbox"/> Screen Size	<input type="checkbox"/> Recommended by a Salesperson
<input type="checkbox"/> Prior Experience with SOYO	<input type="checkbox"/> Warranty	<input type="checkbox"/> Picture Quality
<input type="checkbox"/> Style / Appearance	<input type="checkbox"/> Durability	<input type="checkbox"/> Other
<input type="checkbox"/> Slimness	<input type="checkbox"/> Portability	
<input type="checkbox"/> Price / Value	<input type="checkbox"/> Recommended by Friend/Relative	

PLEASE CHECK THE LOCATION WHERE THIS UNIT WILL BE USED

<input type="checkbox"/> Living Room	<input type="checkbox"/> Family / Recreation Room	<input type="checkbox"/> Home Office
<input type="checkbox"/> Adult's Bedroom	<input type="checkbox"/> Kitchen	<input type="checkbox"/> Mobile Home/Trailer
<input type="checkbox"/> Child's Bedroom	<input type="checkbox"/> Basement	<input type="checkbox"/> Other

WHERE WILL THE TELEVISION BE INSTALLED?

<input type="checkbox"/> Wall	<input type="checkbox"/> Under a Cabinet	<input type="checkbox"/> Entertainment Center
<input type="checkbox"/> Table	<input type="checkbox"/> Night Stand	<input type="checkbox"/> Other

WHAT OTHER BRANDS OF TVS DID YOU SERIOUSLY CONSIDER BEFORE SELECTING THIS SOYO PRODUCT?

<input type="checkbox"/> No Other Brands Considered	<input type="checkbox"/> Sharp	<input type="checkbox"/> JVC
<input type="checkbox"/> RCA	<input type="checkbox"/> Panasonic	<input type="checkbox"/> Philips
<input type="checkbox"/> LG	<input type="checkbox"/> Samsung	<input type="checkbox"/> Syntax
<input type="checkbox"/> Sony	<input type="checkbox"/> Toshiba	<input type="checkbox"/> Other

Part 4

TO HELP US UNDERSTAND OUR CUSTOMERS' LIFESTYLES, PLEASE CHECK THE THREE (3) MOST IMPORTANT INTERESTS AND ACTIVITIES IN WHICH YOU OR YOUR SPOUSE ENJOYS PARTICIPATING ON A REGULAR BASIS.

<input type="checkbox"/> Bicycling	<input type="checkbox"/> Flower Gardening	<input type="checkbox"/> Fashion Clothing	<input type="checkbox"/> Science Fiction
<input type="checkbox"/> Golf	<input type="checkbox"/> Vegetable Gardening	<input type="checkbox"/> Foreign Travel	<input type="checkbox"/> Wildlife/Env'l Issues
<input type="checkbox"/> Physical Fitness/Exercise	<input type="checkbox"/> Crafts	<input type="checkbox"/> Cruise Ship Vacations	<input type="checkbox"/> Dieting/Weight Control
<input type="checkbox"/> Running/Jogging	<input type="checkbox"/> Buying Pre-recorded Videos	<input type="checkbox"/> Travel in USA	<input type="checkbox"/> Science/New Technology
<input type="checkbox"/> Tennis	<input type="checkbox"/> Automotive Work	<input type="checkbox"/> Gourmet Cooking/Fine Foods	<input type="checkbox"/> Self Improvement
<input type="checkbox"/> Camping/Hiking	<input type="checkbox"/> Electronics	<input type="checkbox"/> Wines	<input type="checkbox"/> Walking for Health
<input type="checkbox"/> Fishing	<input type="checkbox"/> Home Workshop/Do-It-Yourself	<input type="checkbox"/> Stamp/Coin Collecting	<input type="checkbox"/> Watching Sports on TV
<input type="checkbox"/> Hunting/Shooting	<input type="checkbox"/> Recreation Vehicles (RV's)	<input type="checkbox"/> Collectibles	<input type="checkbox"/> Home Video Recording
<input type="checkbox"/> Power Boating	<input type="checkbox"/> Listen to Records/Tapes/CDs	<input type="checkbox"/> Our Nation's Heritage	<input type="checkbox"/> Moneymaking Opportunities
<input type="checkbox"/> Sailing	<input type="checkbox"/> Avid Book Reading	<input type="checkbox"/> Real Estate Investments	
<input type="checkbox"/> Grandchildren	<input type="checkbox"/> Bible/Devotional Reading	<input type="checkbox"/> Stocks/Bond Investments	
<input type="checkbox"/> Needlework/Knitting	<input type="checkbox"/> Photography	<input type="checkbox"/> Contests/Sweepstakes	
<input type="checkbox"/> Sewing	<input type="checkbox"/> Cultural/Arts Events	<input type="checkbox"/> Casino Gambling	

Thanks for taking the time to fill out this questionnaire. Your answers will be used for market research studies and reports. They will also allow you to receive important mailings and special offers from a number of fine companies whose products and services relate directly to the specific interests, hobbies, and other information indicated above. Through this selective program, you will be able to obtain more information about activities in which you are involved and less about those in which you are not. Please check here if, for some reason, you would prefer *not* to participate in this opportunity. Failure to return this card will not diminish your warranty rights.

PRODUCT REGISTRATION DEPARTMENT: Please do not send any products or other correspondence to this address. If you have comments or suggestions about our product, please write to: SOYO, Inc., 1420 S. Vintage Avenue, Ontario, California, 91761 | Visit our website at <http://www.soyo.com>

Copyright © 2008. All rights reserved.

cut here

Please seal with tape. Do not staple.

cut here

If you have comments or suggestions
about our product, please write to:

SOYO, INC.
MARKETING DEPARTMENT
1420 S. VINTAGE AVE.
ONTARIO, CALIFORNIA 91761 USA
Visit our website at <http://www.soyo.com>

First-Class
Postage
Required.
Post Office will
not deliver
without proper
postage.



PRODUCT REGISTRATION DEPARTMENT
1420 S. VINTAGE AVE.
ONTARIO, CA 91761-3646



1420 South Vintage Ave.
Ontario, CA 91761

United States

www.soyo.com

A Publicly Traded Company: SOYO

Copyright © 2008 SOYO Group, Inc.

All other trademarks and logos are property of their respective owners.

All specifications are subject to change without notice.

PLASMA TV

Free Manuals Download Website

<http://myh66.com>

<http://usermanuals.us>

<http://www.somanuals.com>

<http://www.4manuals.cc>

<http://www.manual-lib.com>

<http://www.404manual.com>

<http://www.luxmanual.com>

<http://aubethermostatmanual.com>

Golf course search by state

<http://golfingnear.com>

Email search by domain

<http://emailbydomain.com>

Auto manuals search

<http://auto.somanuals.com>

TV manuals search

<http://tv.somanuals.com>