

SAMSUNG

PDP-TELEVISION

(PLASMA DISPLAING PANEL)

Owner's Instructions

Before operating the unit,
please read this manual thoroughly,
and retain it for future reference.

ON-SCREEN MENUS

Picture In Picture (PIP)

Energy Saving

TELETEXT (Option)



SRS TruSurroundXT



Digital Natural Image engine

Digital Terrestrial Receiver

Register your product at www.samsung.com/global/register

User Instructions

◆ Screen Image retention

Do not display a still image (such as on a video game or when hooking up a PC to this PDP) on the plasma monitor panel for more than 2 hours as it can cause screen image retention. This image retention is also known as "screen burn". To avoid such image retention, reduce the degree of brightness and contrast of the screen when displaying a still image.

◆ Height

The PDP can normally operate only under 2000m in height. It might abnormally function at a place over 2000m in height so do not install and operate there.

◆ Heat on the top of the PDP TV

The top side of the product may be hot after long period of use as heat dissipates from the panel through the vent hole in the upper part of the product. This is normal and does not indicate any defect or operation failure of the product. However, children should be prevented from touching the upper part of the product.

◆ The product is making a 'cracking' noise.

A 'cracking' noise may occur when the product contracts or expands due to a change of surrounding environment such as temperature or humidity. This is normal and not a defect of the unit.

◆ Cell Defects

The PDP uses a panel consisting of 1,230,000(SD-level) to 3,150,000(HD-level) pixels which require sophisticated technology to produce. However, there may be few bright or dark pixels on the screen. These pixels will have no impact on the performance of the product.

◆ Avoid operating the TV at temperatures below 5°C(41°F)

◆ A still image displayed too long may cause permanent damage to the PDP Panel.



Watching the PDP TV in 4:3 format for a long period of time may leave traces of borders displayed on the left, right and centre of the screen caused by the difference of light emission on the screen.

Playing a DVD or a game console may cause similar effect to the screen. Damages caused by the above effect are not covered by the Warranty.

◆ Afterimage on the Screen.

Displaying still images from Video games and PC for longer than a certain period of time may produce partial afterimages. To prevent this effect, reduce the 'brightness' and 'contrast' when displaying still images.

◆ Warranty

- Warranty does not cover any damage caused by image retention.

- Burn-in is not covered by the warranty.

◆ Installation

Be sure to contact an authorized service centre, when installing your set in a location with heavy dust, high or low temperatures, high humidity, chemical substance and where it operates continually such as the airport, the train station etc. Failure to do so may cause a serious damage to your set.

Checking Parts

<p>Owner's Instructions</p> <p>Remote Control/AAA Batteries</p> <p>Warranty Card/Registration Card/Safety Guide Manual (Not available in all locations)</p> <p>Ferrite Core for Power Cord/Antenna Cable/Side AV (PS50Q7HD)</p> <p>Cloth-Clean</p>				Sold Separately				

➤ Ferrite Core (Power Cord, Antenna Cable, Side AV)

The ferrite core is used to shield the cable from interference. When connecting a cable, open the ferrite core and clip it around the cable.

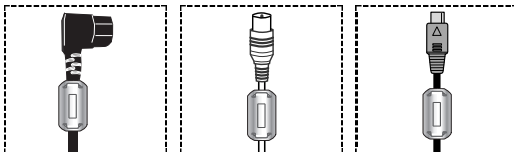

Contents

◆	GENERAL INFORMATION	
■	User Instructions	2
■	Checking Parts	2
■	Control Panel	5
■	Connection Panel	6
■	Viewing the Remote Control	8
■	Installing Batteries in the Remote Control	9
◆	OPERATION	
■	Switching Your Television On and Off	9
■	Viewing the Menus	9
■	Freezing the Current Picture	10
■	Plug & Play Feature	10
■	Viewing an External Signal Sources	11
■	Editing Device Names	11
◆	CHANNEL CONTROL (ANALOG TV)	
■	Storing Channels Automatically	11
■	Storing Channels Manually	12
■	Adding / Locking Channels	13
■	Sorting the Stored Channels	14
■	Assigning Names to Channels	14
■	Fine Tuning Channel Reception	15
■	LNA (Low Noise Amplifier)	15
◆	PICTURE CONTROL	
■	Changing the Picture Standard	15
■	Customizing the Picture Settings	16
■	Selecting the Picture Size	16
■	Digital NR	17
■	SMD	17
■	DNle Demo	17
■	Viewing the Picture in Picture (PIP)	17
◆	SOUND CONTROL	
■	Sound Features	18
◆	FUNCTION DESCRIPTION	
■	Time Features	19
■	Language	20
■	Blue Screen	20
■	Melody	20
■	Energy Saving	20
■	Using Game Mode	20
■	Screen Burn Protection	21
■	Setting the Blue Eye	21
◆	PC DISPLAY	
■	Setting up Your PC Software (Based on Windows XP)	22
■	Input Mode (PC)	22
■	Setting the PC	23

continued..

Contents

◆ USING THE DTV FEATURE

■ Previewing the DTV Menu System	24
■ Basic Functions.....	25
1. Display Screen.....	25
2. Volume Control	25
3. Select Soundtrack.....	25
4. Select Videotrack.....	25
5. Service List.....	25
6. Program Information.....	26
■ Operating the DTV Menu	26
Main Menu.....	26
1. Installation	26
1.1 Select Country	27
1.2 Auto Scanning.....	27
1.3 Manual Scanning.....	27
1.4 Reset to Factory Defaults	27
2. Channel Organising.....	28
2.1 Delete Frequency	28
2.2 Delete Channel.....	28
2.3 Delete All Channels	28
2.4 Move & Edit Channel	28
3. Parental Lock	29
3.1 Set Channel Lock.....	29
3.2 Change PIN Code	29
4. System Setup.....	30
4.1 Language Selection.....	30
4.2 OSD Setting.....	30
4.3 Time Setting	30
4.4 System Information.....	30
4.5 Software Upgrade.....	30
■ Installing the CI card	31

◆ APPENDIX

■ Teletext Feature	32
■ How to Install the Wall Mount Bracket	33
■ Setting Up Your Remote Control.....	36
■ Troubleshooting.....	41

Symbols



Press



Important



Note

Control Panel

➤ The product colour and shape may vary depending on the model.

Front (or Side) Panel

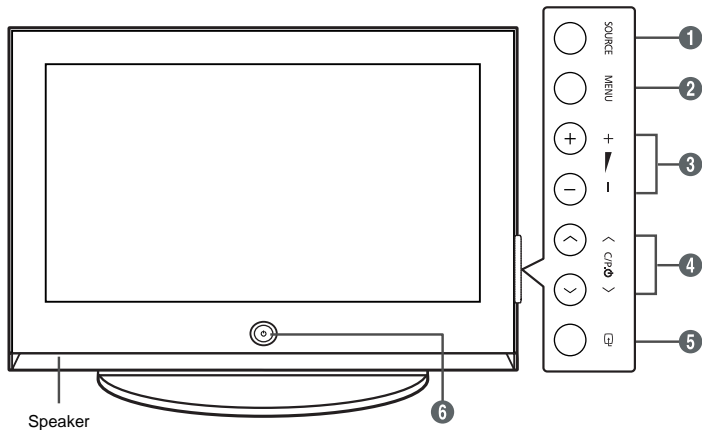

1 SOURCE

Displays a menu of all of the available input sources (TV, Ext.1, Ext.2, AV, S-Video, Component, PC, HDMI1, HDMI2, DTV).

2 MENU

Press to see the on-screen menu of your TV's features.

3 + ▴ -

Press to decrease or increase the volume. In the on-screen menu, use the + ▴ - buttons as you use the ◀ and ▶ buttons on the remote control.

4 ▾ C/P. ⏻ ▲

Press to change channels. In the on-screen menu, use the ▾ C/P. ⏻ ▲ buttons as you use the ▲ and ▼ buttons on the remote control.

5 [ENTER] (ENTER)

Press to confirm a selection.

6 ⏻ (Power)

Press to turn the TV on and off.

Power Indicator

- Power Off: Blue
- Power On: Off

Remote Control Sensor

Aim the remote control towards this spot on the TV.

➤ Press the **MENU** button once in DTV mode, then the DTV menu is displayed.

Connection Panel

➤ The product colour and shape may vary depending on the model.

Side Panel

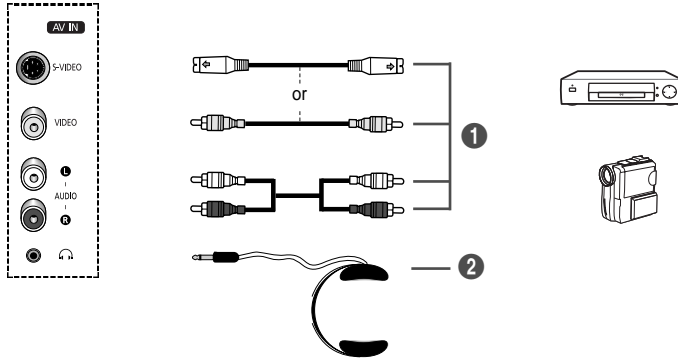

1 S-Video or Video / Audio L/R

Video (S-Video or Video) and audio inputs for external devices, such as a Camcorder or VCR.

2 Headphones jack

You can connect a set of headphones to your television if you wish to watch a television programme without disturbing the other people in the room.

➤ Prolonged use of headphones at a high volume may damage your hearing.

continued...

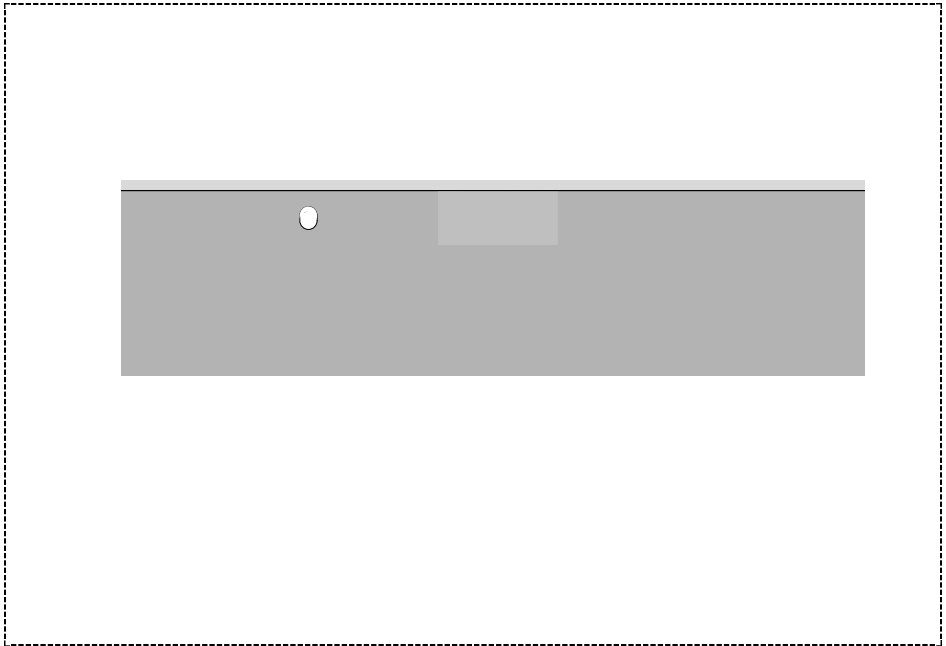

- Whenever you connect an audio or video system to your set, ensure that all elements are switched off.
- When connecting an external device, match the colour of the connection terminal to the cable.

1 COMMON INTERFACE Slot

Insert CI (Common Interface) card into the slot.

Connecting CI (Common Interface) CARD

- When not inserting "CI CARD" in some channels, "Scrambled Signal" is displayed on the screen.
- The pairing information containing a telephone number, CI CARD ID, Host ID, and other information will be displayed in about 2-3 minutes. If an error message is displayed, please contact your service provider.
- When the channel information configuration has finished, the message "Updating Completed" is displayed, indicating that the channel list is now updated.
 - You must obtain a CI CARD from a local cable service provider. Remove the CI CARD by carefully pulling it out with your hands since dropping the CI CARD may cause damage to it.

2 ANT IN VHF/UHF (75Ω)

75Ω Coaxial connector for Aerial/Cable Network.

3 Connecting external Audio Devices

Connect RCA audio signals from the TV to an external source, such as Audio equipment.

4 DIGITAL AUDIO OUT (OPTICAL)

Connect to a Digital Audio Component.

5 DTV SERVICE

Connector for service only.

6 COMPONENT IN

Video (Y/P_B/P_R) and audio (AUDIO L/R) inputs for Component.

7 PC IN / AUDIO

Connect to the video and audio output jack on your PC.

8 EXT 1, EXT 2

Inputs or outputs for external devices, such as VCR, DVD, video game device or video disc players.

Input/Output Specification

Connector	Input			Output
	Video	Audio (L/R)	RGB	Video + Audio (L/R)
EXT 1	✓	✓	✓	Only TV or DTV output is available.
EXT 2	✓	✓		Output you can choose.

9 HDMI 1/DVI IN

- Connect to the HDMI jack of a device with HDMI output. These inputs can also be used as a DVI connection with separate analog audio inputs. An optional HDMI/DVI cable will be necessary to make this connection. When using the optional HDMI/DVI adapter, the DVI analog audio inputs on your TV allow you to receive left and right audio from your DVI device. (Not compatible with PC)
- When connecting this product via HDMI or DVI to a Set Top Box, DVD Player or Games Console etc, make sure that it has been set to a compatible video output mode as shown in the table below. Failure to observe this may result in picture distortion, image breakup or no picture.
- Do not attempt to connect the HDMI/DVI connector to a PC or Laptop Graphics Card. (This will result in a blank screen being displayed)

DVI AUDIO IN L/R

DVI audio outputs for external devices.

HDMI IN 2

Connect to the HDMI jack of a device with HDMI output.

10 SERVICE

Connector for service only.

11 POWER IN

Connect the supplied power cord.

➢ Supported modes for HDMI/DVI and Component

	480i	480p	576i	576p	720p	1080i
HDMI/DVI 50Hz	X	O	X	O	O	O
HDMI/DVI 60Hz	X	O	X	X	O	O
Component	O	O	O	O	O	O

Viewing the Remote Control

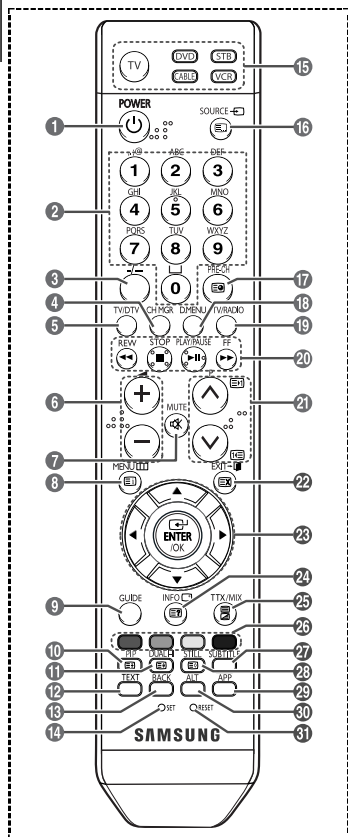

- 1 POWER button (turns the TV on and off)
- 2 Number buttons for direct channel access
- 3 One/Two-digit channel selection
- 4 Channel control button (Refer to page 13)
- 5 Selects the TV and DTV mode directly
- 6 \oplus Volume increase
 \ominus Volume decrease
- 7 Temporary sound switch-off
- 8 Displays the main on-screen menu
- 9 Electronic Program Guide (EPG) display
- 10 Picture-In-Picture On/Off
- 11 Sound mode selection
- 12 Not available
- 13 This button is also used to back to the previous page in D.MENU.
- 14 Remote control setup
- 15 Selects a target device to be controlled by the Samsung remote control (TV, DVD, STB, CABLE, VCR)
- 16 Available source selection
- 17 Previous channel
- 18 DTV menu display
- 19 Toggle between the TV and Radio channel
- 20 VCR/DVD Function (Rewind, Stop, Play/Pause, Fast/Forward)
- 21 \odot Next channel
 \oslash Previous channel
- 22 Exit from the on-screen menu
- 23 Control the cursor in the menu
- 24 Use to see information on the current broadcast
- 25 Fastext topic selection
- 27 Digital subtitle display
- 28 Picture freeze
- 29 Not available
- 30 Select the soundtrack/ videotrack list for the current service
- 31 If your remote control is not functioning properly, take out the batteries and press the reset button for about 2-3 seconds. Re-insert the batteries and try using the remote control again.

Teletext Functions (Refer to page 32)

- 5 Exit from the teletext display (depending on the model)
- 6 Teletext index
- 10 Teletext hold
- 11 Teletext size selection
- 16 Teletext mode selection (LIST/FLOF)
- 17 Teletext sub page
- 23 P \odot : Teletext next page
P \oslash : Teletext previous page
- 28 Teletext cancel
- 24 Teletext reveal
- 25 Teletext display/mix both
Pressing TEXT/MIX selects Teletext, Double, or Mix mode in sequence.
- 26 Fastext topic selection
- 29 Teletext store

- The performance of the remote control may be affected by bright light.
- This is a special remote control for the visually impaired persons, and has Braille points on the Power, Channel, Volume, Stop and Play/Pause buttons.

Installing Batteries in the Remote Control

- 1 Lift the cover at the back of the remote control upward as shown in the figure.
- 2 Install two AAA size batteries.
 - Make sure to match the "+" and "-" ends of the batteries with the diagram inside the compartment.
- 3 Close the cover as shown in the figure.
 - Remove the batteries and store them in a cool, dry place if you won't be using the remote control for a long time. The remote control can be used up to about 23 feet from the TV. (Assuming typical TV usage, the batteries last for about one year.)





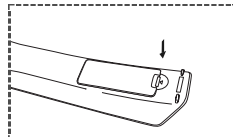
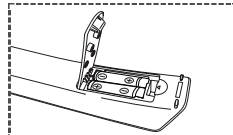
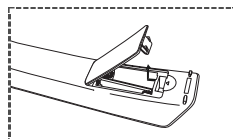

➤ **If the remote control doesn't work! Check the following:**

1. Is the TV power on?
2. Are the plus and minus ends of the batteries reversed?
3. Are the batteries drained?
4. Is there a power cut, or is the power cord unplugged?
5. Is there a special fluorescent light or a neon sign nearby?



Switching Your Television On and Off

The main lead is attached to the rear of the television.

- 1 Plug the main lead into an appropriate socket.
 - The main voltage is indicated on the rear of the television and the frequency is 50 or 60Hz.
- 2 Press the  (Power) button (On/Off) on the front of the television or press the **POWER** () button on the remote control to switch the television on. The programme that you were watching last is re-selected automatically. If you have not yet stored any channels, no clear picture appears. Refer to "Storing Channels Automatically" on page 11 or "Storing Channels Manually" on page 12.
 - If the television is initially powered on, several basic customer settings proceed automatically. Refer to "Plug & Play Feature" on page 10.
- 3 To switch the television off, press the  (Power) button (On/Off) on the front of the television or press the **POWER** () button on the remote control.
- 4 To switch the TV on, press the  (Power) button (On/Off) on the front of the TV or press the **POWER** () button or number buttons on the remote control.

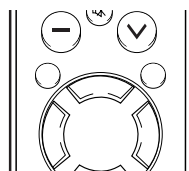

Freezing the Current Picture

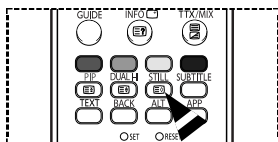

You can freeze the picture when watching a television programme simply by pressing the **STILL** button. To return to normal viewing, press it again.

- To prevent screen burn-in, this function will automatically cancel after 5 minutes.

Plug & Play Feature



When the television is initially powered on, several basic customer settings proceed automatically and subsequently.

The following settings are available.

- 1 If the television is in standby mode, press the **POWER** (⏻) button on the remote control. The message to start Plug & Play is displayed.
- 2 The **Language** menu will automatically appear after several seconds.
- 3 Select the appropriate language by pressing the **▲** or **▼** button. Press the **ENTER/OK** (↵) button. The message to check the connected status of the antenna is displayed.
- 4 Make sure that the antenna is connected to the TV. Press the **ENTER/OK** (↵) button. The **Country** menu is displayed.
- 5 Select your country or area by pressing the **▲** or **▼** button. Press the **ENTER/OK** (↵) button. The menu to select channels is displayed.
- 6 To start channel store, press the **ENTER/OK** (↵) button. The search will end automatically. The TV will begin memorizing all of the available channels. Press the **ENTER/OK** (↵) button to set the clock.
- 7 Press the **◀** or **▶** button to select the hour or minute. Set these by pressing the **▲** or **▼** button.
 - You can enter the Hour, Minute by using the numeric buttons on the remote control.
- 8 Press the **ENTER/OK** (↵) button to confirm your setting. The DTV channel scan menu appears and the DTV channel is automatically updated.
 - If the DTV channel is updated, the Source in the source list of the Input menu is automatically changed to DTV.
 - For detailed descriptions about DTV channel update, refer to page 28 of this manual.



If you want to reset this feature ...

- 1 Press the **MENU** (≡) button to display the menu.
- 2 Press the **▲** or **▼** button to select **Setup**, then press the **ENTER/OK** (↵) button.
- 3 Press the **ENTER/OK** (↵) button again to select **Plug & Play**. The message to start Plug & Play is displayed.

Viewing an External Signal Sources

You can switch between viewing signals from connected equipment, such as a VCR, DVD, Set-Top Box, and the TV source (air or cable).

- 1 Press the **MENU** (□□□) button to display the menu.
- 2 Press the **ENTER/OK** (↵) button to select **Source List**.
- 3 Press the **ENTER/OK** (↵) button again.
- 4 Press the **▲** or **▼** button to select the signal source, then press the **ENTER/OK** (↵) button.

Available signal source: **TV, Ext.1, Ext.2, AV, S-Video, Component, PC, HDMI1, HDMI2, DTV**

- You can select these options simply by pressing the **SOURCE** (←) button on the remote control.
- To watch television programme again, press the **TV/DTV** button and select the channel number required.

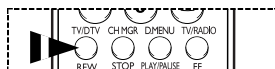
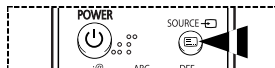

Editing Device Names

You can give a name to the external source.

- 1 Press the **MENU** (□□□) button to display the menu.
- 2 Press the **ENTER/OK** (↵) button.
- 3 Press the **▲** or **▼** button to select **Edit Name**, then press the **ENTER/OK** (↵) button.
- 4 Press the **▲** or **▼** button to select the external source to be edited, then press the **ENTER/OK** (↵) button.
- 5 Select the required device by pressing **▲** or **▼**, then press the **ENTER/OK** (↵) button.

Available device names: **VCR, DVD, D-VHS, Cable STB, HD STB, Satellite STB, AV Receiver, DVD Receiver, Game, Camcorder, DVD Combo, DHR (DVD HDD Recorder), or PC.**

- 6 Press the **EXIT** button to exit.

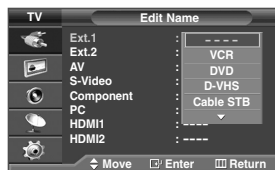

Storing Channels Automatically

- Not available in DTV or external input mode.

You can scan for the frequency ranges available to you (availability depends on your country). Automatically allocated programme numbers may not correspond to actual or desired programme numbers. However you can sort numbers manually and clear any channels you do not wish to watch.

- 1 Press the **MENU** (□□□) button to display the menu.
- 2 Press the **▲** or **▼** button to select **Channel1**, then press the **ENTER/OK** (↵) button.
- 3 Press the **ENTER/OK** (↵) button again. The available countries are listed.
- 4 Select your country by pressing the **▲** or **▼** button, then press the **ENTER/OK** (↵) button.
- 5 Press the **▲** or **▼** button to select **Auto Store**, then press the **ENTER/OK** (↵) button.
- 6 Press the **ENTER/OK** (↵) button again to start the search. The search will end automatically.
 - To stop the search before it has finished, press the **MENU** (□□□) or the **ENTER/OK** (↵) button.



Storing Channels Manually

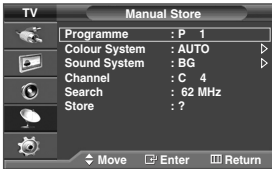

➤ Not available in DTV or external input mode.

You can store television channels, including those received via cable networks. When storing channels manually, you can choose:

- ◆ Whether or not to store each of the channels found.
- ◆ The programme number of each stored channel which you wish to identify.

- 1 Press the **MENU** (□□□) button to display the menu.
 - 2 Press the **▲** or **▼** button to select **Channel**, then press the **ENTER/OK** (⏏) button.
 - 3 Press the **▲** or **▼** button to select **Manual Store**, then press the **ENTER/OK** (⏏) button.
 - 4 Select the required option by pressing the **▲** or **▼** button, then press the **ENTER/OK** (⏏) button.
 - 5 When you are satisfied with your setting, press the **ENTER/OK** (⏏) button.
 - 6 Press the **EXIT** button to exit.
- ◆ **Programme** (Programme number to be assigned to a channel)
 - Press the **▲** or **▼** button until you find the correct number.
 - ◆ **Colour System: AUTO/PAL/SECAM/NTSC4.43**
 - Press the **▲** or **▼** button to select the required colour standard.
 - ◆ **Sound System: BG/DK/I/L**
 - Press the **▲** or **▼** button to select the required sound standard.
 - ◆ **Channel** (When you know the number of the channel to be stored)
 - Press the **▲** or **▼** button to select **C** (Air channel) or **S** (Cable channel).
 - Press the **▶** button, then press the **▲** or **▼** button to select the required number.
 - You can also select the channel number directly by pressing the numeric buttons (0~9).
 - If there is abnormal sound or no sound, re-select the sound standard required.
 - ◆ **Search** (When you do not know the channel numbers)
 - Press the **▲** or **▼** button to start the search.
 - The tuner scans the frequency range until the first channel or the channel that you selected is received on the screen.
 - ◆ **Store** (When you store the channel and associated programme number)
 - Set to **OK** by pressing the **ENTER/OK** (⏏) button.
- 🔑 **Channel mode**
- ◆ **P** (Programme mode): When completing tuning, the broadcasting stations in your area have been assigned to position numbers from P00 to P99. You can select a channel by entering the position number in this mode.
 - ◆ **C** (Air channel mode): You can select a channel by entering the assigned number to each air broadcasting station in this mode.
 - ◆ **S** (Cable channel mode): You can select a channel by entering the assigned number for each cable channel in this mode.

Adding / Locking Channels

- Not available in DTV or external input mode.

Using the Channel Manager, you can conveniently lock or add channels.

- 1 Press the **MENU** (□□) button to display the menu.
- 2 Press the **▲** or **▼** button to select **Channel1**, then press the **ENTER/OK** (↵) button.
- 3 Press the **▲** or **▼** button to select **Channel Manager**, then press the **ENTER/OK** (↵) button.



◆ Adding channels

Using the Channel Manager, you can add channels.

- 4 Select the **Channel Manager** by pressing the **ENTER/OK** (↵) button.
- 5 Move to the (⊕) field by pressing the **▲/▼/◀/▶** buttons, select a channel to be added, and press the **ENTER/OK** (↵) button to add the channel.
 - If you press the **ENTER/OK** (↵) button again, the (✓) symbol next to the channel disappears and the channel is not added.

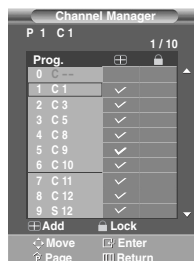

◆ Locking channels

This feature allows you to prevent unauthorized users, such as children, from watching unsuitable programmes by muting out video and audio.

- 4 Press the **▲** or **▼** button to select **Child Lock**, then press the **ENTER/OK** (↵) button.
 - 5 Select **On** by pressing the **▲** or **▼** buttons, then press the **ENTER/OK** (↵) button.
 - 6 Press the **▲** or **▼** buttons to select the **Channel Manager**, then press the **ENTER/OK** (↵) button.
 - 7 Move to the (🔒) field by pressing the **▲/▼/◀/▶** buttons, select a channel to be locked, and press the **ENTER/OK** (↵) button.
 - If you press the **ENTER/OK** (↵) button again, the (✓) symbol next to the channel disappears and the channel lock is canceled.
 - A blue screen is displayed when Child Lock is activated.
 - 8 Press the **EXIT** button to exit.
- You can select these options simply by pressing the **CH MGR** button on the remote control.



Sorting the Stored Channels

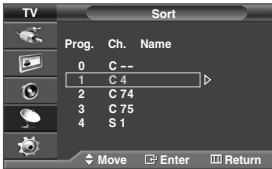

➤ Not available in DTV or external input mode.

This operation allows you to change the programme numbers of stored channels. This operation may be necessary after using auto store.

- 1 Press the **MENU** (□□□) button to display the menu.
- 2 Press the **▲** or **▼** button to select **Channel1**, then press the **ENTER/OK** (↵) button.
- 3 Press the **▲** or **▼** button to select **Sort**, then press the **ENTER/OK** (↵) button.
- 4 Select the channel that you wish to move by pressing the **▲** or **▼** button, then press the **ENTER/OK** (↵) button.
- 5 Select the number of the programme to which the channel is to be moved by pressing the **▲** or **▼** button. Press the **ENTER/OK** (↵) button. The channel is moved to its new position and all other channels are shifted accordingly.
- 6 Repeat steps 4 to 5 until you have moved all the channels to the required programme numbers.
- 7 Press the **EXIT** button to exit.

Assigning Names to Channels

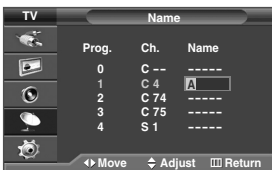

➤ Not available in DTV or external input mode.

Channel names will be assigned automatically when channel information is broadcast. These names can be changed, allowing you to assign new names.

- 1 Press the **MENU** (□□□) button to display the menu.
- 2 Press the **▲** or **▼** button to select **Channel1**, then press the **ENTER/OK** (↵) button.
- 3 Press the **▲** or **▼** button to select **Name**, then press the **ENTER/OK** (↵) button.
- 4 Press the **▲** or **▼** button to select the channel to be assigned to a new name, then press the **ENTER/OK** (↵) button.
- 5 Press the **▲** or **▼** button to select a letter (A-Z), a number (0-9), or a symbol. Move on to the previous or next letter by pressing the **◀** or **▶** button, then press the **ENTER/OK** (↵) button.
- 6 Repeat steps 4 to 5 for each channel to be assigned to a new name.
- 7 Press the **EXIT** button to exit.

Fine Tuning Channel Reception

- Not available in DTV or external input mode.

If the reception is clear, you do not have to fine tune the channel, as this is done automatically during the search and store operation.

If the signal is weak or distorted, you may have to fine tune the channel manually.

- 1 Press the **MENU** (□□□) button to display the menu.
- 2 Press the **▲** or **▼** button to select **Channel1**, then press the **ENTER/OK** (⏏) button.
- 3 Press the **▲** or **▼** button to select **Fine Tune**, then press the **ENTER/OK** (⏏) button.
- 4 To obtain a sharp and clear picture and good sound quality, press the **◀** or **▶** button until you reach the optimal setting. Press the **ENTER/OK** (⏏) button.
 - To reset the fine tuning to **0**, select **Reset** by pressing the **▲** or **▼** button. Press the **ENTER/OK** (⏏) button.
- 5 Press the **EXIT** button to exit.
 - Fine Tune Store will change the colour of the Channel OSD (On Screen Display) from White to Red and add the "*" mark.



LNA (Low Noise Amplifier)

This function is very useful in the situation that the TV is used in weak signal. LNA amplifies the TV signal in the weak signal area, a low-noise preamplifier boosts the incoming signal.

- 1 Press the **MENU** (□□□) button to display the menu.
- 2 Press the **▲** or **▼** button to select **Channel1**, then press the **ENTER/OK** (⏏) button.
- 3 Press the **▲** or **▼** button to select **LNA**, then press the **ENTER/OK** (⏏) button.
- 4 Select **Off** or **On** by pressing the **▲** or **▼** button, then press the **ENTER/OK** (⏏) button.
- 5 Press the **EXIT** button to exit.
 - Depending on areas, factory mode of LNA, will be set up as On or Off.

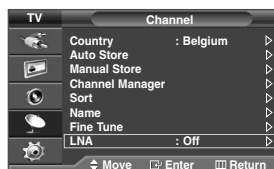

Changing the Picture Standard

You can select the type of picture which best corresponds to your viewing requirements.

- 1 Press the **MENU** (□□□) button to display the menu.
- 2 Press the **▲** or **▼** button to select **Picture**, then press the **ENTER/OK** (⏏) button.
- 3 Press the **ENTER/OK** (⏏) button twice.
- 4 Select the required mode by pressing the **▲** or **▼** button, then press the **ENTER/OK** (⏏) button.

Available modes: **Dynamic, Standard, Movie, Custom**

- The settings values may vary depending on the input source. (ex. RF, Video, Component, PC, or HDMI)
- 5 Press the **EXIT** button to exit.
 - ♦ Choose Dynamic for viewing the TV during the day or when there is bright light in the room.
 - ♦ Choose Standard for the standard factory settings.
 - ♦ Choose Movie when viewing the movie.
 - ♦ Choose Custom if you want to adjust the settings according to personal preference.

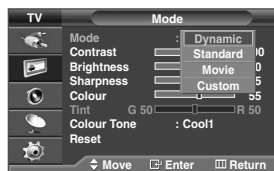

Customizing the Picture Settings

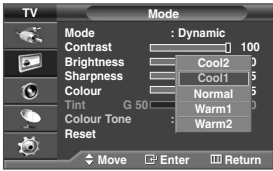

Your television has several setting options that allow you to control the picture quality.

- 1 Press the **MENU** (□□□) button to display the menu.
- 2 Press the **▲** or **▼** button to select **Picture**, then press the **ENTER/OK** (⏏) button.
- 3 Press the **ENTER/OK** (⏏) button twice.

- 4 Select the required mode by pressing the **▲** or **▼** button, then press the **ENTER/OK** (⏏) button.

Available modes: **Dynamic, Standard, Movie, Custom**

- 5 Select the required option by pressing the **▲** or **▼** button, then press the **ENTER/OK** (⏏) button.
- 6 When you are satisfied with your setting, press the **ENTER/OK** (⏏) button.
- 7 Press the **EXIT** button to exit.

◆ **Contrast – Brightness – Sharpness – Colour – Tint** (NTSC only)

◆ **Contrast – Brightness – Colour** : PC Mode

Press the **◀** or **▶** button until you reach the optimal setting.

◆ **Colour Tone: Cool2/Cool1/Normal/Warm1/Warm2**

◆ **Reset:** You can return to the factory defaults picture settings.

➤ The reset function is set for each picture mode and colour tone.

Selecting the Picture Size

You can select the picture size which best corresponds to your viewing requirements.

- 1 Press the **MENU** (□□□) button to display the menu.
- 2 Press the **▲** or **▼** button to select **Picture**, then press the **ENTER/OK** (⏏) button.
- 3 Press the **▲** or **▼** button to select **Size**, then press the **ENTER/OK** (⏏) button.

- 4 Select the required option by pressing the **▲** or **▼** button, then press the **ENTER/OK** (⏏) button.

Available options: **Auto Wide, 16:9, Wide 4:3, Zoom, 4:3**

◆ **Auto Wide:** Expanding and pulling up the picture from **4:3** to **16:9** ratio.

◆ **16:9:** Sets the picture to **16:9** wide mode.

◆ **Wide 4:3:** Magnify the size of the picture more than **4:3**.

Move the screen up/down using the **▲** or **▼** button after selecting the  by pressing the **▶** or **ENTER/OK** (⏏) button.

◆ **zoom:** Magnify the size of the picture vertically on screen.

◆ **4:3:** Sets the picture to **4:3** normal mode.

- 5 Press the **EXIT** button to exit.

➤ If you change the picture size when PIP is On, PIP will automatically be turned Off.

➤ Depending on the input source, the picture size options may vary.

➤ The items available may differ depending on the selected mode.

Positioning and Sizing the screen using Zoom

◆ Resizing the screen using the **Zoom** enables the positioning and sizing of the screen to up/down direction using the **▲** or **▼** button as well as the screen size.

◆ Move the screen up/down using the **▲** or **▼** button after selecting the  by pressing the **◀** or **▶** button.

◆ Resize the screen vertically using the **▲** or **▼** button after selecting the  by pressing the **◀** or **▶** button.

Digital NR / SMD / DNle Demo

- 1 Press the **MENU** (□□) button to display the menu.
- 2 Press the **▲** or **▼** button to select **Picture**, then press the **ENTER/OK** (↵) button.
- 3 Select the required option by pressing the **▲** or **▼** button, then press the **ENTER/OK** (↵) button.

Available options: **Digital NR, SMD, DNle Demo**

- 4 When you are satisfied with your setting, press the **ENTER/OK** (↵) button.
- 5 Press the **EXIT** button to exit.

◆ Digital NR: On/Off

If the signal received by the television is weak, you can activate this feature to reduce any static and ghosting that may appear on the screen.

◆ SMD (Smooth Motion Driver): On/Off

If you set SMD to On, you can view more natural skin and clear text even in fast moving scenes.

➤ SMD is not available in PC mode.

◆ DNle Demo: On/Off

This TV includes the DNle function so as to provide a high visual quality.

If you set DNle Demo to On, you can view an applied DNle and a normal picture on the screen, for demonstration purposes. Using this function, you can view the difference in the visual quality.

➤ DNle™ (Digital Natural Image engine) **DNle**

This feature brings you more detailed image with 3D noise reduction, detail enhancement, contrast enhancement and white enhancement. New image compensation Algorithm gives brighter, clearer, more detailed image to you. DNle™ technology will fit every signal into your eyes.

➤ DNle Demo is not available in PC mode.

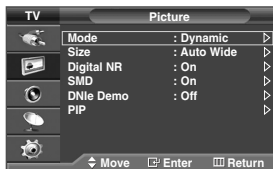

Viewing the Picture in Picture (PIP)

➤ Not available in DTV mode.

You can display a sub picture within the main picture. In this way you can watch TV program or monitor the video input from any connected devices.

- 1 Press the **MENU** (□□) button to display the menu.
- 2 Press the **▲** or **▼** button to select **Picture**, then press the **ENTER/OK** (↵) button.
- 3 Press the **▲** or **▼** button to select **PIP**, then press the **ENTER/OK** (↵) button.
- 4 Select the required option by pressing the **▲** or **▼** button, then press the **ENTER/OK** (↵) button.

Available options: **PIP (On/Off), Source, Position, Programme**

- 5 When you are satisfied with your setting, press the **ENTER/OK** (↵) button.
- 6 Press the **EXIT** button to exit.

◆ PIP: On/Off

You can activate or deactivate the PIP function.

➤ You can select these options simply by pressing the **PIP** button on the remote control.

◆ Source: TV/Ext.1/Ext.2/AV/S-Video

You can select a source of the sub-picture.

◆ Position: []/[]/[]/[]

You can select a position of the sub-picture.

◆ Programme

You can select a channel of the sub-picture only when the **Source** is set to **TV**.

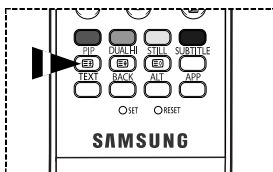
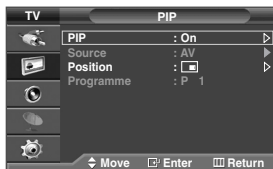

Table of PIP Settings

X - This PIP combination is not available.

O - This PIP combination is available.

Main \ Sub	TV	Ext.1	Ext.2	AV	S-Video	PC
TV	X	X	X	X	X	X
Ext.1	X	X	X	X	X	X
Ext.2	X	X	X	X	X	X
AV	X	X	X	X	X	X
S-Video	X	X	X	X	X	X
Component	X	X	X	X	X	X
PC	O	O	O	O	X	X
HDMI1	O	O	O	O	O	X
HDMI2	O	O	O	O	O	X

Sound Features

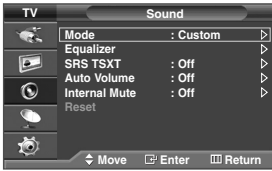

< If Game Mode is On >

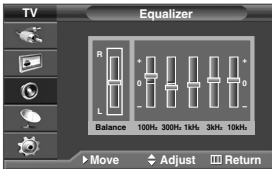
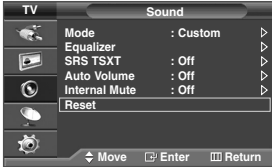

- 1 Press the **MENU** (□□□) button to display the menu.
- 2 Press the **▲** or **▼** button to select **Sound**, then press the **ENTER/OK** (⏏) button.
- 3 Select the required option by pressing the **▲** or **▼** button, then press the **ENTER/OK** (⏏) button.

Available options: **Mode, Equalizer, SRS TSXT, Auto Volume, Internal Mute, Reset** (If Game Mode is On)

- 4 When you are satisfied with your setting, press the **ENTER/OK** (⏏) button.
- 5 Press the **EXIT** button to exit.

◆ **Mode: Standard/Music/Movie/Speech/Custom**

You can select the type of special sound effect to be used when watching a given broadcast.

◆ **Equalizer: Balance/100Hz/300Hz/1kHz/3kHz/10kHz**

The television has several settings which allow you to control the sound quality.

- If you make any changes to these settings, the sound mode is automatically switched to **Custom**.

◆ **SRS TSXT: On/Off**

TruSurround XT is a patented SRS technology that solves the problem of playing 5.1 multichannel content over two speakers. TruSurround delivers a compelling, virtual surround sound experience through any two-speaker playback system, including internal television speakers. It is fully compatible with all multichannel formats.

- TruSurround XT, SRS and (●) Symbol are trademarks of SRS Labs, Inc. TruSurround XT technology is incorporated under license from SRS Labs, Inc.



◆ **Auto Volume: On/Off**

Each broadcasting station has its own signal conditions, and so it is not easy to adjust the volume every time the channel is changed. This feature lets you automatically adjust the volume of the desired channel by lowering the sound output when the modulation signal is high or by raising the sound output when the modulation signal is low.

◆ **Internal Mute: On/Off**

If you want to hear the sound through separate speakers, cancel the internal amplifier.

- The **+** **▲** - and **MUTE** buttons do not operate when the Internal Mute is set to On.

◆ **Reset**

If Game Mode is On, the Reset Sound function is activated. Selecting the Reset function after setting the equalizer resets the equalizer setting to the factory defaults.

Time Features

- 1 Press the **MENU** (□□) button to display the menu.
- 2 Press the **▲** or **▼** button to select **Setup**, then press the **ENTER/OK** (↵) button.
- 3 Press the **▲** or **▼** button to select **Time**, then press the **ENTER/OK** (↵) button.
- 4 Select the required option by pressing the **▲** or **▼** button, then press the **ENTER/OK** (↵) button.



Available options: **Clock Set, Sleep Timer, On Timer, Off Timer**



- 5 When you are satisfied with your setting, press the **ENTER/OK** (↵) button.
- 6 Press the **EXIT** button to exit.

◆ **Clock Set**

You can set the television clock so that the current time is displayed when pressing the **INFO** (□*) button on the remote control. You must also set the time if you wish to use the automatic on or off timers.

- Press the **◀** or **▶** button to select **Hour** or **Minute**.
Set these by pressing the **▲** or **▼** button.
- You can set the hour and minute directly by pressing the numeric buttons on the remote control.
- In the event of a power interruption or the set being turned off at the supply, the settings for the Clock will be lost.

◆ **Sleep Timer**

You can select a time period of between 30 and 180 minutes after which the television automatically switches to standby mode.

- Select the preset time interval (**Off, 30, 60, 90, 120, 150, or 180**) for staying on by pressing the **▲** or **▼** button.
- If the sleep timer is not yet set, **Off** is displayed. If it is already set, the remaining time before which the television switches to standby mode is displayed.

◆ **On Timer / Off Timer**

You can set the On/Off timers so that the television will switch on or off automatically at the time you select.

- ☛ You must set the clock first.
 - **On Timer:** Select **Hour, Minute, Programme, or Volume** by pressing the **◀** or **▶** button.
Set these by pressing the **▲** or **▼** button.
To activate **On Timer** with the setting satisfied, set **Activation** to **Yes** by **▲** or **▼** button.
 - You can set the hour and minute directly by pressing the numeric buttons on the remote control.
 - **Off Timer:** Select **Hour** or **Minute** by pressing the **◀** or **▶** button.
Set these by pressing the **▲** or **▼** button.
To activate **Off Timer** with the setting satisfied, set **Activation** to **Yes** by **▲** or **▼** button.
 - You can set the hour and minute directly by pressing the numeric buttons on the remote control.

☛ **Auto Power Off**

When you set the timer "On", the TV will eventually turn off, if no controls are operated for 3 hours after the TV was turned on by timer. This function is only available in timer "On" mode and prevents overheating, which may occur if a TV is on for too long time.

Language / Blue Screen / Melody / Energy Saving



- 1 Press the **MENU** (□□□) button to display the menu.
- 2 Press the **▲** or **▼** button to select **Setup**, then press the **ENTER/OK** (⏏) button.
- 3 Select the required option by pressing the **▲** or **▼** button, then press the **ENTER/OK** (⏏) button.
Available options: Language, Blue Screen, Melody, Energy Saving
- 4 When you are satisfied with your setting, press the **ENTER/OK** (⏏) button.
- 5 Press the **EXIT** button to exit.

◆ Language

It is variable depending on the model. When you start using the television for the first time, you must select the language which will be used for displaying menus and indications.

◆ Blue Screen: On/Off

If no signal is being received or the signal is very weak, a blue screen automatically replaces the noisy picture background. If you wish to continue viewing the poor picture, you must set the **Blue Screen** to **Off**.

◆ Melody: On/Off

You can hear melody sound when the television is powered on or off.

◆ Energy Saving: Off/Low/Medium/High

This feature adjusts the screen brightness depending on the surrounding lighting conditions.

Off: Switches off the **Energy Saving** mode.

Low: Operates in standard mode regardless of the surrounding illumination.

Medium: Enters Medium power saving mode regardless of the surrounding illumination.

High: Enters maximum power saving mode regardless of the surrounding illumination.

Using Game Mode

When connecting to a game console such as PlayStation™ or Xbox™, you can enjoy a more realistic gaming experience by selecting game menu.



- 1 Press the **MENU** (□□□) button to display the menu.
- 2 Press the **▲** or **▼** button to select **Setup**, then press the **ENTER/OK** (⏏) button.
- 3 Press the **▲** or **▼** button to select **Game Mode**, then press the **ENTER/OK** (⏏) button.
- 4 Select **Off** or **On** by pressing the **▲** or **▼** button, then press the **ENTER/OK** (⏏) button.
- 5 Press the **EXIT** button to exit.

- To disconnect the game console and connect another external device, cancel game mode in the setup menu.
- If you display the TV menu in Game mode, the screen shakes slightly.
- Game Mode is not available in TV mode.
- **If Game Mode is On :**
 - ◆ Picture Mode is automatically changed to Custom and users cannot change the mode.
 - ◆ Sound Mode is automatically changed to Custom and users cannot change the mode.
 - ◆ The Reset Sound function is activated. Selecting the Reset function after setting the equalizer resets the equalizer setting to the factory defaults.

Screen Burn Protection

To reduce the possibility of screen burn, this unit is equipped with screen burn prevention technology. This technology enables you to set picture movement up/down (Vertical Line) and side to side (Horizontal Dot). The Time setting allows you to program the time between movement of the picture in minutes.

- 1 Press the **MENU** (□□) button to display the menu.
- 2 Press the **▲** or **▼** button to select **Setup**, then press the **ENTER/OK** (⏏) button.
- 3 Press the **▲** or **▼** button to select **Screen Burn Protection**, then press the **ENTER/OK** (⏏) button.
- 4 Select the required option by pressing the **▲** or **▼** button, then press the **ENTER/OK** (⏏) button.

Available options: **Pixel Shift, All White, Signal Pattern**

- 5 When you are satisfied with your setting, press the **ENTER/OK** (⏏) button.
- 6 Press the **EXIT** button to exit.

- ◆ **Pixel Shift:** Using this function, you can minutely move pixels on the PDP in horizontal or vertical direction to minimize after image on the screen.

- Set **Pixel Shift** to **On** by pressing the **▲** or **▼** button, then press the **ENTER/OK** (⏏) button.
- Select the required option by pressing the **▲** or **▼** button, then press the **ENTER/OK** (⏏) button.

Available options: **Horizontal Dot, Vertical Line, Time**

- Optimum condition for pixel shift;

Horizontal Dot	4
Vertical Line	4
Time (minute)	4

- ◆ **All White:** This function helps remove after images on the screen by changing the colour of pixels to white. Use this function when there are remaining after images or symbols on the screen especially when you displayed a still image on the screen for a long time.
- ◆ **Signal Pattern:** This function helps remove after images on the screen by moving all the pixels on the PDP according to a pattern. Use this function when there are remaining after images or symbols on the screen especially when you displayed a still image on the screen for a long time.
- To remove after images on the screen, use either "**All White**" or "**Signal Pattern**" function. Although both of the two functions remove after images on the screen, "**Signal Pattern**" is more effective.
- The after image removal function has to be executed for a long time (approximately 1 hour) to effectively remove after images on the screen.
- If after image is not improved after the execution of the function, repeat the function again.
- Press any button on the remote control to cancel this feature.

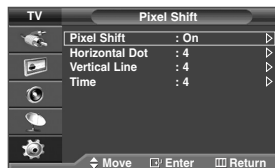
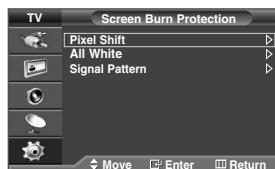

Setting the Blue Eye

You can set the power of Blue LED to be on. If the power is off when Blue Eye is off, the Blue LED goes off after 5 seconds. This will save power and reduce eye fatigue.

- 1 Press the **MENU** (□□) button to display the menu.
- 2 Press the **▲** or **▼** button to select **Setup**, then press the **ENTER** (⏏) button.
- 3 Press the **▲** or **▼** button to select **Blue Eye**, then press the **ENTER** (⏏) button.
- 4 Select **Off** or **On** by pressing the **▲** or **▼** button, then press the **ENTER** (⏏) button.
 - ◆ **Off:** LED(Blue) will not come on.
 - ◆ **On:** LED(Blue) will come on after you turn the TV off.
- 5 Press the **EXIT** button to exit.

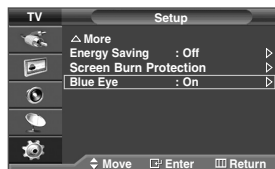

Setting up Your PC Software (Based on Windows XP)

The Windows display-settings for a typical computer are shown below. But the actual screens on your PC will probably be different, depending upon your particular version of Windows and your particular video card. But even if your actual screens look different, the same, basic set-up information will apply in almost all cases. (If not, contact your computer manufacturer or Samsung Dealer.)

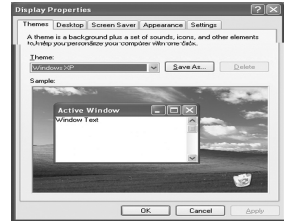

- 1 Right click the mouse on the Windows Desktop, then click on **Properties**. The **Display Properties** will be displayed.
- 2 Click on **Settings** tab, then set the Display Mode with reference to the Display Modes Table. You do not need to change the Colours settings.
- 3 Click on **Advanced**. A new settings dialog box will be displayed.
- 4 Click on the **Monitor** tab, then set the **Screen refresh rate** with reference to the Display Modes Table. Set the Vertical Frequency and Horizontal Frequency individually if you can do so instead of setting the **Screen refresh rate**.
- 5 Click on **OK** to close the window, then Click on **OK** button to the **Display Properties** window. Automatic re-booting may commence at this moment.

Input Mode (PC)

Both screen position and size will vary depending on the type of PC monitor and its resolution. The table below shows all of the display modes that are supported:

Video Signal	Resolution (Dot X Line)	Vertical frequency (Hz)	Horizontal frequency (kHz)	Vertical polarity	Horizontal polarity	
IBM PC / AT Compatible	640 x 350	70.086	31.469	N	P	
	720 x 400	70.087	31.469	P	N	
	640 x 480		59.940	31.469	N	N
			70.000	35.000	N/P	N/P
			72.809	37.861	N	N
			75.000	37.500	N	N
	800 x 600		56.250	35.156	N/P	N/P
			60.317	37.879	P	P
			70.000	43.750	N/P	N/P
			72.188	48.077	P	P
	848 x 480		75.000	46.875	P	P
			60.000	31.020	P	P
	1024 x 768		74.769	37.684	P	N
			60.004	48.363	N	N
			70.069	56.476	N	N
			72.000	57.672	N/P	N/P
			75.029	60.023	P	P





(N: Negative / P: Positive)

- ◆ The interlace mode is not supported.
- ◆ The television might operate abnormally if a non-standard video format is selected.
- ◆ 480i/p, 576i/p, 720p, or 1080i is not available in PC mode.
- ◆ The PC text quality is optimum in **XGA** mode (1024 x 768@60Hz).

➤ This device is a Class B digital apparatus.

Setting the PC

➤ Preset to the **PC** mode by pressing the **SOURCE** () button.

- 1 Press the **MENU** () button to display the menu.
- 2 Press the **▲** or **▼** button to select **Setup**, then press the **ENTER/OK** () button.
- 3 Press the **▲** or **▼** button to select **PC**, then press the **ENTER/OK** () button.
- 4 Select the required option by pressing the **▲** or **▼** button, then press the **ENTER/OK** () button.



Available options: **Image Lock, Position, Auto Adjustment, Image Reset**

- 5 When you are satisfied with your setting, press the **ENTER/OK** () button.
- 6 Press the **EXIT** button to exit.

◆ **Image Lock: Coarse/Fine**

The purpose of picture quality adjustment is to remove or reduce picture noise. If the noise is not removed by Fine-tuning alone, then adjust the frequency as best as possible (coarse) and Fine-tune again.

After the noise has been reduced, re-adjust the picture so that it is aligned on the center of screen.

- 1 Press the **▲** or **▼** button to select **Coarse** or **Fine**, then press the **ENTER/OK** () button.
- 2 Press the **◀** or **▶** button to adjust the screen quality, vertical stripes may appear or the picture may be blurry. Press the **ENTER/OK** () button.

◆ **Position:**

Adjust the PC's screen positioning if it does not fit the TV screen.

- 1 Adjust the position by pressing the **▲/▼/◀/▶** button.
- 2 Press the **ENTER/OK** () button.

◆ **Auto Adjustment:**

Auto adjustment allows the PC screen of set to self-adjust to the incoming PC video signal. The values of fine, coarse and position are adjusted automatically.

◆ **Image Reset:**

You can replace all image settings with the factory default values.

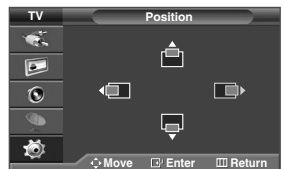
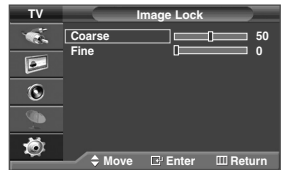
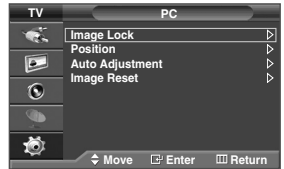

Auto Adjustment in progress
Please wait

Image Reset has completed.
Return

Previewing the DTV Menu System

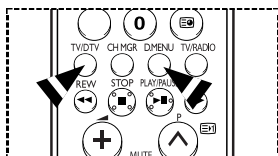

- Available in DTV mode.
- Preset to the DTV mode by using the **TV/DTV** button on your remote control.

To help you navigate around the on-screen menu system and adjust the various settings available, refer to the following illustration.

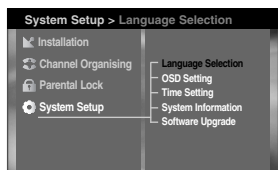
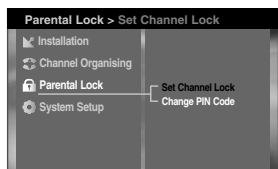
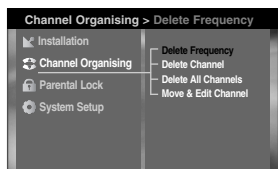
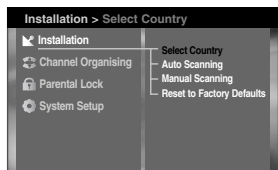

Press the **D.MENU** button on your remote control.

- **Installation**
 - **Select Country**
 - **Auto Scanning**
 - **Manual Scanning**
 - **Reset to Factory Defaults**
- **Channel Organising**
 - **Delete Frequency**
 - **Delete Channel**
 - **Delete All Channels**
 - **Move & Edit Channel**
- **Parental Lock**
 - **Set Channel Lock**
 - **Change PIN Code**
- **System Setup**
 - **Language Selection**
 - **OSD Setting**
 - **Time Setting**
 - **System Information**
 - **Software Upgrade**

- The sub-items of the CI Menu may vary depending on the CAM model.
- In the Digital TV mode, do not turn the power off before the screen is completely loaded.

Basic Functions



6. Program Information

EPG-Electronic Program Guide

The electronic program guide gives you a programme list for the channels.

- 1. This service depends on service provider.
- 2. After receiver recognized the GMT - time from the signal which takes few seconds, it can display correct EPG information.

- Press the **GUIDE** button while you are viewing a program.

This function is displayed on the screen by using only time.

- **RED** button: Red button is for moving back to the previous date.
- **GREEN** button: Green button is for moving to the next coming date.
- **INFO** button: This button is used to watch the program information, if there is more information than one page. Use the **▲** or **▼** buttons to move up and down pages.
- **◀** or **▶** button: Use to display the program list by 30 minutes per block.

Time interval can be adjusted by pressing buttons as followings on EPG screen:

- 1 button: 1 hour and 30 minutes
- 2 button: 30 minutes
- 3 button: 15 minutes

- Select the channel by pressing the **▲** or **▼** buttons and press the **ENTER/OK** (**↵**) button to watch this channel.

Operating the DTV Menu

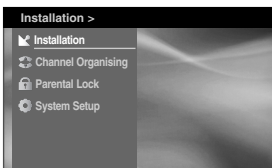

Main Menu

After installing your antenna system and TV with appropriate connectors.

- Plug in the AC main power and switch on the TV.
- Press the **D.MENU** button to bring up the main menu.

The following on-screen display will appear:

The sub menu topics will be displayed. For the sub-menus **Installation**, **Channel Organising** and **Parental Lock**, you need the PIN Code.

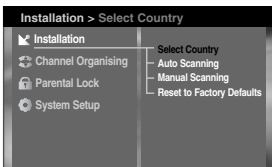

1. Installation

This menu consists of 4 sub-menus:

Select Country, Auto Scanning, Manual Scanning and Reset to Factory Defaults.

- Select **Installation** by pressing the **ENTER/OK** (**↵**) button in the main menu mode to select the sub menu.
- Enter the PIN Code.
- If you have not entered your own PIN Code then the PIN Code 0000 applies, which was set at the factory.
- Once you have entered PIN Code, you do not have to input the code again unless you turn the TV power off.

continued..



Operating the DTV Menu

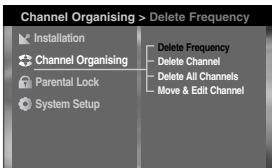

2. Channel Organising

The "Channel Organising" menu has four functions:
The "Channel Organising" menu is used to delete the Frequencies and Channels or Move&Edit Channel as you want.

- Enter the PIN Code.
If you have not entered your own PIN Code 0000 applies, which was set at the factory.
- Once you have entered PIN Code, you do not have to input the code again unless you turn the TV power off.

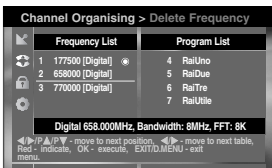

2.1 Delete Frequency

- Select the desired frequency list you want to delete by pressing the **RED** button.
- Press the **ENTER/OK** () button for confirmation.
- This feature doesn't delete frequency itself but deletes the list of channels registered for frequency.

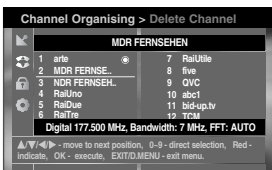

2.2 Delete Channel

- Select the desired channel you want to delete by pressing the **RED** button.
- Press the **ENTER/OK** () button for confirmation.

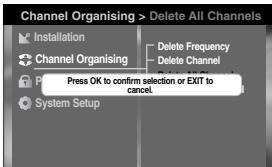

2.3 Delete All Channels

At the request window, press the **ENTER/OK** () button to delete all channels and press the **EXIT** button to exit.

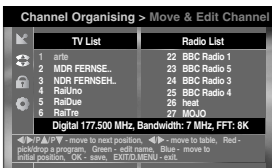

2.4 Move & Edit Channel

To move the Channel Name

- Select the TV/RADIO/Interactive list with **◀** or **▶** buttons.
- Select the TV/RADIO/Interactive list with **▲/▼** or **P** () buttons.
- Select channel by pressing the **RED** button.
- Press the **▲** or **▼** buttons to change the position of the channel you want, and **P** () for moving up or down pages on list. Press the **ENTER/OK** () button for confirmation.
- If you want to return the channel to the initial position, do not press the **ENTER/OK** () button but press the **BLUE** button.

To edit Channel Name

- Select the TV/RADIO/Interactive list with **◀** or **▶** buttons.
- Select a channel list to move to other location with **▲/▼** or **P** () buttons.
- Press the **GREEN** button. Font Table will be displayed.
- Select desired character with **▲/▼/◀/▶** and then press the **ENTER/OK** () button to paste character to the string.
- **P** () button : Backspace for deleting previous character.
- Press the **D.MENU** button and then press the **ENTER/OK** () button to save the set data. The message **Please Wait...** is displayed.

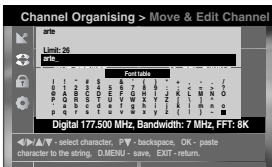

continued..

Operating the DTV Menu

3. Parental Lock

This "Parental Lock" feature sets viewing restrictions and prevents unauthorized access to your TV through the PIN (Personal Identification Number), which is a 4-digit number. (The factory preset PIN Code : 0000) On selecting this menu, you will have two options: to set lock for any desired channel and to change your PIN Code.

- Enter the PIN Code.
If you have not entered your own PIN Code then the PIN Code 0000 applies, which was set at the factory.

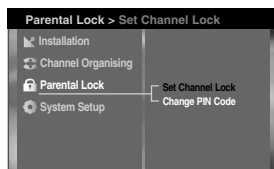

3.1 Set Channel Lock

- Select the channel by pressing the ▲/▼/◀/▶ buttons.
- Select the channel lock by pressing the **RED** button.
- Press the **ENTER/OK** (⏏) button for confirmation.

Whenever you need to view the locked channel, you will have to enter the PIN Code at the request window. After entering PIN Code to be able to access a parental locked channel, it will work on all parental locked channels. It means that you can access all parental locked channels with entering PIN Code on any parental locked channel successfully.

To cancel the lock:

- Press the **RED** button again in order to cancel the lock.

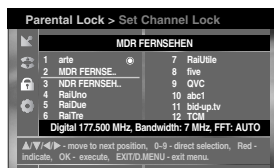

3.2 Change PIN Code

To change the PIN Code, select the second option "Change PIN Code".

This will take you to the following menu:

In this option, you need to enter the current PIN Code at the first cursor, and at the second cursor enter the desired PIN Code. To confirm, you need to enter the new PIN Code again.

Please remember the PIN Code should be a 4 digit numerical value.

THE FACTORY PRESET PIN CODE : **0 0 0 0**.

- If you forget the PIN Code, contact your dealer or service provider.
Once you change password, please do not forget and keep well.

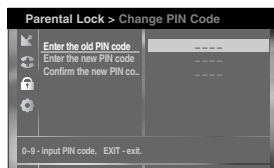



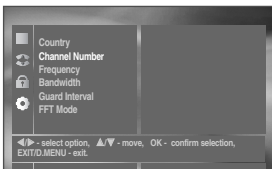



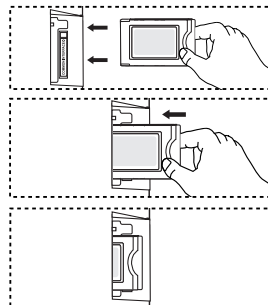

continued...



Installing the CI card

- 1 Purchase the CI CAM module by visiting your nearest dealer or by phone.
- 2 Insert the CI card into the CAM in the direction of the arrow until it fits.
- 3 Insert the CAM with the CI card installed into the common interface slot.
 - Insert the CAM in the direction of the arrow, right up to the end so that it is parallel with the slot.
- 4 Check if you can see a picture on a scrambled signal channel.
 - You can install the CAM anytime whether the TV is ON or OFF.



- 6**  **(page up)**
Used to display the next teletext page.
 - 7**  **(mode)**
Press to select the teletext mode (LIST/FLOF).
If you press it in the LIST mode, it switches into the List save mode.
In the List save mode, you can save teletext page into list using the  (store) button.
 - 8**  **(page down)**
Used to display the previous teletext page.
 - 9**  **(index)**
Used to display the index (contents) page at any time while you are viewing teletext.
 - 10**  **(reveal)**
Used to display the hidden text (answers to quiz games, for example). To display normal screen, press it again.
 - 11** **Coloured buttons (red/green/yellow/blue)**
If the FASTEXT system is used by a broadcasting company, the different topics covered on a teletext page are colour-coded and can be selected by pressing the coloured buttons. Press one of them corresponding to the required. The page is displayed with other coloured information that can be selected in the same way.
To display the previous or next page, press the corresponding coloured button.
 - 12**  **(cancel)**
Used to display the broadcast when searching for a page.
 - 16** **TV/DTV (exit)**
Exit from the teletext display
- You can change teletext pages by pressing the numeric buttons on the remote control.

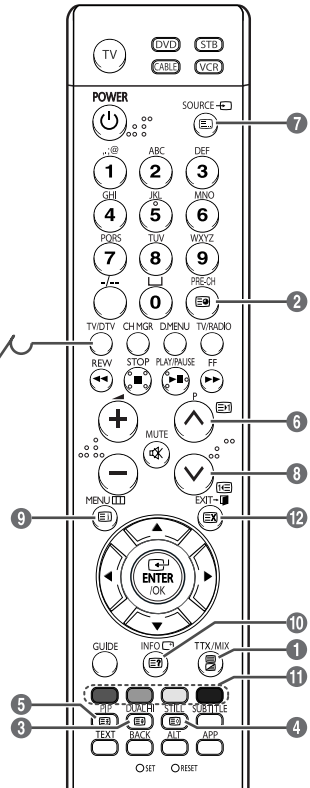

Teletext Feature

The teletext pages are organized according to six categories:

Part	Contents
A	Selected page number.
B	Broadcasting channel identity.
C	Current page number or search indications.
D	Date and time.
E	Text.
F	Status information. FASTEXT information.

- Teletext information is often divided between several pages displayed in sequence, which can be accessed by:
 - ◆ Entering the page number
 - ◆ Selecting a title in a list
 - ◆ Selecting a coloured heading (FASTEXT system)
- Press the **TV/DTV** button to exit from the teletext display.

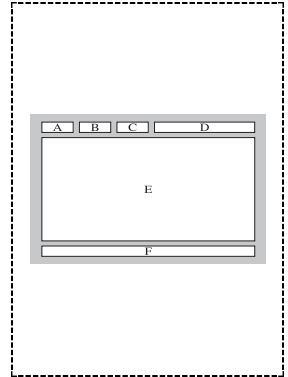

How to Install the Wall Mount Bracket

- This installation guide may be different from the PDP User's manual. Please refer to the proper installation guide for your product.

Installation Notes

- ◆ Contact a technician for installing the wall bracket.
- ◆ Samsung Electronics is not responsible for any damages to the product or harm to customers when the installation is done by the customer.
- ◆ This product is for installing on cement walls. The product may not stay in place when installed on plaster or wood.
- ◆ The package contents and parts supplied for the wall mount are subject to change without prior notice.

Mounting Kits

- ◆ Please use only the parts and components provided for wall mount installation.

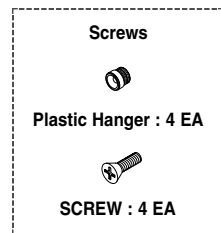
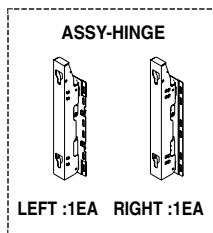
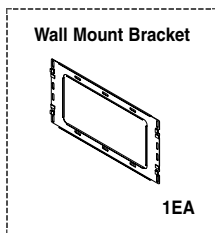

How to assemble the Wall Mount Bracket

- 1 The wall mount bracket is delivered separately. Please tighten the captive screw in the direction of the arrow after assembling the bracket. Install the Wall Mount Bracket after the screws are securely inserted into the wall.

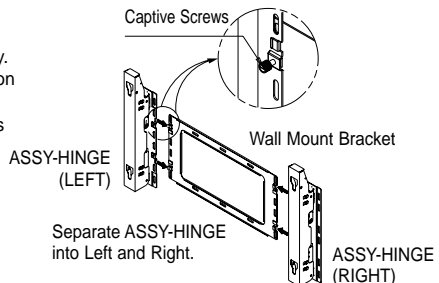

continued...

How to Install the Wall Mount Bracket

Instructions on Securing the SET to the Wall Mount Bracket

➤ The exterior of the SET may be different than the picture. (Assembly and installation of the plastic hanger is the same.)

1 Remove the screws from the back of the PDP.

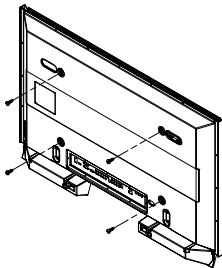

2 Use the screw and assemble the plastic hanger. (Please refer to the following picture.)



- 1 Please ask the installers to install the wall mount bracket.
- 2 Please be sure to check if the plastic hanger is completely secured on both the left and right side after hanging the SET on the wall mount bracket.
- 3 Please avoid catching your fingers while installing and adjusting the angle.
- 4 Please tightly secure the wall mount bracket to the wall to avoid injury from a falling SET.

3 Tighten the screws of the plastic hanger (shown in picture 2) to the back side of the PDP.

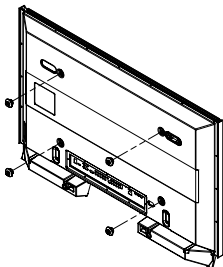

4 Remove the Safety Pins. Fasten the 4 plastic latches assembled at step (3) on the back side of the PDP using the guide holes of the wall mount, push (1) and hook (2) down to secure the PDP on the wall mount as illustrated. Secure the PDP by inserting the Safety Pins.

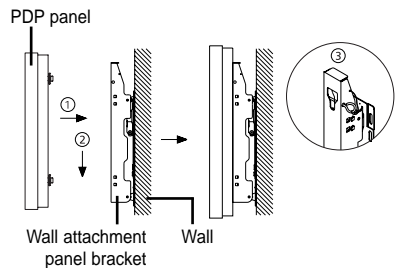

continued...

How to Install the Wall Mount Bracket

How to Adjust Mounting Angle

- Please secure the mounting bracket on the wall surface after setting its angle at 0°

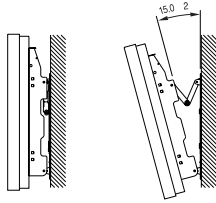

Connecting External Devices to the PDP

- To connect external devices such as a DVD or a Home Theater System to the PDP, please refer to following instructions:

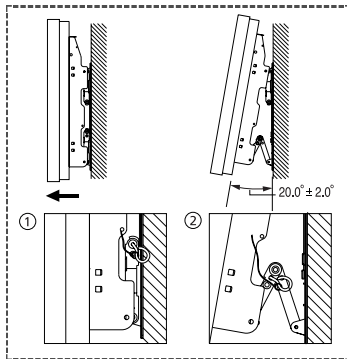

- 1 Be sure to remove the safety pins underneath the PDP.
 - If the safety pins are not removed, the angle cannot be adjusted. Any attempt to do so may cause damage to the PDP.
- 2 Hold onto the bottom of the PDP and pull forward fully as directed by the arrow as illustrated) to adjust the angle. (0°~20° by 2°) Insert the Safety Pins to the front guide holes on both sides as illustrated in figure ②.
 - Viewing the PDP after connecting the external devices Remove the Safety Pins to adjust the angle to 0°, and then secure the Safety Pins again.
 - ☛ For safety, be sure to secure the PDP using the safety pins. If the safety pins are not used, the PDP may fall, causing serious injury.

Setting Up Your Remote Control

After it has been set up properly, your remote control can operate in five different modes: TV, VCR, Cable, DVD, or Set-Top Box. Pressing the corresponding button on the remote control allows you to switch between these modes, and control whichever piece of equipment you choose.

➤ The remote control might not be compatible with all DVD Players, VCRs, Cable boxes, and Set-Top Boxes.

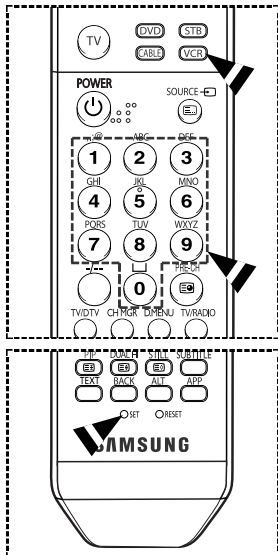

Setting Up the Remote to Operate Your VCR

- 1 Turn off your VCR.
- 2 Press the **VCR** button on your TV's remote control.
- 3 Press the **SET** button on your TV's remote control.
- 4 Using the number buttons on your remote control, enter three digits of the VCR code listed on page 38 of this manual for your brand of VCR. Make sure you enter three digits of the code, even if the first digit is a "0". (If more than one code is listed, try the first one.)
- 5 Press the **POWER** button on the remote control. Your VCR should turn on if your remote is set up correctly.

If your VCR does not turn on after set-up, repeat steps 2, 3 and 4, but try one of the other codes listed for your brand of VCR. If no other codes are listed, try each VCR code, 000 through 080.

Note on Using Remote Control Modes: VCR

When your remote control is in "VCR" mode, the volume buttons still control your TV's volume.

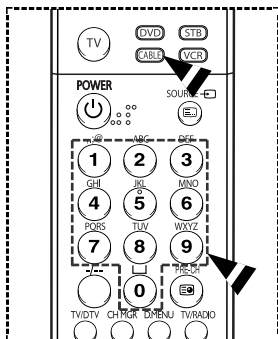

Setting Up the Remote to Operate Your Cable Box

- 1 Turn off your cable box.
- 2 Press the **CABLE** button on your TV's remote control.
- 3 Press the **SET** button on your TV's remote control.
- 4 Using the number buttons on your remote control, enter three digits of the cable box code listed on page 39 of this manual for your brand of cable box. Make sure you enter three digits of the code, even if the first digit is a "0". (If more than one code is listed, try the first one.)
- 5 Press the **POWER** button on the remote control. Your cable box should turn on if your remote is set up correctly.

If your cable box does not turn on after set-up, repeat steps 2, 3 and 4, but try one of the other codes listed for your brand of cable box. If no other codes are listed, try each code, 000 through 046.

Note on Using Remote Control Modes: Cable Box

When your remote control is in "CABLE" mode, the volume buttons still control your TV's volume.

Setting Up Your Remote Control

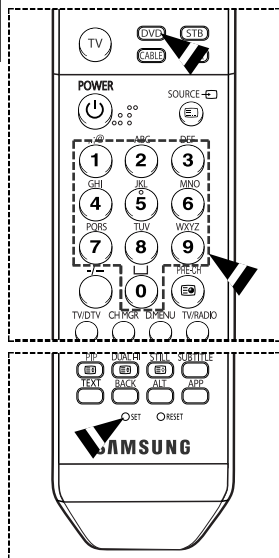

Setting Up the Remote to Operate Your DVD

- 1 Turn off your DVD.
- 2 Press the **DVD** button on your TV's remote control.
- 3 Press the **SET** button on your TV's remote control.
- 4 Using the number buttons on your remote control, enter three digits of the DVD code listed on page 40 of this manual for your brand of DVD. Make sure you enter three digits of the code, even if the first digit is a "0". (If more than one code is listed, try the first one.)
- 5 Press the **POWER** button on the remote control.
Your DVD should turn on if your remote is set up correctly.

If your DVD does not turn on after set-up, repeat steps 2, 3 and 4, but try one of the other codes listed for your brand of DVD. If no other codes are listed, try each code, 000 through 141.

Note on Using Remote Control Modes: DVD

When your remote control is in "DVD" mode, the volume buttons still control your TV's volume.

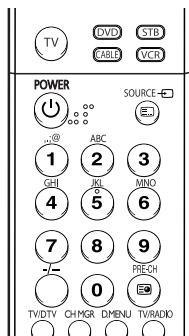

Setting Up the Remote to Operate Your Set Top Box

- 1 Turn off your STB.
- 2 Press the **STB** button on your TV's remote control.
- 3 Press the **SET** button on your TV's remote control.
- 4 Using the number buttons on your remote control, enter three digits of the STB code listed on page 39 of this manual for your brand of STB. Make sure you enter three digits of the code, even if the first digit is a "0". (If more than one code is listed, try the first one.)
- 5 Press the **POWER** button on the remote control.
Your STB should turn on if your remote is set up correctly.

If your STB does not turn on after set-up, repeat steps 2, 3 and 4, but try one of the other codes listed for your brand of STB. If no other codes are listed, try each code, 000 through 074.

Note on Using Remote Control Modes: STB

When your remote control is in "STB" mode, the volume buttons still control your TV's volume

Setting Up Your Remote Control

Remote Control Codes

VCR

Brand	Code
SAMSUNG	000 001 002 003 004 005 077 078 079
ADMIRAL	020
AIWA	025
AKAI	004 027 032
AUDIO DYNAMICS	007 026
BELL&HOWELL	018
BROKSONIC	022
CANDLE	002 003 006 008 015 055
CANON	021 056
CITIZEN	002 003 006 008 015 055
COLORTYME	007
CRAIG	002 024
CURTIS MATHES	002 007 008 017 021 025 056 064 066
DAEWOO	003 010 011 012 013 014 015 016
DB	007 026
DIMENSIA	017
DYNATECH	025
ELECTROHOME	034
EMERSON	001 003 006 021 022 025 030 032 034 040 047 050 052 060 063 065 066 067 069 073
FISHER	018 024 028 029 048 051 061
FUNAI	025
GENERAL ELECTRIC	002 005 017 021 056
GO VIDEO	002
LG(Goldstar)	006 007 008 009 010
HARMAN KARDON	007
HITACHI	019 025 041 042 074
INSTANT REPLAY	021
JC PENNEY	002 007 018 019 021 026 037 041 054 056
JCL	007 008 018 021 026 037
KENWOOD	007 008 018 026 037
KLH	070
LLOYD	025
LOGIK	038
LXI	025
JVC	081 082 083
MAGNAVOX	021 056 059
MARANTZ	007 008 018 021 026 037 062
MARTA	006
KONIA	036
ORION	073 074 075 076
MEI	021
MEMOREX	006 021 024 025
MGA	034
MIDLAND	005
MINOLTA	019 041 075

Brand	Code
MITSUBISHI	019 034 041 046
MONTGOMERY WARD	020
MTC	002 025
MULTITECH	002 005 025 038
NEC	007 008 018 026 037 062 064
OPTIMUS	020
PANASONIC	021 056 071 072
PENTAX	019 041 075
PENTEX RESEARCH+	008
PHILCO	021 056 059
PHILIPS	021 080
PIONEER	019 026 039 053
PORTLAND	015 049 055
PROSCAN	017
QUARTZ	018
QUASAR	021 056
RADIO SHACK/REALISTIC	006 018 020 021 024 025 029 034 048 056
RCA	002 017 019 021 035 041 043 057 068 076
SANSUI	026
SANYO	018 024
SCOTT	003 047 052 067
SEARS	006 018 019 024 028 029 041 048 051
SHARP	020 034 045 015
SHINTOM	027 033 038 058
SIGNATURE	025
SONY	027 033 044
SYLVANIA	021 025 056 059
SYMPHONIC	025
TANDY	018 025
TASHIKA	006
TATUNG	037
TEAC	025 037 068
TECHNICS	021
TEKNIKA	006 021 025 031
TMK	066
TOSHIBA	003 019 029 051 052
TOTEVISION	002 006
UNITECH	002
VECTOR RESEARCH	007 026
VICTOR	026
VIDEO CONCEPTS	007 026
VIDEOSONIC	002
WARDS	002 003 006 019 020 021 024 025 034 038 041
YAMAHA	007 008 018 026 037
ZENITH	023 027 033

continued...

Setting Up Your Remote Control

CABLE BOX

Brand	Code
SAMSUNG	000 001 002 003 004 005 006 007
GI	041
HAMLIN	003 024 031
HITACHI	025 030
JERROLD	038 039
MACOM	025 030
MAGNAVOX	019 023 028
OAK	026
PANASONIC	003 022 027 037 044
PHILIPS	019 021 023 028
PIONEER	004 018 020 044
RCA	014 022 040
REGAL	003

Brand	Code
REGENCY	015 023
SA	042 043
SCIENTIFIC ATLAN	042 043
SPRUCER	022
STARGATE 2000	036
SYLVANIA	016
TEXSCAN	016
TOCOM	032
UNIVERSAL	033 034
VIEWSTAR	019 021 023 028
WARNER AMEX	046
ZENITH	017 029 035 037 045

SAMSUNG SET-TOP BOX

Product	Code
Ground wave STB	001 002
Satellite STB	003
CABLE STB	004
STB DVD COMBO	008
Satellite STB HDD COMBO Standard	009

Product	Code
Satellite STB HDD COMBO Premium	010
CABLE STB HDD COMBO Standard	011
CABLE STB HDD COMBO Premium	012
Ground wave STB HDD COMBO Standard	013
Ground wave STB HDD COMBO Premium	014

SET-TOP BOX

Brand	Code
ALPHASTAR	023
ANAM	043
CHANNEL MASTER	018 034
CROSSDIGITAL	019
CHAPARRAL	035
DIRECT TV	015 016 017 019 022 045 060 061 062 065 066 067 068
DAEWOO	074
DISH NETWORK SYSTEM	069 070
DISHPRO	069
DRAKE	018 024 032
DX ANTENNA	027
ECHOSTAR	025 069 070 071
EXPRESSVU	069
GOI	069
GE	065
GENERAL INSTRUMENT	046 047 048 063 064
HTS	069
HOME CABLE	056
HITACHI	022
HUGHES NETWORK	015 017
IQ	020
IQ PRISM	020
JANEIL	059
JERROLD	063
JVC	069 070

Brand	Code
LG(Goldstar)	044 073
MAGNAVOX	016 021 036 038 039 040 041 042
MEMOREX	016
MOTOROLA	064
MACOM	018
MITSUBISHI	015
NEXT LEVEL	047 048 064
PHILIPS	015 016 017 021 033 036 038 039 040 041 042 067
PRIMESTAR	046 049 050 063
PANASONIC	058 059 061 062
PAYSAT	016
PROSCAN	065 066
RCA	051 052 053 065 066
RADIOSHACK	064
REALISTIC	057
STS	020 027
STAR TRAK	026
SKY	031
SKY LIFE	005 006 007
SHACK	064
STAR CHOICE	064
SONY	054 060
TOSHIBA	015 017 028 029 030 072
ULTIMATE TV	060 066
UNIDEN	016 021 037 055 056 057
ZENITH	024 031 068

continued...

Setting Up Your Remote Control

SAMSUNG DVD

Product	Code
DVD	000 001 002
DVDR	003 004
BD Record	005 006
VCR COMBO	007 008 009 010 011
VCR Record	012
DHR COMBO	013

Product	Code
Home Theater VCR COMBO	014 015 016
HDD Record COMBO	017
TWIN TRAY COMBO	018
STB DVD COMBO	019
DVD Receiver	020
AV Receiver	021

DVD

Brand	Code
ANAM	030
AUDIOVOX	075
AUDIOLOGIC	085
ANABA	072
APEX DIGITAL	070 071 074 086 083 084 088 111 112
AIWA	114
BROKSONIC	062
BLAUPUNKT	074
B&K	122 123
CURTIS MATHES	027
CYBER HOME	065 077 078 079 082
CLARION	080 125
CIRRUS	081
CINEVISION	095
DAEWOO	066
DENON	146
FARENHEIT	067 068
FISHER	090
GPX	060
GO VIDEO	061 089 133 135
GE	069 074
GREENHILL	074
HITACHI	064 113
HITEKER	071
HOYO	073
HARMAN / KARDON	091 110
IRT	089
INTEGRA	092
JBL	091
JVC	022 033 115 116
JATON	073
KENWOOD	051 108 109
KISS	073
KONKA	059 100 106 107
KLH	074 075
LG(Goldstar)	025 031
LOEWE	057
LASONIC	058
MOBILE AUTHORITY	054
MEMOREX	055
MALATA	056
MAGNAVOX	076 093
MINTEK	074 094
MONYKA	073

Brand	Code
NORCENT	048 049 050
NEXT BASE	052
NEC	053
NANTAUS	144
NESA	074
OPTOMEDIA ELECTRONICS	105
OPTIVIEW	072
ONKYO	076 092 119
PHILCO	044 045
PRINCETON	046 047
PROSCAN	023
PANASONIC	024 034 124 134 136 137 138
PHILIPS	036 076
ROTEL	117 118
RIO	120
RCA	023 035 074 075 131 132
RAITE	073
ROWA	038
SAMPO	104
SONY	026 029 126 127 128 129 130 141
SHERWOOD	039 041
SVA	042
SYLVANIA	043 093
SHARP	140
SANSUI	062
SANYO	062
SHINSONIC	094
SANYO	090
THOMSON	145
TOSHIBA	028 062 076
TECHNICS	139
TVIEW	072
TOKAI	073
TEAC	096
TECHWOOD	097
TREDEX	098 099 101
URBAN CONCEPTS	076
VENTURER	075
VOCOPRO	102
YAMAHA	032 063
YAMAKAWA	040 073
XWAVE	103
ZENITH	076 121

Troubleshooting

Before contacting the Samsung after-sales service, perform the following simple checks.

If you cannot solve the problem using the instructions below, note the model and serial number of the television and contact your local dealer.

No sound or picture

- ◆ Check that the mains lead has been connected to a wall socket.
- ◆ Check that you have pressed the ⏻ (Power) button (On/Off) on the front panel or press the **POWER** (⏻) button on the remote control.
- ◆ Check the picture contrast and brightness settings.
- ◆ Check the volume.
- ◆ Check if **Internal Mute** is set to **On**.

Normal picture but no sound

- ◆ Check the volume.
- ◆ Check whether the volume **MUTE** button on the remote control has been pressed.

No picture or black and white picture

- ◆ Adjust the colour settings.
- ◆ Check that the broadcast system selected is correct.

Sound and picture interference

- ◆ Try to identify the electrical appliance that is affecting the television, then move it further away.
- ◆ Plug the television into a different mains socket.

Blurred or snowy picture, distorted sound

- ◆ Check the direction, location and connections of your aerial.
This interference often occurs due to the use of an indoor aerial.

Remote control malfunctions

- ◆ Replace the remote control batteries.
- ◆ Clean the upper edge of the remote control (transmission window).
- ◆ Check that the "+" and "-" ends of the batteries are inserted correctly.
- ◆ Check that the batteries are drained.

Screen is black and power indicator light blinks steadily

- ◆ On your computer check; Power, Signal Cable.
- ◆ The TV is using its power management system.
- ◆ Move the computer's mouse or press any key on the keyboard.
- ◆ On your equipment check (STB, DVD, etc) ; Power, Signal Cable.
- ◆ The TV is using its power management system.
- ◆ Press the Source button on the panel or remote control.
- ◆ Turn the TV off and on.

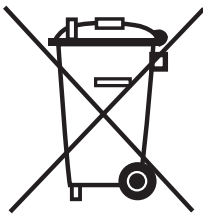

Correct Disposal of This Product **(Waste Electrical & Electronic Equipment)**

(Applicable in the European Union and other European countries with separate collection systems)

This marking shown on the product or its literature, indicates that it should not be disposed with other household wastes at the end of its working life. To prevent possible harm to the environment or human health from uncontrolled waste disposal, please separate this from other types of wastes and recycle it responsibly to promote the sustainable reuse of material resources.

Household users should contact either the retailer where they purchased this product, or their local government office, for details of where and how they can take this item for environmentally safe recycling.

Business users should contact their supplier and check the terms and conditions of the purchase contract. This product should not be mixed with other commercial wastes for disposal.

Free Manuals Download Website

<http://myh66.com>

<http://usermanuals.us>

<http://www.somanuals.com>

<http://www.4manuals.cc>

<http://www.manual-lib.com>

<http://www.404manual.com>

<http://www.luxmanual.com>

<http://aubethermostatmanual.com>

Golf course search by state

<http://golfingnear.com>

Email search by domain

<http://emailbydomain.com>

Auto manuals search

<http://auto.somanuals.com>

TV manuals search

<http://tv.somanuals.com>