

# Circle Surround® Digital Decoder

## U S E R ' S M A N U A L



**Model CSD-07D**

**[www.srslabs.com](http://www.srslabs.com)**

This product is manufactured by SRS Labs, Inc.



P00193 V2.0-FW1.0.6.0

## **IMPORTANT SAFETY INSTRUCTIONS:**

1. Read these instructions.
2. Keep these instructions.
3. Heed all warnings.
4. Follow all instructions.
5. Do not use this apparatus near water.
6. Clean only with a dry cloth.
7. Do not block any of the ventilation openings. Install in accordance with the manufacturers instructions.
8. Do not install near any heat sources such as radiators, heat registers, stoves, or other apparatus (including amplifiers) that produce heat.
9. Do not defeat the safety purpose of the polarized or grounding type plug. A polarized plug has two blades with one wider than the other. A grounding type plug has two blades and a third grounding prong. The wide blade or the third prong are provided for your safety. When the provided plug does not fit into your outlet, consult an electrician for replacement of the obsolete outlet.
10. Protect the power cord from being walked on or pinched particularly at plugs, convenience receptacles, and the point where they exit from the apparatus.
11. Only use attachments/accessories specified by the manufacturer.
12. Use only with a cart, stand, tripod, bracket or table specified by the manufacturer, or sold with the apparatus. When a cart is used, use caution when moving the cart/apparatus combination to avoid injury from tip-over.
13. Unplug this apparatus during lightning storms or when unused for long periods of time.
14. Refer all servicing to qualified service personnel. Servicing is required when the apparatus is damaged in any way, such as power-supply cord or plug is damaged, liquid has been spilled or objects have fallen into the apparatus, the apparatus has been exposed to rain or moisture, does not operate normally, or has been dropped.

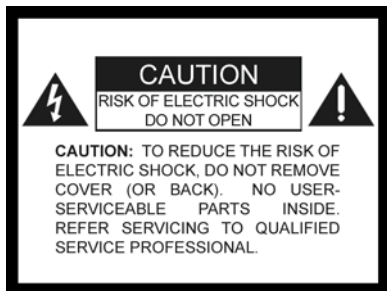

The lightning flash with arrowhead symbol is intended to alert the user to the presence of uninsulated "dangerous voltage" within the product's enclosure that may be of sufficient magnitude to constitute a risk to persons.



The exclamation point, within an equilateral triangle, is intended to alert the user to the presence of important operating and maintenance (servicing) instructions in the literature accompanying the appliance.

**WARNING:** This equipment has been tested and found to comply with the limits for Class A digital device pursuant to Part 15 of the FCC Rules. These limits are designed to provide reasonable protection against harmful interference when the equipment is operated in a commercial environment. This equipment generates, uses, and can radiate radio frequency energy and, if not installed and used in accordance with the instruction's manual, may cause interference to radio communications. Operation of this equipment in a residential area is likely to cause interference in which case the user will be required to correct the interference at their own expense. The user is cautioned that changes and modifications made to the equipment without approval of the manufacturer could void the user's authority to operate this equipment.

It is suggested that the user use only shielded and grounded cables to ensure compliance with FCC Rules.

## Contents:

Company Information .....	2
Introduction .....	3
Front Panel .....	4
Rear Panel .....	5
CSD Setup .....	6
Placement Diagram .....	7
CSD Operation .....	8
Button Function Diagram .....	11
Specifications .....	13
Technical Support .....	14
Warranty Information .....	15

### Company Information:

SRS Labs is a recognized leader in the advancement of audio and voice technology. The company works with the world's top manufacturers to provide a richer entertainment experience through patented sound techniques. SRS Labs' technologies can be heard through products ranging from televisions, LCD and plasma monitors, cell phones, MP3 players, car audio systems, and notebook and desktop computers. The company also offers hardware and software tools to professionals and consumers for the creation, production and broadcast of content featuring SRS Labs' technologies. Based in Santa Ana, Calif., the company also has licensing representation in Hong Kong, Japan, Europe, and Korea. For more information about SRS Labs, Inc. please visit [www.srslabs.com](http://www.srslabs.com).

# Introduction

The SRS CSD-07D Circle Surround<sup>®</sup> Digital Reference Decoder is for use in professional studio production, mastering and broadcast environments to monitor audio, video and multimedia programs encoded with Circle Surround (CS) and other matrix-encoded, two-channel (Lt/Rt) Surround Sound systems. It can be distributed across two-channel carriers such as stereo broadcast television (analog and digital), cable or satellite transmission, VHS videotape, computer and console games, CDs, streaming media and two-channel DVD soundtracks.

As a high-performance 5.1 or 6.1 multichannel decoder, the CSD-07D also delivers superior performance for decoding of any Dolby Surround<sup>®</sup> encoded content (LCRS). The CSD-07D is a versatile tool for professionals to accurately monitor the production of such program material and to evaluate the previously matrix-encoded soundtracks of feature films being prepared for distribution across consumer two-channel formats.

Aside from functioning as a reference monitor, the CSD-07D also features SRS Labs' Xtract<sup>™</sup> technology for use on mono, stereo or LCRS encoded Lt/Rt signals. This function enables the repurposing of legacy material for newer discrete or 5.1 Lt/Rt releases. The post process enhancements enable the mixer to expand the sonic quality in addition to the number of channels available. Mixers can now make any content fit into their 5.1 or 6.1 mix.

The SRS CSD-07D Decoder allows the user to monitor in six modes; CS Cinema (for mixing and extracting Film and TV content), CS Music (for mixing and extracting Music content), CS mono (for extracting mono material to 5.1 or 6.1), LCRS (for monitoring backwards compatibility to legacy LCRS decoders), stereo or mono. This allows the mixer to review the mix in all standard playback formats. The seventh mode, Test Mode, cycles pink noise throughout the channels for calibration purposes. The SRS CSD-07D is the perfect complement to the SRS CSE-07D Encoder.

# Panel

Reference)

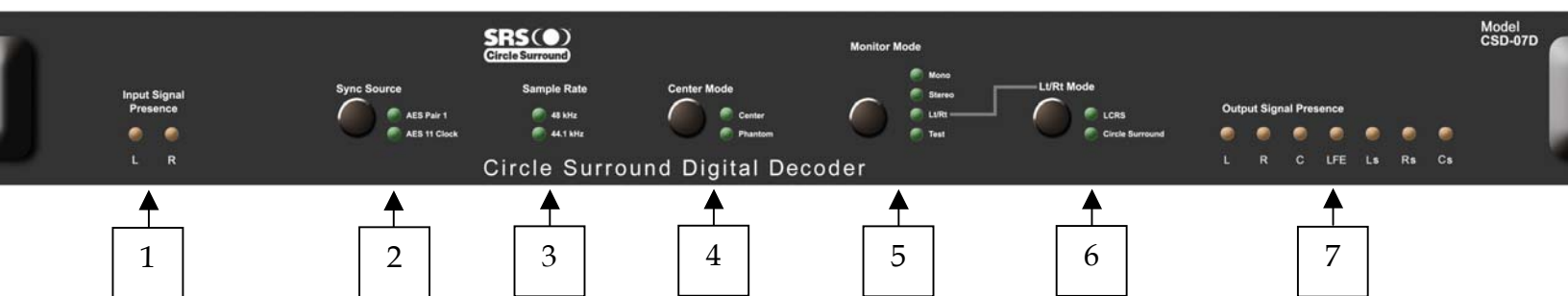

Output Signal Presence Indicators

Sync Source Selector

Sample Rate Indicator

Center Mode Selector

5. Monitor Mode Selector

6. Lt/Rt Mode Selector

7. Output Signal Presence Indicators

# Panel

Reference)

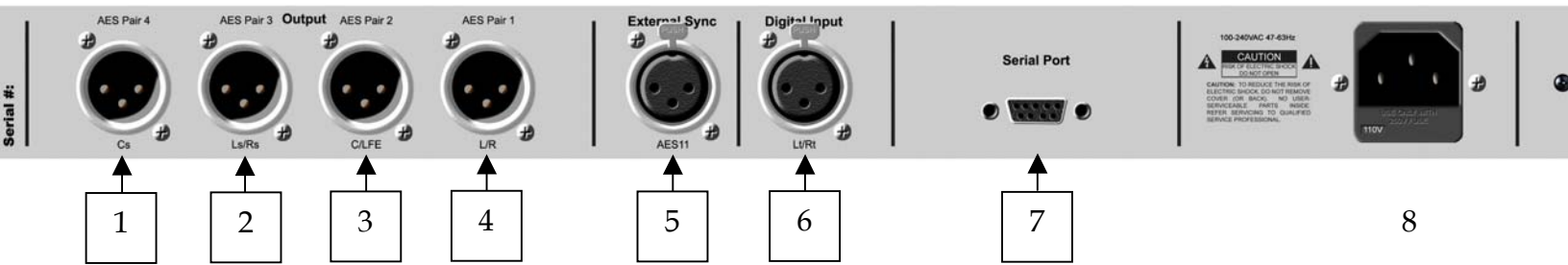

AES Pair 4 Output (Cs)

AES Pair 3 Output (Ls/Rs)

AES Pair 2 Output (C/LFE)

AES Pair 1 Output (L/R)

5. External Sync Input (AES 11)

6. AES Input (Lt/Rt)

7. Serial Port

8. JEDEC Power Connector  
(Auto-switching 100-240VAC, 47-63 Hz)

# CSD-07D Set-up:

## **Placement and Use:**

Install the CSD-07D in the Lt/Rt monitor bus, and before the signal routing to the speaker system.

To ensure accurate monitoring of the Circle Surround mix, it is recommended that a minimum of 5.1 channels be monitored while mixing. Failing to do this may lead to consumers hearing something that was overlooked in the mix process. If necessary, it is possible to place the unit in Phantom Center mode.

Like all matrix encoding systems, it is important to maintain the phase and level relationships between channels. If for any reason symmetry is not maintained, the channel separation will slowly degrade.

One of the features of the CSD-07D Decoder is the ability to generate a compelling, multichannel experience of up to 6.1 channels from any monaural, stereo, Dolby Surround, and down-mixed DTS or Dolby Digital® content.

If you want to create a 5.1 or 6.1 surround mix from an existing mono, stereo or LCRS source, route the stereo signal to the CSD-07D and set the decoder in the appropriate mode (see Decode Mode on pg. 8).

The result is an immersive 5.1 or 6.1 channel soundstage from older LCRS, stereo and mono content, ready for remix or storage onto multichannel recording formats. Once remixed, the multichannel master can then be encoded into a Circle Surround Lt/Rt signal. As with all Circle Surround-encoded content, this signal is backwards compatible with all existing playback formats from mono to 5.1 channel surround sound (i.e. Pro Logic II® and Circle Surround) decoding.

## **Power:**

The Circle Surround Decoder comes with an auto-switching power supply and JEDEC power connector. It is important that the power supplied is within the appropriate voltage range. Failure to do so could result in damage to the unit.

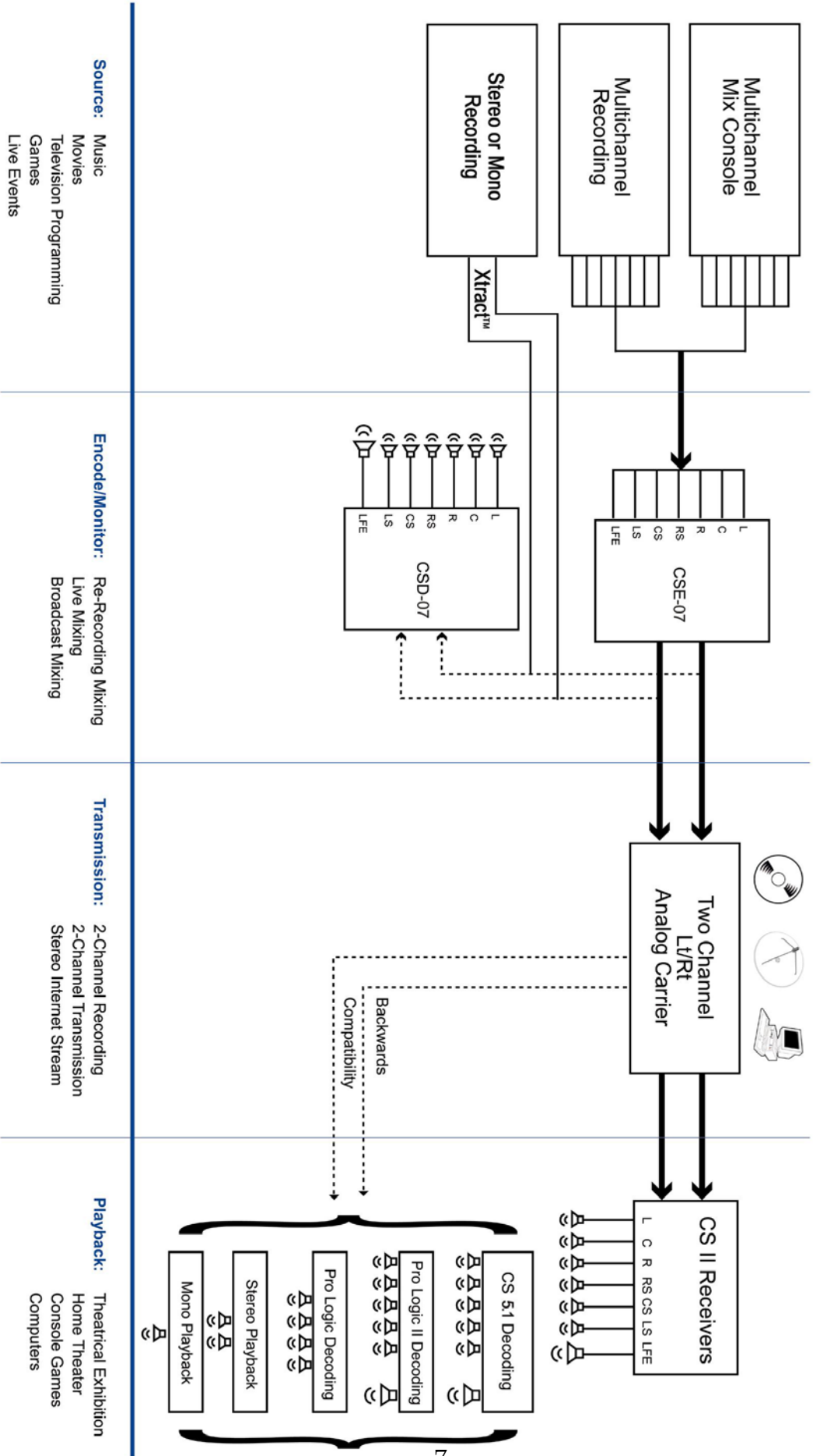



# CSD-07D Operation (see front panel image on page 4)

**1. Input Signal Presence:** Displays signal presence and clip on corresponding input channels. When the LEDs glow green on the front panel, the corresponding channel is receiving a signal  $> -44$  dBFS at the input. If the LED is not illuminated, a signal  $> -44$  dBFS is not present. The clip indicator LEDs will turn red at 0 dBFS.

\* Note that if the signal indicator is not illuminated, it may simply indicate a transitory period where no content is present in the source mix.

**2. Sync Source Switch:** Determines the input source for the Sync signal. When using the clock within the audio signal, choose AES pair 1. When using an external clock source, plug the clock input (AES 11) into the External Sync XLR in on the back of the unit and select AES 11 clock. If there is no valid sync on the selected source, the corresponding LED will flash.

**3. Center / Phantom Switch:** Determines whether the unit outputs a discreet center channel or mixes center into left and right. If a center channel speaker is not available, select the "Phantom" option. If monitoring with a discreet center, select the "Center" option. This function works in mono monitoring as well.

**4. Sample Rate Indicator:** Displays the sample rate of the clock source selected above. If there is no valid sample rate, no LED will be illuminated. If the sample rate is 44.1kHz or 48kHz, the corresponding LED will be illuminated.

**5. Monitor Mode:** Determines how the decoder monitors the incoming signal. The orange LEDs next to the modes will indicate mode status (See Page 11 for Button Function diagram). The five modes are as follows:

**CS Cinema – Lt/Rt LED Solid:** Press the Monitor Mode button until it cycles to Lt/Rt.

Monitors the mix with Circle Surround Cinema decoding. This is ideal for monitoring or extracting TV and film content. Use the additional Lt/Rt Mode selector (see below) to choose whether the output is LCRS, Circle Surround Cinema or Circle Surround Discrete compare.

**Stereo – Stereo LED Solid:** Press the Monitor Mode button until it cycles to Stereo.

Monitors the incoming matrix encoded mix as stereo. Use this setting to confirm backwards compatibility with stereo playback devices.

**CS Music – Stereo LED Blinking:** While in Stereo mode, press and hold the Decode Mode button until the LED goes out and release. To return to any other mode press and release to cycle through to the appropriate mode.

Monitors the mix with Circle Surround Music decoding. This is ideal for monitoring or extracting music content.

**Mono – Mono LED Solid:** Press the Monitor Mode button until it cycles to Mono.

Monitors the incoming matrix encoded mix as mono. Use this setting to confirm backwards compatibility with mono playback devices.

**CS Mono – Mono LED Blinking:** While in Mono mode, press and hold the Decode Mode button until the LED goes out and release. To return to any other mode press and release to cycle through to the appropriate mode.

Monitors the mono mix with Circle Surround Mono decoding. This is ideal for extracting mono music or film content.

**Test** – In order to enter the test mode, press and hold the “Decode Mode” button for one second, then release. This mode will generate a pink noise test signal that cycles between all channels. Once the sequencer has started, it can be paused on a selected channel and restarted by pressing and quickly releasing the “Decode Mode” button. In order to exit the test mode, press and hold the “Decode Mode” button for one second, then release. By functioning in this way, accidental entry into the test mode is minimized.

## 6. Lt/Rt Mode Selector:

Determines the surround output mode (See Page 11 for Button Function diagram).

- **CS Cinema – Lt/Rt LED Solid:** Press the Lt/Rt Mode button until it cycles to Circle Surround.

Allows the mixer to monitor TV or film content in 6.1 surround.

- **CS Discrete Compare Function – Circle Surround LED Blinking:** While in CS Cinema, Music or Mono mode, press and hold the Lt/Rt Mode button for one second and release. To exit CS Discrete Compare, press and hold the Lt/Rt Mode button for one second, then release.

Allows the mixer to monitor CS content in 5.1 or 6.1 surround with adjusted calibration (L and R -2 dB and surrounds -6 dB). This emulates the

discrete by removing the consumer system compensation adjustments. This also closely emulates PLII without any of the dimension, panorama and spread settings enabled.

- **LCRS – LCRS LED Solid:** Press the Lt/Rt Mode button until it cycles to LCRS.

Emulates the performance of older four channel surround receivers.

**7. Output Signal Presence:** Displays signal presence and clip on corresponding output channels. When the LEDs glow green on the front panel, the corresponding channel is outputting a signal > -44 dBFS at the input. If the LED is not illuminated, a signal > -44 dBFS is not present. The clip indicator LEDs will turn red at 0 dBFS.

Note that if the signal indicator is not illuminated, it may simply indicate a transitory period where no content is present in the source mix.

# Monitor Mode Button Flow

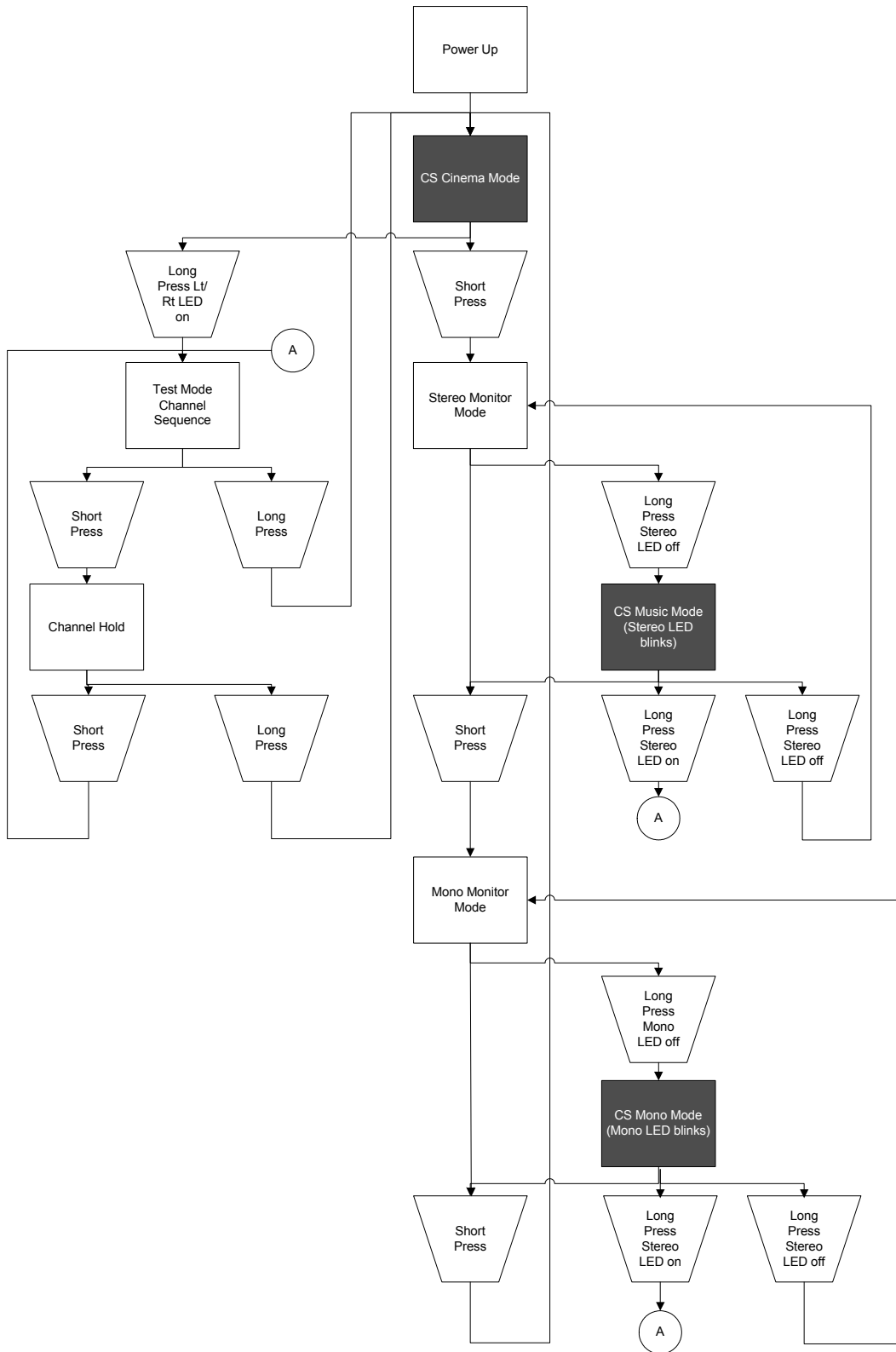

## Lt/Rt Mode Button Flow

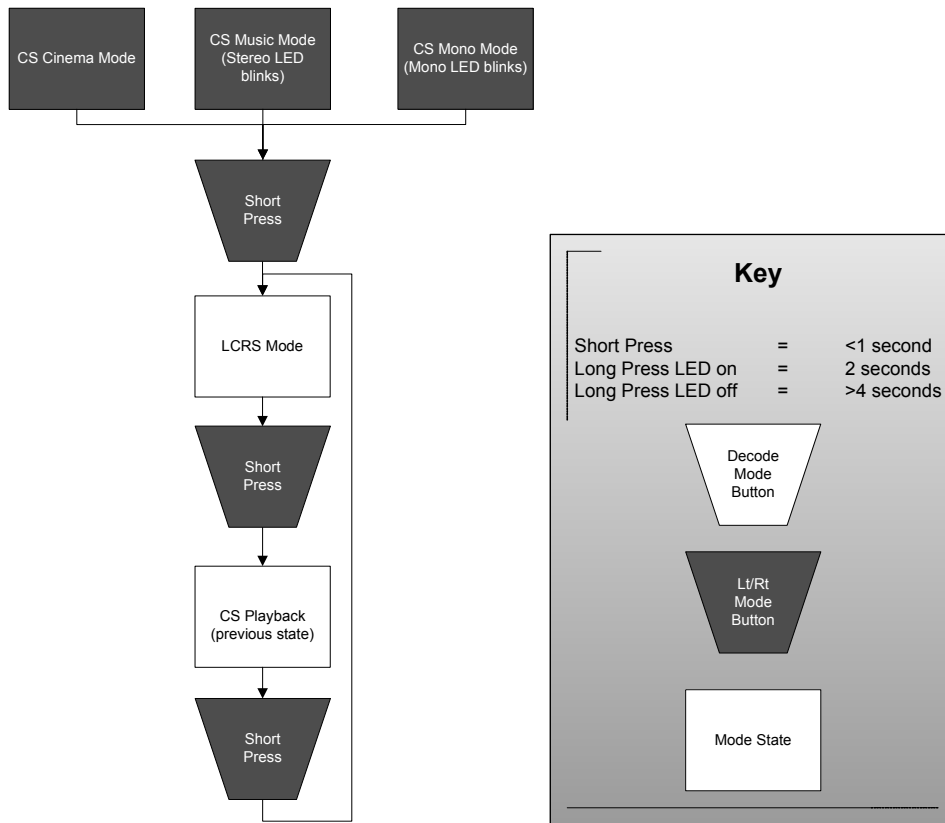

# Specifications

Frequency Response:	20 Hz – 20 kHz (L, C, R, Rs, Cs, Ls); 20 Hz to 80 Hz (LFE)
Inputs (Digital only):	1 balanced XLR (Lt/Rt); input level per AES3 standards
Input Impedance:	110 $\Omega$
Outputs:	4 balanced XLRs (L/R, C/LFE, Ls/Rs, Cs); output levels per AES3 standards
Output Impedance:	110 $\Omega$
Sample Rates:	44.1 kHz or 48 kHz (locked to input sync source sample frequency)
Decoding Latency:	<8.2 ms
Processing:	SRS – Circle Surround II Decoding algorithm with multi-band steering on ADI DSP
Front Panel Indicators/Controls:	<ul style="list-style-type: none"><li>▪ Input signal presence @ -44 dBFS (1 LED per channel); Clip indicator @ 0 dBFS</li><li>▪ Sync Source Selector – AES Pair 1/AES11 Clock &amp; status LEDs</li><li>▪ Sample Rate Indicator – 44.1kHz/48kHz status LEDs</li><li>▪ Center Mode Selector – Discrete/Phantom &amp; status LEDs</li><li>▪ Monitor mode selector – Lt/Rt (CS Cinema, CS Discrete Compare and LCRS switching using Lt/Rt selector below), Stereo (Stereo and CS Music), Mono (Mono and CS Mono) and Test (Pink noise cycled through channels @ -10 dBV) &amp; status LEDs</li><li>▪ Lt/Rt Mode Selector – LCRS / Circle Surround Cinema / Circle Surround Discrete Compare &amp; status LEDs</li><li>▪ Output signal presence @ -44 dBFS (1 LED per channel); Clip indicator @ 0 dBFS</li></ul>
Power Requirements:	Auto-switching 100-240VAC, 47-63 Hz
Power Consumption:	8 W
Dimensions:	Rack mount; 1 ru (1.75" x 19" x 12")
Weight:	5 lbs. 7 oz.
Recommended Cable:	Double Shielded (Foil/Braid) AES/EBU cable. Nominal impedance 110 $\Omega$ (Ex. Belden 1696A)

Note: 0 dBu = 0.775 Vrms

*(Specifications subject to change without notice)*





2909 Daimler Street  
Santa Ana, CA 92705  
Tel: (949) 442-1070  
Fax: (949) 442-1484

For questions regarding use and operation of the Circle Surround Decoder please call or e-mail: [prosupport@srslabs.com](mailto:prosupport@srslabs.com)

For business and pricing inquiries please call or e-mail: [prosales@srslabs.com](mailto:prosales@srslabs.com).

© 2005 SRS Labs, Inc. All Rights Reserved. No part of this publication may be reproduced, transmitted, transcribed, stored in a retrieval system, or translated into any human or computer language, in any form or by any means whatsoever, without express written consent from SRS Labs, Inc.

**SRS**, ,  and Circle Surround are registered trademarks of SRS Labs, Inc.

This product is covered under U.S. Patent Numbers 5,319,713; 5,333,201; 5,638,452; 5,771,295; 6,198,827; 6,285,767; 5,850,453 and other U.S. and International patents pending.

**SRS Labs, Inc.** hereby warrants to the original purchaser of this product that it is free of manufacturing defects in material workmanship.

- a. **Parts:** For **ONE-YEAR** from date of original purchase at retail, we will repair or replace, at our option, any defective part without charge for the part. Parts used for replacement are warranted for the remainder of the original warranty.
- b. **Labor:** For **ONE-YEAR** from the date of original purchase at retail, SRS Labs, Inc. will provide the labor for warranty repair without charge at the SRS Labs, Inc. corporate office or at any SRS Labs, Inc. authorized Service Center.

1. This warranty is void if the unit's serial number has been altered or removed. This warranty does not cover defects or damage caused by:

- a. Abuse, modification, mishandling, accident, alteration repair or service by anyone other than an authorized SRS Labs, Inc. Service Center.
- b. Physical abuse to or misuse of the unit.
- c. Operation in a manner contrary to the instructions, which accompany the unit.
- d. Freight damage, improper installation or application, the malfunction of another component or device with which the product interfaces or any damage caused by acts of God such as lightning or fluctuations in electrical power.

**2. Any express warranty not provided herein, and any other which, but for this provision, might arise by implication or operation of law, is hereby excluded and disclaimed. There are no other warranties, expressed or implied, including the implied warranty of fitness for a particular purpose. If applicable law does not permit SRS Labs, Inc. to disclaim implied warranties, any warranties implied by law are limited to the ONE-YEAR term of the express warranty given herein.**

3. The sole and exclusive remedy under this warranty is repair or replacement at SRS Labs, Inc.'s option of any product that proves to be defective in manufacture or material within **ONE-YEAR** warranty period. To the fullest extent allowed by law, SRS Labs, Inc. disclaims all liability for other direct, incidental or consequential damages alleged to be caused by a defective product; that is, SRS Labs, Inc. will not be responsible for any personal injury, property damage (other than the cost of replacing the product) or any other monetary damage such as lost wages or profits caused by any use, attempted use or inability to use the product.

4. This warranty gives you specific legal rights and you may also have other rights, which vary from State to State.

5. To obtain warranty service, contact the SRS Labs, Inc. Corporate Office at 800-2HEAR3D or at [www.SRSLABS.com](http://www.SRSLABS.com) or your nearest authorized SRS Labs, Inc. Service Center to obtain a return authorization number. All shipping charges must be prepaid. If the requested repair or service (including parts replacement) is within the terms of this warranty, SRS Labs, Inc. will pay return shipping charges only within the United States and Canada. Present your sales receipt or other document, which establishes proof and date of purchase. Returned products must be accompanied by written description of the reason for the return and the circumstances under which the defect became apparent. The return of the owner registration card is not a condition of warranty coverage.

6. **BEFORE REQUESTING SERVICE**, please review the instruction manual to insure proper installation and correct customer control adjustment. If the problem persists, contact your nearest SRS Labs, Inc. dealer for the name(s) of authorized SRS Labs, Inc. Service Center(s). If you are unable to obtain this information, please call 1-800-2HEAR3D (800-243-2733).

7. The warranty for your product can be registered online at [www.srslabs.com/warranty.asp](http://www.srslabs.com/warranty.asp)



## Free Manuals Download Website

<http://myh66.com>

<http://usermanuals.us>

<http://www.somanuals.com>

<http://www.4manuals.cc>

<http://www.manual-lib.com>

<http://www.404manual.com>

<http://www.luxmanual.com>

<http://aubethermostatmanual.com>

Golf course search by state

<http://golfingnear.com>

Email search by domain

<http://emailbydomain.com>

Auto manuals search

<http://auto.somanuals.com>

TV manuals search

<http://tv.somanuals.com>