

LCD-TV DVD Kitchen Clock Radio

Operating Instructions

Owner's Record

The model number and the serial number are located on the top.
Record the serial number in the space provided below. Refer to them
whenever you call upon your Sony dealer regarding this product.

Model No. ICF-DVD57TV

Serial No. _____

For installation and connections, refer to "Connection" on page 7.



ICF-DVD57TV

Warning

You are cautioned that any changes or modifications not expressly approved in this manual could void your authority to operate this equipment.

To prevent fire or shock hazard, do not expose the unit to rain or moisture.

To avoid electrical shock, do not open the cabinet. Refer servicing to qualified personnel only.

Do not install the appliance in a confined space, such as a bookcase or built-in cabinet.

Dots in the LCD monitor remain permanently on or off. It is not a malfunction.

CAUTION

The use of optical instruments with this product will increase eye hazard. As the laser beam used in this CD/DVD unit is harmful to eyes, do not attempt to disassemble the cabinet.

Refer servicing to qualified personnel only.

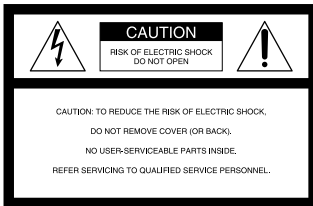

This symbol is intended to alert the user to the presence of uninsulated “dangerous voltage” within the product’s enclosure that may be of sufficient magnitude to constitute a risk of electric shock to persons.



This symbol is intended to alert the user to the presence of important operating and maintenance (servicing) instructions in the literature accompanying the appliance.

Note

This equipment has been tested and found to comply with the limits for a Class B digital device, pursuant to Part 15 of the FCC Rules. These limits are designed to provide reasonable protection against harmful interference in a residential installation. This equipment generates, uses, and can radiate radio frequency energy and, if not installed and used in accordance with the instructions, may cause harmful interference to radio communications. However,

there is no guarantee that interference will not occur in a particular installation. If this equipment does cause harmful interference to radio or television reception, which can be determined by turning the equipment off and on, the user is encouraged to try to correct the interference by one or more of the following measures:

- Reorient or relocate the receiving antenna.
- Increase the separation between the equipment and receiver.
- Connect the equipment into an outlet on a circuit different from that to which the receiver is connected.
- Consult the dealer or an experienced radio/TV technician for help.

For the remote control

This device complies with Part 15 of the FCC Rules. Operation is subject to the following two conditions: (1) This device may not cause harmful interference, and (2) this device must accept any interference received, including interference that may cause undesired operation.

Note to the CATV Installer

This reminder is provided to call the CATV system installer's attention to Article 820-40 of the NEC that provides guidelines for proper grounding and, in particular, specifies that the cable ground shall be connected to the grounding system of the building as close to the point of cable entry as practical.

CAUTION

When using TV games, computers, and similar products with your TV, keep the brightness and contrast functions at low settings. If a fixed (non-moving) pattern is left on the screen for long periods of time at a high brightness or contrast setting, the image can be permanently imprinted onto the screen. Continuously watching the same channel can cause the imprint of station logos onto the TV screen. These types of imprints are not covered by your warranty because they are the results of misuse.

For customers who purchased this product in the USA

Please register this product on line at

<http://www.sony.com/productregistration>.

Proper registration will enable us to send you periodic mailings about new products, services, and other important announcements. Registering your product will also allow us to contact you in the unlikely event that the product needs adjustment or modification.

Thank you.

Table of Contents

Features	4
Precautions	4
About this manual	5
About the discs this unit can play	5
Connection	7
Basic Connections	
(Connecting CATV or an Antenna)	7
Before Installation	8
Installing the Unit Under a Cabinet	8
Setting the Clock	9
Location of controls	10

Watching the TV

Setting the monitor	12
Setting the Channels	12
Watching the TV	13
Setting the screen mode	13
To watch CATV channels	14
To display channel number	14

Playing the Radio

Manual Tuning	15
Switching between monaural and stereo	15
Presetting Your Favorite Stations	16

Disc Play

Playing a disc	17
Searching a chapter/title/track directly	18
Resume playback	19
Playing repeatedly (Repeat Playback)	19
Displaying elapsed time	20
Using a DVD menu	21
Using the TOP MENU button	21
Using the MENU button	21
Changing angles	22
Using the PBC (playback control) function	22
Changing the audio	23
Changing the audio output	23

Changing Setup

Setting for the DVD player	
— GENERAL SETUP	25
Settings for digital audio output	
— AUDIO SETUP	26
Language settings for DVD playback	
— LANGUAGE SETUP	27
Settings for Parental Control	
— PARENTAL SETUP	28
Setting the password	
- PASSWORD	28
Selecting the Parental Control mode on and off	
- PARENTAL CONTROL	28
Preparing for the initial parental setting	
- LEVEL	29
Monitoring video signals input from a connected device	29
Changing the screen settings	30

Other Useful Functions

Selecting the audio emphasis	32
To attenuate the volume	32
Operating the Cooking Timer (Countdown Timer)	32

Additional information

Preparing the Remote Control	33
Notes on discs	33
Specifications	35
AUDIO POWER SPECIFICATIONS	35
TV section	35
DVD/CD player section	35
Radio section	35
General	35
Troubleshooting	36
Error display	37
Language Code List	38
IMPORTANT SAFEGUARDS	40

Features

- Space Saving Under the Cabinet LCD-TV
- Built-in DVD/CD Unit
- 9" Wide-Screen LCD Color Panel Display
- TV stereo/Auto SAP Function
- Easy Set, One Touch Cooking Timer
- Remote Control Supplied

Precautions

- Operate the unit on the power source specified in the "Specifications."
- To disconnect the power cord (mains lead), pull it out by the plug, not the cord.
- Do not leave the unit in a location near a heat source such as a radiator or aircdort, or in a place subject to direct sunlight, excessive dust, mechanical vibration, or shock.
- Allow adequate air circulation to prevent internal heat build-up. Do not place the unit on a surface (a rug, a blanket, etc.) or near materials (a curtain) which might block the ventilation holes.
- Should any solid object or liquid fall into the unit, unplug the unit and have it checked by a qualified personnel before operating it any further.
- To clean the casing, use a soft cloth dampened with a mild detergent solution.

Copyrights

This product incorporates copyright protection technology that is protected by method claims of certain U.S. patents, other intellectual property rights owned by Macrovision Corporation, and other rights owners. Use of this copyright protection technology must be authorized by Macrovision Corporation, and is intended for home and other limited viewing uses only unless otherwise authorized by Macrovision Corporation. Reverse engineering or disassembly is prohibited.

Manufactured under license from Dolby Laboratories. "Dolby", "Pro Logic", and the double-D symbol are trademarks of Dolby Laboratories.

"DTS," "DTS Digital Surround" and "DTS Digital Out" are trademarks of Digital Theater Systems, Inc.





If you have any questions or problems concerning your unit, please consult your nearest Sony dealer.

About this manual

Conventions

- Instructions in this manual describe how to use the unit mainly by using the controls on the supplied remote control.
- "DVD" may be used as a general term for DVD VIDEOS, DVD-Rs/DVD+Rs and DVD-RWs/DVD+RWs.
- The icons below are used in this manual:

Icon	Meaning
	The function is available for DVD VIDEOS, DVD-Rs/DVD-RWs in video mode, or for DVD-RWs in VR (Video Recording) mode, DVD+Rs/DVD+RWs in +VR (Video Recording) mode
	The function is available for Video CDs or CD-Rs/CD-RWs in video CD format
	The function is available for music CDs or CD-Rs/CD-RWs in music CD format

About the discs this unit can play

This unit can play the following discs:

- DVD VIDEO
- DVD-R/DVD+R
- DVD-RW/DVD+RW
- Video CD
- Audio CD
- CD-R/CD-RW

Disc type	Label on the disc	
DVD Videos		
		
		
	DVD+ReWritable	DVD+R
Video CD		
Audio CDs		
		

"DVD VIDEO," "DVD-R" and "DVD-RW" are trademarks.

Discs that this system cannot play

- CD-ROMs
 - CD-Rs/CD-RWs other than those recorded in the following formats:
 - music CD format
 - video CD format
 - Data part of CD-Extras
 - Super Audio CDs
 - DVD-ROMs
 - DVD-RAMs
 - DVD Audio discs
 - 8 cm(3 inches) DVD discs
 - Photo Movies created after recording in VR mode by DVD Handycam.
 - Progressive JPEG format file
 - Discs with non-standard shapes (e.g., heart, square, star) cannot be played on this unit. Attempting to do so may damage the unit. Do not use such discs.
 - A disc with paper or stickers on it
 - A disc that has the adhesive, cellophane tape, or a sticker still left on it.
- * A logical format of files and folders on a CD-ROMs, defined by ISO (International Organization for standardization).

Notes about CD-R/CD-RW/DVD-R/DVD-RW/DVD+R/DVD+RW

- In some cases, CD-Rs, CD-RWs, DVD-Rs, DVD-RWs, DVD+Rs or DVD+RWs cannot be played on this system depending upon the recording quality or physical condition of the disc, or the characteristics of the recording device. Furthermore, the disc will not play if it has not been correctly finalized. For more information, see the operating instructions for the recording device.
- A disc recorded in packet write format cannot be played.

DVD region code this unit can play.

This unit has a region code printed on the top of the unit and will only play DVDs that are labeled with identical region codes. DVDs labeled  will also be played on this unit. If you try to play any other DVD, the message "WRONG REGION" will appear on the screen. Depending on the DVD, the region code indication may not appear even if the DVD is prohibited by area restrictions.

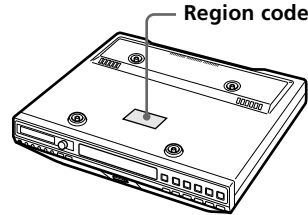

Note on DTS*-encoded DVDs/CDs

To enjoy DTS Digital Surround™ playback, an external 5.1-channel DTS Digital Surround™ decoder system must be connected to the digital output of this unit.

* "DTS," "DTS Digital Surround" and "DTS Digital Out" are trademarks of Digital Theater Systems, Inc.

Connection

Use this hookup if you subscribe to a CATV System that does not require a cable box.

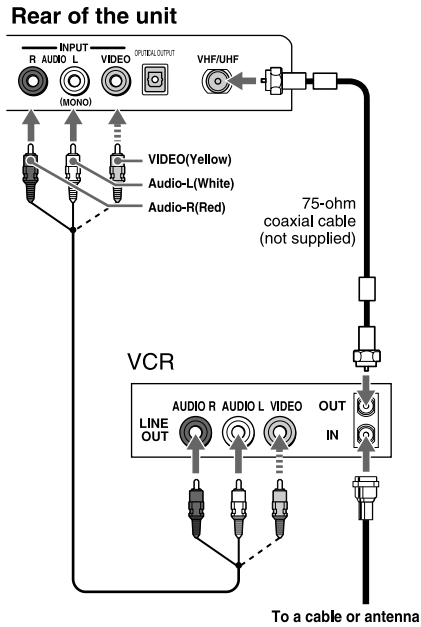

Basic Connections (Connecting CATV or an Antenna)

Connecting directly to cable or an antenna

VHF only or VHF/UHF or cable

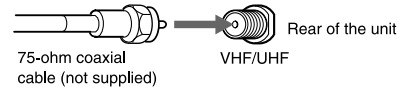

On AUDIO/VIDEO INPUT connectors

You can connect a VCR, etc. to the AUDIO/VIDEO INPUT connectors for playback on the device.

Note

When connecting another device to the unit, be sure to connect the unit to the power source after all other connections are completed.

Before Installation

The unit should be installed in an area with good reception.

Improving the Reception

FM: The AC power cord functions as an FM antenna.

Extend the AC power cord fully to improve FM reception.

AM: When installing the unit, rotate the unit horizontally for optimum reception and then install the unit. A ferrite bar antenna is built into the unit.

Installing the Unit Under a Cabinet

The unit can be installed without the spacer.

- 1** Mark the position of the 4 holes by using the supplied template. Use a drill to make the holes (diameter size-6.5 mm dia., $\frac{9}{32}$ inch).

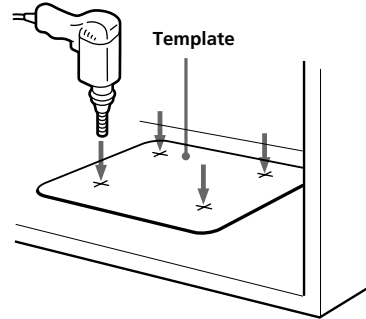

- 2** When the cabinet door overhangs the shelf and obstructs the unit, you can adjust the unit/shelf height.

First set the L mark to the dot which becomes the lowest position, then you can adjust the height in 4 steps (H•L) by turning the spacer counterclockwise.

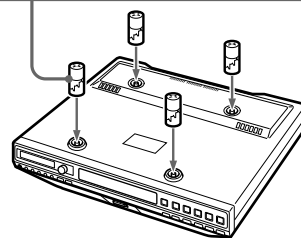
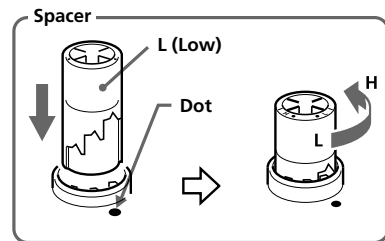

3 Install the unit with the supplied mounting screws.

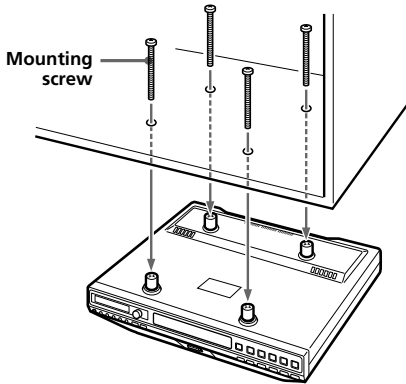

Cautions

- Since the unit is quite heavy, be careful when installing the unit.
- Hold the unit horizontally when installing it, since the disc tray may open if the unit is shaken.
- To reduce the risk of fire, do not place any heating or cooking appliance beneath this unit.
- Install the unit so that its AC power cord can be connected directly to a wall outlet. Do not use a converter or extension cord.
- Be sure that the AC power cord has no slack when using the unit, since the cord acts as an FM wire antenna. If the AC power cord has some slack, wind up the slack on the cord hook.
- The unit has a built-in ferrite bar antenna for AM radio reception. Check the condition of AM reception before fixing in position.
- Install the unit as far as possible from a source of noise (for example, refrigerator, microwave oven, fluorescent lamp, etc.).

Setting the Clock

- 1 Plug in the unit.**
“AM 12:00” will flash in the Clock Display Window.
- 2 Press CLOCK for a few seconds.**
You will hear a beep and the hour digits will start to flash in the Clock Display Window.



- 3 Press RADIO TUNE/TIME SET -, <<<(fast reverse) or +, >>>(fast forward) until the correct hour appears in the Clock Display Window.**
- 4 Press CLOCK (or ENTER) once.**
The minute digits will flash.



- 5 Press RADIO TUNE/TIME SET -, <<<(fast reverse) or +, >>>(fast forward) until the correct minute appears in the Clock Display Window.**
- 6 Press CLOCK (or ENTER) once.**
You will hear two short beeps and the seconds start counting from zero.

Tips

- To set the current time rapidly, hold down **RADIO TUNE/TIME SET -, <<<(fast reverse) or +, >>>(fast forward)**.
- To set the current time exactly to the seconds, adjust the minute function in step 6 and then press **CLOCK (or ENTER)** to synchronize it with a time signal (such as the telephone time signal).
- In the 12-hour system: “AM 12:00” = midnight.

Location of controls

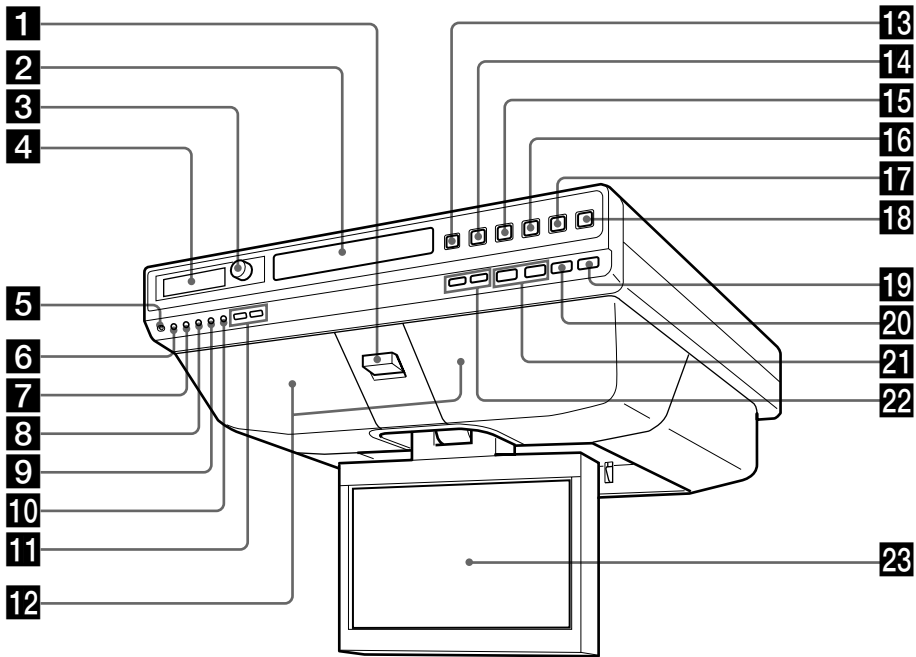

Refer to the pages listed for details.

- 1** DISPLAY RELEASE 12
- 2** Disc Tray 17
- 3** TIMER dial and TIMER indicator, PUSH START/STOP button 32
To operate the Cooking Timer.
- 4** Clock Display Window 9
- 5** Receptor for the remote control
- 6** CLOCK button 9
To set the clock.
- 7** MODE/SCREEN SIZE button 13,15
To set the screen mode, and to set the FM mode.
- 8** TV MENU button 12, 30
To change the screen settings.
- 9** ENTER button 9, 12-13, 16, 18, 21, 24-31
- 10** SOUND button 32
To set the audio emphasis.
- 11** VOLUME +/- buttons 13, 15-17
- 12** Speakers (left/right)
- 13** ▲ OPEN/CLOSE button 17
- 14** AUX button 29
To watch the AUDIO/VIDEO INPUT.

* There is a tactile dot on the VOLUME + and ►|| buttons.

- 15** TV button 12-13
To turn on the TV.
- 16** DVD button 17
To turn on the player.
- 17** RADIO ON/BAND button 15-16
To turn on the radio.
- 18** OFF button 13, 15, 17
To turn off the AUX/TV/DVD/Radio unit.
- 19** ■ (Stop) button 18-19
- 20** ►|| (Play/Pause) button 17-19
- 21** TV CH/PRESET -, ◀◀ (Previous)/ +, ▶▶ (Next) button 13, 16, 18, 22
To select a TV channel, to tune in a preset station, to select the item during TV MENU operation, or to adjust the screen settings.
- 22** RADIO TUNE/TIME SET -, ◀◀ (Fast reverse)/+, ▶▶ (Fast forward) button 9, 15, 18
To tune in a desired radio station or to set the clock.
This can also be used in slow playback mode.
- 23** Monitor 12

Remote control

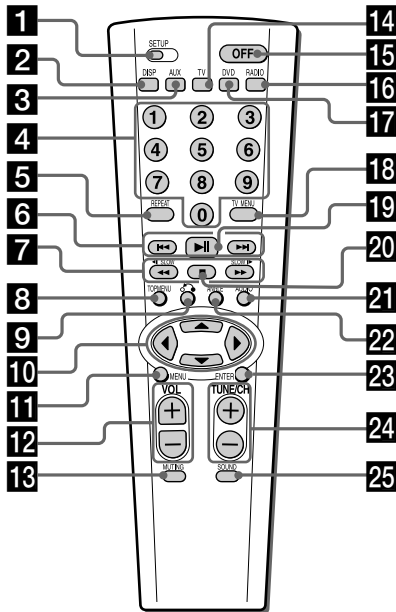

The corresponding buttons of the remote control function the same as those on the unit.

Instructions in this manual describe how to use the unit by mainly using the remote control.

Tip

Refer to "Preparing the Remote Control" (page 33).

Refer to the pages listed for details.

- | | |
|--|---|
| <p>1 SETUP button 24-29
Used to perform menu operations.</p> <p>2 DISP (Display) button 20
To display the channel number or the time information of the disc.</p> <p>3 AUX button 29
To watch the AUDIO/VIDEO INPUT.</p> <p>4 Number buttons 13, 18, 22, 28</p> <p>5 REPEAT button 17-19
To select the repeat mode (DVD/Video CD/Audio CD).</p> <p>6 ◀◀(Previous)/▶▶(Next) buttons 16, 18, 22</p> <p>7 ◀SLOW/◀◀(Fast reverse)/▶▶SLOW/▶▶ (Fast forward) buttons 9, 15, 18
This can also be used in slow playback mode.</p> <p>8 TOP MENU button 21-22
To display the top menu of a recorded DVD, or to set the PBC (playback control) function on or off for the Video CD.</p> <p>9 ↶ (Return) button 22</p> <p>10 ▲/▼/◀/▶ buttons 17-18, 21, 24-30</p> <p>11 MENU button 21
To display the recorded DVD menu.</p> <p>12 VOL (Volume) +/- buttons 13, 15-17</p> <p>13 MUTING button 32
To attenuate the volume.</p> | <p>14 TV button 12-13
To turn on the TV.</p> <p>15 OFF button 13, 15, 17
To turn off the AUX/TV/DVD/Radio unit.</p> <p>16 RADIO/BAND button 15-16
To turn on the radio.</p> <p>17 DVD button 17
To turn on the unit.</p> <p>18 TV MENU button 12, 30
To change the screen settings.</p> <p>19 ▶II (Play/Pause) button 17-19</p> <p>20 ■ (Stop) button 18-19</p> <p>21 AUDIO button 23
To change the audio output/audio language.</p> <p>22 ANGLE button 22
To select the multiple angles of view while playing a DVD.</p> <p>23 ENTER button 9, 12-13, 16, 18, 21, 24-31
To enter a setting.</p> <p>24 TUNE/CH +/- buttons 13, 15, 30
To select the desired TV channel, to tune in to the desired station, to select the item during TV MENU operation or to adjust the screen settings.</p> <p>25 SOUND button 32
To set the audio emphasis.</p> |
|--|---|

* There is a tactile dot on the "5", "▶II" and "TUNE/CH+" buttons of the remote control.

Watching the TV

Setting the monitor

Opening the monitor

- 1 Press **DISPLAY RELEASE** to open the monitor.

The monitor is released as illustrated.

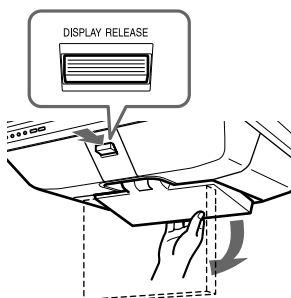

- 2 Turn the monitor and adjust the angle to avoid the reflection of light or get a better view of the TV.

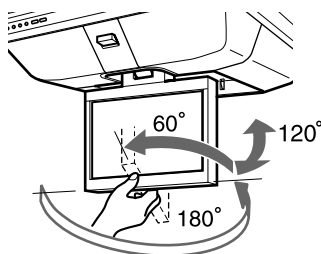

Closing the monitor to its enclosure

Close the monitor until it clicks.

Tip
The monitor can be closed with the screen facing either inside or outside.

Notes

- Be careful not to catch your finger in the monitor when closing.
- Do not put any foreign objects between the LCD panel and the unit when closing.

Setting the Channels

After you finish connecting the unit, you can run Auto Program to set up your channels. The Initial Setup screen appears when you turn your TV on for the first time.

Using Initial Setup

To run Initial Setup the first time you turn on your TV.

- 1 Press **TV** to turn on the TV.
The Initial Setup screen appears.
- 2 Press **TV CH/PRESET +**, **▶▶I(Next)** [**TUNE/CH +**] button to perform Auto Program, or press **TV CH/PRESET -**, **◀◀I(Previous)** [**TUNE/CH -**] to exit.
If you select Auto Program, "CABLE" or "ANTENNA" appears on the display for you to choose.
- 3 Press **TV CH/PRESET -**, **◀◀I(Previous)** or **▶▶I(Next)** [**TUNE/CH -** or **+**] button to select "CABLE" or "ANTENNA".

To perform Auto Program again

- 1 Press **TV MENU**.
- 2 Press **TV CH/PRESET -**, **◀◀I(Previous)** or **▶▶I(Next)** [**TUNE/CH -** or **+**] to select "AUTO PROGRAM", then press **ENTER**.
- 3 Press **TV CH/PRESET -**, **◀◀I(Previous)** or **▶▶I(Next)** [**TUNE/CH -** or **+**] button to select "YES", then press **ENTER**.
Auto Program automatically creates a list of receivable channels. When finished, the lowest numbered channel is displayed.

Watching the TV

- 1 Press **TV**.
- 2 Select the desired channel using **TV CH/PRESET -**, **◀◀** (Previous) or **+**, **▶▶** (Next) [**TUNE/CH -** or **+**].
When the remote control is used, press **0-9** to select a channel, the channel changes after 2 seconds. Press **ENTER** to select immediately.

Tip
When you press and hold **TV CH/PRESET -**, **◀◀** (Previous) or **+**, **▶▶** (Next) [**TUNE/CH -** or **+**], the channel number will change rapidly.

- 3 Adjust the volume using **VOLUME [VOL] +** or **-**.

To turn off the TV

Press **OFF**.

Setting the screen mode

In addition to the **FULL**, **ZOOM**, **WIDE**, and **STANDARD** modes are also available.

Press **MODE/SCREEN SIZE** repeatedly. The current mode is displayed on the screen first. Each time the button is pressed, the screen mode switches in the following sequence:

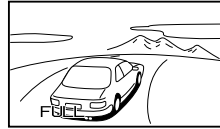

FULL

To show an image with an aspect ratio of 16 : 9.



ZOOM

To show an image with an aspect ratio of 4 : 3 enlarged to the left and right edges of the screen, with the overflowing parts (top and bottom) cut off to fill the screen.



WIDE

To show an image with an aspect ratio of 4 : 3 enlarged to the left and right edges of the screen.



STANDARD

To show an image with an aspect ratio of 4 : 3 (regular image).

Tip
Images may appear grainy when viewed in the zoom mode.

To watch CATV channels

You have to subscribe to a CATV company. Note that CATV cannot be received in some areas. This TV receives 1-125 cable TV channels. For details on CATV subscription, consult your nearest CATV company.

Note

You cannot receive or set the CATV channels and UHF channels at the same time.

To display the channel number

Press **DISP (Display)** on the remote control. The current channel number appears in the display. Press **DISP (Display)** once to turn display off.

Playing the Radio

Manual Tuning

- 1 Press **RADIO ON/BAND [RADIO/BAND]** to turn on the radio.

“RADIO” appears in the Clock Display Window. The display shows the band and frequency for a few seconds and then changes back to the current time.

- 2 Press **RADIO ON/BAND [RADIO/BAND]** repeatedly to select the desired band. Each press changes the band as follows:

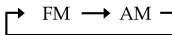

- 3 Press **RADIO TUNE/TIME SET -**, **◀◀(Fast reverse)** or **+**, **▶▶(Fast forward)** [**TUNE/CH - or +**] to tune in to the desired station.

Two short beeps sound when the minimum frequency of each band is received during tuning.

- 4 Adjust the volume using **VOLUME [VOL]** **+** or **-**.

To check the station being received
Press **RADIO ON/BAND [RADIO/BAND]** lightly. The Clock Display Window shows the band and frequency for a few seconds and then changes back to the current time.

To turn off the Radio

Press **OFF**.

Switching between monaural and stereo

The radio is set for stereo reception at the default setting. If FM stereo reception is poor, set to “FM MONO (monaural).” Noise will be reduced although the sound will not be heard in stereo.

- 1 Press **RADIO ON/BAND [RADIO/BAND]** to turn on the radio.

- 2 Press **RADIO ON/BAND [RADIO/BAND]** repeatedly to select FM.

- 3 Press **MODE/SCREEN SIZE**. “Mono(monaural)” or “ST(Stereo)” appears in the Clock Display Window. Each time you press **MODE/SCREEN SIZE**, the mode changes to either “Mono” or “ST.”

- 4 Select Mono or ST.

The mode you select appears in the Clock Display Window for a few seconds and returns to the current time.

Presetting Your Favorite Stations

Preset Tuning

You can preset up to 10 stations for AM, and 20 stations for FM.

Presetting a Station

- 1 Follow steps 1 to 4 in "Manual Tuning" and manually tune in a station you wish to preset.
- 2 Hold down ENTER until the preset number flashes.



- 3 Press TV CH/PRESET -, ◀◀◀(Previous) or +, ▶▶▶(Next) [◀◀◀(Previous)/▶▶▶(Next)] to select the number you wish to preset, then press ENTER. When you press ENTER, the selected preset number lights up in the Clock Display Window.

Example: Clock Display Window shows as below when you preset FM 90.0 MHz in preset number 2.



To preset another station, repeat these steps.

To change the preset station, preset a new station. The previous station will be canceled.

Tuning in a Preset Station

- 1 Press RADIO ON/BAND [RADIO/BAND] to turn on the radio.
- 2 Press RADIO ON/BAND [RADIO/BAND] to select the band.
- 3 Press TV CH/PRESET -, ◀◀◀(Previous) or +, ▶▶▶(Next) [◀◀◀(Previous)/▶▶▶(Next)] to tune in the desired preset station.
- 4 Adjust the volume using VOLUME [VOL] + or -.

Disc Play

This chapter describes various functions for playback.

Playing a disc **DVD VCD**

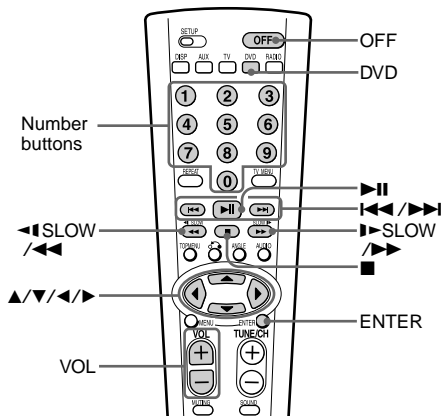

1 Open and turn the monitor and adjust the tilt and swivel.

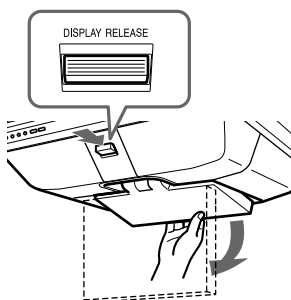

2 Press DVD to turn on the player.

3 Press **▲ OPEN/CLOSE** to open the disc tray, and place a disc on the disc tray.

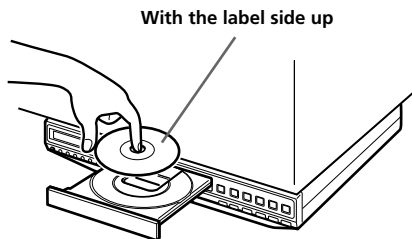

4 Press **▲ OPEN/CLOSE** to close the disc tray.

- DVD/Video CD
Playback starts automatically.
If playback does not start automatically, press **▶|| (Play/Pause)** to start playback.
- CD
The total play time appears. Press **▶|| (Play/Pause)** to start playback.

5 Press **VOLUME [VOL] + or -** to adjust the volume.

To turn off the power

Press **OFF**.

Notes

- Read the operating instructions supplied with the disc to play with this unit.
- Depending on the recording method used on the disc, it may take a minute or more before playing.
- Depending on the condition of the disc, it may not play back (page 33).
- "DVD" also appears in the Clock Display Window, if you inserted the disc (DVD/VCD/CD).

Operation for playback

To	Do this
Stop playback	Press ■*1.
Eject the disc	Press ▲ OPEN/ CLOSE on the unit after the disc stops.
Pause	Press ► *2. Press again to resume playback.
Go to the next chapter, or track	Press ►►.
Go back to the preceding chapter, or track	Press ◀◀.
Fast forward/ fast reverse	Press ◀◀/►► while playing*3. Each press changes the playback speed as follows: 2 times normal speed → 4 times normal speed → 8 times normal speed → 16 times normal speed → 32 times normal speed → normal playback speed.
Slow forward (DVD/Video CD only)/ Slow reverse (DVD only)	Press ◀◀/►► during pause. Playback speed will be as follows: 1/2 normal speed → 1/4 normal speed → 1/8 normal speed → 1/16 normal speed → normal playback speed.

*1 If the resume playback function is activated, you can resume playback later by pressing ►||. For details, see "Resume playback" (page 19).

*2 "||" is displayed on the screen.

*3 DVD/Video CD

No sound is output during fast forward or fast reverse.

Searching a chapter/title/track directly

Use the remote control.

To select the desired chapter/track number

Press the number buttons to enter the desired chapter/track number. The chapter/track changes after 2 seconds. Press **ENTER** to select immediately.

To select the desired title

After pressing one of the number buttons, press ◀ within 2 seconds and input the title number desired. The title changes after 2 seconds. Press **ENTER** to select immediately.

Note

On some discs, the title cannot be selected directly by entering the desired title number.

Resume playback

You can resume playback from the point where the playback has been stopped. The unit memorizes the point even after the power is turned off.

1 During playback, press ■ (Stop) to stop.

The unit memorizes the point where playback is stopped.

"PRESS ► TO CONTINUE" appears on the screen.

2 Press ► (Play/Pause) to start playback.

Playback starts from the point where playback has been stopped.

Notes

- To deactivate the resume function, press ■ (Stop) again while playback is stopped. "PRESS ► TO CONTINUE" disappears on the screen at this time.
- The resume function will be deactivated when the disc is ejected.

Playing repeatedly (Repeat Playback)



You can play all of the chapters or titles on a disc or a single track repeatedly.

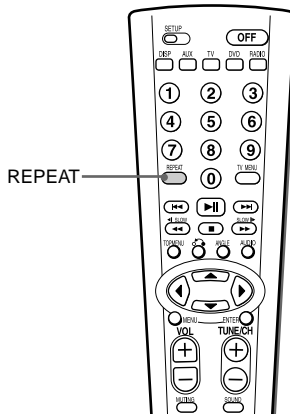

Press **REPEAT** during playback.

Each time you press the button, repeat playback mode changes as follows:

• DVD

- ○ **CHAPTER:** repeats the current chapter.
- ↓
- **TITLE:** repeats the current title on a disc.
- ↓
- **DISC:** repeats all titles and chapters on the disc.

• Video CD (only when PBC is off)/Audio CD

- ○ **TRACK:** repeats the track currently being played.
- ↓
- **DISC:** repeats all tracks on the disc.

To return to normal playback

Press **REPEAT** repeatedly until the repeat icon disappears.

Displaying elapsed time



You can display the elapsed time and the remaining time of DVDs, Video CDs and Audio CDs.

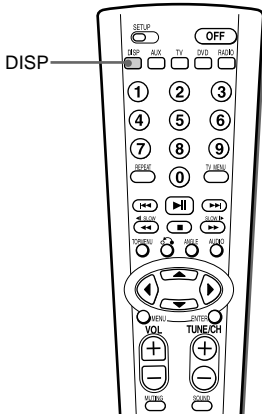

During playback, press **DISP (Display)**. The elapsed time or the remaining time is displayed at the upper left. Each time you press **DISP (Display)**, the display changes as follows:

• DVD

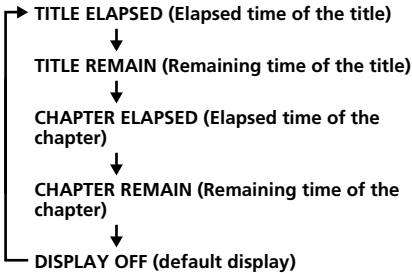

• Video CD (when PBC is on)

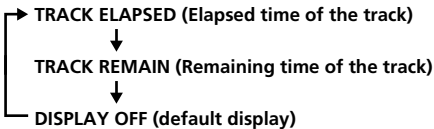

• Video CD (when PBC is off)

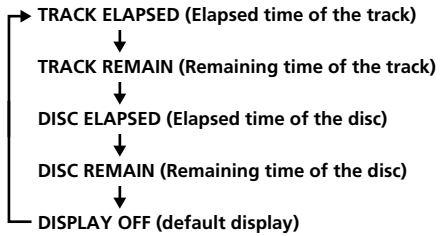

• Audio CD

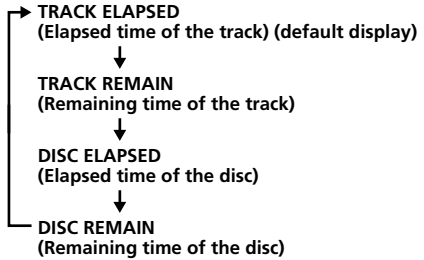

To turn off the time information (DVD/Video CD)

Press **DISP (Display)** repeatedly to select "DISPLAY OFF."

Using a DVD menu

With some DVDs you can use the original menu such as Title menu and DVD menu. In title menu, you can play your favorite scene or song by selecting titles of songs and scenes. You can select an item, subtitle language, audio language etc. by selecting a DVD menu. The contents of title menus and DVD menus differ depending on the DVD. There may be some DVDs which have no recorded menus.

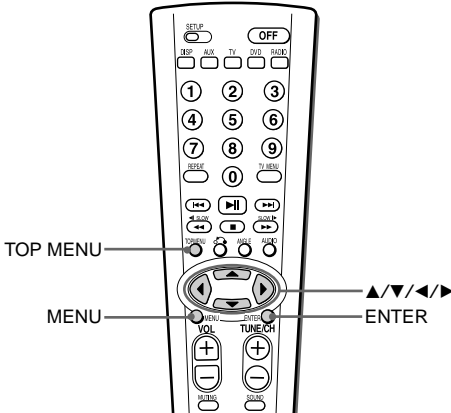

Using the MENU button

Some DVDs have a more comprehensive menu that includes things such as the audio languages, subtitle languages, titles, and chapters, etc.

- 1 During a DVD playback, press MENU.**
The DVD menu is displayed.
- 2 Press ▲/▶/▼/◀ to select the desired item.**
- 3 Press ENTER.**
If additional selection screens appear, repeat steps 2 and 3.

Notes

- Some DVDs do not have a DVD menu and on some DVDs, the contents of the DVD menu and title menu are the same.
- On some DVDs, "DVD Menu" may be expressed as "MENU."
- On some DVDs, "Press ENTER" may be expressed as "Press SELECT" in step 3.
- The contents of the DVD menu differ, depending on the DVDs.
- Read the instruction manual supplied with a DVD.

Using the TOP MENU button

Some DVDs have a title menu. From the title menu you can select a title for playback. Titles are the longest sections of a picture or music feature on a DVD, e.g., a movie, or an album for audio software, etc. The **TOP MENU** button is available to display the initial menu screen.

- 1 During DVD playback, press TOP MENU.**
The title menu* (top menu) is displayed.
** The contents of the title menu differ, depending on the DVD.*

2 Press ▲/▶/▼/◀ to select the desired title.

3 Press ENTER.
The title you selected starts to play.

Changing angles



Some DVDs have multiple alternative angles recorded for certain scenes. If you have set "ANGLE MARK" to "ON" (page 25), a notice appears at the scene.

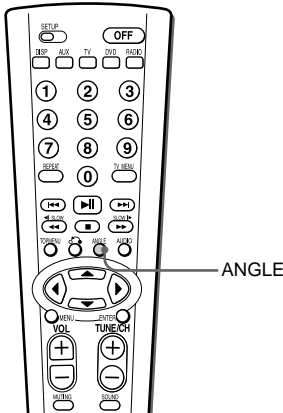

- 1** During playback of a DVD having multiple alternative angles recorded, press **ANGLE** when a notice appears. The number of the currently selected angle is displayed at the upper right.
- 2** Press **ANGLE** repeatedly to select your favorite angle number, while the angle number is displayed. Each time you press **ANGLE**, the angle number switches.

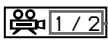
 The angle number you have currently selected/the total number of multiple alternative angles

Notes

- You can switch the angle only if multiple angles are recorded on the DVD.
- The total number of recorded angles differs depending on the DVDs and scenes.
- You can switch the angle only during normal playback. You cannot switch the angle during fast forward/reverse playback.
- When the selected scene with multiple angles appears, the angle is automatically switched to the angle number you selected in step 2.
- This function varies or may not work, depending on the DVDs.

Using the PBC (playback control) function

During playback of a PBC compatible Video CD, you can display the PBC menu to select the item from the menu.

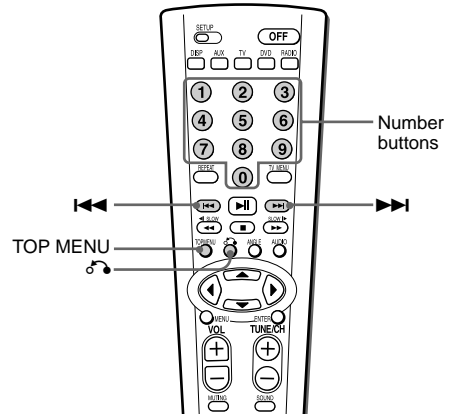

- 1** Start playback of a video CD with PBC functions. The menu for your selection appears.
- 2** Press the number buttons to select the number of the desired item.
- 3** Follow the instructions in the menu for interactive operations. Refer to the instructions supplied with the disc, as the operating procedure may differ depending on the Video CDs.



To return to the menu

Press  (Return).

Tip

To play without using PBC, press **TOP MENU**. "PBC OFF" appears on the TV screen and the unit starts continuous play. To return to PBC playback, press **TOP MENU** again.

Notes

- During playback of a Video CD with "PBC ON," press  (Previous)/ (Next) to change the item. The PBC menu is not displayed but the item you selected starts to play.
- During playback of a Video CD with "PBC ON," press  (Return) to display the PBC menu.

Changing the audio

Some DVDs have multiple audio languages you can choose from.

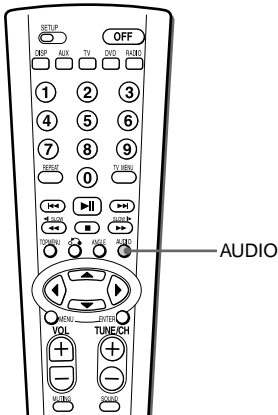

During playback, press **AUDIO** repeatedly to select the desired audio language.

The current audio language is displayed.

Example: an audio language display

AUDIO 1 / 2 : Dolby D 2 CH ENGLISH

The format of the sound source (Dolby D, DTS, or LPCM) may appear.

When the display for the language code appears, input the language code corresponding to the desired language (page 38).

Notes

- This unit displays the following languages: ENGLISH, CHINESE, JAPANESE, GERMAN, FRENCH, ITALIAN, SPANISH, PORTUGUESE, DUTCH, DANISH, SWEDISH, FINNISH, NORWEGIAN, and RUSSIAN. If another language is used, "OTHERS" is displayed.
- You can switch the audio language only if multiple audio languages are recorded on the DVD.
- You can also change the audio languages by using the DVD menu (page 21) or the LANGUAGE SETUP menu* (page 27).
 - * You can change to a specific audio language using the LANGUAGE SETUP menu, only if the language is included in both the disc and the menu. In some discs, the initial language to be output is specified regardless of the LANGUAGE SETUP menu setting.
- This function varies or may not work, depending on the DVDs.

Changing the audio output

You can select the desired audio output from "STEREO", "MONO LEFT", "MONO RIGHT" or "MIX-MONO" during Video CD or Audio CD playback.

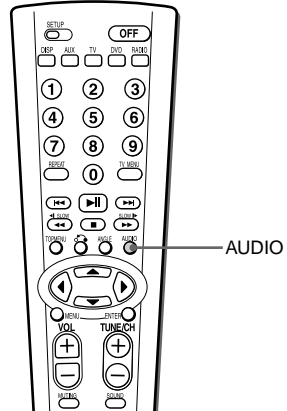

During playback, press **AUDIO** to select the desired output from "STEREO", "MONO LEFT", "MONO RIGHT" or "MIX-MONO" while the output is displayed.

Each time you press **AUDIO**, the output switches.

Example: an audio output display

MONO RIGHT

Changing Setup

You can set up and adjust this player using the on-screen Setup Menus. Most settings need to be set when you first use this player.

Setup Menus are:

- General Setup (system settings)
- Audio Setup (settings for digital audio output)
- Language Setup (language settings)
- Parental Setup (setting for parental control)

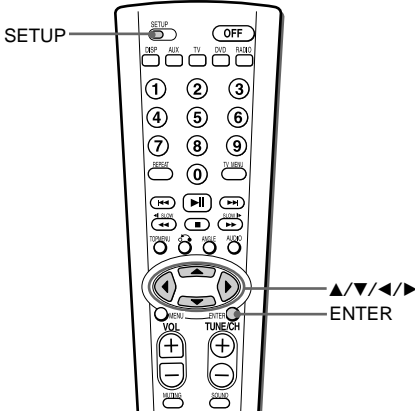

Refer to "Changing the screen setting" (page 30) for settings of the monitor.

1 Press SETUP.

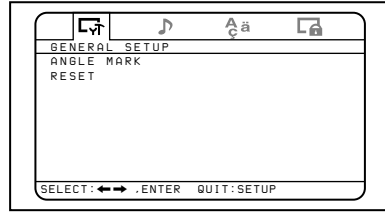

2 Press ◀ or ▶ button to select the desired item.

- ◻: General Setup
- ♪: Audio Setup
- A ä: Language Setup
- ◻: Parental Setup

3 Press ENTER.

4 Press ▲ or ▼ button to select the desired setting.

5 Press ENTER.

6 Press ▲ or ▼ or ◀ or ▶ to select (adjust) the setting option.

7 Press ENTER.

8 Press SETUP.

Setting for the DVD player

— GENERAL SETUP

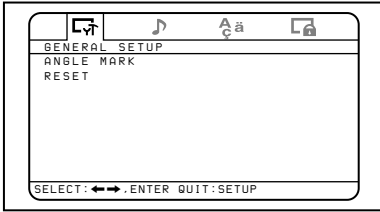

◆ ANGLE MARK

If various angles (multi-angles) for a scene are recorded on the DVD and you have set the “ANGLE MARK” to “ON”, a notice appears at the scene.

This setting is available while the playback is stopped and the resume function is canceled.

ON A notice will appear at the scene.

OFF A notice will not appear at the scene.

◆ RESET

You can reset Setup Menus to the factory setting.

- 1** Press **SETUP**, then press **◀** or **▶** button repeatedly until “GENERAL SETUP” appears on the screen.
- 2** Press **ENTER**.
- 3** Press **▲** or **▼** button repeatedly to select “RESET” and press **ENTER**.
- 4** Press **ENTER** again.

Settings for digital audio output — AUDIO SETUP

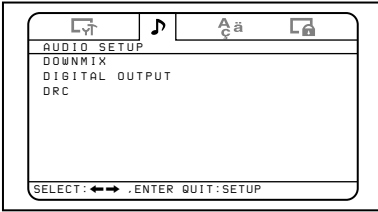

◆ DOWNMIX

You can select the downmix mode from “Surround” or “Normal”. The downmix function is used to create stereo (2-channel) signals from more than 5 separated digital signals of a source. This setting affects the outputs of OPTICAL OUTPUT.

SURROUND Normally, select this position. Multi-channel audio signals are output to 2 channels for enjoying surround sounds.

NORMAL Multi-channel audio signals are downmixed to 2 channels for use with your stereo.

◆ DIGITAL OUTPUT

You can set the mode of the audio signals output from the OPTICAL OUTPUT connector.

RAW Select this when you connect an audio component with a built in Dolby Digital decoder or DTS decoder.

PCM Select this when you connect an audio component without a built-in Dolby Digital decoder or DTS decoder. The downmix signal is output.

OFF No signal is output from OPTICAL OUTPUT connector.

Notes

- When “OFF” is selected, no signal is output from the OPTICAL OUTPUT connector.
- When you connect the player and a digital recording device such as an MD player through an optical cable to record the CD contents with that device, the contents will be recorded as one continuous track.
- If noise occurs in peripheral equipment when using DIGITAL OUTPUT, select “OFF” to turn off DIGITAL OUTPUT.
- Sampling sound of 96kHz is changed to 48kHz.
- If the sound setting is changed to DTS by the AUDIO button or Disc menu, no sound is emitted from the speaker.
- When you connect to another unit which does not support the DTS function and change the sound setting to DTS, noise may occur. In this case, change the audio setting to other than DTS.
- While the playing back a CD, whether the DIGITAL OUTPUT is set to RAW or PCM, there is no difference in the audio effect.

◆ DRC (Dynamic Range Control)

Makes the sound clear when the volume is turned down when playing a DVD that conforms to “Audio DRC”. You can set the DRC level from 9 steps (including “OFF”). This setting affects the outputs of OPTICAL OUTPUT.

MAX: Makes the low sounds clear even if you turn the volume down.

OFF: Set to enjoy the dynamic sound.

Language settings for DVD playback

— LANGUAGE SETUP

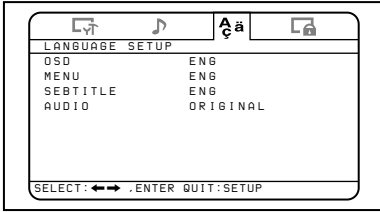

The following settings are available while playback is stopped and the resume function is canceled.

◆ OSD

Switches the language used for the menus on the screen. (Default: ENGLISH)

◆ MENU

You can select the desired language for the disc's menu. (Default: ENGLISH)

Note

Regardless of your setting, the language other than you set may be automatically activated, depending on the DVD.

◆ SUBTITLE

Switches the language for the subtitle recorded on the DVD VIDEO. (Default: ENGLISH)

Note

Regardless of setting to the desired language, other language may be automatically activated, depending on the DVD.

◆ AUDIO

Switches the language of the sound track. When you select "ORIGINAL", the language given priority on the disc is selected. (Default: ORIGINAL)

Notes

- *Regardless of your setting, the language other than you set may be automatically activated, depending on the DVDs.*
- *Some DVDs are prohibited to change the audio language output, even if multiple languages are recorded.*

Settings for Parental Control — PARENTAL SETUP

When you set the password for the first time, be sure to set the parental control together.

Setting the password – PASSWORD

- 1 Press **SETUP**, then press **◀** or **▶** button repeatedly until “PARENTAL SETUP” appears on the screen.

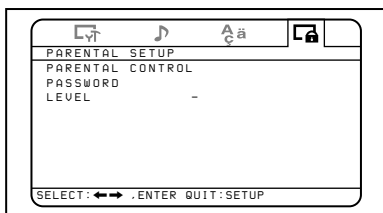

- 2 Press **ENTER**.
- 3 Press **▲** or **▼** button repeatedly to select “PASSWORD”, then press **ENTER**.
- 4 Press **ENTER** again.
- 5 Press the number buttons to enter “5370”.

The player is ready to accept a new password.



- 6 Press the number buttons to enter a new password.
- 7 Press the number buttons to enter the password again to confirm.
- 8 Press **ENTER**.
- 9 Press **SETUP** to exit the Setup Menu.

Notes

- If you forget your registered password, enter “5370”.
- If you enter the wrong password in OLD PASSWORD, you cannot enter a new one in NEW PASSWORD.

Selecting the Parental Control mode on and off – PARENTAL CONTROL

When the PARENTAL CONTROL mode is set to ON, the password is required to change the playback limitation level.

- 1 Press **SETUP**.
- 2 Press **◀** or **▶** button repeatedly until “PARENTAL SETUP” appears on the screen.
- 3 Press **ENTER**.
- 4 Press **▲** or **▼** button repeatedly to select “PARENTAL CONTROL”, then press **ENTER**.
- 5 Press **▲** or **▼** button repeatedly to select “ON” or “OFF”, then press **ENTER**.
- 6 Enter the password, and press **ENTER**.
- 7 Press **SETUP** to exit the Setup Menu.

The factory setting is “OFF.”

Preparing for the initial parental setting - LEVEL

Playback of some DVDs can be limited according to a predetermined level, such as the age of the viewer. The Parental control function allows you to set a playback limitation level.

This setting is available while playback is stopped and the resume function is canceled.

- 1 Press **SETUP**, then press **◀** or **▶** button repeatedly until "PARENTAL SETUP" appears on the screen.
- 2 Press **ENTER**.
- 3 Press **▲** or **▼** button repeatedly to select "Level", then press **ENTER**.
- 4 Press **▲** or **▼** button repeatedly to select the limitation level, then press **ENTER**.
- 5 Enter the password and press **ENTER**. (Only when the PARENTAL CONTROL is set to ON.)
- 6 Press **SETUP** to exit the Setup Menu.

Refer to the following table. Parental levels of the table are on the MPAA (Motion Picture Association of America) rating system. If you set this player to level "4" for example, DVDs with levels "5", "6", "7", and "8" cannot be played.

This Player	MPAA Rating System
"1"	"G": General audience
"2"	-
"3"	"PG": Parental guidance suggested
"4"	"PG13": Parents strongly cautioned
"5"	-
"6"	"R": Restricted
"7"	"NC17": No one 17 and under admitted
"8"	No restriction

The factory setting is "8."

Monitoring video signals input from a connected device

Switch the input channel to monitor video signals input from the device connected to the VIDEO INPUT connector of the player.

- 1 Press **AUX**.
- 2 Adjust the volume using **VOLUME [VOL]** + or - .

Changing the screen settings

You can adjust the screen settings manually if the screen is hard to see from your position.

1 Press TV MENU.

The "PICTURE" screen appears. Each time you press TV CH/PRESET -, I◀◀(Previous) or +, ▶▶I(Next) [TUNE/CH - or +], the setting screen changes in the following sequence:

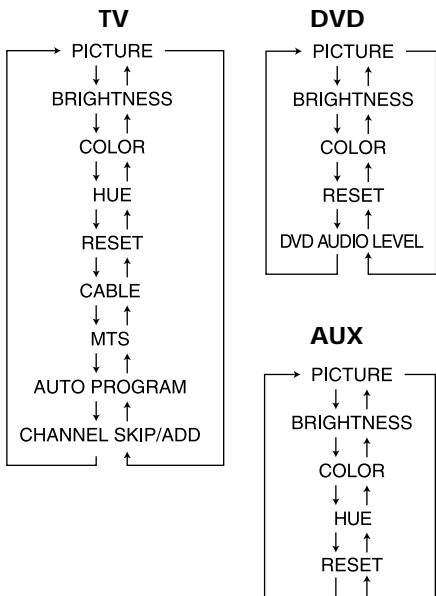

2 Press ENTER to adjust to the desired setting.

PICTURE: Press TV CH/PRESET +, ▶▶I(Next) [TUNE/CH +] to increase the contrast. Press TV CH/PRESET -, I◀◀(Previous) [TUNE/CH -] to decrease contrast. Press ENTER to enter the setting. (Default value: 32)

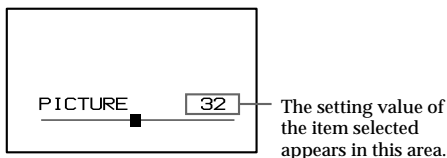

BRIGHTNESS:

Press TV CH/PRESET +, ▶▶I(Next) [TUNE/CH +] to brighten the picture. Press TV CH/PRESET -, I◀◀(Previous) [TUNE/CH -] to darken the picture. Press ENTER to enter the setting. (Default value: 30)

COLOR:

Press TV CH/PRESET +, ▶▶I(Next) [TUNE/CH +] to increase color saturation. Press TV CH/PRESET -, I◀◀(Previous) [TUNE/CH -] to decrease color saturation. Press ENTER to enter the setting. (Default value: 32)

HUE:

Press TV CH/PRESET +, ▶▶I(Next) [TUNE/CH +] to increase red tones. Press TV CH/PRESET -, I◀◀(Previous) [TUNE/CH -] to decrease the green tones. Press ENTER to enter the setting.

RESET: You can reset the PICTURE, BRIGHTNESS, COLOR and HUE settings to the factory setting. Press TV CH/PRESET -, I◀◀(Previous) or +, ▶▶I(Next) [TUNE/CH - or +] to select "YES."

Press ENTER to enter the setting.

CABLE: Press TV CH/PRESET -, I◀◀(Previous) or +, ▶▶I(Next) [TUNE/CH - or +] to select one of the following options.

ON : Select if you are receiving cable channels with a CATV cable.

OFF : Select if you are using a TV antenna. Press ENTER to enter the setting.

MTS: Press TV CH/PRESET -, I◀◀(Previous) or +, ▶▶I(Next) [TUNE/CH - or +] to select one of the following options.

STEREO : Select when viewing a broadcast in stereo.

MONO : Select to reduce noise in areas of poor reception.

AUTO SAP : Select to have the TV automatically switch to a second audio program(SAP) when a signal is received. Press ENTER to enter the setting.

AUTO PROGRAM:

Press TV CH/PRESET -, I◀◀(Previous) or +, ▶▶I(Next) [TUNE/CH - or +] to select "YES," then press ENTER. The TV will scan through all available channels and program receivable channels.

CHANNEL SKIP/ADD:

Select whether a channel is skipped or displayed when TV CH/PRESET -, I◀◀(Previous) or +, ▶▶I(Next) [TUNE/CH - or +] is pressed.

Select CHANNEL by TV CH/PRESET -, I◀◀(Previous) or +, ▶▶I(Next) [TUNE/CH - or +] and then press ENTER.

When you want to skip the channel, press TV CH/PRESET -, I◀◀(Previous) or +, ▶▶I(Next) [TUNE/CH - or +], display SKIP and then press ENTER.

When you want to display the channel, select ADD in the procedure mentioned above.

DVD AUDIO LEVEL:

Press **TV CH/PRESET -**, **◀◀** (Previous) or **+**, **▶▶** (Next) [**TUNE/CH -** or **+**] to select one of the following options.
HIGH : Select when the sound of playing the DVD is small.
NORMAL : Select when the sound of playing the DVD is normal.
Press **ENTER** to enter the setting.

To exit the screen setting mode

Press **TV MENU**.

Other Useful Functions

Selecting the audio emphasis

Press **SOUND** repeatedly to select the desired sound mode.
Each press changes the sound mode as follows:

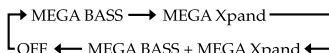

To obtain vast sound

The “MEGA Xpand” system produces a extensive sound.

To obtain powerful bass sound

The “MEGA BASS” system produces a powerful bass sound.

Note

“MEGA Xpand” is not effective in monaural.

To attenuate the volume

Press **MUTING** on the remote control.
While attenuating, “VOL 0” flashes on the Clock Display Window. To return to the previous volume level, press **MUTING** again.

Operating the Cooking Timer (Countdown Timer)

The timer can be set at one minute intervals between 1–120.

- 1 Turn TIMER until the desired time appears in the Clock Display Window.**
“TIMER” will appear in the Clock Display Window when TIMER is turned. After setting the time, the current time is displayed again if you do not perform any operation for more than 65 seconds.
- 2 Push TIMER once.**
Timer indicator lights and beep sounds. While the timer is set, the Clock Display Window shows the remaining time.

To display the current time, press **CLOCK**.

Cooking Timer ON—

When the time has elapsed, the buzzer will sound and the TIMER indicator flashes.

Cooking Timer OFF—

The buzzer is turned off automatically after 60 minutes and the Clock Display Window shows current time.

To Stop Cooking Timer

Press **TIMER** to turn off the buzzer.

To Deactivate Cooking Timer

Press **TIMER**. The TIMER indicator goes off and the current time appears in the Clock Display Window.

Note

If a power failure occurs while the Cooking timer is operating, the remaining time becomes invalid.

Additional information

Preparing the Remote Control

Installing the batteries into the remote control

Insert two size AA (R6) batteries (not supplied).

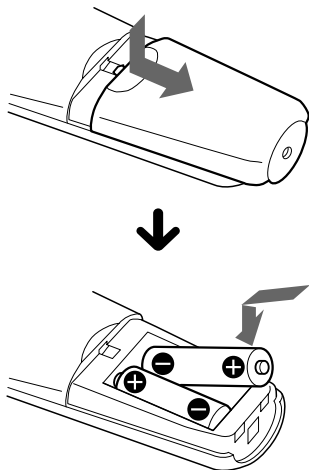

When to replace the batteries

With normal use, the batteries should last for about six months. When the remote control no longer operates the kitchen clock radio, replace all the batteries with new ones.

Notes

- Do not charge the dry batteries.
- When you are not going to use the remote control for a long time, remove the batteries to avoid any damage caused by leakage and corrosion.

Notes on discs

- To keep the disc clean, do not touch the surface. Handle the disc by its edge.
- Keep your discs in their cases or disc magazines when not in use. Do not subject the discs to heat/high temperature. Avoid leaving them in parked cars or on dashboards/rear trays.

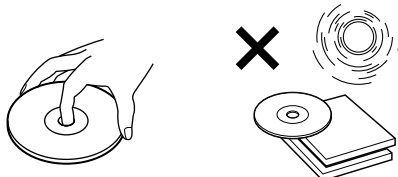

- Do not attach labels, or use discs with sticky ink/residue. Such discs may stop spinning when used, causing a malfunction, or may ruin the disc.

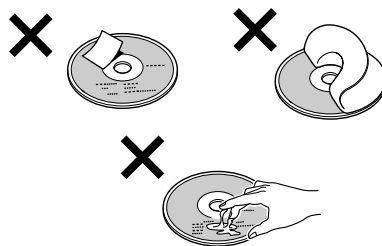

- Do not use any discs with labels or stickers attached.
The following malfunctions may result from using such discs:
 - Inability to eject a disc (due to a label or sticker peeling off and jamming the eject mechanism).
 - Inability to read audio data correctly (e.g., playback skipping, or no playback) due to heat shrinking of a sticker or label causing a disc to warp.
- Discs with non-standard shapes (e.g., heart, square, star) cannot be played on this player. Attempting to do so may damage the player. Do not use such discs.
- Before playing, clean the discs with a commercially available cleaning cloth. Wipe each disc from the center out. Do not use solvents such as benzine, thinner, commercially available cleaners, or antistatic spray intended for analog discs.

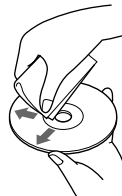

Music discs encoded with copyright protection

This product is designed to play back discs that conform to the Compact Disc (CD) standard. Recently, various music discs encoded with copyright protection are marketed by some record companies. Please be aware that among those discs, there are some that do not conform to the CD standard and may not be playable by this product.

Attention Regarding DualDisc Software

A DualDisc is a two sided disc product which mates DVD recorded material on one side with digital audio material on the other side. However, since the audio material side does not conform to the Compact Disc (CD) standard, playback on this product is not guaranteed.

Specifications

AUDIO POWER SPECIFICATIONS

POWER OUTPUT AND TOTAL HARMONIC DISTORTION

With 6-ohm loads, both channels driven from 100 – 10 000 Hz; rated 1.4 W per channel—minimum RMS power, with no more than 10 % total harmonic distortion in AC operation.

TV section

Television system	American TV standard/NTSC
Channel coverage	VHF: 2-13/UHF: 14-69/ CATV: 1-125
Antenna	75-ohm external antenna terminal for VHF/UHF
Screen type	Wide LCD color monitor
Size	9 inches
System	TFT active matrix
Number of dots	336,960 dots
Input	1 video, 1 audio

DVD/CD player section

Emission duration	Continuous
Laser output	Less than 1,000 μ W (This output is the value measured at a distance of about 200 mm from the objective lens surface on the optical pick-up block with 7 mm aperture.)
Frequency response:	CD: 20 – 20,000 Hz +1/-1 dB DVD Video: 20 – 22,000 Hz +1/-1 dB
Wow and flutter:	Below measurable limit
Output	OPTICAL OUTPUT

Radio section

Frequency range	FM: 87.5 – 108 MHz AM: 530 – 1,710 kHz
-----------------	---

General

Time display	12-hour system
Speaker	77 mm (3 1/8 inches) dia, 6 Ω
Power outputs	1.8 W + 1.8 W (at 10% harmonic distortion)
Power requirements	120 V AC, 60 Hz
Dimensions	Approx. 400 × 123 × 322.5 mm (w/h/d) (Approx. 15 3/4 × 4 7/8 × 12 3/4 inches) incl. projecting parts and controls
Mass	Approx. 4.8 kg (10 lb 9 oz)
Supplied accessories	Mounting screws (4), Template (1), Spacers (4), Remote control (1)

Design and specifications are subject to change without notice.

Troubleshooting

Should any problem occur with the unit, make the following checks to determine whether or not servicing is required. If the problem persists, consult the nearest Sony dealer.

There is no picture.

- Check the AUX, TV and DVD settings
 - when watching TV, set to TV; when watching video equipment, set to AUX; when watching DVD, set to DVD.
- Check that the device connected to the AUDIO/VIDEO INPUT connectors is connected correctly.
- If there is no picture on the TV screen or other devices connected to the player, check that the device is correctly connected to the OPTICAL OUTPUT connector.
- Try another TV channel; it could be station trouble.

Poor or no picture.

- Dirty or defective disc.
- The player is installed in the place subject to severe vibrations.
- Adjust Picture in the PICTURE menu under TV MENU.
- Adjust Brightness in the BRIGHTNESS menu under TV MENU.
- Check the antenna and/or cable connections.

Good picture, no sound

- Press MUTING so that MUTING disappears from the screen.
- Check your MTS setting. Your TV may be set to Auto SAP.

No color

- Adjust Color in the COLOR menu under TV MENU.

Only video noise (snowing) appears on the screen

- Check the Cable setting in the TV MENU.
- Check the antenna and/or cable connections.
- Make sure the channel selected is currently broadcasting.

Dotted lines or stripes

- Adjust the antenna.

Double images or ghosts

- Check your outdoor antenna or call your cable service.
-

Cannot receive higher number channels (UHF) when using an antenna.

- Make sure Cable is set to "OFF" in the TV MENU.
 - Perform Auto Program to add channels that are not presently in the memory.
-

Cable stations don't seem to work

- Make sure Cable is set to "ON" in the "TV MENU".
-

The clock does not show the correct time.

- Has an electrical power outage lasting more than one minute occurred?
-

The player does not operate.

- Did you close the disc tray?
 - Did you place the disc correctly?
The disc should be placed with the labeled side up.
 - Dusty or defective disc
 - Clean the disc with an optional cleaning cloth. Wipe the disc from the center out.
 - Take out the disc and leave the disc compartment open for about an hour to get rid of moisture condensation.
-

The player does not play from the beginning when playing a disc.

- Resume Playback may be activated.
 - Press ■ (Stop) again or eject the disc.
 - Depending on the DVDs, a title menu or a DVD menu may automatically appear on the monitor during playback.
 - Select the desired menu (page 21).
 - Depending on the Video CD, the PBC menu display automatically appears on the monitor during playback.
 - Select the desired menu (page 22).
-

Playback stops automatically.

The disc may contain an auto pause signal. While playing such a disc, this player stops playback at the signal.

You cannot perform certain functions, such as Stop or Search Playback.

With some discs, you cannot activate these functions.

The language for the sound track cannot be changed when you play a DVD.

- Multilingual tracks are not recorded on the DVD.
 - Changing the language for the track is prohibited on the DVD.
-

The subtitle language cannot be changed when you play a DVD.

- Multilingual subtitles are not recorded on the DVD.
 - Changing the subtitle language is prohibited on the DVD.
-

The subtitles cannot be turned off when you play a DVD.

Depending on the DVDs, you may not be able to turn the subtitles off.

The angles cannot be changed when you play a DVD.

- Multi-angles are not recorded on the DVD.
 - Change the angles at a scene recorded with multiple angles (page 22).
 - Changing the angles is prohibited on the DVD.
-

The player does not operate properly.

Static electricity, etc., may affect this player's operation.

→ Turn off the player, allow the player to cool, then turn on again.

There is a noise from the speakers.

- You may hear a noise when you operate the remote control while receiving AM band.
-

Sporadic loss of sound in operation.

- Dusty or defective disc
→ Clean or replace the disc.
 - Volume too high
→ Reduce the volume.
-

The remote control does not function.

- Batteries could be weak. Replace them.
 - Make sure the batteries have been inserted correctly into the remote control.
 - Make sure that you are pointing the remote control at the remote sensor on the unit.
 - Remove any obstacles in the path between the remote control and the unit.
 - Make sure the remote sensor is not exposed to strong light, such as direct sunlight or fluorescent lamp light.
 - Move closer to the unit when using the remote control.
-

Error display

The following indications will be displayed.

POWER OFF OVERHEAT

The player may be overheated.

→ Allow the player to cool off, then turn on again.

WRONG REGION

The region code of the DVD currently in the player does not conform to the player.

→ Make sure the region code of the DVD and the player (page 6).

DISC ERROR

- The data recorded on the disc is damaged.
 - The player does not support the format in which the data is recorded to the disc.
-



The operation cannot be done.

Language Code List

The language spellings conform to the ISO 639: 1988 (E/F) standard.

Code Language	Code Language	Code Language	Code Language
6565 Afar	7089 Frisian	7771 Malagasy	8382 Serbian
6566 Abkhazian	7165 Irish	7773 Maori	8385 Sundanese
6570 Afrikaans	7168 Scots/Gaelic	7775 Macedonian	8386 Swedish
6577 Amharic	7176 Gallcian	7776 Malayalam	8387 Swahili
6582 Arabic	7178 Guarani	7778 Mongolian	8465 Tamil
6583 Assamese	7185 Gujarati	7779 Moldavian	8469 Tegule
6588 Aymara	7265 Hausa	7782 Marathi	8471 Tajik
6590 Azerbaijani	7273 Hindi	7783 Malay	8472 Thai
6665 Bashkir	7282 Croatian	7784 Maltese	8473 Tigrinya
6669 Byelorussian	7285 Hungarian	7789 Burmese	8475 Turkmen
6671 Bulgarian	7289 Armenian	7865 Nauru	8476 Tagalog
6672 Bislama	7365 Interlingua	7869 Nepali	8479 Tonga
6678 Bengali	7378 Indonesian	7876 Dutch	8482 Turkish
6679 Tibetan	7383 Icelandic	7879 Norwegian	8484 Tatar
6682 Breton	7384 Italian	7982 Oriya	8487 Twi
6765 Catalan	7387 Hebrew	8065 Punjabi	8575 Ukrainian
6779 Corsican	7465 Japanese	8076 Polish	8582 Urdu
6783 Czech	7473 Yiddish	8083 Pushto/Pashto	8590 Uzbek
6789 Welsh	7487 Javanese	8084 Portuguese	8673 Vietnamese
6865 Danish	7565 Georgian	8185 Quechua	8679 Volapük
6869 German	7575 Kazakh	8277 Raeto-Romance	8779 Wolof
6890 Bhutani	7576 Greenlandic	8279 Romanian	8872 Xhosa
6976 Greek	7577 Cambodian	8285 Russian	8979 Yoruba
6978 English	7578 Kannada	8365 Kinyarwanda	9072 Chinese
6979 Esperanto	7579 Korean	8368 Sanskrit	9085 Zulu
6983 Spanish	7583 Kashmiri	8372 Serbo-Croatian	
6984 Estonian	7585 Kurdish	8373 Sinhalese	
6985 Basque	7589 Kirghiz	8375 Slovak	
7065 Persian	7665 Latin	8376 Slovenian	
7073 Finnish	7678 Lingala	8377 Samoan	
7074 Fijian	7679 Laotian	8378 Shona	
7079 Faroese	7684 Lithuanian	8379 Somali	
7082 French	7686 Latvian Lettish	8381 Albanian	

IMPORTANT SAFEGUARDS

For your protection, please read these safety instructions completely before operating the appliance, and keep this manual for future reference.

Carefully observe all warnings, precautions and instructions on the appliance and in the operating instructions, and adhere to them.

INSTALLATION

Water and Moisture

Do not use powerline operated appliances near water - for example, near a bathtub, washbowl, kitchen sink, or laundry tub, in a wet basement, or near a swimming pool, etc.

Heat

Do not place the appliance near or over a radiator or heat register, or where it is exposed to direct sunlight.

Ventilation

The slots and openings in the cabinet are provided for necessary ventilation. To ensure reliable operation of the appliance, and to protect it from overheating, these slots and openings must never be blocked or covered.

-Never cover the slots and openings with a cloth or other materials.

-Never block the slots and openings by placing the appliance on a bed, sofa, rug or other similar surface.

-Never place the appliance in a confined space, such as a bookcase, or built-in cabinet, unless proper ventilation is provided.

Accessories

Do not place the appliance on an unstable cart, stand, tripod, bracket, or table. The appliance may fall, causing serious injury to a child or an adult, and serious damage to the appliance. Use only a cart, stand, tripod, bracket, or table recommended by Sony.

-An appliance and cart combination should be moved with care. Quick stops, excessive force, and uneven surfaces may cause the appliance and cart combination to overturn.

Wall or Ceiling Mounting

If your appliance can be mounted to a wall or ceiling, mount it only as recommended by Sony.

USE

Power Source

This appliance should be operated only from the type of power source indicated on the marking label. If you are not sure of the type of electrical power supplied to your home, consult your dealer or local power company. For those appliances designed to operate from battery power, or other sources, refer to the operating instructions.

Grounding or Polarization

This appliance is equipped with a polarized AC power cord plug (a plug having one blade wider than the other), or with a three-wire grounding type plug (a plug having a third pin for grounding). Follow the instructions below:

-For the appliance with a polarized AC power cord plug:

This plug will fit into the power outlet only one way. This is a safety feature. If you are unable to insert the plug fully into the outlet, try reversing the plug. If the plug should still fail to fit, contact your electrician to have a suitable outlet installed. Do not defeat the safety purpose of the polarized plug by forcing it in.

-For the appliance with a three-wire grounding type AC plug:

This plug will only fit into a grounding-type power outlet. This is a safety feature. If you are unable to insert the plug into the outlet, contact your electrician to have a suitable outlet installed. Do not defeat the safety purpose of the grounding plug.

Overloading

Do not overload wall outlets, extension cords or convenience receptacles beyond their capacity, since this can result in fire or electric shock.

When not in use

Unplug the power cord of the appliance from the outlet when left unused for a long period of time. To disconnect the cord, pull it out by grasping the plug. Never pull the plug out by the cord.

Power-Cord Protection

Route the power cord so that it is not likely to be walked on or pinched by items placed upon or against them, paying particular attention to the plugs, receptacles, and the point where the cord exits from the appliance.

Lightning

For added protection for this appliance during a lightning storm, or when it is left unattended and unused for long periods of time, unplug it from the wall outlet and disconnect the antenna or cable system. This will prevent damage to the appliance due to lightning and powerline surges.

Object and Liquid Entry

Never push objects of any kind into the appliance through openings as they may touch dangerous voltage points or short out parts that could result in a fire or electric shock. Never spill liquid of any kind on the appliance.

Cleaning

Unplug the appliance from the wall outlet before cleaning or polishing it. Do not use liquid cleaners or aerosol cleaners. Use a cloth lightly dampened with water for cleaning the exterior of the appliance. Clean the appliance only as recommended by Sony.

Attachments

Do not use attachments not recommended by Sony, as they may cause hazards.

ANTENNAS

Outdoor Antenna Grounding

If an outdoor antenna or cable system is installed, follow the precautions below.

An outdoor antenna system should not be located in the vicinity of overhead power lines or other electric light or power circuits, or where it can come in contact with such power lines or circuits. WHEN INSTALLING AN OUTDOOR ANTENNA SYSTEM, EXTREME CARE SHOULD BE TAKEN TO KEEP FROM CONTACTING SUCH POWER LINES OR CIRCUITS AS CONTACT WITH THEM IS ALMOST INVARIABLY FATAL.

Be sure the antenna system is grounded so as to provide some protection against voltage surges and built-up static charges. Section 810 of the National Electrical Code provides information with respect to proper grounding of the mast and supporting structure, grounding of the lead-in wire to an antenna discharge unit, size of grounding conductors, location of antenna-discharge unit, connection to grounding electrodes, and requirements for the grounding electrode.

Antenna Grounding According to the National Electrical Code

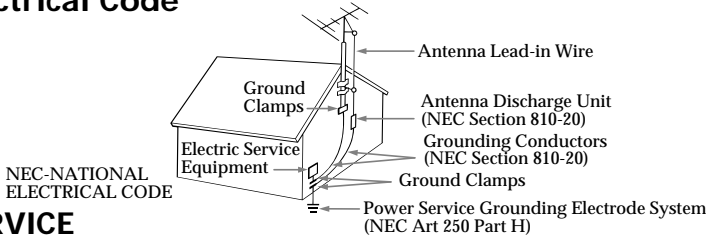

SERVICE

Damage Requiring Service

Unplug the appliance from the wall outlet and refer servicing to qualified service personnel under the following conditions:

- When the power cord or plug is damaged or frayed.
- If liquid has been spilled or objects have fallen into the appliance.
- If the appliance has been exposed to rain or water.
- The appliance does not appear to operate normally or exhibits a marked change in performance.
- This indicates a need for service.
- If the appliance does not operate normally when following the operating instructions, adjust only those controls that are specified in the operating instructions. Improper adjustment of other controls may result in damage and will often require extensive work by a qualified technician to restore the appliance to normal operation.
- If the appliance has been subject to excessive shock by being dropped, or the cabinet has been damaged.

Servicing

Do not attempt to service the appliance yourself as opening or removing covers may expose you to dangerous voltage or other hazards.

Refer all servicing to qualified service personnel.

Replacement parts

When replacement parts are required, be sure the service technician has used replacement parts specified by Sony that have the same characteristics as the original parts.

Unauthorized substitutions may result in fire, electric shock, or other hazards.

Safety Check

Upon completion of any service or repairs to the appliance, ask the service technician to perform routine safety checks (as specified by Sony) to determine that the appliance is in safe operating condition.

SONY[®]

Tape Cassette Player/Recorder/CD Player/Mini Disc
DAT/Radio/Head Phone/Speaker/MIC/Personals

Portable Audio

LIMITED WARRANTY

Sony Electronics Inc. ("Sony") warrants this Product (including any accessories) against defects in material or workmanship as follows:

1. **LABOR:** For a period of one (1) year from the date of purchase, if this Product is determined to be defective, Sony will repair or replace the Product, at its option, at no charge, or pay the labor charges to any Sony authorized service facility. After the Warranty Period, you must pay for all labor charges.
2. **PARTS:** In addition, Sony will supply, at no charge, new or rebuilt replacements in exchange for defective parts for a period of one (1) year. After the warranty period, you must pay for all parts costs.
3. **ACCESSORIES:** Parts and labor for all accessories are for one (1) year.

To obtain warranty service, you must take the Product, or deliver the Product freight prepaid, in either its original packaging or packaging affording an equal degree of protection, to any authorized Sony service facility.

This warranty does not cover customer instruction, installation, set up adjustments or signal reception problems.

This warranty does not cover cosmetic damage or damage due to acts of God, accident, misuse, abuse, negligence, commercial use, or modification of, or to any part of the Product, including the antenna. This warranty does not cover damage due to improper operation or maintenance, connection to improper voltage supply, or attempted repair by anyone other than a facility authorized by Sony to service the Product. This warranty does not cover Products sold AS IS or WITH ALL FAULTS, or consumables (such as fuses or batteries). This warranty is valid only in the United States.

Proof of purchase in the form of a bill of sale or receipted invoice which is evidence that the unit is within the Warranty period must be presented to obtain warranty service.

This warranty is invalid if the factory applied serial number has been altered or removed from the Product.

REPAIR OR REPLACEMENT AS PROVIDED UNDER THIS WARRANTY IS THE EXCLUSIVE REMEDY OF THE CONSUMER. SONY SHALL NOT BE LIABLE FOR ANY INCIDENTAL OR CONSEQUENTIAL DAMAGES FOR BREACH OF ANY EXPRESS OR IMPLIED WARRANTY ON THIS PRODUCT. EXCEPT TO THE EXTENT PROHIBITED BY APPLICABLE LAW, ANY IMPLIED WARRANTY OF MERCHANTABILITY OR FITNESS FOR A PARTICULAR PURPOSE ON THIS PRODUCT IS LIMITED IN DURATION TO THE DURATION OF THIS WARRANTY.

Some states do not allow the exclusion or limitation of incidental or consequential damages, or allow limitations on how long an implied warranty lasts, so the above limitations or exclusions may not apply to you. In addition, if you enter into a service contract with the Sony Partnership within 90 days of the date of sale, the limitation on how long an implied warranty lasts does not apply to you. This warranty gives you specific legal rights, and you may have other rights which vary from state to state.

For your convenience, Sony Electronics Inc. has established telephone numbers for frequently asked questions:

To locate the servicer or dealer nearest you, or for service assistance or resolution of a service problem, or for product information or operation, call:

Sony Customer Information Services Center
1-800-222-7669
or visit the Sony Web Site:
www.sony.com

For an accessory or part not available from your authorized dealer, call:

1-800-488-SONY (7669)

D 455714502

<http://www.sony.net/>

Sony Corporation Printed in China



Printed on 100% recycled paper using
VOC (Volatile Organic Compound)-free
vegetable oil based ink.

Download from [Www.Somanuals.com](http://www.Somanuals.com). All Manuals Search And Download.

Free Manuals Download Website

<http://myh66.com>

<http://usermanuals.us>

<http://www.somanuals.com>

<http://www.4manuals.cc>

<http://www.manual-lib.com>

<http://www.404manual.com>

<http://www.luxmanual.com>

<http://aubethermostatmanual.com>

Golf course search by state

<http://golfingnear.com>

Email search by domain

<http://emailbydomain.com>

Auto manuals search

<http://auto.somanuals.com>

TV manuals search

<http://tv.somanuals.com>