

SONY

3-856-873-11 (1)

KV-14V4U

Operating Instructions **GB**

Trinitron Colour Video TV

VHS Video
COMBO
Black **Trinitron**

VIDEO *plus*

VHS
PAL NTSC 4.43

© 1996 by Sony Corporation Printed in Spain

SONY KV-14V4U (GB)_3-856-873-11 (1)

WARNING

To prevent fire or shock hazard, do not expose the unit to rain or moisture. Dangerously high voltages are present inside the set. Do not open the cabinet. Refer servicing to qualified personnel only.

Caution

Television programmes, films, video tapes and other materials may be copyrighted. Unauthorized recording of such materials may be contrary to the provisions of the copyright laws.

Colour System of Your Set

This video TV is designed to receive TV programmes based on PAL (I) colour system and to record and play on PAL colour system. Also, the video TV can play tapes on NTSC colour system.

Precautions

Safety Information

For general safety:

- Do not expose the unit to rain or moisture.
- Do not open the rear cover.

For safe operations:

- Do not operate the unit on anything but 220-240 V AC.
- Do not operate the unit if any liquid or solid object falls in it—have it checked immediately.
- Unplug the unit from the wall outlet if you do not intend to use it for an extended period of time. To disconnect the cord, pull it out by the plug, never by the cord.

NOTICE FOR CUSTOMERS IN THE UNITED KINGDOM

A moulded plug complying with BS1363 is fitted to this equipment for your safety and convenience. Should the fuse in the plug supplied need to be replaced, a 5 AMP fuse approved by ASTA or BSI to BS 1362 (i.e. marked with ⚡ or ⚡ must be used. When an alternative type of plug is used it should be fitted with a 5 AMP FUSE, otherwise the circuit should be protected by a 5 AMP FUSE at the distribution board. If the plug supplied with this equipment has a detachable fuse cover, be sure to attach the fuse cover after you change the fuse. Never use the plug without the fuse cover. If you should lose the fuse cover, please contact your nearest Sony service station.

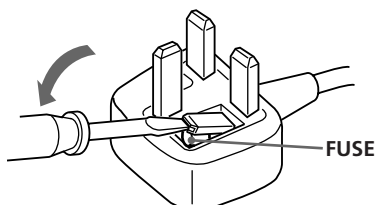

For safe installation:

- Do not block the ventilation openings.
- Do not install the unit in hot, humid, or excessively dusty places.
- Do not install the unit where it may be exposed to mechanical vibrations.
- Position the unit so that there is a clear space of 10 cm from a wall, allowing you to press the Ⓜ (MAIN POWER) switch to turn it on and off completely.

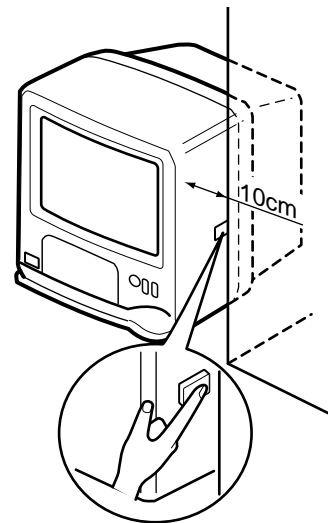

For your protection, refer all servicing to qualified personnel.

● IMPORTANT

If the plug supplied is not suitable for the socket outlets in your home, it should be cut off and an appropriate plug fitted in accordance with the following instructions: The wires in this mains lead are coloured in accordance with the following code:

Blue	Neutral
Brown	Live

As the colours of the wires in the mains lead of this apparatus may not correspond with the coloured markings identifying the terminals in your plug, proceed as follows:

The wire which is coloured blue must be connected to the terminal which is marked with the letter N or coloured black. The wire which is coloured brown must be connected to the terminal which is marked with the letter L or coloured red. Do not connect either wire to the earth terminal in the plug which is marked by the letter E or by the safety earth symbol ⚡ or coloured green or green and yellow.

● WARNING

To prevent shock hazard, do not insert the plug cut off from the mains lead into a socket outlet. This plug cannot be used and should be destroyed.

- To prevent fire or shock hazard, do not expose the unit to rain or moisture.
- Dangerously high voltages are present inside the set. Do not open the cabinet. Refer servicing to qualified personnel only.

How to replace the fuse

Open the fuse compartment with a blade screwdriver, and replace the fuse.

Contents

Getting Started

Step 1—Preparation	4
Checking the supplied accessories	4
Inserting batteries into the Remote Commander	4
Step 2—Connecting the aerial	5
Connecting an indoor aerial	5
Connecting an outdoor aerial	5
Step 3—Tuning in to TV stations	6
Selecting the language on the menu	6
Presetting channels automatically	7
Presetting channels manually	8
Skipping programme positions	9
Captioning a TV station name	10
Manual fine-tuning	11
Step 4 — Setting up VCR Plus+*	12
Setting the guide channels	12
Step 5—Setting the clock	14

Basic Operations

Watching the TV	15
Switching the video TV on and off	15
Selecting TV programmes	15
Adjusting the volume	15
Muting the sound	16
Displaying the on-screen information	16
Adjusting the picture	16
Watching line input	18
Listening with headphones	18
Playing a Tape	19
Inserting a video cassette	19
Ejecting a video cassette	19
Protecting your cassette against accidental erasure	19
Playing a tape	20
Playing a tape repeatedly (Auto Repeat)	21
Displaying the on-screen indications	21
Resetting the tape counter	21
Recording TV programmes	22
Recording TV programmes	22
Recording with the TV off	22
Recording TV programmes using the timer	23
Setting the timer	23
Using the video TV before timer recording starts	25
Checking the timer settings	26
Changing or canceling the timer settings	26
Recording using the quick-timer	27
Timer recording with PDC signals	28
Recording TV programmes using VCR Plus+	29

Additional Operations

Switching off automatically—Sleep timer	31
Switching on at your desired time—On timer	32
Enhancing video picture quality	33
Adjusting the tracking	33
Adjusting with the optimum picture control (OPC)	34
About the auto head cleaner	34
Connecting optional equipment	35
Watching the picture input from optional equipment	35
Editing with another VCR	35

Additional Information

Troubleshooting	36
Taking care of your video TV	38
Video head cleaning	38
Worn video heads	38
Check the video heads after 1,000 hours of use	38
Specifications	39
Television channel number guide	40
Index to parts and controls	41
Video TV set—front	41
Remote Commander	42

* VCR Plus+ and PlusCode are trademarks of Gemstar Development Corporation. VCR Plus+ system is manufactured under license from Gemstar Development Corporation.

Step 1 — Preparation

Checking the Supplied Accessories

When you have taken everything out of the carton, check that you have these items:

- Remote Commander
- Two R6 (size AA) batteries
- Loop aerial

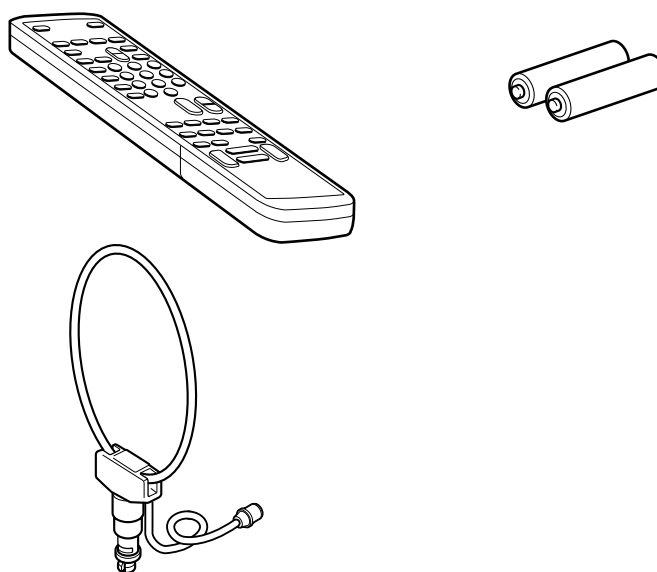

Inserting Batteries into the Remote Commander

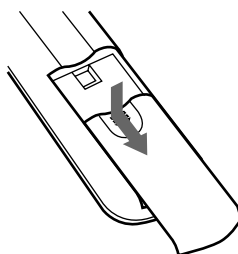

Turn the Commander over, and remove the cover.

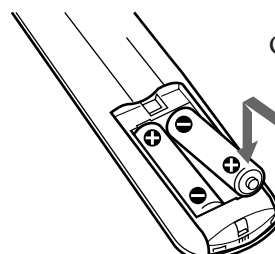

Close the cover.

Check the polarities and position two R6 batteries correctly.

Step 2 — Connecting the Aerial

Connecting an Indoor Aerial

If your local UHF signal is strong, an indoor aerial can be used to obtain a clear picture. Connect the supplied loop aerial as follows.

1 Insert the aerial until it clicks.

2 Connect to the Υ (aerial) socket.

After you've turned on the video TV, adjust the aerial for best reception.

GB

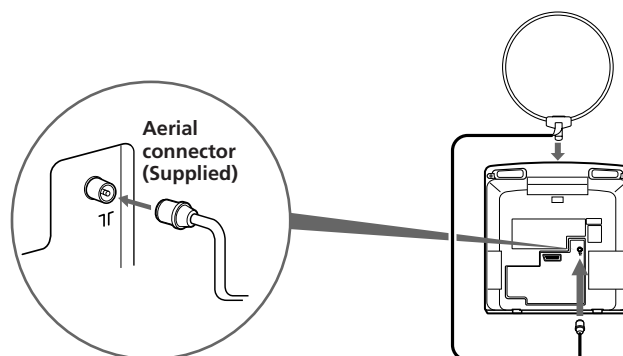

Do not use this aerial with any other TV product.

Connecting an Outdoor Aerial

For better TV reception and recording with clear video picture, connect an outdoor aerial to your video TV.

To connect a UHF aerial—75-ohm coaxial cable (round)

Attach an IEC aerial connector to 75-ohm coaxial cable.

Plug the connector into the Υ (aerial) socket of the video TV.

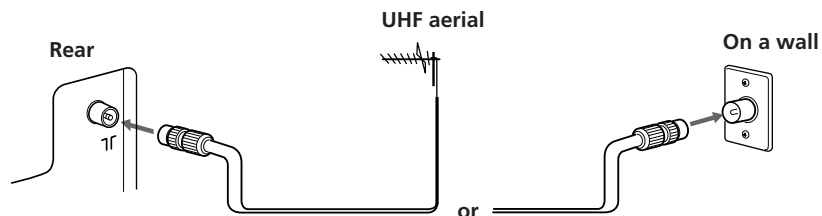

After connecting the aerial, connect the mains lead to a wall outlet.

Step 3 — Tuning in to TV Stations

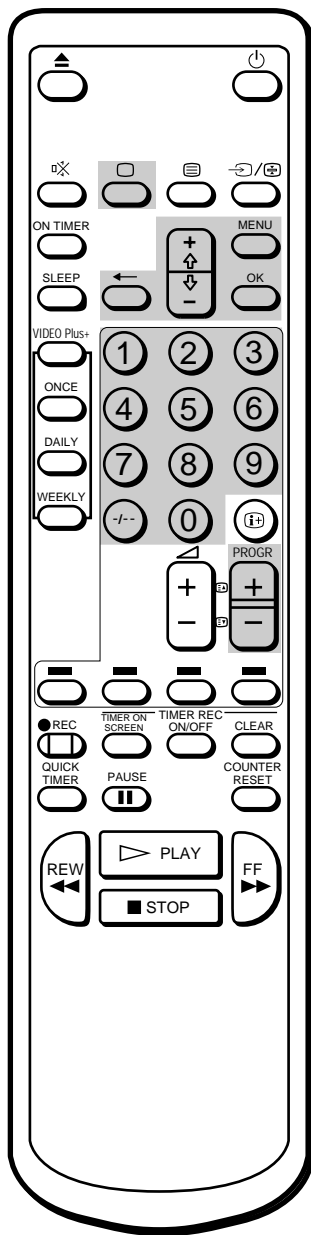

Note on the DEMONSTRATION function

If you choose "DEMONSTRATION" on the main menu and press OK, you can see a sequential demonstration on the menu functions on the screen. Press any button (e.g. MENU) to stop this function.

You should preset the channels (up to 60 channels) by choosing either the automatic or manual method.

The automatic method is easier if you want to preset all receivable channels at once. Use the manual method if you want to allocate programme numbers to the channels one by one.

Before you begin

- Depress the ① switch on the video TV to switch it on.
If the ① lamp on the video TV is lit in red, press □, PROGR +/- or a number button on the Remote Commander.

Selecting the Language on the Menu

You can select one of several languages for the menu and on-screen information.

The initial setting is English.

- 1 Press MENU.
The main menu appears.

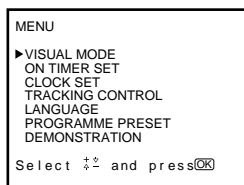

- 2 Move the cursor (▶) to "LANGUAGE" with + ⬆ or - ⬇ and press OK.
The LANGUAGE menu appears.

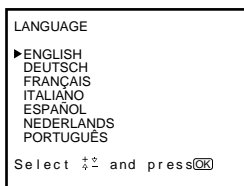

- 3 Select the language you want with + ⬆ or - ⬇ and press OK.
The selected language is coloured green, and the menu appears in the selected language.
- 4 Press MENU to go back to the original screen.

Presetting Channels Automatically

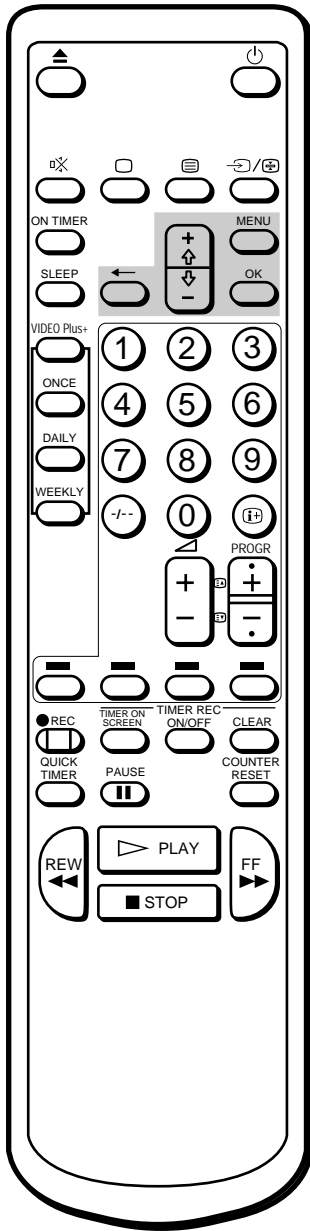

To stop automatic channel presetting

Press on the Remote Commander.

- 1 Press MENU to display the main menu.
- 2 Move the cursor (▶) to "PROGRAMME PRESET" with + ⬆ or - ⬇ and press OK.
The PROGRAMME PRESET menu appears.

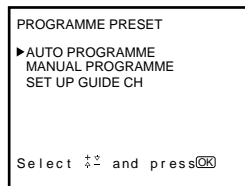

- 3 Move the cursor (▶) to "AUTO PROGRAMME" with + ⬆ or - ⬇ and press OK.
The AUTO PROGRAMME menu appears.

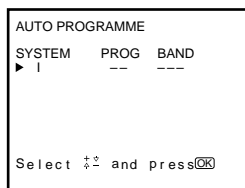

- 4 Press OK.
The programme number you previously watched appears in red in the "PROG" position.
Using + ⬆ or - ⬇, select the programme number from which you want to start presetting.
- 5 Press OK.
The tuning bar appears, and the video TV starts scanning and presetting a receivable channel from programme number selected in step 4.
The band scanning by tuning bar is displayed in the "BAND" position.

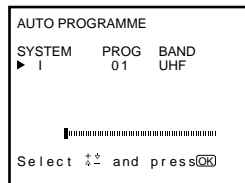

The preset programme and channel numbers are displayed on the screen in sequence. When presetting is finished, the original screen appears. All available channels are now stored on successive number buttons.

GB

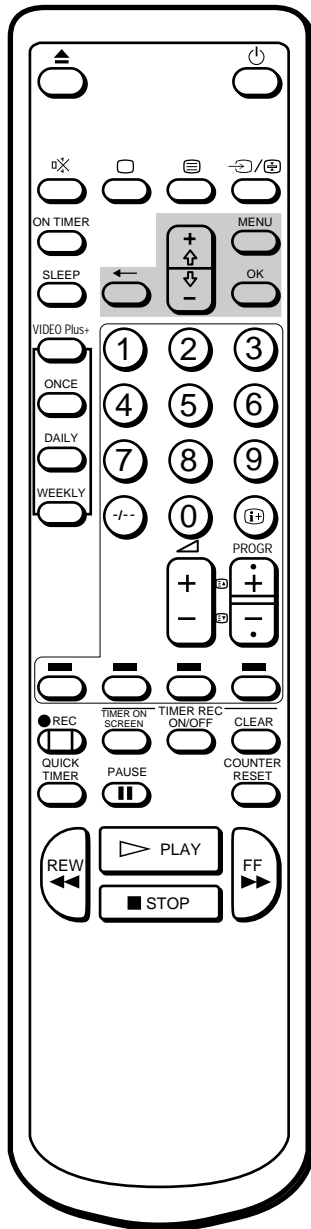

For programme positions beyond 2

The display scrolls by pressing \downarrow repeatedly.

If you have made a mistake

Press \leftarrow to go back to the previous position.

Presetting Channels Manually

- 1 Press MENU to display the main menu.
- 2 Move the cursor (\blacktriangleright) to "PROGRAMME PRESET" with $+\uparrow$ or $-\downarrow$ and press OK.
The PROGRAMME PRESET menu appears.

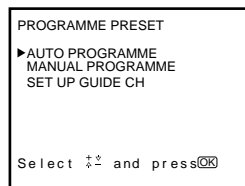

- 3 Move the cursor (\blacktriangleright) to "MANUAL PROGRAMME" with $+\uparrow$ or $-\downarrow$ and press OK.
The MANUAL PROGRAMME menu appears.

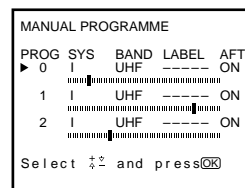

- 4 Using $+\uparrow$ or $-\downarrow$, move the cursor (\blacktriangleright) to the programme position (number button) to which you want to preset the channel, and press OK repeatedly until the tuning bar turns red.

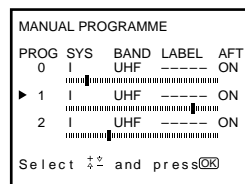

- 5 Press $+\uparrow$ (up) or $-\downarrow$ (down).
The tuning bar turns green and starts scanning receivable channels. When the receivable channel is found, the tuning bar stops. If you want to preset this channel, press OK. If not, press $+\uparrow$ or $-\downarrow$ again to search for another channel.
- 6 Repeat steps 4 and 5 to preset other channels.
- 7 After you finish presetting, press MENU to go back to the original screen.

Skipping Programme Positions

You can skip unused programme positions when selecting programme with PROGR +/- buttons. However, the skipped programmes may still be called up when you select them with the number buttons.

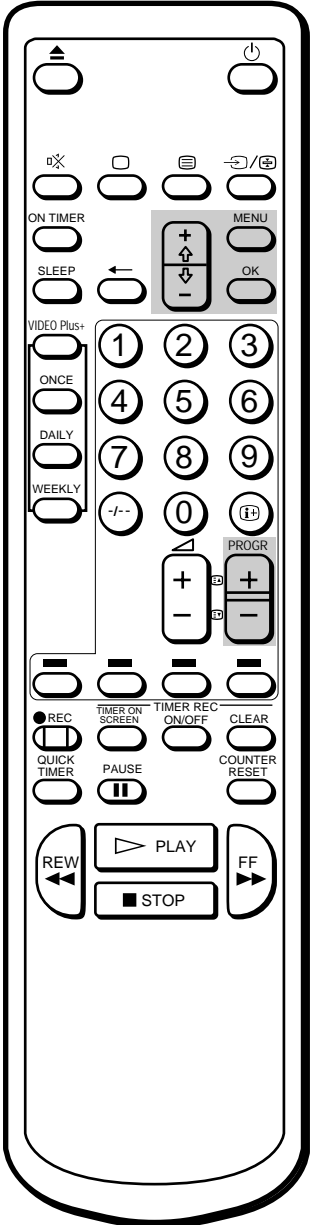

- 1 Press MENU to display the main menu.
- 2 Move the cursor (▶) to "PROGRAMME PRESET" with + ↕ or - ↕ and press OK.
The PROGRAMME PRESET menu appears.
- 3 Move the cursor (▶) to "MANUAL PROGRAMME" with + ↕ or - ↕ and press OK.
The MANUAL PROGRAMME menu appears.
- 4 Using + ↕ or - ↕, move the cursor (▶) to the programme position which you want to skip and press OK.
The "SYS" position turns red.

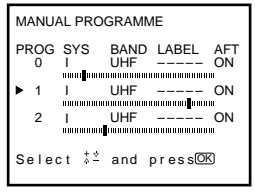

- 5 Press + ↕ or - ↕ until "----" appears in the "SYS" position and press OK.

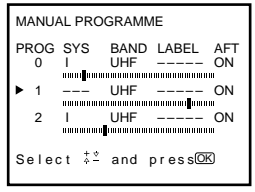

When you select programmes using the PROGR +/- buttons, the programme position is skipped.

- 6 Repeat steps 4 and 5 to skip other programme positions.
- 7 Press MENU to go back to the original screen.

For programme positions beyond 2
The display scrolls by pressing - ↕ repeatedly.

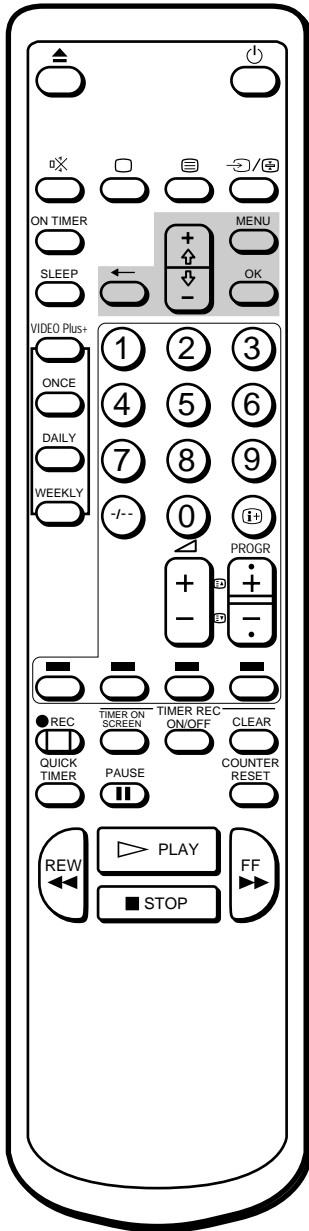

Captioning a TV Station Name

You can name a channel using up to five characters (letters or numbers) to be displayed on the TV screen (e.g. MTV). Using this function, you can easily identify which channel you are watching.

- 1 Press MENU to display the main menu.
- 2 Move the cursor (▶) to "PROGRAMME PRESET" with + ⬆ or - ⬇ and press OK.
The PROGRAMME PRESET menu appears.
- 3 Move the cursor (▶) to "MANUAL PROGRAMME" with + ⬆ or - ⬇ and press OK.
The MANUAL PROGRAMME menu appears.

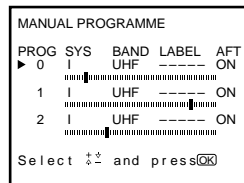

- 4 Using + ⬆ or - ⬇, move the cursor (▶) to the programme position you want to caption and press OK repeatedly until the first element of the "LABEL" position turns red.
- 5 Select a letter or number with + ⬆ or - ⬇ and press OK.
The next element turns red. Select other characters in the same way. For the element you want to leave blank, select "--" and press OK.

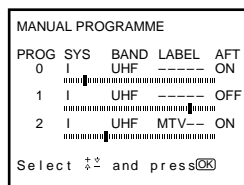

- 6 After selecting all the characters, press OK repeatedly until the cursor appears. Now the caption you chose is stored.
- 7 Repeat steps 4 to 6 to caption other channels.
- 8 Press MENU to go back to the original screen.

If you have made a mistake

Press ◀ to go back to the previous position.

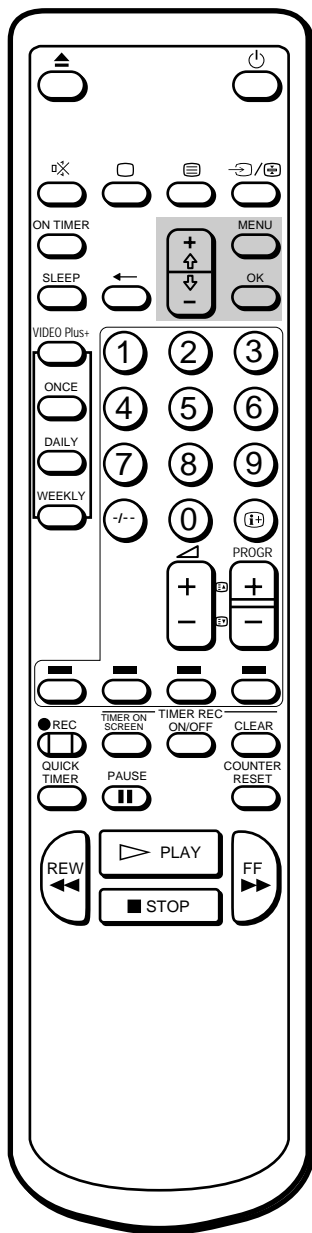

To reactivate automatic fine-tuning (AFT)

Repeat from the beginning and select "ON" in step 5.

Manual Fine-Tuning

Normally, the automatic fine-tuning (AFT) is already working. However, if the picture of a programme is distorted, you can use the manual fine-tuning function to obtain better picture reception.

- 1 Press MENU to display the main menu.
- 2 Move the cursor (▶) to "PROGRAMME PRESET" with + ⬆ or - ⬇ and press OK.
The PROGRAMME PRESET menu appears.
- 3 Move the cursor (▶) to "MANUAL PROGRAMME" with + ⬆ or - ⬇ and press OK.
The MANUAL PROGRAMME menu appears.
- 4 Using + ⬆ or - ⬇, move the cursor (▶) to the programme position which you want to manually fine-tune.

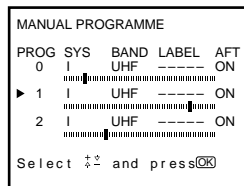

- 5 Press OK repeatedly until the AFT position turns red, then press + ⬆ or - ⬇ to select OFF.
- 6 Press OK.
The tuning bar turns red.
While holding down + ⬆ or - ⬇, the tuning bar flashes red and green by turns, and the channel is fine-tuned. When the best TV reception is found, release + ⬆ or - ⬇.
- 7 Press OK.
The cursor (▶) appears. Now the fine-tuned level is stored.
- 8 Repeat steps 4 to 7 to fine-tune other channels.
- 9 Press MENU to go back to the original screen.

GB

Step 4 — Setting up Video Plus+

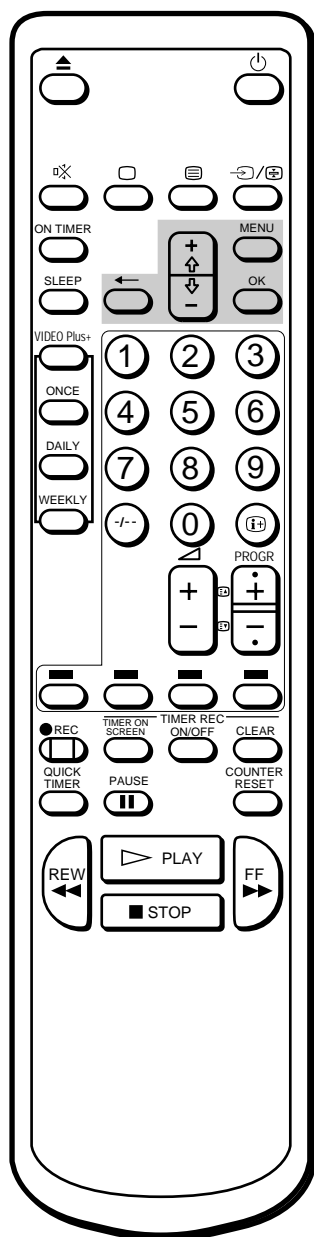

If you have made a mistake

Press **←** to go back to the previous position.

VIDEO plus+ is a feature that simplifies programming the video TV to make timer recording. To use VIDEO plus+, each programme position needs to be matched with its VIDEO plus+ guide channel. To get the guide channel numbers, see “Guide channels for VIDEO plus+” on page 13, or look in the programme guide for your area that features PlusCodes.

Before you begin

- If the **⏻** lamp on the video TV is lit in red, press **□**, **PROGR +/-** or a number button on the Remote Commander.

Setting the Guide Channels

- 1 Press **MENU** to display the main menu. The main menu appears.

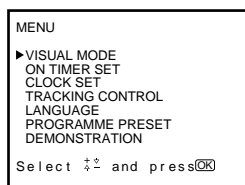

- 2 Move the cursor (**▶**) to “PROGRAMME PRESET” with **+ ↑** or **- ↓** and press **OK**. The PROGRAMME PRESET menu appears.

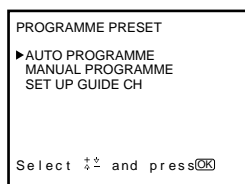

- 3 Move the cursor (**▶**) to “SET UP GUIDE CH” with **+ ↑** or **- ↓** and press **OK**. The SET UP GUIDE CH menu appears.

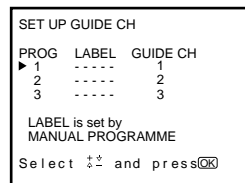

- 4 Using + ⬆ or – ⬇, move the cursor (▶) to the programme position (number button) to which you want to preset the guide channel, and press OK. The GUIDE CH position turns red.

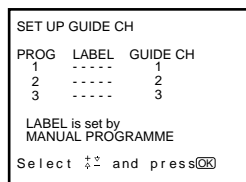

GB

- 5 Select the guide channel you want to preset with + ⬆ or – ⬇, and press OK.

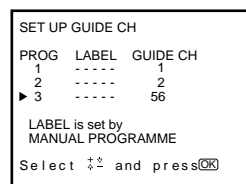

- 6 Repeat steps 4 and 5 to preset other channels.
- 7 After you finish presetting, press MENU to go back to the original screen.

Guide channels for VIDEO plus+

Guide channel	Station name	Guide channel	Station name
001	BBC1	122	TELECLUB
002	BBC2	123	UK GOLD
003	ITV	124	DISCOVERY
004	CHANNEL 4		THE LEARNING CHANNEL
005	RTE (IRELAND)	125	BRAVO
006	NETWORK 2 (IRELAND)		ADULT CHANNEL
101	SKY ONE	126	CNN
102	SKY NEWS	127	EURONEWS
103	SKY MOVIES	129	QVC
104	THE MOVIE CHANNEL	130	UK LIVING
105	SKY SPORT	131	RAI 1
106	NICKELODEON	132	RAI 2
	VH-1 GERMANY	133	TV5 EUROPE
107	EUROSPORT	134	TVE INTERNATIONAL
108	GALAVISION	135	MBC/ARABIC
109	MTV EUROPE	136	VTM
110	CHILDERN'S CHANNEL	137	SPORTNET
	THE FAMILY CHANNEL	138	COUNTRY MUSIC TV
111	SKY MOVIES GOLD	139	VIDEO HITS ONE
112	BBC WORLD SERVICE		VH-1
113	RTL 4	140	SKY SPORT 2 & SOAPS & TRAVEL
114	SUPER SPORT		TV ASIA
	FILMNET 2	141	LA-5
	FILMNET +	142	LIVE TV
115	RTL PLUS INTERNATIONAL	143	SUPERCANNEL
116	SAT 1	144	JAPAN TV
117	PREMIERE	145	SELECT TV
118	3 SAT	146	MOVIE CHANNEL FILMNET 1
119	ARD	147	TNT
120	PRO 7	149	CARTOON NETWORK
121	TELE 5		

Step 5 — Setting the Clock

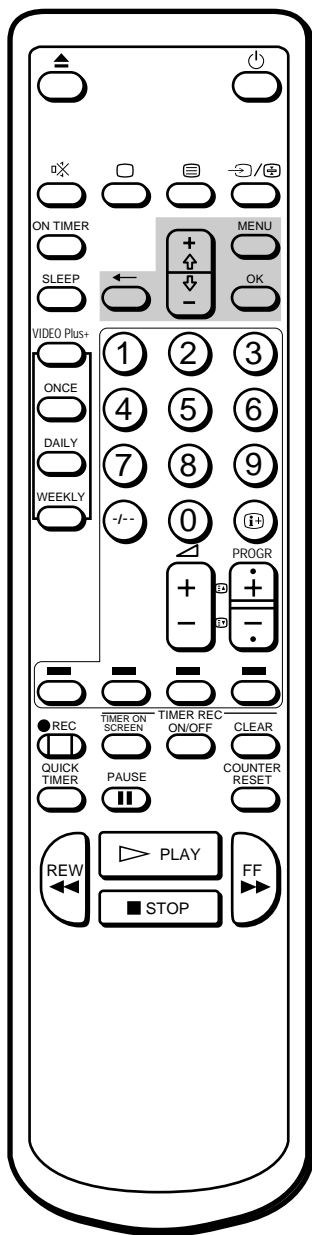

If you have made a mistake

Press **←** to go back to the previous position.

If the clock has stopped and "--/--" is displayed

You have to re-set the clock.

You need to set the clock for using timer recording and quick-timer recording functions.

- 1 Press MENU to display the main menu.

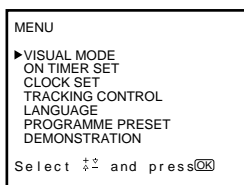

- 2 Move the cursor (▶) to "CLOCK SET" with + ↑ or - ↓ and press OK. The CLOCK SET menu appears.

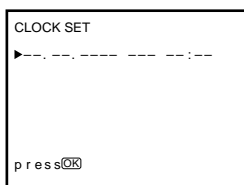

- 3 Press OK to start setting the clock. The day section turns red.

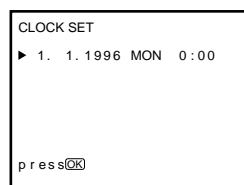

- 4 Set the day with + ↑ or - ↓ and press OK. The month section turns red.

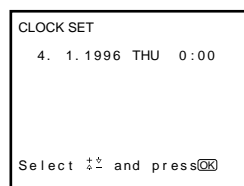

- 5 Using + ↑ or - ↓ and OK, set the month, year, hour and minute in the same way as in step 4.

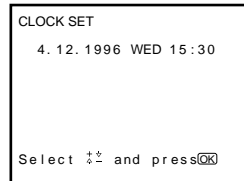

- 6 After setting the minute, press OK. The clock starts working.

- 7 Press MENU to go back to the original screen.

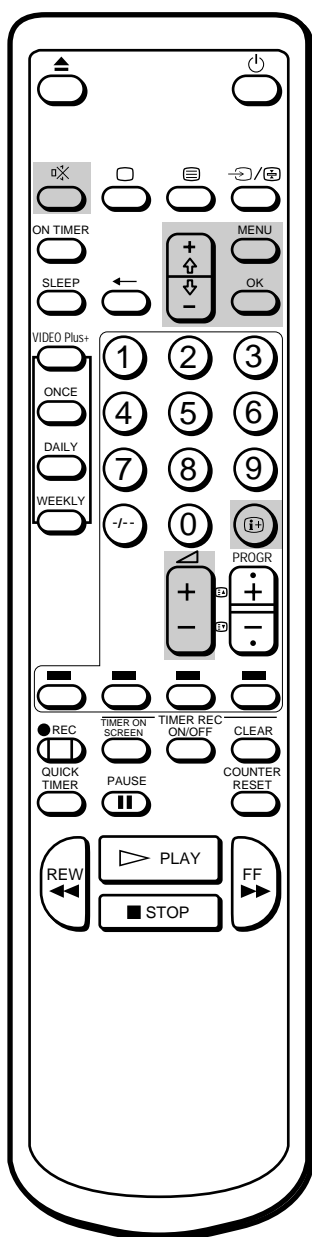

Muting the Sound

Press .

The indicator appears and stays on the screen.

To resume normal sound, press again or +.

Displaying the On-screen Information

Press to display the following on-screen information.

To have the programme number and caption stay on the screen, press again.

To make the indications disappear, press until no indications are displayed on the screen.

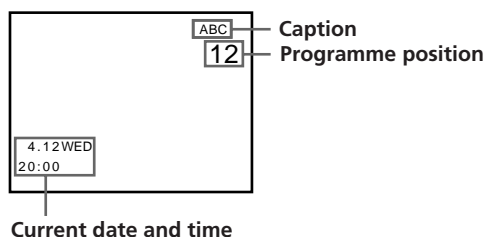

Adjusting the Picture

You can select one of four settings for picture effect in the menu. You can also adjust the picture to suit your own taste.

Selecting the picture effect

- 1 Press MENU to display the main menu.

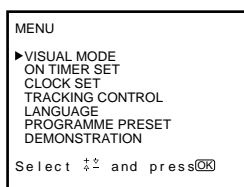

- 2 Move the cursor () to VISUAL MODE with + or - and press OK. The VISUAL MODE menu appears.

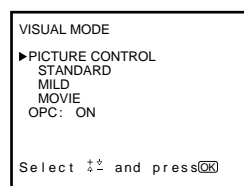

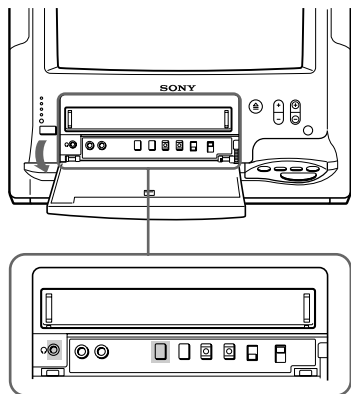

- Press MENU to go back to the original screen. The adjusted control levels are stored.

Effect of each control

PICTURE CONTROL	Effect
CONTRAST	Less More
COLOUR	Less More
BRIGHTNESS	Darker Brighter
HUE	Greenish Reddish
RESET	Resets all the items to the factory preset levels.

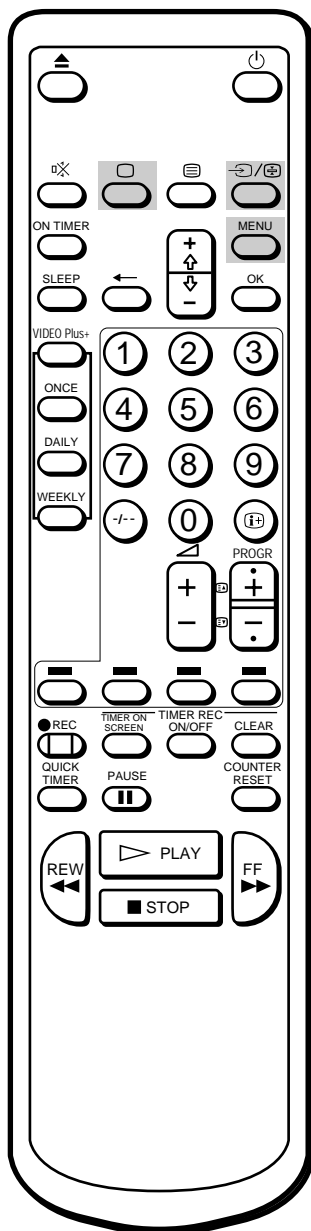

Watching Line Input



Press repeatedly until the desired input indicator appears. To go back to the normal TV picture, press until the programme position appears, or press on the Remote Commander once. For details of the video input picture, see page 35.

Listening with Headphones

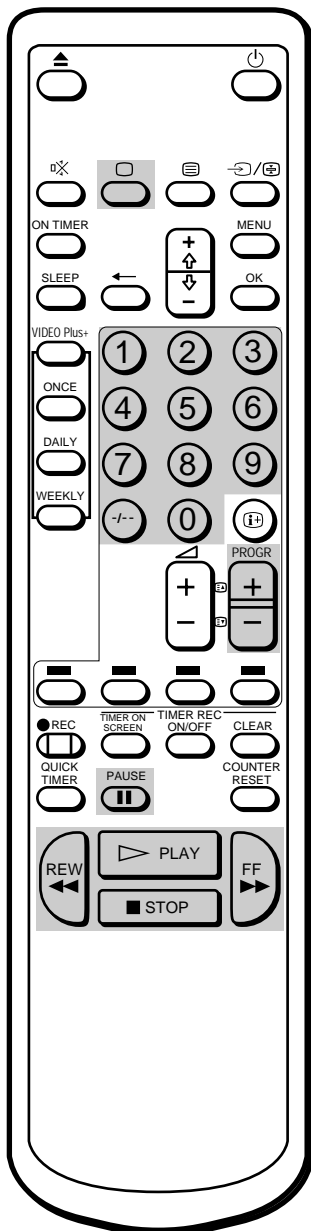
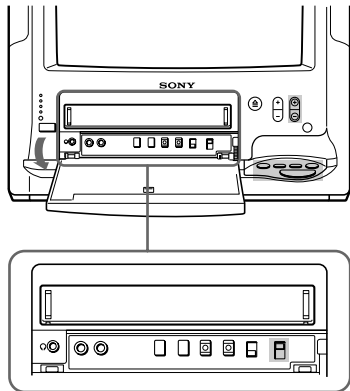
Plug the headphones (not supplied) to the (headphones) jack inside the front panel on the video TV. The sound from the speaker is shut off.



Playing a Tape

- 1 Press , **PROGR +/-** or number buttons on the Remote Commander, or **PROGR +/-** on the video TV when the  lamp is lit in red.
- 2 Insert a cassette.
If you insert a cassette with its safety tab removed, playback starts automatically.
- 3 Set the **COLOUR SYSTEM** switch to conform to the colour system of the tape to be played. Normally, set it to **AUTO**. If streaks appear when playing a tape, switch it to select the colour system.
PAL: to play a tape recorded in PAL colour system
NTSC: to play a tape recorded in NTSC colour system
- 4 Press **PLAY** .
Playback starts. On-screen information is displayed for some seconds.

To stop playback

Press **STOP** .

The video TV goes back to the normal TV picture.

To stop playback for a moment

Press **PAUSE** .

Press **PAUSE**  again or press **PLAY**  to resume playback.

If you leave your video TV in pause mode, normal playback resumes after about 5 minutes to protect the quality of video tapes.

To fast forward the tape

Press **STOP** , then press **FF** .

To rewind the tape

Press **STOP** , then press **REW** .

To search a tape at high speed

During playback, press and hold **REW**  (rewind) or **FF**  (fast forward).

A high-speed picture appears on the TV screen.

To resume normal playback, release the button.

To view the picture in fast forward or rewind mode

Press and hold **FF**  during fast forward or **REW**  during rewind.

While you hold the button, you can view the picture.

When you release the button, fast forward or rewind mode is resumed.

Recording TV Programmes

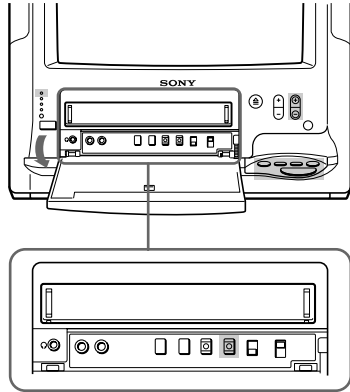

Recording TV Programmes

- 1 Press \square , **PROGR +/-** or number buttons on the Remote Commander, or **PROGR +/-** on the video TV when the \odot lamp is lit in red.
- 2 Insert a cassette with a safety tab.
- 3 Select the programme position with **PROGR +/-**. You can also use number buttons on the Remote Commander. For double-digit numbers (e.g.14), first press **-/-**, then press 1 and 4.
- 4 Press **REC** \bullet .
The **REC** lamp on the front of the video TV lights up and recording begins.

To stop recording

Press **STOP** \blacksquare .

When the tape reaches the end, the video TV rewinds the tape automatically to the beginning, then stops. This function does not work when the power of the video TV is off.

To pause recording

Press **PAUSE** \parallel .

To resume recording, press **PAUSE** \parallel again.

You can cut out an unwanted scene during recording with this button.

- 1 Press **PAUSE** \parallel when an unwanted scene appears on the screen.
Recording pauses.
- 2 Press **PAUSE** \parallel again to release the pause mode at the desired scene.
Recording resumes from the point set in step 1.

When the recording pause mode lasts for about 5 minutes, the video TV stops recording to protect the quality of video tapes.

Recording with the TV Off

Press \odot .

The TV screen is turned off and the \odot lamp lights up.
The video TV continues recording.

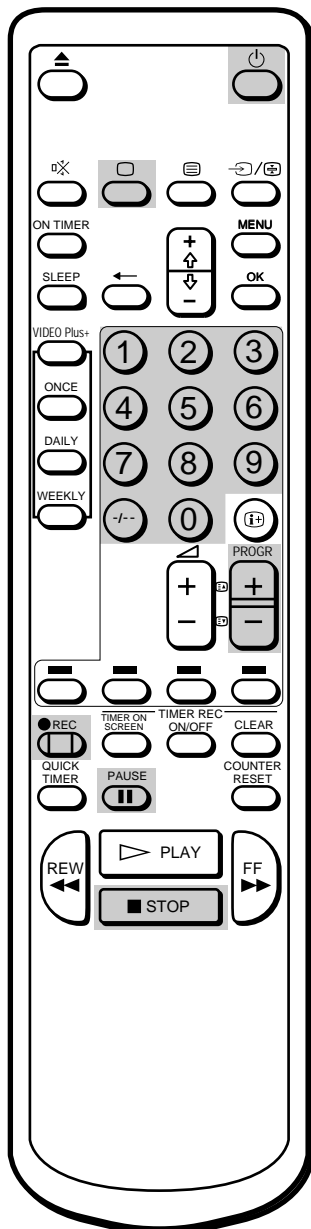

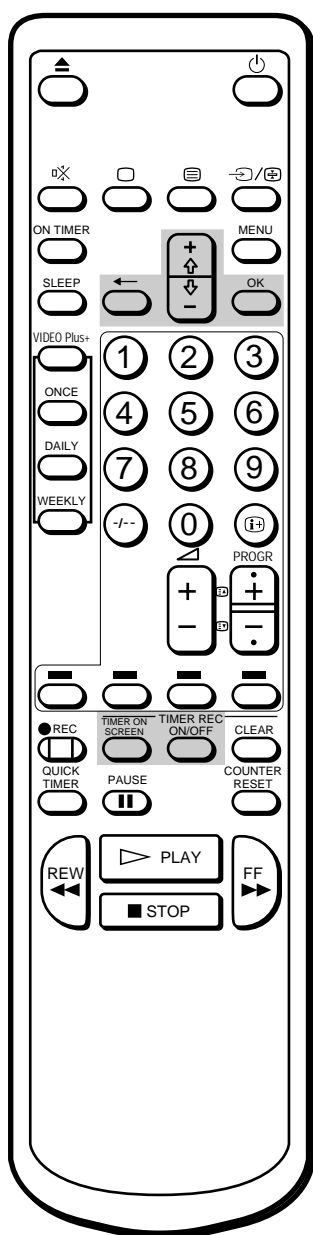

If you have made a mistake during timer setting

Press **←** to go back to the previous position and correct the setting.

If you try to enter the recording start time prior to the current time

All the items of the setting will be erased.

If you try to do incorrect operation

The video TV displays a message on the screen to interrupt your setting.

If you turn the **Ⓢ switch off**

The TIMER REC buttons do not function.

- 5 Press OK, then set the minute of the recording start time to "15" with + **⇧** or - **⇩**.

PROGRAMME LIST				20:00
	PDC	4.	12WED	
DATE	START	STOP	PROG	
6 FRI	20:15	--:--	--	
--	--:--	--:--	--	
--	--:--	--:--	--	
--	--:--	--:--	--	
Select ⇧⇩ and press OK				

- 6 Press OK, then set the hour of the recording stop time to "21" with + **⇧** or - **⇩**.

PROGRAMME LIST				20:00
	PDC	4.	12WED	
DATE	START	STOP	PROG	
6 FRI	20:15	21:--	--	
--	--:--	--:--	--	
--	--:--	--:--	--	
--	--:--	--:--	--	
Select ⇧⇩ and press OK				

- 7 Press OK, then set the minute of the recording stop time to "55" with + **⇧** or - **⇩**.

PROGRAMME LIST				20:00
	PDC	4.	12WED	
DATE	START	STOP	PROG	
6 FRI	20:15	21:55	--	
--	--:--	--:--	--	
--	--:--	--:--	--	
--	--:--	--:--	--	
Select ⇧⇩ and press OK				

- 8 Press OK, then set the programme position to "26" with + **⇧** or - **⇩**.

PROGRAMME LIST				20:00
	PDC	4.	12WED	
DATE	START	STOP	PROG	
6 FRI	20:15	21:55	26	
--	--:--	--:--	--	
--	--:--	--:--	--	
--	--:--	--:--	--	
Select ⇧⇩ and press OK				

- 9 Press OK.
The cursor (**▶**) appears at the left margin.
- 10 When you want to set other programmes, press - **⇩** to move down the cursor to the next line, then repeat steps 2 to 9.
- 11 Press TIMER REC ON/OFF.

The TIMER REC lamp on the front of the video TV lights up and the video TV enters timer recording standby mode.

Press TIMER ON SCREEN to erase the PROGRAMME LIST.

Press **Ⓢ** to turn the video off TV if you do not want to watch the TV.

The video TV turns on automatically and starts recording at the preset start time, and goes off at the preset stop time.

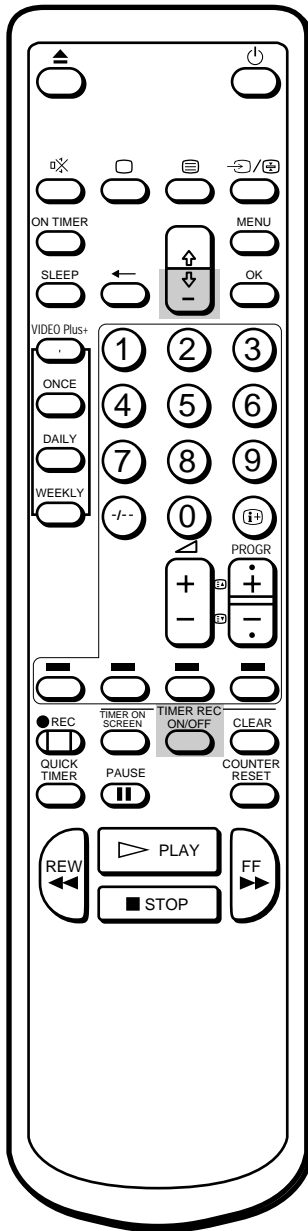

Daily/weekly recording

You can preset your video TV to record the same programme every day of the week (daily recording) or the same programme on the same day every week (weekly recording). Press \downarrow in step 3 until the desired setting appears in the "DATE" position. With each press, the setting changes as follows:

4 (today) \rightarrow MON-SUN \rightarrow MON-SAT \rightarrow MON-FRI \rightarrow EVERY SAT \rightarrow EVERY FRI \rightarrow EVERY THU \rightarrow EVERY WED \rightarrow EVERY TUE \rightarrow EVERY MON \rightarrow EVERY SUN \rightarrow 3 (next month) \rightarrow 2.....

GB

To stop timer recording

Press TIMER REC ON/OFF.
The TIMER REC lamp turns off.

Using the Video TV before Timer Recording Starts

You can watch a TV programme, check the timer settings and reset the counter in timer recording standby mode. However, press TIMER REC ON/OFF to turn off the TIMER REC lamp on the front of the video TV to do the following operations:

- ejecting the cassette
- using the tape operation buttons
- changing or cancelling the timer settings

Remember to press TIMER REC ON/OFF again to make the TIMER REC lamp light after the above operations.

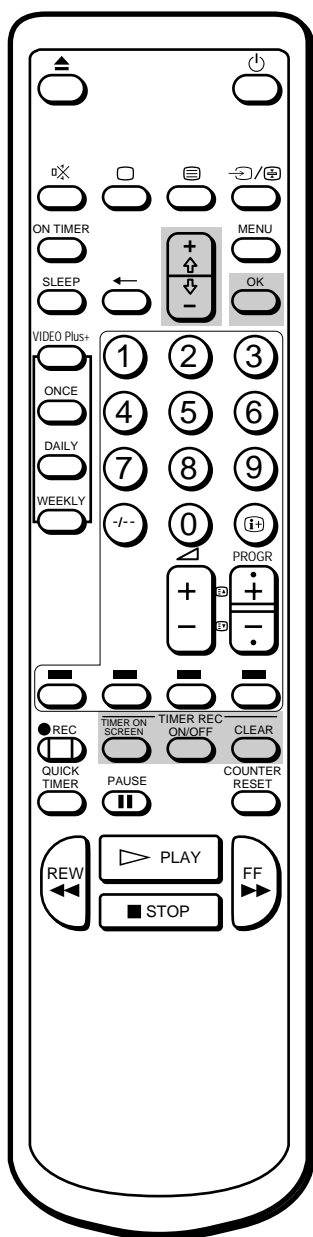

Checking the Timer Settings

You can display the list of the timer settings which you preset.

Press **TIMER ON SCREEN**.

The **PROGRAMME LIST** appears.

DATE	START	STOP	PROG
PROGRAMME LIST	PDC	20:00	4.12WED
6 FRI	20:15	21:55	26
7 SAT	8:30	10:15	50
MON-SAT	23:00	0:00	1
EVERYSUN	9:55	12:30	12
--	--:--	--:--	--
--	--:--	--:--	--

Select \uparrow and press **OK**

Press **TIMER ON SCREEN** again to erase the **PROGRAMME LIST**.

Changing or Canceling the Timer Settings

- 1 Press **TIMER REC ON/OFF** to turn off the **TIMER REC** lamp on the front of the video TV.
- 2 Press **TIMER ON SCREEN** to display the **PROGRAMME LIST**.
- 3 Select the setting you want to change or cancel with $+$ \uparrow or $-$ \downarrow .

DATE	START	STOP	PROG
PROGRAMME LIST	PDC	20:00	4.12WED
6 FRI	20:15	21:55	26
7 SAT	8:30	10:15	50
MON-SAT	23:00	0:00	1
EVERYSUN	9:55	12:30	12
--	--:--	--:--	--
--	--:--	--:--	--

Select \uparrow and press **OK**

4 To change the setting

Using $+$ \uparrow or $-$ \downarrow and **OK**, re-enter all the items.

Refer to "Setting the timer" steps 2 to 9 on pages 23 and 24.

To cancel the setting

Press **TIMER REC CLEAR**.

- 5 Press **TIMER ON SCREEN** to go back to the original screen.
- 6 If there are other timer settings on the list, press **TIMER REC ON/OFF** to set the video TV to timer recording standby mode.

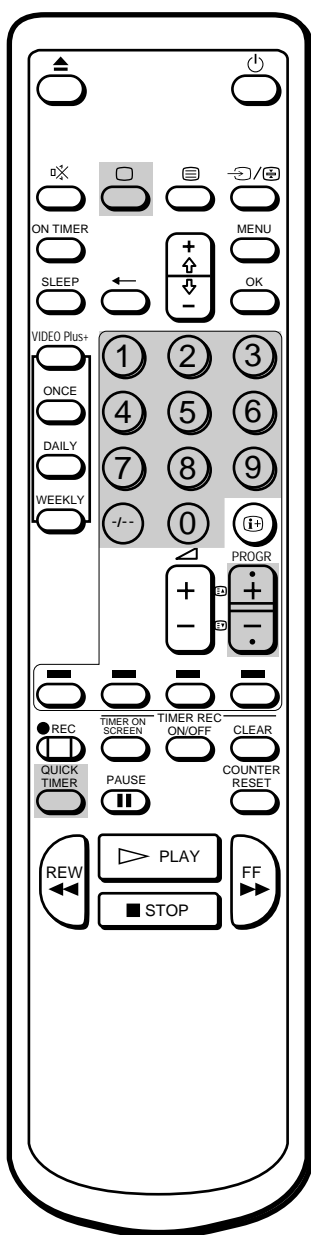

To change the recording time period after quick-timer recording begins

Press QUICK TIMER until the desired time period appears.

To display the remaining time period during quick-timer recording

Press (+). The recording time period decreases minute by minute.

To stop quick-timer recording

Press TIMER REC ON/OFF.

Recording Using the Quick-Timer

You can preset your video TV to start timer recording immediately and to automatically stop recording after a specific time period.

If you have not set the clock, quick-timer recording cannot be done.

GB

If you are recording

- 1 Press QUICK TIMER on the Remote Commander. The "QUICK TIMER 0:00" appears on the screen.
- 2 Press QUICK TIMER repeatedly to select the recording time period. With each press, the time period changes as follows:

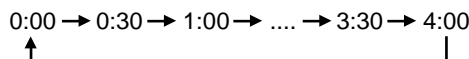

Even if you switch off the video TV, it continues recording. After the selected time period has elapsed, recording stops automatically.

If you are not recording

- 1 Press □, PROGR +/- or number buttons on the Remote Commander, or PROGR +/- on the video TV to switch it on.
- 2 Insert a cassette with its safety tab.
- 3 Select the programme position which you want to record.
- 4 Press QUICK TIMER on the Remote Commander. The "QUICK TIMER 0:00" appears on the screen.
- 5 Press QUICK TIMER repeatedly to select the recording time period. With each press the time period changes as follows:

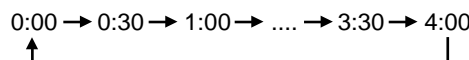

The time period turns yellow and recording starts.

Even if you switch off the video TV, it continues recording.

When the preset time period has elapsed, the video TV stops recording.

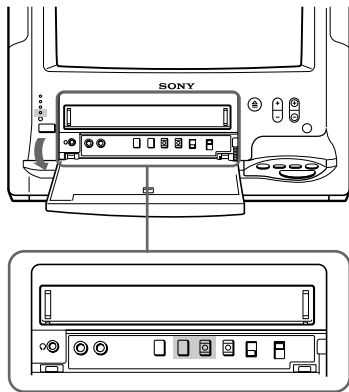

Timer Recording with PDC Signals

The German broadcasting system transmits PDC (Programme Delivery Control) signals with the TV programmes. These signals assure you that your timer recordings are made regardless of broadcast delays, early starts, or broadcast interruptions. For example, if an urgent news bulletin interrupts a regular programme, recording stops. As soon as the interrupted programme resumes, recording starts again.

Notes on PDC recording

- If you use PDC recording while watching the TV, the programme automatically changes to the timer recording programme and you cannot change programmes. Make sure to use PDC recording only when the video/TV set is in standby mode or in power switch off mode. If you watch the TV continuously, cancel the PDC timer recording.
- If recording times overlap due to a PDC time shift, the programme that was broadcast first has priority. Recording of the second programme begins when the first programme has finished.
- If the video TV could not receive a PDC signal because it was too weak or because the station failed to transmit PDC signals, timer recording is made without the PDC function.

- 1** If the TIMER REC lamp is lit on the front panel, press TIMER REC ON/OFF to turn it off.
- 2** Before setting the timer, press PDC on the inside of the front panel so that the PDC lamp lights up.
- 3** Set the timer following the steps in "Setting the timer" (pages 23 and 24).

Recording TV programmes using VIDEO Plus+

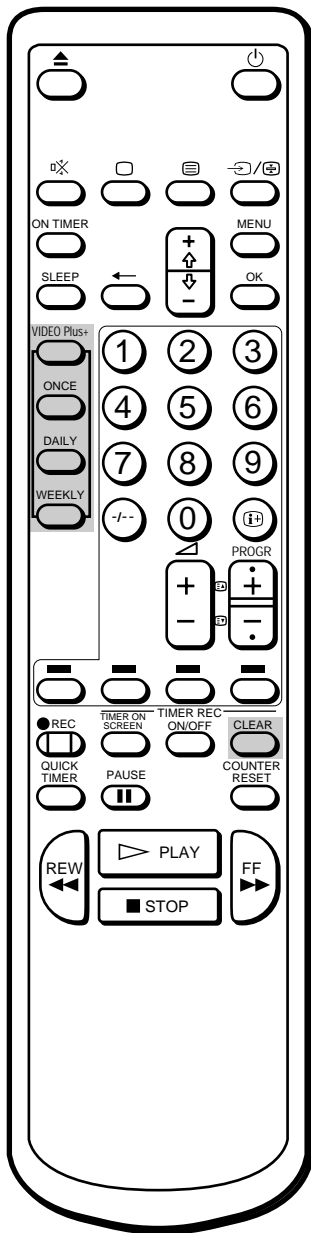

Just enter the programme's "PlusCode" listed in the TV programme guide. The date, times and programme position of that programme are set automatically.

Before you begin

- Press , **PROGR +/-** or a number button on the Remote Commander, or **PROGR +/-** on the video TV to switch on the video TV.
- Make sure that the time and date clock are set correctly. If not, refer to "Setting the clock" on page 14.
- Make sure that the loaded cassette has its safety tab.

GB

- 1 Press **VIDEO Plus+**.
The **SHOWVIEW** menu appears.

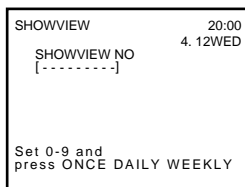

- 2 Press the number buttons to enter the desired programme's PlusCode.

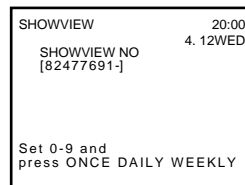

- 3 Press **ONCE**, **DAILY** or **WEEKLY** you want to set.
For each setting, see table below.

To record the programme	Press
Only once	ONCE
Monday to Friday at the same scheduled time	DAILY
Every week at the same scheduled time	WEEKLY

The recording information appears: date, start and stop times, programme position number.

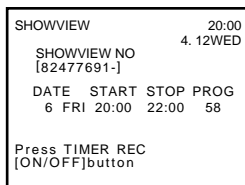

Check that the information is correct. If it is not, press **TIMER CLEAR** to cancel the setting.

If you have made a mistake entering programme's PlusCode

Press **TIMER REC CLEAR** and re-enter the correct number.

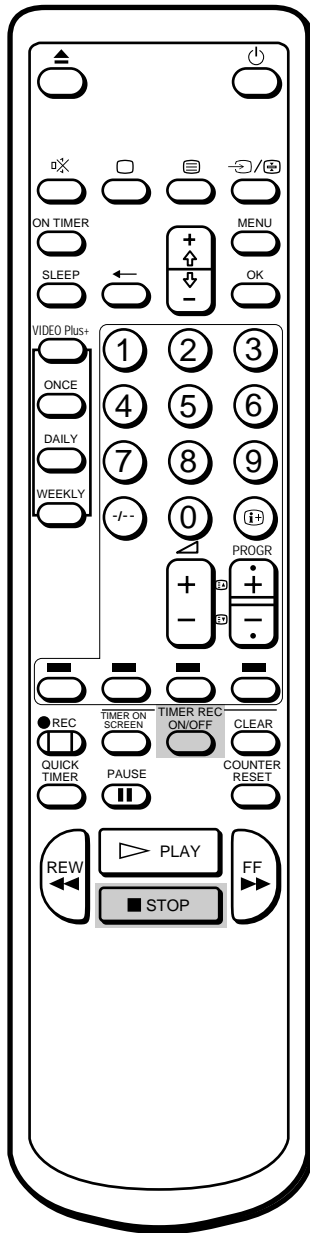

4 Repeat steps 2 and 3 to preset another timer setting.

5 Press **TIMER REC ON**.

The **TIMER REC** lamp on the front of the video TV lights up and the video TV enters timer recording standby mode.

To stop recording

To stop the video TV while recording a programme, press **■STOP**.

Switching off Automatically — Sleep Timer

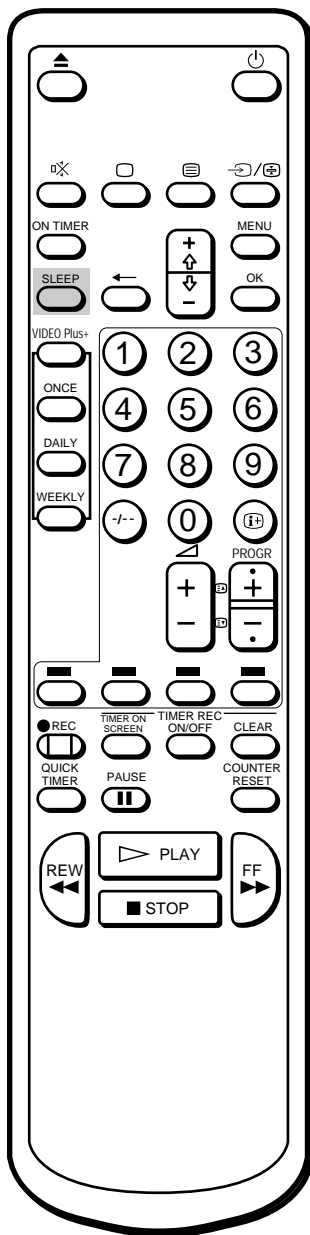

You can automatically switch the video TV into standby mode after a selected time period.

Press SLEEP.

With each press, the time period (in minutes) changes as follows:

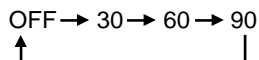

GB

One minute before the TV switches into standby mode, a message “Good night” is displayed on the screen.

To cancel the timer

Press SLEEP to select “OFF”.

Switching on at Your Desired Time — On Timer

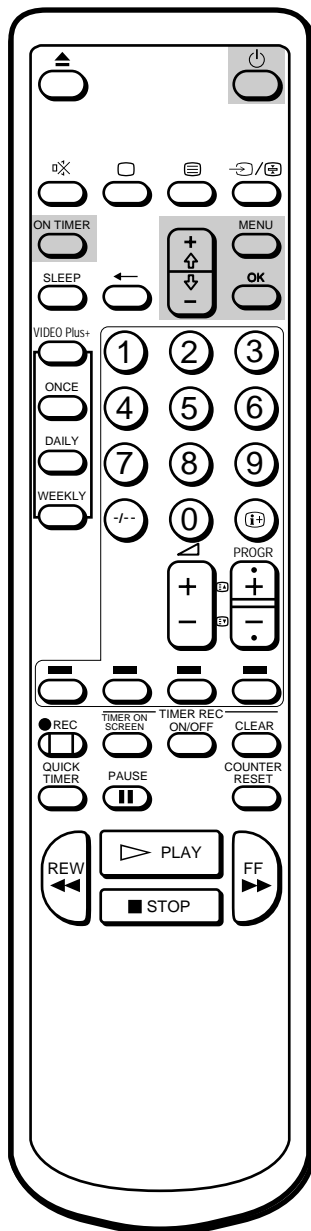

To erase the message

Press any button on the video TV or Remote Commander.









You can preset your video TV to automatically switch on at a desired time. You can select the TV programme or video playback to be switched on.

- 1 Press MENU to display the main menu.
- 2 Move the cursor (▶) to "ON TIMER SET" with + ⬆ or - ⬇ and press OK. The ON TIMER SET menu appears.
- 3 Press OK. The timer setting hour section turns red.
- 4 Set the hour with + ⬆ or - ⬇ and press OK. The minute section turns red.
- 5 Set the minutes (by one minute) with + ⬆ or - ⬇ and press OK. The cursor appears beside "TIME."
- 6 Move the cursor (▶) to "SOURCE" with + ⬆ or - ⬇ and press OK.
- 7 Select TV or VCR (video playback) to be switched on with + ⬆ or - ⬇ and press OK. When you select TV, select the programme position with + ⬆ or - ⬇ and press OK.
- 8 Move the cursor (▶) to "ON TIMER" with + ⬆ or - ⬇ and press OK, then select ON with + ⬆ or - ⬇ and press OK.
- 9 Press MENU to go back to the original screen.
- 10 Press ON TIMER. The ON TIMER lamp on the front of the video TV lights up. If you are not using the video TV, press ⏻ to set the video TV in standby mode.

At the preset time, the video TV automatically switches on and a message "Good morning" is displayed for five minutes.

If you do not press any button for 2 hours, the video TV automatically shuts off.

Troubleshooting

Function	Problems	Possible causes and remedies
TV reception	No picture (screen is dark), no sound	<ul style="list-style-type: none"> The mains lead is disconnected. <ul style="list-style-type: none"> ➔ Connect the mains lead. The video TV is switched off. <ul style="list-style-type: none"> ➔ Press , PROGR +/- or programme number on the Remote Commander, or PROGR +/- on the video TV.
	Good picture but no sound	<ul style="list-style-type: none"> The headphones are connected to  jack. <ul style="list-style-type: none"> ➔ Disconnect the headphones. The  is displayed on the screen. <ul style="list-style-type: none"> ➔ Press . Press  +/-.
	No colour or poor colour (screen is dark) for colour programmes, but good sound.	<ul style="list-style-type: none"> Adjust "CONTRAST," "COLOUR," and "BRIGHTNESS" in the PICTURE CONTROL menu. (page 17)
	No picture, no sound from video input source	<ul style="list-style-type: none"> The connecting cord between the video TV and the input source is disconnected. <ul style="list-style-type: none"> ➔ Connect it firmly. Input is not selected correctly. <ul style="list-style-type: none"> ➔ Press  until the desired input indicator appears. (page 35)
Clock and timer	The clock has stopped and "--/--" is displayed.	<ul style="list-style-type: none"> The power has been interrupted, the  switch is turned off or the mains lead is disconnected for more than a week. <ul style="list-style-type: none"> ➔ Re-set the clock and timer settings if necessary. (pages 14, 23)
	The clock loses or gains.	<ul style="list-style-type: none"> The power has been interrupted, the  switch is turned off or the mains lead is disconnected for less than a week. <ul style="list-style-type: none"> ➔ Re-set the clock and timer settings if necessary. (pages 14, 23)
Playback	Power is on, but the tape does not run.	<ul style="list-style-type: none"> The safety device has been activated. <ul style="list-style-type: none"> ➔ Switch off, disconnect the mains lead, and leave the set for about one minute.
	Poor playback picture	<ul style="list-style-type: none"> The COLOUR SYSTEM switch is set to incorrect position. <ul style="list-style-type: none"> ➔ Set COLOUR SYSTEM to the position corresponding to the colour system with which the tape is recorded. (page 20) Adjust the tracking. (page 33) The video heads are dirty. <ul style="list-style-type: none"> ➔ Clean the heads using the Sony V-25CL video head cleaning tape (page 38). If the cleaning tape is not available in your area, have the heads cleaned at your nearest Sony service facility. (Do not use a commercially available wet-type cleaning tape, as it may damage the video heads.) The tape is worn out. <ul style="list-style-type: none"> ➔ Use a new tape.
	The sound drops out.	<ul style="list-style-type: none"> The tape is defective. <ul style="list-style-type: none"> ➔ Use a new tape.

Function	Problems	Possible causes and remedies
Recording	The cassette is ejected when you press REC ●.	<ul style="list-style-type: none"> • The safety tab of the cassette has been removed. <ul style="list-style-type: none"> ➔ Cover the tab hole with adhesive tape, or use another cassette with a safety tab. (page 19)
	Recording cannot be done.	<ul style="list-style-type: none"> • No cassette has been inserted. <ul style="list-style-type: none"> ➔ Insert a cassette with the safety tab. • The tape is at its end. <ul style="list-style-type: none"> ➔ Rewind the tape.
Timer recording	Timer settings cannot be made.	<ul style="list-style-type: none"> • The clock has not been set. <ul style="list-style-type: none"> ➔ Set the current time and date. (page 14) • You have made a mistake when setting the timer. <ul style="list-style-type: none"> ➔ Check the setting steps. (pages 23 to 25)
	The cassette is ejected when you press TIMER REC ON/OFF.	<ul style="list-style-type: none"> • The safety tab of the cassette has been removed. <ul style="list-style-type: none"> ➔ Cover the tab hole with adhesive tape, or use another cassette with a safety tab.
	The TIMER REC lamp does not light up even though you press TIMER REC ON/OFF.	<ul style="list-style-type: none"> • No cassette has been inserted. <ul style="list-style-type: none"> ➔ Insert a cassette with its safety tab. • The tape is at its end. <ul style="list-style-type: none"> ➔ Rewind the tape. • No setting is made for timer recording. <ul style="list-style-type: none"> ➔ Set the programme for timer recording. (pages 23 to 25)
	Timer recording was not made.	<ul style="list-style-type: none"> • You did not press TIMER REC ON/OFF. • There has been a power interruption lasting more than a week.
Others	A cassette cannot be inserted.	<ul style="list-style-type: none"> • Another cassette is already inserted. <ul style="list-style-type: none"> ➔ Press ▲ to eject the cassette.
	The Remote Commander does not work.	<ul style="list-style-type: none"> • The batteries are low. <ul style="list-style-type: none"> ➔ Replace the batteries. (page 4) • The batteries are installed incorrectly. <ul style="list-style-type: none"> ➔ Install the batteries with correct polarities. (page 4)

Taking Care of Your Video TV

Video Head Cleaning

When playback pictures are noisy and hardly visible, or when no picture appears, the video heads may be contaminated. In such a case, clean the video heads using the V-25CL video head cleaning tape (not supplied), or ask Sony service personnel to clean the video heads, with this service there would be a standard charge.

Symptoms caused by contaminated video heads

- Normal picture
- Rough picture
- Unclear picture
- No picture (or black & white screen appears)

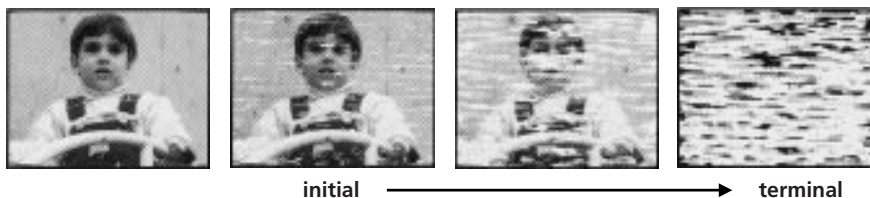

Worn Video Heads

If your video TV displays a poor picture after you clean the video heads, you may need to replace them. Consult your dealer or the Sony Service Center nearest you.

Check the Video Heads after 1,000 Hours of Use

A video TV is a high precision machine. It must record on or play from magnetic tapes on which the image signals from the colour TV or the video camcorder are recorded.

The video heads or mechanical parts for transporting the tape are contaminated or worn after extended use. You should have your video TV checked after each 1,000 hours of use.

Note

Do not use a commercially available wet-type cleaning tape, as it may damage the video heads.

About Moisture Condensation

If the unit is brought directly from a cold place to a warm place, moisture may condense on the video head drum. If this happens, the tape may stick to the head drum and it may be damaged or the unit may not operate correctly. To avoid possible damage caused by moisture condensation, be sure not to leave a cassette inside the compartment when the unit is not in use. When bringing the unit from a cold place to a warm place, wait for about 10 minutes before operating it.

If the tape operation buttons do not work due to moisture condensation, leave the unit for more than one hour with the power on.

Specifications

TV Section

Television system	I
Colour system	PAL
Channel coverage	See "Television channel number guide" at the next page.
Picture tube	Trinitron Approx. 37 cm (14 ⁵ / ₈ inches) (Approx. 34 cm picture measured diagonally)
Aerial in	UHF

Video Section

Format	VHS standard
Video recording system	Rotary 2-head helical scanning system
Audio recording system	Monaural
Video signal	PAL
Tape speed	PAL: 23.39 mm/sec. NTSC (playback only): 33.35 mm/sec.
Maximum recording time	240 minutes with E-240

Inputs and Outputs

Inputs	LINE IN VIDEO: phono jack (1) 1 Vp-p, 75 ohms, unbalanced, sync negative LINE IN AUDIO: phono jack (1) Input level: 500 mVrms (100% modulation) EURO-AV: 21-pin
Output	EURO-AV: 21-pin
Headphones jack	Monaural minijack

General

Clock	Quartz locked
Clock back up	Approx. 7 days
Clock requirements	220-240 V AC, 50 Hz
Power consumption	60 W
Operating temperature	5°C to 40°C (41°F to 104°F)
Storage temperature	-20°C to 60°C (-4°F to 140°F)
Dimensions	Approx. 391 × 409 × 443 mm (w/h/d) (15 ¹ / ₂ × 16 ¹ / ₈ × 17 ¹ / ₂ inches)
Mass	Approx. 15 kg (33 lb 1 oz)

Accessories supplied

Remote Commander (1)
R6 (size AA) batteries (2)
Loop aerial (1)

Design and specifications are subject to change without notice.

Note

This appliance conforms with the EU Directive 89/336/EEC regarding interference suppression.

GB

Television Channel Number Guide

Only the main transmitters are listed. Information regarding the regional sub-relay channel numbers can be obtained by contacting The BBC Engineering Information Dept. (0181) 752 5040.

MAIN TRANSMITTERS	BBC1	BBC2	ITV	CH4
London & South East				
① Bluebell Hill	40	46	43	65
② Crystal Palace	26	33	23	30
③ Dover	50	56	66	53
④ Heathfield	49	52	64	67
⑤ Oxford	57	63	60	53
South-West				
⑥ Beacon Hill	57	63	60	53
⑦ Caradon Hill	22	28	25	32
⑧ Huntshaw Cross	55	62	59	65
⑨ Redruth	51	44	41	47
⑩ Stockland Hill	33	26	23	29
Channel Islands				
⑪ Fremont Point	51	44	41	47
South				
⑫ Hannington	39	45	42	66
⑬ Midhurst	61	55	58	68
⑭ Rowridge	31	24	27	21
West				
⑮ Mendip	58	64	61	54
East				
⑯ Sandy Heath	31	27	24	21
⑰ Sudbury	51	44	41	47
⑱ Tacolneston	62	55	59	65
Midlands (West)				
⑲ Ridge Hill	22	28	25	32
⑳ Sutton Coldfiled	46	40	43	50
㉑ The Wrekin	26	33	23	29
Midlands (East)				
㉒ Waltham	58	64	61	54
Northern Ireland				
㉓ Brougher Mountain	22	28	25	32
㉔ Divis	31	27	24	21
㉕ Limavady	55	62	59	65
North				
㉖ Belmont	22	28	25	32
㉗ Emley Moor	44	51	47	41
North-West				
㉘ Winter Hill	55	62	59	65
North-East				
㉙ Bilsdale West Moor	33	26	29	23
㉚ Caldbeck	30	34	28	32
㉛ Chatton	39	45	49	42
㉜ Pontop Pike	56	64	61	54
Scotland				
㉝ Angus	57	63	60	53
㉞ Black Hill	40	46	43	50
㉟ Sandale	22	67	-	-
㊱ Caldbeck	-	-	28	32
㊲ Craigkelly	31	27	24	21
㊳ Darvel	33	26	23	29
㊴ Durriss	22	28	25	32
㊵ Eitshal (Lewis)	33	26	23	29
㊶ Keelylang Hill	40	46	43	50
㊷ Knock More	33	26	23	29
㊸ Rosemalkie	39	45	49	42
㊹ Rumster Forest	31	27	24	21
㊺ Selkirk	55	62	59	65
Wales				
㊻ Blaenplwyf	31	27	24	21
㊼ Carmel	57	63	60	53
㊽ Llanddona	57	63	60	53
㊾ Moel-y-Parc	52	45	49	42
㊿ Presely	46	40	43	50
① Wenvoe	44	51	41	47

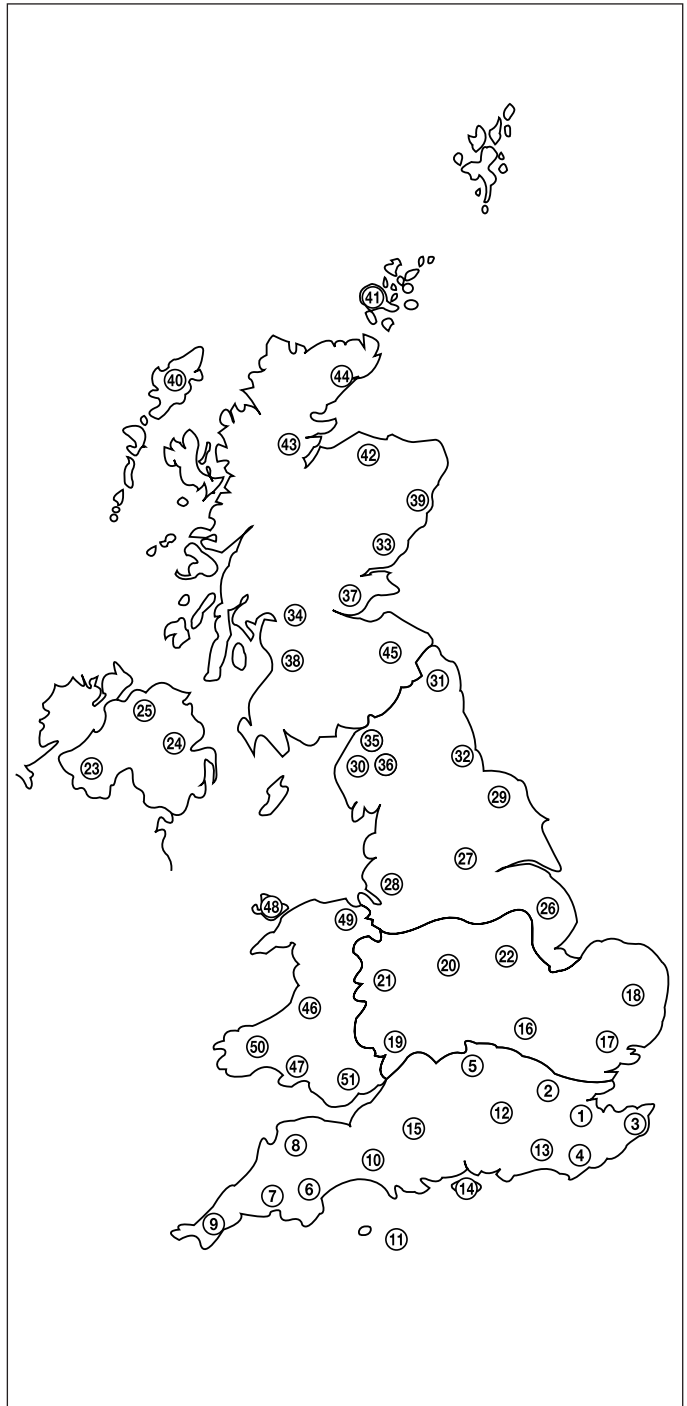

Index to Parts and Controls

Video TV Set—Front

This section briefly describes the buttons and controls on the video TV set and on the Remote Commander. For more information, refer to the pages next to each description.

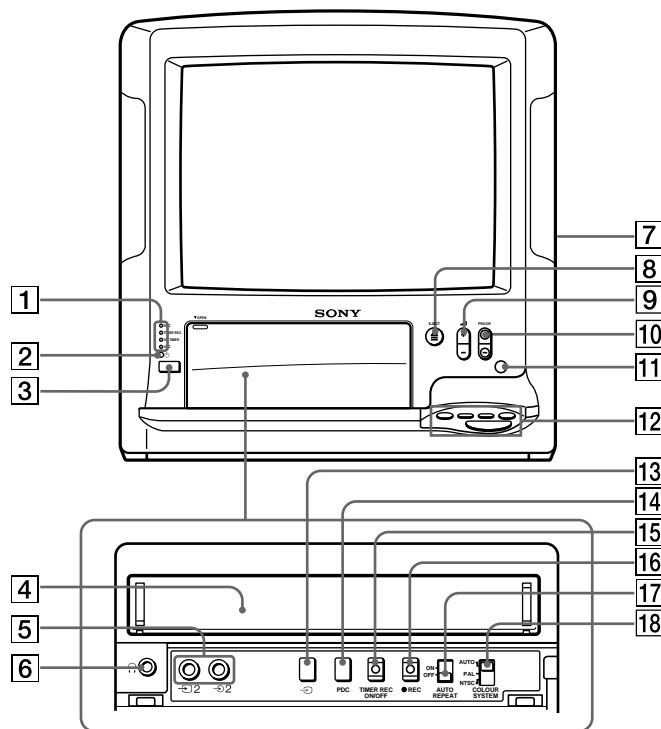

GB

- 1** Lamps
 - REC(recording) (page 22)
 - TIMER REC(recording) (page 24)
 - ON TIMER (page 32)
 - PDC (page 28)
- 2** (standby) lamp (page 15)
- 3** (standby) button (page 15)
- 4** Cassette compartment (page 19)
- 5** (video/audio input) jacks (page 35)
- 6** (headphones) jack (page 18)
- 7** (MAIN POWER) switch (page 15)
- 8** (page 19)
- 9** (volume) +/- buttons (page 15)
- 10** (programme) +/- buttons (page 15)
- 11** Remote sensor
- 12** Tape transport buttons (page 20)
- 13** (input select) button (pages 18, 35)
- 14** PDC button (page 28)
- 15** (page 25, 26)
- 16** (recording) button (page 22)
- 17** (page 21)
- 18** (page 20)

Remote Commander

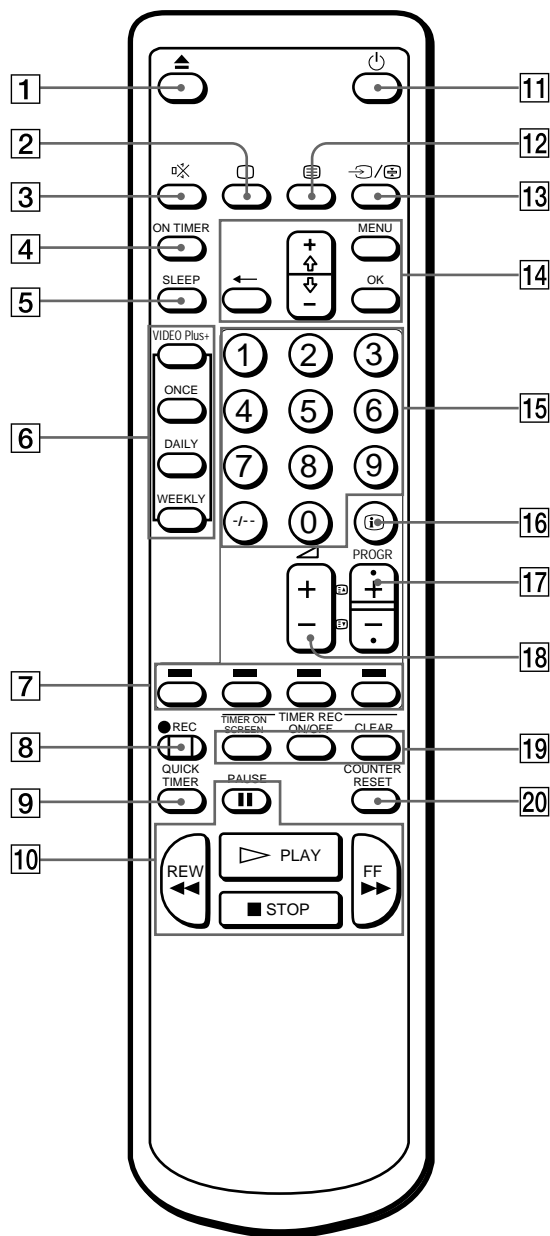

- 1 ▲ (eject)button (page 19)
- 2 □ (TV power on) button (pages 6, 15)
- 3 ✖ (muting) button (page 16)
- 4 ON TIMER button (page 32)
- 5 SLEEP button (page 31)
- 6 VIDEO Plus+ buttons
 - ONCE button (page 29)
 - DAILY button (page 29)
 - WEEKLY button (page 29)
- 7 Teletext operation buttons
The buttons do not function on this video TV.
- 8 REC (recording) ● button (page 22)
- 9 QUICK TIMER button (page 27)
- 10 Tape transport buttons (page 20)
 - ▷ PLAY, ■ STOP, || PAUSE, ◀◀ REW (rewind), ▶▶ FF (fast forward)
- 11 ⏻ (standby) button (page 15)
- 12 ☒ (Teletext) button
The ☒ button does not function on this video TV.
- 13 ↵ (input select)/☒ button (pages 18, 35)
The ☒ button does not function on this video TV.
- 14 Menu operation buttons (pages 6, 7)
 - MENU
 - + ⬆ / - ⬇
 - ←
 - OK
- 15 Number button (page 6, 15)
- 16 ⓘ (on-screen display) button (pages 16, 21)
- 17 PROGR (programme) +/- buttons (page 15)
- 18 ▲ (volume) +/- /Ⓔ/Ⓕ (Teletext page access) buttons (page 15)
The Ⓔ/Ⓕ buttons do not function on this video TV.
- 19 TIMER REC buttons
 - TIMER ON SCREEN (pages 24, 26)
 - ON/OFF (pages 24, 26)
 - CLEAR (page 26, 29)
- 20 COUNTER RESET button (page 21)

SONY KV-14V4U (GB)_3-856-873-11 (1)

Free Manuals Download Website

<http://myh66.com>

<http://usermanuals.us>

<http://www.somanuals.com>

<http://www.4manuals.cc>

<http://www.manual-lib.com>

<http://www.404manual.com>

<http://www.luxmanual.com>

<http://aubethermostatmanual.com>

Golf course search by state

<http://golfingnear.com>

Email search by domain

<http://emailbydomain.com>

Auto manuals search

<http://auto.somanuals.com>

TV manuals search

<http://tv.somanuals.com>