

SONY[®]

3-858-264-11 (1)

KV-14VM5MT

KV-21VM5MT

Operating Instructions **EN**

C

RF

Trinitron Color Video TV



© 1996 by Sony Corporation

WARNING

To prevent fire or shock hazard, do not expose the unit to rain or moisture.

Dangerously high voltages are present inside the set. Do not open the cabinet. Refer servicing to qualified personnel only.

Safety Information

This unit operates on extremely high voltages. To prevent fire or electric shock, please follow the safety procedures below. For your protection, refer all servicing to qualified personnel only.

For general safety:

- Do not expose the unit to rain or moisture.
- Do not open the rear cover.

For safe installation:

- Do not block the ventilation openings.
- Do not install the unit in hot, humid, or excessively dusty places.
- Do not install the unit where it may be exposed to mechanical vibrations.

For safe operations:

- Do not operate the unit on anything but 110–240 V AC.
- Do not operate the unit if any liquid or solid object falls in it—have it checked immediately.
- Unplug the unit from the wall outlet if you do not intend to use it for an extended period of time. To disconnect the cord, pull it out by the plug, never by the cord.

About Moisture Condensation

If the unit is brought directly from a cold place to a warm place, moisture may condense on the video head drum. If this happens, the tape may stick to the head drum and it may be damaged or the unit may not operate correctly. To avoid possible damage caused by moisture condensation, be sure not to leave a cassette inside the compartment when the unit is not in use. When bringing the unit from a cold place to a warm place, wait for about 10 minutes before operating it.

Caution

Television programs, films, video tapes and other materials may be copyrighted.

Unauthorized recording of such materials may be contrary to the provisions of the copyright laws.

Color System of Your Set

This video TV is designed to receive TV programs based on PAL (B/G, I and D/K), SECAM (B/G and D/K) and NTSC (M) color systems and to record and play on PAL, MESECAM and NTSC color systems.

Contents

Getting Started

Step 1—Preparation	4
Checking the supplied accessories	4
Inserting batteries into the Remote Commander	4
Step 2—Installing the video TV	5
Preventing the video TV from falling	5
Step 3—Connecting the antenna	7
Connecting an outdoor antenna	7
Step 4—Tuning in to TV stations	8
Selecting language	8
Presetting channels automatically	9
Presetting channels manually	11
Skipping program positions	12
Captioning a station name	13
Manual fine-tuning	14
Step 5—Setting the clock	15

Basic Operations

Watching the TV	16
Switching the TV on and off	16
Selecting TV programs	16
Adjusting the volume	16
Muting the sound	17
Displaying the on-screen indications	17
Adjusting the picture	17
Watching line input	18
Playing a tape	19
Inserting a video cassette	19
Ejecting a video cassette	19
Protecting your cassette against accidental erasure ...	19
Playing a tape	20
Playing a tape repeatedly (Auto repeat)	22
Displaying the on-screen indications	23
Resetting the tape counter	23
Recording TV programs	24
Recording TV programs	24
Recording with the TV off	24
Recording TV programs using the timer	25
Setting the timer	25
Using the video TV before timer recording starts ..	27
Checking the timer settings	28
Changing or canceling the timer settings	28
Recording using the quick-timer	29

Additional Operations

Switching off automatically—Sleep timer	30
Switching on at your desired time—On timer	31
Searching using the index function	32
Enhancing video picture quality	33
Adjusting the tracking	33
Adjusting with the Adaptive Picture Control (APC)	33
Adjusting with rental picture	33
Connecting optional equipment	34
Watching and recording the picture input from optional equipment	34

Additional Information

Troubleshooting	35
Taking care of your video TV	37
About the auto head cleaner	37
Video head cleaning	37
Worn video heads	37
Check the video heads after 1,000 hours of use ...	37
Specifications	38
Receivable channels and channel display	39
Index to parts and controls	40
Video TV set—front	40
Remote Commander	41

The instructions in this manual are for models, KV-14VM5MT and KV-21VM5MT. Before you start reading, check your model number located at the rear of the video TV. The KV-14VM5MT is the model used for illustration purposes. Any differences in operation are clearly indicated in the text, for example, "KV-21VM5MT only."

Step 1 — Preparation

Checking the Supplied Accessories

When you have taken everything out of the carton, check that you have these items:

- Remote Commander
- Two R6 (size AA) batteries
- Jack cover
- AC plug adaptor
- Band*
- Two clamps*
- Two wood screws*

*KV-21VM5MT only

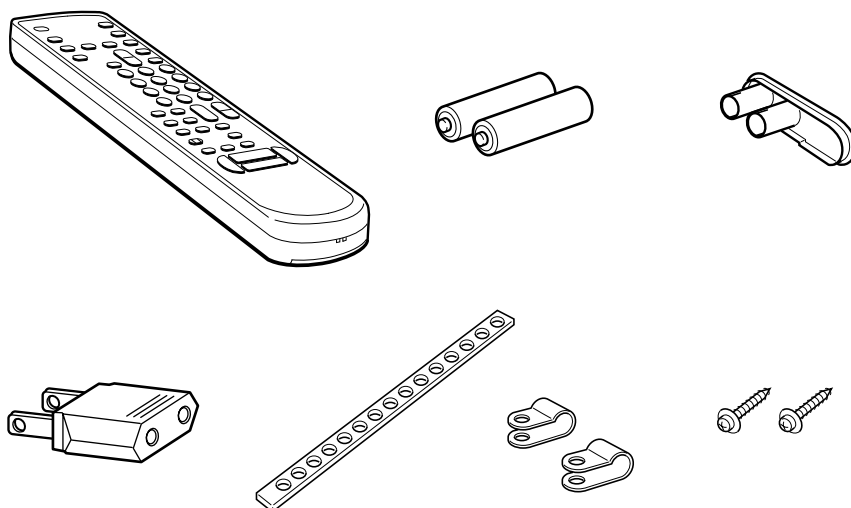

Inserting Batteries into the Remote Commander

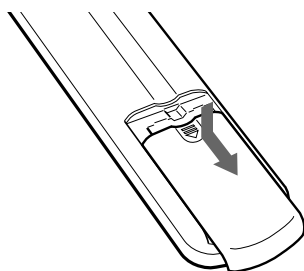

Turn the Commander over, and remove the cover.

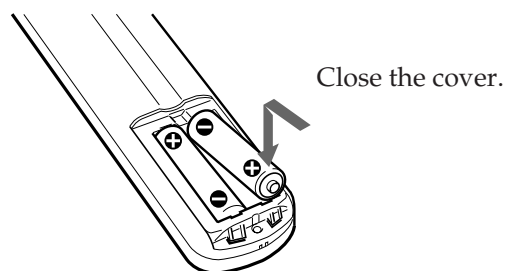

Check the polarities and position two R6 batteries correctly.

Step 2 — Installing the Video TV (KV-21VM5MT only)

Preventing the Video TV from Falling

Because the front is heavier than the back, the video TV may fall if it is not level, or a child pushes or climbs on it. To avoid such an accident, stabilize your video TV with the supplied accessories listed on page 4.

To fasten the video TV to the TV stand

With the supplied wood screws, attach the band to the TV stand and to the rear of the video TV using the hole provided on the video TV.

EN

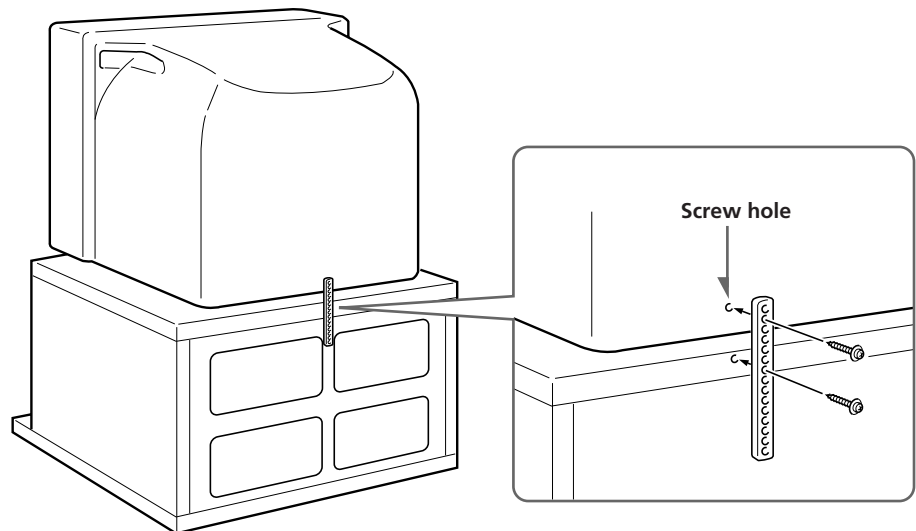

To stabilize the video TV against a wall or pillar

Put the cord or chain (not supplied) through the supplied clamps.

- Using the supplied screws, attach the clamps to the wall and to the screw hole on the video TV.

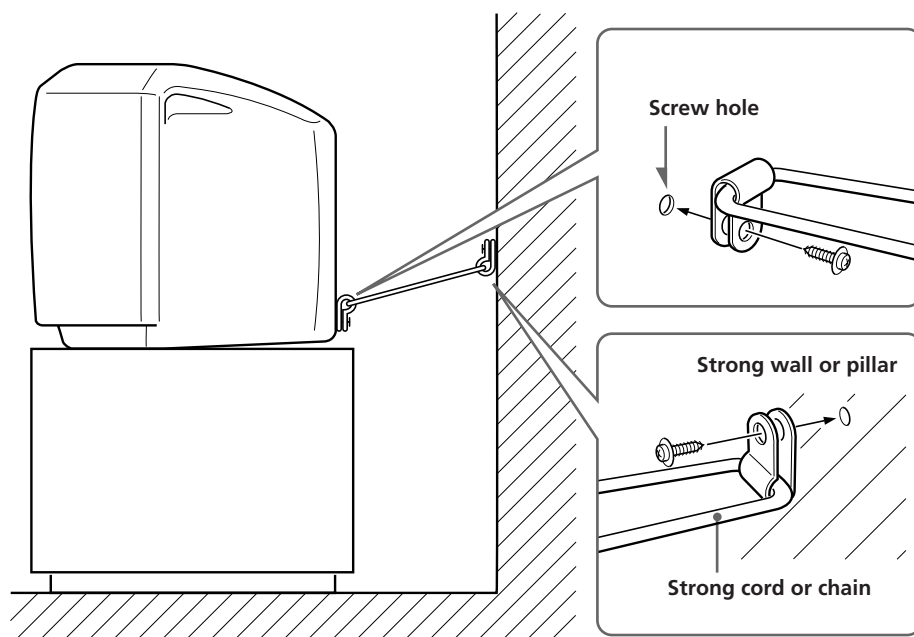

Step 3 — Connecting the Antenna

For better TV reception and recording with clear video picture, connect an outdoor antenna to your video TV.

Connecting an Outdoor Antenna

To connect a VHF antenna or a combination VHF/UHF antenna—75-ohm coaxial cable (round)

EN

Attach an IEC antenna connector to 75-ohm coaxial cable. Plug the connector into the  (antenna) socket of the video TV.

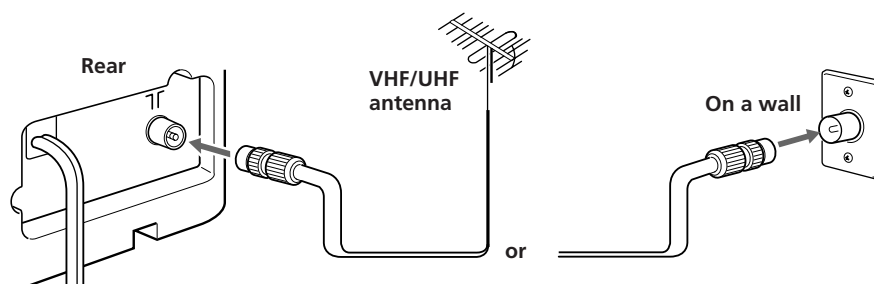

To connect both VHF and UHF antennas

Attach the antenna cable ends to the VHF/UHF mixer (not supplied). Plug the mixer into the  (antenna) socket of the video TV.

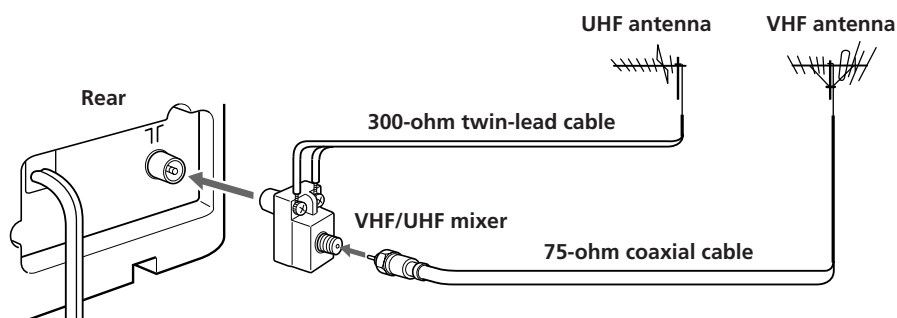

Step 4 — Tuning in to TV Stations

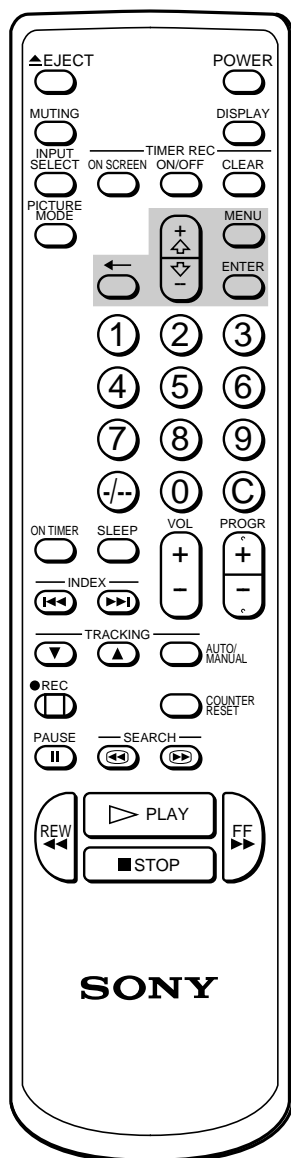

You should preset the channels (up to 80 channels) by choosing either the automatic or manual method.

The automatic method is easier if you want to preset all receivable channels at once. Use the manual method if you want to allocate program numbers to the channels one by one.

Before you begin

- Press the POWER switch on the video TV to switch it on.
If the STANDBY lamp on the video TV is lit in red, press POWER, PROGR +/- or a number button on the Remote Commander.

Selecting Language

You can change the menu and on-screen information language to Chinese.

1 Press MENU.

The main menu appears.

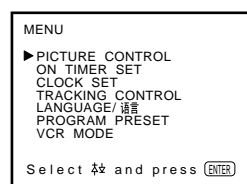

2 Move the cursor (▶) to "LANGUAGE/ 语言" with + ↕ or - ⇩ and press ENTER.

The LANGUAGE/ 语言 menu appears.



3 Move the cursor to "中文" with + ↕ or - ⇩ and press ENTER. The menu appears in Chinese.

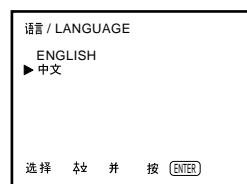

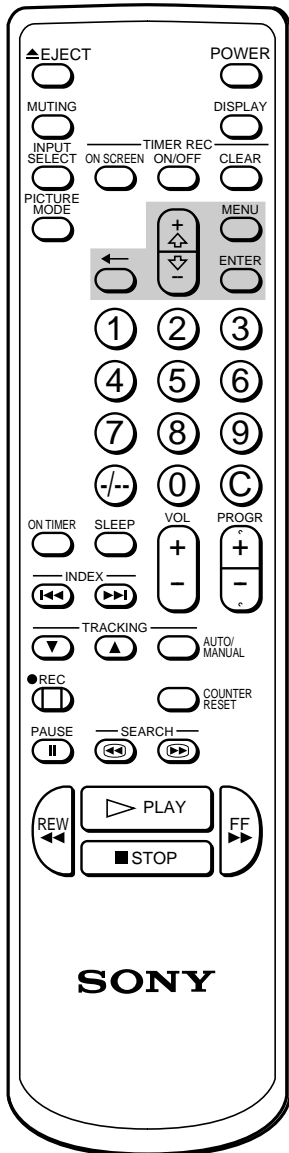

Presetting Channels Automatically

- 1 Press MENU.
The main menu appears.

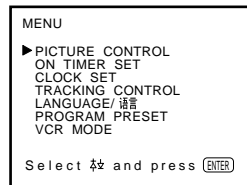

- 2 Move the cursor (▶) to "PROGRAM PRESET" with +⇧ or -⇩ and press ENTER.
The PROGRAM PRESET menu appears.

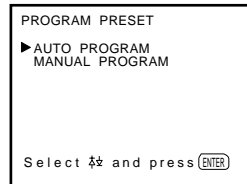

- 3 Move the cursor to "AUTO PROGRAM" with +⇧ or -⇩ and press ENTER.
The AUTO PROGRAM menu appears.

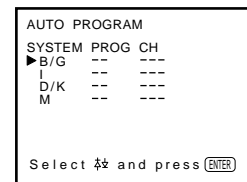

- 4 Using +⇧ or -⇩, move the cursor to the TV system (B/G, I, D/K or M) of the channels which you want to preset, and press ENTER.
Presetting starts from program position 1. The preset program and channel numbers are displayed on the screen in sequence.
When presetting is finished, the channel received before starting automatic presetting appears. All available channels are now stored on successive number buttons.

To stop automatic channel presetting

Press ◀ on the Remote Commander.

EN

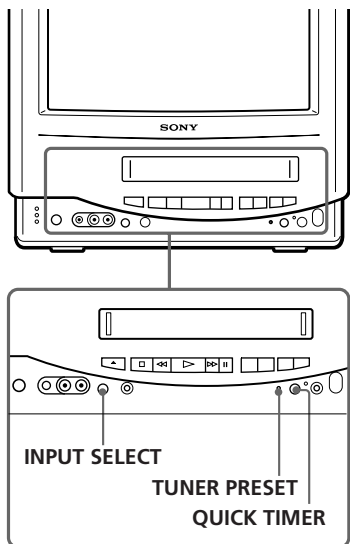

To preset channels automatically using the TUNER PRESET ON/OFF button on the video TV

- 1 Press the POWER switch on the video TV to switch it on.
- 2 Press TUNER PRESET ON/OFF with a pointed object. The following display appears.

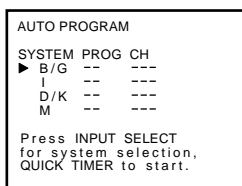

- 3 Press INPUT SELECT on the video TV to select the TV system of the channels which you want to preset.
- 4 Press QUICK TIMER on the video TV. Presetting starts from program position 1. The preset program and channel numbers are displayed on the screen in sequence. When presetting is finished, the channel received before starting automatic presetting appears. All available channels are now stored on successive number buttons.

To stop automatic channel presetting

Press QUICK TIMER on the video TV.

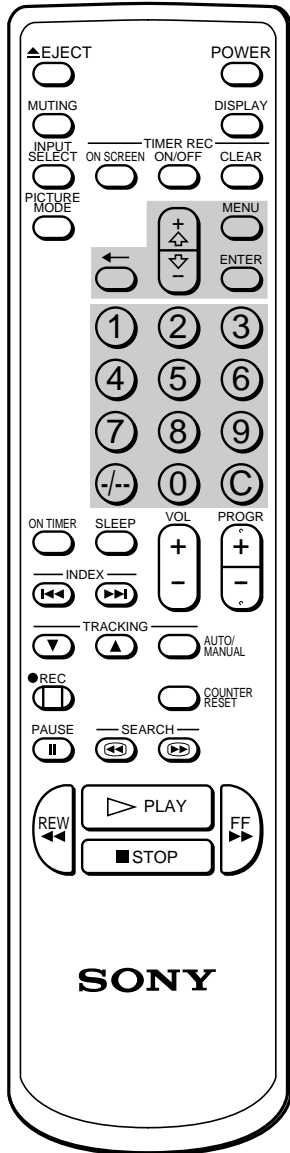

Presetting Channels Manually

- 1 Press MENU to display the main menu.
- 2 Move the cursor (▶) to "PROGRAM PRESET" with +⇧ or -⇩ and press ENTER.

The PROGRAM PRESET menu appears.

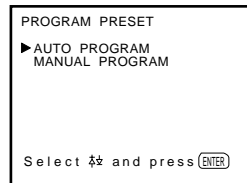

- 3 Move the cursor to "MANUAL PROGRAM" with +⇧ or -⇩ and press ENTER.

The MANUAL PROGRAM menu appears.

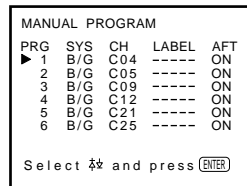

- 4 Using +⇧ or -⇩, move the cursor to the program position (number button) to which you want to preset a channel, and press ENTER.

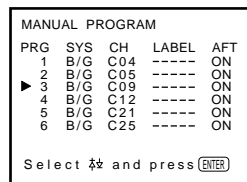

- 5 Select the TV broadcast system (B/G, I, D/K or M) with +⇧ or -⇩, and press ENTER.

The CH number turns red.

- 6 Search for the channel with +⇧ (up) or -⇩ (down).

The channel number starts counting up or downwards. When a channel is found, it stops.

If you want to preset this channel, press ENTER. If not, press +⇧ or -⇩ to search for another channel.

You can also select the channel number directly with the number buttons. Press C (once for regular channels, twice for cable channels), number buttons (e.g. for 06, press 0 and 6), then ENTER.

- 7 Repeat steps 4 to 6 to preset other channels.

- 8 After you finish presetting, press MENU to go back to the original screen.

For program positions beyond 6

The display scrolls by pressing -⇩ repeatedly.

If you have made a mistake

Press ◀ to go back to the previous position.

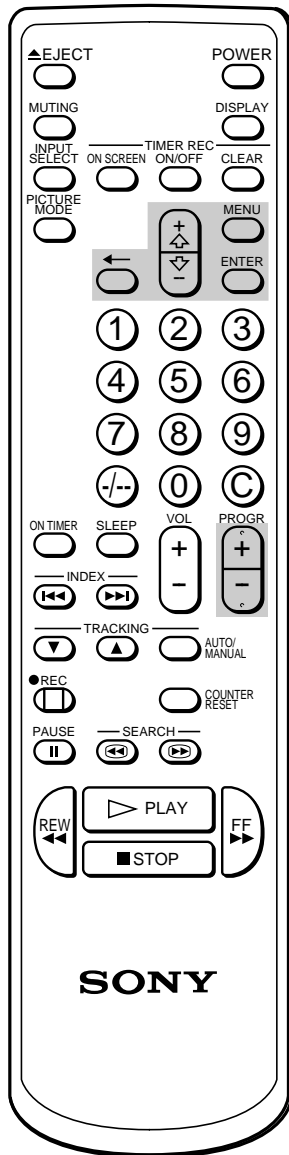

Skipping Program Positions

You can skip unused program positions when selecting program with the PROGR +/- buttons. However, the skipped programs may still be called up when you select them with the number buttons.

- 1 Press MENU to display the main menu.
- 2 Move the cursor (▶) to "PROGRAM PRESET" with +↕ or -↕ and press ENTER.
The PROGRAM PRESET menu appears.
- 3 Move the cursor to "MANUAL PROGRAM" with +↕ or -↕ and press ENTER.
The MANUAL PROGRAM menu appears.
- 4 Using +↕ or -↕, move the cursor to the program position which you want to skip and press ENTER.
The "SYS" position turns red.

MANUAL PROGRAM					
PRG	SYS	CH	LABEL	AFT	
1	B/G	C04	-----	ON	
2	B/G	C05	-----	ON	
▶ 3	B/G	C09	-----	ON	
4	B/G	C12	-----	ON	
5	B/G	C21	-----	ON	
6	B/G	C25	-----	ON	

Select **↕** and press **ENTER**

- 5 Press +↕ or -↕ until "----" appears in the "SYS" position and press ENTER.

MANUAL PROGRAM					
PRG	SYS	CH	LABEL	AFT	
1	B/G	C04	-----	ON	
2	B/G	C05	-----	ON	
▶ 3	---	C09	-----	ON	
4	B/G	C12	-----	ON	
5	B/G	C21	-----	ON	
6	B/G	C25	-----	ON	

Select **↕** and press **ENTER**

When you select programs using the PROGR +/- buttons, the program position is skipped.

- 6 Repeat steps 4 and 5 to skip other program positions.
- 7 Press MENU to go back to the original screen.

For program positions beyond 6

The display scrolls by pressing -↕ repeatedly.

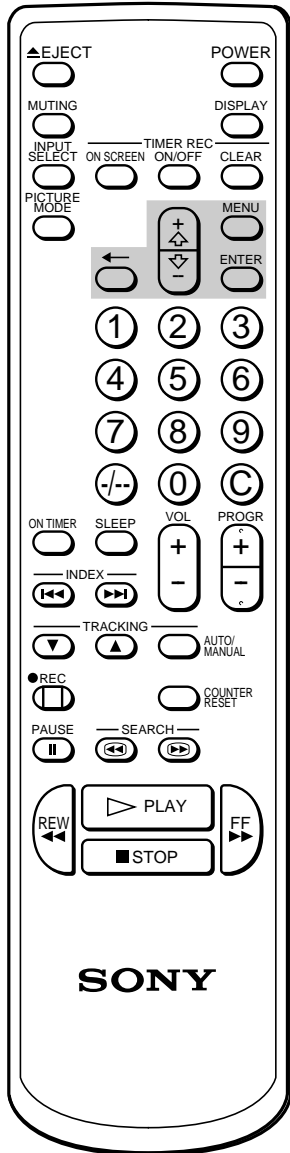

Captioning a Station Name

You can name a channel using up to five characters (letters or numbers) to be displayed on the TV screen (e.g. ABC). Using this function, you can easily identify which channel you are watching.

- 1 Press MENU to display the main menu.
- 2 Move the cursor (▶) to "PROGRAM PRESET" with +⇧ or -⇩ and press ENTER.
The PROGRAM PRESET menu appears.
- 3 Move the cursor to "MANUAL PROGRAM" with +⇧ or -⇩ and press ENTER.
The MANUAL PROGRAM menu appears.

MANUAL PROGRAM				
PRG	SYS	CH	LABEL	AFT
▶ 1	B/G	C04	----	ON
2	B/G	C05	----	ON
3	B/G	C09	----	ON
4	B/G	C12	----	ON
5	B/G	C21	----	ON
6	B/G	C25	----	ON

Select **▶** and press **ENTER**

- 4 Using +⇧ or -⇩, move the cursor to the program position you want to caption and press ENTER repeatedly until the first element of the "LABEL" position turns red.
- 5 Select a letter or number with +⇧ or -⇩ and press ENTER.
The next element turns red. Select other characters in the same way. For the element you want to leave blank, select "--" and press ENTER.

MANUAL PROGRAM				
PRG	SYS	CH	LABEL	AFT
1	B/G	C04	----	ON
2	B/G	C05	----	ON
3	B/G	C09	ABC--	ON
4	B/G	C12	----	ON
5	B/G	C21	----	ON
6	B/G	C25	----	ON

Select **▶** and press **ENTER**

- 6 After selecting all the characters, press ENTER repeatedly until the cursor appears again. Now the caption you chose is stored.
- 7 Repeat steps 4 to 6 to caption other channels.
- 8 Press MENU to go back to the original screen.

If you have made a mistake

Press ◀ to go back to the previous position.

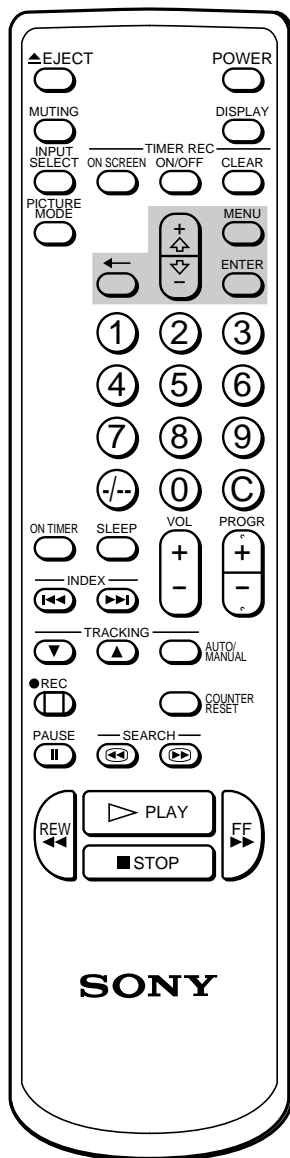

To reactivate automatic fine tuning (AFT)

Repeat from the beginning and select "ON" in step 5.

Manual Fine-Tuning

Normally, the automatic fine-tuning (AFT) is already working. However, if the picture of a program is distorted, you can use the manual fine-tuning function to obtain better picture reception.

- 1 Press MENU to display the main menu.
- 2 Move the cursor (▶) to "PROGRAM PRESET" with +⇧ or -⇩ and press ENTER.
The PROGRAM PRESET menu appears.
- 3 Move the cursor to "MANUAL PROGRAM" with +⇧ or -⇩ and press ENTER.
The MANUAL PROGRAM menu appears.
- 4 Using +⇧ or -⇩, move the cursor to the program position corresponding to the channel which you want to manually fine-tune, and press ENTER repeatedly until the AFT position turns red.

MANUAL PROGRAM				
PRG	SYS	CH	LABEL	AFT
1	B/G	C04	-----	ON
2	B/G	C05	-----	ON
3	B/G	C09	-----	ON
▶ 4	B/G	C12	-----	ON
5	B/G	C21	-----	ON
6	B/G	C25	-----	ON

Select **↔** and press **ENTER**

- 5 Fine-tune the channel with +⇧ or -⇩ so that you get the best TV reception. As you press these buttons, the frequency changes from -15 to +15.

MANUAL PROGRAM				
PRG	SYS	CH	LABEL	AFT
1	B/G	C04	-----	ON
2	B/G	C05	-----	ON
3	B/G	C09	-----	ON
▶ 4	B/G	C12	-----	- 3
5	B/G	C21	-----	ON
6	B/G	C25	-----	ON

Select **↔** and press **ENTER**

- 6 After fine-tuning, press ENTER.
The cursor appears beside the next program position. Now the fine-tuned level is stored.
- 7 Repeat steps 4 to 6 to fine-tune other channels.
- 8 Press MENU to go back to the original screen.

Step 5 — Setting the Clock

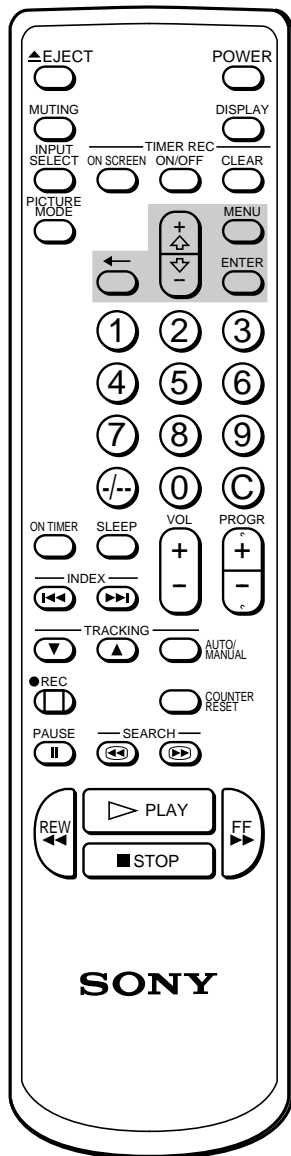

If you have made a mistake

Press **←** to go back to the item to be changed and set the correct digits using **+↕** or **-↕**.

If power is interrupted or you disconnect the AC power cord

You have to re-set the clock.

You need to set the clock for using timer recording, quick-timer recording and on timer functions.

- 1 Press MENU to display the main menu.

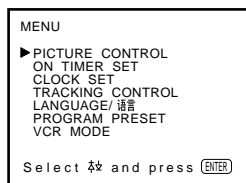

- 2 Move the cursor (▶) to "CLOCK SET" with **+↕** or **-↕** and press ENTER. The CLOCK SET menu appears.

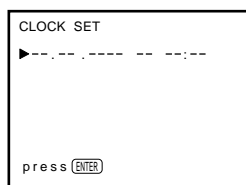

- 3 Press ENTER to start setting the clock. The day section turns red.

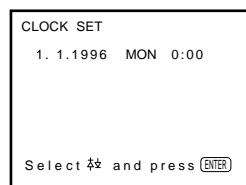

- 4 Set the day with **+↕** or **-↕** and press ENTER. The month section turns red.

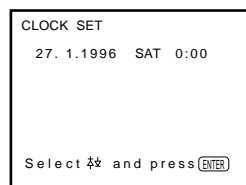

- 5 Using **+↕** or **-↕** and ENTER, set the month, year, hour and minute in the same way as in step 4.

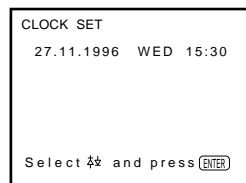

- 6 After setting the minute, press ENTER. The clock starts working.
- 7 Press MENU to go back to the original screen.

EN

Watching the TV

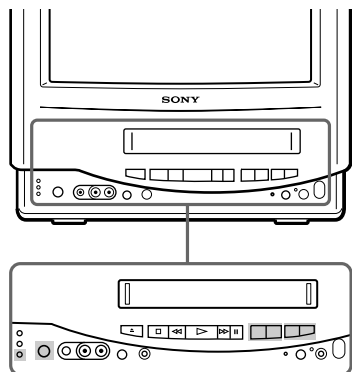

This section explains the basic functions you use while watching the TV. Most of the operations can be done using the Remote Commander.

Switching the TV on and off

Switching on

Press POWER on the video TV.

Switching off

Press POWER on the Remote Commander.

The video TV enters standby mode and the STANDBY lamp on the front of the video TV lights in red.

To switch on again

Press POWER, PROGR +/- or number buttons on the Remote Commander or PROGR +/- on the video TV.

To switch off the main power

Press POWER on the video TV. The STANDBY lamp lights in amber.

Selecting TV Programs

Press PROGR +/- or number buttons on the Remote Commander or PROGR +/- on the video TV.

To select a double-digit number using the number buttons

Press -/-. , then the numbers.

For example, if you want to choose 14, press -/-. , 1 and 4.

Adjusting the Volume

Press VOL +/- on the Remote Commander or VOL +/- on the video TV.

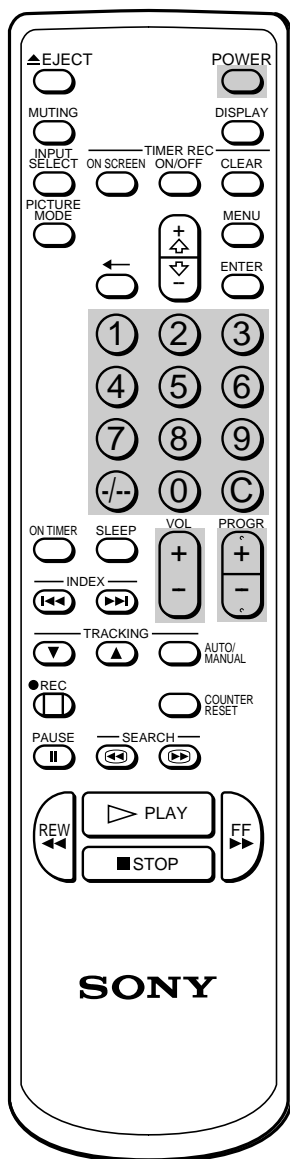

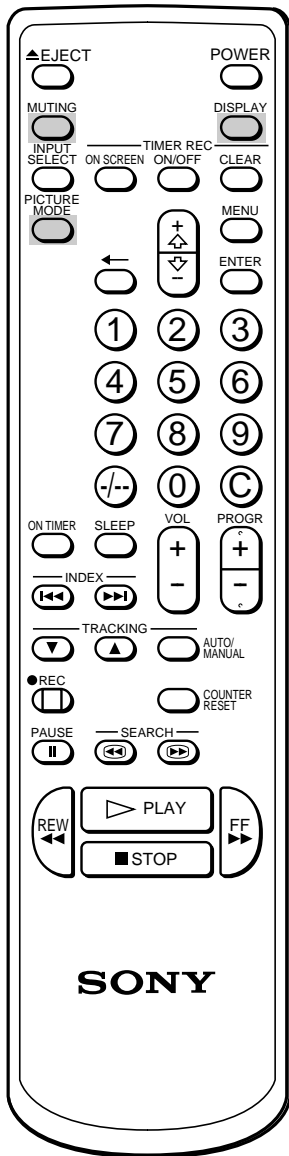

Note

You can adjust the video playback picture and line input picture in the same way.

Muting the Sound

Press MUTING.

The MUTING indicator appears and stays on the screen.

To resume normal sound, press MUTING or VOL +.

Displaying the On-screen Indications

Press DISPLAY to display the following on-screen information.

To have the program number, channel number and caption stay on the screen, press DISPLAY again.

To make the indications disappear, press DISPLAY until no indications are displayed on the screen.

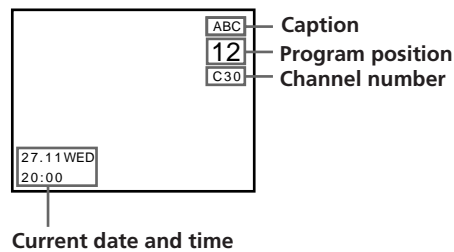

Adjusting the Picture

By pressing the PICTURE MODE button you can select one of four settings for picture effect. You can also adjust the picture to suit your own taste.

Selecting the picture effect

Press PICTURE MODE.

With each press, you can select "DYNAMIC," "MIDDLE," "SOFT" or "PICTURE CONTROL" cyclically.

Effect of each setting

Setting	Picture effect
DYNAMIC	More contrast
MIDDLE	Less contrast
SOFT	Darker e.g. when watching a movie
PICTURE CONTROL	The adjusted picture control levels are stored. (See "Adjusting the picture displayed on the screen.")

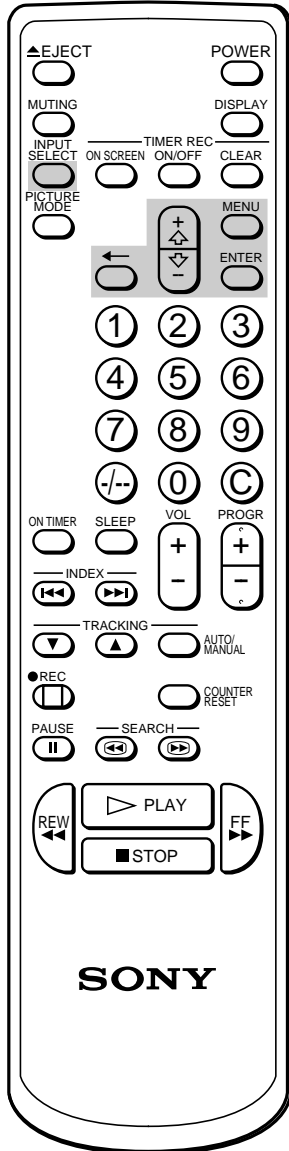

Adjusting the picture displayed on the screen

- 1 Press MENU to display the main menu.
- 2 Move the cursor (▶) to PICTURE CONTROL with +↕ or -↕ and press ENTER.
The PICTURE CONTROL menu appears.

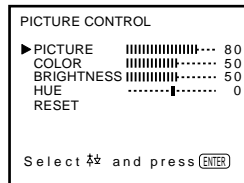

- 3 Using +↕ or -↕, select the item you want to adjust and press ENTER.
- 4 Adjust the picture with +↕ or -↕ and press ENTER.
With each press the vertical bars increase or decrease and the figure at the right margin changes to show the control level. (See the table below.)
- 5 Repeat steps 3 and 4 to adjust other items.
- 6 Press MENU to go back to the original screen.

Effect of each control

PICTURE CONTROL	Effect
PICTURE	Less ██████████ More
COLOR	Less ██████████ More
BRIGHTNESS	Darker ██████████ Brighter
HUE*	Reddish ██████████ Greenish
RESET	Resets all the items to the factory preset levels.

* The HUE adjustment is available only for the NTSC color system.

The adjusted control levels are stored in "PICTURE CONTROL." When you select "PICTURE CONTROL" with PICTURE MODE, you can call up the adjusted levels.

Watching Line Input

Press INPUT SELECT so that "LINE" appears on the screen. To go back to the normal TV picture, press INPUT SELECT so that the program position appears. For details of the line input picture, see page 34.

Playing a Tape

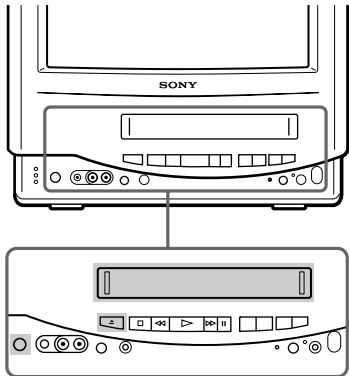

This section shows you how to insert a cassette and to play it. More convenient functions you can use while playing a tape is shown in "Additional Operation."

Inserting a Video Cassette

- 1 Press the POWER switch on the video TV.
- 2 Gently press the center of the front side of a cassette with the arrow indication facing upwards. The cassette is automatically loaded into the cassette compartment.

The  indicator appears on the screen and stays until the cassette has been loaded.

The video TV turns on automatically when it is in standby mode. If you insert a cassette with its safety tab removed, playback starts automatically.

Ejecting a Video Cassette

Press EJECT  on the video TV or the Remote Commander.

The  indicator appears and stays until the cassette is ejected.

You can eject the cassette even if the power is off.

Protecting Your Cassette against Accidental Erasure

The cassette is provided with a safety tab to protect against accidentally erasing a previous recording. Break off the safety tab with a screw driver or a similar tool.

If the safety tab is removed, the cassette is ejected when you try to record on it.

To record on a cassette with the safety tab broken off, simply cover the tab hole with adhesive tape.

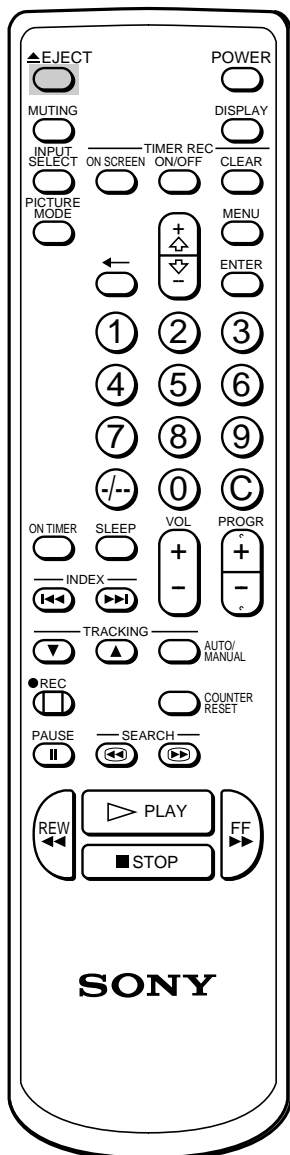
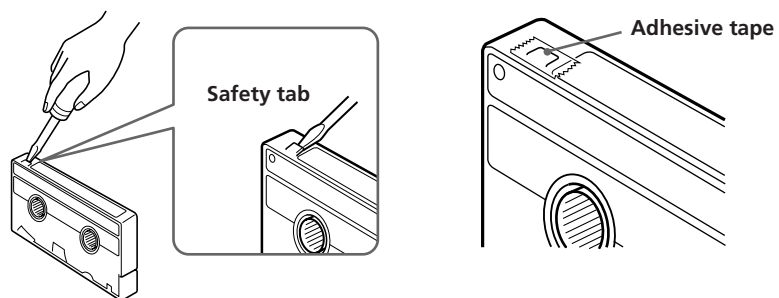

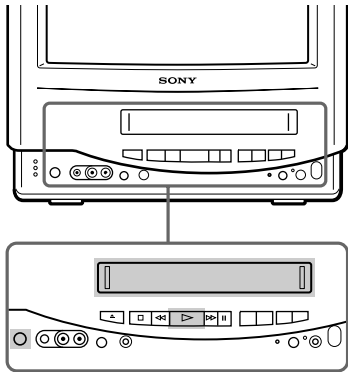

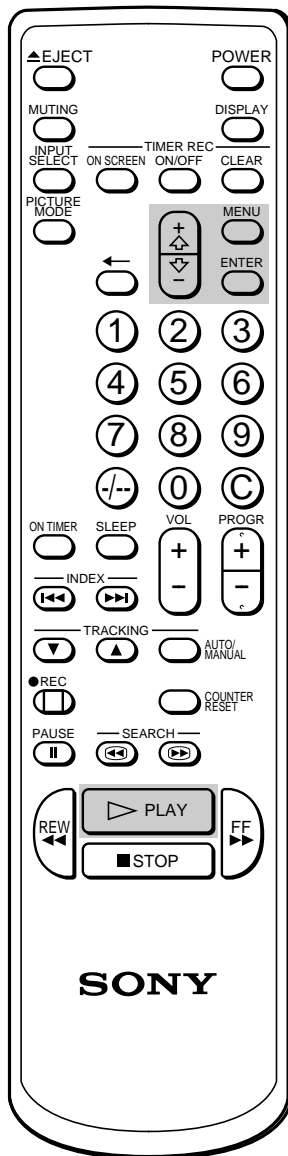

Playing a Tape

- 1 Press POWER on the video TV.
When the STANDBY lamp is lit in red, skip this step.
- 2 Insert a cassette.
If you insert a cassette with its safety tab removed, playback starts automatically.
- 3 Press PLAY .
Playback starts. On-screen information is displayed for some seconds.





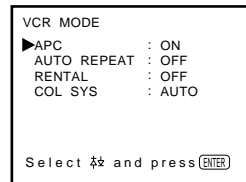

Setting the color system

Normally set the COL SYS (color system) in the menu to AUTO. If streaks appear during playback, set COL SYS to conform to the system that the tape was recorded in.

- 1 Press MENU.
- 2 Move the cursor to "VCR MODE" with +  or - , and press ENTER.



- 3 Move the cursor to "COL SYS" with +  or - , and press ENTER.
- 4 Press +  or -  until the corresponding color system appears, and press ENTER.

PAL/MESECAM: to play a tape that is recorded in PAL or MESECAM color system
NTSC: to play a tape that is recorded in NTSC color system

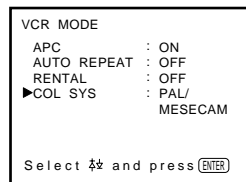

- 5 Press MENU to go back to the original screen.

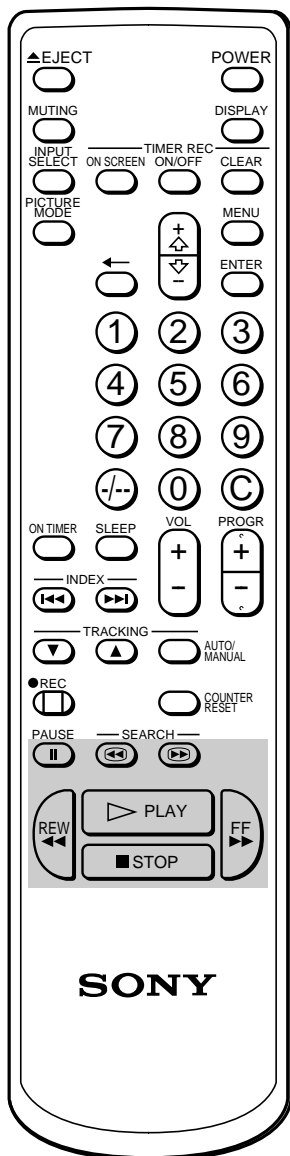

To stop playback

Press STOP ■.

The video TV goes back to the normal TV picture.

To stop playback for a moment

Press PAUSE ||. The picture pauses.

Press PAUSE || again or press PLAY ▷ to resume playback.

If you leave your video TV in pause mode, normal playback resumes after about 5 minutes to protect the quality of video tapes.

To fast-forward the tape

Press STOP ■, then press FF ►►.

To rewind the tape

Press STOP ■, then press REW ◀◀.

To search a tape at high speed

During playback, press SEARCH ◀ (rewind) or SEARCH ▶ (fast-forward).

A high-speed picture appears on the TV screen.

To resume normal playback, press PLAY ▷.

To view the picture in fast-forward or rewind mode

Press and hold FF ►► during fast-forward or REW ◀◀ during rewind.

While you hold the button, you can view the picture.

When you release the button, fast-forward or rewind mode is resumed.

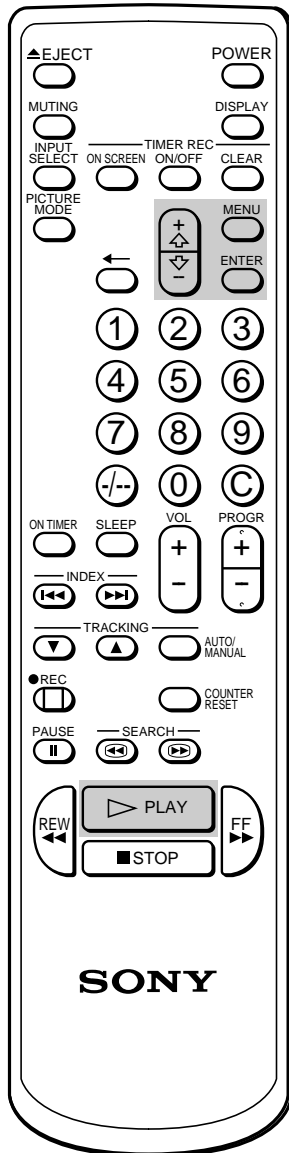

Playing a Tape Repeatedly (Auto Repeat)

You can play the recorded portion of the tape repeatedly.

- 1 Press MENU.
- 2 Move the cursor to "VCR MODE" with + ↕ or - ↕, and press ENTER.

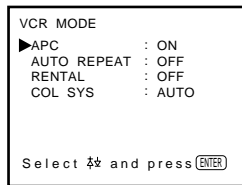

- 3 Move the cursor to "AUTO REPEAT" with + ↕ or - ↕, and press ENTER.
- 4 Press + ↕ or - ↕ to select "ON".

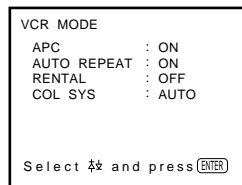

- 5 Press PLAY ▷. Playback starts. When the tape reaches the end, the video TV rewinds the tape to the beginning, then plays it.

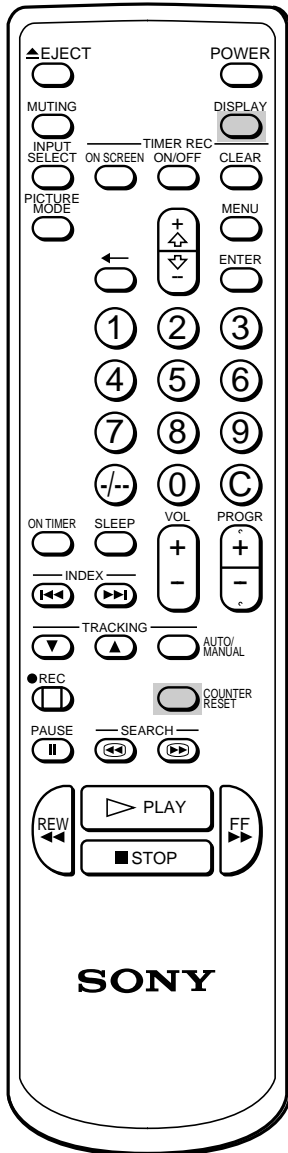

Displaying the on-Screen Indications

Press DISPLAY to display the following on-screen information. To show only the amount of tape remaining and linear tape counter on the screen, press DISPLAY again.

To make the indications disappear, press DISPLAY until no indications are displayed on the screen.

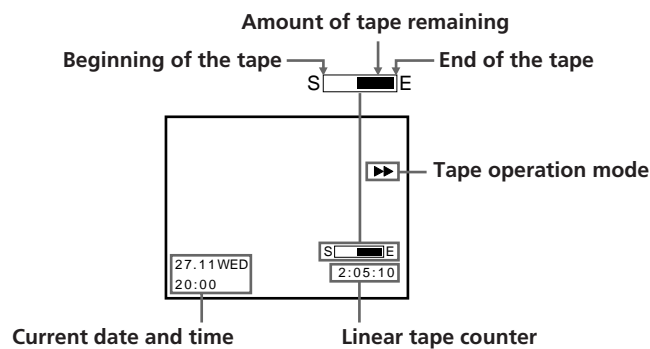

Resetting the Tape Counter

The tape counter helps you to locate a certain scene after playback. Press COUNTER RESET on the Remote Commander to set the counter to "0:00:00" before playing the tape. The tape counter is automatically reset to zero whenever a cassette is inserted. The video TV keeps counting the length of the tape being played. Note, however, that the tape counter does not count the portions without video signals recorded.

Note

The tape operation mode is displayed whenever you change the mode (even when the DISPLAY is turned off).

Recording TV Programs

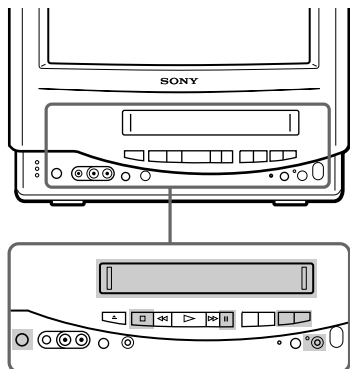

Recording TV Programs

- 1 Press POWER on the video TV.
When the STANDBY lamp is lit in red, skip this step.
- 2 Insert a cassette with a safety tab.
- 3 Select the program position with PROGR+/- . You can also use number buttons on the Remote Commander. For double-digit numbers (e.g.14), first press -/-, then press 1 and 4.
- 4 Press REC ● .
The REC lamp lights up and recording begins.

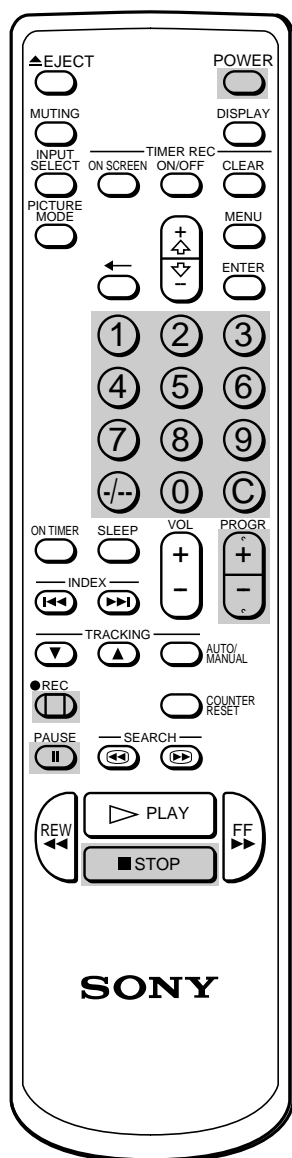

To stop recording

Press STOP ■.

When the tape reaches the end, the video TV rewinds the tape automatically to the beginning, then stops. This function does not work when the power of the video TV is off.

To pause recording

Press PAUSE ■■.

To resume recording, press PAUSE ■■ again.

You can cut out an unwanted scene during recording with this button.

- 1 Press PAUSE ■■ when an unwanted scene appears on the screen.
Recording pauses.
- 2 Press PAUSE ■■ again to release the pause mode at the desired scene.
Recording resumes from the point set in step 1.

When the recording pause mode lasts for about 5 minutes, the video TV stops recording to protect the quality of video tapes.

Recording with the TV Off

Press POWER on the Remote Commander or the video TV.
The video TV is turned off and the STANDBY lamp lights up.
The video TV continues recording.

Recording TV Programs Using the Timer

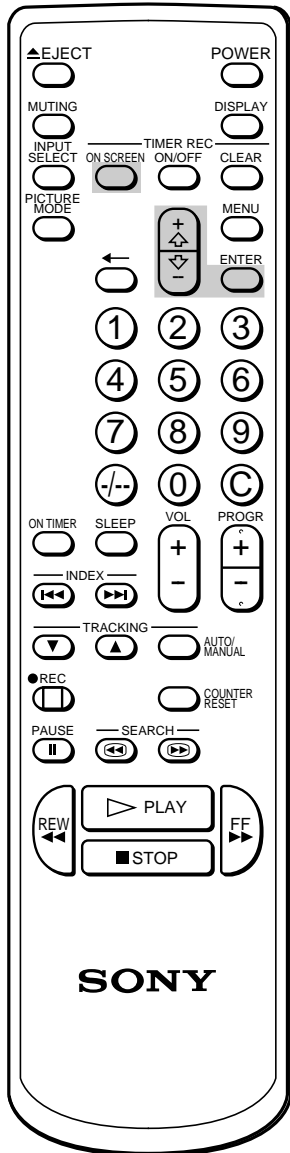

The Timer Recording function allows you to preset your video TV to record up to six programs within a one-month period.

Before you begin

- Switch on the video TV.
- Make sure that the clock is set correctly. If not, see "Setting the clock" on page 15.
- Make sure that the loaded cassette has its safety tab.

EN

Setting the Timer

Example: Here is how to record a program broadcast on program position 11 from 20:15 to 21:55 on Wednesday, 27th November 1996.

- 1 Press **TIMER ON SCREEN**.
The **PROGRAM LIST** appears.

PROGRAM LIST	20:00		
DATE	START	STOP	PROG
24.11 SUN	--:--	--:--	--
--	--:--	--:--	--
--	--:--	--:--	--
--	--:--	--:--	--
--	--:--	--:--	--

Select **↔** and press **ENTER**

- 2 Press **ENTER**.
Today's date colored red appears.

- 3 Press **+↕** until "27 WED" appears.
For daily and weekly recording see "Daily/weekly recording" on page 27.

PROGRAM LIST	20:00		
DATE	START	STOP	PROG
24.11 SUN	--:--	--:--	--
27 WED	--:--	--:--	--
--	--:--	--:--	--
--	--:--	--:--	--
--	--:--	--:--	--

Select **↔** and press **ENTER**

- 4 Press **ENTER**, then set the hour of the recording start time to "20" with **+↕** or **-↕**.

PROGRAM LIST	20:00		
DATE	START	STOP	PROG
24.11 SUN	--:--	--:--	--
27 WED	20:--	--:--	--
--	--:--	--:--	--
--	--:--	--:--	--
--	--:--	--:--	--

Select **↔** and press **ENTER**

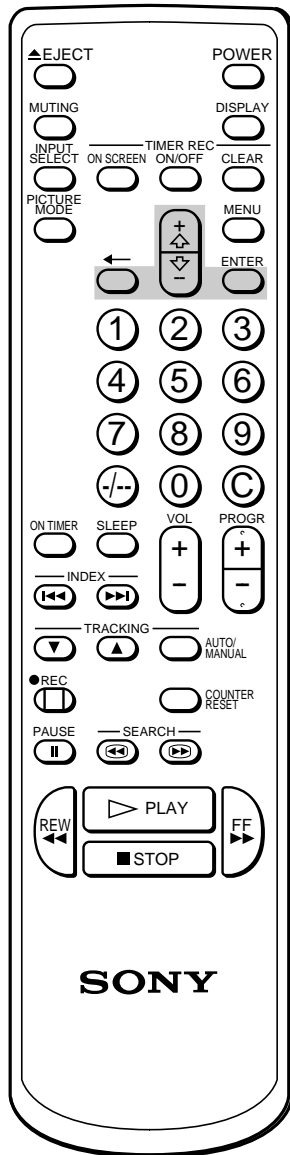

If you have made a mistake during timer setting

Press **←** to go back to the previous position and correct the setting.

If you try to enter the recording start time prior to the current time

All the items of the setting will be erased.

If you try to do incorrect operation

The video TV displays a message on screen to interrupt your setting.

- 5** Press ENTER, then set the minute of the recording start time to “15” with +**↕** or -**↕**.

PROGRAM LIST	20:00		
DATE	START	STOP	PROG
27 WED	20:15	--:--	--
--	--:--	--:--	--
--	--:--	--:--	--
--	--:--	--:--	--

Select **↔** and press **ENTER**

- 6** Press ENTER, then set the hour of the recording stop time to “21” with +**↕** or -**↕**.

PROGRAM LIST	20:00		
DATE	START	STOP	PROG
27 WED	20:15	21:--	--
--	--:--	--:--	--
--	--:--	--:--	--
--	--:--	--:--	--

Select **↔** and press **ENTER**

- 7** Press ENTER, then set the minute of the recording stop time to “55” with +**↕** or -**↕**.

PROGRAM LIST	20:00		
DATE	START	STOP	PROG
27 WED	20:15	21:55	--
--	--:--	--:--	--
--	--:--	--:--	--
--	--:--	--:--	--

Select **↔** and press **ENTER**

- 8** Press ENTER, then set the program position to “11” with +**↕** or -**↕**.

PROGRAM LIST	20:00		
DATE	START	STOP	PROG
27 WED	20:15	21:55	11
--	--:--	--:--	--
--	--:--	--:--	--
--	--:--	--:--	--

Select **↔** and press **ENTER**

- 9** Press ENTER.
The cursor (**▶**) appears at the left margin.

PROGRAM LIST	20:00		
DATE	START	STOP	PROG
▶ 27 WED	20:15	21:55	11
--	--:--	--:--	--
--	--:--	--:--	--
--	--:--	--:--	--

Select **↔** and press **ENTER**

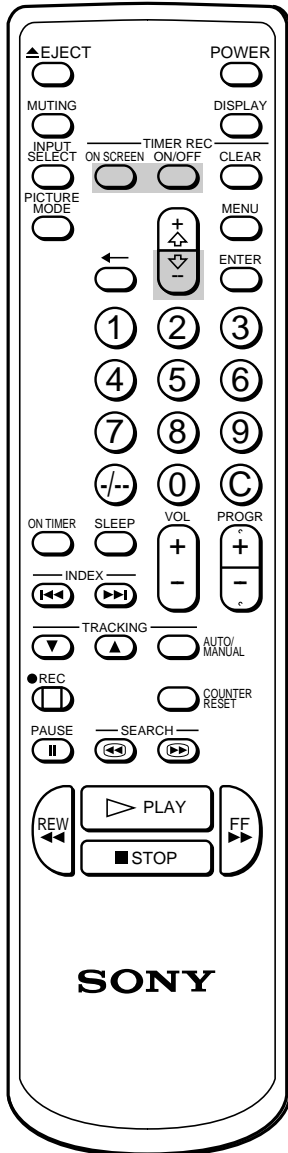

10 When you want to set other programs, press \downarrow to move down the cursor to the next column, then repeat steps 2 to 9.

11 Press **TIMER REC ON/OFF**.
The **TIMER REC** lamp on the front of the video TV lights up and the video TV enters timer recording standby mode.

Press **TIMER ON SCREEN** to erase the **PROGRAM LIST**.
Turn off the video TV if you do not want to watch the TV.
The video TV starts recording at the preset start time.

EN

Daily/weekly recording

You can preset your video TV to record the same program every day of the week (daily recording) or the same program on the same day every week (weekly recording). Press \downarrow in step 3 until the desired setting appears in the "DATE" position. With each press, the setting changes as follows:

24 (today) \rightarrow MON-SUN \rightarrow MON-SAT \rightarrow MON-FRI \rightarrow EVERY SAT \rightarrow EVERY FRI \rightarrow EVERY THU \rightarrow EVERY WED \rightarrow EVERY TUE \rightarrow EVERY MON \rightarrow EVERY SUN \rightarrow 23 (next month) \rightarrow 22.....

To stop timer recording

Press **TIMER REC ON/OFF**.

Using the Video TV before Timer Recording Starts

You can watch a TV program, check the timer settings and reset the counter in timer recording standby mode. However, press **TIMER REC ON/OFF** to turn off the **TIMER REC** lamp on the front of the video TV to do the following operations:

- ejecting the cassette
- using the tape operation buttons
- changing or canceling the timer settings

Remember to press **TIMER REC ON/OFF** again to make the **TIMER REC** lamp light after the above operations.

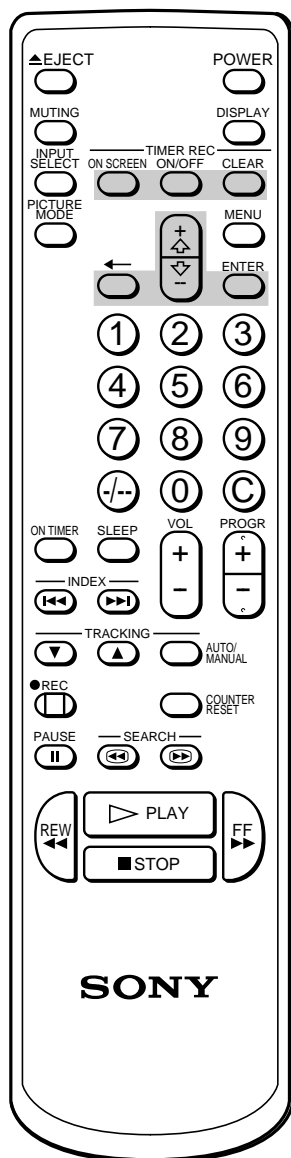

Checking the Timer Settings

You can display the list of the timer settings which you preset.

Press **TIMER ON SCREEN**.

The **PROGRAM LIST** appears.

DATE	START	STOP	PROG
▶27 WED	20:15	21:55	11
7 SAT	8:30	10:15	50
MON-SAT	23:00	0:00	01
EVERY SUN	9:55	12:30	10
--	--:--	--:--	--
--	--:--	--:--	--

Select **⌘** and press **ENTER**

Press **TIMER ON SCREEN** again to erase the **PROGRAM LIST**.

Changing or Canceling the Timer Settings

- 1 Press **TIMER REC ON/OFF** to turn off the **TIMER REC** lamp on the front of the video TV.
- 2 Press **TIMER ON SCREEN** to display the **PROGRAM LIST**.
- 3 Select the setting you want to change or cancel with **+↕** or **-↕**.

DATE	START	STOP	PROG
▶27 WED	20:15	21:55	11
7 SAT	8:30	10:15	50
MON-SAT	23:00	0:00	01
EVERY SUN	9:55	12:30	10
--	--:--	--:--	--
--	--:--	--:--	--

Select **⌘** and press **ENTER**

- 4 **To change the setting**
Using **+↕** or **-↕** and **ENTER**, re-enter all the items.
Refer to "Setting the timer" steps 2 to 9 on pages 25 and 26.

To cancel the setting

Press **TIMER REC CLEAR**.

- 5 Press **TIMER ON SCREEN** to go back to the original screen.
- 6 If there are other timer settings on the list, press **TIMER REC ON/OFF** to set the video TV to timer recording standby mode.

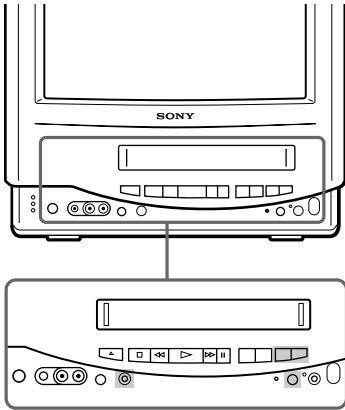

Recording Using the Quick-Timer

You can have your video TV start timer recording immediately and automatically stop recording after a specific time period.

Before you begin

- Switch on the video TV.
- Make sure that the clock is set correctly. If not, see "Setting the clock" on page 15.
- Make sure that the loaded cassette has its safety tab.

If you are recording

- 1 Press QUICK TIMER on the video TV.
The "QUICK TIMER 0:00" appears on the screen.
- 2 Press QUICK TIMER repeatedly to select the recording time period. With each press, the time period changes as follows:

0:00 → 0:30 → 1:00 → → 3:30 → 4:00

Even if you switch off the video TV, it continues recording.
After the selected time period has elapsed, recording stops automatically.

If you are not recording

- 1 Switch on the video TV.
- 2 Insert a cassette with its safety tab.
- 3 Select the program position which you want to record.
- 4 Press QUICK TIMER on the video TV.
The "QUICK TIMER 0:00" appears on the screen.
- 5 Press QUICK TIMER repeatedly to select the recording time period. With each press the time period changes as follows:

0:00 → 0:30 → 1:00 → → 3:30 → 4:00

The time period turns yellow and recording starts.
Even if you switch off the video TV, it continues recording.
After the selected time period has elapsed, recording stops automatically.

To change the recording time period after quick-timer recording begins

Press QUICK TIMER until the desired time period appears.

To display the remaining time period during quick-timer recording

Press DISPLAY on the Remote Commander. The recording time period decreases minute by minute.

To stop quick-timer recording

Press TIMER REC ON/OFF.

Switching off Automatically — Sleep Timer

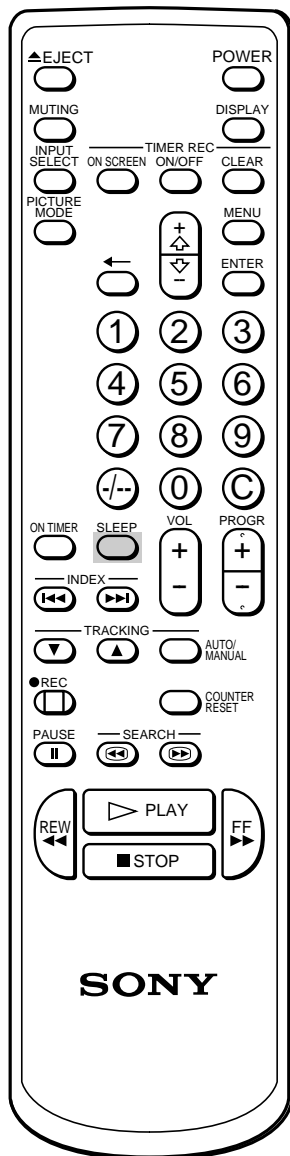

You can automatically switch the video TV into standby mode after a selected time period.

Press SLEEP.

With each press, the time period (in minutes) changes as follows:

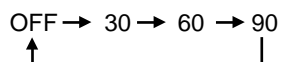

One minute before the TV switches into standby mode, a message "Good night" is displayed on the screen.

To cancel the timer
Press SLEEP to select "OFF."

Switching on at Your Desired Time — On Timer

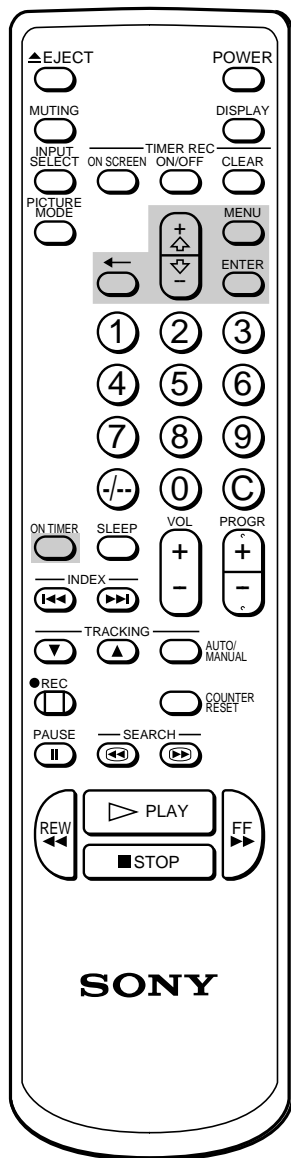

You can preset your video TV to automatically switch on at a desired time. You can select the TV program or video playback to be switched on.

- 1 Press MENU to display the main menu.
- 2 Move the cursor to "ON TIMER SET" with +⇧ or -⇩ and press ENTER. The ON TIMER SET menu appears.

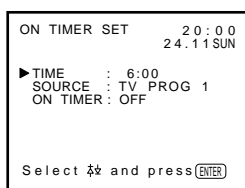

- 3 Press ENTER. The timer setting hour section turns red.
- 4 Set the hour with +⇧ or -⇩ and press ENTER. The minute section turns red.
- 5 Set the minutes (by one minute) with +⇧ or -⇩ and press ENTER. The cursor appears beside "TIME."
- 6 Move the cursor to "SOURCE" with +⇧ or -⇩ and press ENTER.
- 7 Select TV or VCR ▶ (video playback) to be switched on with +⇧ or -⇩ and press ENTER. When you select TV, select the program position with +⇧ or -⇩ and press ENTER.

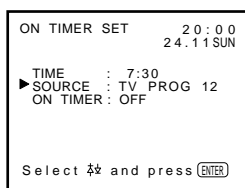

- 8 Move the cursor to "ON TIMER" with +⇧ or -⇩ and press ENTER, then select ON with +⇧ or -⇩ and press ENTER. The ON TIMER lamp on the front of the video TV lights up.
- 9 Press MENU to go back to the original screen. If you are not using the video TV, press POWER on the Remote Commander to set the video TV in standby mode.

At the preset time, the video TV automatically switches on and a message "Good morning" is displayed for five minutes. If you do not press any button for 2 hours, the video TV automatically shuts off.

To cancel on timer function

- 1 Press ON TIMER. The ON TIMER SET menu appears.
- 2 Press ON TIMER again to select OFF.

To erase the message

Press any button on the video TV or Remote Commander.

EN

Searching Using the Index Function

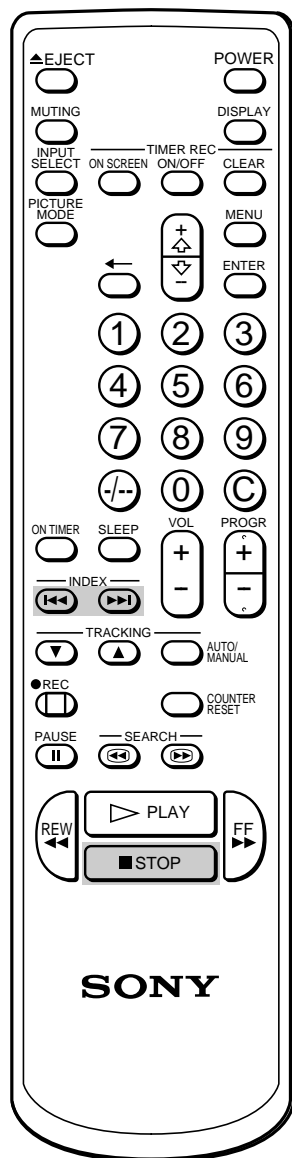

The video TV marks the tape with an index signal at the point where each recording begins. Use these signals as references to find a specific recording. This video TV can search up to 99 index signals ahead of or behind the current position.

- 1 Insert an indexed tape.
- 2 Press **◀◀/▶▶** INDEX repeatedly to specify how many index signals ahead or behind you want to search.

To search ahead, press **▶▶** INDEX.

To search backwards, press **◀◀** INDEX.

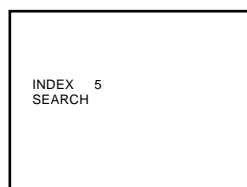

The video TV starts searching and the index number on the TV screen counts down to zero. Playback starts automatically from that point.

To stop searching

Press **■** STOP.

Enhancing Video Picture Quality

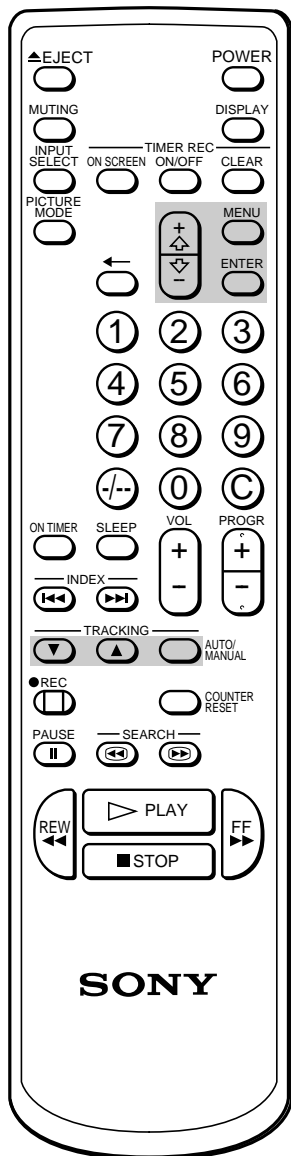

To go back to automatic tracking

Press TRACKING AUTO/MANUAL.

Adjusting the Tracking

Adjusting the Tracking Automatically

The tracking condition is automatically adjusted on this video TV. The AUTO TRACKING indicator will appear while the video TV is searching for best tracking condition.

Adjusting the Tracking Manually

If streaks or snow noise appear on normal playback or playback pause picture, press TRACKING ▼ or ▲ in each playback mode to get the best picture. The tracking meter appears on the screen.

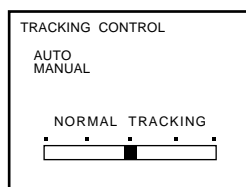

Adjusting with the Adaptive Picture Control (APC)

This function allows you to improve playback and recording quality by adjusting the system parameter automatically according to the condition of a video tape.

This function is set to ON at the factory. To maintain better picture quality, it is advisable to leave the function on. The APC function works on all types of tapes, even on rental tapes.

To change the setting, use the menu display. Move the cursor to "VCR MODE" in the main menu, select "APC" in the VCR MODE menu, then select "ON" or "OFF" with + ↕ or - ↵.

Adjusting with Rental Picture

If you are not satisfied with the picture quality while playing a tape, even when the APC is on, set "RENTAL PICTURE" to "ON". Move the cursor to "VCR MODE" in the main menu, select "RENTAL" in the VCR MODE menu, then set "RENTAL" to "ON".

EN

Connecting Optional Equipment

Watching and Recording the Picture Input from Optional Equipment

To watch the line input signal, press INPUT SELECT so that "LINE" appears on the screen.

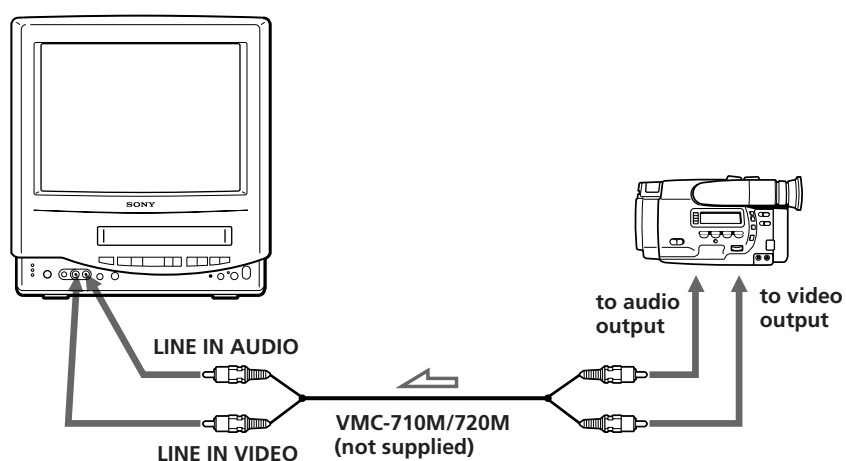

Troubleshooting

Function	Problems	Possible causes and remedies
TV reception	No picture (screen is dark), no sound	<ul style="list-style-type: none"> •The AC power cord is disconnected. <ul style="list-style-type: none"> ➔Connect the AC power cord. •The video TV is switched off. <ul style="list-style-type: none"> ➔Press POWER on the video TV. If the STANDBY lamp is lit in red, press POWER or a program number on the Remote Commander.
	Good picture but no sound	<ul style="list-style-type: none"> •An earphone is connected to ② jack. <ul style="list-style-type: none"> ➔Disconnect the earphone. •"MUTING" is displayed on the screen. <ul style="list-style-type: none"> ➔Press MUTING. •Press VOL +/-.
	No color or poor color (screen is dark) for color programs, but good sound	<ul style="list-style-type: none"> •Adjust "PICTURE," "COLOR," and "BRIGHTNESS" in the PICTURE CONTROL menu. (page 18) •Press PICTURE MODE to switch the picture setting. (page 17)
	No picture, no sound from video input source	<ul style="list-style-type: none"> •The connecting cord between the video TV and the input source is disconnected. <ul style="list-style-type: none"> ➔Connect it firmly. •Input is not selected correctly. <ul style="list-style-type: none"> ➔Press INPUT SELECT so that "LINE" appears. (page 18)
	A receivable channel in your area cannot be received or the sound of the received channel is distorted.	<ul style="list-style-type: none"> •The TV broadcast system is not selected correctly. <ul style="list-style-type: none"> ➔Check the system referring to the table on page 39 and preset the channel manually.
Clock and timer	The clock has stopped and "--:--" is displayed.	<ul style="list-style-type: none"> •The power has been interrupted or the AC power cord is disconnected. <ul style="list-style-type: none"> ➔Re-set the clock and timer settings. (pages 15, 25)
Playback	Power is on, but the tape does not run.	<ul style="list-style-type: none"> •The safety device has been activated. <ul style="list-style-type: none"> ➔Switch off, disconnect the AC power cord, and leave the set for about one minute.
	Poor playback picture	<ul style="list-style-type: none"> •The color system is not set correctly. <ul style="list-style-type: none"> ➔Set "COL SYS" to the setting corresponding to the color system that the tape is recorded in. (page 20) •Adjust the tracking. (page 33) •The video heads are dirty. <ul style="list-style-type: none"> ➔Clean the heads using the Sony V-25CL video head cleaning tape (page 37). If the cleaning tape is not available in your area, have the heads cleaned at your nearest Sony service facility. (Do not use a commercially available wet-type cleaning tape, as it may damage the video heads.) •The tape is worn out. <ul style="list-style-type: none"> ➔Use a new tape.
	The sound drops out.	<ul style="list-style-type: none"> •The tape is defective. <ul style="list-style-type: none"> ➔Use a new tape.

Function	Problems	Possible causes and remedies
Recording	The cassette is ejected when you press REC ●.	<ul style="list-style-type: none"> •The safety tab of the cassette has been removed. <ul style="list-style-type: none"> ➔ Cover the tab hole with adhesive tape, or use another cassette with a safety tab. (page 19)
	Recording cannot be done.	<ul style="list-style-type: none"> •No cassette has been inserted. <ul style="list-style-type: none"> ➔ Insert a cassette with the safety tab. •The tape is at its end. <ul style="list-style-type: none"> ➔ Rewind the tape.
Timer recording	Timer settings cannot be made.	<ul style="list-style-type: none"> •The clock has not been set. <ul style="list-style-type: none"> ➔ Set the current time and date. (page 15) •You have made a mistake when setting the timer. <ul style="list-style-type: none"> ➔ Check the setting steps. (pages 25 to 27)
	The cassette is ejected when you press TIMER REC ON/OFF.	<ul style="list-style-type: none"> •The safety tab of the cassette has been removed. <ul style="list-style-type: none"> ➔ Cover the tab hole with adhesive tape, or use another cassette with a safety tab.
	The TIMER REC lamp does not light up even though you press TIMER REC ON/OFF.	<ul style="list-style-type: none"> •No cassette has been inserted. <ul style="list-style-type: none"> ➔ Insert a cassette with its safety tab. •The tape is at its end. <ul style="list-style-type: none"> ➔ Rewind the tape. •No setting is made for timer recording. <ul style="list-style-type: none"> ➔ Set the program for timer recording. (pages 25 to 27)
	Timer recording was not made.	<ul style="list-style-type: none"> •You did not press TIMER REC ON/OFF. •There has been a power interruption.
Others	A cassette cannot be inserted.	<ul style="list-style-type: none"> •Another cassette is already inserted. <ul style="list-style-type: none"> ➔ Press EJECT ▲ to eject the cassette.
	The Remote Commander does not work.	<ul style="list-style-type: none"> •The batteries are low. <ul style="list-style-type: none"> ➔ Replace the batteries. (page 4) •The batteries are installed incorrectly. <ul style="list-style-type: none"> ➔ Install the batteries with correct polarities. (page 4)

Taking Care of Your Video TV

About the Auto Head Cleaner

The auto head cleaner built into this set automatically cleans the video heads when a cassette is loaded or unloaded. If the effect of head cleaning is not sufficient even after a cassette has been loaded/unloaded several times, clean the heads using the Sony V-25CL video head cleaning cassette.

Video Head Cleaning

When playback pictures are noisy and hardly visible, or when no picture appears, the video heads may be contaminated. In such a case, clean the video heads using the V-25CL video head cleaning tape (not supplied), or ask Sony service personnel to clean the video heads, with this service there would be a standard charge.

Symptoms caused by contaminated video heads

- Normal picture
- Rough picture
- Unclear picture
- No picture (or black & white screen appears)



initial → terminal

Note

Do not use a commercially available wet-type cleaning tape, as it may damage the video heads.

Worn Video Heads

If your video TV displays a poor picture after you clean the video heads, you may need to replace them. Consult your dealer or the Sony Service Center nearest you.

Check the Video Heads after 1,000 Hours of Use

A video TV is a high precision machine. It must record on or play from magnetic tapes on which the image signals from the color TV or the video camcorder are recorded.

The video heads or mechanical parts for transporting the tape are contaminated or worn after extended use. You should have your video TV checked after each 1,000 hours of use.

Specifications

TV Section

Television system	B/G, I, D/K, M
Color system	PAL/SECAM and NTSC ^{3.58} / NTSC ^{4.43}
Channel coverage	See "Receivable channels and channel display" on page 39.
Picture tube	Trinitron KV-14VM5MT: 14 inches (approx. 37 cm measured diagonally) KV-21VM5MT: 21 inches (approx. 54.5 cm measured diagonally)
Antenna in	75-ohm antenna socket for VHF/UHF

Video Section

Format	VHS standard
Video recording system	Rotary 2-head helical scanning system
Audio recording system	Monaural
Video signal	PAL/MESECAM/NTSC
Tape speed	PAL/MESECAM 23.39 mm/sec. NTSC 33.35 mm/sec.
Maximum recording time	PAL/MESECAM 240 minutes with E-240 NTSC 160 minutes with T-160

Inputs and Outputs

Inputs	LINE IN VIDEO: phono jack 1 Vp-p, 75 ohms, unbalanced, sync negative LINE IN AUDIO: phono jack Input level: 500 mVrms
Earphone jack	Minijack

General

Clock	Quartz locked
Power requirements	110 – 240 V AC, 50/60 Hz
Power consumption	KV-14VM5MT: 90 W KV-21VM5MT: 135 W
Operating temperature	5°C to 40°C (41°F to 104°F)
Storage temperature	– 20°C to 60°C (– 4°F to 140°F)
Dimensions	KV-14VM5MT: 396 × 404 × 453 mm (15 ⁵ / ₈ × 16 × 17 ⁷ / ₈ inches) KV-21VM5MT: 550 × 525 × 469.5 mm (21 ³ / ₄ × 20 ³ / ₄ × 18 ¹ / ₂ inches)
Mass	KV-14VM5MT: 14.2 kg (31 lb 5 oz.) KV-21VM5MT: 25 kg (44 lb 1 oz.)

Accessories supplied

- Remote Commander (1)
 - R6 (size AA) batteries (2)
 - Jack cover (1)
 - AC plug adaptor (1)
 - Band (1)*
 - Clamps (2)*
 - Wood screws (2)*
- *KV-21VM5MT only

Design and specifications are subject to change without notice.

Receivable Channels and Channel Display

System	Area	Channel coverage	Channel display
B/G, H	Middle East/Asia	E-2 to E-12	C02 to C12
		E-21 to E-69	C21 to C69
	Indonesia	1A	C01
		2 to 11	C03 to C12
	Morocco	M-4 to M-7	C70 to C73
M-8 to M-10		C08 to C10	
CATV	S-01 to S-05	S42 to S46	
	S-1 to S-41	S01 to S41	
I	Hong Kong/ United Kingdom	B-21 to B-69	C21 to C69
	Ireland	A, B, C,.....J	C01 to C09
	South Africa	4 to 13	C04 to C13
		21 to 68	C21 to C68
	Angola	1	C00
		2 to 3	C02 to C03
CATV	S-01 to S-05	S42 to S46	
	S-1 to S-41	S01 to S41	
D/K,K1	East European countries	R-1 to R-2	C01 to C12
		R-21 to R-60	C21 to C60
	China	C-1	C01
		C-2	C02
		C-3	C13
		C-4	C03
		C-5	C04
		C-6	C14
		C-7 to C-12	C06 to C11
		C-13 to C-24	C21 to C32
		C-25 to C-47	C38 to C60
	C-48 to C-57	C61 to C70	
	Ivory Coast	1 to 3	C71 to C73
CATV	S-1 to S-39	S01 to S39	
M	America	A-2 to A-13	C02 to C13
		A-14 to A-83	C14 to C83
	CATV	A-8	S01
		A-7	S05
		A-6	S06
		A-5 to A-1	S95 to S99
		A to E	S14 to S18
		F to W+28	S19 to S64
W+29 to W+58	S65 to S94		



EN

Index to Parts and Controls

Video TV Set—Front

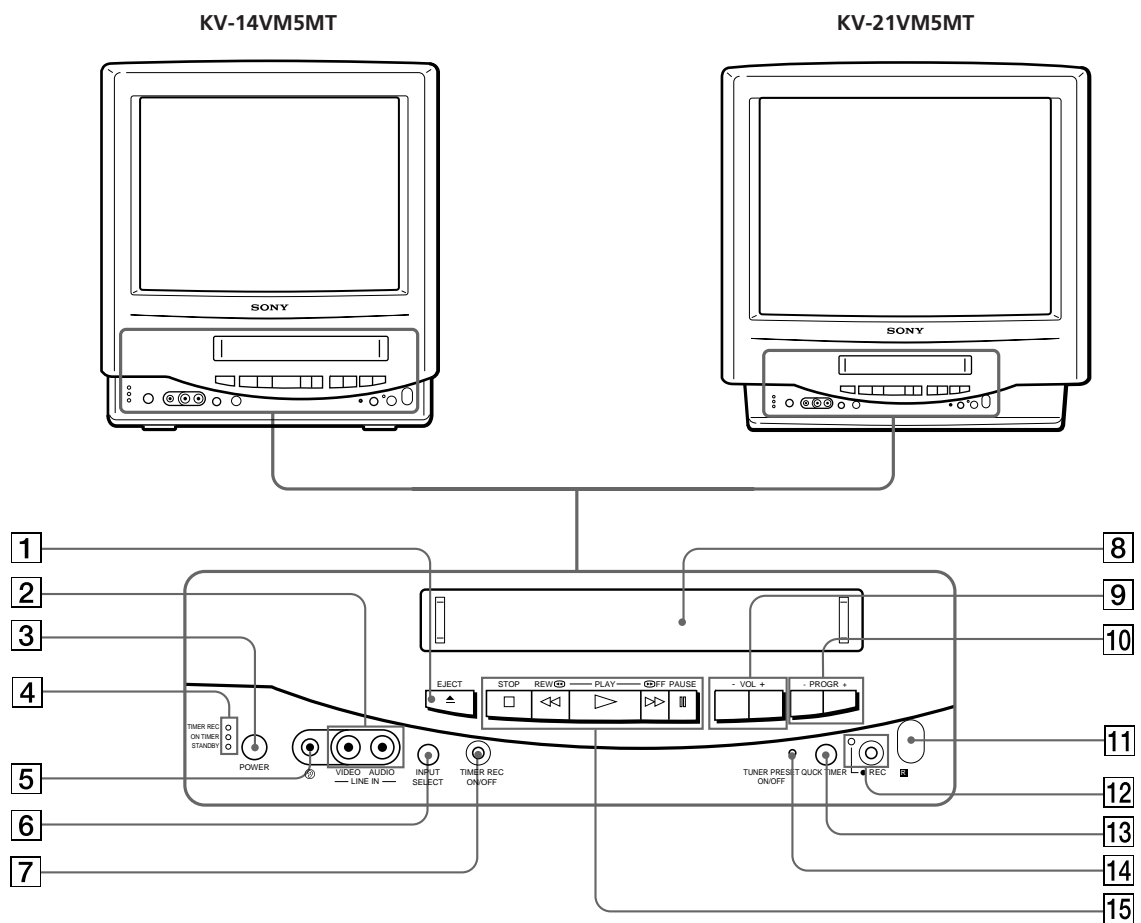
This section briefly describes the buttons and controls on the video TV set and on the Remote Commander. For more information, refer to the pages next to each description.



- | | |
|--|--|
| 1 EJECT  button (page 19) | 8 Cassette compartment (page 19) |
| 2 LINE IN VIDEO/AUDIO jacks (page 34) | 9 VOL (volume) +/- buttons (page 16) |
| 3 POWER switch (pages 8, 16) | 10 PROGR (program) +/- buttons (page 16) |
| 4 Lamps
TIMER REC (recording) (page 27)
ON TIMER (page 31)
STANDBY lamp (pages 8, 16) | 11 Remote sensor |
| 5  (earphone) jack | 12 REC (recording)  button and lamp (page 24) |
| 6 INPUT SELECT button (pages 10, 18, 34) | 13 QUICK TIMER button (pages 10, 29) |
| 7 TIMER REC ON/OFF button (pages 27, 28) | 14 TUNER PRESET ON/OFF button (page 10) |
| | 15 Tape transport buttons (pages 20, 21) |

Remote Commander

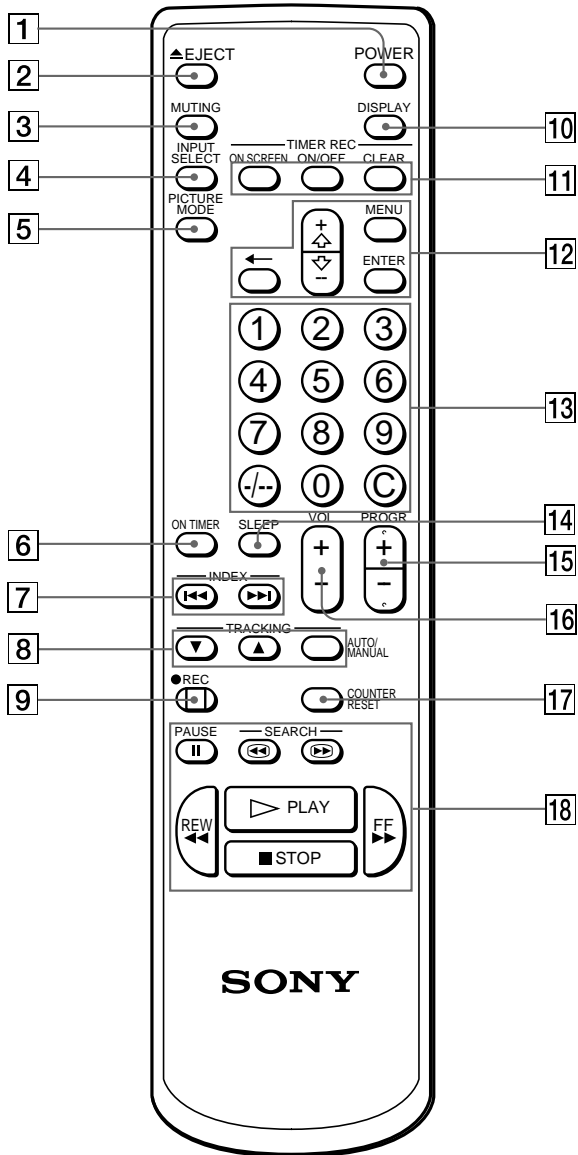

- 1 POWER button (pages 8, 16)
- 2 EJECT ▲ button (page 19)
- 3 MUTE button (page 17)
- 4 INPUT SELECT button (pages 18, 34)
- 5 PICTURE MODE button (page 17)
- 6 ON TIMER button (page 31)
- 7 INDEX ◀◀/▶▶ buttons (page 32)
- 8 TRACKING buttons (page 33)
▼/▲ buttons
AUTO/MANUAL button
- 9 REC(recording) ● button (page 24)
- 10 DISPLAY button (pages 17, 23)
- 11 TIMER REC buttons
TIMER ON SCREEN (pages 25, 28)
ON/OFF (pages 27, 28)
CLEAR (page 28)
- 12 Menu operation buttons (page 8)
MENU
+ ↕ / - ⇓
←
ENTER
- 13 Number buttons (pages 11, 16)
- 14 SLEEP button (page 30)
- 15 PROGR (program) +/- buttons (page 16)
- 16 VOL (volume) +/- buttons (page 16)
- 17 COUNTER RESET button (page 23)
- 18 Tape transport buttons (pages 20, 21)
PLAY ▷, STOP ■, PAUSE ||
REW (rewind) ◀◀, FF (fast-forward) ▶▶
SEARCH ◀/▶ buttons

EN

Free Manuals Download Website

<http://myh66.com>

<http://usermanuals.us>

<http://www.somanuals.com>

<http://www.4manuals.cc>

<http://www.manual-lib.com>

<http://www.404manual.com>

<http://www.luxmanual.com>

<http://aubethermostatmanual.com>

Golf course search by state

<http://golfingnear.com>

Email search by domain

<http://emailbydomain.com>

Auto manuals search

<http://auto.somanuals.com>

TV manuals search

<http://tv.somanuals.com>