

■ Theatre Stand ■ System

Operating Instructions

RHT-G900

RHT-G1500



x.v.Colour

WARNING

To reduce the risk of fire or electric shock, do not expose this apparatus to rain or moisture.

Do not install the appliance in a confined space, such as a bookcase or built-in cabinet.

To prevent fire, do not cover the ventilation of the apparatus with news papers, table-cloths, curtains, etc. And don't place lighted candles on the apparatus.

To prevent fire or shock hazard, do not place objects filled with liquids, such as vases, on the apparatus.

Batteries or batteries installed apparatus shall not be exposed to excessive heat such as sunshine, fire or the like.



Disposal of Old Electrical & Electronic Equipment (Applicable in the European Union and other European countries with separate collection systems)

This symbol on the product or on its packaging indicates that this product shall not be treated as household waste. Instead it shall be handed over to the applicable collection point for the recycling of electrical and electronic equipment. By ensuring this product is disposed of correctly, you will help prevent potential negative consequences for the environment and human health, which could otherwise be caused by inappropriate waste handling of this product. The recycling of materials will help to conserve natural resources. For more detailed information about recycling of this product, please contact your local Civic Office, your household waste disposal service or the shop where you purchased the product.



Disposal of waste batteries (applicable in the European Union and other European countries with separate collection systems)

This symbol on the battery or on the packaging indicates that the battery provided with this

product shall not be treated as household waste. By ensuring these batteries are disposed of correctly, you will help prevent potentially negative consequences for the environment and human health which could otherwise be caused by inappropriate waste handling of the battery. The recycling of the materials will help to conserve natural resources. In case of products that for safety, performance or data integrity reasons require a permanent connection with an incorporated battery, this battery should be replaced by qualified service staff only. To ensure that the battery will be treated properly, hand over the product at end-of-life to the applicable collection point for the recycling of electrical and electronic equipment. For all other batteries, please view the section on how to remove the battery from the product safely. Hand the battery over to the applicable collection point for the recycling of waste batteries. For more detailed information about recycling of this product or battery, please contact your local Civic Office, your household waste disposal service or the shop where you purchased the product.

The manufacturer of this product is Sony Corporation, 1-7-1 Konan Minato-ku Tokyo, 108-0075 Japan. The Authorized Representative for EMC and product safety is Sony Deutschland GmbH, Hedelfinger Strasse 61, 70327 Stuttgart, Germany. For any service or guarantee matters please refer to the addresses given in separate service or guarantee documents.

Table of Contents

WARNING	4
CAUTION.....	5
Precautions	6
Main features	7

Getting Started

Supplied accessories	8
Setting this stand.....	9
Connecting components with HDMI jacks	11
Connecting components without HDMI jacks	13
Setting up the sound output of the connected component	14
Connecting the DIGITAL MEDIA PORT adapter	15

Playback Options

Index to parts and controls	16
Enjoying TV.....	19
Enjoying other components	19

Tuner Functions

Presetting radio stations	21
Listening to the radio	22
Naming preset stations	23
Using the Radio Data System (RDS).....	24

Surround Function

Enjoying the surround effect.....	25
-----------------------------------	----

“BRAVIA” Sync Features

What is “BRAVIA” Sync?.....	27
Preparing for the “BRAVIA” Sync.....	27
Enjoying Blu-ray Disc/DVD.....	30
(One-Touch Play)	
Enjoying the TV sound from the speakers	30
(System Audio Control)	
Turning off the stand, TV and the connected components	31
(System Power Off)	

Advanced Settings

Settings and adjustments using the amplifier menu	32
--	----

Additional Information

Troubleshooting	36
Specifications	38
Glossary.....	40
Index.....	41

The instructions in this manual are for RHT-G900 and RHT-G1500. RHT-G900 is the model used for illustration purposes. Any difference in procedure is clearly indicated in the text, for example, “RHT-G900 only.”

WARNING

Do not lean on or hang from the TV when the TV is placed on the stand.

The TV may fall from the stand causing an accident resulting in serious injury or death.

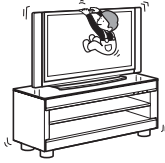

Do not hold the base when moving the stand.

When you move the stand, hold the lower part of the top shelf. If you hold the base as in the illustration, there is a risk that the plinth section may detach and the stand may fall.

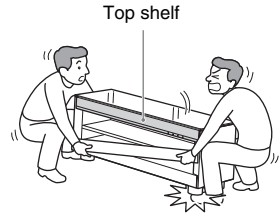

Do not move the stand with the TV or other equipment installed on it.

Be sure to remove the TV and other equipment when moving the stand. If you fail to do so, the stand may lose balance and topple over resulting in serious injury.

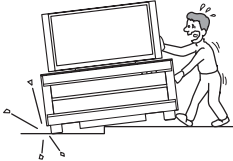

Do not allow the AC power cord (mains lead) or the connecting cable to be pinched between the TV and the stand.

- The AC power cord (mains lead) or the connecting cable may be damaged resulting in fire or electric shock.
- When moving the stand, be careful not to trap the AC power cord (mains lead) or the connecting cable under the stand.

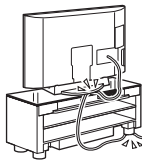

Do not allow children to climb on the stand or crawl between the shelves.

If children climb on the stand or get between the shelves, serious injury or death can result if the glass breaks or the stand topples over.



CAUTION

Do not place any heated objects such as a hot pan or a kettle on the stand.

A top glass panel may break and cause injury. Or, it may cause damage to the stand.

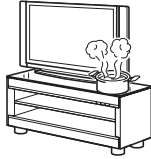

Do not step on the stand.

You may fall, or break the glass and cause injury.



Do not subject the top glass panel to excessive shock.

This stand uses glass with an anti-scatter film, but care should still be taken. If the glass breaks, glass fragments could cause injury, so observe the precautions below.

- Do not hit the glass or drop sharp-pointed objects on the glass. Avoid excessive shock.
- Do not scratch or poke the glass with sharp-pointed objects.
- Do not hit a component on the upper side of a top glass panel when installing the component.

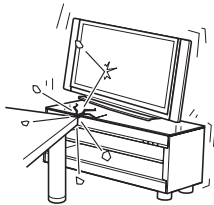

Do not use the top glass panel if it is cracked.

Do not use the top glass panel when it is cracked. The top glass panel may break and cause severe injury.

This stand is only for the specified TV.

Confirm whether this stand is mentioned as a supported product in the operating instructions of the TV.

Note on load capacity

Do not place any equipment exceeding the specified maximum weight on the stand, as indicated in the illustration below. Otherwise, it may fall or break.

RHT-G900

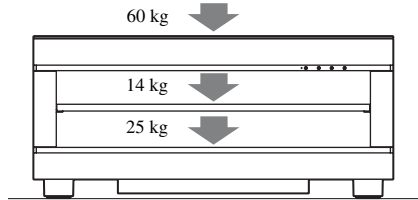

RHT-G1500

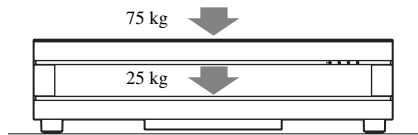

Notes on installation

- Be careful not to pinch your hand or fingers between the TV and the stand.
- To prevent the stand from distorting, observe the following:
 - Install the stand on a solid and flat surface.
 - If you install the stand on a soft surface such as a mat, first lay a board under the stand.
 - Do not install the stand in a place subject to direct sunlight or near a heater.
 - Do not install the stand in a hot or humid place, or outdoors.
- Moving the stand requires two people or more. Move the stand only after removing the TV. If you fail to do so, the TV may fall from the stand resulting in serious injury. Do not hold the grille as it may detach from the stand resulting in serious injury. Be careful not to pinch your fingers when moving the stand.

Precautions

On safety

- Do not place unspecified objects, such as a flower vase or pottery on the stand.
- Do not make alterations to the stand.
- Should any solid object or liquid fall into the stand, unplug the stand and have it checked by qualified personnel before operating it any further.

On power sources

- Before operating the stand, check that the operating voltage is identical to your local power supply. The operating voltage is indicated on the nameplate at the rear of the stand.
- The stand is not disconnected from the AC power source (mains) as long as it is connected to the wall outlet (mains), even if the stand itself has been turned off.
- If you are not going to use the stand for a long time, be sure to disconnect the stand from the wall outlet (mains). To disconnect the AC power cord (mains lead), grasp the plug itself; never pull the cord.
- One blade of the plug is wider than the other for the purpose of safety and will fit into the wall outlet (mains) only one way. If you are unable to insert the plug fully into the outlet, contact your dealer.
- AC power cord (mains lead) must be changed only at the qualified service shop.
- Install this stand so that the power cord can be unplugged from the wall socket immediately in the event of trouble.

On placement

- Place the stand in a location with adequate ventilation to prevent heat buildup and prolong the life of the stand.
- Use caution when placing the stand on surfaces that have been specially treated (with wax, oil, polish, etc.) as staining or discoloration of the surface may result.
- The floor may be damaged if sand, trash, etc., gets caught under the legs of the stand.

On operation

Before connecting other components, be sure to turn off and unplug the stand.

On cleaning

Clean the stand, panel and controls with a soft cloth slightly moistened with a mild detergent solution. Do not use any type of abrasive pad, scouring powder or solvent such as alcohol or benzine.

If you have any question or problem concerning your stand, please consult your nearest Sony dealer.

Copyrights

This stand incorporates Dolby* Digital and Pro Logic Surround and the DTS** Digital Surround System.

* Manufactured under license from Dolby Laboratories.

Dolby, Pro Logic and the double-D symbol are trademarks of Dolby Laboratories.

** Manufactured under license under U.S. Patent #'s: 5,451,942; 5,956,674; 5,974,380; 5,978,762; 6,487,535 & other U.S. and worldwide patents issued & pending. DTS and DTS Digital Surround are registered trademarks and the DTS logos and Symbol are trademarks of DTS, Inc. © 1996-2007 DTS, Inc. All Rights Reserved.

This stand incorporates High-Definition Multimedia Interface (HDMI™) technology.

HDMI, the HDMI logo and High-Definition Multimedia Interface are trademarks or registered trademarks of HDMI Licensing LLC.

“BRAVIA” is a trademark of Sony Corporation.

Main features

► Easy connection with HDMI



The cords are all tangled up.

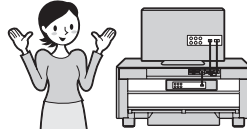

Neat connections (page 11).

► Easy operation with only one TV remote (“BRAVIA” Sync)



Separate remotes for each component.



Consolidate operations on one remote (page 27).

► Easy Surround settings

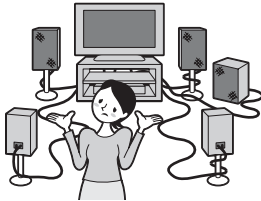

I need lots of cords and speakers.



Easy set-up with S-Force PRO Front Surround.

About S-Force PRO Front Surround

Sony's long-term involvement in surround technology (and the vast amounts of acoustic data accumulated as a result) has led to the development of all-new processing method and advanced DSP to handle this task effectively, which we call S-Force PRO Front Surround. Compared with previous front surround technologies, S-Force PRO Front Surround reproduces a more convincing sense of distance and space, resulting in a true surround sound experience without the need for rear speakers.

Recommended surround-sound area

You can enjoy surround sound in the areas in which sound is spread as illustrated.

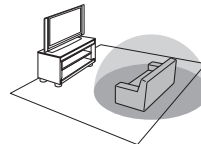

Getting Started

Supplied accessories

Please check the following accessories in the package.

- Optical cable (1 m) (1)**
- Remote commander (RM-ANU032) (1)**
- Size AA (R6) batteries (2)**
- Top glass panel (1)**
- Corner protectors (4)**
- Support belt and two screws (small/large) (1)**
- Shelf board (1) (RHT-G900 only)**
- Shelf support pins (4) (RHT-G900 only)**
- FM wire antenna (aerial) (1)**
- Operating Instructions (1)**

Inserting batteries into the remote

You can control the stand using the supplied remote. Insert two size AA (R6) batteries by matching the + and – ends on the batteries to the markings inside the compartment.

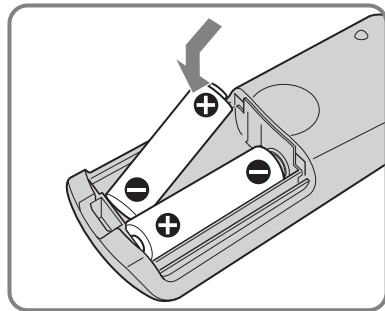
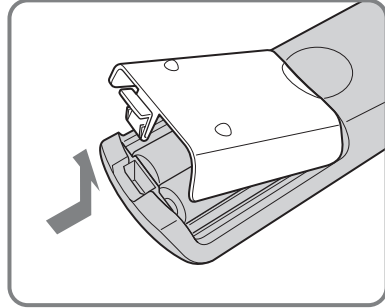

Notes

- Do not leave the remote in an extremely hot or humid place.
- Do not use a new battery with an old one.
- Do not drop any foreign object into the remote casing, particularly when replacing the batteries.
- Do not expose the remote sensor to direct light from the sun or lighting apparatus. Doing so may cause a malfunction.
- If you do not intend to use the remote for an extended period of time, remove the batteries to avoid possible damage from battery leakage and corrosion.

Setting this stand

Installing the top glass panel

Refer to “How to install the top glass panel” supplied with this stand.

Preventing the TV from toppling over

As a protective measure, secure the TV. Perform following steps as a protective measure if you have a Sony LCD TV.

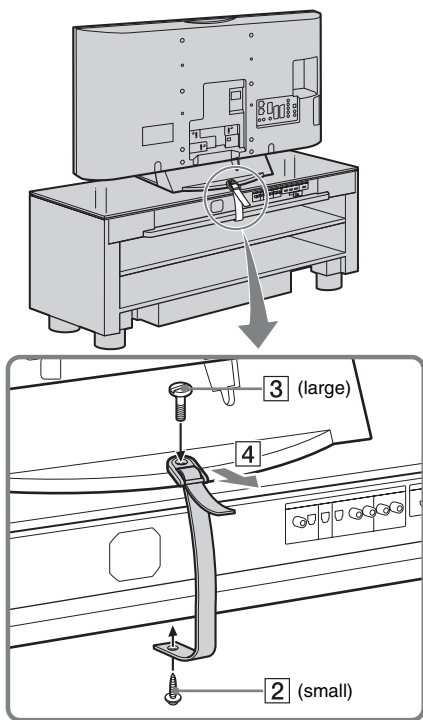

- 1 Place the TV on the center of the stand.**
Install the TV so that the TV does not hide the top panel display of the stand.

- 2 Fasten the support belt (supplied) to the stand with the small screw (supplied).**
Tighten the screw upward into the underside hole, as in the illustration.
- 3 Fit the support belt to the stand, then firmly fasten with the large screw (supplied) using a screw driver or coin, etc.**
- 4 While supporting the TV, tighten the support belt to secure in place.**

Installing the shelf board (RHT-G900 only)

- 1 Insert the attaching shelf support pins (supplied) into the holes in the stand.**
- 2 Fit the shelf board onto the shelf support pins horizontally. This requires people.**

continued

9GB

Connecting the FM wire antenna (aerial)

Connect the FM wire antenna (aerial) to the 75 Ω COAXIAL jack.

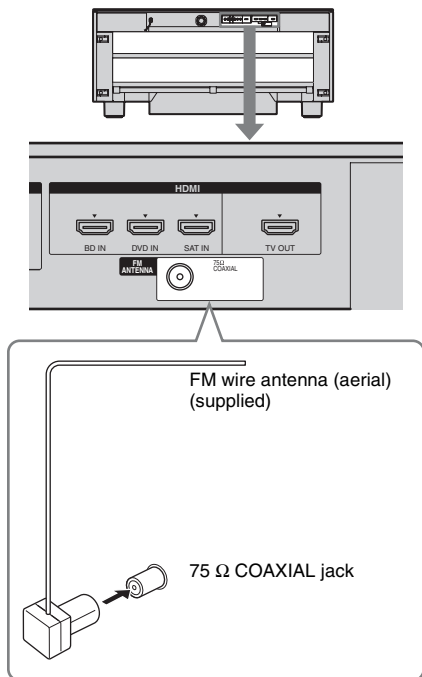

Notes

- Be sure to fully extend the FM wire antenna (aerial).
- After connecting the FM wire antenna (aerial), keep it as horizontal as possible.

Tip

- If you have poor FM reception, use a 75-ohm coaxial cable (not supplied) to connect the control unit to an outdoor FM antenna (aerial) as shown below.

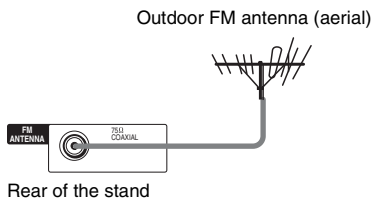

Bundling the cables

- 1** Connect the components to the stand.
For details, refer to pages 11 to 15.
- 2** Bundle the cables with the cord manager to prevent them from tangling.
Stuff the cables into the cord manager as shown in the illustration below.

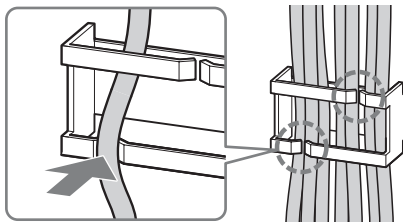

Installing this stand

Install the stand after connecting all the components to the stand.

Install the stand after allowing for a space of more than 5 cm from the wall. This is to allow for heat dissipation and to prevent the TV from falling.

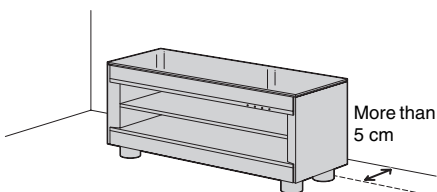

Note

- Be careful not to pinch your fingers when setting up the stand.

Connecting components with HDMI jacks

We recommend that you connect components to the stand using an HDMI cable.

With HDMI, you can easily enjoy both high quality sound and high quality images.

However, it is necessary to connect the audio output of the TV to the audio input of the stand using an optical cable or an audio cord in order listen to the TV's sound from the

stand.

For details on the Control for HDMI function, refer to ““BRAVIA” Sync Features” (page 27).

Connect the AC power cord (mains lead) after you have finished connecting all components to the stand.

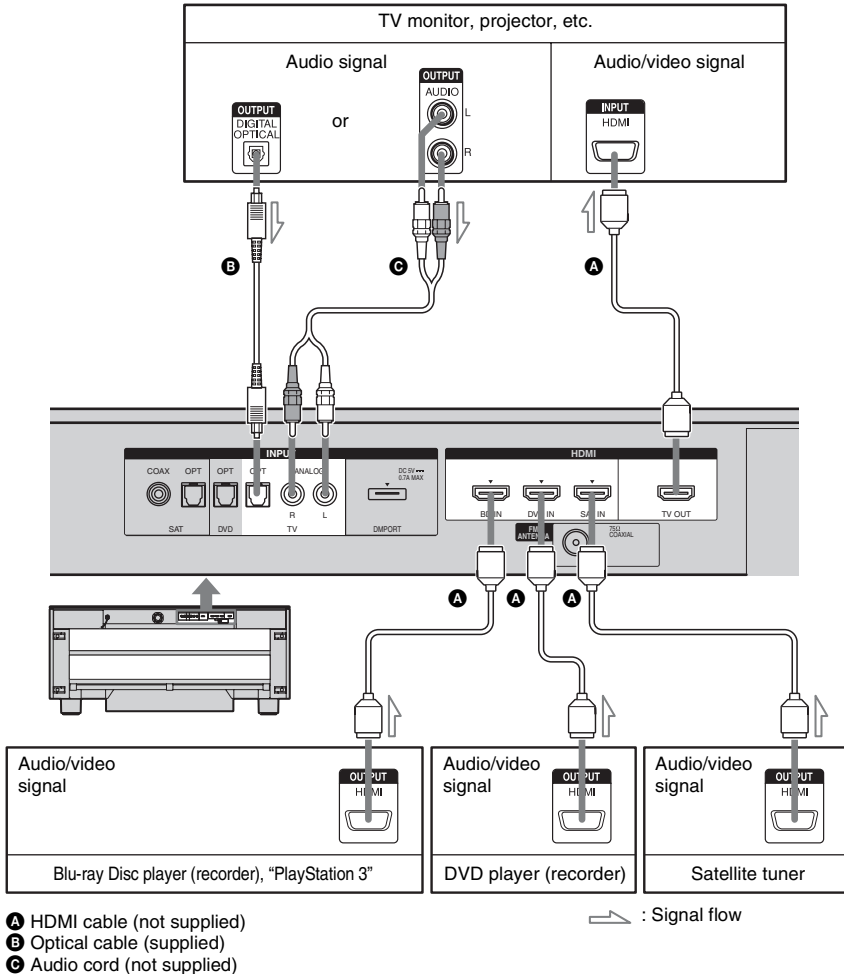

continued

11GB

Notes

- Refer to page 13 for how to connect a component without an HDMI jack.
- The HDMI jack has priority when you connect the component to the stand using INPUT OPT, INPUT COAX and HDMI together.
- The INPUT OPT jack has priority when you connect both the audio output of the TV to the INPUT OPT and INPUT ANALOG jack of the stand.

Notes on HDMI connections

- You can enjoy high quality images using an HDMI cable with an HDMI logo. We recommend that you use a Sony HDMI cable.
- Check the setup of the connected component if an image is poor or the sound does not come out of a component connected via the HDMI cable.
- Audio signals (sampling frequency, bit length, etc.) transmitted from an HDMI jack may be suppressed by the connected component.
- Sound may be interrupted when the sampling frequency or the number of channels of audio output signals from the playback component is switched.
- When the connected component is not compatible with copyright protection technology (HDCP), the image and/or the sound from the HDMI TV OUT jack may be distorted or may be not output.
In this case, check the specification of the connected component.
- We do not recommend using an HDMI-DVI conversion cable.
- No matter what input is selected for the stand, video signals from the HDMI input jack (BD, DVD or SAT) that was selected last time are output from the HDMI TV OUT jack.

Connecting components without HDMI jacks

When you connect a DVD player (recorder), satellite tuner, "PlayStation 2", etc., that has no HDMI jacks, connect to the stand using the INPUT OPT or INPUT COAX jack.

If a component connected to INPUT SAT jacks does not have an OPTICAL OUT jack, connect

this stand using the INPUT COAX jack. In this case, it is not necessary to connect all the cables.

Connect the AC power cord (mains lead) last.
* "PlayStation 2" is a trademark of Sony Computer Entertainment Inc.

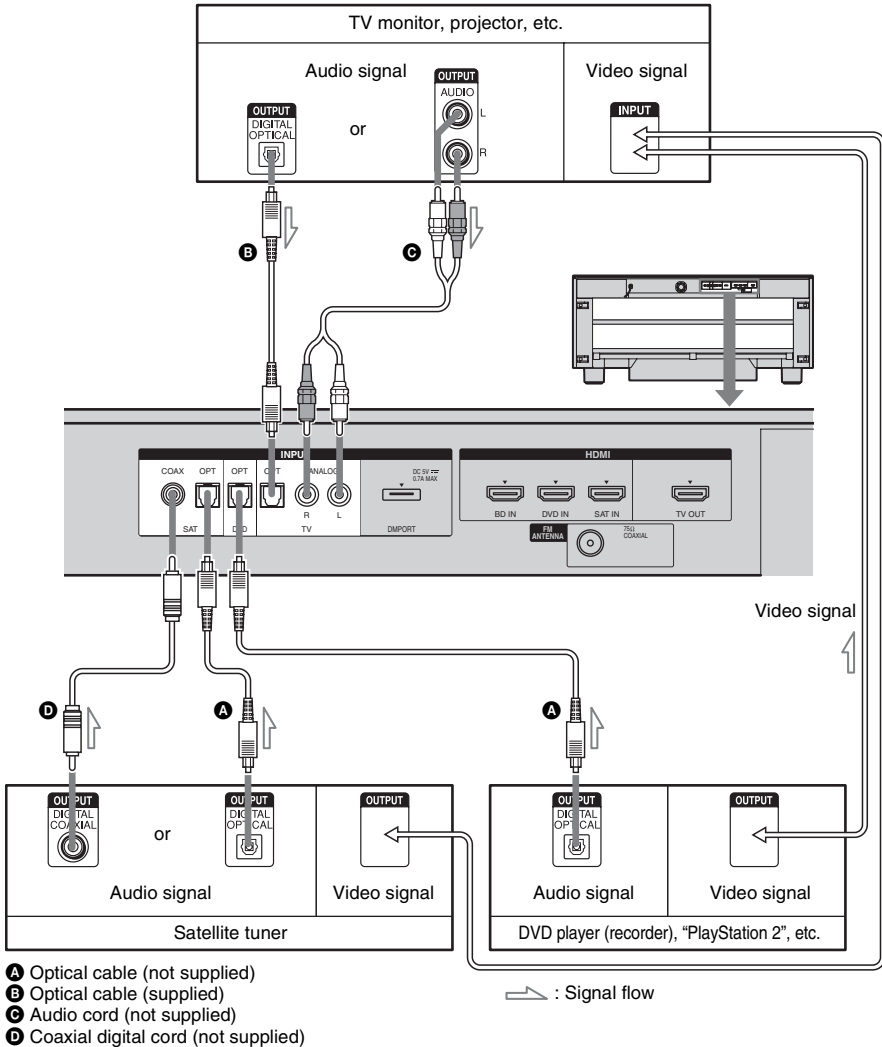

continued

13^{GB}

Note

- The INPUT OPT jack has priority when you connect both the audio output of the TV to the INPUT OPT and INPUT ANALOG jack of the stand.

If you connect any of the components with HDMI jacks, and the Control for HDMI function is set to on

Set “CTRL: HDMI” to “OFF” in the AMP menu of the stand for the component connected to the stand using the INPUT OPT or INPUT COAX jack (except a TV) individually. For details, refer to “Setting the Control for HDMI function to off for a component without HDMI jacks” (page 29).

Setting up the sound output of the connected component

Depending on the audio output settings of the connected component, the sound may output in 2 channel sound format only. In this case, set the connected component to output the sound in multi channel sound format (PCM, DTS, Dolby Digital). For details on audio output settings, refer to the operating instructions supplied with the connected component.

Connecting the DIGITAL MEDIA PORT adapter

You can enjoy sound from the connected component on the stand by connecting the DIGITAL MEDIA PORT adapter.

Connect the AC power cord (mains lead) last.

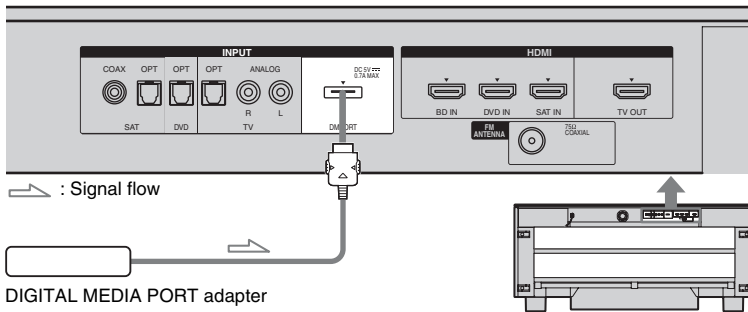

Notes

- Do not connect or disconnect the DIGITAL MEDIA PORT adapter while the stand is turned on.
- When you connect the DIGITAL MEDIA PORT adapter, be sure the connector is inserted with the arrow mark facing toward the arrow mark on the DMPORT jack. To detach the DIGITAL MEDIA PORT adapter, press and hold **A** and then pull out the connector.

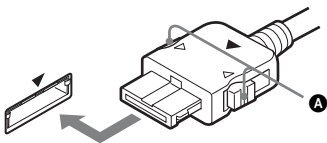

Index to parts and controls

For more information, refer to the pages indicated in parentheses.

Front panel

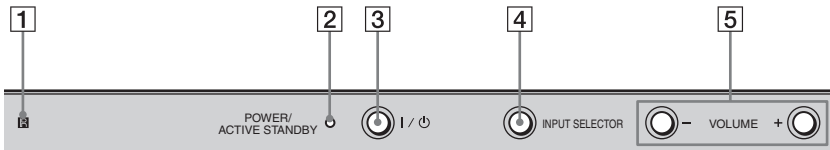

1 **□ (remote sensor) (37)**

Point the remote commander towards here.

2 **POWER/ACTIVE STANDBY indicator**

Lights as follows:

Green: The stand is turned on.

Amber: Control for HDMI function is working while the stand is turned off.

Off: The stand is turned off, and the Control for HDMI function is not working.

3 **I / ⏻ (on/standby)**

Press to turn the stand on or off.

4 **INPUT SELECTOR**

Press to select the input source to play back.

5 **VOLUME +/-**

Press to adjust the volume.

Top panel display

About the indications in the top panel display



1 HDMI (11, 37)

Lights up when an HDMI equipment is being used.

2 Lights up according to the audio input signals.

3 SLEEP (35)

Flashes when the Sleep Timer function is active.

4 NIGHT (26)

Lights up in NIGHT mode.

5 COAX/OPT

Lights up according to the cable which you are using.

6 TUNED (21)

Lights up when an FM station is received.

7 ST/MONO (22)

ST: Lights up when a stereo FM station is received.

MONO: Lights up when the stand is set to reproduce a stereo FM station in monaural.

continued

Remote control

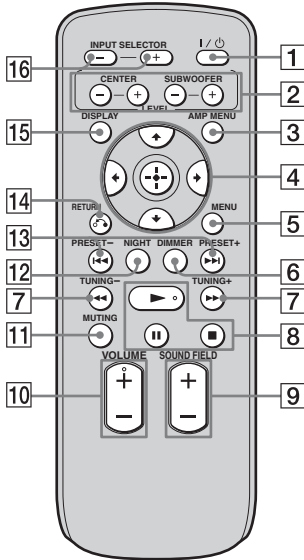

Buttons for the operation of this stand

- 1 **I/⏻ (on/standby)**
Press to turn the stand on or off.
- 2 **LEVEL**
Press to adjust the level of the center speaker and subwoofer. This setting is applied to all sound fields.
- 3 **AMP MENU**
Press to display the menu of the stand (page 32).
- 4 **←, ↑, ↓, → or (+)**
Press ←, ↑, ↓ or → to select the settings. Then press (+) to enter the selection.
- 5 **MENU**
Press to preset a radio station or name the preset station (page 21, 23).
- 6 **DIMMER**
Press to select the brightness of the top panel display can be set to one of 2 levels.
- 7 **TUNING +/-**
Press to select a radio station (page 21, 22).

- 9 **SOUND FIELD +/-**
Press to select the sound field (page 25).
- 10 **VOLUME +/-**
Press to adjust the volume.
- 11 **MUTING**
Press to turn off the sound.
- 12 **NIGHT**
Press to activate the NIGHT mode function (page 26).
- 13 **PRESET +/-**
Press to select a preset radio station (page 22).
- 14 **↶ RETURN**
Press to return to the previous menu.
- 15 **DISPLAY**
Press to switch the information in the top panel display.
- 16 **INPUT SELECTOR +/-**
Press to select an input source, such as the tuner, or other connected component.

Buttons for the operation of a connected component through DMPORT connection

- 4 **←, ↑, ↓, → or (+)**
Press to select a menu item and enter the selection.
- 5 **MENU**
Press to display the MENU.
- 7 **⏮/⏭**
Press to fast reverse or to fast forward the disc when pressed during playback.
- 8 **▶ (playback)/⏸ (pause)/■ (stop)**
Play mode buttons.
- 13 **⏮/⏭**
Press to skip chapters.
- 14 **↶ RETURN**
Press to return to the previous menu.
- 15 **DISPLAY**
Press to select the setting of the top panel display.

Enjoying TV

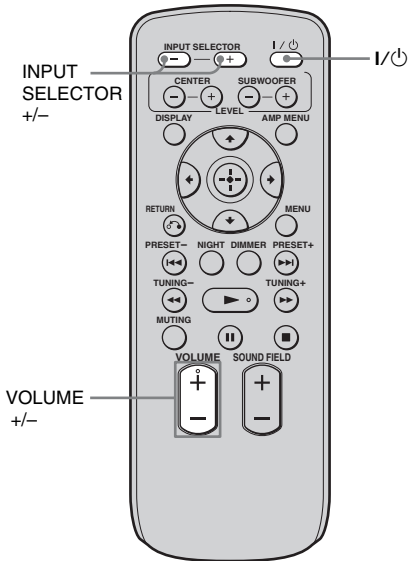

- 1 Turn on the TV and choose a program.**
Refer to the operating instructions of your TV for details.
- 2 Turn the stand on.**
- 3 Press INPUT SELECTOR + or – repeatedly until “TV” appears in the top panel display.**
- 4 Adjust the volume by pressing VOLUME +/-.**

Tip

- The sound may be output from the TV’s speaker. In this case, turn the volume of the TV’s speaker down to the minimum.

Enjoying other components

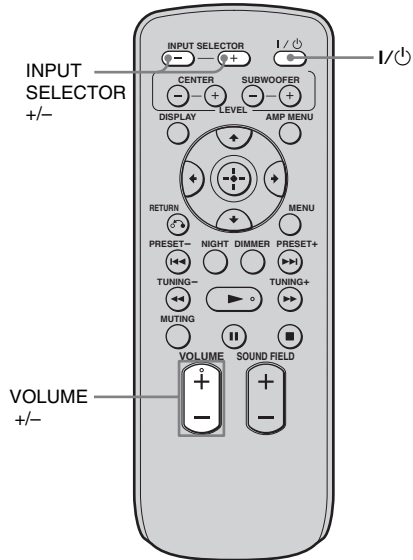

Enjoying satellite tuner

- 1 Turn on the TV.**
Refer to the operating instructions of your TV for details.
- 2 Turn the satellite tuner and the stand on.**
- 3 Press INPUT SELECTOR + or – repeatedly until “SAT” appears in the top panel display.**
- 4 Change the TV input.**
Refer to the operating instructions of your TV for details.
- 5 Adjust the volume by pressing VOLUME +/-.**

Tip

- The sound may be output from the TV’s speaker. In this case, turn the volume of the TV’s speaker down to the minimum.

continued

Enjoying Blu-ray Disc, DVD, “PlayStation 2” or “PlayStation 3”

- 1** Turn on the TV.
- 2** Turn the Blu-ray Disc/DVD player (recorder), “PlayStation 2” or “PlayStation 3” and the stand on.
- 3** Press INPUT SELECTOR + or – repeatedly until “BD” or “DVD” appears in the top panel display.
- 4** Change the TV input.
Refer to the operating instructions of your TV for details.
- 5** Play back the disc.

Tip

- Even if you playback Dolby True HD, Dolby Digital Plus or DTS HD with a connected component compatible with these sound formats, the stand accepts as Dolby Digital or DTS. When you playback these high-quality sound formats, set the connected component to output the sound in multi channel PCM, if possible.

Enjoying a connected component through DMPORT connection

- 1** Press INPUT SELECTOR + or – repeatedly until “DMPORT” appears in the top panel display.
- 2** Start playback of the connected component.

Note

- You can enjoy optimum sound quality from portable audio components in any sound field except for “STANDARD”, joining the effect of Portable Audio Enhancer.

Tuner Functions

Presetting radio stations

You can preset 20 FM stations. Before tuning, make sure to turn down the volume to minimum.

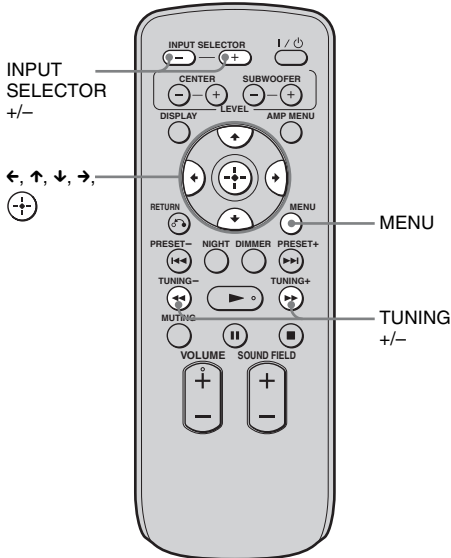

- 1 Press INPUT SELECTOR + or - repeatedly until “FM” appears in the top panel display.**
- 2 Press and hold TUNING + or - until the auto scanning starts.**

Scanning stops when the stand tunes in a station. “TUNED” lights up in the top panel display.
- 3 Press MENU.**
- 4 Press ↑/↓ repeatedly until “Memory?” appears in the top panel display.**
- 5 Press \oplus .**

A preset number appears in the top panel display.



- 6 Press ↑/↓ to select the preset number you want.**



- 7 Press \oplus .**

“Complete!” appears in the top panel display, and the station is stored.



- 8 Press MENU.**

- 9 Repeat 2 to 8 to store other stations.**

To change the preset number

Restart from step 3.

Listening to the radio

Preset radio stations in the stand's memory first (see "Presetting radio stations" (page 21)).

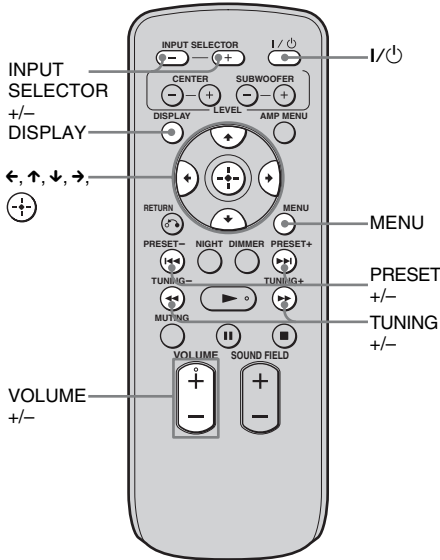

1 Press INPUT SELECTOR + or - repeatedly until "FM" appears in the top panel display.

The last received station is tuned in.

2 Press PRESET + or - repeatedly to select the preset station.

Each time you press the button, the stand tunes in one preset station.

3 Adjust the volume by pressing VOLUME +/-.

To turn off the radio

Press **I/O** to turn off the stand.

To change to another function, press **INPUT SELECTOR + or -**.

To listen to non-preset radio stations

Use manual or automatic tuning in step 2.

For manual tuning, press **TUNING + or -** repeatedly.

For automatic tuning, press and hold **TUNING +** or **-**. The automatic tuning stops when the stand tunes in a station. To stop the automatic tuning manually, press **TUNING + or -**.

If an FM program is noisy

If an FM program is noisy, you can select monaural reception. There will be no stereo effect, but reception will improve.

1 Press MENU.

2 Press ↑/↓ repeatedly until "FM Mode?" appears in the top panel display, then press **+ or **→**.**

3 Press ↑/↓ to select "MONO."

- STEREO: Stereo reception.
- MONO: Monaural reception.

4 Press **+.**

The setting is made.

5 Press MENU.

Tip

- To improve reception, reorient the FM wire antenna (aerial) (supplied).

Naming preset stations

You can enter a name for preset stations. These names (for example, “XYZ”) appear in the top panel display when a station is selected. Note that no more than one name can be entered for each preset station.

1 Press **INPUT SELECTOR + or –** repeatedly until “FM” appears in the top panel display.

The last received station is tuned in.

2 Press **PRESET + or –** repeatedly to select the preset station you want to create an index name for.

3 Press **MENU**.

4 Press **↑/↓** repeatedly until “Name In?” appears in the top panel display.



5 Press **⊕**.

6 Create a name by using **←/↑/↓/→**.

Press **↑/↓** to select a character, then press **→** to move the cursor to the next position.

Letters, numbers, and other symbols can be input for a radio station name.

If you enter a wrong character

Press **←/→** repeatedly until the character to be changed flashes, then press **↑/↓** to select the desired character.

7 Press **⊕**.

“Complete!” appears in the top panel display, and the station name is stored.



8 Press **MENU**.

Tip

- You can check the frequency in the top panel display by pressing **DISPLAY** repeatedly (page 23).

Viewing the station name or frequency in the top panel display

When the stand is set to “FM”, you can check the frequency using the top panel display.

Press **DISPLAY**.

Each time you press **DISPLAY**, the station name and the frequency alternate in the top panel display.

Tips

- The station name is displayed if you have entered a name for a preset station.
- The frequency in the top panel display switches to the station name after several seconds.

Using the Radio Data System (RDS)

What is the Radio Data System?

The Radio Data System (RDS) is a broadcasting service that allows radio stations to send additional information along with the regular program signal. This tuner offers convenient RDS features, such as station name display. RDS is available only for FM stations.*

Note

- RDS may not work properly if the station you are tuned to is not transmitting the RDS signal properly, or if the signal strength is weak.
- * Not all FM stations provide RDS service, nor do they provide the same type of services. If you are not familiar with the RDS system, check with your local radio stations for details on RDS services in your area.

Receiving RDS broadcasts

Simply select a station from the FM band.

When you tune in a station that provides RDS services, the frequency in the top panel display switches to the station name*.

- * If an RDS broadcast is not received, a station name will not appear in the top panel display.

Tip

- When a station name is displayed, you can check the frequency by pressing DISPLAY repeatedly.

Surround Function

Enjoying the surround effect

Selecting the sound field

This stand can create multi channel surround sound. You can select one of stand's optimized pre-programmed sound fields.

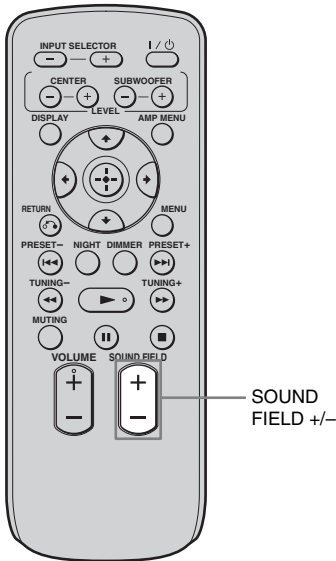

Press SOUND FIELD +/-.

The present sound field appears in the top panel display.

Each time you press the SOUND FIELD +/- button, the display changes cyclically as follows:
 STANDARD ↔ MOVIE ↔ NEWS ↔
 SPORTS ↔ GAME ↔ MUSIC ↔ JAZZ
 ↔ CLASSIC ↔ ROCK ↔ POP ↔
 DANCE ↔ FLAT ↔ STANDARD
 Press SOUND FIELD +/- repeatedly until the sound field you want appears.

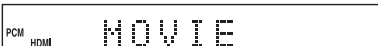

Available sound fields

Sound field	Effect
STANDARD	This is the standard setting.
MOVIE*	Recreates powerful and realistic sound, along with clear dialog.
NEWS*	Produces the announcer's voice clearly.
SPORTS*	Produces the play-by-play commentary clearly and realistic sound with surround effects, such as cheering, etc.
GAME*	Produces powerful and realistic sound, best suited for playing video games.
MUSIC*	Produces music with optimum surround sound effects.
JAZZ	Recreates the atmosphere of a jazz club.
CLASSIC	Recreates the atmosphere of a classical concert.
ROCK	Produces powerful sound, best suited for listening to rock music.
POP	Produces uplifting sound, best suited for listening to pop music.
DANCE	Recreates the atmosphere of a dance hall.
FLAT	Plays all music in stereo without any effects.

* These sound fields do not appear when "DMPORT" is selected for the INPUT SELECTOR.

Note

- All sound is played in surround sound in "MOVIE", "SPORTS", "GAME" and "MUSIC."
Multi channel sounds are played in surround sound in "STANDARD" and "NEWS."
In other modes, sound is played in stereo.

Tips

- The sound fields memorized for each input are retained even if you disconnect the AC power cord (mains lead).

continued

- Multi-channel sound is processed by the surround feature in any sound field. Also, multi-channel sound is processed by the surround feature for any sound in “MOVIE” or “SPORTS.”

Enjoying the sound at low volume (NIGHT mode)

You can enjoy sound effects and to hear the dialog clearly even at a low volume level using this function. This function is useful for enjoying sound at night.

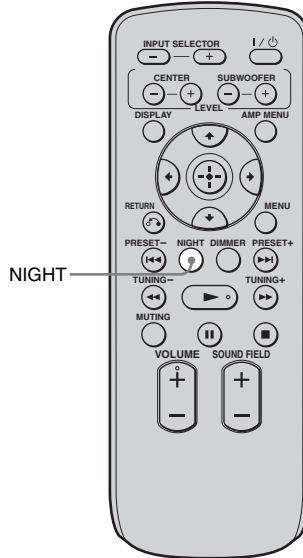

Press NIGHT.

To cancel the night mode, press NIGHT again.

Tip

- You can listen to Dolby Digital sound at low volume by using AUDIO DRC (page 34).

“BRAVIA” Sync Features

What is “BRAVIA” Sync?

By connecting Sony components that are compatible with the “BRAVIA” Sync with an HDMI cable (not supplied), operation is simplified as below:

- **One-Touch Play:** When you play back a component such as a Blu-ray Disc/DVD player (recorder), the stand and the TV are turned on automatically and switch to the appropriate HDMI input.
- **System Audio Control:** While watching TV, you can select to output the sound from the TV speaker or the speakers of the stand.
- **System Power Off:** When you turn off the TV, the stand and the connected components are also turned off simultaneously.

“BRAVIA” Sync is compatible with a Sony TV, Blu-ray Disc/DVD player, AV amplifier, etc., with the Control for HDMI function.

CONTROL FOR HDMI is a mutual control function standard used by CEC (Consumer Electronics Control) for HDMI (High-Definition Multimedia Interface).

The Control for HDMI function will not operate in the following cases:

- When you connect this stand to a component which is not correspond with Control for HDMI function.
- When you connect the stand and components using other than HDMI connection.

We recommend that you connect this stand to products featuring “BRAVIA” Sync.

Note

- Depending on the connected component, the Control for HDMI function may not work. See the operating instructions of the component.

Preparing for the “BRAVIA” Sync

To use the “BRAVIA” Sync, set the Control for HDMI function to on for the stand and the connected component.

When you connect a Sony TV with the Control for HDMI function, the Control for HDMI function for the stand and the connected component can be set simultaneously by setting Control for HDMI function of the TV.

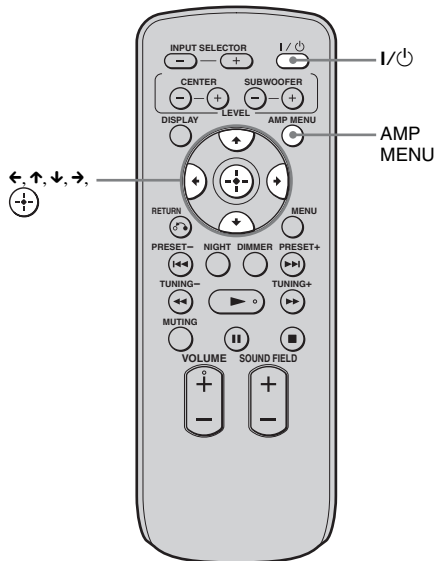

- 1** Make sure that the stand is connected to the TV and the connected components (which should be compatible with the Control for HDMI function) using HDMI cables (not supplied).
- 2** Turn on the stand, the TV and the connected components.
- 3** Select the input of the stand connected to the component you want to watch (BD, DVD, SAT), and switch the HDMI input of the TV, so that an image from the connected component is displayed.

continued

4 Set Control for HDMI function of the TV to on.

The Control for HDMI function for the stand and the connected component is simultaneously set to on.

During the setting, "SCANNING" appears in the top panel display. After you finish the setting, "COMPLETE" appears in the top panel display. Wait until the setting is complete.

If "SCANNING" or "COMPLETE" does not appear after performing the steps above

Set the Control for HDMI function to on for the stand and the connected component individually.

1 Press AMP MENU.

2 Press \uparrow/\downarrow repeatedly until "SET HDMI" appears, then press \oplus or \rightarrow .

3 Press \uparrow/\downarrow repeatedly until "CTRL: HDMI" appears, then press \oplus or \rightarrow .

4 Press \uparrow/\downarrow to select "ON."

5 Press AMP MENU.

The AMP menu turns off. The Control for HDMI function is set to on.

6 Set the Control for HDMI function of the connected component to on.

For details on setting the connected component, refer to its operating instructions.

7 Select the input of the stand connected to the component you want to use the Control for HDMI function for (BD, DVD, SAT), and repeat step 6.

If you add or reconnect the component

Perform steps of "Preparing for the "BRAVIA" Sync" and "If "SCANNING" or "COMPLETE" does not appear after performing the steps above" again.

Notes

- During the setting of the Control for HDMI function for the stand, the System Audio Control function does not work.
- If the Control for HDMI function for the connected component cannot be set simultaneously by setting "CONTROL FOR HDMI" of the TV, set the Control for HDMI function using the menu of the connected component.
- For details on setting the TV and the connected components, refer to their operating instructions.

Tip

- The default setting of the Control for HDMI function of the stand is "OFF."

Setting the Control for HDMI function to off for a component without HDMI jacks

To listen to the sound of the component without HDMI jacks when the Control for HDMI function is set to on, set it to off for that component individually.

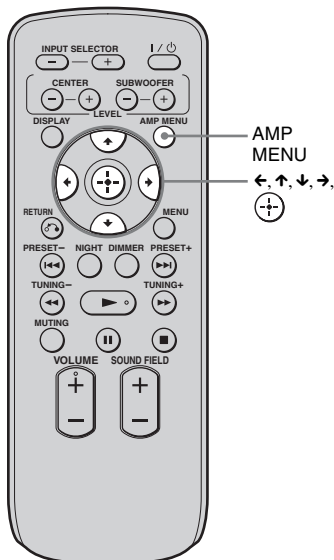

Tip

- When you connect the video output of the DIGITAL MEDIA PORT adapter to the video input of the TV, set the “DMPORT. CTRL” to “OFF.”
When you connect the DIGITAL MEDIA PORT adapter without video output jack, set the “DMPORT. CTRL” to “ON.”

- 1 Press AMP MENU.
- 2 Press \uparrow/\downarrow repeatedly until “SET HDMI” appears, then press $\left(\oplus\right)$ or \rightarrow .
- 3 Press \uparrow/\downarrow to select the component you want to set the Control for HDMI function to off for (DVD CTRL, SAT CTRL or DMPORT. CTRL), then press $\left(\oplus\right)$ or \rightarrow .
- 4 Press \uparrow/\downarrow to select “OFF.”
- 5 Press AMP MENU.

The AMP menu turns off.

Note

- Unless the Control for HDMI function is set to off for a component without HDMI jacks, the sound of that component is not output from the stand.

Enjoying Blu-ray Disc/DVD

(One-Touch Play)

Play back a connected component.

The stand and the TV are turned on automatically and switch to the appropriate HDMI input.

Note

- Depending on the TV, the start of the content may not be output.

Tip

- You can enjoy the Blu-ray Disc/DVD player (recorder) connected to the stand, even if you turn the stand off. The POWER/ACTIVE STANDBY indicator lights up in amber at this time.

Enjoying the TV sound from the speakers

(System Audio Control)

You can enjoy the TV sound from the speakers of the stand by means of a simple operation. For details, see the operating instructions of the TV.

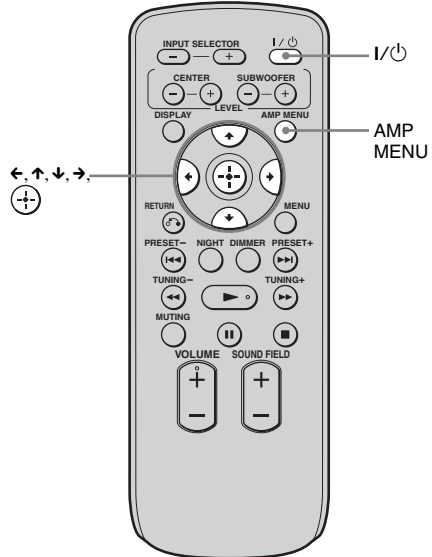

Press I/⏻ to turn on the stand.

The sound is output from the speaker of the stand. The sound is output from the TV's speaker when you turn the stand off.

Notes



- When the TV is turned on before this stand is turned on, the TV sound will not be output for a moment.
- When you connect a TV that does not have System Audio Control function, the System Audio Control function does not work.

Tip

- You can adjust the volume and turn off the sound of the stand using the TV remote.

Using the Volume Limit function

When the System Audio Control function is active, and the output method changes from the TV speaker to the stand speaker automatically, loud sound may be output depending on the volume level of the stand. You can prevent this by limiting the maximum volume level.

- 1 Press AMP MENU.**
- 2 Press ↑/↓ repeatedly until "SET HDMI" appears, then press  or →.**
- 3 Press ↑/↓ repeatedly until "VOL LIMIT" appears, then press  or →.**
- 4 Press ↑/↓ to select the maximum volume level you want.**

The maximum volume level changes as follows:

MAX ↔ 49 ↔ 48 2 ↔ 1 ↔ MIN

- 5 Press AMP MENU.**

The AMP menu turns off.

Notes

- This function is available only when the Control for HDMI function is set to on.
- This function is not available when the output method changes from the stand speaker to the TV speaker.

Tips

- We recommend that you set the maximum volume level to a little lower than the volume you usually listen to.
- Regardless of the maximum volume level you set, the VOLUME +/- button of the stand and the remote is operable.
- If you do not want to limit the maximum volume level, select "MAX."

Turning off the stand, TV and the connected components

(System Power Off)

When you turn the TV off by using the POWER button on the TV's remote, the stand and the connected components turns off automatically.

Note

- Depending on the status, the connected components may not be turned off. For details, see operating instructions supplied with the connected components.

Advanced Settings

Settings and adjustments using the amplifier menu

Using the AMP menu

You can set the following items with AMP MENU on the remote.

The default settings are underlined.

AMP MENU

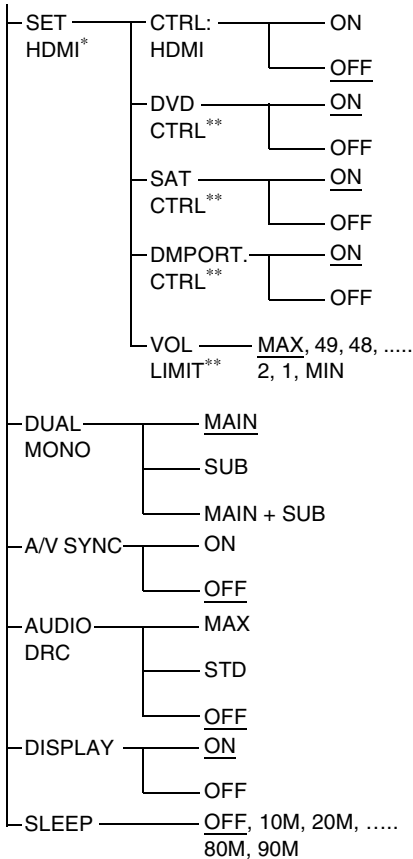

* Refer to ““BRAVIA” Sync Features” (page 27).

** This setting appears only when “CTRL: HDMI” is set to “ON.”

- 1 Press AMP MENU to turn on the AMP menu.
- 2 Press ←/↑/↓/→ repeatedly to select the item and the setting.
- 3 Press AMP MENU to turn off the AMP menu.

The following pages show details for each setting.

Enjoying multiplex broadcast sound (DUAL MONO)

You can enjoy multiplex broadcast sound when the stand receives an AC-3 multiplex broadcast signal.

Note

- To receive AC-3 signal, you need to connect a digital satellite tuner to the stand with an optical cable or coaxial cable, and set the digital output mode of the digital satellite tuner to AC-3.

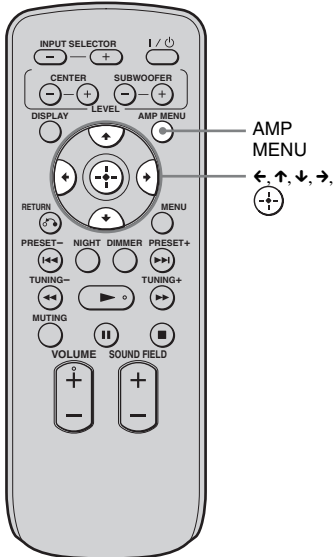

- 1 Press AMP MENU.
- 2 Press ↑/↓ repeatedly until “DUAL MONO” appears, then press or →.
- 3 Press ↑/↓ to select the sound you want.

- MAIN: Plays back only the main channel.
- SUB: Plays back only the sub channel.
- MAIN+SUB: Main sound is output from the left speaker and sub sound is output from the right speaker.

- 4 Press AMP MENU.

The AMP menu turns off.

Adjusting the delay between the sound and the image (A/V SYNC)

You can delay the sound using this function when the image is slower than the sound.

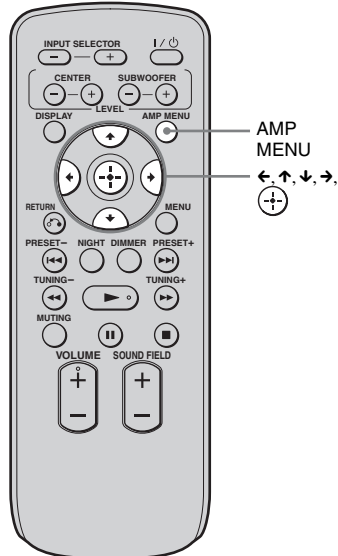

- 1 Press AMP MENU.
- 2 Press ↑/↓ repeatedly until “A/V SYNC” appears, then press or →.
- 3 Press ↑/↓ to select the setting.

- OFF: Does not adjust.
- ON: Adjusts the difference between picture and sound.

- 4 Press AMP MENU.

The AMP menu turns off.

Notes

- You may not be able to adjust the delay between sound and image perfectly using this function.
- This function is useful only for Dolby Digital, DTS and Linear PCM (2ch) input by coaxial (audio), optical (audio) or HDMI.

continued

Enjoying Dolby Digital sound at low volume (AUDIO DRC)

Narrows the dynamic range of the sound track. Useful for enjoying movies at low volume. AUDIO DRC only applies to Dolby Digital sources.

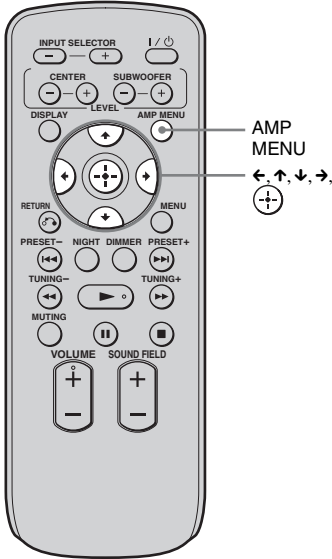

- 1 Press AMP MENU.
- 2 Press \uparrow/\downarrow repeatedly until "AUDIO DRC" appears, then press \oplus or \rightarrow .
- 3 Press \uparrow/\downarrow to select the setting.
 - OFF: No compression of dynamic range.
 - STD: Reproduces the sound track with the kind of dynamic range that the recording engineer intended.
 - MAX: Compresses dynamic range fully.
- 4 Press AMP MENU.
The AMP menu turns off.

Changing the display setting (DISPLAY)

You can change the display setting.

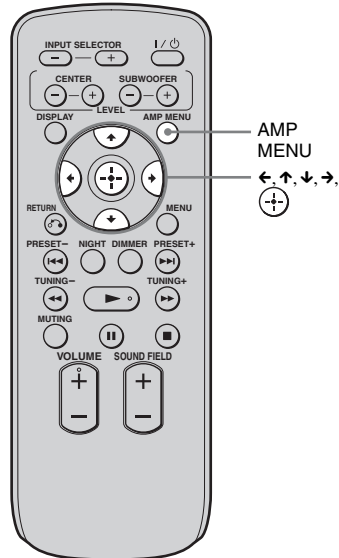

- 1 Press AMP MENU.
 - 2 Press \uparrow/\downarrow repeatedly until "DISPLAY" appears, then press \oplus or \rightarrow .
 - 3 Press \uparrow/\downarrow to select the setting of the top panel display.
 - ON: The display appears all the time.
 - OFF: The display appears for a few seconds when you operate the stand.
- Note**
- The display appears all the time when the muting or protection function is working, even if you set the "DISPLAY" to "OFF."
- 4 Press AMP MENU.
The AMP menu turns off.

Using the sleep timer

You can set the stand to turn off at a preset time when you sleep listening to music. You can preset the time in 10 minutes decrements.

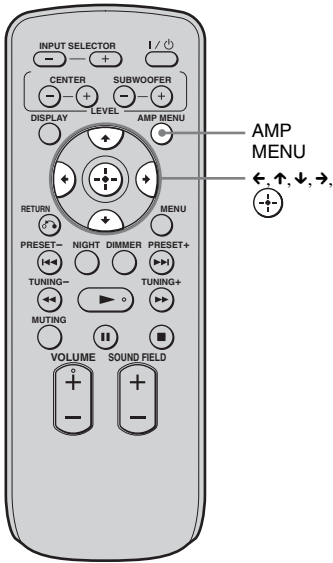

- 1** Press AMP MENU.
- 2** Press \uparrow/\downarrow repeatedly until "SLEEP" appears, then press \oplus/\ominus or \rightarrow .
- 3** Press \uparrow/\downarrow to select the preset time you want.

The minutes display (remaining time) changes as follows:

OFF \leftrightarrow 10M \leftrightarrow 20M
 \updownarrow \updownarrow
 90M \leftrightarrow 80M 30M

Note

- This function is only for this stand, not for the connected TV or other components.

Additional Information

Troubleshooting

If you experience any of the following difficulties while using the stand, use this troubleshooting guide to help remedy the problem before requesting repairs. Should any problem persist, consult your nearest Sony dealer.

General

The power is not turned on.

- Check that the AC power cord (mains lead) is connected securely.

If “PROTECTOR” and “PUSH POWER” appears alternately in the top panel display.

Press I/⏻ to turn off the stand, and check the following item after “STANDBY” disappears.

- Is anything blocking the ventilation holes of the stand?

After checking the above item and fixing any problems, turn on the stand. If the cause of the problem cannot be found even after checking the above item, consult your nearest Sony dealer.

Dolby Digital or DTS multi-channel sound is not reproduced.

- Check that the playing Blu-ray Disc, DVD, etc., is recorded in Dolby Digital or DTS format.
- When connecting the Blu-ray Disc, DVD player, etc., to the digital input jacks of this stand, check that audio setting (settings for the audio output) of the connected component.

The surround effect cannot be obtained.

- Depending on the digital signal, the surround processing may not work (page 25).

No sound or only a very low-level sound is heard from the speakers.

- Press VOLUME + and check the volume level.
- Press MUTE or VOLUME + to cancel the muting function.
- Press SOUND FIELD +/- and check the selected sound field.
- Depending on the source, the sound effect of the speakers may be less noticeable.

Sound lags behind the TV image.

- Set “A/V SYNC” to “OFF” when “A/V SYNC” is set to “ON.”
-

Connected components

There is no sound or only a very low-level sound no matter which component is selected.

- Check that this stand and components are connected correctly and securely.
- Check that both this stand and the selected component are turned on.

There is no sound from the selected component.

- Check that the component is connected correctly to the audio input jacks for that component.
- Check that the cords are fully inserted into the jacks on both the component and this stand.
- Check that the component is selected correctly.

Sound is interrupted or there is noise.

- Check “Formats supported by this stand” (page 38).

There is no picture appears on the TV screen.

- Check that the TV is selected correctly.
 - Set the TV to the appropriate input mode.
 - Check the HDMI connection.
 - Check that the cords are fully inserted into the jacks on both the component and this stand.
-

Control for HDMI

If you experience any of the following difficulties while using the “BRAVIA” Sync, use this troubleshooting guide to help you remedy the problem.

The Control for HDMI function does not work.

- Check the HDMI connection (page 11).
- Make sure “CTRL: HDMI” is set to “ON” in AMP menu.
- Make sure the connected component is compatible with the Control for HDMI function.
- Check the Control for HDMI settings on the connected component. See the operating instructions supplied of the connected component.
- If you change the HDMI connection, connect/disconnect the AC power cord (mains lead), or there is a power failure, repeat the procedures of ““BRAVIA” Sync Features” (page 27).
- The stand may not work correctly if you select a component that is not compatible with the Control for HDMI function on the TV side.
- Make sure “DVD CTRL”, “SAT CTRL” or “DMPORT. CTRL” is set to “ON” in AMP menu.

No sound is output from the stand and TV speaker.

- Check the volume of the stand and the TV.
- Select the input of the stand correctly.

The sound is output from both the stand and the TV.

- If the Control for HDMI function is set to off, or the selected component is not compatible with the Control for HDMI function, turn off the sound of the stand or the TV.

The System Power Off function does not work.

- Change the setting of the TV to turn connected components off automatically when you turn off the TV. For details, refer to the operating instructions of the TV.

An image does not appear on the TV.

- Check whether HDMI IN and HDMI OUT are connected in reverse.

A message stating that the output method has changed from the stand speaker to the TV speaker, appears on the TV screen.

- The Control for HDMI function for the selected component is set to off. For details, refer to “Connecting components without HDMI jacks” (page 13).

OTHER

The remote does not function.

- Point the remote at the remote sensor  on the stand.
- Remove any obstacles in the path between the remote and the stand.
- Replace both batteries in the remote with new ones, if they are weak.
- Make sure you select the correct input on the remote.

The volume turns down when the output method changes from the TV speaker to the stand speaker.

- The Volume Limit function is working. For details, refer to “Using the Volume Limit function” (page 31).

If the stand still does not operate properly after performing the above measures, reset the stand as follows:

Use buttons on the stand for the operation.

1 Press I/⏻ to turn on the power.

2 Press I/⏻ while pressing INPUT SELECTOR and VOLUME –.

“COLD RESET” appears and the stand is reset. AMP menu, sound field etc., return to the default settings.

Specifications

RHT-G900

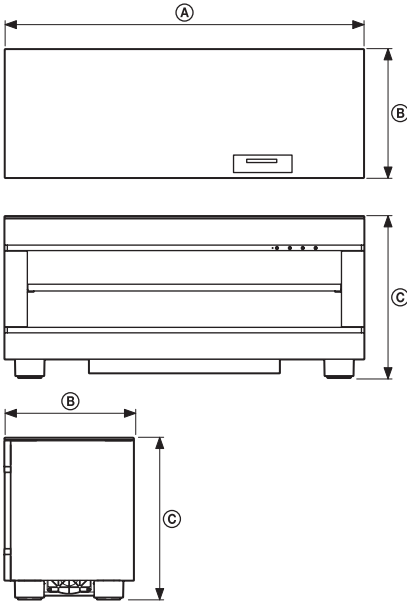

Dimensions: mm (approx.)	Ⓐ	1,115
	Ⓑ	400
	Ⓒ	500
Mass: kg		54

RHT-G1500

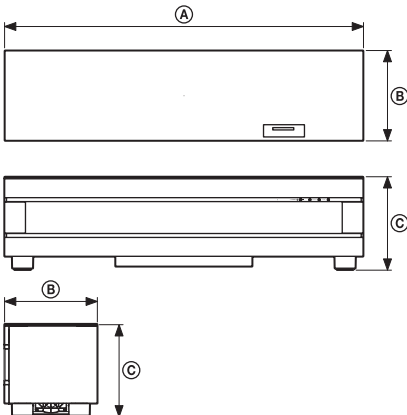

Dimensions: mm (approx.)	Ⓐ	1,550
	Ⓑ	400
	Ⓒ	400
Mass: kg		59

Formats supported by this stand

Digital input formats supported by this stand are as follows.

Format	Supported/Not supported
Dolby Digital	○
DTS	○
Linear PCM-2ch*	○
Linear PCM-7.1ch 48k* (Only on HDMI)	○
Linear PCM-7.1ch 96k	×
Dolby Digital Plus	×
Dolby True HD	×
DTS-HD	×

* Linear PCM accepts sampling frequencies of no more than 48 kHz.

Amplifier section

Rated Output Power
Stereo mode

50 W + 50 W, 6 ohms,
1 kHz, THD less than 1 %

Reference Output Power
Surround mode

Front: 70 W/ch, 6 ohms,
1 kHz, THD 10 %
Center*: 70 W/ch, 3 ohms,
1 kHz, THD 10 %
Surround*: 70 W/ch,
6 ohms, 1 kHz, THD 10 %
Subwoofer: 120 W,
3 ohms, 100 Hz, THD 10 %

* Depending on the sound field settings and the source, there may be no sound output.

Inputs (Analog)
TV

Sensitivity: 600 mV
Impedance: 30 kohms

Inputs (Digital)

TV, DVD	Optical
SAT	Coaxial, optical

FM tuner section

System	PLL quartz-locked digital synthesizer
Tuning range	87.5 – 108.0 MHz (50 kHz step)
Antenna (aerial)	FM wire antenna (aerial)
Antenna (aerial) terminals	75 ohms, unbalanced
Intermediate frequency	10.7 MHz

HDMI section

Connector	HDMI 19pin-standard connector
Video inputs/outputs	BD, DVD, SAT: 640 × 480p@60 Hz 720 × 480p@59.94/60 Hz 1440 × 480p@59.94/60 Hz (pixel sent 2 times) 1280 × 720p@59.94/60 Hz 1920 × 1080i@59.94/60 Hz 1920 × 1080p@59.94/60 Hz 720 × 576p@50 Hz 1440 × 576p@50 Hz (pixel sent 2 times) 1280 × 720p@50 Hz 1920 × 1080i@50 Hz 1920 × 1080p@50 Hz 1920 × 1080p@24 Hz
Audio inputs	BD, DVD, SAT: Linear PCM 7.1ch/Dolby Digital/DTS

Speakers

Front speaker unit

Speaker system	2-way, Bass reflex, Magnetically shielded
Speaker unit	Woofer: 50 mm, cone type Tweeter: 25 mm, balanced dome type

Center speaker unit

Speaker system	2-way, Bass reflex, Magnetically shielded
Speaker unit	Woofer: 50 mm, cone type × 2 Tweeter: 25 mm, balanced dome type

Surround speaker unit

Speaker system	Full range, Acoustic suspension, Magnetically shielded
Speaker unit	50 mm, cone type

Subwoofer unit

Speaker system	Bass reflex
Speaker unit	100 mm, cone type × 2

General

Power requirements	European model: 220 – 240 V, 50/60 Hz
Power consumption	On: 110 W Active Standby (Control for HDMI is on): 1.5 W or more Standby (Control for HDMI is off): less than 0.3 W
Dimensions (approx.)	RHT-G900 1,115 × 500 × 400 mm (w/h/d) RHT-G1500 1,550 × 400 × 400 mm (w/h/d)
Mass (approx.)	RHT-G900 54 kg RHT-G1500 59 kg
Supplied accessories	Optical cable (1 m) (1) Remote commander (RM-ANU032) (1) Size AA (R6) batteries (2) Top glass panel (1) Corner protectors (4) Support belt and two screws (small/large) (1) Shelf board (1) (RHT-G900 only) Shelf support pins (4) (RHT-G900 only) FM wire antenna (aerial) (1) Operating Instructions (1)

Design and specifications are subject to change without notice.



- Standby power consumption 0.3 W.
- Halogenated flame retardants are not used in the printed wiring boards.
- Over 85 % power efficiency of amplifier block is achieved with the full digital amplifier, S-Master.
- Halogenated flame retardants are not used in cabinets.

Glossary

Dolby Digital

This movie theater sound format is more advanced than Dolby Surround Pro Logic. In this format, the surround speakers output stereo sound with an expanded frequency range, and a subwoofer channel for deep bass is independently provided. This format is also called "5.1" with the subwoofer channel designed as the 0.1 channel (since it functions only when a deep bass effect is needed). All six channels in this format are recorded separately for superior channel separation. Furthermore, since all the signals are processed digitally, less signal degradation occurs.

Dolby Pro Logic II

Dolby Pro Logic II creates five full-bandwidth output channels from 2 channel sources. This is done using an advanced, high-purity matrix surround decoder that extracts the spatial properties of the original recording without adding any new sounds or tonal colorations.

DTS

Digital audio compression technology developed by Digital Theater Systems, Inc. This technology conforms to 5.1-channel surround. This format comprises of stereo rear channel and there is discrete subwoofer channel in this format. DTS provides the same 5.1 discrete channels of high quality digital audio. The good channel separation is realized due to the all channel data being recorded discretely and processed in digitally.

HDMI

HDMI (High-Definition Multimedia Interface) is an interface that supports both video and audio on a single digital connection, allowing you to enjoy high quality digital picture and sound. The HDMI specification supports HDCP (High-bandwidth Digital Contents Protection), a copy protection technology that incorporates coding technology for digital video signals.

PCM (Pulse Code Modulation)

A method of converting analog audio to digital audio for easy enjoyment of digital sound.

S-Force PRO Front Surround

Sony's long-term involvement in surround technology (and the vast amounts of acoustic data accumulated as a result) has led to the development of all-new processing method and advanced DSP to handle this task effectively, which we call S-Force PRO Front Surround. Compared with previous front surround technologies, S-Force PRO Front Surround reproduces a more convincing sense of distance and space, resulting in a true surround sound experience without the need for rear speakers.

S-Master

S-Master is an all-digital amplifier technology developed by Sony, which effectively minimizes the occurrence of sound fragmentation and jitter, delivering superb dialog clarity and faithful reproduction of the original sound. The compact amplifier section supports a higher power efficiency and improved thermal performance.

x.v.Colour

x.v.Colour is a more familiar term for the xvYCC standard proposed by Sony, and is a trademark of Sony. xvYCC is an international standard for color space in video. This standard can express a wider color range than the currently used broadcast standard.

Index

A

A/V SYNC 33
AMP menu 32
AUDIO DRC 34

B

Blu-ray Disc player (recorder)
connecting 11

D

DIGITAL MEDIA PORT
connecting 15
DISPLAY 23, 34
DUAL MONO 33
DVD player (recorder)
connecting 11, 13

N

NIGHT mode 26

P

“PlayStation 3”
connecting 11

R

Radio 22
Radio stations 21
Remote
before use 8
operating 18

S

Satellite tuner
connecting 11, 13
Setting 9
S-Force PRO Front Surround 7
Sleep timer 35
Sound field 25

X

x.v.Colour 40



* 3 2 9 1 7 3 0 2 1 * (1)

Free Manuals Download Website

<http://myh66.com>

<http://usermanuals.us>

<http://www.somanuals.com>

<http://www.4manuals.cc>

<http://www.manual-lib.com>

<http://www.404manual.com>

<http://www.luxmanual.com>

<http://aubethermostatmanual.com>

Golf course search by state

<http://golfingnear.com>

Email search by domain

<http://emailbydomain.com>

Auto manuals search

<http://auto.somanuals.com>

TV manuals search

<http://tv.somanuals.com>