

■ Theatre Stand ■ System

Operating Instructions

RHT-G500



WARNING

To reduce the risk of fire or electric shock, do not expose this apparatus to rain or moisture.

Do not install the appliance in a confined space, such as a bookcase or built-in cabinet.

To prevent fire, do not cover the ventilation of the apparatus with news papers, table-cloths, curtains, etc. And don't place lighted candles on the apparatus.

To prevent fire or shock hazard, do not place objects filled with liquids, such as vases, on the apparatus.

Batteries or batteries installed apparatus shall not be exposed to excessive heat such as sunshine, fire or the like.



Disposal of Old Electrical & Electronic Equipment (Applicable in the European Union and other European countries with separate collection systems)

This symbol on the product or on its packaging indicates that this product shall not be treated as household waste. Instead it shall be handed over to the applicable collection point for the recycling of electrical and electronic equipment. By ensuring this product is disposed of correctly, you will help prevent potential negative consequences for the environment and human health, which could otherwise be caused by inappropriate waste handling of this product. The recycling of materials will help to conserve natural resources. For more detailed information about recycling of this product, please contact your local Civic Office, your household waste disposal service or the shop where you purchased the product.



Disposal of waste batteries (applicable in the European Union and other European countries with separate collection systems)

This symbol on the battery or on the packaging indicates that the battery provided with this

product shall not be treated as household waste. By ensuring these batteries are disposed of correctly, you will help prevent potentially negative consequences for the environment and human health which could otherwise be caused by inappropriate waste handling of the battery. The recycling of the materials will help to conserve natural resources. In case of products that for safety, performance or data integrity reasons require a permanent connection with an incorporated battery, this battery should be replaced by qualified service staff only. To ensure that the battery will be treated properly, hand over the product at end-of-life to the applicable collection point for the recycling of electrical and electronic equipment. For all other batteries, please view the section on how to remove the battery from the product safely. Hand the battery over to the applicable collection point for the recycling of waste batteries. For more detailed information about recycling of this product or battery, please contact your local Civic Office, your household waste disposal service or the shop where you purchased the product.

The manufacturer of this product is Sony Corporation, 1-7-1 Konan Minato-ku Tokyo, 108-0075 Japan. The Authorized Representative for EMC and product safety is Sony Deutschland GmbH, Hedelfinger Strasse 61, 70327 Stuttgart, Germany. For any service or guarantee matters please refer to the addresses given in separate service or guarantee documents.

Table of Contents

WARNING	4
CAUTION.....	5
Precautions	6
Main features	7

Getting Started

Supplied accessories	8
Setting this stand	9
Connecting components with HDMI jacks	10
Connecting components without HDMI jacks	12
Setting up the sound output of the connected component	13
Connecting the DIGITAL MEDIA PORT adapter	14

Playback Options

Index to parts and controls	15
Enjoying TV	18
Enjoying other components	19

Surround Function

Enjoying the surround effect.....	20
-----------------------------------	----

“BRAVIA” Sync Features

What is “BRAVIA” Sync?.....	21
Preparing for the “BRAVIA” Sync.....	21
Enjoying Blu-ray Disc/DVD.....	24
(One-Touch Play)	
Enjoying the TV sound from the speakers	24
(System Audio Control)	
Turning off the TV, system and connected components	26
(System Power Off)	

Advanced Settings

Setting up the speakers level.....	27
Settings and adjustments using the amplifier menu.....	28

Additional Information

Troubleshooting	33
Specifications	35
Glossary.....	37
Index.....	39

WARNING

Do not lean on or hang from the TV when the TV is placed on the stand.

The TV may fall from the stand causing an accident resulting in serious injury or death.

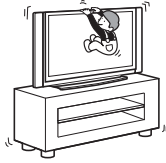

Do not hold the base when moving the stand.

When you move the stand, hold the lower part of the top shelf. If you hold the base as in the illustration, there is a risk that the plinth section may detach and the stand may fall.

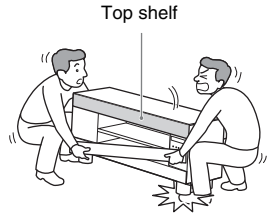

Do not move the stand with the TV or other equipment installed on it.

Be sure to remove the TV and other equipment when moving the stand. If you fail to do so, the stand may lose balance and topple over resulting in serious injury.

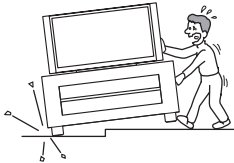

Do not allow the AC power cord (mains lead) or the connecting cable to be pinched between the TV and the stand.

- The AC power cord (mains lead) or the connecting cable may be damaged resulting in fire or electric shock.
- When moving the stand, be careful not to trap the AC power cord (mains lead) or the connecting cable under the stand.

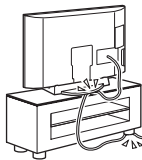

Do not allow children to climb on the stand or crawl between the shelves.

If children climb on the stand or get between the shelves, serious injury or death can result if the stand breaks or topples over.



CAUTION

Do not place any heated objects such as a hot pan or a kettle on the stand.

It may cause damage to the stand.

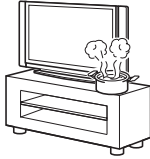

Do not step on the stand.

You may fall, or break the stand and cause injury.

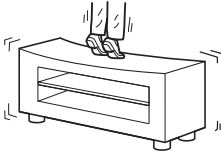

This stand is only for the specified TV.

Confirm whether this stand is mentioned as a supported product in the operating instructions of the TV.

Notes on installation

- Be careful not to pinch your hand or fingers between the TV and the stand.
- To prevent the stand from distorting, observe the following:
 - Install the stand on a solid and flat surface.
 - If you install the stand on a soft surface such as a mat, first lay a board under the stand.
 - Do not install the stand in a place subject to direct sunlight or near a heater.
 - Do not install the stand in a hot or humid place, or outdoors.
- Moving the stand requires two people or more. Move the stand only after removing the TV. If you fail to do so, the TV may fall from the stand resulting in serious injury. Do not hold the grille as it may detach from the stand resulting in serious injury. Be careful not to pinch your fingers when moving the stand.

Note on load capacity

Do not place any equipment exceeding the specified maximum weight on the stand, as indicated in the illustration below. Otherwise, it may fall or break.

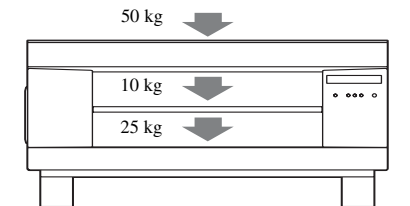

Precautions

On safety

- Do not place unspecified objects, such as a flower vase or pottery on the stand.
- Do not make alterations to the stand.
- Should any solid object or liquid fall into the stand, unplug the stand and have it checked by qualified personnel before operating it any further.

On power sources

- Before operating the stand, check that the operating voltage is identical to your local power supply. The operating voltage is indicated on the nameplate at the rear of the stand.
- The stand is not disconnected from the AC power source (mains) as long as it is connected to the wall outlet (mains), even if the stand itself has been turned off.
- If you are not going to use the stand for a long time, be sure to disconnect the stand from the wall outlet (mains). To disconnect the AC power cord (mains lead), grasp the plug itself; never pull the cord.
- One blade of the plug is wider than the other for the purpose of safety and will fit into the wall outlet (mains) only one way. If you are unable to insert the plug fully into the outlet, contact your dealer.
- AC power cord (mains lead) must be changed only at the qualified service shop.
- Install this stand so that the power cord can be unplugged from the wall socket immediately in the event of trouble.

On placement

- Place the stand in a location with adequate ventilation to prevent heat buildup and prolong the life of the stand.
- Use caution when placing the stand on surfaces that have been specially treated (with wax, oil, polish, etc.) as staining or discoloration of the surface may result.
- The floor may be damaged if sand, trash, etc., gets caught under the legs of the stand.

On operation

Before connecting other components, be sure to turn off and unplug the stand.

On cleaning

Clean the stand, panel and controls with a soft cloth slightly moistened with a mild detergent solution. Do not use any type of abrasive pad, scouring powder or solvent such as alcohol or benzine.

If you have any question or problem concerning your stand, please consult your nearest Sony dealer.

Copyrights

This stand incorporates Dolby* Digital and Pro Logic Surround and the DTS** Digital Surround System.

* Manufactured under license from Dolby Laboratories.

Dolby, Pro Logic and the double-D symbol are trademarks of Dolby Laboratories.

** Manufactured under license under U.S. Patent #'s: 5,451,942; 5,956,674; 5,974,380; 5,978,762; 6,487,535 & other U.S. and worldwide patents issued & pending. DTS and DTS Digital Surround are registered trademarks and the DTS logos and Symbol are trademarks of DTS, Inc. © 1996-2007 DTS, Inc. All Rights Reserved.

This stand incorporates High-Definition Multimedia Interface (HDMI™) technology.

HDMI, the HDMI logo and High-Definition Multimedia Interface are trademarks or registered trademarks of HDMI Licensing LLC.

“BRAVIA” is a trademark of Sony Corporation.

Main features

► Easy connection with HDMI

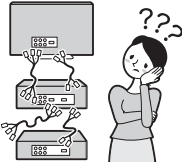

The cords are all tangled up.

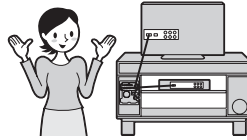

Neat connections (page 10).

► Easy operation with only one TV remote ("BRAVIA" Sync)



Separate remotes for each component.

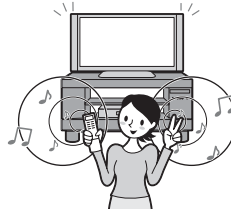

Consolidate operations on one remote (page 21).

► Easy Surround settings

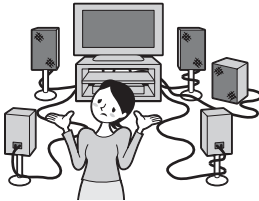

I need lots of cords and speakers.

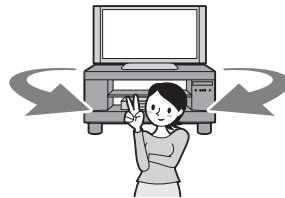

Easy set-up with S-Force PRO Front Surround.

About S-Force PRO Front Surround

Sony's long-term involvement in surround technology (and the vast amounts of acoustic data accumulated as a result) has led to the development of all-new processing method and advanced DSP to handle this task effectively, which we call S-Force PRO Front Surround. Compared with previous front surround technologies, S-Force PRO Front Surround reproduces a more convincing sense of distance and space, resulting in a true surround sound experience without the need for rear speakers.

Recommended surround-sound area

You can enjoy surround sound in the areas in which sound is spread as illustrated.

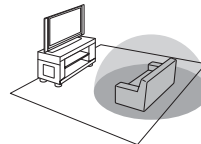

Getting Started

Supplied accessories

Please check the following accessories in the package.

Optical cable (1.5 m) (1)

Remote commander (RM-ANU041) (1)

Size AA (R6) batteries (2)

Support belt and two screws (small/large) (1)

Shelf board (1)

Shelf support pins (4)

Operating Instructions (1)

Inserting batteries into the remote

You can control the stand using the supplied remote. Insert two size AA (R6) batteries by matching the + and – ends on the batteries to the markings inside the compartment.

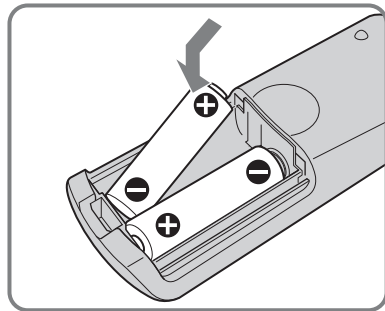
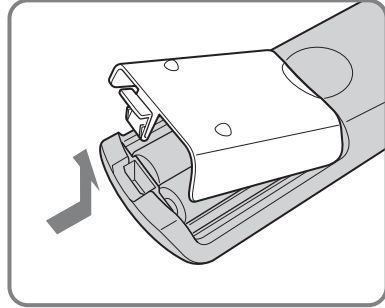

Notes

- Do not leave the remote in an extremely hot or humid place.
- Do not use a new battery with an old one.
- Do not drop any foreign object into the remote casing, particularly when replacing the batteries.
- Do not expose the remote sensor to direct light from the sun or lighting apparatus. Doing so may cause a malfunction.
- If you do not intend to use the remote for an extended period of time, remove the batteries to avoid possible damage from battery leakage and corrosion.

Setting this stand

Preventing the TV from toppling over

As a protective measure, secure the TV. Perform following steps as a protective measure if you have a Sony LCD TV.

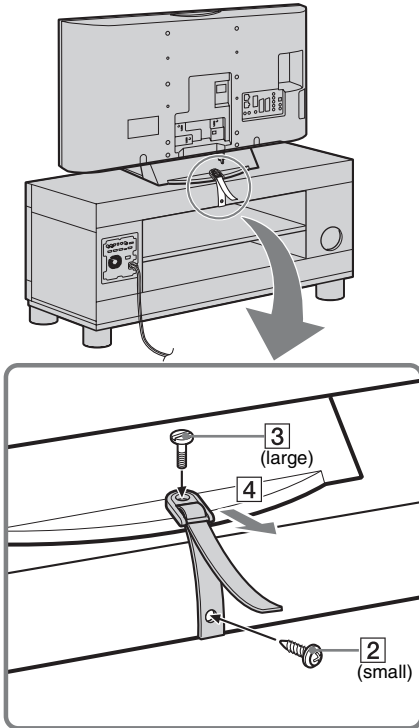

- 1** Place the TV on the center of the stand.
- 2** Fasten the support belt (supplied) to the stand with the small screw (supplied).
Tighten the screw into the rear hole, as in the illustration.
- 3** Fit the support belt to the TV, then firmly fasten with the large screw (supplied) using a screw driver or coin, etc.

- 4** While supporting the TV, tighten the support belt to secure in place.

Installing the shelf board

- 1** Insert the attaching shelf support pins (supplied) into the holes in the stand.
- 2** Fit the shelf board onto the shelf support pins horizontally. This requires people.

Installing this stand

Install the stand after connecting all the components to the stand.

Install the stand, allowing for at least 10 cm space between the wall and the rear of the stand, and 30 cm between the wall and the left side of the stand. This is to allow for heat dissipation and to prevent the TV from falling.

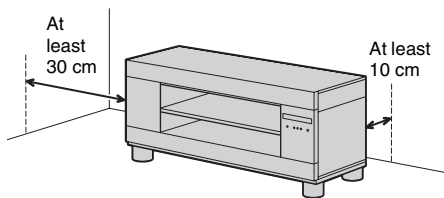

Note

- Be careful not to pinch your fingers when setting up the stand.

Connecting components with HDMI jacks

We recommend that you connect components to the system using an HDMI cable.

With HDMI, you can easily enjoy both high quality sound and high quality images.

However, it is necessary to connect the audio output of the TV to the audio input of the system using an optical cable or an audio cord

in order to listen to the TV's sound from the system.

For details on the Control for HDMI function, refer to ““BRAVIA” Sync Features” (page 21).

Connect the AC power cord (mains lead) after you have finished connecting all components to the system.

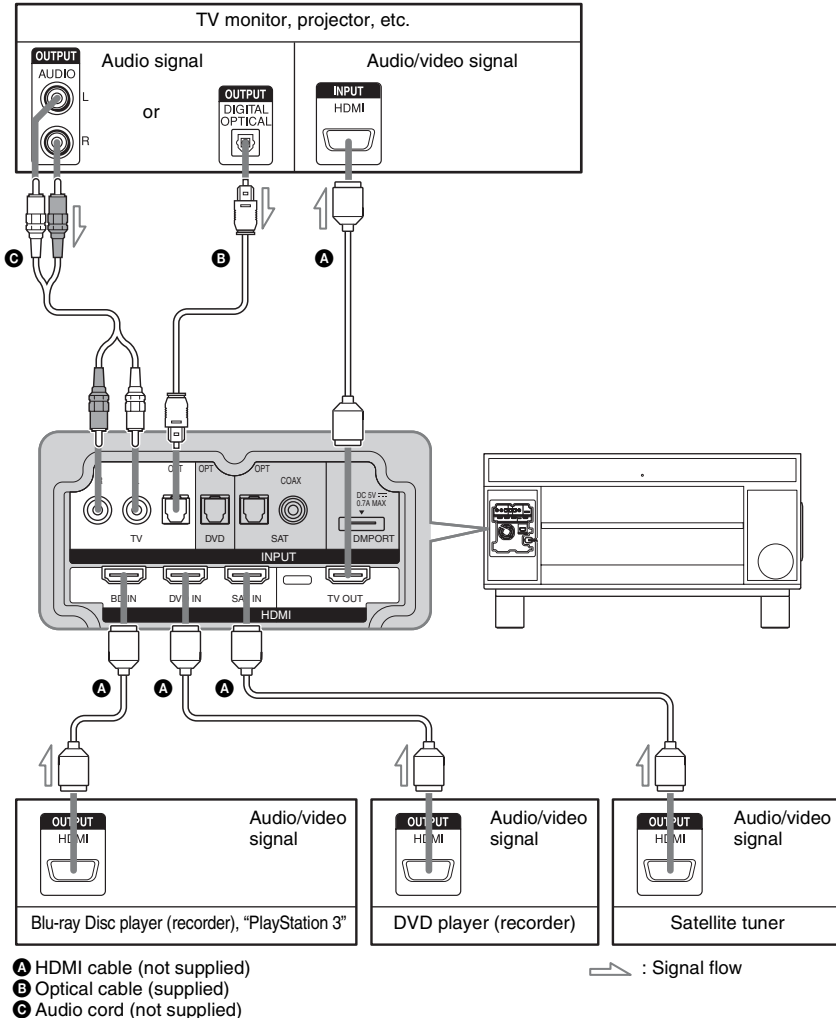

Notes

- Refer to page 12 for how to connect a component without an HDMI jack.
- The HDMI jack has priority when you connect the component to the system using HDMI, INPUT COAX and INPUT OPT together.
- The INPUT OPT jack has priority when you connect both the audio output of the TV to the INPUT OPT and AUDIO jack of the system.

Notes on HDMI connections

- You can enjoy high quality images using an HDMI cable with an HDMI logo. We recommend that you use a Sony HDMI cable.
- Check the setup of the connected component if an image is poor or the sound does not come out of a component connected via the HDMI cable.
- Audio signals (sampling frequency, bit length, etc.) transmitted from an HDMI jack may be suppressed by the connected component.
- Sound may be interrupted when the sampling frequency or the number of channels of audio output signals from the playback component is switched.
- When the connected component is not compatible with copyright protection technology (HDCP), the image and/or the sound from the HDMI TV OUT jack may be distorted or may not be output.
In this case, check the specification of the connected component.
- We do not recommend using an HDMI-DVI conversion cable.
- No matter what input is selected for the system, video signals from the HDMI input jack (BD, DVD, SAT) that was selected last time are output from the HDMI TV OUT jack.

Connecting components without HDMI jacks

When you connect a DVD player (recorder), satellite tuner, "PlayStation 2", etc., that has no HDMI jacks, connect to the system using the INPUT OPT or INPUT COAX jack.

If the satellite tuner does not have the OPTICAL OUT jack, connect the system using the INPUT

COAX jack. In this case, it is not necessary to connect all the cables. Connect the audio cords according to the jacks of your components.

Connect the AC power cord (mains lead) last.

* "PlayStation 2" is a trademark of Sony Computer Entertainment Inc.

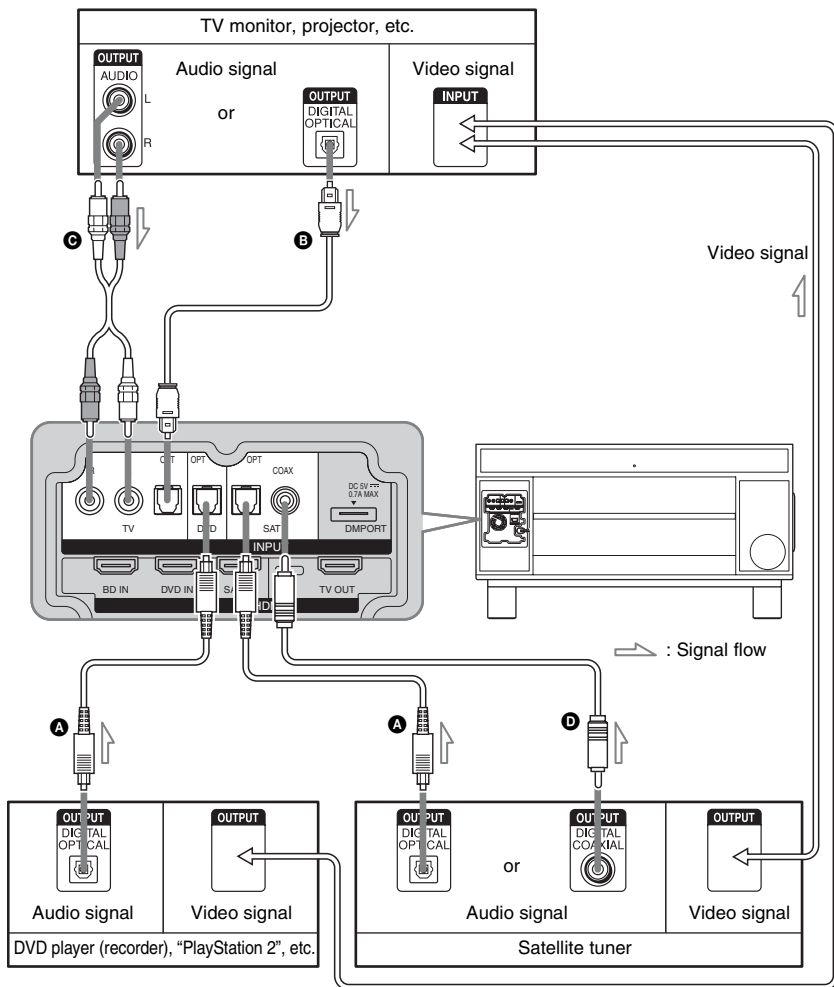

- Ⓐ Optical cable (not supplied)
- Ⓑ Optical cable (supplied)
- Ⓒ Audio cord (not supplied)
- Ⓓ Coaxial digital cord (not supplied)

Note

- The INPUT OPT jack has priority when you connect both the audio output of the TV to the INPUT OPT and AUDIO jack of the system.

If you connect any of the components with HDMI jacks, and the Control for HDMI function is set to on

Set “CTRL: HDMI” to “OFF” in the AMP menu of the system for the component connected to the system using the INPUT OPT or INPUT COAX jack (except a TV) individually. For details, refer to “Setting the Control for HDMI function to off for a component without HDMI jacks” (page 23).

Setting up the sound output of the connected component

Depending on the audio output settings of the connected component, the sound may output in 2 channel sound format only. In this case, set the connected component to output the sound in multi channel sound format (PCM, DTS, Dolby Digital). For details on audio output settings, refer to the operating instructions supplied with the connected component.

Connecting the DIGITAL MEDIA PORT adapter

You can enjoy sound from the connected component on the system by connecting the DIGITAL MEDIA PORT adapter.

Connect the AC power cord (mains lead) last.

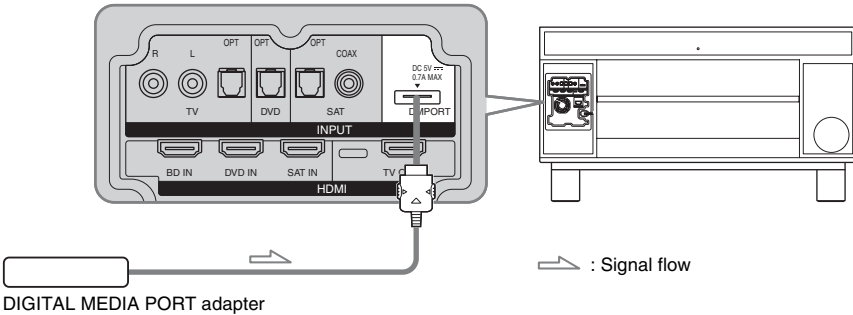

Notes

- Do not connect or disconnect the DIGITAL MEDIA PORT adapter while the system is turned on.
- When you connect the DIGITAL MEDIA PORT adapter, be sure the connector is inserted with the arrow mark facing toward the arrow mark on the DMPORT jack. To detach the DIGITAL MEDIA PORT adapter, press and hold **A** and then pull out the connector.

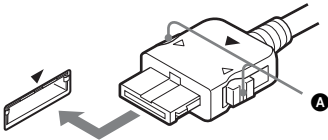

Index to parts and controls

For more information, refer to the pages indicated in parentheses.

Front panel

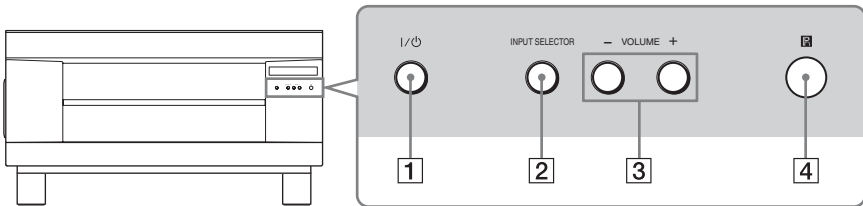

- 1 I/⏻ (on/standby)**
Press to turn the stand on or off.
- 2 INPUT SELECTOR**
Press to select the input source to play back.
- 3 VOLUME +/-**
Press to adjust the volume.
- 4  (remote sensor)**
Point the remote commander towards here.

continued

15^{GB}

Front panel display

About the indications in the front panel display

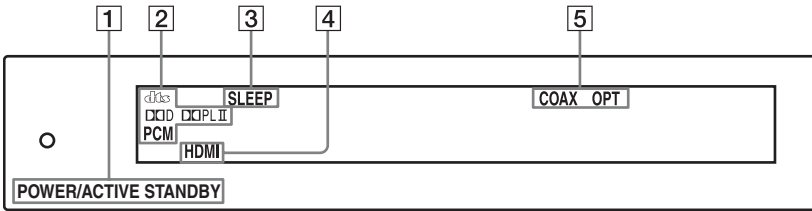

1 POWER / ACTIVE STANDBY indicator

Lights as follows:

Green: The system is turned on.

Amber: The Control for HDMI function is working while the system is turned off.

Off: The system is turned off, and the Control for HDMI function is not working.

2 Lights up according to the audio input signals.

3 SLEEP (32)

Flashes when the sleep timer function is active.

4 HDMI (10, 34)

Lights up when the HDMI equipment is being used.

5 COAX/OPT

Lights up according to the cable which you are using.

Remote control

Here describes the buttons for the operation of this stand and a connected component through DMPORT connection.

Note

- Point the remote at the remote sensor  on the stand.

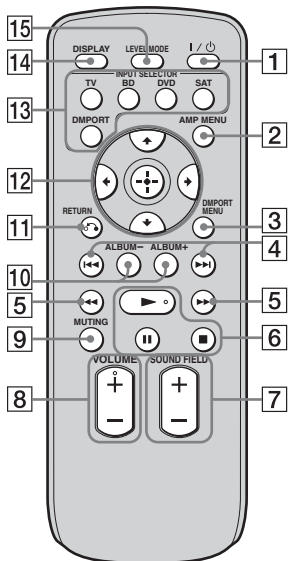

- * The  and VOLUME + buttons have a tactile dot. Use it as a guide during operation.

Buttons for the operation of this stand

- 1 **I/O (on/standby)**
Press to turn the system on or off.
- 2 **AMP MENU**
Press to display the menu of the system (page 28).
- 7 **SOUND FIELD +/-**
Press to select the sound field (page 20).
- 8 **VOLUME +/-**
Press to adjust the volume.
- 9 **MUTING**
Press to turn off the sound.

- 11 **RETURN**
Press to return to the previous menu.
- 12 **←, ↑, ↓, → or (+)**
Press ←, ↑, ↓ or → to select the settings. Then press (+) to enter the selection.
- 13 **INPUT SELECTOR**
Press one of the buttons to select the component you want to use. The buttons are factory assigned to control Sony components. You can change the factory settings of the input buttons to suit the components in your system.
- 14 **DISPLAY**
Press to switch the information in the front panel display.
- 15 **LEVEL MODE**
Press to adjust the level of the center speaker and subwoofer. This setting is applied to all sound fields.

Buttons for the operation of a connected component through DMPORT connection

The following explanations are for example only. Depending on the component, the following operations may not be possible, or may be different than described.

- 3 **DMPORT MENU**
Press to display the menu.
- 4 **⏮/⏭**
Press to skip chapters.
- 5 **⏪/⏩**
Press to fast reverse or to fast forward.
- 6 **▶ (playback)/⏸ (pause)/■ (stop)**
Play mode buttons.
- 10 **ALBUM +/-**
Press to select an album.
- 11 **RETURN**
Press to return to the previous menu.
- 12 **←, ↑, ↓, → or (+)**
Press to select a menu item and enter the selection.

Enjoying TV

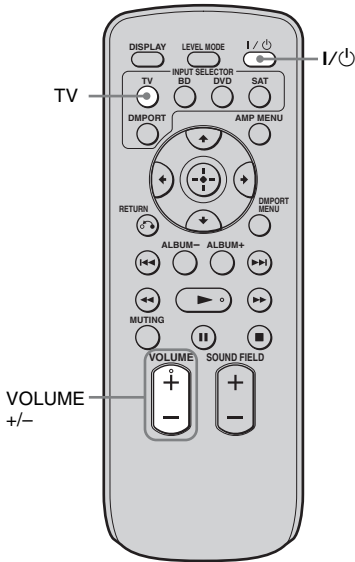

- 1 Turn on the TV and choose a program.**
Refer to the operating instructions of your TV for details.
- 2 Press I/O to turn the system on.**
- 3 Press TV on the remote.**
- 4 Press VOLUME +/- to adjust the volume of the system.**

Tip

- The sound may be output from the TV's speaker. In this case, turn the volume of the TV's speaker down to the minimum.

Enjoying other components

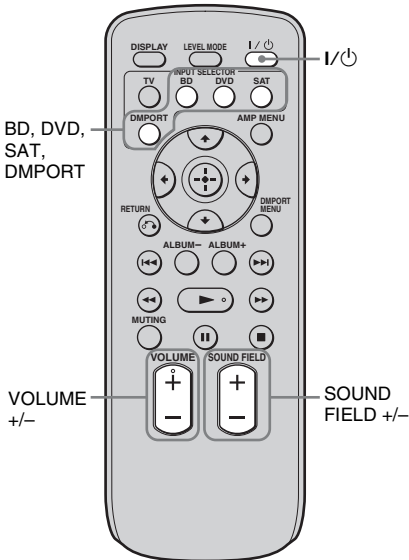

Enjoying a satellite tuner

- 1 Turn on the TV.**
Refer to the operating instructions of your TV for details.
- 2 Turn the satellite tuner on and press I/⏻ to turn the system on.**
Refer to the operating instructions of your satellite tuner for details.
- 3 Press SAT on the remote.**
- 4 Change the TV input.**
Refer to the operating instructions of your TV for details.
- 5 Press VOLUME +/- to adjust the volume of the system.**

Tip

- The sound may be output from the TV's speaker. In this case, turn the volume of the TV's speaker down to the minimum.

Enjoying Blu-ray Disc, DVD or "PlayStation 3"

- 1 Turn on the TV.**
- 2 Turn the Blu-ray Disc/DVD player (recorder) or "PlayStation 3" on and press I/⏻ to turn the system on.**
Refer to the operating instructions of your component for details.
- 3 Press BD or DVD on the remote.**
- 4 Change the TV input.**
Refer to the operating instructions of your TV for details.
- 5 Play back the disc.**

Tip

- Even if you play back Dolby True HD, Dolby Digital Plus or DTS HD with a connected component compatible with these sound formats, the system accepts as Dolby Digital or DTS. When you play back these high-quality sound formats, set the connected component to output the sound in multi channel PCM, if possible.

Enjoying a connected component through DMPORT connection

- 1 Press DMPORT on the remote.**
- 2 Start playback of the connected component.**

Tip

- When listening to MP3 or other compressed music files using a portable audio source, you can enhance the sound. Press SOUND FIELD +/- repeatedly until "P. AUDIO" appears in the front panel display.

Surround Function

Enjoying the surround effect

Selecting the sound field

This system can create multi channel surround sound. You can select one of the optimized sound fields from system's preprogrammed sound fields.

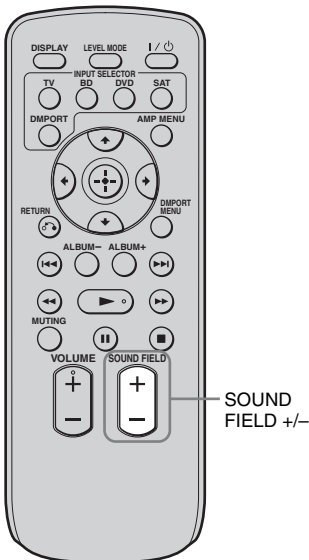

Press SOUND FIELD +/-.

The present sound field appears.
Each time you press the SOUND FIELD +/-, the display changes cyclically as follows:
STANDARD ↔ MOVIE ↔ MUSIC ↔
SPORTS ↔ GAME ↔ P.AUDIO* ↔
STANDARD.....

Press SOUND FIELD +/- repeatedly until the sound field you want appears.



Available sound fields

Sound field	Effect
STANDARD	You can enjoy normal sound.
MOVIE	You can enjoy powerful sound in which low-pitched sound is emphasized, with enhanced presence.
MUSIC	This sound field is the best for listening to music, and you can enjoy the full surround sound experience.
SPORTS	You can enjoy the atmosphere of a game, and listen to the exciting play-by-play description.
GAME	This sound field is best for playing video games.
P. AUDIO*	You can enjoy enhanced sound when you listen to MP3 or other compressed music files using a portable audio source.

* "P. AUDIO" appears only when DMPORT is selected for the input source to playback.

Tips

- The sound fields memorized for each input are retained even if you disconnect the AC power cord (mains lead).
- Multi-channel sound is processed by the surround feature in any sound field. Also, multi-channel sound is processed by the surround feature for any sound in "MOVIE" or "SPORTS."

“BRAVIA” Sync Features

What is “BRAVIA” Sync?

By connecting Sony components that are compatible with the “BRAVIA” Sync with an HDMI cable (not supplied), operation is simplified as below:

- **One-Touch Play:** When you play back a component such as a Blu-ray Disc/DVD player (recorder), the system and the TV are turned on automatically and switch to the appropriate HDMI input.
- **System Audio Control:** While watching TV, you can select to output the sound from the TV speaker or the speakers of the system.
- **System Power Off:** When you turn off the TV, the system and the connected components are also turned off simultaneously.

“BRAVIA” Sync is compatible with a Sony TV, Blu-ray Disc/DVD player, AV amplifier, etc., with the Control for HDMI function.

CONTROL FOR HDMI is a mutual control function standard used by CEC (Consumer Electronics Control) for HDMI (High-Definition Multimedia Interface).

The Control for HDMI function will not operate in the following cases:

- When you connect this system to a component which is not compatible with the Control for HDMI function.
- When you connect the system and components using other than HDMI connection.

We recommend that you connect this system to products featuring “BRAVIA” Sync.

Note

- Depending on the connected component, the Control for HDMI function may not work. See the operating instructions of the component.

Preparing for the “BRAVIA” Sync

To use the “BRAVIA” Sync, set the Control for HDMI function to on for the system and the connected component.

When you connect a Sony TV with the Control for HDMI function, the Control for HDMI function for the system and the connected component can be set simultaneously by setting the Control for HDMI function of the TV.

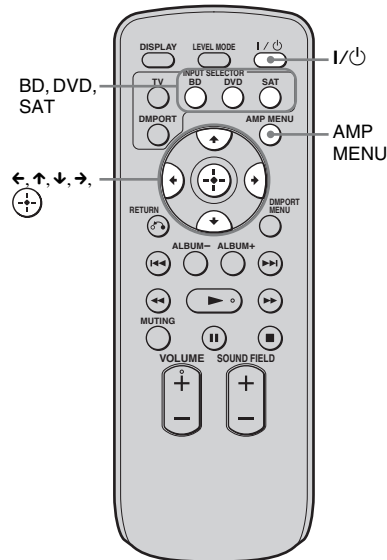

- 1 Make sure that the system is connected to the TV and the connected components (which should be compatible with the Control for HDMI function) using HDMI cables (not supplied).**
- 2 Turn on the system, the TV and the connected components.**

continued

3 Select the input of the system connected to the component you want to watch (BD, DVD, SAT), and switch the HDMI input of the TV, so that an image from the connected component is displayed.

4 Set the Control for HDMI function of the TV to on.

The Control for HDMI function for the system and the connected component is simultaneously set to on.

During the setting, "SCANNING" appears in the front panel display. After you finish the setting, "COMPLETE" appears in the front panel display. Wait until the setting is complete.

If "SCANNING" or "COMPLETE" does not appear after performing the steps above

Set the Control for HDMI function to on for the system and the connected component individually.

1 Press AMP MENU.

2 Press ↓/↑ repeatedly until "SET HDMI" appears, then press  or →.

3 Press ↓/↑ repeatedly until "CTRL: HDMI" appears, then press  or →.

4 Press ↓/↑ to select "ON."

5 Press AMP MENU.

The AMP menu turns off. The Control for HDMI function is set to on.

6 Set the Control for HDMI function of the connected component to on.

For details on setting the connected component, refer to its operating instructions.

7 Select the input of the system connected to the component you want to use the Control for HDMI function for (BD, DVD, SAT), and repeat step 6.

If you add or reconnect the component

Perform steps of "Preparing for the "BRAVIA" Sync" and "If "SCANNING" or "COMPLETE" does not appear after performing the steps above" again.

Notes

- During the setting of the Control for HDMI function for the system, the System Audio Control function does not work.
- If the Control for HDMI function for the connected component cannot be set simultaneously by setting "CONTROL FOR HDMI" of the TV, set the Control for HDMI function using the menu of the connected component.
- For details on setting the TV and the connected components, refer to their operating instructions.

Tip

- The default setting of the Control for HDMI function of the system is "OFF."

Setting the Control for HDMI function to off for a component without HDMI jacks

To listen to the sound of the component without HDMI jacks when the Control for HDMI function is set to on, set it to off for that component individually.

Tip

- When you connect the video output of the DIGITAL MEDIA PORT adapter to the video input of the TV, set the "DMPORT. CTRL" to "OFF." When you connect the DIGITAL MEDIA PORT adapter without video output jack, set the "DMPORT. CTRL" to "ON."

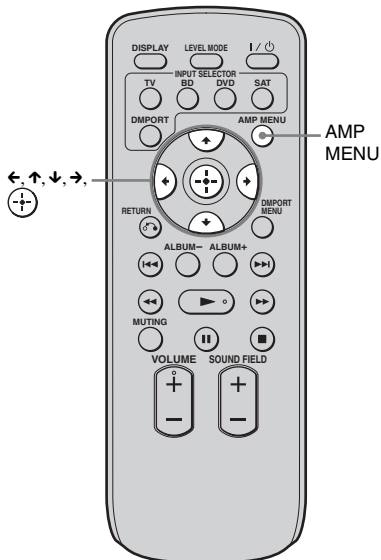

- 1** Press AMP MENU.
- 2** Press ↓/↑ repeatedly until "SET HDMI" appears, then press ↻ or →.
- 3** Press ↓/↑ to select the component you want to set the Control for HDMI function to off for (DVD CTRL, SAT CTRL or DMPORT. CTRL), then press ↻ or →.
- 4** Press ↓/↑ to select "OFF."
- 5** Press AMP MENU.
The AMP menu turns off.

Note

- Unless the Control for HDMI function is set to off for a component without HDMI jacks, the sound of that component may not be output from the system.

Enjoying Blu-ray Disc/DVD

(One-Touch Play)

Play back a connected component.

The system and the TV are turned on automatically and switch to the appropriate HDMI input.

Note

- Depending on the TV, the start of the content may not be output.

Tip

- You can enjoy the Blu-ray Disc/DVD player (recorder) connected to the system, even if you turn the system off. The POWER / ACTIVE STANDBY indicator lights up in amber at this time.

Enjoying the TV sound from the speakers

(System Audio Control)

You can enjoy the TV sound from the speakers of the system by means of a simple operation. For details, see the operating instructions of the TV.

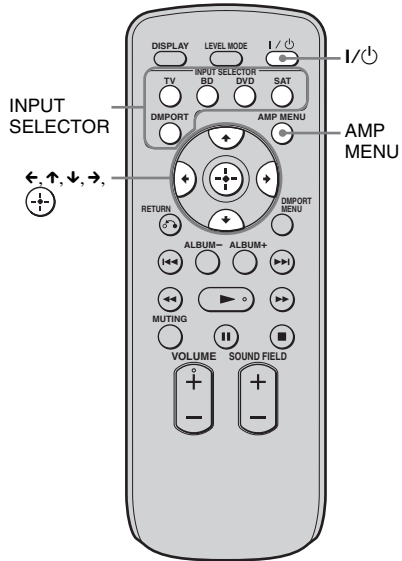

Press I/⏻ to turn on the system.

The sound is output from the speaker of the system. The sound is output from the TV's speaker when you turn the system off.

Notes

- When the TV is turned on before this system is turned on, the TV sound will not be output for a moment.
- When you connect a TV that does not have System Audio Control function, the System Audio Control function does not work.

Tip

- You can adjust the volume and turn off the sound of the system using the TV remote.

Using the Volume Limit function

When the System Audio Control function is active, and the output method changes from the TV speaker to the system speaker automatically, loud sound may be output depending on the volume level of the system. You can prevent this by limiting the maximum volume level.

- 1 Press AMP MENU.**
- 2 Press \downarrow/\uparrow repeatedly until "SET HDMI" appears, then press \oplus or \rightarrow .**
- 3 Press \downarrow/\uparrow repeatedly until "VOL LIMIT" appears, then press \oplus or \rightarrow .**
- 4 Press \downarrow/\uparrow to select the maximum volume level you want.**

The maximum volume level changes as follows:

MAX \leftrightarrow 49 \leftrightarrow 48.....2 \leftrightarrow 1 \leftrightarrow MIN

- 5 Press AMP MENU.**
The AMP menu turns off.

Notes

- This function is available only when the Control for HDMI function is set to on.
- This function is not available when the output method changes from the system speaker to the TV speaker.

Tips

- We recommend that you set the maximum volume level to a little lower than the volume you usually listen to.
- Regardless of the maximum volume level you set, the VOLUME +/- buttons of the system and the remote are operable.
- If you do not want to limit the maximum volume level, select "MAX."

Using the INPUT SELECTOR buttons of the remote

The INPUT SELECTOR buttons (TV, BD, DVD, SAT) work as follows when the Control for HDMI function is set to on.

- BD, DVD, SAT: The system's audio input is switched to the corresponding component's sound by pressing the button. The TV's video input is also switched to the component's image automatically.
- TV: The system's audio input is switched to the TV sound by pressing this button. The TV's video input is not switched automatically. Select the TV channel you want to watch with the TV remote.

Turning off the TV, system and connected components

(System Power Off)

When you turn the TV off by using the POWER button on the TV's remote, the system and the connected components turn off automatically.

Note

- Depending on the status, the connected components may not be turned off. For details, see operating instructions supplied with the connected components.

6 Press LEVEL MODE.

Advanced Settings

Setting up the speakers level

You can adjust the level of the center speaker and the subwoofer. This setting is applied to all sound fields.

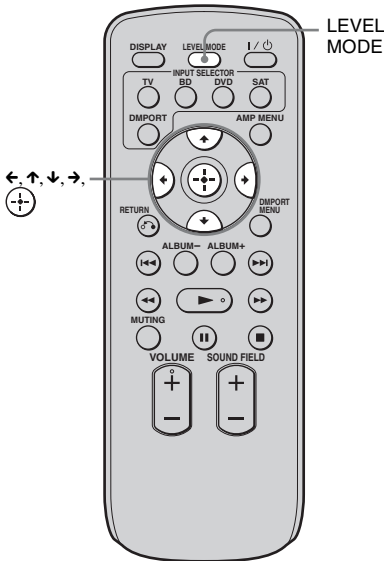

- 1 Start playing a source encoded with multi channel surround effects (DVD, etc.).
- 2 Press LEVEL MODE.
- 3 Press \downarrow/\uparrow to select “CNT LEVEL (center speaker level)” or “SW LEVEL (subwoofer level).”
- 4 Press \ominus/\oplus or \rightarrow .
- 5 While monitoring the sound, press \downarrow/\uparrow to select the setting you want.

Default setting: 0 (dB)

You can adjust from -6 (dB) to +6 (dB) in 1 (dB) steps.

Settings and adjustments using the amplifier menu

2 Press **←/↑/↓/→** repeatedly to select the item and the setting.

3 Press **AMP MENU** to turn off the AMP menu.

Using the AMP menu

You can set the following items with AMP MENU on the remote.

The default settings are underlined.

AMP MENU

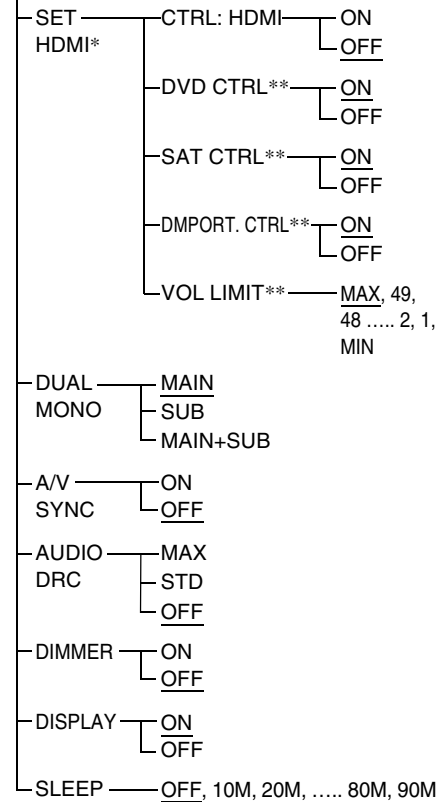

* Refer to ““BRAVIA” Sync Features” (page 21).

** This setting appears only when “CTRL: HDMI” is set to “ON.”

1 Press **AMP MENU** to turn on the AMP menu.

The following pages show details for each setting.

Enjoying multiplex broadcast sound (DUAL MONO)

You can enjoy multiplex broadcast sound when the system receives an AC-3 multiplex broadcast signal.

Note

- To receive AC-3 signal, you need to connect a digital satellite tuner to the system with an optical cable or coaxial cable, and set the digital output mode of the digital satellite tuner to AC-3.

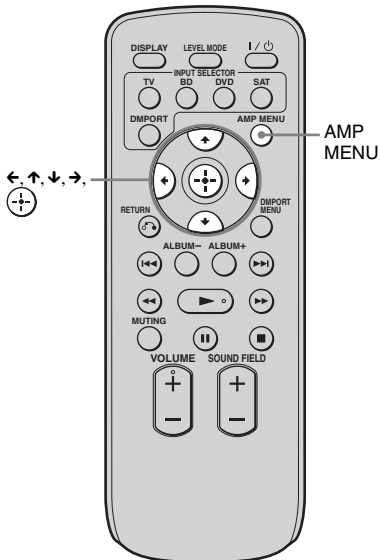

- Press AMP MENU.
The AMP menu turns off.

- Press AMP MENU.
- Press ↓/↑ repeatedly until “DUAL MONO” appears, then press (+) or →.
- Press ↓/↑ to select the sound you want.
 - MAIN: Plays back only the main channel.
 - SUB: Plays back only the sub channel.
 - MAIN+SUB: Main sound is output from the left speaker and sub sound is output from the right speaker.

continued

Adjusting the delay between the sound and the image (A/V SYNC)

You can delay the sound using this function when the image is behind the sound.

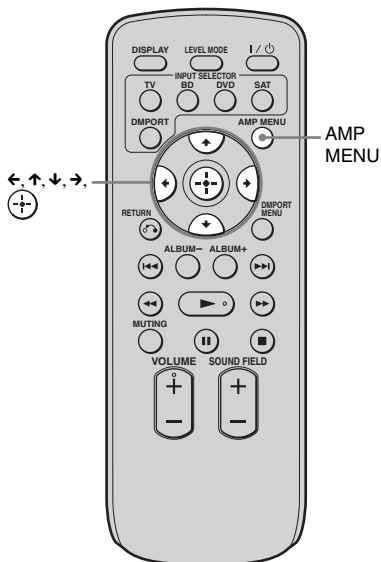

- 1 Press AMP MENU.
- 2 Press ↑/↓ repeatedly until “A/V SYNC” appears, then press  or →.
- 3 Press ↑/↓ to select the setting.
 - OFF: Does not adjust.
 - ON: Adjusts the difference between image and sound.
- 4 Press AMP MENU.
The AMP menu turns off.

Notes

- You may not be able to adjust the delay between sound and image perfectly using this function.
- This function is useful only for Dolby Digital, DTS and Linear PCM (2ch) input by coaxial (audio), optical (audio) or HDMI.

Enjoying Dolby Digital sound at low volume (AUDIO DRC)

You can narrow the dynamic range of the sound track. This function is useful for enjoying movies at low volume. AUDIO DRC only applies to Dolby Digital sources.

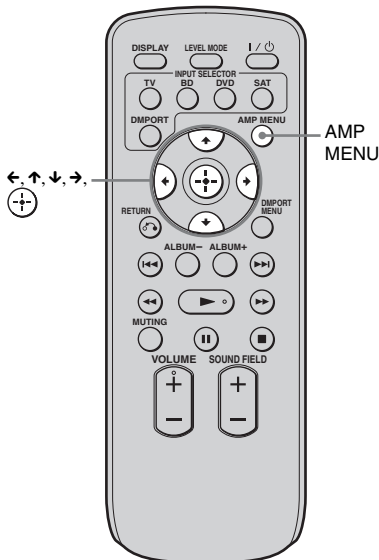

- 1 Press AMP MENU.
- 2 Press ↓/↑ repeatedly until “AUDIO DRC” appears, then press  or →.
- 3 Press ↓/↑ to select the setting.
 - OFF: No compression of dynamic range.
 - STD: Reproduces the sound track with the kind of dynamic range that the recording engineer intended.
 - MAX: Compresses dynamic range fully.
- 4 Press AMP MENU.
The AMP menu turns off.

Changing the brightness of the front panel display (DIMMER)

The brightness of the front panel display can be set to one of 2 levels.

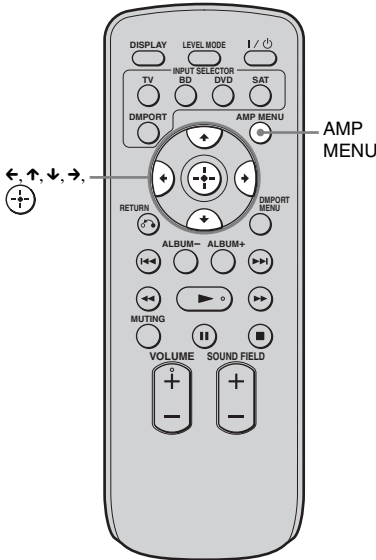

- 1 Press AMP MENU.
- 2 Press \uparrow/\downarrow repeatedly until "DIMMER" appears, then press \ominus or \rightarrow .
- 3 Press \uparrow/\downarrow to select the brightness of the front panel display.
 - OFF: Bright lighting.
 - ON: Low lighting.
- 4 Press AMP MENU.

The AMP menu turns off.

Changing the display setting (DISPLAY)

You can change the display setting.

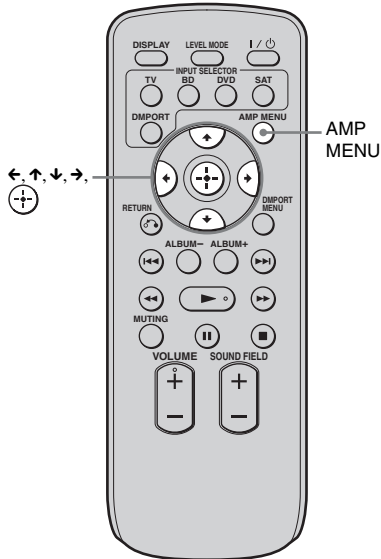

- 1 Press AMP MENU.
- 2 Press \downarrow/\uparrow repeatedly until "DISPLAY" appears, then press \ominus or \rightarrow .
- 3 Press \downarrow/\uparrow to select the setting of the front panel display.

- ON: The display appears all the time.
- OFF: The display appears for a moment when you operate the system.

Note

- The display appears all the time when the muting or protection function is working, even if you set the "DISPLAY" to "OFF."

- 4 Press AMP MENU.

The AMP menu turns off.

continued

Using the sleep timer (SLEEP)

You can set the system to turn off at a preset time when you sleep listening to music. You can preset the time in 10 minutes decrements.

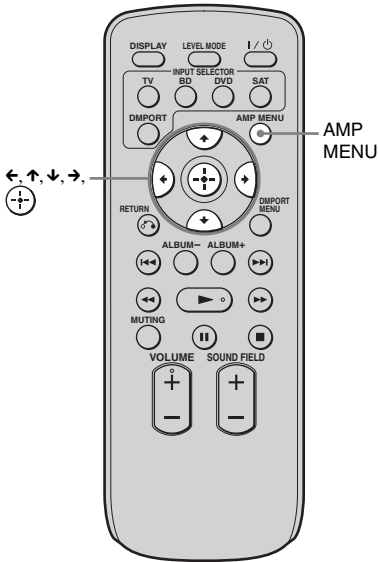

- 1 Press AMP MENU.**
- 2 Press ↓/↑ repeatedly until “SLEEP” appears, then press ⊕ or →.**
- 3 Press ↓/↑ to select the preset time.**

The minutes display (the remaining time) changes as follows:

OFF ↔ 10M ↔ 20M
↑ ↓
90M ↔ 80M 30M

- 4 Press AMP MENU.**

The AMP menu turns off.

Note

- This function is only for this system, not for the connected TV or other components.

Additional Information

Troubleshooting

If you experience any of the following difficulties while using the system, use this troubleshooting guide to help remedy the problem before requesting repairs. Should any problem persist, consult your nearest Sony dealer. When bringing the system in for repairs, be sure to bring in the entire system.

General

The power is not turned on.

- Check that the AC power cord (mains lead) is connected securely.

If “PROTECTOR” and “PUSH POWER” appears alternately in the front panel display.

Press I/⏻ to turn off the system, and check the following item after “STANDBY” disappears.

- Is anything blocking the ventilation holes of the system?

After checking the above item and fixing any problems, turn on the system. If the cause of the problem cannot be found even after checking the above item, consult your nearest Sony dealer.

Dolby Digital or DTS multi channel sound is not reproduced.

- Make sure that Dolby Digital or DTS sound format is selected when playing a Blu-ray Disc or DVD via a connected component.
- Check the audio setting of the component connected to this stand, such as a Blu-ray Disc recorder (player) or DVD player.

The surround effect cannot be obtained.

- Depending on the sound field setting and/or input signal, surround processing may not work. To check the input signal, press the INPUT SELECTOR on the stand and select the input again. When the input is switched, the input signal type appears in the front panel.
If “2.0ch” or “1.0ch” appears, the sound source is stereo or monaural, and does not

contain surround sound.

If “5.1ch” appears, the sound source does have surround sound, though not much surround sound may be heard, depending on the program or disk.

No sound or only a very low-level sound is heard from the speakers.

- Press VOLUME + and check the volume level.
- Press MUTING or VOLUME + to cancel the muting function.
- Press SOUND FIELD +/- and check the selected sound field.
- Depending on the source, the sound effect of the speakers may be less noticeable.

The sound is delayed compared to the image of the TV.

- Set “A/V SYNC” to “OFF” when “A/V SYNC” is set to “ON.”

Connected components

There is no sound or only a very low-level sound no matter which component is selected.

- Check that this system and components are connected correctly and securely.
- Check that both this system and the selected component are turned on.

There is no sound from the selected component.

- Check that the component is connected correctly to the audio input jacks for that component.
- Check that the cords are fully inserted into the jacks on both the component and this system.
- Check that the component is selected correctly.
- If you resume playback of a disc when volume is maximum, there may be no sound. In this case, turn down the volume, turn off the system and turn on again.

Sound is interrupted or there is noise.

- Check the output audio formats supported by this system on page 36.

continued

There is no picture on the TV screen.

- Check that the TV is selected correctly.
 - Set the TV to the appropriate input mode.
-

Control for HDMI

The Control for HDMI function does not work.

- Check the HDMI connection (page 10).
- Make sure “CTRL: HDMI” is set to “ON” in AMP menu.
- Make sure the connected component is compatible with the Control for HDMI function.
- Check the Control for HDMI settings on the connected component. Refer to the operating instructions supplied with the connected component.
- If you change the HDMI connection, or connect/disconnect the AC power cord (main lead), or if there is a power failure, repeat the procedures of “Preparing for the “BRAVIA” Sync” (page 21).
- The system may not work correctly if you select a component that is not compatible with the Control for HDMI function on the TV side.
- Make sure “DVD CTRL”, “SAT CTRL” or “DMPORT. CTRL” is set to “ON” in AMP menu. If the system input is selected for a component whose “DVD CTRL,” “SAT CTRL” or “DMPORT. CTRL” setting is “OFF,” the Control for HDMI functions, such as One-Touch Play, System Audio Control, Volume Limit function, will not work, even if the Control for HDMI function setting of another component is set to on.

No sound is output from the system and the TV’s speaker.

- Check the volume of the system and the TV.
- Select the input of the system correctly.

The sound is output from both the system and the TV.

- If the Control for HDMI function is set to off, or the selected component is not compatible with the Control for HDMI function, turn off the sound of the system or the TV.

The System Power Off function does not work.

- Change the setting of the TV to turn connected components off automatically when you turn off the TV. For details, refer to the operating instructions of the TV.

An image does not appear on the TV.

- Check whether HDMI IN and HDMI OUT are connected correctly.

A message stating that the output method has changed from the system speaker to the TV speaker appears on the TV screen.

- The Control for HDMI function for the selected component is set to off. For details, refer to “Setting the Control for HDMI function to off for a component without HDMI jacks” (page 23).

Other

The remote does not function.

- Point the remote at the remote sensor  on the system.
- Remove any obstacles in the path between the remote and the satellite speaker.
- Replace both batteries in the remote with new ones, if they are weak.
- Make sure you select the correct input on the remote.

The volume turns down when the output method changes from the TV speaker to the system speaker.

- The Volume Limit function is working. For details, refer to “Using the Volume Limit function” (page 25).
-

If the system still does not operate properly after performing the above measures, reset the system as follows:

Use buttons on the system for the operation.

- 1** Press I/⏻ to turn on the power.
- 2** Press **INPUT SELECTOR, VOLUME –** and I/⏻ **at the same time.**

“COLD RESET” appears and the system is reset. AMP menu, sound field etc., return to the default settings.

Specifications

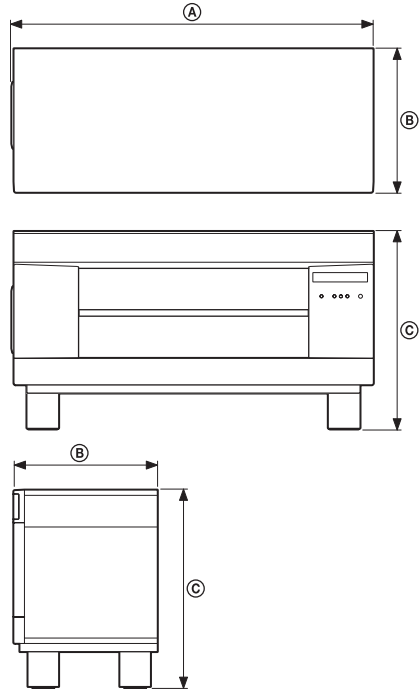

Dimensions: mm (approx.)	(A)	1,010
	(B)	400
	(C)	550
Mass: kg		43

Formats supported by this stand

Digital input formats supported by this system are as follows.

Format	Supported/Not supported
Dolby Digital	○
DTS	○
Linear PCM (2ch)*	○
Linear PCM (5.1ch, 7.1ch)* (Only on HDMI)	○
Dolby Digital Plus	×
Dolby True HD	×
DTS-HD	×

* Linear PCM accepts sampling frequencies of no more than 48 kHz.

Amplifier section

Reference Output Power
Surround mode

Front: 50 Watts/ch
(8 ohms at 1 kHz,
THD 10 %)
Center*: 50 Watts/ch
(8 ohms at 1 kHz, THD
10 %)
Subwoofer: 100 Watts/ch
(4 ohms at 100 Hz,
THD 10 %)

* Depending on the sound field settings and the source, there may be no sound output.

Inputs (Analog)

TV Impedance: 30 kohms

Inputs (Digital)

TV, DVD Optical
SAT Coaxial, optical

HDMI section

Connector

HDMI 19pin-standard connector

Video inputs/outputs

BD, DVD, SAT:
640 × 480p@60 Hz
720 × 480p@59.94/60 Hz
1440 × 480p@59.94/60 Hz
(pixel sent 2 times)
1280 × 720p@59.94/60 Hz
1920 × 1080i@59.94/60
Hz
1920 × 1080p@59.94/60
Hz
720 × 576p@50 Hz
1440 × 576p@50 Hz (pixel
sent 2 times)
1280 × 720p@50 Hz
1920 × 1080i@50 Hz
1920 × 1080p@50 Hz
1920 × 1080p@24 Hz
BD, DVD, SAT: Linear
PCM 7.1ch/Dolby Digital/
DTS

Audio inputs

Speakers

Front / Center speaker unit

Speaker system Bass reflex, magnetically shielded

Speaker unit 40 × 70 mm cone type

Subwoofer unit

Speaker system Bass reflex
Speaker unit 160 mm, cone type

General

Power requirements 230 V, 50/60 Hz

Power consumption On: 70 W
Active Standby (Control for HDMI is on): 1.5 W (minimum) to 5 W (maximum)
Standby (Control for HDMI is off): less than 0.3 W

Dimensions (approx.) 1,010 × 550 × 400 mm (w/h/d)

Mass (approx.) 43 kg

Supplied accessories

- Optical cable (1.5 m) (1)
- Remote commander (RM-ANU041) (1)
- Size AA (R6) batteries (2)
- Support belt and two screws (small/large) (1)
- Shelf board (1)
- Shelf support pins (4)
- Operating Instructions (1)

Design and specifications are subject to change without notice.



- Standby power consumption 0.3 W.
- Halogenated flame retardants are not used in the printed wiring boards.
- Over 85 % power efficiency of amplifier block is achieved with the full digital amplifier, S-Master.

Glossary

Dolby Digital

This movie theater sound format is more advanced than Dolby Surround Pro Logic. In this format, the surround speakers output stereo sound with an expanded frequency range, and a subwoofer channel for deep bass is independently provided. This format is also called “5.1” with the subwoofer channel designed as the 0.1 channel (since it functions only when a deep bass effect is needed). All six channels in this format are recorded separately for superior channel separation. Furthermore, since all the signals are processed digitally, less signal degradation occurs.

Dolby Pro Logic II

Dolby Pro Logic II creates five full-bandwidth output channels from 2 channel sources. This is done using an advanced, high-purity matrix surround decoder that extracts the spatial properties of the original recording without adding any new sounds or tonal colorations.

DTS

Digital audio compression technology developed by Digital Theater Systems, Inc. This technology conforms to 5.1-channel surround. This format comprises of stereo rear channel and there is discrete subwoofer channel in this format. DTS provides the same 5.1 discrete channels of high quality digital audio. The good channel separation is realized due to the all channel data being recorded discretely and processed in digitally.

HDMI

HDMI (High-Definition Multimedia Interface) is an interface that supports both video and audio on a single digital connection, allowing you to enjoy high quality digital picture and sound. The HDMI specification supports HDCP (High-bandwidth Digital Contents Protection), a copy protection technology that incorporates coding technology for digital video signals.

continued

37^{GB}

PCM (Pulse Code Modulation)

A method of converting analog audio to digital audio for easy enjoyment of digital sound.

S-Force PRO Front Surround

Sony's long-term involvement in surround technology (and the vast amounts of acoustic data accumulated as a result) has led to the development of all-new processing method and advanced DSP to handle this task effectively, which we call S-Force PRO Front Surround.

Compared with previous front surround technologies, S-Force PRO Front Surround reproduces a more convincing sense of distance and space, resulting in a true surround sound experience without the need for rear speakers.

S-Master

S-Master is an all-digital amplifier technology developed by Sony, which effectively minimizes the occurrence of sound fragmentation and jitter, delivering superb dialog clarity and faithful reproduction of the original sound. The compact amplifier section supports a higher power efficiency and improved thermal performance.

x.v.Colour

x.v.Colour is a more familiar term for the xvYCC standard proposed by Sony, and is a trademark of Sony. xvYCC is an international standard for color space in video.

This standard can express a wider color range than the currently used broadcast standard.

Index

A

A/V SYNC 30
AMP menu 28
AUDIO DRC 30

B

Blu-ray Disc player (recorder)
connecting 10

D

DIGITAL MEDIA PORT
connecting 14
DIMMER 31
DISPLAY 31
DUAL MONO 29
DVD player (recorder)
connecting 10, 12

H

HDMI
connecting 10

I

Installing 9

P

“PlayStation 3”
connecting 10

R

Remote
before use 8
operating 17

S

Satellite tuner
connecting 10, 12
Setting 9
S-Force PRO Front Surround 7
Sleep timer 32
Sound field 20
Speakers level 27



* 3 8 7 7 0 3 0 1 2 * (1)

Free Manuals Download Website

<http://myh66.com>

<http://usermanuals.us>

<http://www.somanuals.com>

<http://www.4manuals.cc>

<http://www.manual-lib.com>

<http://www.404manual.com>

<http://www.luxmanual.com>

<http://aubethermostatmanual.com>

Golf course search by state

<http://golfingnear.com>

Email search by domain

<http://emailbydomain.com>

Auto manuals search

<http://auto.somanuals.com>

TV manuals search

<http://tv.somanuals.com>