

SONY®

STEREO TURNTABLE SYSTEM

PS-FL7II

Ⓐ

OPERATING INSTRUCTIONS

Before operating the unit, please read this manual thoroughly.
This manual should be retained for future reference.

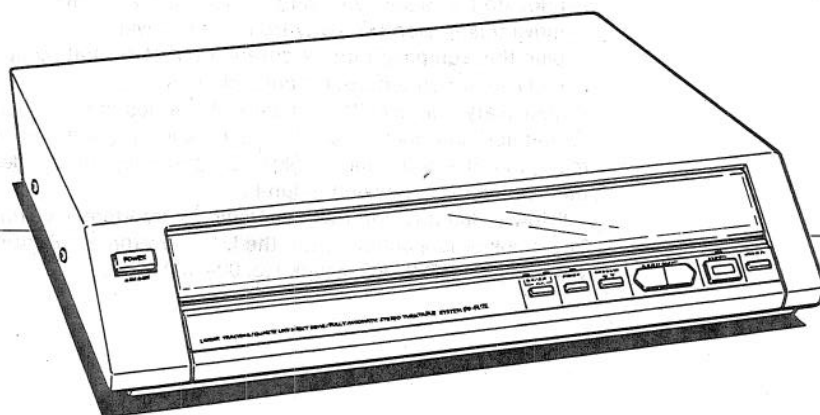

OWNER'S RECORD

The model and serial numbers are located at the rear. Record the serial number in the space provided below. Refer to these numbers whenever you call upon your Sony dealer regarding this product.

Model No. PS-FL7II

Serial No. _____

WARNING

To prevent fire or shock hazard, do not expose the unit to rain or moisture.

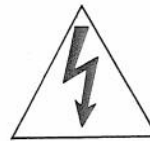
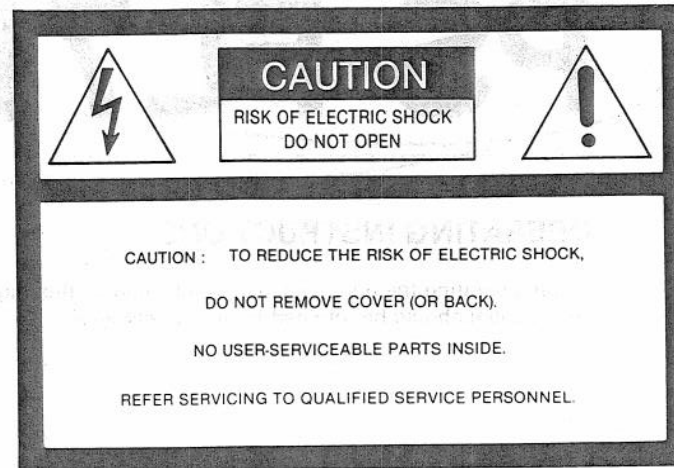

This symbol is intended to alert the user to the presence of uninsulated "dangerous voltage" within the product's enclosure that may be of sufficient magnitude to constitute a risk of electric shock to persons.

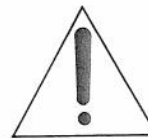

This symbol is intended to alert the user to the presence of important operating and maintenance (servicing) instructions in the literature accompanying the appliance.

INFORMATION

This equipment generates and uses radio frequency energy and not installed and used properly, that is, in strict accordance with the manufacturer's instructions, may cause interference to radio and television reception. It has been type tested and found to comply with the limits for a Class B computing device in accordance with the specifications in Subpart J of Part 15 of FCC Rules, which are designed to provide reasonable protection against such interference in a residential installation. However, there is no guarantee that interference will not occur in a particular installation. If this equipment does cause interference to radio or television reception, which can be determined by turning the equipment off and on, the user is encouraged to try to correct the interference by one or more of the following measures:

- reorient the receiving antenna
- relocate this equipment with respect to the receiver
- move this equipment away from the receiver
- plug this equipment into a different outlet so that equipment and receiver are on different branch circuits.

If necessary, the user should consult the dealer or an experienced radio/television technician for additional suggestions. The user may find the following booklet prepared by the Federal Communications Commission helpful:

"How to Identify and Resolve Radio-TV Interference Problems"
This booklet is available from the U.S. Government Printing Office, Washington, DC 20402, Stock No. 004-000-00345-4.

TABLE OF CONTENTS

Precautions	3
Location and function of controls.....	4
Turntable assembly.....	5
Cartridge installation	6
Connections	6
Signal connection	6
Remote control cord connection.....	6
Synchro remote control cord connection.....	7
Tips on record handling.....	7
Record playing	7
Auto play.....	7
Manual play.....	8
To lift up the stylus during play	8
To stop during play	8
To move to a different part of a record during play.....	8
To repeat play	8
Auto-record-size selection system.....	8
Synchronized play of the turntable and a cassette deck.....	9
Replacing the stylus	10
Tracking force fine adjustment.....	10
Specifications	10
Trouble checks.....	11

PRECAUTIONS

On safety

- Operate the unit only on 120 V ac, 60 Hz.
- Should any solid object or liquid fall into the cabinet, unplug the unit and have it checked by qualified personnel before operating it any further.
- Unplug the unit from the wall outlet if it is not to be used for an extended period of time. To disconnect the cord, pull it out by the plug. Never pull the cord itself.

On installation

- Do not install the unit in a location near heat sources such as radiators or air ducts or in a place subject to direct sunlight, excessive dust, mechanical vibration or shock.
- Place the turntable on a level surface.

On cleaning

- Clean the cabinet periodically with a soft dry cloth. If the stains are difficult to remove, use a cloth moistened with a mild detergent solution. Do not use solvents such as alcohol, benzine or thinner, since they will damage the finish.
- Before playing a record, clean the stylus with a soft brush. Brush the stylus from back to front. Never attempt to clean the stylus with your finger tip. If a fluid stylus cleaner is used, make sure not to moisten the stylus too much.

On repacking

Do not throw away the carton and packing materials. It is an ideal container in which to transport the unit. When shipping the unit to another location, repack it as illustrated on the carton box. Before repacking, fix the transit screws in the original positions.

For detailed safety precautions, see the leaflet "IMPORTANT SAFEGUARDS".

LOCATION AND FUNCTION OF CONTROLS

Each number in the text is keyed to that of the photo.
The photo shows the assembled turntable.

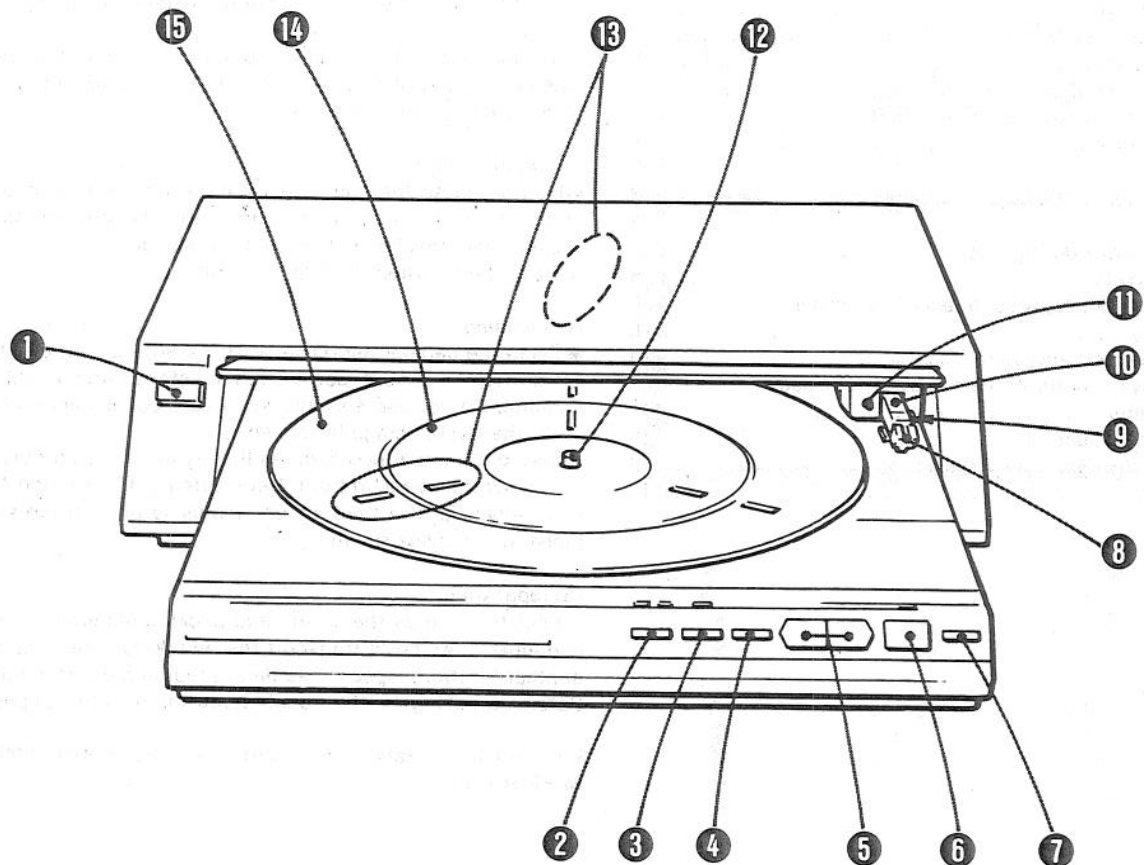

1 POWER switch

Press to turn on the power. To turn the power off, press it again.

2 SPEED selector and indicators

Press this button when a 45 rpm record is to be played. Press it again for a 33 $\frac{1}{3}$ rpm record. Corresponding indicator lights up.

3 REPEAT button and indicator

Press this button to repeat play. The indicator lights up. To cancel the repeat play, press this button again.

4 $\nabla \nabla$ ARM LIFTER button

This button lifts and lowers the tonearm. When the tonearm is lowered, the turntable starts rotating.

5 ARM TRANSPORT buttons

To move the tonearm inward, press the \triangleleft button, and to move outward, the \triangleright button. The tonearm is raised and continues to move while the button is pressed. The tonearm will stop when the button is released. For fine adjustments, press and immediately release the appropriate button.

6 START/STOP button and indicator

Press to start the record playing. To stop during play, press it again.

7 OPEN/CLOSE button

With one touch of this button the turntable module automatically opens for loading a record. With another touch the module automatically closes.

8 Cartridge

9 Cartridge locking screw

10 Tonearm

11 Tonearm position indicator

12 Center spindle

13 Auto-record-size selection holes and LEDs

14 Rubber mat

15 Turntable

Rear panel

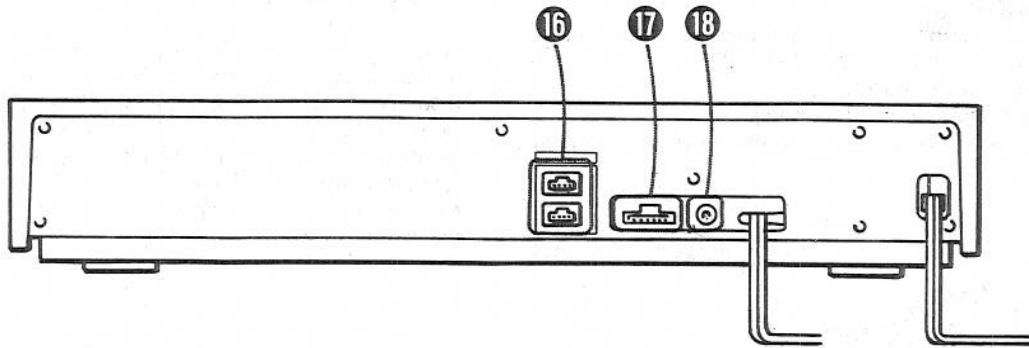

16 CONTROL S connector (4-pin)

OUT: Connect to the CONTROL S IN or REMOTE IN connector of other Sony audio equipment with the supplied flat 4-pin remote control cord for remote control of the total audio system.

IN: Connect to the CONTROL S OUT or REMOTE OUT connector of the optional Sony system control tuner or receiver for remote control of the total audio system.

17 REMOTE control connector (6-pin)

Connect to the PHONO connector of the optional Sony RM-S410 or RM-44 system remote controller for remote control operation. When the RM-44 or RM-S410 is connected to the REMOTE connector, do not connect audio equipment to the CONTROL S connector. This will cause malfunction of the remote control system function.

18 SYNC jack

Connect a Sony cassette deck equipped with a flat 3-pin synchro remote control connector here for synchronized play. A Sony cassette deck equipped with a 4-pin or 5-pin synchro remote control jack can also be connected here when an optional Sony RM-65 synchro remote control unit is used.

TURNTABLE ASSEMBLY

- 1 Remove the tonearm transit screw, three transit screws and stoppers from the bottom of the set as follows. Save these screws and stoppers, since they will be required when repacking.

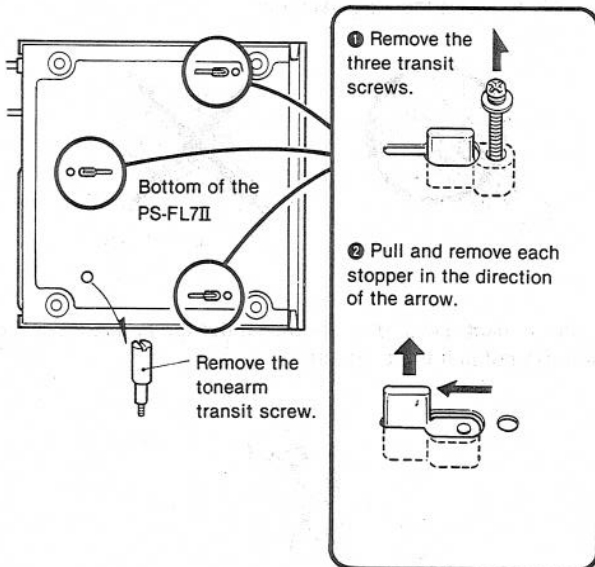

Do not hold the unit so that the front panel faces down after you have removed the transit screws, since this may cause serious damage to the module.

- 2 Connect the power cord to an ac outlet, press the POWER switch and press the OPEN/CLOSE button. The module will open.

- 3 Press the ARM TRANSPORT button to move the tonearm inward, remove the tonearm transit plate, then press the ARM TRANSPORT button to move the tonearm to the arm rest.
- 4 Carefully place the platter and the rubber mat on the motor board so that the holes for auto-record-size selection on the rubber mat and on the platter are matched correctly.

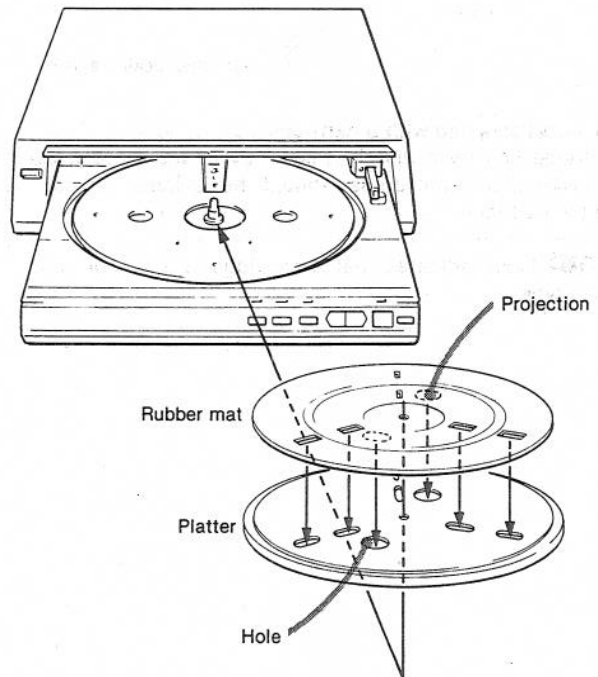

Notes on the module

- The OPEN/CLOSE button does not activate when the power is turned off. Never push or pull the module forcibly.
- Do not push down on the module.
- Do not stop the module when it is moving.
- Be careful that no foreign object is caught between the module and the cabinet.

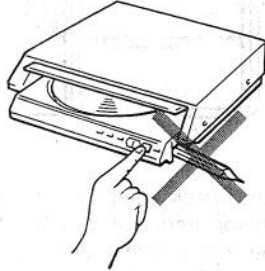

If the foreign object should be caught in this position, press the OPEN/CLOSE button immediately so that the module will move in the opposite direction.

If you leave the foreign object between the module and the cabinet for 10 seconds, the module will automatically move in the opposite direction.

CARTRIDGE INSTALLATION

A cartridge with **T4P** label (optional) can be installed. Plug the cartridge into the tonearm and tighten the cartridge locking screw (supplied) firmly.

The screw cannot be inserted from this side.

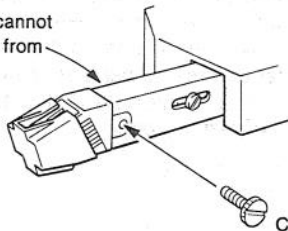

Cartridge locking screw

For the model supplied with a cartridge :

The cartridge has been installed correctly at the factory. So the above installation procedures should be skipped unless you replace the cartridge.

The **T4P** label indicates that a cartridge is a standardized plug-in type.

CONNECTIONS

SIGNAL CONNECTION

Notes

- Turn off the amplifier before making connections.
- Be sure to connect the red plug of the connecting cord to the F (right) jack and the other plug to the L (left).
- The cable connector should be fully inserted into the jacks. A loose connection may cause hum and noise.
- Leave a little slack in the connecting cord to allow for inadvertent shock or vibration.

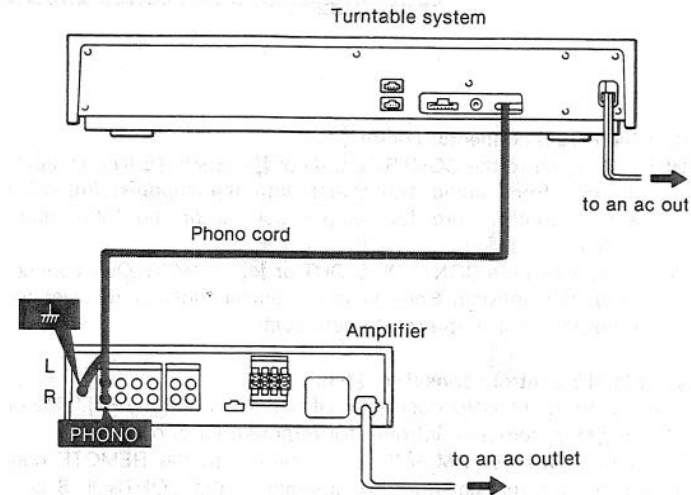

REMOTE CONTROL CORD CONNECTION

Connect the supplied remote control cord to the CONTROL S IN connector.



Notes

- Be sure to insert the cord securely.

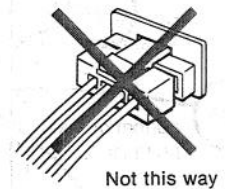
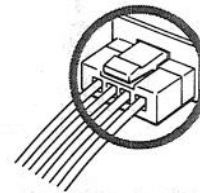

- To disconnect the cord, press the center tab and pull out the connector. Do not pull the cord itself.

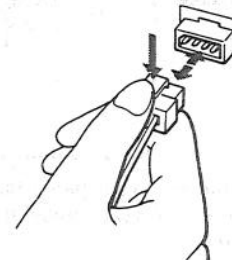

RECORD PLAYING

SYNCHRO REMOTE CONTROL CORD CONNECTION

Connect the supplied synchro remote control cord to the SYNC connector. For details, refer to page 9.

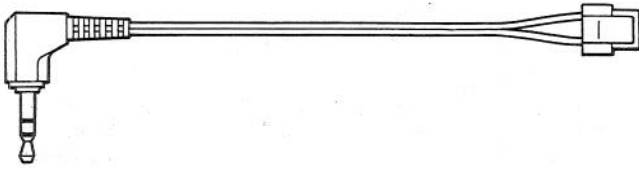

TIPS ON RECORD HANDLING

- Before playing, clean the record with a record cleaner or soft cloth. If a spray cleaner is used, make sure that it has dried completely before playing the record.
- Handle a record by its edges and do not touch the grooves.
- Use a commercially available anti-static spray to neutralize the static electricity on a record.
- Avoid exposing a record to direct sunlight or sources of heat, such as a hot-air duct.
- Store your records vertically. They should not be compressed.

AUTO PLAY

Follow the numbered sequence.

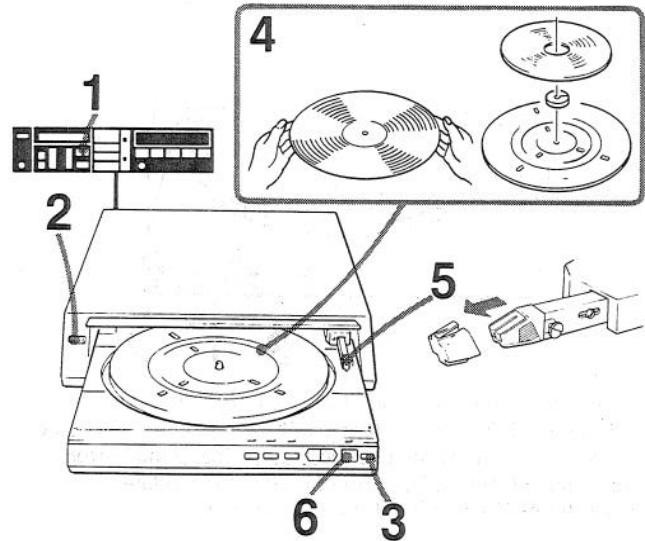

- 1 Turn on the amplifier and set the input selector to PHONO.
- 2 Depress the POWER switch (ON).
- 3 Press the OPEN/CLOSE button to open the module.
- 4 Place a record on the platter. For 45-rpm record playing, see below.
- 5 Remove the stylus guard.
- 6 Press the START/STOP button. Play will begin.

When the tonearm reaches the end of the record, it will automatically return to the arm rest and the turntable will stop. Press the POWER switch to turn the unit off after the tonearm returns to the arm rest.

45 rpm record playing

- Put the supplied 45 rpm adaptor over the center spindle and then place a record on the platter.
- Press the SPEED selector so that the 45 rpm indicator lights up.

Notes

- 25 cm (10 inch) records and transparent records cannot be played automatically. To play these records, proceed as in "MANUAL PLAY" on page 8.
- If the POWER switch is turned off while the tonearm is returning to the arm rest, when you press the POWER switch the next time the tonearm will return to the arm rest. While the tonearm is moving, the START/STOP button is not activated.

AUTO-RECORD-SIZE SELECTION SYSTEM

MANUAL PLAY—To begin record play at a particular point

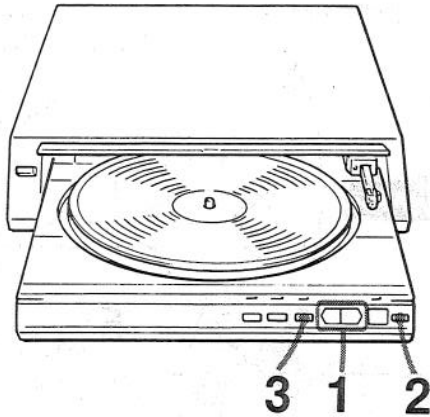

- 1 After proceeding from step 1 to 5 in "AUTO PLAY", press the ARM TRANSPORT button to move the tonearm over the record to the desired point. At the desired point, release the button.
- 2 Press the OPEN/CLOSE button to close the module.
- 3 Press the ARM LIFTER button. Play will begin.

When the tonearm reaches the end of the record, it will automatically return to the arm rest and the turntable will stop. Press the POWER switch to turn the unit off after the tonearm returns to the arm rest.

Note

- During manual play, auto repeat function does not activate.
- To play the record with the module opened, press the ARM LIFTER button without pressing the OPEN/CLOSE button.

TO LIFT UP THE STYLUS DURING PLAY

To lift the stylus from a record for a moment and then start playing from the same point, press the ARM LIFTER button. To lower the tonearm onto the record, press the button again. Play will start from the same point.

TO STOP DURING PLAY

To stop playing and open the module, press the OPEN/CLOSE button.

You can stop play by pressing the START/STOP button instead of the OPEN/CLOSE button. In this case, the module will not move.

TO MOVE TO A DIFFERENT PART OF A RECORD DURING PLAY

Move the tonearm to the desired point of the record by pressing the ARM TRANSPORT button and then press the ARM LIFTER button to start play.

TO REPEAT PLAY

Press the REPEAT button either before or after starting play when the module is closed. The indicator in this button lights up. To cancel the repeat play, press the REPEAT button again. (The indicator goes off.)

To stop during repeat play, press the OPEN/CLOSE button or the START/STOP button. The indicators in the REPEAT and START/STOP buttons go off and the repeat function is cancelled. The module will open only when the OPEN/CLOSE button has been pressed.

The auto-record-size selection system which only works during auto play, serves to detect using a beam from the LED, whether there is a record or not on the platter and also to determine the record size.

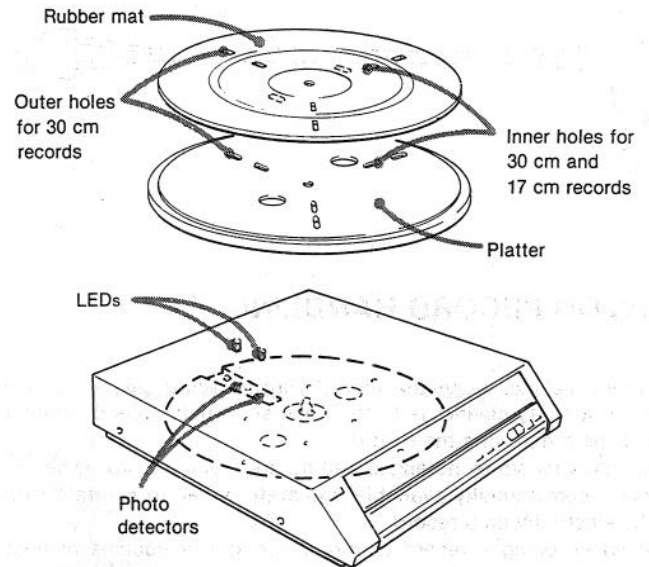

When a 30 cm record is to be played, both inner and outer holes are covered so no beam is transmitted to the photo detector.

When a 17 cm record is to be played, the inner holes are covered so a beam is transmitted through the outer holes to the photo detector.

When there is no record on the platter, a beam is transmitted through both the inner and outer holes to the photo detectors. Even if the START/STOP button is accidentally pressed, the tonearm does not lower.

When a 25 cm record is to be played, the tonearm lowers to the same point if a 30 cm record were on the platter, since both the inner and outer holes are covered. To play a 25 cm record, proceed as in "MANUAL PLAY".

When a transparent record is to be played, a beam passes through both the inner and outer holes to the detectors so the tonearm does not lower onto the record. To play a transparent record, proceed as in "MANUAL PLAY".

When a badly warped record is to be played, a beam may pass through the holes to the detector and cause a malfunction of the auto-record-size selection. To play a warped record, proceed as in "MANUAL PLAY".

SYNCHRONIZED PLAY OF THE TURNTABLE AND A CASSETTE DECK

When the tonearm lowers onto the record, the cassette deck goes into the record mode and, when the tonearm is lifted up, the deck goes into the auto record muting mode for four seconds, then into the pause mode.

Cassette decks which can be used with your turntable for this special synchronized operation are those Sony models which are equipped with a flat 3-pin remote control connector.

Connect the SYNC jack of the PS-FL7 II and the SYNC connector of the cassette deck with the supplied synchro remote control cord. Synchro play can also be done with Sony cassette decks equipped with a 4-pin or 5-pin remote control jack but the RM-65 synchro remote control unit (optional) is required to connect the turntable and the cassette deck.

PREPARATION

- 1 Turn the amplifier on and set its input selector to PHONO.
- 2 Turn the turntable system on, place a record and select the correct record speed.
- 3 Adjust the recording level on the cassette deck and set it in the record stand-by mode.
- 4 When the RM-65 is used, set the SYNCHRO switch of the RM-65 to ON.

RECORDING

Desired action	Turntable operation	Synchronized operation of the cassette deck
To record from the beginning of a record...	Press the START/STOP button.	When the tonearm lowers onto the record, the pause mode is released and recording begins.
To lift up the tonearm to move to a different point on a record...	Press the ARM TRANSPORT button.	When the tonearm is lifted up, auto-record-muting activates for four seconds, then the pause mode is assumed.
To record from a point some way in the record...	Move the tonearm over the desired point and press the START/STOP or ARM LIFTER button.	When the tonearm lowers onto the record, the pause mode is released and recording begins.
To stop recording during record play...	Press the START/STOP button.	When the tonearm is lifted up, auto-record-muting activates for four seconds, then the pause mode is assumed.
When record play ends...	The tonearm returns automatically to the arm rest.	When the tonearm is lifted up, auto-record-muting activates for four seconds, then the pause mode is assumed.

Note: Disconnect the synchro remote control cord if you do not want to use the synchronized play function.

REPLACING THE STYLUS

Replace the stylus after about 400 hours of use because using a worn stylus will damage records.
For the VL-45G cartridge (supplied with the specific models), an ND-145G replacement stylus is available at your Sony dealer.

1

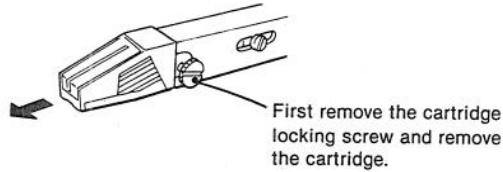

2 Detach the stylus assembly and insert a new stylus into the cartridge.

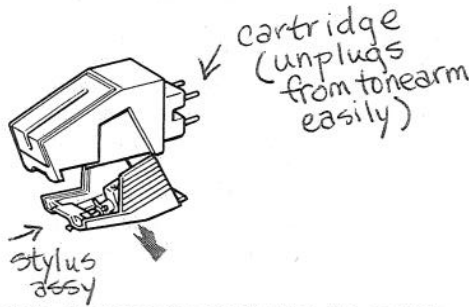

3 Plug the cartridge into the tonearm and tighten the cartridge locking screw firmly.

The screw cannot be inserted from this side.

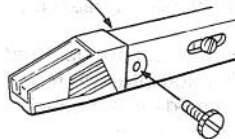

TRACKING FORCE FINE ADJUSTMENT

The tracking force has been correctly adjusted at the factory. Make fine adjustment only when the tracking force is so light that the stylus skips grooves.

Slide the tracking force adjustment lever towards + (forward) for heavier tracking force or towards - (backward) for lighter tracking force.

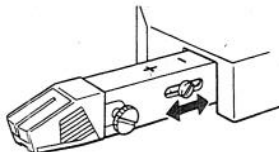

SPECIFICATIONS

Turntable

Platter	29 cm (11½ in.), aluminum-alloy diecast
Motor	BSL (brushless and slotless) motor
Drive system	Direct drive
Control system	Quartz lock control system
Speed	33½ rpm, 45 rpm
Wow and flutter	0.03% (WRMS)*, 0.035% (WRMS)
Signal-to-noise ratio	75 dB (DIN-B)
Automatic system	Lead-in, return, reject, repeat, tonearm up/down, record size selection
Load characteristics	0% up to 1.5g tracking force (at lead-in groove of a record)
Speed deviation	Within ±0.003%

Tonearm

Type	Linear tracking tonearm
Pivot-to-stylus length	75 mm (3 in.)
Tracking error	±0.1°
Tracking force adjustment range	1.25 ±0.25 g
Cartridge	plug-in type, 6 g

Cartridge VL-45G (supplied only with the specific models)

Type	Moving magnet type
Frequency response	10 Hz to 20 kHz
Output voltage	3.5 mV at 1 kHz, 5 cm/sec., 45°
Load impedance	47 to 100 kilohms
Tracking force	1.0 to 1.5 g (1.25 g recommended)
Stylus	Sony ND-145G
Weight	6 g

PS-FL7IIC

General

Power requirements	120 V ac, 60 Hz
Power consumption	10 W
Dimensions	Approx. 430 × 96 × 382 mm (w/h/d) (17 × 37/8 × 15¼ in.) including projecting parts and controls
Weight	Approx. 7.5 kg (16 lbs 9 oz), net Approx. 9.3 kg (20 lbs 8 oz), in shipping carton
Supplied accessory	45-rpm adaptor (1) Remote control cord (1) Synchro remote control cord (1)

Design and specifications subject to change without notice.

* This new measuring method concerns only the turntable assembly, including the platter. It excludes wow and flutter caused by the tonearm, the cartridge or the record. Measured by obtaining signal from magnetic pick-up head.

TROUBLE CHECKS

Should any problem persist after you have made these checks, consult your nearest Sony service facility. Before proceeding with these trouble checks, first refer to the connections and the operating procedures.

TROUBLES	CAUSES	WHAT TO DO
The tonearm does not lower onto the record.	Transparent or warped record	Play the record referring to page 8.
The tonearm always lowers on the point for 30 cm records.	A rubber mat other than the one supplied being used.	Use the supplied rubber mat.
	Incorrect placement of the supplied rubber mat	Align the holes in the rubber mat with the holes of the platter.
Impaired tone quality	Improper tracking force	Apply proper tracking force (see page 10).
	Dusty stylus	Clean the stylus with a soft brush from back to front.
	Worn stylus	The stylus life is approx. 400 hours. Replace with a new stylus.
No audio from one channel	Loose connection of phono cord	Connect the cord firmly.
	Dirty terminals of the cartridge	Clean the terminals with a soft dry cloth.
	Loose attachment of the cartridge to the tonearm	Fix the cartridge to the tonearm firmly.
Steady low-pitched humming sound	Loose attachment of the cartridge to the tonearm	Fix the cartridge to the tonearm firmly.
Groove skipping ; tonearm skating ; tonearm not advancing	Improper tracking force	Apply proper tracking force (see page 10).
	Turntable not level	Place the turntable on a level surface.
	Defective record	—
Loud rumble or low-frequency howl*	The turntable is subjected to external vibration.	Place the turntable on a solid surface free from external vibration.
	The turntable is placed too near the speaker.	Locate the turntable as far away from the speaker as possible.

* This is called "acoustic feedback" and is caused when vibrations from the speakers are transmitted through the air or via solid objects (such as the shelves, the cabinet, the floor, etc.) to the turntable, where they are picked up by the stylus, amplified and reproduced through the speakers once again.

Free Manuals Download Website

<http://myh66.com>

<http://usermanuals.us>

<http://www.somanuals.com>

<http://www.4manuals.cc>

<http://www.manual-lib.com>

<http://www.404manual.com>

<http://www.luxmanual.com>

<http://aubethermostatmanual.com>

Golf course search by state

<http://golfingnear.com>

Email search by domain

<http://emailbydomain.com>

Auto manuals search

<http://auto.somanuals.com>

TV manuals search

<http://tv.somanuals.com>