

# ***Integrated Remote Commander***

---

Operating Instructions

***RM-AV2000***

## **For the customers in the U.S.A. INFORMATION**

This equipment has been tested and found to comply with the limits for a Class B digital device, pursuant to Part 15 of the FCC Rules.

These limits are designed to provide reasonable protection against harmful interference in a residential installation. The equipment generates, uses, and can radiate radio frequency energy and, if not installed and used in accordance with the instructions may cause harmful interference to radio communications. However, there is no guarantee that interference will not occur in a particular installation. If this equipment does not cause harmful interference to radio or television reception, which can be determined by turning the equipment off and on, the user is encouraged to try to correct the interference by one or more of the following measures:

- Reorient or relocate the receiving antenna.
- Increase the separation between the equipment and receiver.
- Connect the equipment into an outlet on a circuit different from that to which the receiver is connected.
- Consult the dealer or an experienced radio/TV technician for help.

You are cautioned that any changes or modifications not expressly approved in this manual could void your authority to operate this equipment.

# Features

The RM-AV2000 Remote Commander provides centralized control of all your AV components from a single remote commander and saves the trouble of operating different AV components with different remote control devices. The following are its main features.

## ***Centralized control of Sony AV components with this one remote commander***

This Commander is preset at the factory to operate Sony brand components, so you can use it out of the box as a control center for your Sony AV components.

## ***Remote control signals for non-Sony components are also preset***

This Commander is preset for most major brands components including Sony. You can remote control your components by setting their code numbers.

## ***Learning function for programming other remote control signals you need***

This Commander has a learning function, to learn remote control signals to operate non-preset components or functions. In addition, the Commander can learn remote control signals (infrared signals only) of non-Audio Visual components such as air-conditioners, lights, etc. (some specific appliances or functions may not be available).

## ***Adding or reassigning new components***

You can use the OPTION button as an extra Component Select button. What's more, you can assign other Component Select Buttons to freely operate other components. This is useful when you have more than two of the same kind of AV components.

## ***System Control function allows one-touch operation to execute a series of commands***

You can program up to 16 consecutive operation steps to execute a series of operations by pressing a single button.

## ***Easy-to-operate touch key LCD with blue back light***

This Commander has a touch key LCD that changes the key display according to the selected component. The Commander is easy to operate as only the keys necessary to operate the selected component are displayed. The display backlight allows operation even in the dark.

# Table of Contents

---

## Getting Started

Installing the Batteries .....	6
When to replace the batteries .....	6
Location and Function of Controls .....	7

---

## Basic Operations

Setting the Code for Preset Audio and Visual Components .....	8
Setting a Component Code .....	8
Checking if the code number works .....	10
Operating Your Components with the Remote Commander .....	11
Using Non-Preset Remote Control Operations — Learning Function .....	13
Changing or erasing the function of a learned key or button .....	16
Using the OPTION button .....	17

---

## Advanced Features

Controlling the Volume of Visual Components Connected to an Audio System .....	18
Executing a Series of Commands — System Control Function .....	20
Programming a series of commands to the SYSTEM CONTROL buttons .....	20
Executing the programmed commands .....	22
Changing the programmed commands .....	23
Adding an Extra Function to the Component Select Buttons .....	24
Programming the Power-On Command of the Selected Component (for Sony Components only) .....	24
Adding a Command that is Required when Selecting a Component .....	25
Turning Off the Power of All Components by a Single Button Operation — System Power-Off Function (for Sony Components only) .....	26
Assigning Other Components to the Component Select Buttons .....	27
Programming a Frequently Used Key Operation to SYSTEM CONTROL Buttons .....	29

---

## Using Other Functions

Locking the Controls — Hold Function .....	30
Protecting your settings and “learned” signals — Preset Lock Function .....	31
Changing the Auto Power-Off Time of the Commander .....	32
Adjusting the Backlight of the Display Window .....	33

---

## Additional Information

Precautions .....	34
Maintenance .....	34
Specifications .....	34
Troubleshooting .....	35

---

## Appendix

Table of Preset Functions .....	37
TV .....	37
VCR 1, 2, 3 .....	37
DVD .....	38
VD (LD player) .....	38
DBS .....	39
CBL (Cable box) .....	39
AMP .....	40
CD .....	40
MD .....	41
DAT .....	41
DECK B/A .....	42
TUNER .....	42
DSP (Digital Surround Processor) .....	42
LCD Touch Key Display Table .....	43
Quick Reference of Operations .....	51
Index .....	back cover

## Installing the Batteries

Slide open the battery compartment lid and insert six size AA(R6) batteries (not supplied). Be sure to line up the + and - on the batteries with the + and - on the battery compartment.

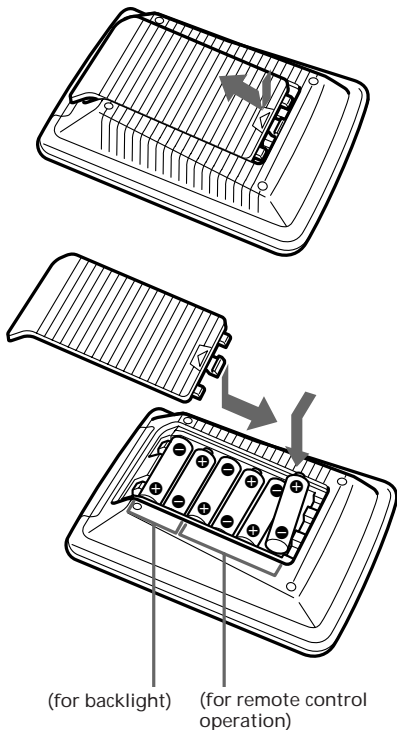

## When to replace the batteries

### Batteries for remote control operation (Four size AA (R6) batteries)

Under normal conditions, batteries will last up to six months. If the Commander does not operate properly, batteries might be worn out and  is displayed on the LCD touch panel. When the display dims, replace the batteries with new ones.

#### Note

- Do not take more than one hour to replace the batteries; otherwise, your setting of the code numbers (page 8) and learned remote control signals (page 13) will be erased.

### Batteries for backlight (Two size AA (R6) batteries)

When the backlight for the touch keys grows dim, replace its batteries.

#### Notes on batteries

- Do not mix old batteries with new ones or mix different types of batteries together.
- If the electrolyte inside the battery should leak, wipe the contaminated area of the battery compartment with a cloth and replace the old batteries with new ones. To prevent the electrolyte from leaking, remove the batteries when you plan not to use the Commander for a long period of time.

# Location and Function of Controls

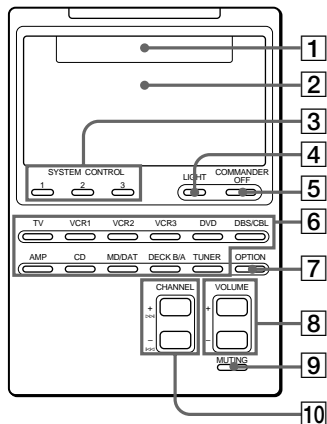

**1** Component display area  
Displays the name of the component selected.

**2** LCD touch key display  
The keys used for operating each component are displayed.

#### Note

Do not press the touch keys using sharp objects such as pins or ball-point pens.

**3** SYSTEM CONTROL buttons (page 20)

You can program up to 16 consecutive key operations to each of the three SYSTEM CONTROL buttons. You can automatically carry out the entire program by pressing one button.

**4** LIGHT button

Used to light up the LCD display in the dark. Press the button once to turn on the light, and once again to turn it off. You can also set the backlight to go off automatically after a certain period of time (page 33).

**5** COMMANDER OFF button

Turns the power of the Commander off.

**6** Component Select buttons

Selects the component to control.

**7** OPTION button (page 17)

You can assign this button to operate any component and use it as a Component Select button.

**8** VOLUME +/- buttons\*

Adjust the volume.

**9** MUTING button\*

Mutes the volume.

**10** CHANNEL +/- buttons

Select the channel.

\* The Commander controls or mutes the TV's volume when you select a visual component. The Commander controls or mutes the amplifier's volume when you select an audio component. You can change this setting also (page 18).

#### Note on the power on and off of the Remote Commander

To turn on the power, press any button except the COMMANDER OFF button.

To turn off, press COMMANDER OFF, or if you don't use the Commander, it automatically turns off after 10 minutes. This interval can also be changed (page 32).

#### To turn off the key touch confirmation beep

Press the  $\blacktriangleright$  key. "OFF" is displayed and the Commander no longer makes the key touch confirmation beep. To switch the key touch confirmation beep back on, press the  $\blacktriangleright$  key again.

## Setting the Code for Preset Audio and Visual Components

The Commander is preset at the factory to operate Sony brand AV components (see the table below). If you are using the Commander with a factory-set Sony components, skip the following procedures.

You can use the Commander with other preset AV components also. To use with other AV components, you need to follow the procedures to set the correct codes for each component.

Component Select Button	Preset component(s)	Factory setting
TV	TV	Sony TV
VCR1	VCR	Sony Beta VCR (VTR1)
VCR2	VCR	Sony 8mm VCR (VTR2)
VCR3	VCR	Sony VHS VCR (VTR3)
DVD	DVD player (DVD)/LD player (VD)	Sony DVD player
DBS/CBL	DBS tuner (DBS)/Cable box (CBL)	Sony DBS tuner
AMP	Amplifier	Sony amplifier
CD	CD player	Sony CD player
MD/DAT	MD deck/DAT deck	Sony MD deck
DECK B/A	Cassette deck*	Sony cassette deck
TUNER	FM/AM tuner/Surround processor	Sony FM/AM tuner
OPTION	(You can preset any of the above.)	—

\* Analog audio compact cassette deck

See “Table of Preset Functions” (page 37) for the functions of keys and buttons as for each component.

### Setting a Component Code

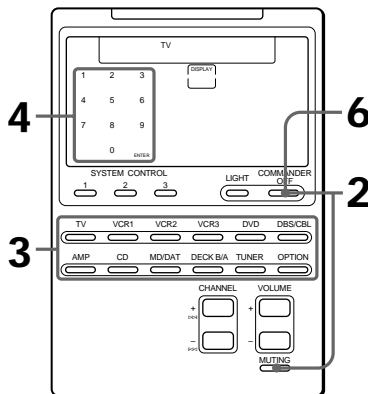

#### Example: To set up a Philips' TV

**1** See the tables in the supplied “Component Code Numbers”, and find the double digit code number for the desired component.

If more than one code number is listed, use the number that is listed first.

For example, to set up a Philips' TV, you would use the code number 11.

**2** While pressing COMMANDER OFF, press MUTING.

COMMANDER OFF + MUTING

All the component names in the display flash.

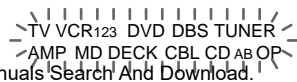



- 3** Press the Component Select button\* for the desired component.

TV



The selected component remains displayed, and the 0 - 9, ENTER and DISPLAY keys flash.

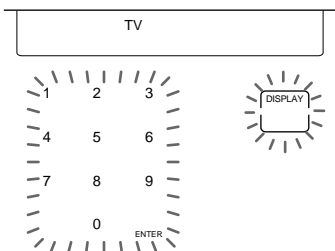

\* When you set the component code of the DVD or DBS/CBL button, press repeatedly until the desired component is displayed.

- 4** Press the double digit component code number followed by the ENTER key on the touch-key display.

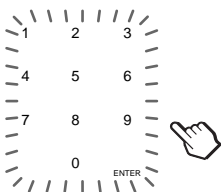

A beep sounds, and the code numbers and "ENTER" appear twice.

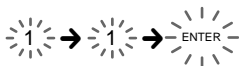

- 5** If you want to set a code for another component, repeat Steps 3 and 4.

- 6** Press COMMANDER OFF.

COMMANDER  
OFF



### Notes

- If you press a component code number that is not on the table in the supplied "Component Code Numbers", the Commander beeps and "NG" flashes after you press the ENTER key. If this happens, check the component code number, and try setting again.
- If you don't input anything into the Commander for over two minutes between each step, the setup procedure will be canceled. To set the code, you must again press MUTING while pressing COMMANDER OFF.

### To check which code number is set

Press the DISPLAY key. The code number and "ENTER" appear twice.

### To set a component code on the OPTION button

Assign a component to the OPTION button first (see page 17), and then follow the procedure on page 8 to 9.

## Setting the Code for Preset Audio and Visual Components (continued)

### Checking if the code number works

- 1 Press the corresponding Component Select button for the component you have set up.

TV



The Commander turns on and the touch-keys appear on the display.

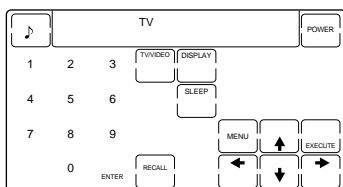

- 2 Power on the component with its power switch.

- 3 Aim the Commander at the component and press the POWER key in the touch-key display.

When the remote control signal is sent,  is displayed on the display.



The component should power off.

- 4 If you have succeeded, check that the Commander is operating the other functions of your component, such as channel and volume control.

See page 11 for details.

### If the Commander does not seem to be working...

Try repeating these setup procedures using the other codes listed for your components (see page 8).

### Notes on keys which have "learned" a remote control signal already

If another signal has already been programmed on that key or button by the learning function (page 13), that "learned" signal will work even after you set the component code number. To use it as a preset component key or button, first erase its learned signal.

### Note on the touch-key display

When you set a component code number, only the keys that have been preset with the signals for the desired component will be displayed. Preset signal of each key varies according to the brand.

By using the learning function, you can program remote control signals to both the displayed keys and keys that are not displayed (see page 13).

# Operating Your Components with the Remote Commander

When you operate a non-Sony component, make sure you set the component code first (page 8).

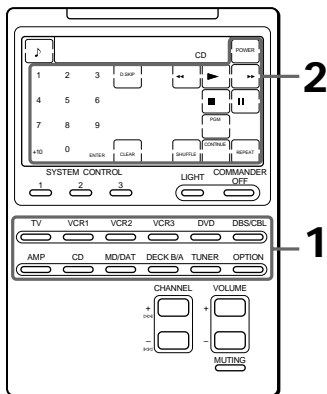

## Example: To play a CD player

- 1 Press the desired Component Select button.

CD



The Commander comes on and the keys for operating the selected component are displayed.

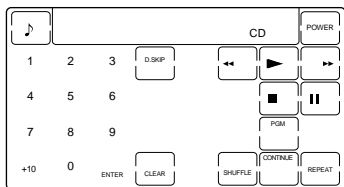

- 2 Press the desired key in the touch key display.

When the remote control signal is sent,  is displayed on the display.



You may also use the VOLUME +/- buttons, the MUTING button and the CHANNEL +/- buttons if necessary.

- 3 When you are done using the Commander, press COMMANDER OFF to power off the Commander.



### Note

The remote control signals may be different for some components or functions. In this case, program the remote control signals with the learning function (see page 13). Note, however, that components and functions that do not support the remote control of infrared signals will not work with this Commander.

### To control the volume

Press the VOLUME +/- buttons to control the volume, and the MUTING button to mute. When you select a visual component, the TV's volume will be controlled, and when you select an audio component, the amplifier's volume will be controlled. You can change this setting also (page 18).

## **Operating Your Components with the Remote Commander (continued)**

### **When you operate a Sony VCR**

Select the VCR1, 2, or 3 button to match the VTR1, 2 or 3 switch on your VCR. If your VCR does not have a VTR1, 2, or 3 switch, select VCR1, 2, or 3 according to the type of VCR as follows.

Betamax	VCR1
8mm	VCR2
VHS	VCR3

### **When you operate a VCR REC (record) key**

In order to avoid recording by mistake, the REC key does not work by itself. To record, you must press the ► key while pressing the REC key.

### **When you use a double cassette deck**

You need to select deck A or B before operating. To select the deck, press DECK B/A to switch the display between "DECK A" and "DECK B".

If the remote control for your cassette deck has only one set of operating buttons and has an A/B button for selecting a deck, press the D.SKIP key in the touch-key display instead.

### **About the input select of a TV**

It is also possible to select directly as follows when you are connecting more than two VCRs.

"TV/VIDEO" + "0" : TV tuner

"TV/VIDEO" + "1" : VIDEO1

"TV/VIDEO" + "2" : VIDEO2

"TV/VIDEO" + "3" : VIDEO3

"TV/VIDEO" + "4" : VIDEO4

"TV/VIDEO" + "5" : VIDEO5

"TV/VIDEO" + "6" : VIDEO6

When you use a Sony TV, the above commands are preset. For other brands, it is possible to "teach" the above double-key operations using the learning function (see page 13).

# Using Non-Preset Remote Control Operations

## — Learning Function

To operate non-preset components or functions, use the following “learning” procedure to “teach” any of the programmable buttons and keys to operate the functions of another remote control. You can also use the learning function to change the signal of individual keys and buttons after setting the component code number (page 8). It is useful if you make a memo of the learned key functions in the LCD touch key display table (See page 43).

### Note

Some specific remote control signals may not be learned.

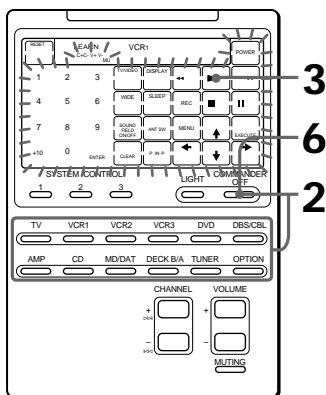

**Example: To program the ► (Play) signal of your component to the VCR1 ► (Play) key of the Commander**

- 1 Place the RM-AV2000 head to head with your component's remote control.

Remote control for your component

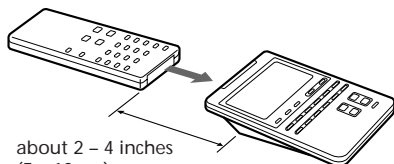

RM-AV2000

- 2 While pressing COMMANDER OFF, press the Component Select button for the component whose signals are to be learned.

COMMANDER OFF + VCR1



All the learnable keys flash.

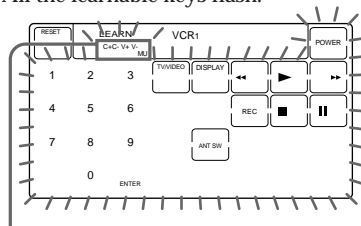

Display for CHANNEL, VOLUME and MUTING buttons

The “C+ C- V+ V- MU” display indicates if CHANNEL +/-, VOLUME +/- and MUTING buttons are learnable or not.

### Note on the flashing display

The keys or buttons that are already preset for that component flash twice while those that are not preset flash once.

## Using Non-Preset Remote Control Operations — Learning Function (continued)

- 3 Press the key or button on the Commander you want to “teach”.



“LEARN” flashes and the only pressed key remains on the display.

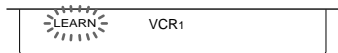

**To teach on the CHANNEL +/-, VOLUME +/- or MUTING buttons**  
Press the corresponding button. “LEARN” flashes, “C+”, “C-”, “V+”, “V-”, or “MU” remains on the display.

- 4 Press and hold down the button on the other remote control until you hear a beep.



“LEARN” stops flashing and stays lit. When the command has been learned successfully, the learned keys stay lit and the other learnable keys flash.

### **If you hear beeps and “NG” flashes on the display**

Learning did not succeed. Try Steps 3 and 4 again.

Certain signals may require the learning procedure more than once to complete learning. In this case, try Step 4 again if “NG” appears after Step 4.

- 5 Repeat Steps 3 and 4 to teach functions to other keys or buttons.

### **To learn another component's remote control signal**

After positioning the two remote commanders as in Step 1 on page 13, press the corresponding Component Select button, and then follow Steps 3 and 4 on the left to perform learning.

- 6 Press COMMANDER OFF.

COMMANDER  
OFF



### **Notes**

- If you do not perform learning steps within two minutes, learning mode ends.
- If you do not perform Step 4 within 10 seconds after Step 3, the display turns back to the display in Step 2. (All the learnable keys flash.) In this case, perform Step 3 again while the display is flashing.
- If “NG” appears while learning, the memory is full. To free memory, clear learned functions from keys that you do not use often (page 16). Then continue the learning steps.
- If you touch a key by mistake, while pressing “RESET” key, press the mistaken key. Then repeat from Step 2 to continue learning.

### **If the Commander does not seem to be working**

If the learned key or button does not operate properly, teach once again. (For example, if the volume becomes very loud after pressing the VOLUME+ button only once, noise may have interfered during the learning procedure.)

### For accurate learning

- Do not move the remote units during the learning procedure.
- Be sure to keep holding down the button of the other remote control until you hear the confirmation beep.
- Use fresh battery in both remote units.
- Avoid learning in places under direct sunlight or a strong fluorescent light.
- The remote control detector area may differ depending on each remote unit. If learning does not work, try changing the positions of the two remote control units.

### To “teach” to the keys for the component to the OPTION button

Assign your desired component, first (see page 17).

#### **IMPORTANT**

Be sure to place the Commander out of the reach of small children or pets. Components such as air conditioners, heaters, electric appliances, and electric shutters or curtains receiving an infrared signal can be dangerous if misused.

### When you teach the signals for a double cassette deck

Press DECK B/A to select deck A or B.

### When you teach the REC (record) signal for VCR1, 2, or 3

In Step 3, while pressing the REC key, press the  key to display both keys, then follow Steps 4 to 6. The Commander can not learn the remote control signal with just the REC key lit up.

### When you teach signals on the VOLUME or MUTING buttons

For components other than TV or AMP, see the notes on page 19 for details.

### To display only the frequently used keys

You can hide keys you do not use. This makes operations even easier to understand, when the components have many keys.

After Step 2 on page 13, while pressing the RESET key, press the key you want to hide (flashing). The pressed key changes to slower flashing and will no longer be displayed during remote control operations.

To display it again, perform the same procedure again.

#### **Note**

You can not hide a key which has “learned” any signal.

---

## Changing or erasing the function of a learned key or button

To change the learned function, clear it first and perform learning again.

### To clear the learned function of a single key or button

---

- 1 After Step 2, while pressing the RESET key, press the key or button you want to erase.

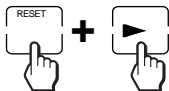

The cleared key flashes together with other learnable keys.

---

### To clear all signals learned for a specific component

---

- 1 While pressing COMMANDER OFF, press the corresponding Component Select button.

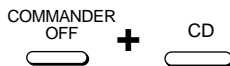

#### When you want to clear signals learned for DECK B/A

Press DECKB/A to display "DECK A" or "DECK B". You can not clear both decks at the same time.

---

- 2 While pressing the RESET key, press that Component Select button again. The Commander beeps, the learned contents are cleared. The keys for the component return to their original states before learning.

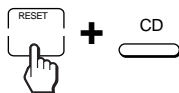

---

#### Note

If you perform the steps above when no signal is "learned", the component code setting (page 8) will be reset to the factory setting.

Note that for DECK B/A, if you reset either deck (A or B), the component code for both A and B will be reset to the factory setting.



## Using the OPTION button

You can use the OPTION button as an extra Component Select button. For example, if you have two CD players, you can set the remote control signals of the second CD player to the OPTION button to select its key operation. To use the OPTION button, first assign a component on it. Then you can either use it as it is with a Sony component, set a component code (page 8), or “teach” the keys and buttons necessary remote control signals (page 15).

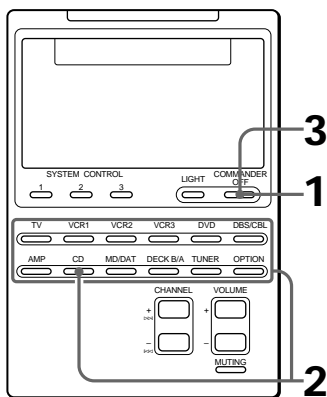

### Example: To assign a CD player (CD) to the OPTION button

- 1 While pressing COMMANDER OFF, press OPTION.

COMMANDER OFF + OPTION

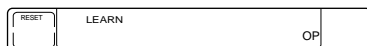

When a component is already assigned to OPTION, the component name and learnable keys flash. To perform learning, skip to Step 3.

- 2 While pressing OPTION again, press the desired Component Select button.

OPTION + CD

The Commander beeps, and the Commander automatically goes into learning mode (page 12).

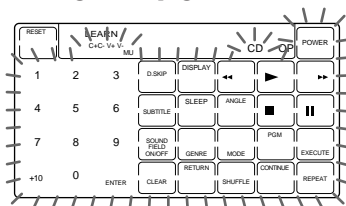

#### When you assign an LD player (VD) or a cable box (CBL)

Repeat this step again so that the desired component (“VD” or “CBL”) flashes.

#### When you assign a cassette deck (DECK B/A)

You cannot assign both decks A and B to the OPTION button at a time. If the desired deck (A or B) is not displayed, finish the procedure by pressing COMMANDER OFF and press DECK B/A to select the desired deck, and then start over from Step 1.

### Using the **OPTION** button (continued)

- 
- 3** • If the newly assigned component is a Sony component, press **COMMANDER OFF** to finish this procedure.
- If you need to set the component code, follow the steps on pages 8 and 9.
  - If you need to program some signals by the “learning” function, follow the Steps 1 and 3 to 6 on pages 13 and 14.
- 

### To change the component assigned to the **OPTION** button

Follow Step 1 to 3 above.

#### **Note**

If you leave the Commander with the component names flashing for over two minutes, the operation will be cancelled. To assign a component to the **OPTION** button, start over the procedure from the beginning.

## Controlling the Volume of Visual Components Connected to an Audio System

The Commander is factory preset based on the assumption that you hear the sound of your visual components from your TV speakers, and that you hear sound of your audio components from the loudspeakers connected to your amplifier.

The following table shows the factory setting of which volume would be controlled for each component.

Component Select button	Controls the volume of
TV	TV
VCR1,2,3	TV
DBS/CBL	TV
DVD	TV
AMP	amplifier
CD	amplifier
MD/DAT	amplifier
DECK B/A	amplifier
TUNER	amplifier
OPTION	TV/amplifier (depending on the assigned component)

This feature enables you to control the volume of your TV or amplifier without having to select TV or AMP each time you want to control the volume. For example, to control the volume while using a VCR, you don't need to press the TV button to control the TV volume.

## Notes

- If you have programmed any signal on the VOLUME or MUTING buttons by learning (page 13) for certain components, that signal will be transmitted instead of controlling the volume of TV or amplifier when you select that component.
- When the VOLUME or MUTING buttons of TV or AMP have "learned" any signal, that signal will be transmitted only when you select TV or AMP. When you select other components, the original signals preset for TV or AMP will be transmitted.

## To change the Factory Preset of the Volume Control

However, if your visual components are connected to an audio system, you probably hear TV or VCR sound from the loudspeakers via your amplifier, not from your TV speakers. In this case, you need to change the factory preset so that you can control the volume of your visual components without first having to switch to the amplifier.

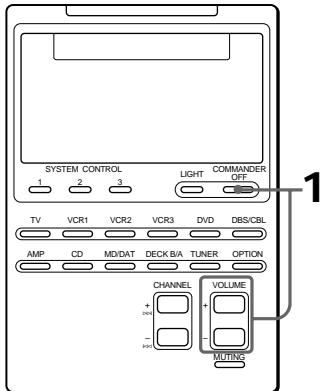

## 1 While pressing COMMANDER OFF, press VOLUME + and VOLUME -.

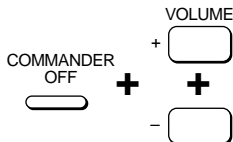

You hear a beep and the volume control setting of visual components (TV, VCR1, 2 and 3, DBS/CBL, and DVD) changes to the displayed component.

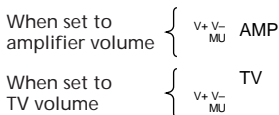

## Notes

- If you have already programmed the VOLUME or MUTING button of each component any signals by "learning", the procedure above will not change the function of the VOLUME and MUTING buttons.
- If you have programmed volume control signals on VOLUME or MUTING buttons of TV or AMP, you can only use that signal when you select TV or AMP. For other component, the preset volume control signals for TV or AMP (depending on the above setting procedure) will be transmitted. To use the new signals, you need to program each button for each component by the learning procedure (page 13).

## Executing a Series of Commands

### — System Control Function

With the System Control function, you can program a series of operating commands, and execute them by pressing just one button.

For example, when you watch a video, a series of operations like the ones below are necessary.

Example:

- 1 Power on the TV.
- 2 Power on the video (VCR 1).
- 3 Power on the amplifier.
- 4 Set the input selector of the amplifier to VIDEO 1.
- 5 Set the input mode of the TV to VIDEO.
- 6 Start video playback

You can program up to 16 consecutive operation steps to each of the SYSTEM CONTROL 1, 2 or 3. At the factory, SYSTEM CONTROL 1 and 2 are not programmed yet, but a series of Power-on Commands for Sony Components is programmed on the SYSTEM CONTROL 3 button.

## Programming a series of commands to the SYSTEM CONTROL buttons

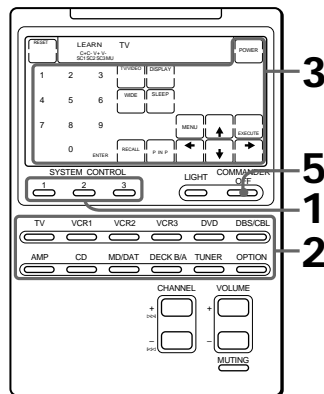

Example: To program the procedure on the left to the SYSTEM CONTROL 1 button

- 1 While pressing COMMANDER OFF, press one of the SYSTEM CONTROL buttons (in this case, SYSTEM CONTROL 1).

COMMANDER OFF + SYSTEM CONTROL 1

All the component names flash.

```

  /-TV VCR123 DVD DBS TUNER \-
 /-AMP MD DECK CBL CD AB OP \-
  
```

**If a series of commands is already programmed on that button**

That program will be displayed. (Note that the SYSTEM CONTROL 3 button is factory preset with standard Power-on Command for nearly all Sony Components.) To program a new series of operations, clear the program first (see page 23).

- 2 Press the Component Select button for the component to operate.

TV



The keys for the selected component flash.

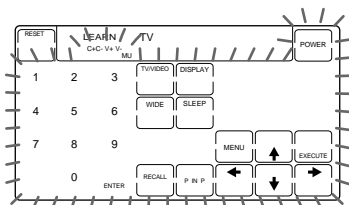

- 3 Press key(s) or button(s) for the desired operation.



The remote control signal for the pressed key is transmitted, so you can check that each component actually operates the way you want.

- 4 Repeat Steps 2 and 3 and program the buttons and keys for the series of operations.

In this example, press the following buttons and keys.

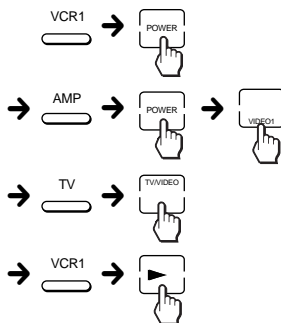

- 5 When you have programmed all the keys, press COMMANDER OFF.

COMMANDER OFF



### Notes

- If you interrupt the procedure at any point for over two minutes, the setting mode ends and the series of commands will be programmed to that point. In this case, clear the program and start again from Step 1 to set the entire program from the beginning. You can not continue from where you left off.
- If a SYSTEM CONTROL button has already "learned" a remote control signal (see page 29), "NG" flashes and you hear a beep to inform you that you can not program on this button. Clear the learned contents first (see page 30).
- If you change the component code number (page 8) or program a new signal by learning (page 13) on a key or button that has been programmed in the series of commands of the System Control function, the new signal will be transmitted when you press the corresponding SYSTEM CONTROL button.

## Executing a Series of Commands — SYSTEM CONTROL buttons (continued)

### Tip for programming on SYSTEM CONTROL button

After the series of input commands is executed, the Commander displays the touch keys of the component of the final step. By programming an often-used component's command as the final step, you can save the step of pressing a Component Select button when you start operating that component.

---

## Executing the programmed commands

Press the desired SYSTEM CONTROL button (1, 2 or 3). The programmed remote control signals are transmitted in the programmed order to operate each component.

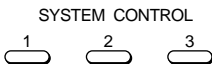

At the same time that each remote control signal is transmitted, the corresponding key is displayed.

## Notes on System Control Operation

- If the remote control detectors of the components are too far apart, or if something is blocking them, some of the components may not operate consecutively even after you press the SYSTEM CONTROL button.
- If some of the components did not operate correctly because of the above or for any other reason, always set all the components back to the states they were in before you pressed the SYSTEM CONTROL button. Failure to do this can result in incorrect operation when you press the SYSTEM CONTROL button again.
- Some components may not always be powered on by the System Control function. This is because the power of the component gets on and off alternatively when receiving the power on/off signal. In this case, check the operating component's power on/off state before using the SYSTEM CONTROL function.
- Some of the components may not accept consecutive remote control signals. For example, a TV generally does not react to next signal right after the Power-on signal. So, a series of commands such as TV Power-on and input select may not work properly. In this case, insert other signals like the example below;  
TV Power-on → VCR Power-on  
→ VCR play back → TV input select

---

## Changing the programmed commands

### To clear programmed commands

---

- 1 While pressing COMMANDER OFF, press one of the SYSTEM CONTROL 1, 2, or 3 button.

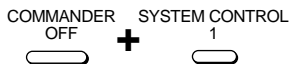

The key operations programmed for that button are displayed in order.

---

- 2 While pressing the RESET key, press the same SYSTEM CONTROL button (1, 2, or 3) again.

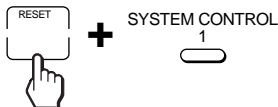

The contents of its program are cleared and all the component names flash.

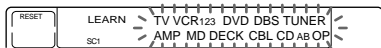

When you want to set a new program to this SYSTEM CONTROL button, follow the Steps 2 – 5 on Page 21.

---

To set SYSTEM CONTROL 3 back to the factory setting (Power-on commands for Sony components)

---

- 1 While pressing COMMANDER OFF, press SYSTEM CONTROL 3.

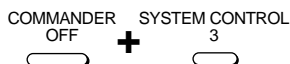

The programmed key operations are displayed in order.

---

- 2 While pressing the RESET key, press SYSTEM CONTROL 3.

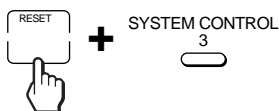

The contents of its program are cleared and all the components names flash.

---

- 3 While pressing the RESET key again, press SYSTEM CONTROL 3 again.

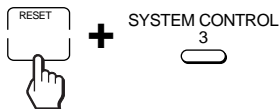

The series of the Power-on commands for Sony Components are set and the programmed operations are displayed in order.

---

# Adding an Extra Function to the Component Select Buttons

## Programming the Power-On Command of the Selected Component (for Sony Components only)

When using Sony components, you can program the Power-on signal for each component on a Component Select button. You can select the desired component and power it on by just pressing that Component Select button.

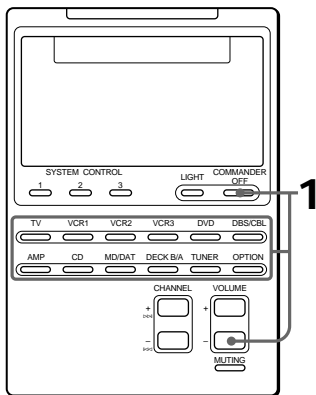

## Example: To program the TV button

- 1 While pressing COMMANDER OFF, press VOLUME – and the desired Component Select button.



When the Power-on command is programmed, you will hear a beep and “POWER ON” appears on the display. (The display goes off when you release the buttons.)



## To clear the Power-on command

Repeat the procedure above.

You will hear a beep and the following display appears.



## Notes

- When a signal has been already learned for a Component Select button (see page 25), the Power-on command can not be programmed.
- When you program another signal using the learning function to a Component Select button (page 25) for which a Power-on command has been already programmed, the learned signal overwrites the Power-on command. If the learned signal is cleared afterward, the Power-on command will also be erased and the button will return to its status before being programmed.



## Adding a Command that is Required when Selecting a Component

In addition to the original function of selecting the operating keys and buttons of the desired component, the Component Select button can have another remote control signal by "learning" (see page 13).

For example, if you always have to change input select of the amplifier to CD when listening to the CD player, program the signal of "changing the amplifier's input select" to the CD button of this Commander. Then whenever you press the CD button, it automatically works as the original CD Component Select button and changes also the amplifier input select to CD.

**Example :** To program the input select signal of your amplifier to the CD button

- 1 Place the RM-AV2000 head to head with your component's remote control.

Remote control of your component

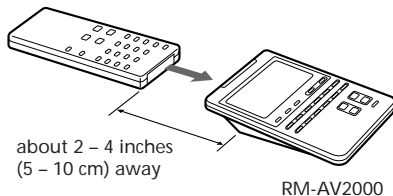

- 2 While pressing COMMANDER OFF, press VOLUME + and CHANNEL +.

COMMANDER OFF + VOLUME + CHANNEL +

"LEARN" appears and all the component names flash.

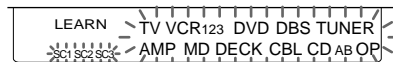

- 3 Press the desired Component Select button.

CD

The selected component name stays lit and "LEARN" flashes.

LEARN CD

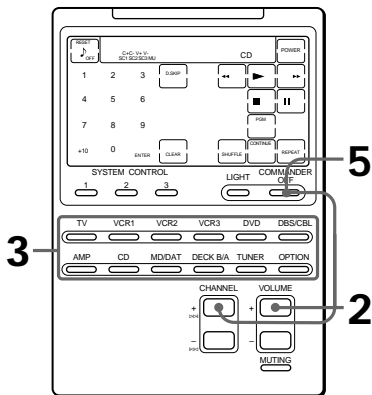

## Adding an Extra Function to the Component Select Buttons (continued)

- Press and hold down the button on the component's remote control (amplifier in this example) until you hear a beep.



- Press COMMANDER OFF.



### To clear the learned function of the Component Select button

- While pressing COMMANDER OFF, press VOLUME+ and CHANNEL+.
- While pressing the RESET key, press the Component Select button which you want to clear.

#### Note

- Even if that Component Select button has been programmed with the Power-on command (page 24), you can program any signal on it by the procedure above. However, the new signal overwrites the Power-on command, and even after you clear this new signal, the Power-on command will not resume.

## Turning Off the Power of All Components by a Single Button Operation

### — System Power-Off Function (for Sony Components only)

When the System Power-Off function is active, you can turn off all Sony components just by pressing the COMMANDER OFF button for three seconds.

### To set the System Power-Off function

- While pressing COMMANDER OFF, press CHANNEL - and VOLUME +.

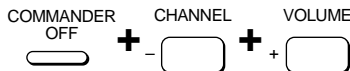

When the System Power-Off function is set, "POWER OFF" appears on the display. (The display goes off when you release the buttons.)



### To cancel the System Power-Off function

Repeat the procedure above. The following display appears when the System Power-Off function is disabled.



# Assigning Other Components to the Component Select Buttons

In addition to using the OPTION button as an extra Component Select button, assign another component to any Component Select button. For example, if you have two VCRs and two CD players, you can use the VCR3 button as the Component Select button for your second CD player.

## Note

Once you assign another component to a Component Select button, the setting of the component code number will be erased. The component code number will not return even if you reset the newly assigned component and turn back to the original component.

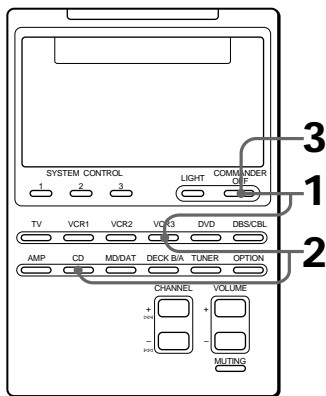

## Example: To assign a CD player to the VCR3 button

- 1 While pressing COMMANDER OFF, press VCR3.

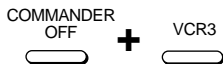

The keys for that component (VCR3) flash.

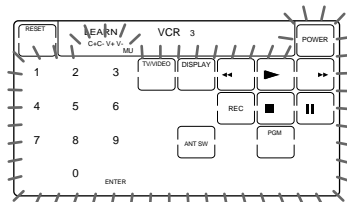

- 2 While pressing VCR3, press CD.



The Commander beeps and the keys for the new component (CD) flash. The new component name (CD) flash and the original component name (VCR3) stays lit.

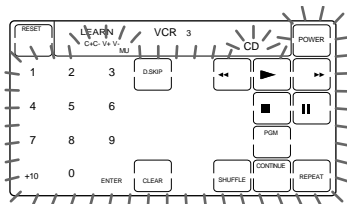

## When you assign a cassette deck (DECK B/A) on another Component Select button

You cannot assign both decks A and B at a time to one button. If the desired deck (A or B) is not displayed, finish the procedure by pressing COMMANDER OFF and press DECK B/A to select the desired deck, and then start over from Step 1.

### Assigning Other Components to the Component Select Buttons (continued)

- 3** • If the newly assigned component is a Sony component, press **COMMANDER OFF** to finish this procedure.
- If you need to set the component code, follow the steps on pages 8 and 9.
  - If you need to program some signals by the “learning” function, follow the Steps 1 and 3 to 6 on pages 13 and 14.

#### Notes

- If you hear beeps and “NG” flashes on the display when you press the Component Select button at Step 1, you can not assign another component because some of the keys or buttons are already programmed with the learning function (see page 25). Try the above procedure again after clearing the learned signals for that component.
- You cannot press **OPTION** in Step 2 even if you have assigned a component on the **OPTION** button.

### To assign an LD player (VD) or a Cable box (CBL) on another Component Select button

If the desired component (“VD” or “CBL”) is not displayed, before Step 3, repeat Step 2 again so that desired component (“VD” or “CBL”) flashes on the display.

### To use the Commander after assigning other components

Press the reassigned Component Select button. The keys of the new component are displayed and you can use the desired component. Note however that only the original component name is displayed.

(In this example, the display would be like the one below.)

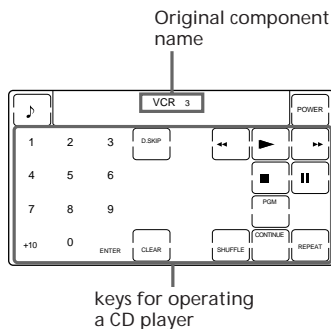

### To reset a Component Select button to its original setting

- 1 While pressing **COMMANDER OFF**, press the Component Select button which you want to reset.
- 2 While pressing the **RESET** key, press that Component Select button again. The setting for that Component Select button returns to the factory setting.

#### Note

If you have programed some signals on any of the keys or buttons with the learning function (see page 14) after you reassigned your component, the two steps above only clears the “learned” signals. In this case, perform Step 2 again to reset to the original Component Select button.

# Programming a Frequently Used Key Operation to SYSTEM CONTROL Buttons

In addition to their original System Control functions (see page 19), SYSTEM CONTROL 1, 2 or 3 buttons can be programmed to “learn” any remote control signal.

As they operate independently from other buttons, SYSTEM CONTROL 1, 2 or 3 buttons can work as one-touch buttons without any preceding operation such as pressing a Component Select button to select a component.

This is useful if you prefer having the SYSTEM CONTROL button as a “one-touch” button for a single operation rather than executing a series of commands.

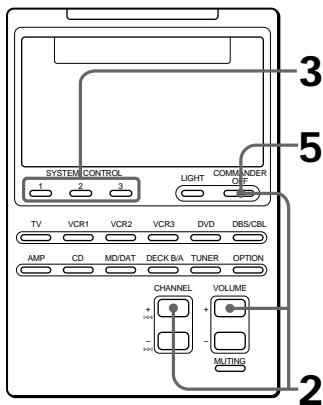

**Example:** To store the On/Off signal of an air-conditioner to the SYSTEM CONTROL 2 button

- 1 Place the Commander head to head with the remote control of the air-conditioner.

Remote control of your component

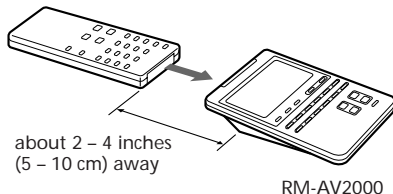

- 2 While pressing COMMANDER OFF, press CHANNEL + and VOLUME +.

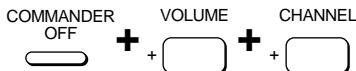

“LEARN” appears and the display that stands for the learnable SYSTEM CONTROL buttons flash in the display panel.

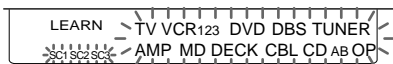

If a signal has been learned on that button, the display stays lit. If you want to program on that button, clear the signal first (page 30).

## Programming a Frequently Used Key Operation to SYSTEM CONTROL Buttons (continued)

- 3** Press the SYSTEM CONTROL button you want to teach.

SYSTEM CONTROL



“LEARN” flashes and the display for the pressed SYSTEM CONTROL button stays lit.



- 4** Press and hold down the button of the remote control until you hear a beep.

AIR CONDITIONER



“LEARN” display stops flashing and stays lit.

**If you hear beeps and “NG” flashes on the display**

Learning did not succeed. Try Steps 3 and 4 again.

- 5** Press COMMANDER OFF.

COMMANDER OFF



### To clear the learned remote control signal

- While pressing COMMANDER OFF, press VOLUME + and CHANNEL+.
- While pressing the RESET key, press SYSTEM CONTROL 1, 2, or 3.

## Locking the Controls

### — Hold Function

To prevent accidental operation, you can lock all the buttons with the Hold function.

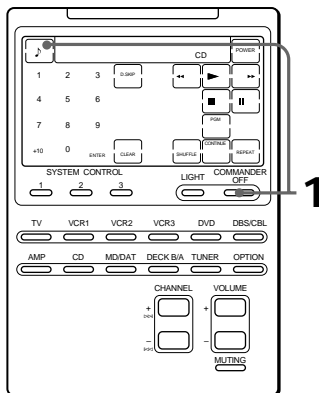

If the ♪ key is not displayed, press any button before you start.

- 1** While pressing the ♪ key, press COMMANDER OFF.

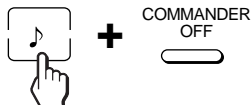

The Commander beeps and “OFF” is displayed.



### To unlock the control

While pressing the “OFF” key, press COMMANDER OFF. “OFF” disappears from the display.

# Protecting your settings and “learned” signals

## — Preset Lock function

You can lock the Commander so that you can not change, add, or clear any of your component code settings (page 8), “learned” signals (pages 13, 25, 29, etc.), System Control settings, (page 20), volume setting (page 18), or System Power-off setting (page 26).

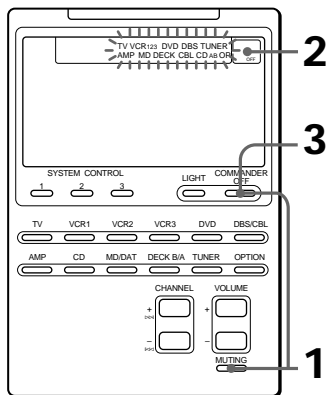

- 1 While pressing COMMANDER OFF, press MUTING.

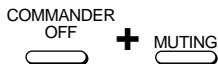

All the component names flash and “OFF” key appears.

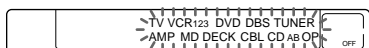

- 2 Press the OFF key.



All the component names stop flashing and stay lit, and “ON” flashes.



- 3 Press COMMANDER OFF.

## When the preset lock is on

If you try to set a component code number (page 8) or perform learning (page 13), you will hear beeps and “NG” flashes on the display.

## To unlock the preset lock

To unlock the preset lock, follow the same procedure as the above and press “ON” in Step 2. “OFF” appears on the display.

# Changing the Auto Power-Off Time of the Commander

The Commander is preset at the factory to switch the power off automatically after 10 minutes if left unused (Auto Power-Off). To change this time, perform the following procedure.

You can set the Auto Power-Off time up to 90 minutes, in units of 10 minutes, or disable the Auto Power-Off function.

## Note

The Auto Power-Off function only turns off the power of the Commander, but not of the component.

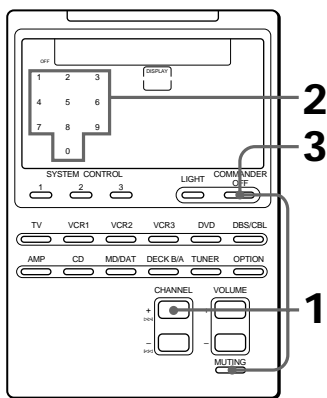

- 1 While pressing **COMMANDER OFF**, press **CHANNEL +** and **VOLUME -**.

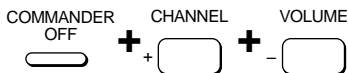

The number which shows the current Power-Off time of the Commander stays lit, and other numbers flash.

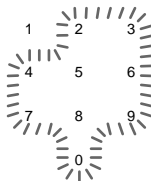

- 2 Press one of the 1 - 9 keys to select the Auto Power-Off time, or press the 0 key to disable the Auto Power-off function.

For example, to set the Auto Power-Off time to 20 minutes, press the 2 key.



The Commander beeps, and "2" stops flashing and stays lit.

- 3 Press **COMMANDER OFF**.





# Adjusting the Backlight of the Display Window

The Commander is preset at the factory to bright backlight, and to switch off the backlight automatically after 10 seconds. To change this setting, perform the following procedure.

You can adjust the backlight Automatic-Off time (from 10 seconds to 90 seconds in the units of 10 seconds) and the brightness (bright or dim).

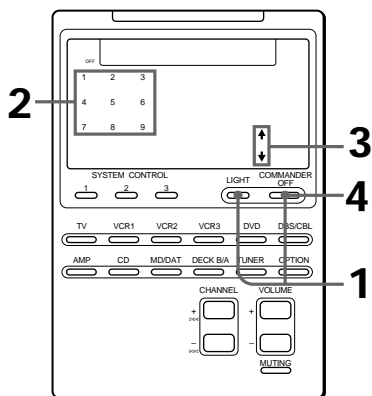

- 1 While pressing COMMANDER OFF, press LIGHT.

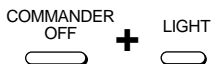

- 2 Press one of the 1 – 9 keys to select the Off time.

For example, to set the Automatic-Off time to 20 seconds, press the 2 key.



The Commander beeps and “2 “ stops flashing and stays lit.

- 3 Press the ↑ or ↓ key, to select the brightness.

To brighten, press ↑, to dim, press ↓.



The Commander beeps and the chosen arrow stays lit.

- 4 Press COMMANDER OFF.



The number which shows current Automatic-Off time and the arrow indicating the current brightness of the backlight stay lit. Other numbers and the opposite arrow will flash.

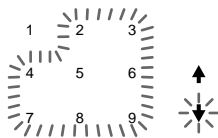

## Precautions

- Do not drop the unit or give a shock to the unit, or it may cause a malfunction.
- Do not leave the unit in a location near heat sources, or in a place subject to direct sunlight, excessive dust or sand, moisture, rain or mechanical shock.
- Do not put foreign objects into the unit. Should any liquid or solid object fall into the unit, have it checked by qualified personnel before operating the unit any further.
- Do not expose the remote control detectors of your components to direct sunlight or other strong illumination. Too much light there can interfere with remote control operations.
- Be sure to place the Commander out of the reach of small children or pets. Components such as air conditioners, heaters, electric appliances, and electric shutters or curtains receiving an infrared signal can be dangerous if misused.

## Maintenance

Clean the surface with a soft cloth slightly moistened with water or a mild detergent solution. Do not use any type of solvent such as alcohol, benzine or thinner as they may damage the finish of the surface.

## Specifications

### **Operating distance**

Approx. 10 meters (32.8 ft.) (varies depending on components of different manufacturers)

### **Power requirements**

Remote control: Four size AA (R6) batteries  
Backlight: Two size AA (R6) batteries

### **Battery life**

Approx. 6 months (varies depending on frequency of use)

### **Dimensions**

Approx. 120 x 175 x 45 mm (w x h x d) (4<sup>3</sup>/<sub>4</sub> x 7 x 1<sup>13</sup>/<sub>16</sub> in.)

### **Mass**

290 g (10.22 oz.) (not including batteries)

Design and specifications are subject to change without notice.

# Troubleshooting

If you have problems setting up or using the Remote Commander, first check the batteries (page 6), then check the items below.

Symptom	Remedy
You cannot operate the components.	<ul style="list-style-type: none"><li>• Go closer to the component. The maximum operating distance is approximately 10m (32.8 ft.).</li><li>• Check that you are aiming the Commander directly at the component, and that there are no obstructions between the Commander and the component.</li><li>• Power on the components first, if necessary.</li><li>• Make sure you have pressed the correct Component Select button. In case of DBS/CBL, DVD or DECK B/A, make sure the desired component is displayed.</li><li>• Check that the component has infrared remote capability. For example, if your component didn't come with a remote commander, it probably isn't capable of being controlled by a remote commander.</li><li>• If your visual components are connected to an audio system, make sure you've set up the Commander as described in "Controlling the Volume of Visual Components Connected to an Audio System". (page 18)</li></ul>
You cannot operate the components even after setting the component code numbers.	<ul style="list-style-type: none"><li>• Set the component code correctly (page 8). If the code that is listed first for your component doesn't work, try all the codes for your component in the order in which they are listed in the supplied "Component Code Numbers".</li><li>• Some features may not be preset. If some or all of the keys do not function correctly even after you have set the component codes, then use the learning function to program the remote control signals for the component. (page 13)</li></ul>
You cannot operate a component even after you programmed the remote control signals with the "learning" function.	<ul style="list-style-type: none"><li>• Make sure that the Remote Commander has learned the correct signals. If not, try the learning procedure again. (page 13)</li></ul>
"NG" flashes during learning.	<ul style="list-style-type: none"><li>• Clear infrequently used learned keys (page 15), then carry out learning operations.</li><li>• See "For accurate learning" on page 15 and try the learning procedure again. (page 13)</li></ul>
"NG" displays during learning.	<ul style="list-style-type: none"><li>• Another remote control signal has been already programmed on that key or button by the learning function. Clear learned functions (page 16) and then try the learning procedure again. (page 13)</li></ul>

## Troubleshooting (continued)

Symptom	Remedy
A system control program does not function correctly.	<ul style="list-style-type: none"><li>• Make sure that you have programmed the commands in the correct order. (page 20)</li><li>• Try changing the orientation of the Commander. If that does not help, try placing the components as close to each other as possible.</li><li>• Check the status of the components and make sure that you have set the components properly to receive commands from the SYSTEM CONTROL buttons.</li></ul>
The power of the Commander turns off by itself.	<ul style="list-style-type: none"><li>• This Commander is preset at the factory to switch the power off automatically after 10 minutes if left unused. (Auto Power-Off, page 32) You can change the power-off time from 10 to 90 minutes, or set the Commander not to power off automatically.</li></ul>

### For the customers in the U.S.A

#### **Customer Support Information**

After you have read through this manual, if you still can not get the Remote Commander to work properly, call the Sony Customer Support Helpline at 1-800-822-2217.

## Table of Preset Functions

### TV

KEY DISPLAY	FUNCTION
POWER	To turn on and off.
1 - 9, 0, ENTER	To change the channel. For example, to change to channel 5, press 0 and 5 (or, press 5 and ENTER).
TV/VIDEO	To change the input mode.
DISPLAY	To display the current channel on TV.
WIDE	To switch to WIDE.
SLEEP	To operate SLEEP function on the TV (Works only for a TV with SLEEP function).
MENU	To call up the MENU display.
↑	To move the cursor upward.
RECALL	To operate JUMP, FLASHBACK or CHANNEL RETURN function on the TV depending on the setting of the TV's manufacturer.
←	To move the cursor to the left.
↓	To move the cursor downward.
→	To move the cursor to the right.
CH +/-	Channel up: + Channel down: -
VOL +/-	Volume up: + Volume down: -
MUTING	To mute the volume on the TV. Press again to turn muting off.

### VCR 1, 2, 3

KEY DISPLAY	FUNCTION
POWER	To turn on and off.
1 - 9, 0, ENTER	To change the channel. For example, to change to channel 5, press 0 and 5 (or, press 5 and ENTER).
TV/VIDEO	To change the input mode.
DISPLAY	To display the on-screen menu.
⏮	To rewind.
▶	To play.
⏭	To fast-forward.
REC	To record, press ▶ while pressing REC. First release ▶, then release REC.
■	To stop.
⏸	To pause.
ANT SW	To switch the antenna output.
CH +/-	Channel up: + Channel down: -

**Table of Preset Functions  
(continued)**

<b>DVD</b>	
<b>KEY DISPLAY</b>	<b>FUNCTION</b>
POWER	To turn to the power on and off.
1 - 9, 0	Number buttons: To set items selected from the screen.
+10	To select numbers 10 and above.
ENTER	To enter the setting. To set items selected from the screen.
AUDIO	To change the sound.
DISPLAY	To show the current play status on the screen.
◀◀	To rewind.
▶	To play.
▶▶	To fast-forward
SUB TITLE	To switch the subtitle.
SUB TITLE ON/OFF	To switch the subtitle on and off.
ANGLE	To switch angle.
■	To stop.
	To pause.
TITLE	To display the title menu.
DVD MENU	To display the DVD menu.
MENU	To set or adjust menu items.
↑	To move the cursor upward.
EXECUTE	To execute items selected from the screen.
CLEAR	To clear the selected characters from the screen.
RETURN	To return to the last previous screen.
←	To move the cursor to the left.
↓	To move the cursor downward.
→	To move the cursor to the right.
CH +	To proceed to the next location or song.
CH -	To proceed to the previous location or song.

**VD (LD player)**

<b>KEY DISPLAY</b>	<b>FUNCTION</b>
Power	To turn on and off.
1 - 9, 0	To select the track number. 0 selects track 10. To select track numbers above 10, see the descriptions on the +10 button below.
+10	To select numbers 10 and above.
ENTER	To enter the setting.
DISPLAY	To show the current play status on the screen.
◀◀	To rewind.
▶	To play.
▶▶	To fast-forward.
■	To stop.
	To pause.
CLEAR	To clear the selected characters from the screen.
CH +	To proceed to the next location or song.
CH -	To proceed to the previous location or song.

## DBS

KEY DISPLAY	FUNCTION
POWER	To turn on and off.
1 - 9, 0, ENTER	To change the channel. For example, to change to channel 5, press 0 and 5 ( or, press 5 and ENTER)
DISPLAY	To turn on the display.
GUIDE	To bring up Master Guide.
FAVORITE	To use the "FAVORITE" function.
TV/DBS	To switch the output of the DBS receiver to the TV. (When you connect a TV cable or antenna to the receiver, the output switches between a TV and DBS program.)
MENU	To call up the MENU display.
↑	To move the cursor upward.
EXECUTE	To bring up the Station Index when a program guide is not displayed. To select the channel that is highlighted.
RECALL	To tune to the last tuned station.
←	To move the cursor to the left.
↓	To move the cursor downward.
→	To move the cursor to the right.
CH +/-	Channel up : + Channel down : -

## CBL (Cable box)

KEY DISPLAY	FUNCTION
POWER	To turn on and off.
1 - 9, 0	To change the channel. For example, to change to channel 5, press 0 and 5 ( or, press 5 and ENTER.)
RECALL	To tune to the last tuned station.
CH +/-	Channel up : + Channel down : -

**Table of Preset Functions  
(continued)**

**AMP**

KEY DISPLAY	FUNCTION
POWER	To turn on and off.
VIDEO 1	To select the input source: VIDEO 1
VIDEO 2	To select the input source: VIDEO 2
VIDEO 3	To select the input source: VIDEO 3
VDP	To select the input source: VDP
TV	To select the input source: TV
TAPE	To select the input source: TAPE
DAT/MD	To select the input source: DAT/MD
CD	To select the input source: CD
TUNER	To select the input source: TUNER
PHONO	To select the input source: PHONO
MENU	To call up the MENU display.
↑	To move the cursor upward.
SHIFT	To shift band (FM/AM)
←	To move the cursor to the left.
↓	To move the cursor downward.
→	To move the cursor to the right.
CH +/-	Presetting frequency up: +, down: -  Tuning frequency up: +, down: -
VOL +/-	Volume up: +  Volume down: -
MUTING	To mute the volume on the AMP. Press again to turn muting off.

**CD**

KEY DISPLAY	FUNCTION
POWER	To turn on and off.
1 - 9, 0	To select the track number. 0 selects track 10. To select track numbers above 10, see the descriptions on the +10 button below.
+10	To select numbers 10 and above.
ENTER	To enter the setting.
D.SKIP	To select next disk.
◀◀	To rewind.
▶	To play.
▶▶	To fast-forward.
■	To stop.
	To pause.
PGM	To use for program play.
CLEAR	To clear the setting.
SHUFFLE	To play in random order.
CONTINUE	To select continuous play mode.
REPEAT	To select repeat play mode.
CH +	To select the previous track.
CH -	To select the next track.



## MD

KEY DISPLAY	FUNCTION
POWER	To turn on and off.
1 - 9, 0	To select the track number. 0 selects track 10. To select track numbers above 10, see the descriptions on the +10 button below.
+10	To select numbers 10 and above.
ENTER	To enter the setting.
◀◀	To rewind.
▶	To play.
▶▶	To fast-forward.
REC	To record, press ▶ while pressing REC. First release ▶, then release REC.
■	To stop.
	To pause.
PGM	To use for program play.
CLEAR	To clear the setting.
SHUFFLE	To play in random order.
CONTINUE	To select continuous play mode.
REPEAT	To select repeat play mode.
CH +	To select the previous track.
CH -	To select the next track.

## DAT

KEY DISPLAY	FUNCTION
POWER	To turn on and off.
1 - 9, 0	To select a program number.
ENTER	To enter the setting.
◀◀	To rewind.
▶	To play.
▶▶	To fast-forward.
REC	To record, press ▶ while pressing REC. First release ▶, then release REC.
■	To stop.
	To pause.
○	Record muting.
REPEAT	To select repeat play mode.
CH +	To proceed to the next song.
CH -	To proceed to the previous song.

**Table of Preset Functions  
(continued)**

## DECK B/A

KEY DISPLAY	FUNCTION
D.SKIP	To select the tape deck : Deck A or B (dual cassette deck only).
◀◀	To rewind.
◀	To reverse.
▶	To play.
▶▶	To fast-forward.
REC	To record, press ▶ while pressing REC. First release ▶, then release REC. To record, press ◀ while pressing REC. First release ◀, then release REC.
■	To stop.
	To pause.
○	Record muting.

## TUNER

KEY DISPLAY	FUNCTION
POWER	To turn on and off.
1 - 9, 0	Number buttons
+10	To select numbers 10 and above.
ENTER	To enter the setting.
>	Tuning down.
<	Tuning up.
BAND	To select FM/AM.
CH +	Preset tuning +.
CH -	Preset tuning -.

## DSP (Digital Surround Processor)

KEY DISPLAY	FUNCTION
AUDIO	To select the DPC mode
DISPLAY	To change the display
<	Input select <.
>	Input select >.
SOUNDFIELD ON/OFF	To turn on/off the sound fields
GENRE	To select a sound field genre.
MODE	To select a sound field mode.
↑	Digital processing control ^.
T.TONE	To make a test tone.
←	Digital processing control <.
↓	Digital processing control v.
→	Digital processing control >.

# LCD Touch Key Display Table

## Memo for component select buttons

If you assign other components on Component Select buttons, use the space below as your memo.

	TV	VCR1	VCR2	VCR3	DVD	DBS/CBL
New component →	<input type="text"/>	<input type="text"/>	<input type="text"/>	<input type="text"/>	<input type="text"/>	<input type="text"/>
	AMP	CD	MD/DAT	DECK B/A	TUNER	OPTION
New component →	<input type="text"/>	<input type="text"/>	<input type="text"/>	<input type="text"/>	<input type="text"/>	<input type="text"/>

## Keys for each component

The followings are the tables of the keys available for each component, which are useful if you use them as a memorandum of learned keys.

### TV

RESET	TV					POWER
	C+C- V+ V- MU					
1	2	3	TV/VIDEO	DISPLAY	◀	▶
4	5	6	WIDE	SLEEP	REC	■
7	8	9	SOUND FIELD ON/OFF	ANT SW	MENU	↑
+10	0	ENTER	RECALL	P IN P	◀	↓
						▶
						EXECUTE

## LCD Touch Key Display Table (continued)

### VCR 1

RESET		VCR1					POWER	
		C+C- V+ V- MU						
1	2	3	TV/VIDEO	DISPLAY	◀	▶	▶▶	
4	5	6	WIDE	SLEEP	REC	■	⏸	
7	8	9	SOUND FIELD ON/OFF	ANT SW	MENU	↑	EXECUTE	
+10	0	ENTER	CLEAR	P IN P	◀	↓	▶	

### VCR 2

RESET		VCR 2					POWER	
		C+C- V+ V- MU						
1	2	3	TV/VIDEO	DISPLAY	◀	▶	▶▶	
4	5	6	WIDE	SLEEP	REC	■	⏸	
7	8	9	SOUND FIELD ON/OFF	ANT SW	MENU	↑	EXECUTE	
+10	0	ENTER	CLEAR	P IN P	◀	↓	▶	

### VCR 3

RESET		VCR 3					POWER	
		C+C- V+ V- MU						
1	2	3	TV/VIDEO	DISPLAY	◀	▶	▶▶	
4	5	6	WIDE	SLEEP	REC	■	⏸	
7	8	9	SOUND FIELD ON/OFF	ANT SW	MENU	↑	EXECUTE	
+10	0	ENTER	CLEAR	P IN P	◀	↓	▶	

## DVD

RESET			DVD					POWER
			C+C- V+ V- MU					
1	2	3	AUDIO	DISPLAY	◀	▶	▶▶	
4	5	6	SUBTITLE	SUBTITLE ON/OFF	ANGLE	■	⏸	
7	8	9	TITLE	DVD MENU	MENU	▲	EXECUTE	
	0	ENTER	CLEAR	RETURN	◀	▼	▶	

## VD (LD player)

RESET			VD					POWER
			C+C- V+ V- MU					
1	2	3	D.SKIP	DISPLAY	◀	▶	▶▶	
4	5	6	WIDE	SLEEP	ANGLE	■	⏸	
7	8	9	SOUND FIELD ON/OFF	GENRE	MODE	PGM	EXECUTE	
+10	0	ENTER	CLEAR	P IN P	SHUFFLE	CONTINUE	REPEAT	

## LCD Touch Key Display Table (continued)

### DBS

RESET	C+C- V+ V- MU				DBS				POWER
1	2	3	AUDIO	DISPLAY	INPUT SELECT	GUIDE	FAVORITE		
4	5	6	WIDE	SLEEP	ANGLE	TUNER	TV/DBS		
7	8	9	TITLE	ANT SW	MENU	↑	EXECUTE		
+10	0	ENTER	RECALL	P IN P	←	↓	→		

### CBL (cable box)

RESET	C+C- V+ V- MU				CBL				POWER
1	2	3	TV/VIDEO	DISPLAY	◀◀	▶▶	▶▶		
4	5	6	WIDE	SLEEP	REC	■	⏸		
7	8	9	TITLE	ANT SW	MENU	↑	EXECUTE		
+10	0	ENTER	RECALL	P IN P	←	↓	→		

### AMP

RESET	C+C- V+ V- MU				AMP				POWER
1	2	3	VIDEO1	VIDEO2	VIDEO3	VDP	TV		
4	5	6	TAPE	DAT/MD	CD	TUNER	PHONO		
7	8	9	SOUND FIELD ON/OFF	GENRE	MODE	↑	EXECUTE		
+10	0	ENTER	T.TONE	SHIFT	←	↓	→		

# CD

RESET	C+C- V+ V- MU			CD				POWER
1	2	3	D.SKIP	DISPLAY	◀	▶	▶▶	
4	5	6	SUBTITLE	SLEEP	ANGLE	■		
7	8	9	SOUND FIELD ON/OFF	GENRE	MODE	PGM	EXECUTE	
+10	0	ENTER	CLEAR	RETURN	SHUFFLE	CONTINUE	REPEAT	

# MD

RESET	C+C- V+ V- MU			MD				POWER
1	2	3	D.SKIP	DISPLAY	◀	▶	▶▶	
4	5	6	TAPE	DAT/MD	REC	■		
7	8	9	SOUND FIELD ON/OFF	GENRE	MODE	PGM	○	
+10	0	ENTER	CLEAR	RETURN	SHUFFLE	CONTINUE	REPEAT	

# DAT

RESET	C+C- V+ V- MU			MD				POWER
1	2	3	D.SKIP	DISPLAY	◀	▶	▶▶	
4	5	6	TAPE	DAT/MD	REC	■		
7	8	9	SOUND FIELD ON/OFF	GENRE	MODE	PGM	○	
+10	0	ENTER	CLEAR	RETURN	SHUFFLE	CONTINUE	REPEAT	

## LCD Touch Key Display Table (continued)

### DECK A

RESET	C+C- V+ V- MU			DECK		A	POWER
1	2	3	D.SKIP	◀	◀▶	▶	▶▶
4	5	6	TAPE	SLEEP	REC	■	⏸
7	8	9	SOUND FIELD ON/OFF	GENRE	MODE	▲	○
+10	0	ENTER	CLEAR	RETURN	◀	▼	▶

### DECK B

RESET	C+C- V+ V- MU			DECK		B	POWER
1	2	3	D.SKIP	◀	◀▶	▶	▶▶
4	5	6	TAPE	SLEEP	REC	■	⏸
7	8	9	SOUND FIELD ON/OFF	GENRE	MODE	▲	○
+10	0	ENTER	CLEAR	RETURN	◀	▼	▶



## TUNER

RESET	C+C- V+ V- MU					TUNER		POWER
1	2	3	AUDIO	DISPLAY	◀	▶	FAVORITE	
4	5	6	WIDE	SLEEP	ANGLE	TUNER	PHONO	
7	8	9	SOUND FIELD ON/OFF	ANT SW	MENU	↑	EXECUTE	
+10	0	ENTER	BAND	SHIFT	◀	↓	▶	

## Digital Surround Processor (DSP)

RESET	C+C- V+ V- MU					TUNER		POWER
1	2	3	AUDIO	DISPLAY	INPUT SELECT	◀	▶	TV
4	5	6	TAPE	DAT/MD	CD	TUNER	PHONO	
7	8	9	SOUND FIELD ON/OFF	GENRE	MODE	↑	EXECUTE	
+10	0	ENTER	T.TONE	SHIFT	◀	↓	▶	

## LCD Touch Key Display Table (continued)

### Full display

You can use the following tables as a memorandum for the OPTION button or for any component.

RESET OFF	LEARNING C+C- V+ V- SC1 SC2 SC3 MU			TV VCR123	DVD DBS TUNER	AMP MD DECK CBL CD AB OP	POWER ON OFF
1	2	3	TV/VIDEO D.SKIP AUDIO VIDEO1	DISPLAY ◀◀ VIDEO2	INPUT SELECT ◀◀▶▶ VIDEO3	GUIDE ▶▶ VDP	FAVORITE ▶▶ TV
4	5	6	WIDE SUBTITLE TAPE	SLEEP SUBTITLE ON/OFF DAT/MD	ANGLE REC CD	TUNER	TV/DBS    PHONO
7	8	9	TITLE SOUND FIELD ON/OFF	DVD MENU ANT SW GENRE	MENU MODE	PGM ↑	EXECUTE
+10	0	ENTER	T.TONE RECALL CLEAR BAND	RETURN P IN P SHIFT	◀◀ SHUFFLE	CONTINUE ↓	▶▶ REPEAT

RESET OFF	LEARNING C+C- V+ V- SC1 SC2 SC3 MU			TV VCR123	DVD DBS TUNER	AMP MD DECK CBL CD AB OP	POWER ON OFF
1	2	3	TV/VIDEO D.SKIP AUDIO VIDEO1	DISPLAY ◀◀ VIDEO2	INPUT SELECT ◀◀▶▶ VIDEO3	GUIDE ▶▶ VDP	FAVORITE ▶▶ TV
4	5	6	WIDE SUBTITLE TAPE	SLEEP SUBTITLE ON/OFF DAT/MD	ANGLE REC CD	TUNER	TV/DBS    PHONO
7	8	9	TITLE SOUND FIELD ON/OFF	DVD MENU ANT SW GENRE	MENU MODE	PGM ↑	EXECUTE
+10	0	ENTER	T.TONE RECALL CLEAR BAND	RETURN P IN P SHIFT	◀◀ SHUFFLE	CONTINUE ↓	▶▶ REPEAT

RESET OFF	LEARNING C+C- V+ V- SC1 SC2 SC3 MU			TV VCR123	DVD DBS TUNER	AMP MD DECK CBL CD AB OP	POWER ON OFF
1	2	3	TV/VIDEO D.SKIP AUDIO VIDEO1	DISPLAY ◀◀ VIDEO2	INPUT SELECT ◀◀▶▶ VIDEO3	GUIDE ▶▶ VDP	FAVORITE ▶▶ TV
4	5	6	WIDE SUBTITLE TAPE	SLEEP SUBTITLE ON/OFF DAT/MD	ANGLE REC CD	TUNER	TV/DBS    PHONO
7	8	9	TITLE SOUND FIELD ON/OFF	DVD MENU ANT SW GENRE	MENU MODE	PGM ↑	EXECUTE
+10	0	ENTER	T.TONE RECALL CLEAR BAND	RETURN P IN P SHIFT	◀◀ SHUFFLE	CONTINUE ↓	▶▶ REPEAT

# Quick Reference of Operations

To	Press	For details, see
Set a component code	<b>COMMANDER OFF</b> + <b>MUTING</b>	page 8
Program to the keys or buttons on a component (learning function)	<b>COMMANDER OFF</b> + <b>Component Select</b>	page 13
Assign a component to the <b>OPTION</b> button	<b>COMMANDER OFF</b> + <b>OPTION</b>	page 17
Assign other components to the <b>Component Select</b> buttons	<b>Component Select</b> + <b>Component Select</b>	page 27
Change the volume control setting	<b>COMMANDER OFF</b> + <b>VOL+</b> + <b>VOL-</b>	page 18
Program the <b>System Control</b> function	<b>COMMANDER OFF</b> + <b>SYSTEM CONTROL (1, 2, 3)</b>	page 20
Set the <b>System Power-Off</b> function	<b>COMMANDER OFF</b> + <b>CH-</b> + <b>VOL+</b>	page 26
Program the <b>Power-on</b> command to the <b>Component Select</b> buttons	<b>COMMANDER OFF</b> + <b>VOL-</b> + <b>Component Select</b>	page 24
Program a command to the <b>SYSTEM CONTROL</b> buttons or <b>Component Select</b> buttons	<b>COMMANDER OFF</b> + <b>CH+</b> + <b>VOL+</b>	page 25, 29
Set the <b>Auto Power-Off</b> time	<b>COMMANDER OFF</b> + <b>CH+</b> + <b>VOL-</b>	page 32
Set the <b>Auto-Off</b> time/brightness of the <b>Backlight</b>	<b>COMMANDER OFF</b> + <b>LIGHT</b>	page 33
Lock the <b>Remote Commander</b>	<b>♪</b> + <b>COMMANDER OFF</b>	page 30
Select the input select of a TV directly	<b>TV/VIDEO</b> + <b>0 - 6 keys</b>	page 12
Start recording	<b>REC</b> + <b>▶</b>	page 12

# Index

## A

- Assigning other components
  - to Component Select buttons 27
  - to OPTION button 17
- Auto Power-Off
  - of the Commander 32
  - of the backlight 33

## B

- Backlight
  - batteries 6
  - adjusting 33
- Batteries 6

## C

- CHANNEL button 7
- Clearing/Changing
  - a learned signal 16, 26, 30
  - System Control function 23
- Code number 8
- Component Select buttons
  - to add an extra function 24
  - to assign other components 27
- COMMANDER OFF button 7

## E

- Erasing
  - See "Clearing/Changing"

## H, I, J

- Hold Function 30

## L

- LCD
  - auto-off time 33
  - brightness 33
  - touch keys 43
- Learning Function 13
- LIGHT button 7, 33
- Locking the controls 30

## M

- MUTING button 7, 19

## O

- OPTION button 17

## P, Q, R

- Power-On command
  - System Control Function 20
  - Adding to the Component Select button 24
- Power-off command
  - See "System Power-Off function" 20
- Preset components 8
- Preset Lock Function 31

## S

- SYSTEM CONTROL buttons
  - System Control Function 20
  - Programming a frequently used command 29
- System Power-Off function 20

## T, U

- Troubleshooting 35

## V, W, X, Y, Z

- VOLUME buttons 7, 18
- Volume Control 7, 18

## Free Manuals Download Website

<http://myh66.com>

<http://usermanuals.us>

<http://www.somanuals.com>

<http://www.4manuals.cc>

<http://www.manual-lib.com>

<http://www.404manual.com>

<http://www.luxmanual.com>

<http://aubethermostatmanual.com>

Golf course search by state

<http://golfingnear.com>

Email search by domain

<http://emailbydomain.com>

Auto manuals search

<http://auto.somanuals.com>

TV manuals search

<http://tv.somanuals.com>