

- ▶ Operation Search
- ▶ Before Use
- ▶ Shooting
- ▶ Viewing
- ▶ Using MENU items (Shooting)
- ▶ Using MENU items (Viewing)
- ▶ Changing settings
- ▶ Viewing images on a TV
- ▶ Using with your computer
- ▶ Printing
- ▶ Troubleshooting
- ▶ Precautions / About this camera

[→ Contents list](#)

DSC-W510 User Guide

Use this manual if you encounter any problems, or have any questions about the camera.



Cyber-shot

[▲ Back to top](#)

Copyright 2011 Sony Corporation

- ▶ Operation Search
- ▶ Before Use
- ▶ Shooting
- ▶ Viewing
- ▶ Using MENU items (Shooting)
- ▶ Using MENU items (Viewing)
- ▶ Changing settings
- ▶ Viewing images on a TV
- ▶ Using with your computer
- ▶ Printing
- ▶ Troubleshooting
- ▶ Precautions / About this camera

[→ Contents list](#)

Operation Search

Operation Search

[Search by Operation](#)

[▲ Back to top](#)

- ▶ Operation Search
- ▶ **Before Use**
- ▶ Shooting
- ▶ Viewing
- ▶ Using MENU items (Shooting)
- ▶ Using MENU items (Viewing)
- ▶ Changing settings
- ▶ Viewing images on a TV
- ▶ Using with your computer
- ▶ Printing
- ▶ Troubleshooting
- ▶ Precautions / About this camera

[→ Contents list](#)

Before Use

How to use this User Guide

[How to use this User Guide](#)

[The images used in this User Guide](#)

Names of parts and list of icons displayed on the screen

[Names of parts](#)

[List of icons displayed on the screen](#)

Using the wrist strap

[Using the wrist strap](#)

Using the internal memory

[Using the internal memory](#)

[▲ Back to top](#)

▶ Operation Search
▶ Before Use
▶ Shooting
▶ Viewing
▶ Using MENU items (Shooting)
▶ Using MENU items (Viewing)
▶ Changing settings
▶ Viewing images on a TV
▶ Using with your computer
▶ Printing
▶ Troubleshooting
▶ Precautions / About this camera

[→ Contents list](#)

Shooting

Shooting still images

[Shooting still images](#)

[Zoom](#)

Shooting movies

[Shooting movies](#)

Setting REC mode

[List of mode switch functions](#)

[Intelligent Auto](#)

[Program Auto](#)

[Scene Selection](#)

[SteadyShot](#)

[Sweep Panorama](#)

[Movie Mode](#)

[Functions not available in some REC modes](#)

Using shooting functions

[DISP \(Screen Display Settings\)](#)

[Flash](#)

[Smile Shutter](#)

[Self-Timer](#)

[▲ Back to top](#)

Viewing

Viewing still images

[Viewing still images](#)

[Playback zoom](#)

[Image Index](#)

Deleting images

[Delete button](#)

Viewing movies

[Viewing movies](#)

Viewing panorama images

[Scrolling the panorama images for display](#)

[▲ Back to top](#)

- ▶ Operation Search
- ▶ Before Use
- ▶ Shooting
- ▶ Viewing
- ▶ Using MENU items (Shooting)
- ▶ Using MENU items (Viewing)
- ▶ Changing settings
- ▶ Viewing images on a TV
- ▶ Using with your computer
- ▶ Printing
- ▶ Troubleshooting
- ▶ Precautions / About this camera

[→ Contents list](#)

Copyright 2011 Sony Corporation

▶ Operation Search
▶ Before Use
▶ Shooting
▶ Viewing
▶ Using MENU items (Shooting)
▶ Using MENU items (Viewing)
▶ Changing settings
▶ Viewing images on a TV
▶ Using with your computer
▶ Printing
▶ Troubleshooting
▶ Precautions / About this camera

[→ Contents list](#)

Using MENU items (Shooting)

Using MENU items (Shooting)

[Using MENU items \(Shooting\)](#)

MENU items (Shooting)

[REC Mode](#)

[Scene Selection](#)

[Easy Mode](#)

[Shooting Direction](#)

[Image Size](#)

[Burst Settings](#)

[EV](#)

[ISO](#)

[White Balance](#)

[Focus](#)

[Metering Mode](#)

[Scene Recognition](#)

[Smile Detection Sensitivity](#)

[Face Detection](#)

[DRO](#)

Shooting MENU list

[MENU items not available in some REC modes](#)

[▲ Back to top](#)

▶ Operation Search
▶ Before Use
▶ Shooting
▶ Viewing
▶ Using MENU items (Shooting)
▶ Using MENU items (Viewing)
▶ Changing settings
▶ Viewing images on a TV
▶ Using with your computer
▶ Printing
▶ Troubleshooting
▶ Precautions / About this camera

[→ Contents list](#)

Using MENU items (Viewing)

Using MENU items (Viewing)

[Using MENU items \(Viewing\)](#)

MENU items (Viewing)

[Easy Mode](#)

[Slideshow](#)

[Retouch](#)

[Delete](#)

[Protect](#)

[DPOF](#)

[Rotate](#)

[Select Folder](#)

Playback MENU list

[MENU items that cannot be set according to recording media](#)

[▲ Back to top](#)

Copyright 2011 Sony Corporation

- ▶ Operation Search
- ▶ Before Use
- ▶ Shooting
- ▶ Viewing
- ▶ Using MENU items (Shooting)
- ▶ Using MENU items (Viewing)
- ▶ Changing settings
- ▶ Viewing images on a TV
- ▶ Using with your computer
- ▶ Printing
- ▶ Troubleshooting
- ▶ Precautions / About this camera

[→ Contents list](#)

Changing settings

Changing settings

[Changing camera settings](#)

Shooting Settings

[Grid Line](#)

[Disp. Resolution](#)

[Digital Zoom](#)

[Red Eye Reduction](#)

Main Settings

[Beep](#)

[Language Setting](#)

[Function Guide](#)

[Display color](#)

[Power Save](#)

[Initialize](#)

[Video Out](#)

[USB Connect](#)

[LUN Setting](#)

Memory Card Tool / Internal Memory Tool

[Format](#)

[Create REC. Folder](#)

[Change REC. Folder](#)

[Delete REC. Folder](#)

[Copy](#)

[File Number](#)

Clock Settings

[Area Setting](#)

[Date & Time Setting](#)

[▲ Back to top](#)

Viewing images on a TV

Viewing an image on a Standard Definition (SD) TV

[Viewing an image on a Standard Definition \(SD\) TV](#)

[▲ Back to top](#)

- ▶ Operation Search
- ▶ Before Use
- ▶ Shooting
- ▶ Viewing
- ▶ Using MENU items (Shooting)
- ▶ Using MENU items (Viewing)
- ▶ Changing settings
- ▶ Viewing images on a TV
- ▶ Using with your computer
- ▶ Printing
- ▶ Troubleshooting
- ▶ Precautions / About this camera

[→ Contents list](#)

Copyright 2011 Sony Corporation

▶ Operation Search
▶ Before Use
▶ Shooting
▶ Viewing
▶ Using MENU items (Shooting)
▶ Using MENU items (Viewing)
▶ Changing settings
▶ Viewing images on a TV
▶ Using with your computer
▶ Printing
▶ Troubleshooting
▶ Precautions / About this camera

[→ Contents list](#)

Using with your computer

Recommended computer environment

[Recommended computer environment \(Windows\)](#)

[Recommended computer environment \(Macintosh\)](#)

Using the software

[“PMB \(Picture Motion Browser\)”](#)

[Installing “PMB” \(Windows\)](#)

Connecting the camera to the computer

[Connecting the camera to the computer](#)

[Importing images to a computer \(Windows\)](#)

[Importing images to a computer \(Macintosh\)](#)

[Deleting the USB connection](#)

Uploading images to a media service

[“PMB Portable”](#)

[Starting up “PMB Portable” \(Windows\)](#)

[Starting up “PMB Portable” \(Macintosh\)](#)

[▲ Back to top](#)

Printing

Printing still images

[Printing still images](#)

[Printing at a shop](#)

[▲ Back to top](#)

- ▶ Operation Search
- ▶ Before Use
- ▶ Shooting
- ▶ Viewing
- ▶ Using MENU items (Shooting)
- ▶ Using MENU items (Viewing)
- ▶ Changing settings
- ▶ Viewing images on a TV
- ▶ Using with your computer
- ▶ **Printing**
- ▶ Troubleshooting
- ▶ Precautions / About this camera

[→ Contents list](#)

Copyright 2011 Sony Corporation

- ▶ Operation Search
- ▶ Before Use
- ▶ Shooting
- ▶ Viewing
- ▶ Using MENU items (Shooting)
- ▶ Using MENU items (Viewing)
- ▶ Changing settings
- ▶ Viewing images on a TV
- ▶ Using with your computer
- ▶ Printing
- ▶ Troubleshooting
- ▶ Precautions / About this camera

[→ Contents list](#)

Troubleshooting

If you have problems

[If you have problems](#)

Troubleshooting

[Battery pack and power](#)

[Shooting still images / movies](#)

[Viewing images](#)

[Deleting](#)

[Computers](#)

[Memory card](#)

[Internal memory](#)

[Printing](#)

[Others](#)

Warning indicators and messages

[Messages](#)

[▲ Back to top](#)

▶ Operation Search
▶ Before Use
▶ Shooting
▶ Viewing
▶ Using MENU items (Shooting)
▶ Using MENU items (Viewing)
▶ Changing settings
▶ Viewing images on a TV
▶ Using with your computer
▶ Printing
▶ Troubleshooting
▶ Precautions / About this camera

[→ Contents list](#)

Precautions / About this camera

Precautions

[Precautions](#)

[On the internal rechargeable backup battery](#)

[Battery pack](#)

[Battery charger](#)

[Memory card](#)

On cleaning

[On cleaning](#)

Number of still images and recordable time of movies

[Number of still images](#)

[Recordable time of movies](#)

Using the camera abroad

[Using the camera abroad](#)

[On TV color systems](#)

About this camera

[License](#)

Trademarks

[Trademarks](#)

[▲ Back to top](#)

▶ Operation Search
▶ Before Use
▶ Shooting
▶ Viewing
▶ Using MENU items (Shooting)
▶ Using MENU items (Viewing)
▶ Changing settings
▶ Viewing images on a TV
▶ Using with your computer
▶ Printing
▶ Troubleshooting
▶ Precautions / About this camera

[→ Contents list](#)

Contents list

Operation Search

Operation Search

[Search by Operation](#)

[▲ Back to top](#)

Before Use

How to use this User Guide

[How to use this User Guide](#)

[The images used in this User Guide](#)

Names of parts and list of icons displayed on the screen

[Names of parts](#)

[List of icons displayed on the screen](#)

Using the wrist strap

[Using the wrist strap](#)

Using the internal memory

[Using the internal memory](#)

[▲ Back to top](#)

Shooting

Shooting still images

[Shooting still images](#)

[Zoom](#)

Shooting movies

[Shooting movies](#)

Setting REC mode

[List of mode switch functions](#)

[Intelligent Auto](#)

[Program Auto](#)

[Scene Selection](#)

[SteadyShot](#)

[Sweep Panorama](#)

[Movie Mode](#)

[Functions not available in some REC modes](#)

Using shooting functions

[DISP \(Screen Display Settings\)](#)

[Flash](#)

Viewing

Viewing still images

[Viewing still images](#)

[Playback zoom](#)

[Image Index](#)

Deleting images

[Delete button](#)

Viewing movies

[Viewing movies](#)

Viewing panorama images

[Scrolling the panorama images for display](#)

Using MENU items (Shooting)

Using MENU items (Shooting)

[Using MENU items \(Shooting\)](#)

MENU items (Shooting)

[REC Mode](#)

[Scene Selection](#)

[Easy Mode](#)

[Shooting Direction](#)

[Image Size](#)

[Burst Settings](#)

[EV](#)

[ISO](#)

[White Balance](#)

[Focus](#)

[Metering Mode](#)

[Scene Recognition](#)

[Smile Detection Sensitivity](#)

[Face Detection](#)

[DRO](#)

Shooting MENU list

[MENU items not available in some REC modes](#)

Using MENU items (Viewing)

Using MENU items (Viewing)

[Using MENU items \(Viewing\)](#)

MENU items (Viewing)

[Easy Mode](#)

- Slideshow
- Retouch
- Delete
- Protect
- DPOF
- Rotate
- Select Folder

Playback MENU list

MENU items that cannot be set according to recording media

[▲ Back to top](#)

Changing settings

Changing settings

[Changing camera settings](#)

Shooting Settings

[Grid Line](#)

[Disp. Resolution](#)

[Digital Zoom](#)

[Red Eye Reduction](#)

Main Settings

[Beep](#)

[Language Setting](#)

[Function Guide](#)

[Display color](#)

[Power Save](#)

[Initialize](#)

[Video Out](#)

[USB Connect](#)

[LUN Setting](#)

Memory Card Tool / Internal Memory Tool

[Format](#)

[Create REC. Folder](#)

[Change REC. Folder](#)

[Delete REC. Folder](#)

[Copy](#)

[File Number](#)

Clock Settings

[Area Setting](#)

[Date & Time Setting](#)

[▲ Back to top](#)

Viewing images on a TV

Viewing an image on a Standard Definition (SD) TV

[Viewing an image on a Standard Definition \(SD\) TV](#)

[▲ Back to top](#)

Using with your computer

Recommended computer environment

[Recommended computer environment \(Windows\)](#)

[Recommended computer environment \(Macintosh\)](#)

Using the software

[“PMB \(Picture Motion Browser\)”](#)

[Installing “PMB” \(Windows\)](#)

Connecting the camera to the computer

[Connecting the camera to the computer](#)

[Importing images to a computer \(Windows\)](#)

[Importing images to a computer \(Macintosh\)](#)

[Deleting the USB connection](#)

Uploading images to a media service

[“PMB Portable”](#)

[Starting up “PMB Portable” \(Windows\)](#)

[Starting up “PMB Portable” \(Macintosh\)](#)

[▲ Back to top](#)

Printing

Printing still images

[Printing still images](#)

[Printing at a shop](#)

[▲ Back to top](#)

Troubleshooting

If you have problems

[If you have problems](#)

Troubleshooting

[Battery pack and power](#)

[Shooting still images / movies](#)

[Viewing images](#)

[Deleting](#)

[Computers](#)

[Memory card](#)

[Internal memory](#)

[Printing](#)

[Others](#)

Warning indicators and messages

[Messages](#)

[▲ Back to top](#)

Precautions / About this camera

Precautions

[Precautions](#)

[On the internal rechargeable backup battery](#)

[Battery pack](#)

[Battery charger](#)

[Memory card](#)

On cleaning

[On cleaning](#)

Number of still images and recordable time of movies

[Number of still images](#)

[Recordable time of movies](#)

Using the camera abroad

[Using the camera abroad](#)

[On TV color systems](#)

About this camera

[License](#)

Trademarks

[Trademarks](#)

[▲ Back to top](#)

Copyright 2011 Sony Corporation

▶ Operation Search
▶ Before Use
▶ Shooting
▶ Viewing
▶ Using MENU items (Shooting)
▶ Using MENU items (Viewing)
▶ Changing settings
▶ Viewing images on a TV
▶ Using with your computer
▶ Printing
▶ Troubleshooting
▶ Precautions / About this camera

[→ Contents list](#)

Search by Operation

Leaving the settings to the camera

[Intelligent Auto](#)
[Scene Selection](#)
[Scene Recognition](#)

Shooting portraits

[Scene Selection\(Soft Snap\)](#)
[Scene Selection\(Twilight Portrait\)](#)
[Smile Shutter](#)
[Scene Recognition](#)
[Face Detection](#)
[Red Eye Reduction](#)

Shooting panoramic images

[Sweep Panorama](#)

Shooting moving objects

[Movie Mode](#)
[Burst Settings](#)

Shooting without blur

[SteadyShot](#)
[Scene Selection\(High Sensitivity\)](#)
[Self-Timer\(2sec\)](#)
[ISO](#)

Shooting with backlight

[Flash](#)
[Scene Recognition](#)
[DRO](#)

Shooting in dark places

[Scene Selection\(High Sensitivity\)](#)
[Flash\(Slow Synchro\)](#)
[ISO](#)

Changing focus position

[Focus](#)
[Face Detection](#)

Changing image size

[Image Size](#)

Changing screen display

[DISP \(Screen Display Settings\)](#)
[Function Guide](#)
[Display color](#)

Deleting images

- Delete
- Delete button
- Format

Displaying enlarged images

- Playback zoom
- Retouch(Trimming (Resize))

Editing images

- Retouch

Playing back a series of images in order

- Slideshow

Printing images with the date

- "PMB (Picture Motion Browser)"

Changing clock settings

- Date & Time Setting

Initializing settings

- Initialize

Printing images

- Printing still images

Viewing on TVs

- Viewing an image on a Standard Definition (SD) TV

[▲ Back to top](#)

Copyright 2011 Sony Corporation

- ▶ Operation Search
- ▶ **Before Use**
- ▶ Shooting
- ▶ Viewing
- ▶ Using MENU items (Shooting)
- ▶ Using MENU items (Viewing)
- ▶ Changing settings
- ▶ Viewing images on a TV
- ▶ Using with your computer
- ▶ Printing
- ▶ Troubleshooting
- ▶ Precautions / About this camera

➔ Contents list

How to use this User Guide

- ▼ [Selecting a topic to display](#)
- ▼ [Returning to a previous page](#)
- ▼ [Printing out a page](#)
- ▼ [Marks and notations used in this User Guide](#)

This User Guide explains how to use each function of the camera, how to change settings, and how to troubleshoot a problem.

Selecting a topic to display

The following illustrations take Internet Explorer 7 as an example.

1. Click a title in the side bar on the left of the browser window.
The title's topic list appears in the right pane.
2. Click a topic title in the list.

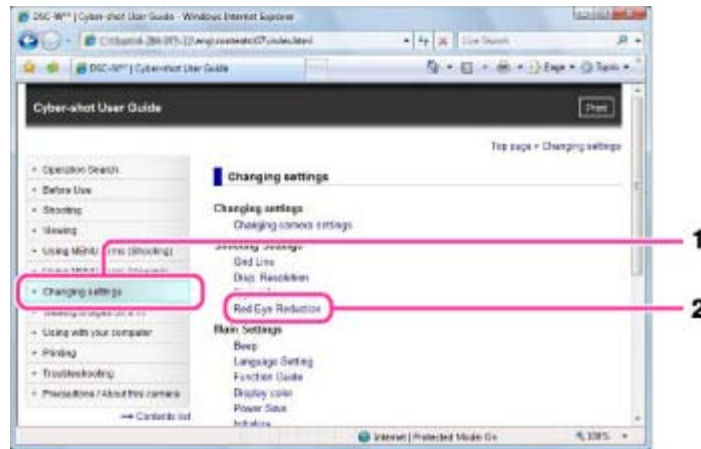

Descriptions appear in the right pane.

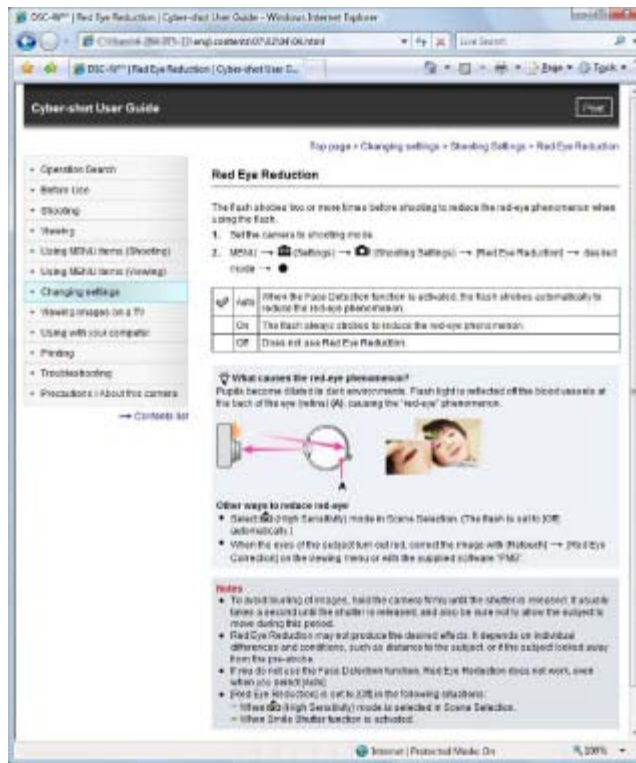

Changing the font size

Change the font size by changing the setting of your web browser. For how to change the font size setting, refer to the Help of your web browser.

Returning to a previous page

Use the back button of your web browser or the breadcrumb trail navigation to return to a page you previously viewed.

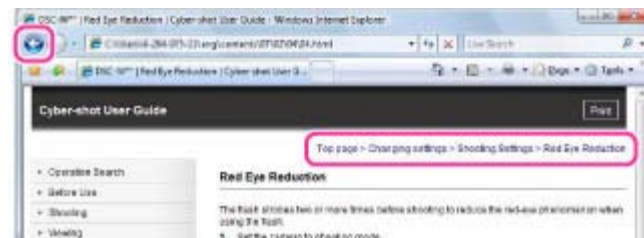

Printing out a page

Click the [Print] button to print out a page you are viewing.

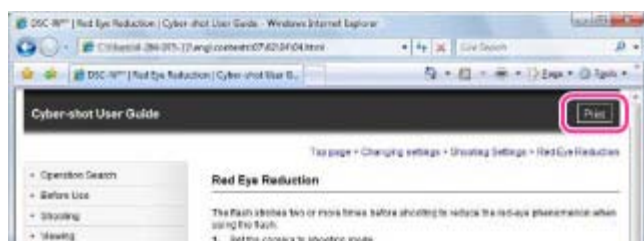

Marks and notations used in this User Guide

In this User Guide, the sequence of operations is shown by arrows (→) (A). Operate the camera in the order indicated.



- Icons in the operating procedure sentences appear when the camera is in its default settings.
- The default setting is indicated by ✓.
- 💡 indicates information that is useful to know.

[▲ Back to top](#)

Copyright 2011 Sony Corporation

[Top page](#) > [Before Use](#) > [How to use this User Guide](#) > [The images used in this User Guide](#)

The images used in this User Guide

Images used in this User Guide

- The images used as examples in this User Guide are reproduced images, and are not actual images shot using this camera.

[▲ Back to top](#)

▶ Operation Search
▶ Before Use
▶ Shooting
▶ Viewing
▶ Using MENU items (Shooting)
▶ Using MENU items (Viewing)
▶ Changing settings
▶ Viewing images on a TV
▶ Using with your computer
▶ Printing
▶ Troubleshooting
▶ Precautions / About this camera

[→ Contents list](#)

Copyright 2011 Sony Corporation

- ▶ Operation Search
- ▶ Before Use
- ▶ Shooting
- ▶ Viewing
- ▶ Using MENU items (Shooting)
- ▶ Using MENU items (Viewing)
- ▶ Changing settings
- ▶ Viewing images on a TV
- ▶ Using with your computer
- ▶ Printing
- ▶ Troubleshooting
- ▶ Precautions / About this camera

[→ Contents list](#)

Names of parts

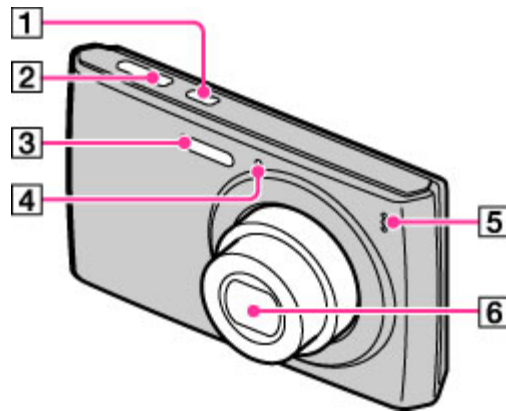

- 1** ON/OFF (Power) button
- 2** Shutter button
- 3** Flash
- 4** Self-timer lamp / Smile Shutter lamp
- 5** Microphone
- 6** Lens

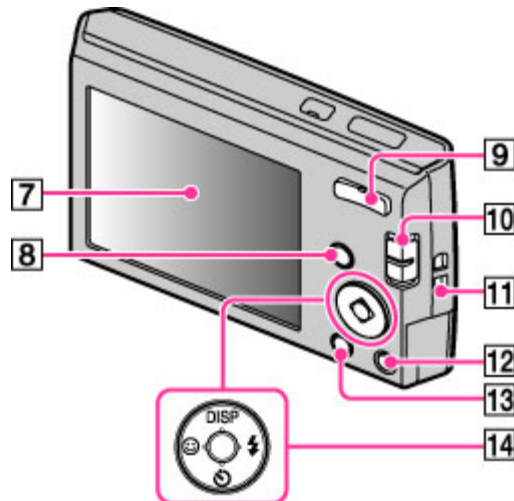

- 7** LCD screen
- 8** ▶ (Playback) button
- 9** For shooting: W/T (zoom) button
For viewing: (Playback zoom) button / (Index) button
- 10**

Mode switch

11 Hook for wrist strap

12  (Delete) button

13 MENU button

14 Control button

Menu on: ▲ / ▼ / ◀ / ▶ / ●

Menu off: **DISP** /  /  / 

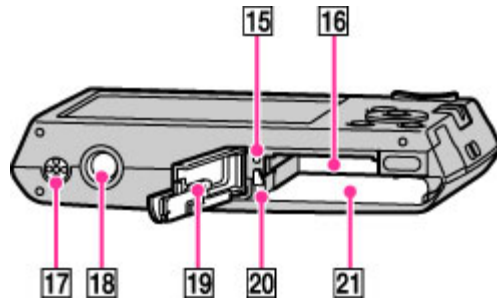

15 Access lamp

16 Memory card slot

17 Speaker

18 Tripod receptacle

19 Battery / Memory card cover

20 Battery eject lever

21 Battery insertion slot

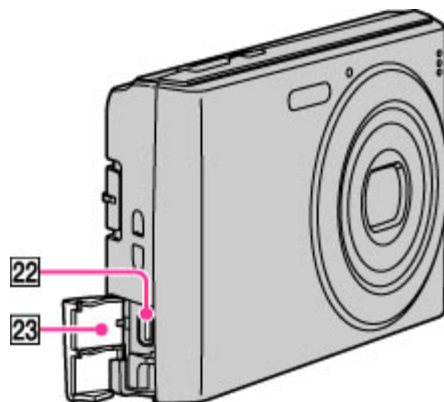

22  (USB) / AV OUT jack

23 Terminal cover

[▲ Back to top](#)

Copyright 2011 Sony Corporation

Top page > Before Use > Names of parts and list of icons displayed on the screen > List of icons displayed on the screen

- ▶ Operation Search
- ▶ Before Use
- ▶ Shooting
- ▶ Viewing
- ▶ Using MENU items (Shooting)
- ▶ Using MENU items (Viewing)
- ▶ Changing settings
- ▶ Viewing images on a TV
- ▶ Using with your computer
- ▶ Printing
- ▶ Troubleshooting
- ▶ Precautions / About this camera

[→ Contents list](#)

List of icons displayed on the screen

▼ List of shooting mode icons

▼ List of viewing mode icons

Icons are displayed on the screen to indicate the camera status.

You can change the screen display using DISP (Screen Display Settings) on the control button.

List of shooting mode icons

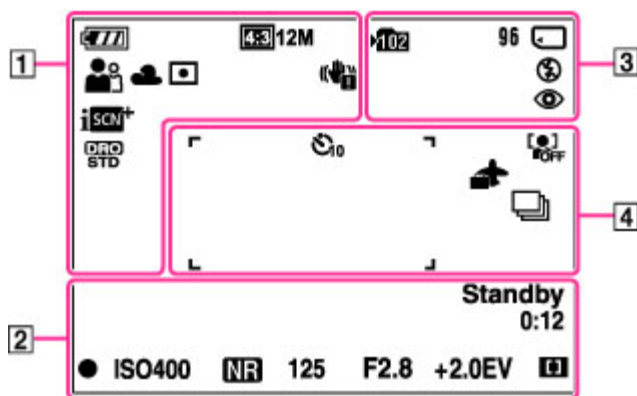



1

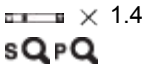



Display	Indication
	Battery remaining
	Low battery warning
	Image size
	Scene Selection
	Shooting mode (Intelligent Auto, Program Auto, SteadyShot, Sweep Panorama, Movie Mode)
	Scene Recognition icon
	White balance
	Metering Mode
	Vibration warning
	Scene Recognition
	DRO

	Smile Detection Sensitivity indicator
	Zoom scaling





2

Display	Indication
	AE/AF lock
ISO400	ISO number
	NR slow shutter
125	Shutter speed
F2.8	Aperture value
+2.0EV	Exposure value
	AF range finder frame indicator
REC Standby	Recording a movie / Movie standby
0:12	Recording time (m:s)

3

Display	Indication
	Recording folder
96	Number of recordable images
100Min	Recordable time
	Recording Media (Memory card, internal memory)
	Flash mode
	Red-eye reduction
	Flash charging

4

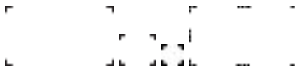

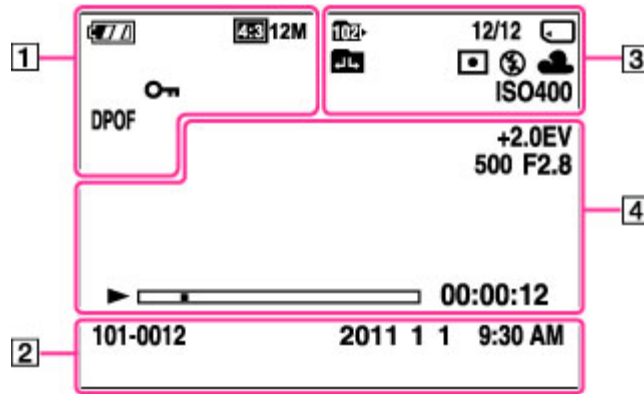

Display	Indication
	Self-timer
	Face detection
	Destination
	Burst Settings
	AF range finder frame

 Spot metering cross-hairs

List of viewing mode icons









1

Display	Indication
	Battery remaining
	Low battery warning
	Image size
	Protect
DPOF	Print order (DPOF)
	Playback zoom

2



Display	Indication
101-0012	Folder-file number
2011 11 9:30 AM	Recorded date/time of the playback image

3

Display	Indication
	Playback folder
12/12	Image number / Number of images recorded in selected folder
	Playback Media (Memory card, internal memory)
	Changing folder
	Metering Mode
	Flash mode
	White balance

	
ISO400	ISO number

4

Display	Indication
+2.0EV	Exposure value
500	Shutter speed
F2.8	Aperture value
	Playback
	Playback bar
00:00:12	Counter
	Volume

[▲ Back to top](#)

Copyright 2011 Sony Corporation

- ▶ Operation Search
- ▶ **Before Use**
- ▶ Shooting
- ▶ Viewing
- ▶ Using MENU items (Shooting)
- ▶ Using MENU items (Viewing)
- ▶ Changing settings
- ▶ Viewing images on a TV
- ▶ Using with your computer
- ▶ Printing
- ▶ Troubleshooting
- ▶ Precautions / About this camera

[→ Contents list](#)

Using the wrist strap

Attach the strap and place your hand through the loop to prevent the camera from damage by being dropped.

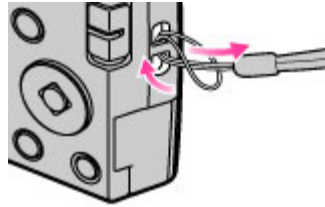
[▲ Back to top](#)

▶ Operation Search
▶ Before Use
▶ Shooting
▶ Viewing
▶ Using MENU items (Shooting)
▶ Using MENU items (Viewing)
▶ Changing settings
▶ Viewing images on a TV
▶ Using with your computer
▶ Printing
▶ Troubleshooting
▶ Precautions / About this camera

[→ Contents list](#)

Using the internal memory

The camera has approximately 6 MB of internal memory. This memory is not removable. You can record images on the internal memory when there is no memory card inserted in the camera.

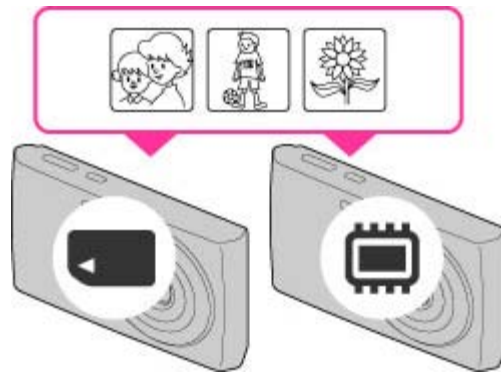

When a memory card is inserted

[Recording]: Images are recorded on the memory card.

[Playback]: Images on the memory card are played back.

[Menu, Settings, etc.]: Various functions can be performed on images on the memory card.

When there is no memory card inserted

[Recording]: Images are recorded using the internal memory.

[Playback]: Images stored in the internal memory are played back.

[Menu, Settings, etc.]: Various functions can be performed on images in the internal memory.

On image data stored in the internal memory

We recommend that you copy (back up) data using one of the following methods.

To copy (back up) data on a hard disk of your computer

Without a memory card inserted in the camera, import the images into a computer. [\[Details\]](#)
[\[Details\]](#)

To copy (back up) data on a memory card

Prepare a memory card with sufficient free capacity, then copy the images in the internal memory to the memory card. [\[Details\]](#)

Notes

- You cannot transfer image data on a memory card to the internal memory.
- By making a USB connection between the camera and a computer with the dedicated USB cable, you can transfer data stored in the internal memory to a computer. However you cannot transfer data on a computer to the internal memory.

[▲ Back to top](#)

▶ Operation Search
▶ Before Use
▶ Shooting
▶ Viewing
▶ Using MENU items (Shooting)
▶ Using MENU items (Viewing)
▶ Changing settings
▶ Viewing images on a TV
▶ Using with your computer
▶ Printing
▶ Troubleshooting
▶ Precautions / About this camera

[→ Contents list](#)

Shooting still images

1. Set the mode switch to  (Still Image), then press the ON/OFF (Power) button.

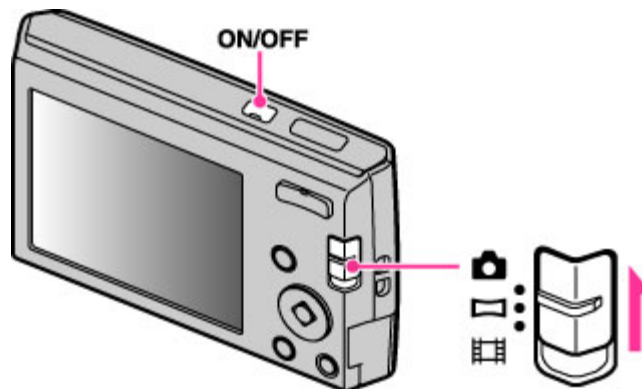

2. Hold the camera steady as illustrated.



3. Press the shutter button halfway down to focus.
When the image is in focus, a beep sounds and the ● indicator lights.

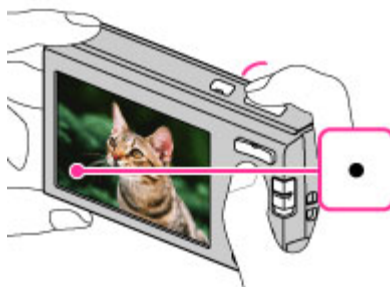

- The shortest shooting distance is approximately 4 cm (1 5/8 inches) (W), 60 cm (23 5/8 inches) (T) (from the lens).

4. Press the shutter button fully down.



 If you shoot a still image of a subject that is difficult to focus on

- When the camera cannot focus on the subject automatically, the AE/AF lock indicator changes to slowly flashing and the beep does not sound. Either recompose the shot or change the focus setting. [\[Details\]](#)
- Focusing may be difficult in the following situations:
 - It is dark and the subject is distant.
 - The contrast between the subject and the background is poor.
 - The subject is seen through glass.
 - The subject is moving quickly.
 - There is reflective light or shiny surfaces.
 - The subject is backlit or there is a flashing light.

Related Topic

[Viewing still images](#)

[Image Size](#)

[▲ Back to top](#)

Copyright 2011 Sony Corporation

▶ Operation Search
▶ Before Use
▶ Shooting
▶ Viewing
▶ Using MENU items (Shooting)
▶ Using MENU items (Viewing)
▶ Changing settings
▶ Viewing images on a TV
▶ Using with your computer
▶ Printing
▶ Troubleshooting
▶ Precautions / About this camera

[→ Contents list](#)

Zoom

You can enlarge the image when shooting. The camera's optical zoom function can enlarge images up to 4×.

1. Press the W/T (zoom) button.
Press the T button to zoom in, and the W button to zoom out.



- When the zoom scale exceeds 4×, set [Digital Zoom].

Notes

- Zoom is locked to the W side in Sweep Panorama mode.
- You cannot change the zoom scale while shooting a movie.

[▲ Back to top](#)

Copyright 2011 Sony Corporation

- ▶ Operation Search
- ▶ Before Use
- ▶ Shooting
- ▶ Viewing
- ▶ Using MENU items (Shooting)
- ▶ Using MENU items (Viewing)
- ▶ Changing settings
- ▶ Viewing images on a TV
- ▶ Using with your computer
- ▶ Printing
- ▶ Troubleshooting
- ▶ Precautions / About this camera

[→ Contents list](#)

Shooting movies

1. Set the mode switch to  (Movie), then press the ON/OFF (Power) button.

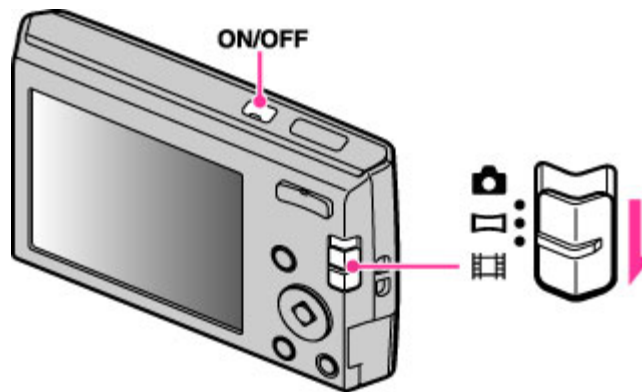

2. Press the shutter button to start recording.



3. Press the shutter button again to stop recording.

Related Topic

[Zoom](#)

[Image Size](#)

[▲ Back to top](#)

Copyright 2011 Sony Corporation



- ▶ Operation Search
- ▶ Before Use
- ▶ Shooting
- ▶ Viewing
- ▶ Using MENU items (Shooting)
- ▶ Using MENU items (Viewing)
- ▶ Changing settings
- ▶ Viewing images on a TV
- ▶ Using with your computer
- ▶ Printing
- ▶ Troubleshooting
- ▶ Precautions / About this camera

[→ Contents list](#)

List of mode switch functions

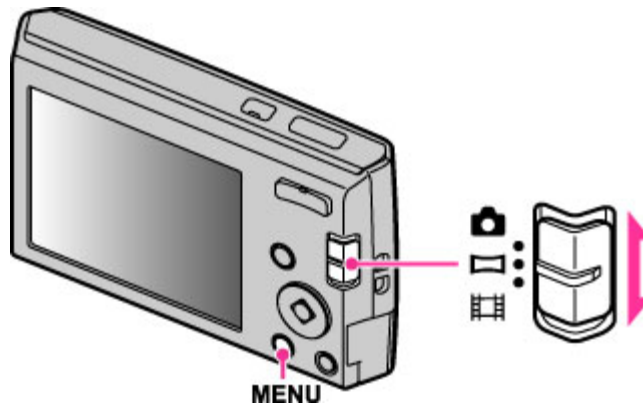
Set the mode switch to the desired function.



 (Still Image)	Allows you to shoot still images. You can set the desired still image shooting mode with MENU → [REC Mode].
 (Sweep Panorama)	Allows you to shoot a panorama image after composing images.
 (Movie)	Allows you to record movies. Press the shutter button fully down to start recording, and then press the shutter button again to end the recording.

Related Topic

- [Intelligent Auto](#)
- [Program Auto](#)
- [Scene Selection](#)
- [SteadyShot](#)
- [Sweep Panorama](#)
- [Movie Mode](#)



[▲ Back to top](#)

▶ Operation Search
▶ Before Use
▶ Shooting
▶ Viewing
▶ Using MENU items (Shooting)
▶ Using MENU items (Viewing)
▶ Changing settings
▶ Viewing images on a TV
▶ Using with your computer
▶ Printing
▶ Troubleshooting
▶ Precautions / About this camera

[→ Contents list](#)

Intelligent Auto

Allows you to shoot still images with settings adjusted automatically.

1. Set the mode switch to  (Still Image).
2. MENU →  (REC Mode) →  (Intelligent Auto) → ● on the control button
3. Shoot with the shutter button.









Note

- You may not be able to set some functions depending on the selected REC mode. For details, see “Functions not available in some REC modes” [\[Details\]](#) and “MENU items not available in some REC modes.” [\[Details\]](#)

On Scene Recognition

Scene Recognition operates in Intelligent Auto mode. This function lets the camera automatically recognize the shooting conditions and shoot the image.



When the camera recognizes  (Twilight),  (Twilight Portrait),  (Twilight using a tripod),  (Backlight),  (Backlight Portrait),  (Landscape),  (Macro) or  (Portrait), the corresponding Scene Recognition icon and guide is displayed on the LCD screen. For details, see “Scene Recognition”. [\[Details\]](#)

Related Topic

[Scene Recognition](#)

[▲ Back to top](#)



Copyright 2011 Sony Corporation

▶ Operation Search
▶ Before Use
▶ Shooting
▶ Viewing
▶ Using MENU items (Shooting)
▶ Using MENU items (Viewing)
▶ Changing settings
▶ Viewing images on a TV
▶ Using with your computer
▶ Printing
▶ Troubleshooting
▶ Precautions / About this camera

[→ Contents list](#)

Program Auto

Allows you to shoot with the exposure adjusted automatically (both the shutter speed and the aperture value). Also you can select various settings using the menu.

1. Set the mode switch to  (Still Image).
2. MENU →  (REC Mode) → **P** (Program Auto) → ● on the control button
3. Shoot with the shutter button.

Note

- You may not be able to set some functions or MENU items depending on the selected REC mode. For details, see “Functions not available in some REC modes” [\[Details\]](#) and “MENU items not available in some REC modes.” [\[Details\]](#)



[▲ Back to top](#)

- ▶ Operation Search
- ▶ Before Use
- ▶ Shooting
- ▶ Viewing
- ▶ Using MENU items (Shooting)
- ▶ Using MENU items (Viewing)
- ▶ Changing settings
- ▶ Viewing images on a TV
- ▶ Using with your computer
- ▶ Printing
- ▶ Troubleshooting
- ▶ Precautions / About this camera











[→ Contents list](#)

Scene Selection



Allows you to shoot with preset settings according to the scene.

1. Set the mode switch to  (Still Image).
2. MENU →  (REC Mode) → **SCN** (Scene Selection) → ● on the control button → desired mode
 - If you want to select the other Scene Selection mode, select from MENU.

 (High Sensitivity)	<p>Allows you to shoot images without a flash under low light conditions, reducing blur.</p> 
 (Soft Snap)	<p>Allows you to shoot images with a softer atmosphere for portraits and flowers, etc.</p> 
 (Landscape)	<p>Allows easy shooting of distant scenes by focusing in the distance. Shoots vivid blue sky and flora colors.</p> 
 (Twilight Portrait)	<p>Allows you to shoot sharp images of people with the night view in the background without compromising the atmosphere.</p> 
	<p>Allows you to shoot night scenes at far distance without losing the dark atmosphere of the surroundings.</p>

 (Twilight)	
 (Gourmet)	<p>Shifts to Macro mode, allowing you to shoot food arrangements in delicious and bright color.</p> 
 (Pet)	<p>Allows you to shoot images of your pet with the best settings.</p> 
 (Beach)	<p>Allows you to record the blue of the water clearly when shooting seaside or lakeside scenes.</p> 
 (Snow)	<p>Allows you to record clear images preventing sunken colors in snowy scenes or other places where the whole screen appears white.</p> 

Notes

- When you shoot images using  (Twilight Portrait) or  (Twilight) mode, the shutter speed is slower and the images tend to blur. To prevent blurring, the use of a tripod is recommended.
- You may not be able to set some functions or MENU items depending on the selected REC mode. For details, see “Functions not available in some REC modes” [\[Details\]](#) and “MENU items not available in some REC modes.” [\[Details\]](#)



[▲ Back to top](#)

▶ Operation Search
▶ Before Use
▶ Shooting
▶ Viewing
▶ Using MENU items (Shooting)
▶ Using MENU items (Viewing)
▶ Changing settings
▶ Viewing images on a TV
▶ Using with your computer
▶ Printing
▶ Troubleshooting
▶ Precautions / About this camera



[→ Contents list](#)

SteadyShot

Allows you to shoot with reduced camera shake or subject blur.

1. Set the mode switch to  (Still Image).
2. MENU →  (REC Mode) →  (SteadyShot) → ● on the control button
3. Shoot with the shutter button.

Tips for preventing blur

If the camera moves accidentally when you shoot an image, “camera shake” occurs. On the other hand, if the subject moves when you shoot an image, “subject blur” can occur. Camera shake and subject blur occur frequently under low-light or slow shutter speed conditions, such as those encountered in  (Twilight Portrait) or  (Twilight) mode. In such a case, shoot with the below tips in mind.

Camera shake

Your hands or body moves while holding the camera and pressing the shutter button, and the entire screen is blurred.



- Use a tripod or place the camera on a flat surface to hold the camera steady.
- Shoot with a 2-second delay self-timer and stabilize the camera by holding your arms firmly at your side after pressing the shutter button.

Subject blur

Even though the camera is steady, the subject moves during the exposure and is captured blurred when the shutter button is pressed.



- Select  (High Sensitivity) mode in Scene Selection.
- Select a higher ISO sensitivity to make the shutter speed faster.

Note

- You may not be able to set some functions or MENU items depending on the selected REC mode. For details, see “Functions not available in some REC modes” [\[Details\]](#) and “MENU items not available in some REC modes.” [\[Details\]](#)

Sweep Panorama

Allows you to create a panorama image from composite images.



1. Set the mode switch to  (Sweep Panorama).
2. Align the camera with the end of the subject to be shot and press the shutter button fully.



3. Pan the camera to the end of the guide (A), following the indication on the LCD screen.



Tips for shooting a panorama image

Pan the camera in an arc at a constant velocity in the direction indicated on the LCD screen. Subjects at rest are more suited for panorama shots than moving subjects. Radius as short as possible.

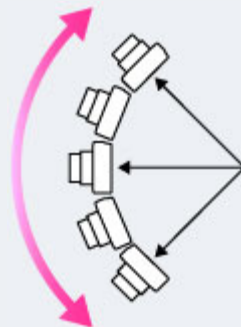

- ▶ Operation Search
- ▶ Before Use
- ▶ Shooting
- ▶ Viewing
- ▶ Using MENU items (Shooting)
- ▶ Using MENU items (Viewing)
- ▶ Changing settings
- ▶ Viewing images on a TV
- ▶ Using with your computer
- ▶ Printing
- ▶ Troubleshooting
- ▶ Precautions / About this camera

[→ Contents list](#)

Vertical direction

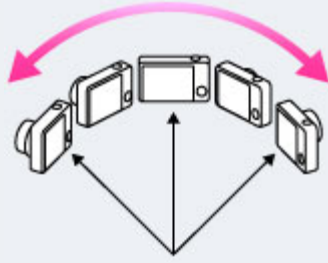

Horizontal direction

- First, press the shutter button halfway so that you can lock the focus, exposure and white balance. Then, press the shutter button fully down and pan or tilt the camera.
- If a section with greatly varied shapes or scenery is concentrated along a screen edge, the image composition may fail. In such case, adjust the frame composition so that the section is in the center of the image, then shoot again.

Notes

- If in Panorama shooting excessive camera shake occurs shooting stops, and a gray area will appear in the composite image. Be sure to shoot without blur.
- Since several images are stitched together, the stitched part will not be recorded smoothly.
- Under low light conditions, panorama images may be blurred or the shooting may not be successful.
- Under lights that flicker, such as fluorescent lights, the brightness or color of the combined image will not always be the same.
- When the whole angle of panoramic shooting and the AE/AF locked angle are very different in brightness, color and focus, the shooting will not be successful. If this happens, change AE/AF locked angle and shoot again.
- Sweep Panorama is not suitable for the following situations:
 - Moving subjects
 - Subjects are too close to the camera
 - Images with little contrast, such as sky, sandy beach or lawn
 - Images with constant changes, such as waves or waterfalls
- You cannot create panorama images in the following situations:
 - You pan the camera too quickly.
 - There is too much camera shake.
- You may not be able to set some functions or MENU items depending on the selected REC mode. For details, see “Functions not available in some REC modes” [\[Details\]](#) and “MENU items not available in some REC modes.” [\[Details\]](#)

Related Topic

[Scrolling the panorama images for display](#)

[Shooting Direction](#)

[Image Size](#)

[▲ Back to top](#)

Copyright 2011 Sony Corporation

▶ Operation Search
▶ Before Use
▶ Shooting
▶ Viewing
▶ Using MENU items (Shooting)
▶ Using MENU items (Viewing)
▶ Changing settings
▶ Viewing images on a TV
▶ Using with your computer
▶ Printing
▶ Troubleshooting
▶ Precautions / About this camera

[→ Contents list](#)

Movie Mode

Allows you to record movies with their audio.

1. Set the mode switch to  (Movie Mode).
2. Press the shutter button.
3. To stop recording, press the shutter button again.

Note

- You may not be able to set some functions or MENU items depending on the selected REC mode. For details, see “Functions not available in some REC modes” [\[Details\]](#) and “MENU items not available in some REC modes.” [\[Details\]](#)

Related Topic

[Shooting movies](#)

[Image Size](#)

[▲ Back to top](#)

Copyright 2011 Sony Corporation

Functions not available in some REC modes

In the table below, ✓ indicates a user-changeable function, while — indicates an unchangeable one. The icons below [Self-Timer] and [Flash] indicate the available flash modes.

	Self-Timer	Flash	Face Detection/Smile Shutter	Burst Settings
(Intelligent Auto)	✓	AUTO	✓	✓
P (Program Auto)	✓	✓	✓	✓
(SteadyShot)	✓	AUTO	✓	—
(Sweep Panorama)	—		—	—
(Movie Mode)	10 2		—	—
(High Sensitivity)	✓		✓	—
(Soft Snap)	✓	✓	✓*	✓
(Landscape)	10 2		—	✓
(Twilight Portrait)	✓	SL	✓	—
(Twilight)	10 2		—	—
(Gourmet)	10 2		—	—
(Pet)	10 2		—	—
(Beach)	✓		✓	✓
(Snow)	✓		✓	✓

* [Off] for [Face Detection] cannot be selected.

- ▶ Operation Search
- ▶ Before Use
- ▶ Shooting
- ▶ Viewing
- ▶ Using MENU items (Shooting)
- ▶ Using MENU items (Viewing)
- ▶ Changing settings
- ▶ Viewing images on a TV
- ▶ Using with your computer
- ▶ Printing
- ▶ Troubleshooting
- ▶ Precautions / About this camera

[→ Contents list](#)

[▲ Back to top](#)









Copyright 2011 Sony Corporation

- ▶ Operation Search
- ▶ Before Use
- ▶ Shooting
- ▶ Viewing
- ▶ Using MENU items (Shooting)
- ▶ Using MENU items (Viewing)
- ▶ Changing settings
- ▶ Viewing images on a TV
- ▶ Using with your computer
- ▶ Printing
- ▶ Troubleshooting
- ▶ Precautions / About this camera

[→ Contents list](#)

DISP (Screen Display Settings)

1. Press DISP (Screen Display Settings) on the control button.
2. Select the desired mode with the control button.

 (Bright + Image Only)	Sets screen brighter and displays only images. 
 (Bright + Exposure Data) (In playback mode only)	Sets screen brighter and displays the information. Exif data for the recorded image are also displayed. 
 (Bright)	Sets screen brighter and displays the information. 
  (Normal)	Sets screen to standard brightness and displays the information. 

Note





- If you view images in bright outside light, adjust the screen brightness up. However, the battery power may decrease faster under such condition.

▶ Operation Search
▶ Before Use
▶ Shooting
▶ Viewing
▶ Using MENU items (Shooting)
▶ Using MENU items (Viewing)
▶ Changing settings
▶ Viewing images on a TV
▶ Using with your computer
▶ Printing
▶ Troubleshooting
▶ Precautions / About this camera

[→ Contents list](#)

Flash

1. Press  (Flash) on the control button.
2. Select the desired mode with the control button.

	 AUTO (Auto)	Flash automatically operates in dark locations or when there is backlight.
	 (On)	Flash always operates.
	 SL (Slow Synchro)	Flash always operates. The shutter speed is slow in a dark place to clearly shoot the background that is out of flash light.
	 (Off)	Flash does not operate.

 When the “White circular spots” appears in flash photos

This is caused by particles (dust, pollen, etc.) floating close to the lens. When they are accentuated by the camera’s flash, they appear as white circular spots.



How can the “White circular spots” be reduced?

- Light the room and shoot the subject without a flash.
- Select **ISO** (High Sensitivity) mode in Scene Selection. ([Off] is automatically selected.)

Notes

- The flash strobos twice. The first flash adjusts the light quantity.
- While charging the flash,  is displayed.
- You cannot use the flash during burst shooting.
- You may not be able to set some functions or MENU items depending on the selected REC mode. For details, see “Functions not available in some REC modes” [\[Details\]](#) and “MENU items not available in some REC modes.” [\[Details\]](#)

[▲ Back to top](#)

Copyright 2011 Sony Corporation

▶ Operation Search
▶ Before Use
▶ Shooting
▶ Viewing
▶ Using MENU items (Shooting)
▶ Using MENU items (Viewing)
▶ Changing settings
▶ Viewing images on a TV
▶ Using with your computer
▶ Printing
▶ Troubleshooting
▶ Precautions / About this camera

[→ Contents list](#)

Smile Shutter

When the camera detects a smile, the shutter is released automatically.

1. Press ☺ (Smile) on the control button.
2. Wait for a smile to be detected.
When a smile is detected and the smile level exceeds the ◀ point on the indicator, the camera records images automatically.



- If you press the shutter button during Smile Shutter, the camera shoots the image, and then returns to Smile Shutter mode.
3. To stop shooting, press ☺ (Smile) again.

💡 Tips for better capturing of smiles



- 1 Do not cover the eyes with the bangs.
Do not obscure the face by hat, masks, sunglasses, etc.
- 2 Try to orient the face in front of the camera and be as level as possible.
Keep the eyes narrowed.
- 3 Give a clear smile with an open mouth. The smile is easier to detect when the teeth are shown.
 - The shutter operates when any person whose face is being detected smiles.
 - You can select the priority subject for face detection with [Face Detection]. To perform smile detection for a different face, change the priority face with ● on the control button. [\[Details\]](#)
 - If a smile is not detected, set the [Smile Detection Sensitivity] in setting menu.

Notes

- Shooting using the Smile Shutter ends automatically when either the memory card or internal memory becomes full.
- Smiles may not be detected correctly depending on the conditions.
- You cannot use the digital zoom function.
- You may not be able to set some functions or MENU items depending on the selected REC mode. For details, see “Functions not available in some REC modes” [\[Details\]](#) and “MENU items not available in some REC modes.” [\[Details\]](#)

Related Topic

[Smile Detection Sensitivity](#)

[▲ Back to top](#)

Copyright 2011 Sony Corporation







▶ Operation Search
▶ Before Use
▶ Shooting
▶ Viewing
▶ Using MENU items (Shooting)
▶ Using MENU items (Viewing)
▶ Changing settings
▶ Viewing images on a TV
▶ Using with your computer
▶ Printing
▶ Troubleshooting
▶ Precautions / About this camera

[→ Contents list](#)



Self-Timer

▼ Automatic shooting with Self-portrait timer

1. Press  (Self-Timer) on the control button.
2. Select the desired mode with the control button.

	 OFF (Off)	Does not use the self-timer.
	 (10sec)	Sets the self-timer to a 10-second delay. When you press the shutter button, the self-timer lamp flashes and a beep sounds until the shutter operates. To cancel, press  again.
	 (2sec)	Sets the self-timer to a 2-second delay.
	 (Self-portrait One Person)	Sets the self-timer to Self-portrait timer. When the camera detects the specified number of faces, a beep sounds, and the shutter operates 2 seconds later.
	 (Self-portrait Two People)	

Tips for preventing blur

If your hands or body moves while holding the camera and pressing the shutter button, “Camera shake” occurs. Camera shake occurs frequently under low-light or slow shutter speed conditions, such as those encountered in  (Twilight Portrait) or  (Twilight) mode. In such a case, shoot with the below tips in mind.



- Shoot with a 2-second delay self-timer and stabilize the camera by holding your arms firmly at your side after pressing the shutter button.
- Use a tripod or place the camera on a flat surface to hold the camera steady.

Note

- You may not be able to set some functions depending on the selected REC mode. For details, see “Functions not available in some REC modes.” [\[Details\]](#)

Automatic shooting with Self-portrait timer

Point the lens at yourself so your face is reflected in the LCD screen. The camera detects the subjects, and then the shutter operates. The camera determines the optimal composition and prevents faces from being cut out of the LCD screen. Do not move your camera after the beep sounds.



- You can also shoot an image by pressing the shutter button during this operation.

[▲ Back to top](#)

Copyright 2011 Sony Corporation

▶ Operation Search
▶ Before Use
▶ Shooting
▶ Viewing
▶ Using MENU items (Shooting)
▶ Using MENU items (Viewing)
▶ Changing settings
▶ Viewing images on a TV
▶ Using with your computer
▶ Printing
▶ Troubleshooting
▶ Precautions / About this camera

[→ Contents list](#)

Viewing still images

1. Press the  (Playback) button to switch to playback mode.
2. Select an image with the control button.

[▲ Back to top](#)

▶ Operation Search
▶ Before Use
▶ Shooting
▶ Viewing
▶ Using MENU items (Shooting)
▶ Using MENU items (Viewing)
▶ Changing settings
▶ Viewing images on a TV
▶ Using with your computer
▶ Printing
▶ Troubleshooting
▶ Precautions / About this camera

[→ Contents list](#)

Playback zoom

Enlarges the image being played back.

1. Press **Q** (Playback zoom) button during still image playback.
The image is enlarged to twice the previous size, at the center of the image.
2. Adjust the position with the control button.
The mark in the lower left of the image shows which part of the total image is being displayed.



3. Change the zoom scale with W/T (zoom) button.
Press **Q** button (T) to zoom in, W side to zoom out.
Press **●** to cancel playback zoom.

To save enlarged images

You can save an enlarged image by using the trimming function.
Press MENU → [Retouch] → [Trimming (Resize)].

[▲ Back to top](#)



Copyright 2011 Sony Corporation

▶ Operation Search
▶ Before Use
▶ Shooting
▶ Viewing
▶ Using MENU items (Shooting)
▶ Using MENU items (Viewing)
▶ Changing settings
▶ Viewing images on a TV
▶ Using with your computer
▶ Printing
▶ Troubleshooting
▶ Precautions / About this camera



[→ Contents list](#)

Image Index

Displays multiple images at the same time.

1. Press the  (Playback) button to switch to playback mode.
2. Press the  (Index) button to display the image index screen.
Press the button again to display an index screen with more images.
3. To return to the single-image screen, select an image with the control button, then press .

Displaying images of the desired folder

Select the left side bar with the control button, then select the desired folder with  / .



[▲ Back to top](#)



▶ Operation Search
▶ Before Use
▶ Shooting
▶ Viewing
▶ Using MENU items (Shooting)
▶ Using MENU items (Viewing)
▶ Changing settings
▶ Viewing images on a TV
▶ Using with your computer
▶ Printing
▶ Troubleshooting
▶ Precautions / About this camera

[→ Contents list](#)

Delete button

Allows you to select unwanted images for deletion.

You can also delete images from the MENU button. [\[Details\]](#)

1. Press the  (Playback) button to switch to playback mode.
2.  (Delete) button → desired mode → ● on the control button

All in This Folder	Deletes all images in the selected folder at once. Press [OK] → ● after step 2.
Multiple Images	Allows you to select and delete multiple images. Do as the following after step 2. ① Select an image then press ● . Repeat the above steps until there are no more images to be deleted. Select an image with a ✓ mark again to release the ✓ mark. ② MENU → [OK] → ●
This Image	Deletes the currently displayed image in single-image mode.
Cancel	Cancels the deletion.

 You can switch between index and single-image mode when selecting images

Press the  button (T) of the W/T (zoom) button in index mode to return to single-image mode, and press the  (Index) button (W) in single-image mode to return to index mode.

- You can also switch between index and single-image mode in [Protect] or [DPOF].



Note

- In Easy Mode, you can select from [Delete Single Image] or [Delete All Images] to delete an image.

Related Topic



[Delete](#)

[▲ Back to top](#)







▶ Operation Search
▶ Before Use
▶ Shooting
▶ Viewing
▶ Using MENU items (Shooting)
▶ Using MENU items (Viewing)
▶ Changing settings
▶ Viewing images on a TV
▶ Using with your computer
▶ Printing
▶ Troubleshooting
▶ Precautions / About this camera

[→ Contents list](#)

Viewing movies

1. Press the  (Playback) button to switch to playback mode.
2. Select a movie with the control button.
3. Press  .
The Playback bar appear, then movie playback starts.



Control button	Playback feature
	Pause
	Fast forward
	Fast rewind
	Displays the volume control screen. Adjust the volume with  /  on the control button, then press  .

Note

- You may not be able to play back some images shot using other cameras.

[▲ Back to top](#)

[Top page](#) > [Viewing](#) > [Viewing panorama images](#) > [Scrolling the panorama images for display](#)

Scrolling the panorama images for display

You can scroll panorama images by pressing ● on the control button while panorama images are being displayed. Press the W (zoom) button to display the whole image again.



A: Shows the displayed area of the whole panorama image

Operation button	Action
● on the control button	Scrolling playback/pauses scrolling images
▲ / ▼ / ◀ / ▶ on the control button	Scrolls images
W (zoom) button	Displays the whole image

- Panorama images can also be played back using the supplied software "PMB". [\[Details\]](#)
- Panorama images recorded using another camera may not scroll correctly when played.

[▲ Back to top](#)

Copyright 2011 Sony Corporation

▶ Operation Search
▶ Before Use
▶ Shooting
▶ Viewing
▶ Using MENU items (Shooting)
▶ Using MENU items (Viewing)
▶ Changing settings
▶ Viewing images on a TV
▶ Using with your computer
▶ Printing
▶ Troubleshooting
▶ Precautions / About this camera

[→ Contents list](#)

[Top page](#) > [Using MENU items \(Shooting\)](#) > [Using MENU items \(Shooting\)](#) > [Using MENU items \(Shooting\)](#)

Using MENU items (Shooting)

You can select the various shooting functions easily from the MENU button.

1. Press the ON/OFF (Power) button and set the camera to shooting mode.
2. Press the MENU button to display the Menu screen.

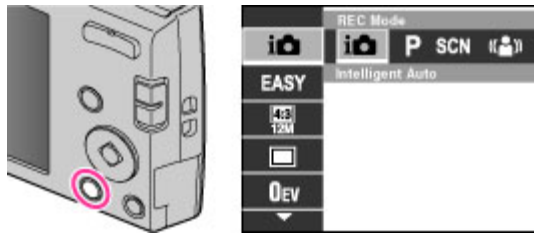

3. Select the desired menu item with ▲ / ▼ / ◀ / ▶ on the control button.

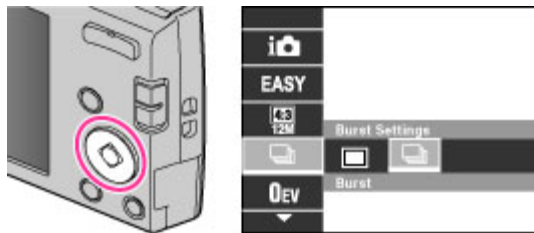

4. Press the MENU button to turn off the Menu screen.

- ▶ Operation Search
- ▶ Before Use
- ▶ Shooting
- ▶ Viewing
- ▶ Using MENU items (Shooting)
- ▶ Using MENU items (Viewing)
- ▶ Changing settings
- ▶ Viewing images on a TV
- ▶ Using with your computer
- ▶ Printing
- ▶ Troubleshooting
- ▶ Precautions / About this camera

[→ Contents list](#)

[▲ Back to top](#)



Copyright 2011 Sony Corporation

- ▶ Operation Search
- ▶ Before Use
- ▶ Shooting
- ▶ Viewing
- ▶ Using MENU items (Shooting)
- ▶ Using MENU items (Viewing)
- ▶ Changing settings
- ▶ Viewing images on a TV
- ▶ Using with your computer
- ▶ Printing
- ▶ Troubleshooting
- ▶ Precautions / About this camera

[→ Contents list](#)

REC Mode

1. MENU →  (REC Mode) → desired mode

	 (Intelligent Auto)	Allows you to shoot with the setting adjusted automatically. [Details]
P	(Program Auto)	Allows you to shoot with the exposure adjusted automatically (both the shutter speed and the aperture value). [Details] Also you can select various settings using the menu.
SCN	(Scene Selection)	Allows you to shoot with preset settings according to the scene. [Details]
	(SteadyShot)	Allows you to shoot with reduced camera shake or subject blur. [Details]

[▲ Back to top](#)









- ▶ Operation Search
- ▶ Before Use
- ▶ Shooting
- ▶ Viewing
- ▶ Using MENU items (Shooting)
- ▶ Using MENU items (Viewing)
- ▶ Changing settings
- ▶ Viewing images on a TV
- ▶ Using with your computer
- ▶ Printing
- ▶ Troubleshooting
- ▶ Precautions / About this camera









[→ Contents list](#)

Scene Selection



When you want to select another scene, follow the steps below.

1. MENU →  (REC Mode) → **SCN** (Scene Selection) → ● on the control button → desired mode

 (High Sensitivity)	<p>Allows you to shoot images without a flash under low light conditions, reducing blur.</p> 
 (Soft Snap)	<p>Allows you to shoot images with a softer atmosphere for portraits and flowers, etc.</p> 
 (Landscape)	<p>Allows easy shooting of distant scenes by focusing in the distance. Shoots the clear sky and trees and flowers in vivid colors.</p> 
 (Twilight Portrait)	<p>Allows you to shoot sharp images of people with the night view in the background without compromising the atmosphere.</p> 
 (Twilight)	<p>Allows you to shoot night scenes at far distance without losing the dark atmosphere of the surroundings.</p>

	
 (Gourmet)	<p>Allows you to shoot food arrangements in delicious and bright colors using Macro mode.</p> 
 (Pet)	<p>Allows you to shoot images of your pet with the best settings.</p> 
 (Beach)	<p>Allows you to shoot images with the proper settings for seaside or lakeside scenes.</p> 
 (Snow)	<p>Allows you to record clear images preventing sunken colors in snowy scenes or other places where the whole screen appears white.</p> 

Notes

- When you shoot images using  (Twilight Portrait) or  (Twilight) mode, the shutter speed is slower and the images tend to blur. To prevent blurring, the use of a tripod is recommended.
- You may not be able to set some functions or MENU items depending on the selected REC mode. For details, see “Functions not available in some REC modes” [\[Details\]](#) and “MENU items not available in some REC modes.” [\[Details\]](#)

[▲ Back to top](#)

- ▶ Operation Search
- ▶ Before Use
- ▶ Shooting
- ▶ Viewing
- ▶ Using MENU items (Shooting)
- ▶ Using MENU items (Viewing)
- ▶ Changing settings
- ▶ Viewing images on a TV
- ▶ Using with your computer
- ▶ Printing
- ▶ Troubleshooting
- ▶ Precautions / About this camera

[→ Contents list](#)

Easy Mode

Allows you to shoot still images using the minimum necessary functions. The text size increases and indicators become easier to see.

1. MENU → **EASY** (Easy Mode) → ● on the control button.
2. [OK] → ●
3. Shoot with the shutter button.
 - To exit Easy mode, press the MENU button, then select [Exit Easy Mode].

Note

- The battery power may decrease faster because the screen brightness increases automatically.

On Scene Recognition

Scene Recognition operates in Easy Mode. This function lets the camera automatically recognize the shooting conditions and shoot the image.



The camera recognizes 🌙 (Twilight), 🧑 (Twilight Portrait), 📷 (Twilight using a tripod), 🌅 (Backlight), 🧑 (Backlight Portrait), 🏞️ (Landscape), 🌸 (Macro) or 🧑 (Portrait), and displays an icon on the LCD screen when the scene is recognized. For details, see “Scene Recognition.” [\[Details\]](#)

Shooting functions available in Easy Mode (Shooting)

Image Size	MENU → [Image Size] → ● on the control button → desired mode → ● Select between [Large] or [Small] size.
Self-Timer	🕒 on the control button → desired mode Select between [10sec] or [Off] mode.
Flash	⚡ on the control button → desired mode Select between [Auto] or [Off] mode.
Smile Shutter	😊 on the control button

Related Topic
[Scene Recognition](#)





[▲ Back to top](#)

Copyright 2011 Sony Corporation

Shooting Direction

Set the direction in which the camera will be panned when shooting in Sweep Panorama mode.

1. MENU →  (Shooting Direction) → desired direction

<input checked="" type="checkbox"/>	 (Right)	Pan from left to right.
<input type="checkbox"/>	 (Left)	Pan from right to left.
<input type="checkbox"/>	 (Up)	Pan from down to up.
<input type="checkbox"/>	 (Down)	Pan from up to down.

Related Topic

[Sweep Panorama](#)

[→ Contents list](#)

[▲ Back to top](#)

Copyright 2011 Sony Corporation

▶ Operation Search
▶ Before Use
▶ Shooting
▶ Viewing
▶ Using MENU items (Shooting)
▶ Using MENU items (Viewing)
▶ Changing settings
▶ Viewing images on a TV
▶ Using with your computer
▶ Printing
▶ Troubleshooting
▶ Precautions / About this camera

[→ Contents list](#)

Image Size

- ▼ Image size when shooting still images
- ▼ Image size in Easy Mode
- ▼ Image size when shooting Sweep Panorama
- ▼ Image size when shooting movies

The image size determines the size of the image file that is recorded when you take an image. The larger the image size, the more detail will be reproduced when the image is printed on large-format paper. The smaller the image size, the more images can be recorded.

1. MENU →  (Image Size) → desired size

 On "image quality" and "image size"

A digital image is made up of a collection of small dots called pixels.

If it contains a large number of pixels (A), the image becomes large, it takes up more memory, and the image is displayed in fine detail. "Image size" is shown by the number of pixels.

Although you cannot see the differences on the screen of the camera, the fine detail and data processing time differ when the image is printed or displayed on a computer screen.

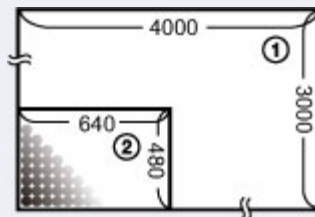

- ① Image size: 12M
4000 pixels × 3000 pixels = 12,000,000 pixels
- ② Image size: VGA
640 pixels × 480 pixels = 307,200 pixels

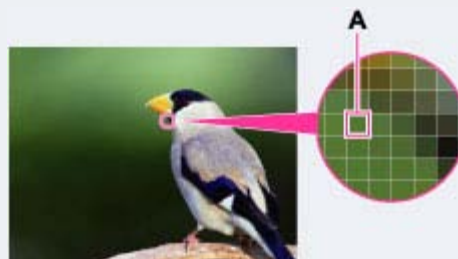









Many pixels
(Fine image quality and large file size)



Few pixels
(Rough image quality but small file size)

Image size when shooting still images

	Image size	Usage guidelines	No. of images	Printing
✓	 (4000×3000)	For prints up to A3+ size	Less	Fine
	 (3264×2448)	For prints up to A3 size	 ↑ ↓	
	 (2592×1944)	For prints from 10×15 cm up to A4 size		↓
	 (640×480)	For e-mail attachments	More	Rough
	 (4000×2248)	For viewing on a high-definition TV and printing up to A4 size	Less	Fine
	 (1920×1080)	For viewing on a high-definition TV	More	Rough

Note

- When you print still images recorded at a 16:9 aspect ratio or panoramic images, both edges may be cut off.

Image size in Easy Mode

✓	Large	Shoots images in [12M] size.
	Small	Shoots images in [5M] size.

Image size when shooting Sweep Panorama

✓	 (Standard) (Horizontal: 4912 × 1080) (Vertical: 3424 × 1920)	Shoots images using standard size.
---	--	------------------------------------



 (Wide) (Horizontal: 7152 × 1080) (Vertical: 4912 × 1920)	Shoots images using wide size.
---	--------------------------------

Image size when shooting movies

The larger the image size, the higher the image quality.

The movies shot with this camera will be recorded in AVI (Motion JPEG), Approx. 30fps format.

	Movie image size	Usage guidelines
<input checked="" type="checkbox"/>	 VGA (640×480)	For viewing on a TV screen
<input type="checkbox"/>	 QVGA (320×240)	For sending as an e-mail attachment



[▲ Back to top](#)

Copyright 2011 Sony Corporation

Burst Settings

You can select Single (single-image) or Burst as the shooting mode.

1. MENU →  (Burst Settings) → desired mode

✓	 (Single)	The camera shoots a single image.
	 (Burst)	The camera shoots up to 100 continuous frames in one burst when you hold down the shutter button. 

Notes

- [Flash] is set to [Off].
- When recording with the self-timer, a series of up to 5 images is recorded.
- The recording interval becomes longer, depending on the setting for the image size.
- [Focus], [White Balance], and [EV] are adjusted for the first image, and these settings are also used for the other images.
- When the battery level is low, or when the internal memory or a memory card is full, the burst stops.
- You may not be able to set some functions or MENU items depending on the selected REC mode. For details, see “Functions not available in some REC modes” [\[Details\]](#) and “MENU items not available in some REC modes.” [\[Details\]](#)

[→ Contents list](#)

[▲ Back to top](#)

▶ Operation Search
▶ Before Use
▶ Shooting
▶ Viewing
▶ Using MENU items (Shooting)
▶ Using MENU items (Viewing)
▶ Changing settings
▶ Viewing images on a TV
▶ Using with your computer
▶ Printing
▶ Troubleshooting
▶ Precautions / About this camera

[→ Contents list](#)

EV

You can adjust the exposure manually in 1/3 EV steps in a range of -2.0 EV to +2.0 EV.

1. MENU → **0EV** (EV) → desired EV setting

💡 Adjusting the exposure for better looking images



A: Whitish image (Overexposure = too much light)

B: Correct exposure

C: Darker image (Underexposure = too little light)

Note

- If you shoot a subject in extremely bright or dark conditions, or when you use the flash, the exposure adjustment may not be effective.
- You may not be able to set some MENU items depending on the selected REC mode. For details, see “MENU items not available in some REC modes.” [\[Details\]](#)

[▲ Back to top](#)

- ▶ Operation Search
- ▶ Before Use
- ▶ Shooting
- ▶ Viewing
- ▶ Using MENU items (Shooting)
- ▶ Using MENU items (Viewing)
- ▶ Changing settings
- ▶ Viewing images on a TV
- ▶ Using with your computer
- ▶ Printing
- ▶ Troubleshooting
- ▶ Precautions / About this camera

[→ Contents list](#)

ISO

Adjusts the luminous sensitivity when the camera is set to Program Auto.

1. MENU → ^{ISO}AUTO (ISO) → desired mode

✓	ISO AUTO (Auto)	Sets the ISO sensitivity automatically.
	ISO 80/100/200/400/ ISO 800/1600/3200	You can reduce image blurring in dark locations or with moving subjects by increasing the ISO sensitivity (select a larger number).

💡 Adjusting ISO Sensitivity (Recommended Exposure Index)

ISO sensitivity is a speed rating for recording media that incorporates an image sensor that receives light. Even when the exposure is the same, images differ depending on the ISO sensitivity.



High ISO sensitivity

Records a bright image even in dark locations while increasing shutter speed to reduce blur. However, the image tends to become noisy.



Low ISO sensitivity

Records a smoother image.

However, when the exposure is insufficient, the image may become darker.

Note

- You can select only from [ISO AUTO], [ISO 80] to [ISO 800] when the shooting mode is set to burst mode, or when [DRO] is set to [DRO plus].

[▲ Back to top](#)









- ▶ Operation Search
- ▶ Before Use
- ▶ Shooting
- ▶ Viewing
- ▶ Using MENU items (Shooting)
- ▶ Using MENU items (Viewing)
- ▶ Changing settings
- ▶ Viewing images on a TV
- ▶ Using with your computer
- ▶ Printing
- ▶ Troubleshooting
- ▶ Precautions / About this camera

[→ Contents list](#)

White Balance

Adjusts color tones according to the surrounding light conditions. Use this function if image color appears unnatural.

1. MENU →  (White Balance) → desired mode

	 (Auto)	Adjusts the white balance automatically so that the colors appear natural.
	(Daylight)	Adjusts for outdoors conditions on a fine day, evening views, night scenes, neon signs, fireworks, etc.
	(Cloudy)	Adjusts for a cloudy sky or a shady location.
	(Fluorescent White Balance 1)	[Fluorescent White Balance 1]: Adjusts for white fluorescent lighting.
	(Fluorescent White Balance 2)	[Fluorescent White Balance 2]: Adjusts for natural white fluorescent lighting.
	(Fluorescent White Balance 3)	[Fluorescent White Balance 3]: Adjusts for day white fluorescent lighting.
	(Incandescent)	Adjusts for places under incandescent lamp, or under bright lighting, such as in a photo studio.
	(Flash)	Adjusts for the flash conditions.

Effects of lighting conditions

The apparent color of the subject is affected by the lighting conditions. The color tones are adjusted automatically, but you can adjust color tones manually using the White Balance function.



Daylight (White as Standard)



Cloudy (Bluish)



Fluorescent (Green-tinged)



Incandescent (Reddish)

Notes

- Under fluorescent lights that flicker, the white balance function may not work correctly even though you select [Fluorescent White Balance 1], [Fluorescent White Balance 2] or [Fluorescent White Balance 3].
- When shooting with a flash in other than [Flash] mode, [White Balance] is set to [Auto].
- When [Flash] is [On] or [Slow Synchro], the white balance can only be adjusted to [Auto] or [Flash].
- You may not be able to set some MENU items depending on the selected REC mode. For details, see “MENU items not available in some REC modes.” [\[Details\]](#)

[▲ Back to top](#)

Copyright 2011 Sony Corporation

- ▶ Operation Search
- ▶ Before Use
- ▶ Shooting
- ▶ Viewing
- ▶ Using MENU items (Shooting)
- ▶ Using MENU items (Viewing)
- ▶ Changing settings
- ▶ Viewing images on a TV
- ▶ Using with your computer
- ▶ Printing
- ▶ Troubleshooting
- ▶ Precautions / About this camera

[→ Contents list](#)

FOCUS







▼ Focusing on subjects near the edge of the screen

You can change the focus method. Use the menu when it is difficult to get the proper focus in auto focus mode.

AF stands for "Auto Focus," a function that adjusts the focus automatically.

The selected AF range finder frame appears on the screen.

1. MENU →  (Focus) → desired mode

 ✓ (Multi AF)	<p>Focuses on a subject in all ranges of the finder frame automatically. When you press the shutter button halfway down in still image shooting mode, a green frame is displayed around the area that is in focus.</p>  <ul style="list-style-type: none"> ● When the Face Detection function is active, AF operates with priority on faces.
 (Center AF)	<p>Focuses on a subject in the center of the finder frame automatically. Using the AF lock function together, you can compose the image the way you want.</p> 
 (Spot AF)	<p>Focuses on an extremely small subject or a narrow area automatically. Using the AF lock function together, you can compose the image the way you want.</p>  <ul style="list-style-type: none"> ● Hold the camera steady so as not to misalign the subject and the AF range finder frame.

Notes

- When you use [Digital Zoom], the AF range finder frame is disabled and appears in a dotted line. In this case, the camera works to focus on the subjects at the center of the screen.
- When the focus mode is set to other than [Multi AF], you cannot use the Face Detection function.
- You may not be able to set some MENU items depending on the selected REC mode. For

| Focusing on subjects near the edge of the screen

If the subject is out of focus, do as follows:

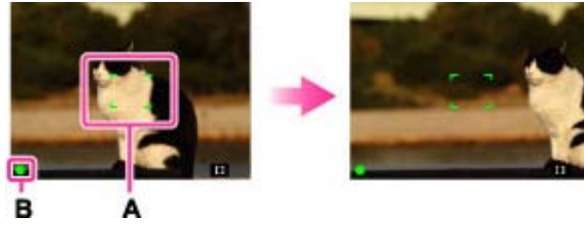

1. Recompose the shot so that the subject is centered in the AF range finder (A), and press the shutter button halfway to focus on the subject (AF lock).
2. When the AE/AF lock indicator (B) stops flashing and remains on, return to the fully composed shot, and press the shutter button fully down.
 - As long as you do not press the shutter button fully down, you can retry the procedure as many times as necessary.

[▲ Back to top](#)

Copyright 2011 Sony Corporation





- ▶ Operation Search
- ▶ Before Use
- ▶ Shooting
- ▶ Viewing
- ▶ Using MENU items (Shooting)
- ▶ Using MENU items (Viewing)
- ▶ Changing settings
- ▶ Viewing images on a TV
- ▶ Using with your computer
- ▶ Printing
- ▶ Troubleshooting
- ▶ Precautions / About this camera

[→ Contents list](#)

Metering Mode

Selects the metering mode that sets which part of the subject to measure to determine the exposure.

1. MENU →  (Metering Mode) → desired mode

<input checked="" type="checkbox"/>	 (Multi)	Divides into multiple regions and measures each region. The camera determines a well-balanced exposure (Multi-pattern metering).
<input type="checkbox"/>	 (Center)	Measures the center of the image, and determines the exposure based on the brightness of the subject there (Center-weighted metering).
<input type="checkbox"/>	 (Spot)	Align the spot metering cross hairs on the subject to meter one part of the subject (Spot metering). This function is useful when the subject is backlit or when there is strong contrast between the subject and the background. 

Notes

- In Movie Mode, [Spot] cannot be selected.
- If you set [Metering Mode] to other than [Multi], the Face Detection function cannot be used.
- You may not be able to set some MENU items depending on the selected REC mode. For details, see "MENU items not available in some REC modes." [\[Details\]](#)

[▲ Back to top](#)

- ▶ Operation Search
- ▶ Before Use
- ▶ Shooting
- ▶ Viewing
- ▶ Using MENU items (Shooting)
- ▶ Using MENU items (Viewing)
- ▶ Changing settings
- ▶ Viewing images on a TV
- ▶ Using with your computer
- ▶ Printing
- ▶ Troubleshooting
- ▶ Precautions / About this camera

[→ Contents list](#)

Scene Recognition

▼ On Advanced mode

The camera automatically detects shooting conditions, and then takes the shot. When a motion is detected, the ISO sensitivity is increased according to the movement to reduce subject blur (Motion Detection).



The camera recognizes the following types of scenes. When the camera determines the optimal scene, it displays the corresponding icon and guide.

☾ (Twilight), 🧑 (Twilight Portrait), 🚶 (Twilight using a tripod), 🌃 (Backlight), 🧑🌃 (Backlight Portrait), 🏞️ (Landscape), 🌿 (Macro), 🧑 (Portrait)

1. MENU → 📷 (REC Mode) → 📷 (Intelligent Auto) → 📷 (Scene Recognition) → desired mode





✓	📷 (Auto)	When the camera recognizes the scene, it switches to the optimal settings and shoots the image.
	📷+ (Advanced)	<p>When the camera recognizes the scene, it switches to the optimal settings. When the camera recognizes ☾ (Twilight), 🧑 (Twilight Portrait), 🚶 (Twilight using a tripod), 🌃 (Backlight) or 🧑🌃 (Backlight Portrait), it automatically changes the setting and shoots another image.</p> <ul style="list-style-type: none"> When you shoot two images consecutively, the + mark on the 📷+ icon will turn green. When two frames are shot, the two images are displayed side by side immediately after shooting.

Notes

- Scene Recognition function does not operate when you shoot images using digital zoom.
- The available flash settings are [Auto] and [Off].
- These scenes may not be recognized depending on the situation.
- You may not be able to set some MENU items depending on the selected REC mode. For details, see "MENU items not available in some REC modes." [\[Details\]](#)

On Advanced mode

In [Advanced] mode, the camera shoots two images consecutively with the settings differing as follows when it recognizes ☾ (Twilight), 🧑 (Twilight Portrait), 🚶 (Twilight using a tripod), 🌃 (Backlight) or 🧑🌃 (Backlight Portrait) scenes, which tends to blur. You can select the desired image from the two images shot.

	First Image*	Second Image
	Shoots in Slow Synchro	Shoots with sensitivity increased and shake reduced
	Shoots in Slow Synchro with the face which the flash strobos on as guide	Shoots with sensitivity increased with the face as guide and shake reduced
	Shoot in Slow Synchro	Shoots with even slower shutter speed without increasing sensitivity
	Shoots with the flash	Shoots with the brightness and contrast of the background adjusted (DRO plus)
	Shoots with the face which the flash strobos on as guide	Shoots with the brightness and contrast of the face and the background adjusted (DRO plus)

* When [Flash] is set to [Auto].

[▲ Back to top](#)

Copyright 2011 Sony Corporation

Smile Detection Sensitivity

Sets the sensitivity of the Smile Shutter function for detecting smiles.

1. MENU → 😊 (Smile Detection Sensitivity) → desired mode

	😊 (Big Smile)	Detects a big smile.
✓	😊 (Normal Smile)	Detects a normal smile.
	😊 (Slight Smile)	Detects even a slight smile.

Notes

- Smiles may not be detected correctly depending on the conditions.
- You may not be able to set some MENU items depending on the selected REC mode. For details, see “MENU items not available in some REC modes.” [\[Details\]](#)

Related Topic

[Smile Shutter](#)

[▲ Back to top](#)

Copyright 2011 Sony Corporation

- ▶ Operation Search
- ▶ Before Use
- ▶ Shooting
- ▶ Viewing
- ▶ Using MENU items (Shooting)
- ▶ Using MENU items (Viewing)
- ▶ Changing settings
- ▶ Viewing images on a TV
- ▶ Using with your computer
- ▶ Printing
- ▶ Troubleshooting
- ▶ Precautions / About this camera

[→ Contents list](#)

▶ Operation Search
▶ Before Use
▶ Shooting
▶ Viewing
▶ Using MENU items (Shooting)
▶ Using MENU items (Viewing)
▶ Changing settings
▶ Viewing images on a TV
▶ Using with your computer
▶ Printing
▶ Troubleshooting
▶ Precautions / About this camera

→ [Contents list](#)

Face Detection



▼ Selecting the priority face

When the Face Detection function is used, the camera detects the faces of your subjects and adjusts the focus, flash, white balance and red-eye reduction settings automatically.



When the camera detects more than one subject, the camera will judge which is the main subject and set focus by priority. The Face Detection frame for the main subject will turn orange. The frame for which the focus is set will turn green by pressing the shutter button halfway down.

1. MENU →  (Face Detection) → desired mode

 (Off)	Cannot use Face Detection.
 (Auto)	Selects the face the camera is to automatically focus on.

Notes







- [Off] is not available when [Self-Timer] is set to [Self-portrait One Person] or [Self-portrait Two People].
- You can select [Face Detection] only when the focus mode is set to [Multi AF] and the metering mode is set to [Multi].
- The Face Detection function does not work when using the digital zoom.
- Up to 8 faces of your subjects can be detected.
- During Smile Shutter shooting, [Face Detection] is automatically set to [Auto] even if it is set to [Off].
- You may not be able to set some MENU items depending on the selected REC mode. For details, see “MENU items not available in some REC modes.” [\[Details\]](#)

Selecting the priority face

Normally the camera automatically selects the face to focus on according to the [Face Detection] setting, but you can also select a face to be given priority.



1. Press  on the control button during Face Detection. The leftmost face is selected as the

- priority face, and the frame changes from  to an orange frame (.
2. Each time you press , the priority face moves one face to the right. Press  repeatedly until the orange frame () is on the face you want to select.
 3. To cancel the face selection (Off), move the orange frame to the rightmost face, then press  again.
- It may not be possible to detect the selected face correctly depending on the surrounding brightness, the subject's hairstyle, etc. In this case, select the face again under the conditions where the image will be shot.
 - When the Smile Shutter function is used with the Face Detection frame selected, Smile Detection is performed only on the selected face.
 - You cannot select the priority face in Easy Shooting mode or when the self-timer is set to [Self-portrait One Person] or [Self-portrait Two People].

[▲ Back to top](#)

Copyright 2011 Sony Corporation

▶ Operation Search
▶ Before Use
▶ Shooting
▶ Viewing
▶ Using MENU items (Shooting)
▶ Using MENU items (Viewing)
▶ Changing settings
▶ Viewing images on a TV
▶ Using with your computer
▶ Printing
▶ Troubleshooting
▶ Precautions / About this camera



[→ Contents list](#)

DRO

The camera analyzes the shooting scene and automatically corrects the brightness and contrast to improve the image quality.

DRO stands for “Dynamic Range Optimizer,” a function that automatically optimizes the difference between light and dark parts of an image.

1. MENU →  (REC Mode) → P (Program Auto) →  (DRO) → desired mode

 (Off)	Does not adjust.
<input checked="" type="checkbox"/>  (DRO standard)	Adjusts the brightness and contrast of the images automatically.
 (DRO plus)	Adjusts image brightness and contrast automatically and strongly.

Notes

- Depending on shooting conditions, it may not be possible to obtain correction effects.
- Only [ISO AUTO] or values from [ISO 80] to [ISO 800] can be set for the ISO value when [DRO plus] is set.

[▲ Back to top](#)

[Top page](#) > [Using MENU items \(Shooting\)](#) > [Shooting MENU list](#) > [MENU items not available in some REC modes](#)

MENU items not available in some REC modes

In the table below, ✓ indicates settings that can be changed, while — indicates settings that cannot be changed. The icons below **SCN** indicate the available modes. A setting may be fixed or restricted depending on the shooting mode.

Menu items	i	P	SCN	(人)	⏏	📺
Scene Selection	—	—	✓	—	—	—
Easy Mode	✓	✓	✓	✓	—	—
Shooting Direction	—	—	—	—	✓	—
Image Size	✓	✓	✓	✓	✓	✓
Burst Settings	✓	✓	📷 📷 📷 📷	—	—	—
EV	✓	✓	✓	✓	✓	✓
ISO	—	✓	—	—	—	—
White Balance	—	✓	ISO 📷 📷	✓	✓	✓
Focus	—	✓	—	—	✓	—
Metering Mode	—	✓	—	—	✓	✓
Scene Recognition	✓	—	—	—	—	—
Smile Detection Sensitivity	✓	✓	ISO 📷 📷 📷 📷	✓	—	—
Face Detection	✓	✓	ISO 📷 📷 📷	✓	—	—
DRO	—	✓	—	—	—	—
📷 (Settings)	✓	✓	✓	✓	✓	✓

Note

- Only the items that are available for each mode are displayed on the screen.

- ▶ Operation Search
- ▶ Before Use
- ▶ Shooting
- ▶ Viewing
- ▶ Using MENU items (Shooting)
- ▶ Using MENU items (Viewing)
- ▶ Changing settings
- ▶ Viewing images on a TV
- ▶ Using with your computer
- ▶ Printing
- ▶ Troubleshooting
- ▶ Precautions / About this camera

[→ Contents list](#)

[▲ Back to top](#)

Copyright 2011 Sony Corporation

Top page > Using MENU items (Viewing) > Using MENU items (Viewing) > Using MENU items (Viewing)

Using MENU items (Viewing)

You can select the various viewing functions easily from the MENU button.

1. Press the  (Playback) button to switch to playback mode.
2. Press the MENU button to display the Menu screen.

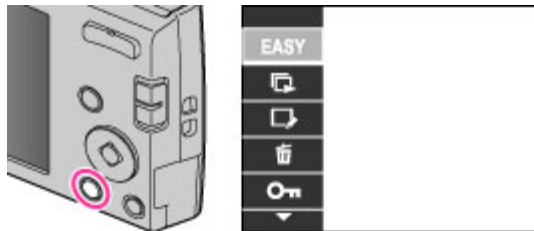

3. Select the desired menu item with  /  /  /  on the control button.

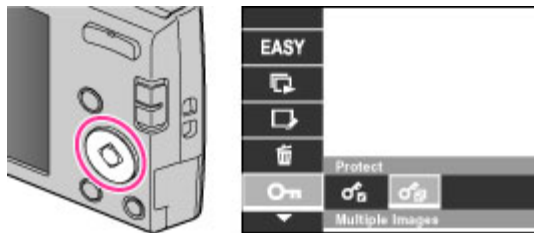

4. Press  on the center of the control button.

[→ Contents list](#)

[▲ Back to top](#)

Copyright 2011 Sony Corporation

▶ Operation Search
▶ Before Use
▶ Shooting
▶ Viewing
▶ Using MENU items (Shooting)
▶ Using MENU items (Viewing)
▶ Changing settings
▶ Viewing images on a TV
▶ Using with your computer
▶ Printing
▶ Troubleshooting
▶ Precautions / About this camera

[→ Contents list](#)

Easy Mode

When viewing still images in Easy Mode, the playback screen text becomes larger, and indicators become easier to see.

1. Press the  (Playback) button to switch to playback mode.
2. MENU → **EASY** (Easy Mode) → [OK] → ● on the control button
 - To exit Easy mode, press the MENU button, then select [Exit Easy Mode].

Notes

- The battery charge is used up more quickly because the screen brightness increases automatically.
- The shooting mode also changes to [Easy Mode].

Viewing functions available in Easy Mode

In Easy Mode, only the deletion function is available.

 (Delete) button	You can delete the currently displayed image. Select [OK] → ● .
MENU button	You can delete the currently displayed image with [1 image], and delete all images in a folder with [All]. Select [Exit Easy Mode] → [OK] to exit Easy Mode.

[▲ Back to top](#)

- ▶ Operation Search
- ▶ Before Use
- ▶ Shooting
- ▶ Viewing
- ▶ Using MENU items (Shooting)
- ▶ Using MENU items (Viewing)
- ▶ Changing settings
- ▶ Viewing images on a TV
- ▶ Using with your computer
- ▶ Printing
- ▶ Troubleshooting
- ▶ Precautions / About this camera

[→ Contents list](#)



Slideshow

▼ Image

▼ Interval

▼ Repeat

Images are automatically played back in succession.

1. Press the  (Playback) button to switch to playback mode.
2. MENU →  (Slideshow) → ● on the control button
3. Select a desired setting.
4. [Start] → ●
5. Press ● to end the slideshow.

Note

- You cannot play back movies or panorama images.

Image

Selects the group of images to be shown.

<input checked="" type="checkbox"/>	All	Plays a slideshow of all the images in order.
<input type="checkbox"/>	Folder	Plays a slideshow of images in the currently selected folder.

Note

- This setting is fixed to [Folder] when the internal memory is used to record images.

Interval

Sets the screen switching interval.

<input type="checkbox"/>	1 sec	Switches the screen at the selected interval.
<input checked="" type="checkbox"/>	3 sec	
<input type="checkbox"/>	5 sec	
<input type="checkbox"/>	10 sec	

Repeat

Turns slideshow repeat on or off.

<input checked="" type="checkbox"/>	On	Plays back images in a continuous loop.
-------------------------------------	----	---

	Off	After all the images have been played back, the slideshow ends.
--	-----	---

[▲ Back to top](#)



Copyright 2011 Sony Corporation





▶ Operation Search
▶ Before Use
▶ Shooting
▶ Viewing
▶ Using MENU items (Shooting)
▶ Using MENU items (Viewing)
▶ Changing settings
▶ Viewing images on a TV
▶ Using with your computer
▶ Printing
▶ Troubleshooting
▶ Precautions / About this camera

[→ Contents list](#)

Retouch

Retouches a recorded image and saves it as a new file. The original image is retained.

1. Press the  (Playback) button to switch to playback mode.
2. MENU →  (Retouch) → desired mode → ● on the control button
3. Perform retouching according to the operation method in each mode.

 (Trimming (Resize))	<p>Records the zoomed playback image.</p>  <ol style="list-style-type: none"> ① Turn the  button to (T) to zoom in and press W to zoom out. ② Set the zoom point with the control button. ③ MENU → select an image size to save → ● ④ [OK] → ● <ul style="list-style-type: none"> • The quality of trimmed images may deteriorate. • The image size that you can trim may vary depending on the image.
 (Red Eye Correction)	<p>Corrects the red-eye phenomenon caused by flash.</p>  <ol style="list-style-type: none"> ① Select [OK] with the control button → ● . <ul style="list-style-type: none"> • You may not be able to correct the red-eye phenomenon depending on the image.

Note

- You cannot retouch the panorama images or movies.



[▲ Back to top](#)



▶ Operation Search
▶ Before Use
▶ Shooting
▶ Viewing
▶ Using MENU items (Shooting)
▶ Using MENU items (Viewing)
▶ Changing settings
▶ Viewing images on a TV
▶ Using with your computer
▶ Printing
▶ Troubleshooting
▶ Precautions / About this camera

[→ Contents list](#)

Delete

Allows you to select unwanted images for deletion. You can also delete images using the  (Delete) button. [\[Details\]](#)

1. Press the  (Playback) button to switch to playback mode.
2. MENU →  (Delete) → desired mode → ● on the control button
3. [OK] → ●

 (This Image)	Deletes the currently displayed image in single-image mode.
 (Multiple Images)	You can select and delete multiple images. Do as the following after step 2. <ol style="list-style-type: none"> ① Select an image then press ● . Repeat the above steps until there are no more images to be deleted. Select an image with a ✓ mark to release the ✓ mark. ② MENU → [OK] → ●
 (All in This Folder)	Deletes all images in the selected folder at once.

Note

- In Easy Mode, you can select between [1 image] or [All].

Related Topic

[Delete button](#)[▲ Back to top](#)



▶ Operation Search
▶ Before Use
▶ Shooting
▶ Viewing
▶ Using MENU items (Shooting)
▶ Using MENU items (Viewing)
▶ Changing settings
▶ Viewing images on a TV
▶ Using with your computer
▶ Printing
▶ Troubleshooting
▶ Precautions / About this camera







[→ Contents list](#)

Protect

Protects recorded images against accidental erasure.

The  mark is displayed for registered images.

1. Press the  (Playback) button to switch to playback mode.
2. MENU →  (Protect) → desired mode →  on the control button

 (This Image)	Protects the currently displayed image in single-image mode.
 (Multiple Images)	<p>You can select and protect multiple images. Do as the following after step 2.</p> <p>① Select an image then press . Repeat the above steps until there are no more images to be protected. Select an image with a  mark to release the  mark.</p> <p>② MENU → [OK] → </p>

To cancel the protection

Select the image for which you want to cancel protection, and unlock it by pressing  on the control button as the same procedure to protect it.

The  indicator disappears, and the protection is released.

[▲ Back to top](#)

▶ Operation Search
▶ Before Use
▶ Shooting
▶ Viewing
▶ Using MENU items (Shooting)
▶ Using MENU items (Viewing)
▶ Changing settings
▶ Viewing images on a TV
▶ Using with your computer
▶ Printing
▶ Troubleshooting
▶ Precautions / About this camera



[→ Contents list](#)

DPOF

DPOF (Digital Print Order Format) is a function that allows you to specify the images of the memory card that you want to print out later.

The **DPOF** (Print order) mark is displayed for registered images.

1. Press the  (Playback) button to switch to playback mode.
2. MENU → **DPOF** → desired mode → ● on the control button

 (This Image)	Orders printing the currently displayed image in single-image mode.
 (Multiple Images)	<p>You can select and order printing multiple images. Do as the following, after step 2.</p> <p>① Select an image then press ● . Repeat the above steps until there are no more images to be printed. Select an image with a ✓ mark to release the ✓ mark.</p> <p>② MENU → [OK] → ●</p>

Notes

- The **DPOF** (Print order) mark cannot be added to the following images:
 - Movies
 - Images in the internal memory
- You can add a **DPOF** (Print order) mark to a maximum 999 images.

Clearing the DPOF mark

Select the image to clear the DPOF registration, then press ● on the control button in the same procedure as when making a **DPOF** mark.

The **DPOF** mark disappears and the DPOF registration is cleared.

Related Topic

[Printing still images](#)

[▲ Back to top](#)

Copyright 2011 Sony Corporation





▶ Operation Search
▶ Before Use
▶ Shooting
▶ Viewing
▶ Using MENU items (Shooting)
▶ Using MENU items (Viewing)
▶ Changing settings
▶ Viewing images on a TV
▶ Using with your computer
▶ Printing
▶ Troubleshooting
▶ Precautions / About this camera

[→ Contents list](#)

Rotate

Rotates a still image. Use this to display a horizontal orientation image in vertical orientation.



1. Press the  (Playback) button to switch to playback mode.
2. MENU →  (Rotate) → ● on the control button
3. Rotate the image with [ / ] → ◀ / ▶ .
4. [OK] → ●

Notes

- You cannot rotate the following images:
 - Movies
 - Protected still images
- You may not be able to rotate images shot with other cameras.
- When viewing images on a computer, the image rotation information may not be reflected depending on the software.

[▲ Back to top](#)



Copyright 2011 Sony Corporation

▶ Operation Search
▶ Before Use
▶ Shooting
▶ Viewing
▶ Using MENU items (Shooting)
▶ Using MENU items (Viewing)
▶ Changing settings
▶ Viewing images on a TV
▶ Using with your computer
▶ Printing
▶ Troubleshooting
▶ Precautions / About this camera

[→ Contents list](#)



Select Folder

When multiple folders are created in a memory card, this selects the folder containing the image you want to play back.

1. Press the  (Playback) button to switch to playback mode.
2. MENU →  (Select Folder) → ● on the control button
3. Select the folder with ◀ / ▶ .
4. [OK] → ●

Viewing images across multiple folders

When multiple folders are created, the following indicators appear on the first and last images in the folder.

- : Moves to the previous folder
- : Moves to the next folder
- : Moves to either the previous or next folders

Note







- This item is not displayed when the internal memory is used to record images.

[▲ Back to top](#)

[Top page](#) > [Using MENU items \(Viewing\)](#) > [Playback MENU list](#) > [MENU items that cannot be set according to recording media](#)

MENU items that cannot be set according to recording media

In the table below, ✓ indicates a user-changeable function, while — indicates an unchangeable one.

Menu items	Memory card	Internal Memory
EASY (Easy Mode)	✓	✓
 (Slideshow)	✓	✓
 (Retouch)	✓	✓
 (Delete)	✓	✓
 (Protect)	✓	✓
DPOF	✓	—
 (Rotate)	✓	✓
 (Select Folder)	✓	—
 (Settings)	✓	✓

Note

- Only the items that are available for each mode are displayed on the screen.

[▲ Back to top](#)

Copyright 2011 Sony Corporation

- ▶ Operation Search
- ▶ Before Use
- ▶ Shooting
- ▶ Viewing
- ▶ Using MENU items (Shooting)
- ▶ Using MENU items (Viewing)
- ▶ Changing settings
- ▶ Viewing images on a TV
- ▶ Using with your computer
- ▶ Printing
- ▶ Troubleshooting
- ▶ Precautions / About this camera



[→ Contents list](#)

Changing camera settings

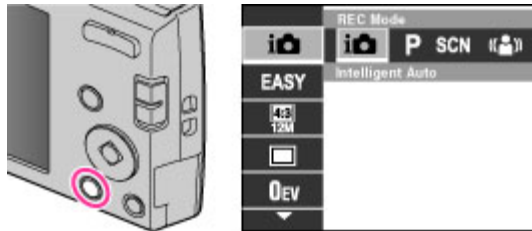

You can change the settings on the  (Settings) screen.

1. Press the MENU button to display the Menu screen.

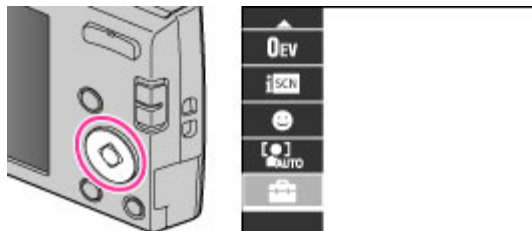

2. Select  (Settings) with  on the control button, then press  on the center of the control button to display the setup screen.



3. Select the desired category using  /  /  /  , then press  .

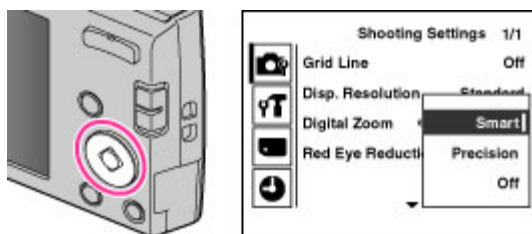

4. Select the desired setting, then press  .

Notes

- [Shooting Settings] appears only when settings have been entered from shooting mode.
- [Memory Card Tool] appears only when a memory card is inserted in the camera, while [Internal Memory Tool] appears only when a memory card is not inserted.

- ▶ Operation Search
- ▶ Before Use
- ▶ Shooting
- ▶ Viewing
- ▶ Using MENU items (Shooting)
- ▶ Using MENU items (Viewing)
- ▶ Changing settings
- ▶ Viewing images on a TV
- ▶ Using with your computer
- ▶ Printing
- ▶ Troubleshooting
- ▶ Precautions / About this camera

[→ Contents list](#)



[▲ Back to top](#)

▶ Operation Search
▶ Before Use
▶ Shooting
▶ Viewing
▶ Using MENU items (Shooting)
▶ Using MENU items (Viewing)
▶ Changing settings
▶ Viewing images on a TV
▶ Using with your computer
▶ Printing
▶ Troubleshooting
▶ Precautions / About this camera

[→ Contents list](#)

Grid Line

With reference to the grid lines, you can easily set a subject in a horizontal / vertical position.

1. Set the camera to shooting mode.
2. MENU →  (Settings) →  (Shooting Settings) → [Grid Line] → desired mode →



<input type="checkbox"/>	On	Displays the grid lines. The grid lines are not recorded.
<input checked="" type="checkbox"/>	Off	Does not display the grid lines.



[▲ Back to top](#)

▶ Operation Search
▶ Before Use
▶ Shooting
▶ Viewing
▶ Using MENU items (Shooting)
▶ Using MENU items (Viewing)
▶ Changing settings
▶ Viewing images on a TV
▶ Using with your computer
▶ Printing
▶ Troubleshooting
▶ Precautions / About this camera

[→ Contents list](#)

Disp. Resolution

Selects the display quality on the LCD screen for shooting.

1. Set the camera to shooting mode.
2. MENU →  (Settings) →  (Shooting Settings) → [Disp. Resolution] → desired mode → ●

	High	Displays a high-quality image for shooting.
<input checked="" type="checkbox"/>	Standard	Displays a standard-quality image for shooting.

Notes

- The battery charge is used up more quickly when [Disp. Resolution] is set to [High].
- In Sweep Panorama and Movie Mode, [Disp. Resolution] is set to [High].



[▲ Back to top](#)

▶ Operation Search
▶ Before Use
▶ Shooting
▶ Viewing
▶ Using MENU items (Shooting)
▶ Using MENU items (Viewing)
▶ Changing settings
▶ Viewing images on a TV
▶ Using with your computer
▶ Printing
▶ Troubleshooting
▶ Precautions / About this camera

[→ Contents list](#)

Digital Zoom

Selects the digital zoom mode. The camera enlarges the image using optical zoom (up to 4×). When the zoom scale is exceeded, the camera uses either smart or precision digital zoom.

1. Set the camera to shooting mode.
2. MENU →  (Settings) →  (Shooting Settings) → [Digital Zoom] → desired mode
→ ●

	Smart (SQ)	Enlarges the image digitally within the range where the image will not be distorted, according to the image size (Smart zoom).
	Precision (PQ)	Enlarges all image sizes by the total zoom scale of approximately 8×, including the optical zoom 4×. However, note that the image quality deteriorates when the optical zoom scale is exceeded (Precision digital zoom).
	Off	Does not use the digital zoom.

Notes

- The Digital Zoom function does not operate in the following situations:
 - In Sweep Panorama mode
 - In Movie Mode
 - When the Smile Shutter function is activated.
 - When [Self-Timer] is set to [Self-portrait One Person] or [Self-portrait Two People].
- The smart zoom is not available when the image size is set to [12M] or [16:9(9M)].
- The Face Detection function does not work when using the digital zoom.

Total zoom scale when using Smart zoom (including optical zoom 4×)

The supported zoom ratio differs depending on the image size.

Size	Total zoom scale
8M	Approx. ×4.9
5M	Approx. ×6.2
VGA	Approx. ×25
16:9(2M)	Approx. ×8.3



[▲ Back to top](#)

▶ Operation Search
▶ Before Use
▶ Shooting
▶ Viewing
▶ Using MENU items (Shooting)
▶ Using MENU items (Viewing)
▶ Changing settings
▶ Viewing images on a TV
▶ Using with your computer
▶ Printing
▶ Troubleshooting
▶ Precautions / About this camera

[→ Contents list](#)

Red Eye Reduction

The flash strobos two or more times before shooting to reduce the red-eye phenomenon when using the flash.

1. Set the camera to shooting mode.
2. MENU →  (Settings) →  (Shooting Settings) → [Red Eye Reduction] → desired mode → ●

<input checked="" type="checkbox"/>	Auto	When the Face Detection function is activated, the flash strobos automatically to reduce the red-eye phenomenon.
<input type="checkbox"/>	On	The flash always strobos to reduce the red-eye phenomenon.
<input type="checkbox"/>	Off	Does not use Red Eye Reduction.

What causes the red-eye phenomenon?

Pupils become dilated in dark environments. Flash light is reflected off the blood vessels at the back of the eye (retina) (A), causing the “red-eye” phenomenon.

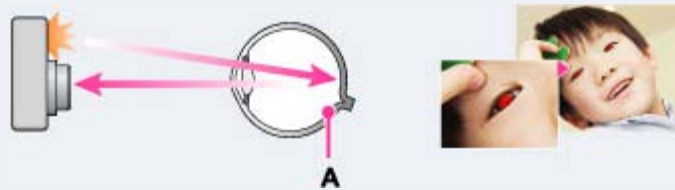

Other ways to reduce red-eye

- Select **ISO** (High Sensitivity) mode in Scene Selection. (The flash is set to [Off] automatically.)
- When the eyes of the subject turn out red, correct the image with [Retouch] → [Red Eye Correction] on the viewing menu or with the supplied software “PMB”.

Notes

- To avoid blurring of images, hold the camera firmly until the shutter is released. It usually takes a second until the shutter is released, and also be sure not to allow the subject to move during this period.
- Red Eye Reduction may not produce the desired effects. It depends on individual differences and conditions, such as distance to the subject, or if the subject looked away from the pre-strobe.
- If you do not use the Face Detection function, Red Eye Reduction does not work, even when you select [Auto].
- [Red Eye Reduction] is set to [Off] in the following situations:
 - When **ISO** (High Sensitivity) mode is selected in Scene Selection.
 - When Smile Shutter function is activated.

[▲ Back to top](#)

▶ Operation Search
▶ Before Use
▶ Shooting
▶ Viewing
▶ Using MENU items (Shooting)
▶ Using MENU items (Viewing)
▶ Changing settings
▶ Viewing images on a TV
▶ Using with your computer
▶ Printing
▶ Troubleshooting
▶ Precautions / About this camera

[→ Contents list](#)

Beep

Selects the sound produced when you operate the camera.

1. MENU →  (Settings) →  (Main Settings) → [Beep] → desired mode → ●

	Shutter	Turns on the shutter sound when you press the shutter button.
<input checked="" type="checkbox"/>	High	Turns on the beep / shutter sound when you press the control / shutter button. If you want to lower the beep volume, select [Low].
	Low	
	Off	Turns off the beep / shutter sound.



[▲ Back to top](#)

▶ Operation Search
▶ Before Use
▶ Shooting
▶ Viewing
▶ Using MENU items (Shooting)
▶ Using MENU items (Viewing)
▶ Changing settings
▶ Viewing images on a TV
▶ Using with your computer
▶ Printing
▶ Troubleshooting
▶ Precautions / About this camera

[→ Contents list](#)

Language Setting

Selects the language to be used in the menu items, warnings and messages.

1. MENU →  (Settings) →  (Main Settings) → [Language Setting] → desired mode
→ ●



[▲ Back to top](#)

- ▶ Operation Search
- ▶ Before Use
- ▶ Shooting
- ▶ Viewing
- ▶ Using MENU items (Shooting)
- ▶ Using MENU items (Viewing)
- ▶ Changing settings
- ▶ Viewing images on a TV
- ▶ Using with your computer
- ▶ Printing
- ▶ Troubleshooting
- ▶ Precautions / About this camera

[→ Contents list](#)

Function Guide

You can select whether or not the function guide is displayed when you operate the camera.

1. MENU →  (Settings) →  (Main Settings) → [Function Guide] → desired mode
→ ●

<input checked="" type="checkbox"/>	On	Displays the function guide.
<input type="checkbox"/>	Off	Does not display the function guide.



[▲ Back to top](#)

- ▶ Operation Search
- ▶ Before Use
- ▶ Shooting
- ▶ Viewing
- ▶ Using MENU items (Shooting)
- ▶ Using MENU items (Viewing)
- ▶ Changing settings
- ▶ Viewing images on a TV
- ▶ Using with your computer
- ▶ Printing
- ▶ Troubleshooting
- ▶ Precautions / About this camera

[→ Contents list](#)

Display color

Sets the color of the screen display.

1. MENU →  (Settings) →  (Main Settings) → [Display color] → desired mode →



<input checked="" type="checkbox"/>	Black	Sets the background color of the LCD screen.
<input type="checkbox"/>	White	
<input type="checkbox"/>	Pink	

[▲ Back to top](#)

- ▶ Operation Search
- ▶ Before Use
- ▶ Shooting
- ▶ Viewing
- ▶ Using MENU items (Shooting)
- ▶ Using MENU items (Viewing)
- ▶ Changing settings
- ▶ Viewing images on a TV
- ▶ Using with your computer
- ▶ Printing
- ▶ Troubleshooting
- ▶ Precautions / About this camera

[→ Contents list](#)

Power Save

Sets the time until the camera turns off.

If you do not operate the camera running on a battery pack for a certain amount of time, the camera automatically turns off to prevent wearing down the battery pack (Auto Power off).

1. MENU →  (Settings) →  (Main Settings) → [Power Save] → desired mode →



	Stamina	The camera turns off after about 1 minute of no operation.
<input checked="" type="checkbox"/>	Standard	The camera turns off after about 2 minutes of no operation.
	Off	The camera does not turn off automatically.



[▲ Back to top](#)

▶ Operation Search
▶ Before Use
▶ Shooting
▶ Viewing
▶ Using MENU items (Shooting)
▶ Using MENU items (Viewing)
▶ Changing settings
▶ Viewing images on a TV
▶ Using with your computer
▶ Printing
▶ Troubleshooting
▶ Precautions / About this camera

[→ Contents list](#)

Initialize

Initializes the setting to the default setting.
Even if you execute this function, the images are retained.

1. MENU →  (Settings) →  (Main Settings) → [Initialize] → [OK] → ●

Note

- Be sure not to turn off the camera while initializing.

[▲ Back to top](#)

- ▶ Operation Search
- ▶ Before Use
- ▶ Shooting
- ▶ Viewing
- ▶ Using MENU items (Shooting)
- ▶ Using MENU items (Viewing)
- ▶ Changing settings
- ▶ Viewing images on a TV
- ▶ Using with your computer
- ▶ Printing
- ▶ Troubleshooting
- ▶ Precautions / About this camera

[→ Contents list](#)

Video Out

Sets the video signal output according to the TV color system of the connected video equipment. The TV color systems differ depending on the country and region.

To view images on a TV screen, check the TV color system of the country or region of use.

[\[Details\]](#)

1. MENU →  (Settings) →  (Main Settings) → [Video Out] → desired mode → ●

NTSC	Sets the video output signal to NTSC mode (e.g., for the USA, Japan).
PAL	Sets the video output signal to PAL mode (e.g., for Europe, China).



[▲ Back to top](#)

- ▶ Operation Search
- ▶ Before Use
- ▶ Shooting
- ▶ Viewing
- ▶ Using MENU items (Shooting)
- ▶ Using MENU items (Viewing)
- ▶ Changing settings
- ▶ Viewing images on a TV
- ▶ Using with your computer
- ▶ Printing
- ▶ Troubleshooting
- ▶ Precautions / About this camera

[→ Contents list](#)

USB Connect

Selects the USB mode when connecting the camera to a computer or a USB device using the dedicated USB cable.

1. MENU →  (Settings) →  (Main Settings) → [USB Connect] → desired mode → 

<input checked="" type="checkbox"/>	Mass Storage	Establishes a Mass Storage connection between the camera and a computer or other USB device.
<input type="checkbox"/>	PTP/MTP	When you connect the camera to a computer, the AutoPlay Wizard appears, and the still images in the recording folder on the camera are imported to the computer. (with Windows 7 / Vista / XP, Mac OS X)

Note

- When [USB Connect] is set to [PTP/MTP], you cannot export movies to a computer. To export movies to a computer, set [USB Connect] to [Mass Storage].

[▲ Back to top](#)

▶ Operation Search
▶ Before Use
▶ Shooting
▶ Viewing
▶ Using MENU items (Shooting)
▶ Using MENU items (Viewing)
▶ Changing settings
▶ Viewing images on a TV
▶ Using with your computer
▶ Printing
▶ Troubleshooting
▶ Precautions / About this camera

[→ Contents list](#)

LUN Setting

Sets the display method for the recording media displayed on a computer screen or other monitor when the camera is connected with a computer or AV component using a USB connection.

1. MENU →  (Settings) →  (Main Settings) → [LUN Setting] → desired mode →



<input checked="" type="checkbox"/>	Multi	The images both on the memory card and in the internal memory are displayed. Select this setting when you connect the camera to a computer.
<input type="checkbox"/>	Single	When the memory card is inserted into the camera, the images on the memory card are displayed; when it is not inserted, the images in the internal memory are displayed. Select this setting in cases where the images of both the memory card and the internal memory are not displayed when the camera is connected to a device other than a computer.

Note

- Set [LUN Setting] to [Multi] when uploading images to a media service using “PMB Portable”.



[▲ Back to top](#)

▶ Operation Search
▶ Before Use
▶ Shooting
▶ Viewing
▶ Using MENU items (Shooting)
▶ Using MENU items (Viewing)
▶ Changing settings
▶ Viewing images on a TV
▶ Using with your computer
▶ Printing
▶ Troubleshooting
▶ Precautions / About this camera

[→ Contents list](#)

Format

Formats the memory card or the internal memory. When you use a memory card with this camera for the first time, it is recommended to format the card using the camera for stable performance of the memory card before shooting. Note that formatting permanently erases all data on the memory card, and is unrecoverable. Save precious data on a computer, etc.

1. MENU →  (Settings) →  (Memory Card Tool) or  (Internal Memory Tool) → [Format] → [OK] → ●

Note



- Note that formatting permanently erases all data including even protected images.

[▲ Back to top](#)

Create REC. Folder

Creates a folder in a memory card for recording images.

Images are recorded in the newly created folder until you create another folder or select another recording folder.

1. MENU →  (Settings) →  (Memory Card Tool) → [Create REC. Folder] → [OK] → ●

On the folders

After a new folder is created, you can change the storage destination folder [\[Details\]](#) and select the folder for viewing images. [\[Details\]](#)

Notes

- This item is not displayed when the internal memory is used to record images.
- When you insert a memory card that was used with other equipment into the camera and shoot images, a new folder may be automatically created.
- Up to 4,000 images can be stored in one folder. When the folder capacity is exceeded, a new folder is automatically created.

▶ Operation Search
▶ Before Use
▶ Shooting
▶ Viewing
▶ Using MENU items (Shooting)
▶ Using MENU items (Viewing)
▶ Changing settings
▶ Viewing images on a TV
▶ Using with your computer
▶ Printing
▶ Troubleshooting
▶ Precautions / About this camera



→ [Contents list](#)

[▲ Back to top](#)

[Top page](#) > [Changing settings](#) > [Memory Card Tool / Internal Memory Tool](#) > [Change REC. Folder](#)

Change REC. Folder

Changes the folder in the memory card that is currently used for recording images.

1. MENU →  (Settings) →  (Memory Card Tool) → [Change REC. Folder]
2. Select a folder with ◀ / ▶ on the control button.
3. [OK] → ●

Notes

- This item is not displayed when the internal memory is used to record images.
- You cannot select the “100” folder as a recording folder.
- You cannot move recorded images to another folder.

[▲ Back to top](#)



▶ Operation Search
▶ Before Use
▶ Shooting
▶ Viewing
▶ Using MENU items (Shooting)
▶ Using MENU items (Viewing)
▶ Changing settings
▶ Viewing images on a TV
▶ Using with your computer
▶ Printing
▶ Troubleshooting
▶ Precautions / About this camera

[→ Contents list](#)

Copyright 2011 Sony Corporation

Delete REC. Folder

Deletes a folder for recording images in a memory card.

1. MENU →  (Settings) →  (Memory Card Tool) → [Delete REC. Folder]
2. Select a folder with ◀ / ▶ on the control button.
3. [OK] → ●

Notes

- This item is not displayed when the internal memory is used to record images.
- If you delete the folder set as the recording folder using [Delete REC. Folder], the folder that has the largest folder number is selected as the next recording folder.
- You can delete only empty folders. If a folder contains images, or files that cannot be played back by the camera, first delete these images and files using a computer, and then delete the folder.

▶ Operation Search
▶ Before Use
▶ Shooting
▶ Viewing
▶ Using MENU items (Shooting)
▶ Using MENU items (Viewing)
▶ Changing settings
▶ Viewing images on a TV
▶ Using with your computer
▶ Printing
▶ Troubleshooting
▶ Precautions / About this camera

[→ Contents list](#)



[▲ Back to top](#)

▶ Operation Search
▶ Before Use
▶ Shooting
▶ Viewing
▶ Using MENU items (Shooting)
▶ Using MENU items (Viewing)
▶ Changing settings
▶ Viewing images on a TV
▶ Using with your computer
▶ Printing
▶ Troubleshooting
▶ Precautions / About this camera

[→ Contents list](#)

Copy

Copies all images in the internal memory to a memory card.

1. Insert a memory card with sufficient free capacity into the camera.
2. MENU →  (Settings) →  (Memory Card Tool) → [Copy] → [OK] → ●

Notes

- Use a fully charged battery pack. If you attempt to copy image files using a battery pack with little remaining charge, the battery pack may run out, causing copying to fail or possibly corrupting the data.
- Images cannot be copied individually.
- The original images in the internal memory are retained even after copying. To delete the contents of the internal memory, remove the memory card after copying, then format the internal memory ([Format] in [Internal Memory Tool]).
- A new folder is created on the memory card and all the data will be copied to it. You cannot choose a specific folder and copy images to it.



[▲ Back to top](#)

- ▶ Operation Search
- ▶ Before Use
- ▶ Shooting
- ▶ Viewing
- ▶ Using MENU items (Shooting)
- ▶ Using MENU items (Viewing)
- ▶ Changing settings
- ▶ Viewing images on a TV
- ▶ Using with your computer
- ▶ Printing
- ▶ Troubleshooting
- ▶ Precautions / About this camera

[→ Contents list](#)

File Number

Selects the method used to assign file numbers to images.

1. MENU →  (Settings) →  (Memory Card Tool) or  (Internal Memory Tool) → [File Number] → desired mode → ●

<input checked="" type="checkbox"/>	Series	Assigns numbers to files in sequence even if the recording folder or the memory card is changed. (When the replaced memory card contains a file with a number higher than the last assigned number, a number one higher than the largest number is assigned.)
<input type="checkbox"/>	Reset	Starts from 0001 each time the folder is changed. (When the recording folder contains a file, a number one higher than the largest number is assigned.)

[▲ Back to top](#)

▶ Operation Search
▶ Before Use
▶ Shooting
▶ Viewing
▶ Using MENU items (Shooting)
▶ Using MENU items (Viewing)
▶ Changing settings
▶ Viewing images on a TV
▶ Using with your computer
▶ Printing
▶ Troubleshooting
▶ Precautions / About this camera

[→ Contents list](#)

Area Setting

Adjusts the time to the local time of a selected area.

1. MENU →  (Settings) →  (Clock Settings) → [Area Setting] → desired setting →





<input checked="" type="checkbox"/>	Home	You use the camera in your area. When the currently set area differs from your home area, you must make the Area Setting.
<input type="checkbox"/>	Destination	You use the camera set to the time at your destination. Set the destination area.

Changing Area Setting

Setting a frequently visited destination lets you easily adjust the time when you visit that destination.

1. Select the area part for [Destination], then press .



2. Select an area with  /  on the control button, and select Daylight Savings time with  / .



[▲ Back to top](#)

- ▶ Operation Search
- ▶ Before Use
- ▶ Shooting
- ▶ Viewing
- ▶ Using MENU items (Shooting)
- ▶ Using MENU items (Viewing)
- ▶ Changing settings
- ▶ Viewing images on a TV
- ▶ Using with your computer
- ▶ Printing
- ▶ Troubleshooting
- ▶ Precautions / About this camera

[→ Contents list](#)

Date & Time Setting

Sets the date and time again.

1. MENU →  (Settings) →  (Clock Settings) → [Date & Time Setting] → desired setting → ●
2. Set the numeric value and desired setting with ▲ / ▼ / ◀ / ▶ on the control button.
3. [OK] → ●

Date & Time Format	You can select the date and time display format.
Daylight Savings	You can select Daylight Savings [On] / [Off].
Date & Time	You can set the date and time.

Note

- The camera does not have a feature for superimposing dates on images. By using “PMB” in the CD-ROM (supplied), you can print or save images with the date.

[▲ Back to top](#)

[Top page](#) > [Viewing images on a TV](#) > [Viewing an image on a Standard Definition \(SD\) TV](#) > [Viewing an image on a Standard Definition \(SD\) TV](#)

Viewing an image on a Standard Definition (SD) TV

You can view images recorded on the camera in standard picture quality by connecting the camera to a Standard Definition (SD) TV. Refer also to the operating instructions supplied with the TV.

1. Turn off both the camera and the TV.
2. Connect the A/V OUT jack of the camera (A) and the audio / video input jacks on the TV (B) using the dedicated AV cable (sold separately) (C).

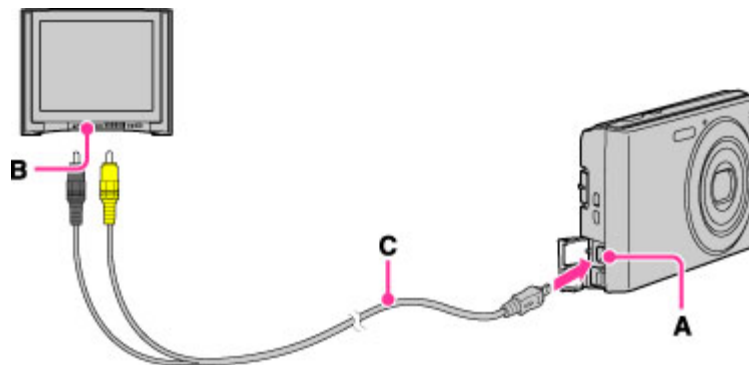

3. Turn on the TV and set the input.
4. Press  (Playback) button to turn on the camera. Images shot with the camera appear on the TV. Select the desired image with the control button.

Notes

- When using the camera abroad, it may be necessary to switch [Video Out]. [\[Details\]](#)
- During output to TV, [Easy Mode] is invalid.
- To purchase the dedicated AV cable, consult your nearest Sony dealer, stating the product name (VMC-15CSR1).

- ▶ Operation Search
- ▶ Before Use
- ▶ Shooting
- ▶ Viewing
- ▶ Using MENU items (Shooting)
- ▶ Using MENU items (Viewing)
- ▶ Changing settings
- ▶ Viewing images on a TV
- ▶ Using with your computer
- ▶ Printing
- ▶ Troubleshooting
- ▶ Precautions / About this camera

[→ Contents list](#)

[▲ Back to top](#)

Copyright 2011 Sony Corporation

[Top page](#) > [Using with your computer](#) > [Recommended computer environment](#) > [Recommended computer environment \(Windows\)](#)

Recommended computer environment (Windows)

The following computer environment is recommended when using the supplied software “PMB” or “PMB Portable”, and importing images via a USB connection.

OS (pre-installed)	Microsoft Windows XP* ¹ SP3 / Windows Vista* ² SP2 / Windows 7
Others	CPU: Intel Pentium III 800 MHz or faster Memory: 512 MB or more Hard Disk: Disk space required for installation—approximately 500 MB Display: Screen resolution: 1,024 × 768 dots or more

*¹ 64-bit editions and Starter (Edition) are not supported.

*² Starter (Edition) is not supported.

Notes

- Operation is not assured in an environment based on an upgrade of the operating systems described above or in a multi-boot environment.
- If you connect two or more USB devices to a single computer at the same time, some devices, including the camera, may not operate, depending on the types of USB devices you are using.
- Connecting the camera using a USB interface that is compatible with Hi-Speed USB (USB 2.0) allows advanced transfer (high speed transfer), as the camera is compatible with Hi-Speed USB (USB 2.0).
- When your computer resumes activity from suspend or sleep mode, communication between the camera and your computer may not recover at the same time.

▶ Operation Search
▶ Before Use
▶ Shooting
▶ Viewing
▶ Using MENU items (Shooting)
▶ Using MENU items (Viewing)
▶ Changing settings
▶ Viewing images on a TV
▶ Using with your computer
▶ Printing
▶ Troubleshooting
▶ Precautions / About this camera

[→ Contents list](#)

[▲ Back to top](#)

Copyright 2011 Sony Corporation

[Top page](#) > [Using with your computer](#) > [Recommended computer environment](#) > [Recommended computer environment \(Macintosh\)](#)

Recommended computer environment (Macintosh)

The following computer environment is recommended when using the supplied software “PMB Portable” and importing images via a USB connection.

OS (pre-installed)	USB Connection: Mac OS X (v10.3 to v10.6) PMB Portable: Mac OS X* (v10.4 to v10.6)
--------------------	---

* Equipped with Intel processor

Notes

- Operation is not assured in an environment based on an upgrade of the operating systems described above or in a multi-boot environment.
- If you connect two or more USB devices to a single computer at the same time, some devices, including the camera, may not operate, depending on the types of USB devices you are using.
- Connecting the camera using a USB interface that is compatible with Hi-Speed USB (USB 2.0) allows advanced transfer (high speed transfer), as the camera is compatible with Hi-Speed USB (USB 2.0).
- When your computer resumes activity from suspend or sleep mode, communication between the camera and your computer may not recover at the same time.

[▲ Back to top](#)

Copyright 2011 Sony Corporation

▶ Operation Search
▶ Before Use
▶ Shooting
▶ Viewing
▶ Using MENU items (Shooting)
▶ Using MENU items (Viewing)
▶ Changing settings
▶ Viewing images on a TV
▶ Using with your computer
▶ Printing
▶ Troubleshooting
▶ Precautions / About this camera

[→ Contents list](#)

[Top page](#) > [Using with your computer](#) > [Using the software](#) > "PMB (Picture Motion Browser)"

"PMB (Picture Motion Browser)"

- "PMB" allows you to import images shot with the camera to a computer for display. Make a USB connection between the camera and your computer, and click [Import].
- Images on a computer can be exported to a memory card, and displayed on the camera. Make a USB connection between the camera and your computer, click [Export] → [Export Media Files] in the [Manipulate] menu, and click [Export].
- You can save and print images with the date.
- You can display images stored on a computer by shooting date in a calendar display.
- You can correct (Red Eye Reduction, etc.) still images, and change the shooting date and time.
- You can upload images to a network service. (An internet connection environment is required.)
- For other details, see  (PMB Help).

[▲ Back to top](#)

▶ Operation Search
▶ Before Use
▶ Shooting
▶ Viewing
▶ Using MENU items (Shooting)
▶ Using MENU items (Viewing)
▶ Changing settings
▶ Viewing images on a TV
▶ Using with your computer
▶ Printing
▶ Troubleshooting
▶ Precautions / About this camera





[→ Contents list](#)

Copyright 2011 Sony Corporation

▶ Operation Search
▶ Before Use
▶ Shooting
▶ Viewing
▶ Using MENU items (Shooting)
▶ Using MENU items (Viewing)
▶ Changing settings
▶ Viewing images on a TV
▶ Using with your computer
▶ Printing
▶ Troubleshooting
▶ Precautions / About this camera

[→ Contents list](#)

Installing "PMB" (Windows)

- Turn on your computer and insert the CD-ROM (supplied) into the CD-ROM drive. The installation menu screen appears.
 - If it does not appear, double-click [Computer] (in Windows XP, [My Computer]) →  (SONYPMB).
 - If the AutoPlay screen appears, select "Run Install.exe" and follow the instructions that appear on the screen to proceed with the installation.
- Click [Install].
The "Choose Setup Language" screen appears.
- Select the desired language, then proceed to the following screen.
The "License Agreement" screen appears.
- Carefully read the agreement, click the radio button (→) to accept the terms of the agreement, and then click [Next].
- Follow the instructions on the screen to complete the installation.
 - For the installation, connect the camera to the computer during the procedure. [\[Details\]](#)
 - When the restarting confirmation message appears, restart the computer following the instructions on the screen.
 - DirectX may be installed depending on the system environment of your computer.
- Remove the CD-ROM after the installation is complete.
- Start up the software.
 - To start up "PMB," click  (PMB) on the desktop.
For the detailed operation method, see the following PMB support page (English only): <http://www.sony.co.jp/pmb-se>
or click  (PMB Help).
 - To start up "PMB" from the Start menu, select [Start] → [All Programs] →  (PMB).
 - If "PMB" was installed on your computer and if you re-install "PMB" using the supplied CD-ROM, you can start up all the applications from "PMB Launcher." To start up "PMB Launcher," double-click  (PMB Launcher) on the desktop.

Notes

- Log on as Administrator.
- If "PMB" has been already installed on your computer and that "PMB" version number is lower than that of the supplied CD-ROM, re-install "PMB" using the supplied CD-ROM.
- If the version number is higher than that of the supplied CD-ROM, you do not need to re-install "PMB". When you connect the camera and the computer via USB cable, the available "PMB" function is activated.
- If "PMB" has already been installed on your computer and that "PMB" version number is lower than 5.0, some functions may become invalid after you install "PMB" using the supplied CD-ROM. Also, you can start up "PMB" or other various software from "PMB Launcher" installed at the same time. To start up "PMB Launcher," double-click  (PMB Launcher) on the desktop.

[▲ Back to top](#)

[Top page](#) > [Using with your computer](#) > [Connecting the camera to the computer](#) > [Connecting the camera to the computer](#)

Connecting the camera to the computer

1. Insert a sufficiently charged battery pack into the camera.
2. Turn on the computer, then press  (Playback) button.
3. Connect the camera to your computer using a dedicated USB cable (A).
 - When a USB connection is established for the first time, your computer automatically runs a program to recognize the camera. Wait for a while.

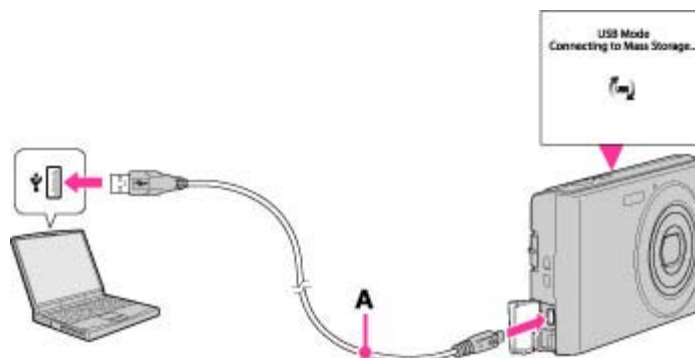

[→ Contents list](#)

Related Topic

[USB Connect](#)

[LUN Setting](#)

[▲ Back to top](#)

Copyright 2011 Sony Corporation

[Top page](#) > [Using with your computer](#) > [Connecting the camera to the computer](#) > [Importing images to a computer \(Windows\)](#)

Importing images to a computer (Windows)

“PMB” allows you to easily import images.
For details on “PMB” functions, see the “PMB Help”.

Importing images to a computer without using “PMB”

When the AutoPlay Wizard appears after making a USB connection between the camera and a computer, click [Open folder to view files] → [OK] → [DCIM] → copy the desired images to the computer.

[▲ Back to top](#)

- ▶ Operation Search
- ▶ Before Use
- ▶ Shooting
- ▶ Viewing
- ▶ Using MENU items (Shooting)
- ▶ Using MENU items (Viewing)
- ▶ Changing settings
- ▶ Viewing images on a TV
- ▶ Using with your computer
- ▶ Printing
- ▶ Troubleshooting
- ▶ Precautions / About this camera

[→ Contents list](#)

Copyright 2011 Sony Corporation

[Top page](#) > [Using with your computer](#) > [Connecting the camera to the computer](#) > [Importing images to a computer \(Macintosh\)](#)

Importing images to a computer (Macintosh)

1. Connect the camera to your Macintosh computer first. Double-click the newly recognized icon on the desktop → the folder where the images you want to import are stored.
2. Drag and drop the image files to the hard disk icon.
The image files are copied to the hard disk.
3. Double-click the hard disk icon → the desired image file in the folder containing the copied files.
The image is displayed.

[▲ Back to top](#)

▶ Operation Search
▶ Before Use
▶ Shooting
▶ Viewing
▶ Using MENU items (Shooting)
▶ Using MENU items (Viewing)
▶ Changing settings
▶ Viewing images on a TV
▶ Using with your computer
▶ Printing
▶ Troubleshooting
▶ Precautions / About this camera

[→ Contents list](#)

Copyright 2011 Sony Corporation

[Top page](#) > [Using with your computer](#) > [Connecting the camera to the computer](#) > [Deleting the USB connection](#)

Deleting the USB connection

Perform the procedures from step 1 to 3 below before:

- Disconnecting the dedicated USB cable.
- Removing a memory card.
- Inserting a memory card into the camera after copying images from the internal memory.
- Turning off the camera.

1. Double-click the disconnect icon () on the tasktray.

Windows Vista



Windows XP



2. Click  (USB Mass Storage Device) → [Stop].

3. Confirm the device on the confirmation window, then click [OK].

Note

- Drag and drop the icon of the memory card or the drive icon to the “Trash” icon beforehand when you use a Macintosh computer, and the camera is disconnected from the computer.

[▲ Back to top](#)

Copyright 2011 Sony Corporation

▶ Operation Search
▶ Before Use
▶ Shooting
▶ Viewing
▶ Using MENU items (Shooting)
▶ Using MENU items (Viewing)
▶ Changing settings
▶ Viewing images on a TV
▶ Using with your computer
▶ Printing
▶ Troubleshooting
▶ Precautions / About this camera

[→ Contents list](#)

▶ Operation Search
▶ Before Use
▶ Shooting
▶ Viewing
▶ Using MENU items (Shooting)
▶ Using MENU items (Viewing)
▶ Changing settings
▶ Viewing images on a TV
▶ Using with your computer
▶ Printing
▶ Troubleshooting
▶ Precautions / About this camera

[→ Contents list](#)

"PMB Portable"

This camera has a built-in application "PMB Portable".

You can use this application to do the following:

- You can easily upload images to a blog or other media service.
- You can upload images from a computer connected to the Internet even when you are away from home or the office.
- You can easily register the media services (such as blogs) you use frequently.

For details on "PMB Portable", see the "PMB Portable" help.

Notes on "PMB Portable"

"PMB Portable" makes it possible to download the URLs of a number of websites from the server administered by Sony (the "Sony server").

In order to use "PMB Portable" to enjoy the benefits of the image uploading service or other services (the "services") provided by these and other websites, you must consent to the following.

- Some websites require registration procedures and / or fees to use their services. In using such services, you must comply with the terms and conditions established by the websites concerned.
- Services may be terminated or changed in accordance with the convenience of the website operators. Sony will not be held responsible for any trouble occurring between the users and third parties or any inconvenience caused to users relating to the utilization of the services inclusive of the termination of or changes to such services.
- To view a website, you will be redirected to it by the Sony server. There may be times when you cannot access the website because of server maintenance or for other reasons.
- If the operation of the Sony server is to be terminated, you will be notified of the termination ahead of time on Sony's website, etc.
- The URLs to which you are redirected by the Sony server and other information may be recorded for the purposes of improving Sony's future products and services. However, no personal data will be recorded on such occasions.

[▲ Back to top](#)

[Top page](#) > [Using with your computer](#) > [Uploading images to a media service](#) > [Starting up "PMB Portable" \(Windows\)](#)

Starting up "PMB Portable" (Windows)

For Windows, when using "PMB Portable" for the first time, you must select the language. Follow the procedure below to make the selection. Once the language selection has been made, steps 3 to 5 are unnecessary the next time you use "PMB Portable".

1. Make a USB connection between the camera and a computer.
When you connect the camera and your computer, the AutoPlay Wizard appears.
Click [x] to close any unnecessary drives.
 - If the desired AutoPlay Wizard does not appear, click [Computer] (in Windows XP, [My Computer]) → [PMBPORTABLE], then double-click "PMBP_Win.exe".
2. Click "PMB Portable".
(In Windows XP, click "PMB Portable" → [OK].)
 - If [PMB Portable] is not displayed within the AutoPlay Wizard, click [Computer] → [PMBPORTABLE], then double-click "PMBP_Win.exe".The Language Selection screen appears.
3. Select the desired language, then click [OK].
The Region Selection screen appears.
4. Select the appropriate [Region] and [Country/Area], and then click [OK].
The User Agreement screen appears.
5. Read the agreement carefully. If you accept the terms of the agreement, click [I Agree].
"PMB Portable" starts up.

Notes

- Set [LUN Setting] in [Main Settings] to [Multi].
- Always connect to a network when using "PMB Portable".
- When uploading images over the Internet, the cache may remain in the computer being used depending on the service provider. This is also true when this product is used for this purpose.
- When a bug occurs in "PMB Portable" or you delete "PMB Portable" by mistake, you can recover "PMB Portable" by downloading the PMB Portable installer from the website.

▶ Operation Search
▶ Before Use
▶ Shooting
▶ Viewing
▶ Using MENU items (Shooting)
▶ Using MENU items (Viewing)
▶ Changing settings
▶ Viewing images on a TV
▶ Using with your computer
▶ Printing
▶ Troubleshooting
▶ Precautions / About this camera

[→ Contents list](#)

[▲ Back to top](#)

Copyright 2011 Sony Corporation

[Top page](#) > [Using with your computer](#) > [Uploading images to a media service](#) > [Starting up "PMB Portable" \(Macintosh\)](#)

Starting up "PMB Portable" (Macintosh)

For Macintosh, when using "PMB Portable" for the first time, you must install it and select the region. Follow the on-screen instructions to install "PMB Portable" and perform the procedure below. Once region selection has been made, steps 3 and 4 are unnecessary the next time you use "PMB Portable".

1. Make a USB connection between the camera and a Macintosh computer.
When you connect the camera and your computer, [PMBPORTABLE] appears on the desktop.
Click [x] to close any unnecessary drives.
2. Click [PMBP_Mac] in the [PMBPORTABLE] folder.
The Region Selection screen appears.
3. Select the appropriate [Region] and [Country/Area], and then click [OK].
The User Agreement screen appears.
4. Read the agreement carefully. If you accept the terms of the agreement, click [I Agree].
"PMB Portable" starts up.

Notes

- Set [LUN Setting] in [Main Settings] to [Multi].
- Always connect to a network when using "PMB Portable".
- When uploading images over the Internet, the cache may remain in the computer being used depending on the service provider. This is also true when this product is used for this purpose.
- When a bug occurs in "PMB Portable" or you delete "PMB Portable" by mistake, you can recover "PMB Portable" by downloading the PMB Portable installer from the website.
- Installing "PMB Portable" for Macintosh will delete "PMB Portable" for Windows from the camera.

▶ Operation Search
▶ Before Use
▶ Shooting
▶ Viewing
▶ Using MENU items (Shooting)
▶ Using MENU items (Viewing)
▶ Changing settings
▶ Viewing images on a TV
▶ Using with your computer
▶ Printing
▶ Troubleshooting
▶ Precautions / About this camera

[→ Contents list](#)

[▲ Back to top](#)

Copyright 2011 Sony Corporation

▶ Operation Search
▶ Before Use
▶ Shooting
▶ Viewing
▶ Using MENU items (Shooting)
▶ Using MENU items (Viewing)
▶ Changing settings
▶ Viewing images on a TV
▶ Using with your computer
▶ Printing
▶ Troubleshooting
▶ Precautions / About this camera

[→ Contents list](#)

Printing still images

You can print still images using the following methods.

- Printing directly using a printer which supports your memory card type.
For details, see the operating instructions supplied with the printer.
- Printing using a computer
You can import images to a computer using the supplied “PMB” software and print the images.
You can insert the date on the image and print it. For details, see the “PMB Help”.
- Printing at a shop [\[Details\]](#)

Notes

- When you print still images shot in [16:9] mode, both edges may be cut off.
- You cannot print panorama images depending on the printer.

[▲ Back to top](#)

▶ Operation Search
▶ Before Use
▶ Shooting
▶ Viewing
▶ Using MENU items (Shooting)
▶ Using MENU items (Viewing)
▶ Changing settings
▶ Viewing images on a TV
▶ Using with your computer
▶ Printing
▶ Troubleshooting
▶ Precautions / About this camera

[→ Contents list](#)

Printing at a shop

You can take a memory card containing images shot with the camera to a photo printing service shop. As long as the shop supports photo printing services conforming to DPOF, you can make a **DPOF** (Print order) mark on images in advance in the playback mode so that you do not have to reselect them when you print them out at the shop.

Notes

- You cannot print images stored in the internal memory at a print shop directly from the camera. Copy the images to a memory card, then take the memory card to the print shop. [\[Details\]](#)
- Consult your photo printing service shop as to what types of memory card they handle.
- A memory card adaptor (sold separately) may be necessary. Consult your photo printing service shop.
- Before you take image data to a shop, always copy (back up) your data to a disk.
- You cannot set the number of prints.
- If you want to superimpose dates on images, consult your photo printing service shop.

Related Topic

[DPOF](#)[▲ Back to top](#)

▶ Operation Search
▶ Before Use
▶ Shooting
▶ Viewing
▶ Using MENU items (Shooting)
▶ Using MENU items (Viewing)
▶ Changing settings
▶ Viewing images on a TV
▶ Using with your computer
▶ Printing
▶ Troubleshooting
▶ Precautions / About this camera

[→ Contents list](#)

If you have problems

If you experience trouble with the camera, try the following solutions.

1. Check the items under “Troubleshooting”, then check your camera.
2. Remove the battery pack, wait for about one minute, re-insert the battery pack, then turn on the power.
3. Initialize the settings. [\[Details\]](#)
4. Consult your Sony dealer or local authorized Sony service facility.
 - Be aware that by sending the camera for repair, you give consent that the contents of the internal memory, music files may be checked.
 - Additional information on this product and answers to frequently asked questions can be found at our Customer Support Website.
<http://www.sony.net/>

[▲ Back to top](#)

▶ Operation Search
▶ Before Use
▶ Shooting
▶ Viewing
▶ Using MENU items (Shooting)
▶ Using MENU items (Viewing)
▶ Changing settings
▶ Viewing images on a TV
▶ Using with your computer
▶ Printing
▶ Troubleshooting
▶ Precautions / About this camera

[→ Contents list](#)

Battery pack and power

Cannot insert the battery pack into the camera.

- Make sure the direction of the battery pack is correct, and insert it until the battery eject lever is locked.

Cannot turn on the camera.

- After inserting the battery pack into the camera, it may take a few moments for the camera to power up.
- Make sure that the battery pack is inserted correctly.
- The battery pack is discharged. Insert a charged battery pack.
- The battery pack terminals are dirty. Gently wipe away any dirt with a soft cloth.
- Use a recommended battery pack.

The power turns off suddenly.

- Depending on the camera and battery temperature, the power may turn off automatically to protect the camera. In this case, a message is displayed on the LCD screen before the power turns off.
- If you do not operate the camera for a certain period of time while the power is on and [Power Save] is set to [Standard] or [Stamina], the camera turns off automatically to prevent wearing down the battery pack. Turn on the camera again.

The remaining charge indicator is incorrect.

- This is caused when you use the camera in an extremely hot or cold location.
- A discrepancy arose between the remaining charge indicator and the actual remaining battery charge. Fully discharge the battery pack once, then charge it to correct the indication. Depending on conditions of use, the display may remain incorrect.
- Battery capacity decreases over time and through repeated use. If decreased usage time between charges becomes significant, it is probably time to replace it with a new one.

Cannot charge the battery pack while it is inserted in the camera.

- You cannot charge the battery pack using the AC Adaptor (sold separately). Use the battery charger to charge the battery.

The CHARGE lamp flashes while charging the battery.

- Check that the battery pack type is NP-BN1.
- The CHARGE lamp flashes infrequently when you use a battery pack that has not been used for a long time.

- The CHARGE lamp (on the supplied battery charger) has two flash patterns, fast flash (approx. 0.15-second intervals) and slow flash (approx. 1.5-second intervals). If the lamp flashes quickly, remove the battery pack being charged, and then insert the same battery pack into the battery charger again (until it clicks). If the lamp flashes quickly again, this may indicate a battery pack problem.

If the lamp flashes slowly, the charger is in standby mode and charging has temporarily stopped. Charging stops temporarily and standby mode results when the temperature is outside the range suitable for charging. Charging resumes and the CHARGE lamp lights when the temperature returns to the range suitable for charging.

It is recommended to charge the battery pack within the proper charging temperature range between 10°C to 30°C (50°F to 86°F).

- For details, see. [\[Details\]](#)

[▲ Back to top](#)



Copyright 2011 Sony Corporation

▶ Operation Search
▶ Before Use
▶ Shooting
▶ Viewing
▶ Using MENU items (Shooting)
▶ Using MENU items (Viewing)
▶ Changing settings
▶ Viewing images on a TV
▶ Using with your computer
▶ Printing
▶ Troubleshooting
▶ Precautions / About this camera

[→ Contents list](#)

Shooting still images / movies



Cannot record images.

- Images are recorded on the internal memory even when a memory card is inserted into the camera. Make sure that the memory card is fully inserted into the camera.
- Check the free capacity of the internal memory or memory card. If it is full, do one of the following:
 - Delete unnecessary images. [\[Details\]](#)
 - Change the memory card.
- You cannot record images while charging the flash.
- When recording movies, it is recommended that you use the following memory cards:
 - “Memory Stick PRO Duo” media, “Memory Stick PRO-HG Duo” media
 - SD card (Class 2 or faster)
- Set the mode switch to  (Still Image) when shooting still images.
- Set the mode switch to  (Movie) when shooting movies.

Smile Shutter function does not work.

- No image is shot if a smiling face is not detected. [\[Details\]](#)

The image is out of focus.

- The subject is too close. When shooting, make sure to position the lens farther away from the subject than the shortest shooting distance (approximately 4 cm (1 5/8 inches) (W)/60 cm (23 5/8 inches) (T) from the lens).
-  (Twilight) or  (Landscape) mode is selected in the Scene Selection when shooting still images.









Zoom does not work.

- You cannot use the optical zoom in Sweep Panorama mode.
- You cannot change the zoom scale when shooting movies.
- You cannot use the Smart zoom depending on the image size. [\[Details\]](#)
- You cannot use the digital zoom when:
 - Shooting movies.
 - The Smile Shutter is working.
 - [Self-Timer] is set to [Self-portrait One Person] or [Self-portrait Two People].

Cannot select the Face Detection function.

- You can select Face Detection only when the focus mode is set to [Multi AF] and the metering mode is set to [Multi].



The flash does not work.

- You cannot use the flash when:
 - Burst mode is selected. [\[Details\]](#)
 -  (High Sensitivity) or  (Twilight) mode is selected in Scene Selection.
 - Shooting in Sweep Panorama mode.
 - Shooting in Movie Mode.
- Set the flash to  (On) when the Scene Selection mode is set to  (Landscape),  (Gourmet),  (Pet),  (Beach) or  (Snow) mode. [\[Details\]](#)

Fuzzy white circular spots appear in images shot using the flash.

- Particles (dust, pollen, etc.) in the air reflected the flash light and appeared in the image. This is not a malfunction. [\[Details\]](#)

The close-up shoot function (Macro) does not work.

- The camera automatically adjusts the focus. Press and hold the shutter button halfway down. Focus adjustment may take some time when shooting a close subject.
-  (Landscape) or  (Twilight) mode is selected in the Scene Selection.

The date and time are not displayed on the LCD screen.

- While shooting, the date and time are not displayed. They are displayed only during playback.

Cannot insert dates on images.

- This camera does not have a feature for superimposing dates on images. By using “PMB”, you can print or save images with the date. [\[Details\]](#)

The F value and shutter speed flash when you press and hold the shutter button halfway down.

- The exposure is incorrect. Correct the exposure. [\[Details\]](#)

The image colors are not correct.

- Adjust the White Balance. [\[Details\]](#)

White or purple streaks appear in bright areas of the subject, or the whole screen of the image becomes reddish.

- This phenomenon is called smearing. This is not a malfunction. Smearing is not recorded on still images, but is recorded as streaks or uneven colors on Sweep Panorama images or movies.
 (“Bright areas” refers to the sun or electric lights which are much brighter than surroundings.)

Noise appears in the image when you view the screen in a dark place.

- The camera is attempting to increase the visibility of the screen by temporarily brightening the image under conditions of low illumination. There is no effect on the recorded image.

The eyes of the subject come out red.

- Set [Red Eye Reduction] to [Auto] or [On]. [\[Details\]](#)
 - Shoot the subject at a distance closer than the flash range using the flash.
 - Light the room and shoot the subject.
 - Retouch the image using [Retouch] → [Red Eye Correction] in viewing menu [\[Details\]](#), or correct using “PMB”. [\[Details\]](#)
-

Dots appear and remain on the screen.

- This is not a malfunction. These dots are not recorded.
-

Cannot shoot images in succession.

- The internal memory or memory card is full. Delete unnecessary images. [\[Details\]](#)
 - The battery level is low. Insert a charged battery pack.
-

The same image is shot several times.

- Set [Burst Settings] to [Single]. [\[Details\]](#)
 - [Scene Recognition] is set to [Advanced]. [\[Details\]](#)
-

[▲ Back to top](#)

Copyright 2011 Sony Corporation

▶ Operation Search
▶ Before Use
▶ Shooting
▶ Viewing
▶ Using MENU items (Shooting)
▶ Using MENU items (Viewing)
▶ Changing settings
▶ Viewing images on a TV
▶ Using with your computer
▶ Printing
▶ Troubleshooting
▶ Precautions / About this camera

[→ Contents list](#)

Viewing images

Cannot play back images.

- Make sure that the memory card is fully inserted into the camera.
- The folder / file name has been changed on your computer.
- No guarantees are made for playing back, on this camera, files containing images which were processed on a computer or images which were shot using other cameras.
- The camera is in USB mode. Delete the USB connection. [\[Details\]](#)

The date and time are not displayed.

- The screen display is set to display images only. Press the DISP (Screen Display Settings) button to display information. [\[Details\]](#)

Cannot display images in index mode.

- The camera is set to Easy Mode. Cancel Easy Mode.

The image does not appear on the TV.

- Check [Video Out] to see if the video output signal of the camera is set to the color system of your TV. [\[Details\]](#)
- Check whether the connection is correct. [\[Details\]](#)

[▲ Back to top](#)

▶ Operation Search
▶ Before Use
▶ Shooting
▶ Viewing
▶ Using MENU items (Shooting)
▶ Using MENU items (Viewing)
▶ Changing settings
▶ Viewing images on a TV
▶ Using with your computer
▶ Printing
▶ Troubleshooting
▶ Precautions / About this camera

[→ Contents list](#)

Deleting

Cannot delete an image.

- Cancel the protection. [\[Details\]](#)

[▲ Back to top](#)

▶ Operation Search
▶ Before Use
▶ Shooting
▶ Viewing
▶ Using MENU items (Shooting)
▶ Using MENU items (Viewing)
▶ Changing settings
▶ Viewing images on a TV
▶ Using with your computer
▶ Printing
▶ Troubleshooting
▶ Precautions / About this camera

[→ Contents list](#)

Computers

“Memory Stick PRO Duo” media is not recognized by a computer with a “Memory Stick” media slot.

- Check that the computer and the “Memory Stick” media Reader / Writer support “Memory Stick PRO Duo” media. Users of computers and “Memory Stick” media Readers / Writers made by manufacturers other than Sony should contact those manufacturers.
- If “Memory Stick PRO Duo” media is not supported, connect the camera to the computer. [\[Details\]](#) The computer recognizes the “Memory Stick PRO Duo” media.

Your computer does not recognize the camera.

- When the battery level is low, insert the charged battery pack.
- Set [USB Connect] to [Mass Storage]. [\[Details\]](#)
- Use the dedicated USB cable (supplied).
- Disconnect the dedicated USB cable from both the computer and the camera, and connect it again firmly.
- Disconnect all equipment other than the camera, the keyboard and the mouse from the USB connectors of your computer.
- Connect the camera directly to your computer without passing through a USB hub or other device.

Cannot import images.

- Connect the camera and your computer correctly making a USB connection. [\[Details\]](#)
- When you shoot images with a memory card formatted by a computer, you may not be able to import the images to a computer. Shoot using a memory card formatted by the camera. [\[Details\]](#)

After making a USB connection, “PMB” does not start automatically.

- Make the USB connection after the computer is turned on.

After making a USB connection, “PMB Portable” does not start.

- Set [LUN Setting] to [Multi]. [\[Details\]](#)
- Set [USB Connect] to [Mass Storage]. [\[Details\]](#)
- Connect the computer to the network.

Cannot play back images on your computer.

- If you are using “PMB”, refer to “PMB Help”. [\[Details\]](#)

- Consult the computer or software manufacturer.

The image and sound are interrupted by noise when you view a movie on a computer.

- You are playing back the movie directly from the internal memory or the memory card. Import the movie to your computer using “PMB” and play it back. [\[Details\]](#)

Images once exported to a computer cannot be viewed on the camera.

- Export them to a folder recognized by the camera, such as “101MSDCF”.

[▲ Back to top](#)

Copyright 2011 Sony Corporation

▶ Operation Search
▶ Before Use
▶ Shooting
▶ Viewing
▶ Using MENU items (Shooting)
▶ Using MENU items (Viewing)
▶ Changing settings
▶ Viewing images on a TV
▶ Using with your computer
▶ Printing
▶ Troubleshooting
▶ Precautions / About this camera

[→ Contents list](#)

Memory card

Cannot insert a memory card.

- Insert the memory card in the correct direction.

You have formatted a memory card by mistake.

- All the data on the memory card is deleted by formatting. You cannot restore it.

Images are recorded on the internal memory even when a memory card is inserted into the camera.

- Make sure that the memory card is fully inserted into the camera.

[▲ Back to top](#)

▶ Operation Search
▶ Before Use
▶ Shooting
▶ Viewing
▶ Using MENU items (Shooting)
▶ Using MENU items (Viewing)
▶ Changing settings
▶ Viewing images on a TV
▶ Using with your computer
▶ Printing
▶ Troubleshooting
▶ Precautions / About this camera

[→ Contents list](#)

Internal memory

Cannot play back or record images using the internal memory.

- There is a memory card inserted in the camera. Remove it.

Cannot copy the data stored in the internal memory to a memory card.

- The memory card is full. Copy to a memory card with sufficient capacity.

Cannot copy the data on the memory card or the computer to the internal memory.

- This feature is not available.

[▲ Back to top](#)

▶ Operation Search
▶ Before Use
▶ Shooting
▶ Viewing
▶ Using MENU items (Shooting)
▶ Using MENU items (Viewing)
▶ Changing settings
▶ Viewing images on a TV
▶ Using with your computer
▶ Printing
▶ Troubleshooting
▶ Precautions / About this camera

[→ Contents list](#)

Printing

Cannot print an image.

- Refer to the operation manual of the printer.

Images are printed with both edges cut off.

- Depending on your printer, all the edges of the image may be cut off. Especially when you print an image shot with the image size set to [16:9], the lateral end of the image may be cut off.
- When printing images using your printer, cancel the trimming or borderless settings. Consult the printer manufacturer as to whether the printer provides these functions or not.
- When having images printed at a digital print shop, ask the shop whether they can print the images without cutting off both edges.

Cannot print images with the date.

- Using "PMB", you can print images with date. [\[Details\]](#)
- The camera does not have a feature for superimposing dates on images. However, because the images shot with the camera include information on the recording date, you can print images with the date superimposed if the printer or the software can recognize Exif information. For compatibility with Exif information, consult the manufacturer of the printer or the software.
- If you use a photo printing service, ask them to superimpose the dates on images.

[▲ Back to top](#)

▶ Operation Search
▶ Before Use
▶ Shooting
▶ Viewing
▶ Using MENU items (Shooting)
▶ Using MENU items (Viewing)
▶ Changing settings
▶ Viewing images on a TV
▶ Using with your computer
▶ Printing
▶ Troubleshooting
▶ Precautions / About this camera

[→ Contents list](#)

Others

The lens gets fogged.

- Moisture condensation has occurred. Turn off the camera and leave it for about an hour before using it.

The camera turns off with the lens portion extended.

- The battery pack is discharged. Replace it with a charged battery pack, then turn the camera on again.
- Do not attempt to force the lens that has stopped moving.

The camera becomes warm when you use it for a long time.

- This is not a malfunction.

The Clock Set screen appears when you turn on the camera.

- Set the date and time again. [\[Details\]](#)
- The internal rechargeable backup battery has discharged. Insert a charged battery, and set aside for 24 hours or more with the power left off.

The date or time is incorrect.

- The Area Setting is set to a different location than your current location. Change the setting by MENU →  (Settings) → [Clock Settings] → [Area Setting].

[▲ Back to top](#)

▶ Operation Search
▶ Before Use
▶ Shooting
▶ Viewing
▶ Using MENU items (Shooting)
▶ Using MENU items (Viewing)
▶ Changing settings
▶ Viewing images on a TV
▶ Using with your computer
▶ Printing
▶ Troubleshooting
▶ Precautions / About this camera

[→ Contents list](#)

Messages

If the following messages appear, follow the instructions.



- The battery level is low. Charge the battery pack immediately. Depending on the conditions of use or the type of battery, the indicator may flash even though there are still 5 minutes to 10 minutes of remaining battery time left.

For use with compatible battery only

- The battery inserted is not an NP-BN1 (supplied) battery pack.

System error

- Turn the power off and then on again.

Camera overheating
Allow it to cool

- The camera temperature has risen. The power may turn off automatically, or you may be unable to record movies. Leave the camera in a cool location until the temperature goes down.

Internal memory error

- Turn the power off and then on again.

Reinsert the memory card

- The inserted memory card cannot be used in the camera. [\[Details\]](#)
- The terminal section of the memory card is dirty.
- The memory card is damaged.

Memory card type error

- The inserted memory card cannot be used in the camera. [\[Details\]](#)

Error formatting internal memory
Error formatting memory card

- Format the media again. [\[Details\]](#)

Memory card locked

- You are using the memory card with the write-protect switch, and the switch is set to the LOCK position. Set the switch to the recording position.

Read only memory card

- The camera cannot record or delete images on this memory card.

No images

- No images that can be played back have been recorded in the internal memory.
- No images that can be played back have been recorded in this folder of the memory card.

Folder error

- A folder with the same first three digit number already exists on the memory card (for example: 123MSDCF and 123ABCDE). Select another folder [\[Details\]](#), or create a new folder. [\[Details\]](#)

Cannot create more folders

- The folder with a name beginning with “999” exists on the memory card. You cannot create any folders if this is the case.

Cannot display file

- An error occurred while the image was playing back.
No guarantees are made for playing back, on this camera, files containing images which were processed on a computer or images which were shot using other cameras.

Read only folder

- You have selected a folder that cannot be set as a recording folder on the camera. Select another folder. [\[Details\]](#)

File protected

- Release the protection. [\[Details\]](#)

Image size over limit

- You are playing back an image with size that cannot be played back on the camera.

Unable to detect face for retouch

- You may not be able to retouch the image depending on the image.

(Vibration warning indicator)

- Camera shake may occur due to insufficient light. Use the flash, or mount the camera on a tripod to secure the camera.

Turn the power off and on again

- The lens malfunction.

VGA is not supported with this memory card

- For recording movies, it is recommended that you use a memory card of 1 GB or larger.

Maximum number of images already selected

- Up to 100 files can be selected when using [Multiple Images].
- You can add **DPOF** (Print order) marks to up to 999 files.

Operation cannot be executed in unsupported files

- Processing and other editing functions of the camera cannot be performed on image files that have been processed using a computer or images that were recorded with other cameras.

No internal memory space remaining

Delete all images?

- The internal memory is full. To record to the internal memory, select [Yes] and delete unwanted images.

[▲ Back to top](#)

Copyright 2011 Sony Corporation

▶ Operation Search
▶ Before Use
▶ Shooting
▶ Viewing
▶ Using MENU items (Shooting)
▶ Using MENU items (Viewing)
▶ Changing settings
▶ Viewing images on a TV
▶ Using with your computer
▶ Printing
▶ Troubleshooting
▶ Precautions / About this camera

[→ Contents list](#)

Precautions

- ▼ [Internal memory and memory card back up](#)
- ▼ [Do not use / store the camera in the following places](#)
- ▼ [On carrying](#)
- ▼ [On operating temperatures](#)
- ▼ [On moisture condensation](#)
- ▼ [On image data compatibility](#)
- ▼ [Notes on the LCD screen and lens](#)

Internal memory and memory card back up

- Do not turn off the camera, remove the battery pack, or remove the memory card while the access lamp is lit. Otherwise, the internal memory data or the memory card may be damaged. Be sure to make a backup copy to protect your data.

Do not use / store the camera in the following places

- In an extremely hot, cold or humid place
In places such as in a car parked in the sun, the camera body may become deformed and this may cause a malfunction.
- Under direct sunlight or near a heater
The camera body may become discolored or deformed, and this may cause a malfunction.
- In a location subject to rocking vibration
- Near strong magnetic place
- In sandy or dusty places
Be careful not to let sand or dust get into the camera. This may cause the camera to malfunction, and in some cases this malfunction cannot be repaired.

On carrying

- Do not sit down in a chair or other place with the camera in the back pocket of your trousers or skirt, as this may cause malfunction or damage the camera.

On operating temperatures

- Your camera is designed for use under the temperatures between 0°C and 40°C (32°F and 104°F). Shooting in extremely cold or hot places that exceed this range is not recommended.

On moisture condensation

- If the camera is brought directly from a cold to a warm location, moisture may condense inside or outside the camera. This moisture condensation may cause a malfunction of the camera.
- If moisture condensation occurs, turn off the camera and wait about an hour for the moisture to evaporate. Note that if you attempt to shoot with moisture remaining inside the lens, you will be unable to record clear images.

On image data compatibility

- The camera conforms with DCF (Design rule for Camera File system) universal standard established by JEITA (Japan Electronics and Information Technology Industries Association).
- Sony does not guarantee that the camera will play back images recorded or edited with other equipment, or that other equipment will play back images recorded with the camera.

Notes on the LCD screen and lens

- The LCD screen is manufactured using extremely high-precision technology so over 99.99% of the pixels are operational for effective use. However, some tiny black and / or bright dots (white, red, blue or green) may appear on the LCD screen. These dots are a normal result of the manufacturing process and do not affect the recording.
- Exposing the LCD screen or the lens to direct sunlight for long periods may cause malfunctions. Be careful when placing the camera near a window or outdoors.
- Do not press against the LCD screen. The screen may be discolored and that may cause a malfunction.
- Images may trail across on the LCD screen in a cold location. This is not a malfunction.
- Be careful not to bump the movable lens, and be careful not to apply force to it.

[▲ Back to top](#)

Copyright 2011 Sony Corporation

[Top page](#) > [Precautions / About this camera](#) > [Precautions](#) > [On the internal rechargeable backup battery](#)

On the internal rechargeable backup battery

This camera has an internal rechargeable battery for maintaining the date and time and other settings regardless of whether the power is on or off.

This rechargeable battery is continually charged as long as you are using the camera. However, if you use the camera for only short periods, it discharges gradually, and if you do not use the camera at all for about one month it becomes completely discharged. In this case, be sure to charge this rechargeable battery before using the camera.

However, even if this rechargeable battery is not charged, you can still use the camera, but the date and time will not be indicated.

Charging method of the internal rechargeable backup battery

Insert charged battery pack in the camera, and then leave the camera for 24 hours or more with the power off.

[▲ Back to top](#)

- ▶ Operation Search
- ▶ Before Use
- ▶ Shooting
- ▶ Viewing
- ▶ Using MENU items (Shooting)
- ▶ Using MENU items (Viewing)
- ▶ Changing settings
- ▶ Viewing images on a TV
- ▶ Using with your computer
- ▶ Printing
- ▶ Troubleshooting
- ▶ Precautions / About this camera

[→ Contents list](#)

Copyright 2011 Sony Corporation

▶ Operation Search
▶ Before Use
▶ Shooting
▶ Viewing
▶ Using MENU items (Shooting)
▶ Using MENU items (Viewing)
▶ Changing settings
▶ Viewing images on a TV
▶ Using with your computer
▶ Printing
▶ Troubleshooting
▶ Precautions / About this camera

[→ Contents list](#)

Battery pack

- ▼ [On charging the battery pack](#)
- ▼ [Effective use of the battery pack](#)
- ▼ [About the remaining battery charge](#)
- ▼ [How to store the battery pack](#)
- ▼ [On battery life](#)
- ▼ [Compatible battery pack](#)

On charging the battery pack

- Charge the battery pack (supplied) before using the camera for the first time.
- You can charge the battery pack even if it is not completely discharged. In addition, even if the battery pack is not fully charged, you can use the partially charged capacity of the battery pack as is.
- We recommend charging the battery pack in an ambient temperature of between 10°C to 30°C (50°F to 86°F). The battery pack may not be effectively charged in temperatures outside this range.

Effective use of the battery pack

- Battery performance decreases in low temperature surroundings. So in cold places, the operational time of the battery pack is shorter. We recommend the following to ensure longer battery pack use:
 - Put the battery pack in a pocket close to your body to warm it up, and insert it in the camera immediately before you start shooting.
- The battery pack will run out quickly if you use the flash or zoom frequently.
- We recommend having spare battery packs handy for two times or three times the expected shooting time, and making trial shots before taking the actual shots.
- Do not expose the battery pack to water. The battery pack is not water-resistant.
- Do not leave the battery pack in extremely hot places, such as in a car or under direct sunlight.
- You may not be able to turn on the camera or the battery pack may not be effectively charged if the terminal section of the battery is dirty. In this case, wipe any dust with a soft cloth lightly to clean the battery.

About the remaining battery charge



A: High

B: Low

- A remaining charge indicator appears on the LCD screen.
- It takes about one minute until the correct remaining charge indicator appears.
- The remaining charge indicator may not be correct under certain circumstances.
- When [Power Save] is set to [Standard] or [Stamina], if you do not operate the camera for a certain period of time while the power is on, the LCD screen becomes dark, then the camera

turns off automatically (Auto power-off function).

How to store the battery pack

- Fully discharge the battery pack before storing and store it in a cool, dry place. To maintain the battery pack's function, fully charge the battery pack and then fully discharge it on the camera at least once a year while storing.
- To use the battery pack up, leave the camera in slideshow playback mode until the power goes off.
- To prevent staining the terminal, short-circuiting, etc., be sure to use a plastic bag to keep away from metal materials when carrying or storing.

On battery life

- The battery life is limited. Battery capacity decreases over time and through repeated use. If decreased usage time between charges becomes significant, it is probably time to replace it with a new one.
- The battery life varies according to how it is stored and the operating conditions and environment in which each battery pack is used.

Compatible battery pack

- The NP-BN1 (supplied) can be used only in N type compatible Cyber-shot models.

[▲ Back to top](#)

Copyright 2011 Sony Corporation

▶ Operation Search
▶ Before Use
▶ Shooting
▶ Viewing
▶ Using MENU items (Shooting)
▶ Using MENU items (Viewing)
▶ Changing settings
▶ Viewing images on a TV
▶ Using with your computer
▶ Printing
▶ Troubleshooting
▶ Precautions / About this camera

[→ Contents list](#)

Battery charger

- Only NP-BN1 type battery packs (and no others) can be charged in the battery charger (supplied). Batteries other than the specified kind may leak, overheat, or explode if you attempt to charge them, posing a risk of injury from electrocution and burns.
- Remove the charged battery pack from the battery charger. If you leave the charged battery pack in the charger, battery life may be shortened.
- The CHARGE lamp of the supplied battery charger flashes in either way:
 - Fast flashing: Turns the light on and off repeatedly at the interval of approximately 0.15 seconds.
 - Slow flashing: Turns the light on and off repeatedly at the interval of approximately 1.5 seconds.
- When the CHARGE lamp flashes fast, remove the battery pack being charged, and then insert the same battery pack into the battery charger securely again. When the CHARGE lamp flashes fast again, this may indicate a battery error or that a battery pack other than the specified type has been inserted. Check that the battery pack is the specified type. If the battery pack is the specified type, remove the battery pack, replace it with a new one or another one and check if the battery charger operates correctly. If the battery charger operates correctly, a battery error may have occurred.
- When the CHARGE lamp flashes slowly, it indicates that the battery charger stops charging temporarily on standby. The battery charger stops charging and enters the standby status automatically when the temperature is outside of the recommended operating temperature. When the temperature gets back within the appropriate range, the battery charger resumes charging and the CHARGE lamp lights up again. We recommend charging the battery pack in an ambient temperature of between 10°C to 30°C (50°F to 86°F).

[▲ Back to top](#)

▶ Operation Search
▶ Before Use
▶ Shooting
▶ Viewing
▶ Using MENU items (Shooting)
▶ Using MENU items (Viewing)
▶ Changing settings
▶ Viewing images on a TV
▶ Using with your computer
▶ Printing
▶ Troubleshooting
▶ Precautions / About this camera

→ [Contents list](#)

Memory card

- ▼ [Memory card](#)
- ▼ [Note on using the memory card adaptor \(sold separately\)](#)
- ▼ [“Memory Stick” media](#)
- ▼ [When using a “Memory Stick Duo” media with standard sized “Memory Stick” media slot](#)
- ▼ [Notes on using a “Memory Stick Micro” media \(sold separately\)](#)

Memory card

The types of memory cards that can be used with the camera are “Memory Stick PRO Duo” media, “Memory Stick PRO-HG Duo” media, “Memory Stick Duo” media, SD memory card and SDHC memory card. However, all memory cards are not guaranteed to work with this camera. MultiMediaCard cannot be used. The following memory cards are compatible with this camera: “Memory Stick PRO Duo” media, “Memory Stick PRO-HG Duo” media, “Memory Stick Duo” media, SD memory cards and SDHC memory cards. MultiMediaCard is not compatible. In this Users Guide, “Memory Stick PRO Duo” media, “Memory Stick PRO-HG Duo” media and “Memory Stick Duo” media are called “Memory Stick Duo” media and SD memory cards, SDHC memory cards are called SD cards.

- “Memory Stick Duo” media of up to 32 GB and SD memory cards of up to 32 GB have been tested and proven to operate with your camera.
- When recording movies, it is recommended that you use the following memory cards:
 - **MEMORY STICK PRO DUO** (“Memory Stick PRO Duo” media)
 - **MEMORY STICK PRO-HG DUO** (“Memory Stick PRO-HG Duo” media)
 - SD card (Class 2 or faster)

Notes

- To ensure stable operations of the memory card, we recommend that you use this camera to format any memory card being used with this camera for the first time. Note that formatting will erase all data recorded on the memory card. This data cannot be restored. Be sure to backup any important data to a PC or other storage location.
- A memory card formatted with a computer is not guaranteed to operate with the camera.
- Data read / write speeds differ depending on the combination of the memory card and the equipment used.
- Data may be corrupted in the following cases:
 - When the memory card is removed or the camera is turned off during a read or write operation
 - When the memory card is used in locations subject to static electricity or electrical noise
- We recommend backing up important data.
- Do not attach a label on the memory card itself nor on a memory card adaptor.
- Do not touch the terminal section of the memory card with your hand or a metal object.
- Do not strike, bend or drop the memory card.
- Do not disassemble or modify the memory card.
- Do not expose the memory card to water.
- Do not leave the memory card within the reach of small children. They might accidentally swallow it.
- Insert a memory card that fits the memory card slot size. Otherwise, it will cause a malfunction.
- Do not use or store the memory card under the following conditions:
 - High temperature locations such as the hot interior of a car parked in direct sunlight

- Locations exposed to direct sunlight
- Humid locations or locations with corrosive substances present

Note on using the memory card adaptor (sold separately)

- When inserting a memory card into a memory card adaptor, make sure the memory card is inserted facing in the correct direction, then insert it all the way in. Incorrect insertion may result in a malfunction.

“Memory Stick” media

The types of “Memory Stick Duo” media that can be used with the camera are listed in the table below. However, proper operation cannot be guaranteed for all “Memory Stick Duo” media functions.

“Memory Stick” media type	Recording / Playback
Memory Stick Duo (without MagicGate)	○ *1
Memory Stick Duo (with MagicGate)	○ *2
MagicGate Memory Stick Duo	○ *1*2
Memory Stick PRO Duo	○ *2*3
Memory Stick PRO-HG Duo	○ *2*3*4

*1 High-speed data transfer using a parallel interface is not supported.

*2 “Memory Stick Duo” media, “MagicGate Memory Stick Duo” media, “Memory Stick PRO Duo” media and “Memory Stick PRO-HG Duo” media are equipped with MagicGate functions. MagicGate is copyright protection technology that uses encryption technology. Data recording / playback that requires MagicGate functions cannot be performed with the camera.

*3 [VGA] size movies can be recorded.

*4 This camera does not support 8-bit parallel data transfer. It performs the same 4-bit parallel data transfer as the “Memory Stick PRO Duo” media.

When using a “Memory Stick Duo” media with standard sized “Memory Stick” media slot

You can use the “Memory Stick Duo” media by inserting it into the “Memory Stick Duo” media Adaptor (sold separately).



“Memory Stick Duo” media Adaptor

Notes on using a “Memory Stick Micro” media (sold separately)

- This product is compatible with “Memory Stick Micro” media (“M2”). “M2” is an abbreviation for “Memory Stick Micro” media.
- To use a “Memory Stick Micro” media with the camera, be sure to insert the “Memory Stick Micro” media into an “M2” Adaptor as large as of Duo size. If you insert a “Memory Stick Micro” media into the camera without an “M2” Adaptor as large as of Duo size, you might not be able to remove it from the camera.
- Do not leave the “Memory Stick Micro” media within the reach of small children. They might accidentally swallow it.

▶ Operation Search
▶ Before Use
▶ Shooting
▶ Viewing
▶ Using MENU items (Shooting)
▶ Using MENU items (Viewing)
▶ Changing settings
▶ Viewing images on a TV
▶ Using with your computer
▶ Printing
▶ Troubleshooting
▶ Precautions / About this camera

[→ Contents list](#)

On cleaning

Cleaning the LCD screen

Wipe the screen surface with an LCD cleaning kit (sold separately) to remove fingerprints, dust, etc.

Cleaning the lens

Wipe the lens with a soft cloth to remove fingerprints, dust, etc.

Cleaning the flash

Clean the flash surface before use. The heat of flash emission may cause dirt on the flash surface to become discolored or to stick to the flash surface, resulting in insufficient light emission.

Cleaning the camera surface

Clean the camera surface with a soft cloth slightly moistened with water, then wipe the surface with a dry cloth. To prevent damage to the finish or casing:

- Do not expose the camera to chemical products such as thinner, benzene, alcohol, disposable cloths, insect repellent, sunscreen or insecticide.
- Do not touch the camera with any of the above on your hand.
- Do not leave the camera in contact with rubber or vinyl for a long time.

[▲ Back to top](#)

[Top page](#) > [Precautions / About this camera](#) > [Number of still images and recordable time of movies](#) > [Number of still images](#)

Number of still images

(Units: Images)

Size	Internal memory	Memory card formatted with this camera				
	Approx. 6 MB	2 GB	4 GB	8 GB	16 GB	32 GB
12M	1	340	680	1350	2750	5500
8M	1	480	960	1900	3850	7700
5M	1	580	1150	2300	4650	9300
VGA	35	11500	23500	47000	94000	185000
16:9(9M)	1	380	760	1500	3050	6100
16:9(2M)	5	1950	3900	7800	15500	31000

Notes

- When the number of remaining shootable images is greater than 99,999, the ">99999" indicator appears.
- When an image shot with other cameras is played back on this camera, the image may not appear in the actual image size.

[▲ Back to top](#)

Copyright 2011 Sony Corporation

- ▶ Operation Search
- ▶ Before Use
- ▶ Shooting
- ▶ Viewing
- ▶ Using MENU items (Shooting)
- ▶ Using MENU items (Viewing)
- ▶ Changing settings
- ▶ Viewing images on a TV
- ▶ Using with your computer
- ▶ Printing
- ▶ Troubleshooting
- ▶ Precautions / About this camera

[→ Contents list](#)

[Top page](#) > [Precautions / About this camera](#) > [Number of still images and recordable time of movies](#) > [Recordable time of movies](#)

Recordable time of movies

The table below shows the approximate maximum recording times. These are the total times for all movie files.

Quality/Size	Internal memory	Memory card formatted with this camera				
	Approx. 6 MB	2 GB	4 GB	8 GB	16 GB	32 GB
VGA	0:00:05	0:25:00	0:55:00	1:50:00	3:40:00	7:25:00
QVGA	0:00:15	1:40:00	3:20:00	6:45:00	13:35:00	27:10:00

Note

- The recordable time of movies may vary depending on the shooting conditions (temperature, etc.). The value above applies when DISP (Screen Display Settings) is set to [Normal].
- The recordable movie file size is up to approx. 2 GB for each file. If the file size reaches approx. 2 GB, the camera stops recording the movie automatically.

▶ Operation Search
▶ Before Use
▶ Shooting
▶ Viewing
▶ Using MENU items (Shooting)
▶ Using MENU items (Viewing)
▶ Changing settings
▶ Viewing images on a TV
▶ Using with your computer
▶ Printing
▶ Troubleshooting
▶ Precautions / About this camera

[→ Contents list](#)

[▲ Back to top](#)

Copyright 2011 Sony Corporation

[Top page](#) > [Precautions / About this camera](#) > [Using the camera abroad](#) > [Using the camera abroad](#)

Using the camera abroad

You can use the battery charger (supplied) in any country or region where the power supply is within 100 V to 240 V AC, 50/60 Hz.

Note

- An electronic voltage transformer is unnecessary and its use may cause a malfunction.

[▲ Back to top](#)

- ▶ Operation Search
- ▶ Before Use
- ▶ Shooting
- ▶ Viewing
- ▶ Using MENU items (Shooting)
- ▶ Using MENU items (Viewing)
- ▶ Changing settings
- ▶ Viewing images on a TV
- ▶ Using with your computer
- ▶ Printing
- ▶ Troubleshooting
- ▶ Precautions / About this camera

[→ Contents list](#)

Copyright 2011 Sony Corporation

[Top page](#) > [Precautions / About this camera](#) > [Using the camera abroad](#) > [On TV color systems](#)

On TV color systems

If you want to view images on a TV screen, you need a TV with a video input jack and the dedicated A/V cable. The color system of the TV must match that of the digital still camera. Check the following lists for the TV color system of the country or region where the camera is used.

NTSC system

Bahama Islands, Bolivia, Canada, Central America, Chile, Colombia, Ecuador, Jamaica, Japan, Korea, Mexico, Peru, Surinam, Taiwan, the Philippines, the U.S.A., Venezuela, etc.

PAL system

Australia, Austria, Belgium, China, Croatia, Czech Republic, Denmark, Finland, Germany, Holland, Hong Kong, Hungary, Indonesia, Italy, Kuwait, Malaysia, New Zealand, Norway, Poland, Portugal, Rumania, Singapore, Slovak Republic, Spain, Sweden, Switzerland, Thailand, Turkey, United Kingdom, Viet Nam, etc.

PAL-M system

Brazil

PAL-N system

Argentina, Paraguay, Uruguay

SECAM system

Bulgaria, France, Greece, Guiana, Iran, Iraq, Monaco, Russia, Ukraine, etc.

▶ Operation Search
▶ Before Use
▶ Shooting
▶ Viewing
▶ Using MENU items (Shooting)
▶ Using MENU items (Viewing)
▶ Changing settings
▶ Viewing images on a TV
▶ Using with your computer
▶ Printing
▶ Troubleshooting
▶ Precautions / About this camera

[→ Contents list](#)

[▲ Back to top](#)

Copyright 2011 Sony Corporation

▶ Operation Search
▶ Before Use
▶ Shooting
▶ Viewing
▶ Using MENU items (Shooting)
▶ Using MENU items (Viewing)
▶ Changing settings
▶ Viewing images on a TV
▶ Using with your computer
▶ Printing
▶ Troubleshooting
▶ Precautions / About this camera

[→ Contents list](#)

License

Notes on the License

“zlib”, “libjpeg”, “Miscellaneous” and “ZCAM” software are provided in the camera. We provide this software based on license agreements with their owners of copyright. Based on requests by the owners of copyright of these software applications, we have an obligation to inform you of the following. Please read the following sections.

Read “license4.pdf” in the “License” folder on the CD-ROM. You will find licenses (in English) of “zlib”, “libjpeg”, “Miscellaneous” and “ZCAM” software.

[▲ Back to top](#)

▶ Operation Search
▶ Before Use
▶ Shooting
▶ Viewing
▶ Using MENU items (Shooting)
▶ Using MENU items (Viewing)
▶ Changing settings
▶ Viewing images on a TV
▶ Using with your computer
▶ Printing
▶ Troubleshooting
▶ Precautions / About this camera

[→ Contents list](#)

Trademarks

- The following marks are trademarks of Sony Corporation. **Cyber-shot**, “Cyber-shot,” “Memory Stick,” , “Memory Stick PRO,” **MEMORY STICK PRO**, “Memory Stick Duo,” **MEMORY STICK DUO**, “Memory Stick PRO Duo,” **MEMORY STICK PRO DUO**, “Memory Stick PRO-HG Duo,” **MEMORY STICK PRO-HG DUO**, “Memory Stick Micro,” “MagicGate,” **MAGICGATE**
- Microsoft, Windows, DirectX and Windows Vista are either registered trademarks or trademarks of Microsoft Corporation in the United States and/or other countries.
- Macintosh and Mac OS are trademarks or registered trademarks of Apple Inc..
- Intel and Pentium are trademarks or registered trademarks of Intel Corporation.
- SDHC logo is trademarks of SD-3C, LLC.
- MultiMediaCard is a trademark of MultiMediaCard Association.
- In addition, system and product names used in this manual are, in general, trademarks or registered trademarks of their respective developers or manufacturers. However, the ™ or ® marks are not used in all cases in this manual.

[▲ Back to top](#)

Copyright 2011 Sony Corporation

Free Manuals Download Website

<http://myh66.com>

<http://usermanuals.us>

<http://www.somanuals.com>

<http://www.4manuals.cc>

<http://www.manual-lib.com>

<http://www.404manual.com>

<http://www.luxmanual.com>

<http://aubethermostatmanual.com>

Golf course search by state

<http://golfingnear.com>

Email search by domain

<http://emailbydomain.com>

Auto manuals search

<http://auto.somanuals.com>

TV manuals search

<http://tv.somanuals.com>