

Digital HD Videocassette Recorder

Operating Instructions

HDV
HDV 1080i

DVCAM[™]

DV Digital
Video
Cassette

Mini **DV** Digital
Video
Cassette

HDMI[™]
HIGH-DEFINITION MULTIMEDIA INTERFACE

HVR-M25U/M25N/M25E/M25P

WARNING

To reduce fire or shock hazard, do not expose the unit to rain or moisture.

To avoid electrical shock, do not open the cabinet. Refer servicing to qualified personnel only.

This unit must be connected to an earthed MAINS socket-outlet.

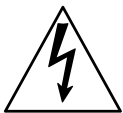
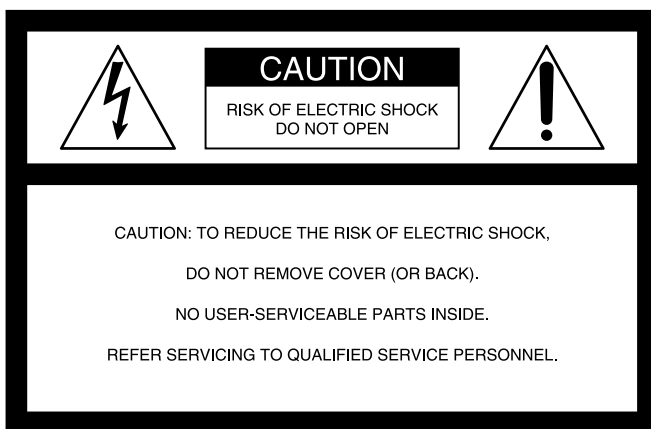

This symbol is intended to alert the user to the presence of uninsulated "dangerous voltage" within the product's enclosure that may be of sufficient magnitude to constitute a risk of electric shock to persons.



This symbol is intended to alert the user to the presence of important operating and maintenance (servicing) instructions in the literature accompanying the appliance.

Owner's record

The model number and the serial number are located at the name plate on the left of the unit. Record the serial number in the space provided below. Refer to these numbers whenever you call upon your Sony dealer regarding this product.

Model No. HVR- Serial No. _____

Important Safety Instructions

- Read these instructions.
- Keep these instructions.
- Heed all warnings.
- Follow all instructions.
- Do not use this apparatus near water.
- Clean only with dry cloth.
- Do not block any ventilation openings. Install in accordance with the manufacturer's instructions.
- Do not install near any heat sources such as radiators, heat registers, stoves, or other apparatus (including amplifiers) that produce heat.
- Do not defeat the safety purpose of the polarized or grounding-type plug. A polarized plug has two blades with one wider than the other. A grounding-type plug has two blades and a third grounding prong. The wide blade or the third prong are provided for your safety. If the provided plug does not fit into your outlet, consult an electrician for replacement of the obsolete outlet.
- Protect the power cord from being walked on or pinched particularly at plugs, convenience receptacles, and the point where they exit from the apparatus.
- Only use attachments/accessories specified by the manufacturer.
- Use only with the cart, stand, tripod, bracket, or table specified by the manufacturer, or sold with the apparatus. When a cart is used, use caution when moving the cart/apparatus combination to avoid injury from tip-over. 
- Unplug this apparatus during lightning storms or when unused for long periods of time.
- Refer all servicing to qualified service personnel. Servicing is required when the apparatus has been damaged in any way, such as power-supply cord or plug is damaged, liquid has been spilled or objects have fallen into the apparatus, the apparatus has been exposed to rain or moisture, does not operate normally, or has been dropped.

Notes on installation

- This unit is not designed as a portable. Make sure to install the unit properly on a flat surface. If you install the unit so that it is inclined 30 degrees or more (i.e., if you stand the unit on its side), malfunctions may occur.
- Do not place materials around the unit that may block the ventilation holes. Otherwise, heat builds up inside the unit and malfunctions may occur.
- Install the unit nearby the wall socket, disconnect the mains plug from the wall socket immediately if any malfunction occurs while using this unit.

For customers in the U.S.A.

HVR-M25U only

If you have any questions about this product, you may call: Sony's Business Information Center (BIC) at 1-800-686-SONY (7669)

*or Write to: Sony Customer Information Services Center
6900-29 Daniels Parkway, PMB 330 Fort
Myers, Florida 33912*

Declaration of Conformity

Trade Name: SONY
Model: HVR-M25U
Responsible Party: Sony Electronics Inc.
Address: 16530 Via Esprillo, San Diego,
CA 92127 U.S.A.
Telephone Number: 858-942-2230

This device complies with Part 15 of the FCC Rules. Operation is subject to the following two conditions:
(1) This device may not cause harmful interference, and
(2) this device must accept any interference received, including interference that may cause undesired operation.

CAUTION

You are cautioned that any changes or modifications not expressly approved in this manual could void your authority to operate this equipment.

NOTE:

This equipment has been tested and found to comply with the limits for Class B digital device, pursuant to Part 15 of the FCC Rules.

These limits are designed to provide reasonable protection against harmful interference in a residential installation.

This equipment generates, uses, and can radiate radio frequency energy and, if not installed and used in accordance with the instructions, may cause harmful interference to radio communications.

However, there is no guarantee that interference will not occur in a particular installation. If this equipment does cause harmful interference to radio or television reception, which can be determined by turning the equipment off and on, the user is encouraged to try to correct the interference by one or more of the following measures:

- Reorient or relocate the receiving antenna.
- Increase the separation between the equipment and receiver.
- Connect the equipment into an outlet on a circuit different from that to which the receiver is connected.
- Consult the dealer or an experienced radio/TV technician for help.

Disposal of Waste Electrical and Electronic Equipment for business use (Applicable in the European Union and other European countries with separate collection systems)

This symbol on the product or on its packaging indicates that this product shall not be treated as household waste. Instead it shall be handed over to the applicable take-back scheme for the recycling of electrical and electronic equipment. By ensuring this product is disposed of correctly, you will help prevent potential negative consequences for the environment and human health, which could otherwise be caused by inappropriate waste handling of this product. The recycling of materials will help to conserve natural resources. For more detailed information about recycling of this product, please contact your local Sony office or visit Sony Europe's web site for business customers: <http://www.sonybiz.net/environment>



For the customers in Europe HVR-M25E only

This product with the CE marking complies with both the EMC Directive (89/336/EEC) and the Low Voltage Directive (73/23/EEC) issued by the Commission of the European Community.

Compliance with these directives implies conformity to the following European standards:

- EN60065 :Product Safety
- EN55103-1 :Electromagnetic Interference (Emission)
- EN55103-2 :Electromagnetic Susceptibility (Immunity)

This product is intended for use in the following Electromagnetic Environment(s):

E1 (residential), E2 (commercial and light industrial), E3 (urban outdoors) and E4 (controlled EMC environment ex. TV studio).

ATTENTION

The electromagnetic fields at the specific frequencies may influence the picture and sound of this unit.

For the customers in the Nederland Voor de klanten in Nederland

Dit apparaat bevat een vast ingebouwde batterij die niet vervangen hoeft te worden tijdens de levensduur van het apparaat.

Raadpleeg uw leverancier indien de batterij toch vervangen moet worden.

De batterij mag alleen vervangen worden door vakbekwaam servicepersoneel.

Gooi de batterij niet weg maar lever deze in als klein chemisch afval (KCA).

Lever het apparaat aan het einde van de levensduur in voor recycling, de batterij zal dan op correcte wijze verwerkt worden.

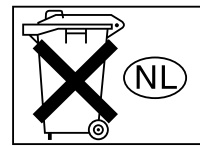

Caution

Television programs, films, video tapes and other materials may be copyrighted. Unauthorized recording of such material may be contrary to the provisions of the copyright laws. Also, use of this recorder with cable television transmission may require authorization from the cable television transmission and/or program owner.

Table of Contents

Chapter1

Overview

Features	7
Location and Function of Parts	9
Front Panel	9
Rear Panel	18
Supplied Remote Commander	23
Displaying Various Data	25

Chapter2

Playback and Recording

Notes on Power Supply and Video Cassettes	30
Preparing the Power Supply	31
Inserting/Ejecting Cassettes	31
Notes on Playback/Recording	31
Playback	33
Connections for Playback.....	33
Settings for Playback	35
Playback Procedures	35
Playback Functions	36
AUTO REPEAT (CUSTOM REPEAT)	39
EDGE CROP MARKER	41
MARKER BURN	42
Using the Unit as a Videocassette Recorder	43
Connections for Recording	43
Settings for Recording	45
Recording Procedures	47
Recording Functions	47

Chapter3

Setting the Time Code

Setting the Time Code and User Bits	49
Using the Internal Time Code Generator	49

Chapter4

Dubbing to another equipment using i.LINK jack, Duplication, Audio Dubbing, and Connecting with a Computer

Dubbing to another equipment using i.LINK jack	54
Connections for Dubbing	54
Dubbing procedures	55
Duplication (generating a work tape with the same time code)	56
Audio Dubbing	60
Editing (Connecting with a Computer)	62
Connecting the Unit to a Computer	62
Preparations	63

Table of Contents

Chapter5

Adjusting and Setting Through Menus

Operating the Menus	65
Menu Organization	66
Menu Contents	67

Chapter6

Maintenance

Troubleshooting	80
Warning indicators and messages	87
Notes on Use	89
Notes on the Videocassette Recorder	89
Cleaning of the Video Heads	89
Notes on the Video Cassettes	90
Notes on LCD Screen	91
About Moisture Condensation	91
Digital Hours Meter	92
About the Built-in Rechargeable Battery	92
Notes on the License	92

Appendix

Compatibility of HDV, DVCAM, and DV Formats	93
About i.LINK	98
Specifications	99
Index	102
Submenu Index	103

Overview

Features

The HVR-M25U/M25N/M25E/M25P is a digital HD videocassette recorder supporting HDV format and DVCAM/DV format. The unit produces stable, superior picture quality by digital processing and separating image signals into color difference signals and a luminance signal (component video). The unit provides i.LINK (Ⓜ HDV/DV) jack, HDMI OUT jack, COMPONENT OUT jacks, S VIDEO IN/OUT jacks, composite IN/OUT jacks, and AUDIO IN/OUT jacks. These jacks allow you to connect other equipment like non-linear editors. Additionally, it comes with a 2.7 (16:9)-type color LCD (liquid crystal display) monitor, you can easily check your recorded images, menus, and the audio level meters. The main features of the unit are described below.

HDV format

The unit can perform HDV (High-Definition Digital Video) recording and playback on a DVCAM format video cassette or a DV format video cassette. The compression system of HDV format is the MPEG2 system adopted in the high-definition broadcasting and the Blu-ray Disk System. The unit adopts the 1080 scanning lines (interlace (HDV 1080/60i and HDV 1080/50i)/1440 × 1080 pixels) format of the HDV specifications. The recording bit rate is approximately 25 Mbps. The unit is equipped with an i.LINK digital interface and can be digitally connected with HDV-compatible televisions or computers.

DVCAM/DV format

DVCAM is based on the consumer DV format, which uses the 4:1:1 component digital format (60i) or the 4:2:0 format (50i), and provides a 1/4-inch digital recording format for professional use. The unit provides both DVCAM format recording/playback and DV format in SP mode recording/playback. *For details, see “Compatibility of HDV, DVCAM, and DV Formats” on page 93.*

Compatible with both 1080/60i (NTSC) and 1080/50i (PAL) systems

The unit is compatible with 60i and 50i systems. You can switch these input signals using the menu setting (*page 79*). This compatibility allows you to record (download) or play back (upload) both 50i and 60i signals with your VCR, computer, or other equipment. However, the unit cannot convert the color system of the signals. The unit set in 60i system has a field frequency of 59.94 Hz.

Features

High definition down convert function

When you want to playback a tape recorded in HDV format, you can down convert images to output them. This function allows you to preview recorded-images on a monitor which is not compatible with High-Definition (HD) format. Also, you can select an aspect ratio from SQUEEZE, LETTER BOX (except , HDV/DV jack output), or EDGE CROP.

16:9 Built-in color LCD monitor

The unit has a 2.7-type 16:9 color LCD (liquid crystal display) monitor that lets you verify images on the spot. You can see the setup menus, audio levels, and system statuses. Menus and data can be superimposed over the picture being displayed.

Multiple input/output interfaces

HDMI OUT jack, , HDV/DV jack, COMPONENT OUT jacks, S VIDEO jacks, VIDEO jacks and AUDIO jacks are equipped on the unit and enable the connection with various devices.

About HDMI (High Definition Multimedia Interface)

HDMI is an interface for connecting directly to a TV with digital pictures and digital audio signals. By connecting HDMI OUT jack to a HDMI compatible TV using a single HDMI cable, you can enjoy a high quality picture and digital sounds.

A variety of buttons and switches for VCR operations

The unit provides a variety of buttons for VCR operations, such as INPUT SELECT switch, AUDIO REC LEVEL, PHONE LEVEL control knob, and STATUS CHECK button.

Time code and user bits

On the unit, you can use time code and user bits. Using the menu, these can be set easily.

JOG AUDIO function

If you use the optional remote control unit DSRM-10 (not supplied), audio can be monitored at various playback speeds when in jog/shuttle mode. (Jog audio cannot be output when the tape is recorded in HDV format.)

Screen Language Setting

You can select the language. The default language setting is English. See page 77 to change the screen language.

Easy maintenance functions

- **Self-diagnostics/alarm functions:** The system automatically detects an invalid operation, bad connection or a malfunction, and displays a description, a cause and a recovery method on LCD monitor and outputs to HDMI OUT jack, COMPONENT OUT jacks, S VIDEO jack, and VIDEO jack.
- **Digital hours meter:** A digital hours meter counts four types of time data—operating time, drum rotation time, tape running time, and tape threading/unthreading. The digital hours data are indicated on the menu.

.....
, , and  are trademarks of Sony Corporation.

HDV is a trademark of Sony Corporation and Victor Company of Japan Ltd.

HDMI, HDMI logo, and High Definition Multimedia Interface is a trademark or a registered trademark of HDMI Licensing LLC.

All other product names mentioned here may be the trademarks or registered trademarks of their respective companies. “™” and “®” are not mentioned in each case in this manual.

Location and Function of Parts

Front Panel

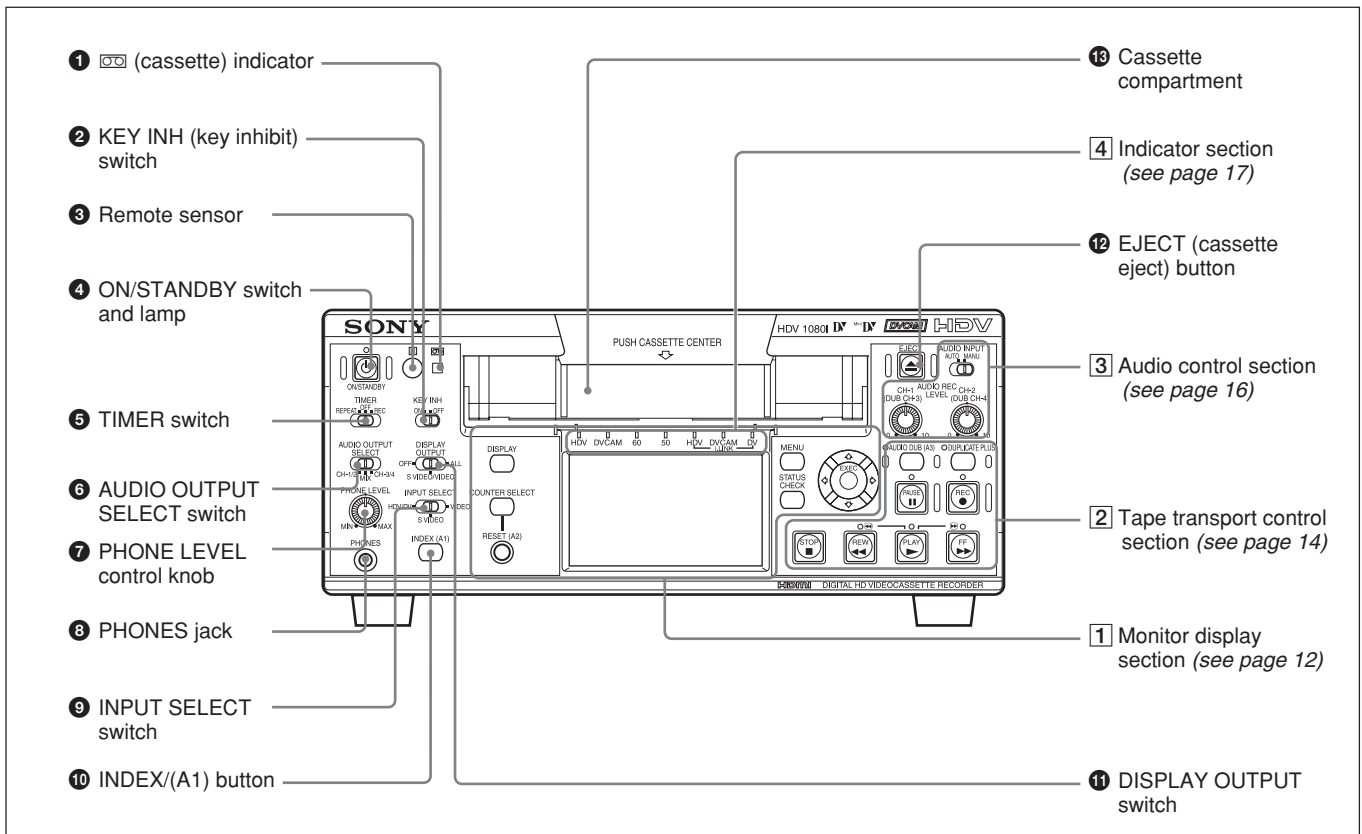

1 (cassette) indicator

Lights when a digital video cassette is loaded. Does not light up while the unit is not loading a cassette. This indicator blinks while a cassette is being ejected. For details, see "Inserting/Ejecting Cassettes" on page 31.

2 KEY INH (key inhibit) switch

Turning on this switch disables all buttons to prevent accidental button operations.

Notes

- Even when this switch is set to ON, the switches 5, 6, 9, 11, and 3-1, the switch 4 on the rear panel, and the knobs 7 and 3-2 can be controlled.
- Even when you set this switch to ON, you can operate the unit with Remote Commander, LANC jack, CONTROL S jack, and HDV/DV jack.

3 Remote sensor

Note

In addition to Remote Commander supplied with the unit, the unit accepts signals from any Sony Remote Commander whose command mode is set to VTR4. To disable the control from Remote Commander, set [COMMANDER] in [OTHERS] menu to [CONTROL S].

4 ON/STANDBY switch and lamp

Press this switch to turn the unit on, and ON/STANDBY lamp lights up green. When you press this switch again, the unit goes into STANDBY mode and the lamp lights up red.

Note

When KEY INH switch 2 is set to ON, ON/STANDBY switch does not work. Set KEY INH switch to OFF to enable ON/STANDBY switch.

(Continued)

Location and Function of Parts

5 TIMER switch

Use to select Auto Repeat or recording using an external AC timer (not supplied).

REPEAT: When the power is supplied to the unit, the tape rewinds to its beginning automatically and playback starts. When the following items on the tape are searched, AUTO REPEAT playback starts automatically.

- Index signals
- A portion unrecorded
- A portion recorded in the format set by other than [AUTO] in [HDV/DV SEL] in [IN/OUT REC] menu
- Tape end

Auto Repeat also functions if you set this switch to REPEAT during playback or rewind.

For details on Auto Repeat, see “AUTO REPEAT (CUSTOM REPEAT)” on page 39 and “CUSTOM REPEAT” in “VTR SET” menu on page 74.

OFF: Auto Repeat or timer recording is released.

REC: Recording begins the moment the power is connected to the unit.

Note

The setting of this switch still activates even when KEY INH switch 2 is set to ON.

6 AUDIO OUTPUT SELECT switch

When the audio mode is 32 kHz (4-channel), use this switch to select the audio channel to be output via HDMI OUT jack, AUDIO jacks in OUTPUT as well as PHONES jack 8.

CH-1/2: channels 1/2 only

MIX: channels 1/2 and channels 3/4

CH-3/4: channels 3/4 only

Notes

- During audio dubbing, if you want to listen to the sound recorded on the tape, set this switch to CH-1/2; if you want to listen to the sound being dubbed, set the switch to CH-3/4. (Only channels 3 and 4 can be used to dub.) To check the sound to be dubbed before dubbing, set this switch to CH-3/4, then press AUDIO DUB button while the unit is in the stop mode. Then you can listen to the sound of the channels used to dub (channels 3 and 4) at a moment. For details on the audio dubbing, see page 60. Also refer to the instructions of “AUDIO DUB / (A3) 1” button on page 14.

- When the audio mode is 48 kHz (2-channel), sounds of channel 1 and 2 are output via HDMI OUT jack, AUDIO jacks in OUTPUT, and PHONES jack 8 regardless of the position of this switch.
- When this switch is set to MIX, the sound of the mixed level of the pair of channel 1 and 3 and that of channels 2 and 4 is output. The audio output level becomes 50 % (–6 dB) of the original audio levels on each channel.

7 PHONE LEVEL control knob

Controls the volume of the headphones connected to PHONES jack 8.

8 PHONES jack

Connect stereo headphones for monitoring sounds during recording or playback. The audio signals you want to monitor can be selected with AUDIO OUTPUT SELECT switch 6. By changing the setting of [AUDIO MONI] in [AUDIO SET] (page 73), you can monitor the sound of a particular channel.

9 INPUT SELECT switch

Switch the signal input jack from i HDV/DV jack, S VIDEO jack, and VIDEO jack.

HDV/DV : Inputs a signal from i HDV/DV jack.

S VIDEO : Inputs a signal from S VIDEO jack.

VIDEO : Inputs a signal from VIDEO jack.

Notes

- Do not change the setting of this switch while recording in progress, or it causes noise added to images and sounds. Also, a part of the tape where the change of setting applied will not be recorded properly. The time code may be recorded discontinuously.
- If you change the setting of this switch while recording in progress, the output signal via i HDV/DV jack may be interrupted. Also, the unit may detect signals such as a copyright information signal incorrectly.
- When a signal is input via i HDV/DV jack, the settings of the menu listed below are unavailable.
 - 60i/50i SEL
 - AUDIO MODE
 - AUDIO LOCK
 - AUDIO INPUT LEVEL (–10/–2/+4) switch
 - AUDIO REC LEVEL control knob
 - AUDIO INPUT (AUTO/MANU) switch

10 INDEX/(A1) button

Press this button to write an index mark while recording. Index is useful when you search for scenes on a tape. Also, this button can be used as ASSIGN (A1) button.

For detail on Index, see “Recording Functions” on page 47.

When you change ASSIGN buttons setting with [ASSIGN (A1)] of [ASSIGN BTN] in [OTHERS] menu, this button executes the function you have set.

For details on ASSIGN buttons, see “ASSIGN BTN” on page 77.

11 DISPLAY OUTPUT switch

Selects the destination for the text data to be superimposed via output jacks.

OFF : Does not superimpose text data to output

S VIDEO/VIDEO : Superimposes text data to S VIDEO OUT jack and VIDEO jack.

ALL : Superimposes text data to HDMI OUT jack, COMPONENT OUT jacks, S VIDEO OUT jack, and VIDEO OUT jack.

12 EJECT button

Press this button to eject a cassette. If you press this button while a cassette is inside the unit, the cassette is ejected.

13 Cassette compartment

Insert a standard-size or mini-size cassette.

For details on cassettes that can be used, see “Notes on Power Supply and Video Cassettes” on page 30.

Location and Function of Parts

1 Monitor display section

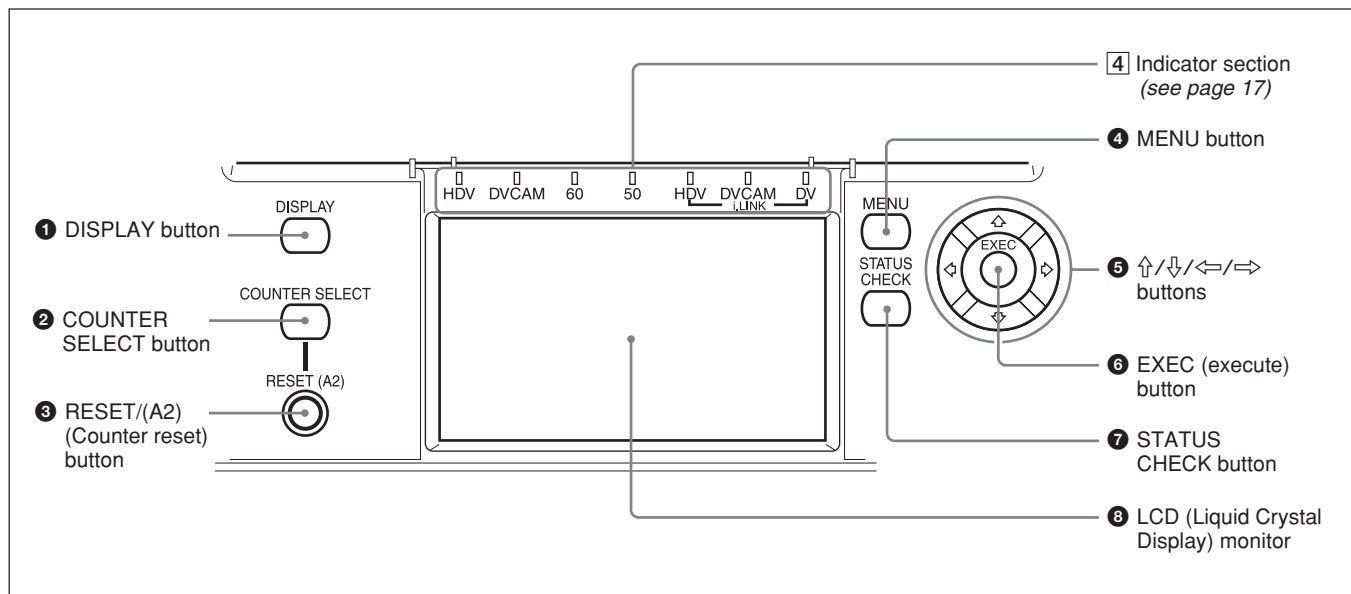

1 DISPLAY button

Change the text data displayed on LCD monitor or the text data output from video jacks on the rear panel of the unit. By pressing this button, the unit displays the picture only, picture and data, or picture and time counter.

For details on various data, see “Displaying Various Data” on page 25.

2 COUNTER SELECT button

While displaying the data or time counter, press this button to change the time counter display in the order of time code, user bits, and tape counter. Count value of the tape counter (seven digits) is displayed on a ± 12 -hour cycle.

Note

The count value of the counter of the unit is determined by calculation based on the time code, that is, simple approximation. Therefore, in cases such as the following, the value may be inaccurate.

- There is a portion where the time code is not continuous on the tape you are using.
- The time code in both the drop frame mode and the non-drop frame mode are recorded on the tape you are using (for 60i only).
- There is a blank portion between recorded portions on the tape you are using.

- A tape recorded using 50i system is being used in the unit when [60i/50i SEL] in [OTHERS] menu is set to [60i].
- A tape recorded using 60i system is being used in the unit when [60i/50i SEL] in [OTHERS] menu is set to [50i].
- [TC RUN] in [TC/UB SET] menu is set to [FREE RUN].

3 RESET (Counter reset)/(A2) button

Press this button, when the count value of the counter is displayed. The count value is reset to 0:00:00:00. Also, this button can be used as ASSIGN (A2) button. When you change ASSIGN button setting with [ASSIGN (A2)] of [ASSIGN BTN] in [OTHERS] menu, this button executes the function you have set. For details on ASSIGN buttons, see “ASSIGN BTN” on page 77.

Notes

- This button does not reset the value of the time code or user bits.
- To reset the value of the time code or user bits, use [TC PRESET] or [UB PRESET] in [TC/UB SET] menu.

4 MENU button

Press this button to display the menu on screen.

For details on the menu, see “Operating the Menus” on page 65.

5 $\uparrow/\downarrow/\leftarrow/\rightarrow$ buttons

Use these buttons in menu settings and other settings.

You can adjust the brightness of images by pressing \uparrow/\downarrow buttons, while the data (format, the tape running mode) is displayed on the LCD screen.

The display of the brightness level adjustment disappears in a second after the adjustment completes.

While the time counter is displayed, the position of the time counter moves up and down by pressing \uparrow/\downarrow buttons. When the small size time counter is displayed, the position of the time counter moves not only to the up and down, but also to the right and left by pressing \leftarrow/\rightarrow buttons.

While STATUS CHECK screen is displayed, you can switch the screen by pressing \uparrow/\downarrow buttons.

6 EXEC (execute) button

Use this button in menu settings.

7 STATUS CHECK button

Press this button to check the audio level and menu settings. To display STATUS CHECK screen, press STATUS CHECK button.

Every time you press \uparrow/\downarrow buttons, STATUS CHECK screen switches in the order of AUDIO, OUTPUT, ASSIGN, and CUSTOM REPEAT. To hide STATUS CHECK screen, press STATUS CHECK button again.

Note

Audio level meter display varies depending on the settings of [AUDIO MODE] in [AUDIO SET] menu, AUDIO OUTPUT SELECT switch, and the audio mode on the tape played back.

8 LCD (Liquid Crystal Display) monitor

Display the playback or EE¹⁾ pictures. Also, superimposed time data, status information, menus, audio level meters, etc. are displayed.

1) “EE” stands for “Electric to Electric.” In EE mode, the video and audio signals input to the VCR’s recording circuitry do not pass through any magnetic conversion circuits but output via electric circuits only. This mode is used to check the input signals and adjust input levels. The pictures output in EE mode are referred to as EE pictures.

2 Tape transport control section

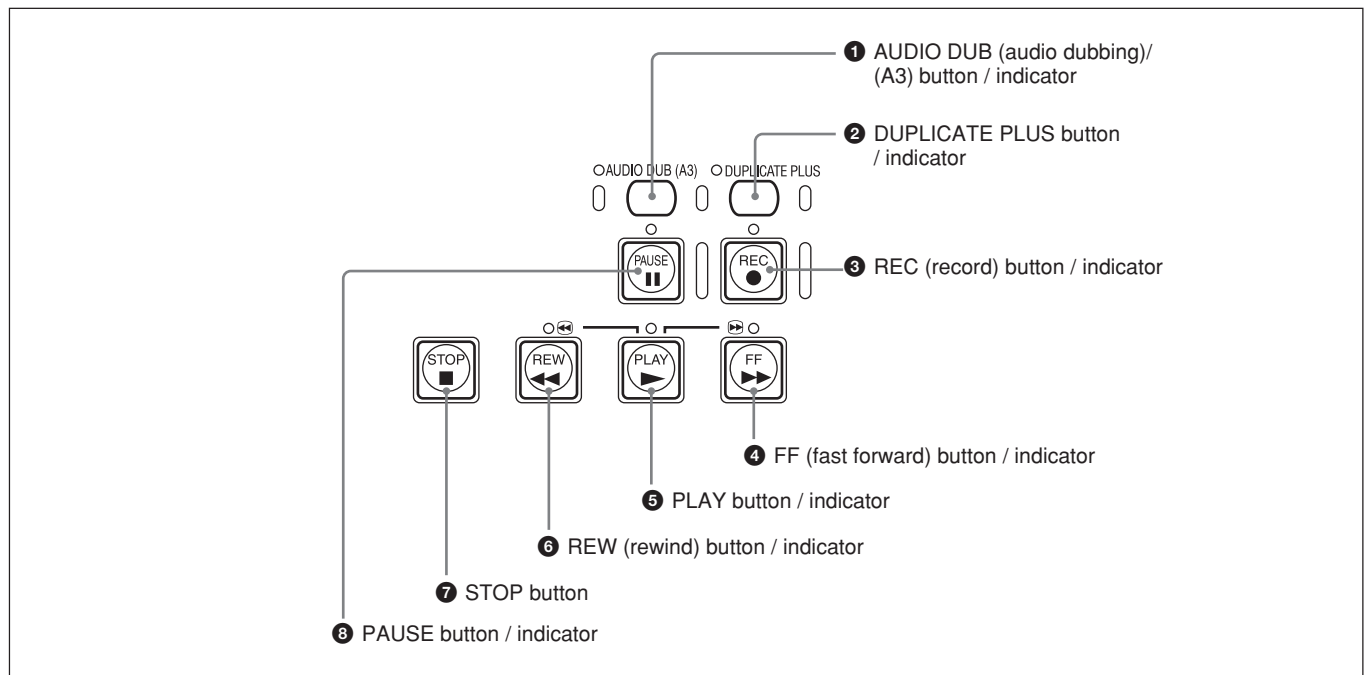

1 AUDIO DUB (audio dubbing)/ (A3) button / indicator

Use this button to dub sounds. The indicator lights while sounds are being dubbed. Also, this button can be used as ASSIGN (A3) button.

For details on audio dubbing, see “Audio Dubbing” on page 60.

When the unit is in the stop mode and INPUT SELECT switch is set to other than HDV/DV, you can check EE signals of the sound (channels 3 and 4) to be dubbed by pressing this button. While the operation is in progress, the indicator lights. To stop the operation, press STOP button.

For details, see “EE/PB SEL” in “IN/OUT REC” menu on page 71.

When you change ASSIGN buttons setting with [ASSIGN (A3)] of [ASSIGN BTN] in [OTHERS] menu, this button executes the function you have set.

For details on ASSIGN buttons, see “ASSIGN BTN” on page 77.

2 DUPLICATE PLUS button/indicator

Use to duplicate a tape, including the time code. While duplication is in progress, the indicator lights.

For details on the duplicate function, see “Duplication (generating a work tape with the same time code)” on page 56.

When the unit is in the stop mode and HDV/DV signals is selected and input, you can check EE signals for an image, sound and time code by pressing this button. While you are checking EE signals, the indicator lights. To stop this operation, press STOP button.

For details, see “EE/PB SEL” in “IN/OUT REC” menu on page 71.

For details on time codes, see “HVR-M25U/M25N/M25E/M25P time codes” on page 53.

3 REC (record) button / indicator

When you press and hold this button, then press PLAY button, the each indicator lights and recording starts. If you press this button while the tape is stopped, you can check EE picture and audio signals for a moment.

When HDV/DV is selected, if [HDV/DV IN TC] in [TC/UB SET] menu is set to [EXTERNAL], you can also check the EE time code signals. Press STOP button to end the check.

For details, see “EE/PB SEL” in “IN/OUT REC” menu on page 71.

For details on time code, see “TC/UB SET” on page 75.

Notes

- The unit does not have an LP recording mode of the consumer DV format. Only SP recording mode is available.
- To set the unit to recording pause mode with the remote control unit DSRM-10 (not supplied), press PAUSE button while holding down PLAY button to set the unit to the playback pause mode, then press REC button on the DSRM-10.
- When the recording mode is set in HDV format, it may take a few seconds to start recording. During this time, REC indicator blinks.

4 FF (fast forward) button / indicator

When you press this button, the indicator lights and the tape is fast forwarded. During fast forward, the picture does not appear on the monitor. (you can see the picture as it is seen in EE mode during fast forward.) To locate a scene while monitoring the picture, keep pressing this button during fast forward, playback or in playback pause mode (picture search).

For details on [VTR SET] menu, see “VTR SET” on page 74.

Notes

- If you set [EE/PB SEL] in [IN/OUT REC] menu to [PB], EE picture and EE audio signals are not output.
- If you set [FF/REW SPEED] in [VTR SET] menu to [SHUTTLEMAX], the picture is played back during fast forward.

For details on running speed with [SHUTTLEMAX], see “FF/REW SPEED” in “VTR SET” menu on page 74.

5 PLAY button / indicator

When you press this button, the indicator lights and playback begins.

If you press this button while holding down REW button during stop, the tape is rewound to its beginning and starts playing automatically (during rewind, REW indicator lights and PLAY indicator blinks).

Notes

- When the unit is playing back a part of the tape where the recording format has been changed among HDV format, DVCAM format, and DV format, or between 60i format and 50i format, the picture and sound may be distorted.
- The unit cannot play back a tape recorded in the LP recording mode of the consumer DV format.

6 REW (rewind) button / indicator

When you press this button, the indicator lights and the tape starts rewinding. During rewind, the picture does not appear on the monitor. (you can see the picture as it is seen in EE mode during rewind.) To locate a scene while monitoring the picture, hold this button down during rewind, playback or in the playback pause mode.

If you press PLAY button while holding down this button during stop, the tape is rewound to its beginning and starts playing automatically (during rewind, REW indicator lights and PLAY indicator blinks).

For details on [VTR SET] menu, see “VTR SET” on page 74.

Notes

- If you set [EE/PB SEL] in [IN/OUT REC] menu to [PB], EE picture and EE audio signals are not output.
- If you set [FF/REW SPEED] in [VTR SET] menu to [SHUTTLEMAX], the picture is played back during fast forward.

For details on running speed with [SHUTTLEMAX], see “FF/REW SPEED” in “VTR SET” menu on page 74.

7 STOP button

Press this button to stop the tape transport operation completely.

8 PAUSE button / indicator

Press this button to set the unit to pause mode. The indicator lights while recording, playing, or audio dubbing. Press this button again to resume the operation.

Location and Function of Parts

3 Audio control section

During normal recording, sounds are recorded onto channels 1 and 2; they cannot be recorded onto channels 3 and 4. During audio dubbing, sounds are dubbed onto channels 3 and 4.

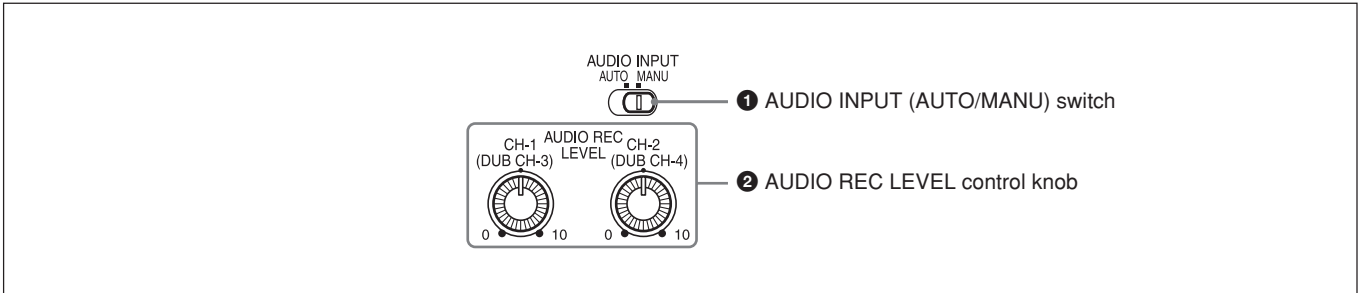

1 AUDIO INPUT (AUTO/MANU) switch

Switches the audio recording level adjustment mode.

AUTO : Adjusts AUDIO REC LEVEL automatically. (Adjustment of AUDIO REC LEVEL control knobs 2 is disabled.)
 For acceptable recording level, see the table below.

AUDIO INPUT LEVEL switch	Acceptable level (max.)
-10	+18 dBu
-2	+24 dBu
+4	+30 dBu

MANU : Enables AUDIO REC LEVEL control knobs 2.

Notes

- When i.LINK signals are input to the unit, the sound recorded retains the signal level input, regardless of the setting of this switch.
- Even this switch is set to AUTO, the setting is not effective against the volume which exceeds the dynamic range of the input amplifier.
- If you input a sound whose level exceeds the acceptable range, the recorded sound is distorted.

2 AUDIO REC LEVEL control knobs (CH-1 (DUB CH-3), CH-2 (DUB CH-4))

To perform normal recording using these knobs, adjust the levels of the analog audio signals input to the unit (channel 1 and 2). To perform audio dubbing using these knobs, adjust the levels of channel 3 and 4. These knobs are enabled only when AUDIO INPUT (AUTO/MANU) switch 1 is set to MANU. To display the audio level meters on LCD monitor, press STATUS CHECK button.

For details on the audio level meter, see "STATUS CHECK screen" on page 27.

Note

You cannot adjust the audio level using these knobs while i.LINK signals is input.

4 Indicator section

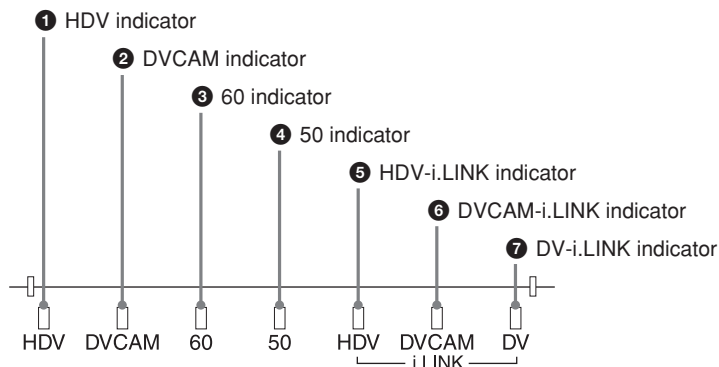

1 HDV indicator

Lights when the unit is in the following operating status.

- When a tape recorded in HDV format is being played back.
- When HDV signals are input through the i.LINK interface.
- When [HDV/DV SEL] in [IN/OUT REC] menu is set to [HDV].*

* Even when [HDV/DV SEL] in [IN/OUT REC] menu is set to [AUTO] with no signal input, while the last signal input was HDV format or the last tape played was HDV format, this indicator lights.

2 DVCAM indicator

Lights when the unit is in the following operating status.

- When a tape recorded in DVCAM format is being played back.
- When [HDV/DV SEL] in [IN/OUT REC] menu is set to [DV] and [REC MODE] in [IN/OUT REC] menu is set to [DVCAM] (during recording or in EE mode).*

* Neither HDV indicator nor DVCAM indicator lights during recording in DV (SP) format or a playback of a tape recorded in DV (SP) format.

3 60 indicator

Lights when the unit is in the following operating status.

- During recording or in EE mode when [60i/50i SEL] in [OTHERS] menu is set to [60i].
- During HDV1080/60i or NTSC signals are input from HDV/DV jack.
- A tape that has HDV1080/60i or NTSC signals is being played back.

4 50 indicator

Lights when the unit is in the following operating status.

- During recording or in EE mode when [60i/50i SEL] in [OTHERS] menu is set to [50i].
- During HDV1080/50i, or PAL signals are input from HDV/DV jack.
- A tape that has HDV1080/50i or PAL signals is being played back.

5 HDV-i.LINK indicator

Lights when HDV signals are input/output through the i.LINK interface.

6 DVCAM-i.LINK indicator

Lights when DVCAM signals are input/output through the i.LINK interface.

7 DV-i.LINK indicator

Lights when DV signals are input/output through the i.LINK interface.

Location and Function of Parts

Rear Panel

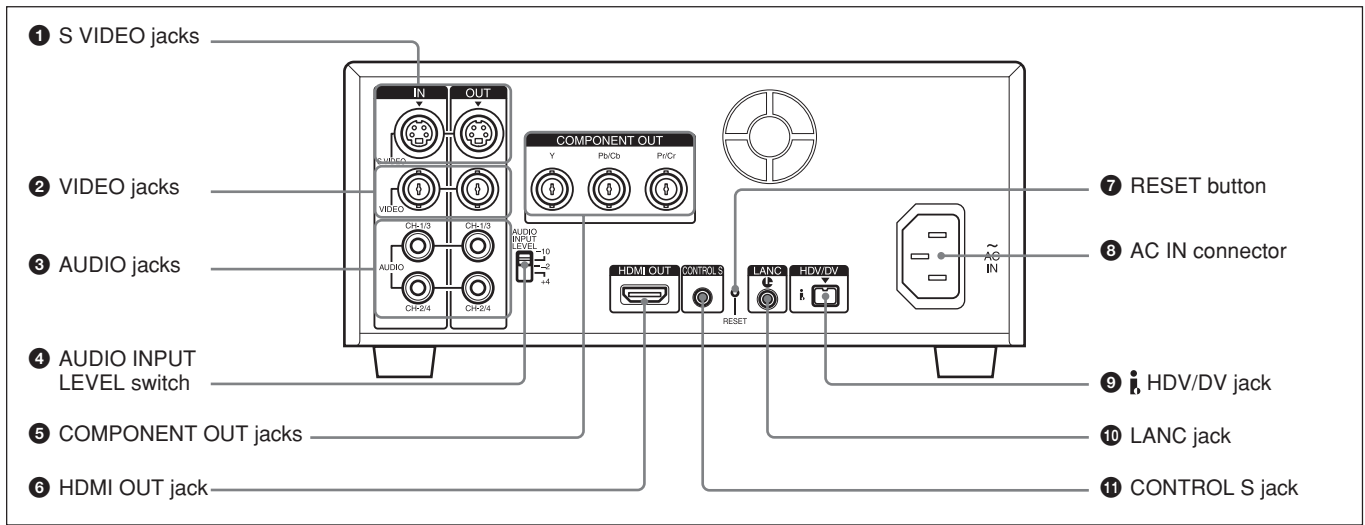

1 S VIDEO jacks

To connect a device equipped with S video jack, use S VIDEO jacks on the unit.

If you use S VIDEO jacks, you can input/output high-quality video with less signals deterioration in quality than the one connected to the standard VIDEO jack. When DISPLAY OUTPUT switch is set to S VIDEO/VIDEO or ALL, text data such as the time code, menus, and alarm messages are superimposed on an external monitor connected to S VIDEO jack (page 25).

For details on the output of S VIDEO jack, see “Notes on all video output jacks” (page 22).

2 VIDEO jacks

Use to input and output analog video signals.

Text data is superimposed on a monitor in the same way as S VIDEO jack connection (page 25).

For details on the output of VIDEO jack, see “Notes on all video output jacks” (page 22).

3 AUDIO jacks

Use to input and output analog audio signals.

During normal recording, sounds are recorded onto channels 1 and 2. During audio dubbing, sounds are dubbed onto channels 3 and 4. When the audio mode is FS32K (4 channel), if you set AUDIO OUTPUT SELECT switch to MIX, the audio output level becomes 50% (-6 dB) of the original audio level on each channel.

Notes

- In the audio dubbing mode, CH1/3 and CH2/4 jacks function as the channel 3 and channel 4 input jacks, respectively.

- To input balanced audio signals via AUDIO jacks, use a conversion cable as shown below. (The COLD side is open.)

For details on conversion cables, refer to the instruction manual of the devices you use.

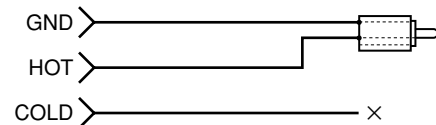

4 AUDIO INPUT LEVEL (-10/-2/+4) switch

Select one from -10 dB, -2 dB, or +4 dB according to the audio level of the signal input via AUDIO IN jacks.

Note

If this switch setting is not appropriate, clipping distortion or noise may occur.

For more information on the setting of this switch, see “When you set AUDIO INPUT LEVEL switch” on page 86.

5 COMPONENT OUT jacks



Use to output component signals.

To connect a device equipped the component video input connector, use COMPONENT OUT jacks on the unit. If you use COMPONENT OUT jacks, you can output high-quality video with less signal deterioration in quality than S VIDEO jack.

You can set the output video format by using [HDMI/CMPNT] of [VIDEO OUT] in [IN/OUT REC] menu.

When DISPLAY OUTPUT switch is set to ALL, text data such as time code, menu, and alarm message are superimposed on a monitor connected using COMPONENT OUT jacks (page 25).

Notes

- When images are output in 720p format, some of the text image data (outer frame: underscan portion) on the monitor may appear cut out. In this case, check the text image data on LCD monitor of the unit or on a monitor using S VIDEO OUT jack or the VIDEO OUT jack. Also, when your monitor has an underscan function, you can check all the text data on the monitor during underscan.
 - When you change the video format setting of [HDMI/CMPNT] of [VIDEO OUT] in [IN/OUT REC] menu, the video signal output from S VIDEO jack, VIDEO jack, or  HDV/DV jack may be distorted for a moment.
 - When you play back an HDV-formatted tape with copyright protected signals or input HDV signals with copyright protection to  HDV/DV jack, pictures may be output in either 480i (NTSC) or 576i (PAL) format, regardless of the setting of [HDMI/CMPNT] of [VIDEO OUT] in [IN/OUT REC] menu.
 - When you play back a tape in DVCAM/DV format and while an EE picture in NTSC/PAL is displayed, the 480i resolution or the 576i resolution is output, regardless of the setting of [HDMI/CMPNT] of [VIDEO OUT] in [IN/OUT REC] menu.
- The output level of COMPONENT OUT jacks is as follows:
 - Output at 480i NTSC
 - With [BETACAM] selected in [IN/OUT REC] menu
 - Y: 1.0 Vp-p
(with 0.286 Vp-p sync negative, output impedance 75 Ω (ohms), unbalanced)
 - Pb/Cb/B-Y, Pr/Cr/R-Y: 0.7 Vp-p
(output impedance 75 Ω (ohms), unbalanced)
(75% color bars with 7.5 IRE setup)
 - With [SMPTE] selected in [IN/OUT REC] menu
 - Y: 1.0 Vp-p
(with 0.3 Vp-p sync negative, output impedance 75 Ω (ohms), unbalanced)
 - Pb/Cb/B-Y, Pr/Cr/R-Y: 0.7 Vp-p
(output impedance 75 Ω (ohms), unbalanced)
(100% color bars with no setup)
 - Output with other settings
 - Y: 1.0 Vp-p
(output impedance 75 Ω (ohms), unbalanced)
 - Pb/Cb/B-Y, Pr/Cr/R-Y: 0.7 Vp-p
(output impedance 75 Ω (ohms), unbalanced)
(100% color bars with no setup)
 - 480i/480p:
 - Y: with 0.3 Vp-p sync negative
 - 1080i/720p:
 - Y/Pb/Pr: with 0.6 Vp-p 3-level sync

(Continued)

Location and Function of Parts

6 HDMI OUT jack

Use to output HDMI signals. HDMI OUT jack outputs both pictures and audio.

To connect a device which equipped HDMI input connector, use HDMI OUT jack on the unit.

HDMI OUT jack outputs high-quality video with even less signal deterioration in quality than COMPONENT OUT jacks.

You can set the output video format by using [HDMI/CMPNT] of [VIDEO OUT] in [IN/OUT REC] menu.

Text data is superimposed on a monitor in the same way as COMPONENT OUT jacks connection (*page 25*).

Notes

Use an HDMI cable with HDMI logo.

When you connect the unit with other device, some of the devices do not display pictures or sounds. Also, when you connect the unit in the way described below, the unit or the device connected to the unit may be damaged.

- When HDMI OUT jack on the unit is connected to the HDMI OUT jack on the device.
- When HDMI OUT jack on the unit is connected to the HDMI OUT jack of the same unit.

There are following restrictions on the output of HDMI OUT jack.

- When you play back an HDV-formatted tape with copyright protected signals or input HDV signals, including copyright protected signals via **i** HDV/DV jack, pictures and audio cannot be output from HDMI OUT jack. (Copy-protected signals and programs such as digital broadcasts are also included.)
- You cannot output EE picture of analog video (NTSC, PAL) that are input from VIDEO IN jack, S VIDEO IN jack to HDMI OUT jack. In this case, text data and menus cannot be displayed either. When you play back a DVCAM or DV (SP)-formatted tape recorded in either NTSC or PAL format, pictures are output to HDMI OUT jack.
- You cannot output EE picture and sound of DVCAM/DV signals (NTSC, PAL) that are input from **i** HDV/DV jack to HDMI OUT jack.
- Sounds output via HDMI OUT jack of the unit is 2-channel (stereo). In case of playing back a tape recorded in 4-channel (32 kHz), audio recording, or pausing audio recording, to output the sound of CH3 and CH4 during post recording, select CH-3/4 with AUDIO OUTPUT SELECT switch. By selecting MIX with this switch, mixed sounds can be output to HDMI OUT jack as well.

- Sounds output via HDMI OUT jack are output with 16 bit of 48 kHz, 2-channel linear PCM mode regardless of the tape played back, the setting of the menus, or the signal format input to **i** HDV/DV jack.
- When images are output in 720p format, some of the text image data (outer frame: underscan portion) on the monitor may appear cut out. In this case, check the text image data on LCD monitor of the unit or on a monitor using S VIDEO OUT jack or VIDEO OUT jack. Also, when your monitor has an underscan function, you can check all the text data on the monitor during full screen underscan.
- When you change the video format setting of [HDMI/CMPNT] of [VIDEO OUT] in [IN/OUT REC] menu, the video signal output from S VIDEO jack, VIDEO jack, or **i** HDV/DV jack may be distorted.
- If a monitor or other device connected to the unit does not have a resolution display mode selected with [HDMI/CMPNT] of [VIDEO OUT] in [IN/OUT REC], noise may occur on the picture of the monitor, or a humming noise may be output from the speakers. Also, the picture may not be displayed or the sound may not be output. Be sure to check the displayable resolutions of the monitor by referring the operational instructions of your monitor, and select the appropriate menu for the unit.
- Depending on the monitor you have, the picture and sound on the monitor may be distorted when you change the resolution of the picture. This is not a malfunction.
- Some monitors have a specification that does not allow them to display personal contents (such as a movie recorded for private use) played on the unit. To play the video properly, use COMPONENT OUT jacks or VIDEO jacks to connect the monitor and the unit.

7 RESET button

If you press this button with the tip of a ballpoint pen or similar tool, the following settings are initialized.

- [CLOCK SET] (*page 78*) and [60i/50i SEL] (*page 79*) in [OTHERS] menu.
- The setting on the unit except the menu settings.

8 AC IN connector

Connects to an AC outlet using the supplied power cord.

Even if the unit is in the standby mode, it consumes power. To turn the unit off completely, pull the plug out from the AC outlet.

9 HDV/DV jack (4-pin)

Use this jack to input/output the digital signals that complies with the i.LINK standard. Use when a device connected to the unit has an i.LINK jack. If you connect the unit and another device using  HDV/DV jack, you can minimize deterioration of picture quality during recording, dubbing, or capturing still pictures, all by means of digital signals processing.

For details, refer to the instruction manual of the external device.

Notes

- When you connect with the i.LINK cable to a computer and the unit, check the direction of the jack. If you forcibly insert the jack, the terminal may be damaged or cause the unit to malfunction. Align ▲ mark of the i.LINK cable with ▼ mark on the unit and insert the i.LINK cable.
- This jack is only compatible with HDV (1080i)/DVCAM/DV signals.

For details, see “About i.LINK” on page 98.

- If video signals have been input to  HDV/DV jack and you output these video signals to the S VIDEO or VIDEO connectors, the sync and burst of the corresponding EE picture is not synchronized.
- If the unit is connected to a device equipped with an i.LINK jack, when you intend to disconnect or reconnect the i.LINK cable, turn off the device and pull out the plug of its power cord from the AC outlet beforehand. If you connect or disconnect the i.LINK cable while the device is connected to the AC outlet, high-voltage current (8 to 40 V) is output from i.LINK jack of the device to the unit. This may cause a malfunction.
- When connecting a device that has a 6-pin i.LINK jack to the unit, connect the plug of the cable to the 6-pin i.LINK jack first.

For details on each setting when HDV/DV signals are input, see “HDV/DV SEL” (page 67).

- Video signal which is input from  HDV/DV jack will be output directly to COMPONENT OUT jacks, S VIDEO jack, and VIDEO jack with the jitter of i.LINK signal. This jitter may be displayed on the connected monitor. Be aware of this jitter when you connect other recording device to for these jacks. This jitter will not appear on a recording with the unit.

- When you change the video format setting of [HDMI/CMPNT] in [VIDEO OUT] of [IN/OUT REC] menu, the video signal output from S VIDEO OUT jack, VIDEO OUT jack, or  HDV/DV jack may be distorted.

For details on the output of  HDV/DV jack, see “Notes on all video output jacks” (page 22).

10 LANC jack

Use this jack when controlling the tape transport operation of the unit using a device that has a LANC¹⁾ jack.

Notes

- LANC jack on the unit has only LANC-S functions. The unit has no LANC-M functions. A device that is set to LANC-S mode cannot be connected to the unit. Either this, the unit or the other device may not operate properly.
- When using the unit as a player, set LANC mode on the recorder to M. A VCR that does not have M/S switching function cannot be used to control the unit.
- When the device for connecting to the unit has [LANC-M] function to switch between SHUTTLE A/B, select SHUTTLE A for HDV-formatted tape, and SHUTTLE B for the DVCAM/DV (SP)-formatted tape.
- LANC connection transmits command signals for playback, stop, pause playback, as well as the time code, tape counter, and data status of the unit.
- Jacks labeled CONTROL L have the same function as LANC jacks.
- There are some limitations when you edit an HDV-formatted tape.

Refer to the “Notes” in “Editing (Connecting with a Computer)” on page 62.

11 CONTROL S jack

Connect to a remote control unit DSRM-10 (not supplied) for controlling the unit.

You can use DSRM-20 (no longer manufactured: not supplied).

Note

When you use a CONTROL S device, set [COMMANDER] in [OTHERS] menu to [CONTROL S].

(Continued)

1) LANC (Local Application Control bus system):

Bidirectional interface used to control a consumer VCR

Notes on all video output jacks

- When you change the video format setting of [HDMI/CMPNT] and [DOWN CONVERT] of [VIDEO OUT] in [IN/OUT REC] menu, [ALLSCAN MODE] in [DISPLAY SET] menu, or [HDV → DV CONV] and [DOWN CONVERT] in [i.LINK SET], the image may be distorted for a moment. Also, the above settings may cause the restrictions on the video output of the unit.

For details, refer to the table on page 85 and the instructions of each menu setting.

- When you change the video format setting of [HDMI/CMPNT] of [VIDEO OUT] in [IN/OUT REC] menu, the video signals output from S VIDEO OUT jack, VIDEO OUT jack, or  HDV/DV jack may be distorted.
- The unit is only compatible with standard video signals. If you input the types of video signals shown below, recorded picture and sound may be distorted.
 - Signals from some home game machines
 - Blue background screen or gray background screen from a consumer VCR
 - Pictures played at a speed other than normal by a VCR that does not have the TBC (Time Base Corrector)
 - Video signals in which the sync signals are distorted
 - Signals from a defective cassette (tape or recording condition is bad) played by an analog VCR that does not have TBC
- To absorb the jitter of input video signals, the distortion of video signals are processed in the underscan portion. You may see this procedure on an underscan monitor, yet this is not a malfunction. Also, the picture recorded on the tape will not be affected.
- During recording or in EE mode, the subcarrier of the color signal to be output from the unit is not synchronized with the horizontal sync signal. The color of the picture or the horizontal position of the picture may be distorted depending on the type of monitor connected to the unit.
- To output video signals to VIDEO, S VIDEO, or COMPONENT OUT jacks without text data, set DISPLAY OUTPUT switch to OFF, or press DATA CODE or SEARCH SELECT button on the remote commander.

Supplied Remote Commander

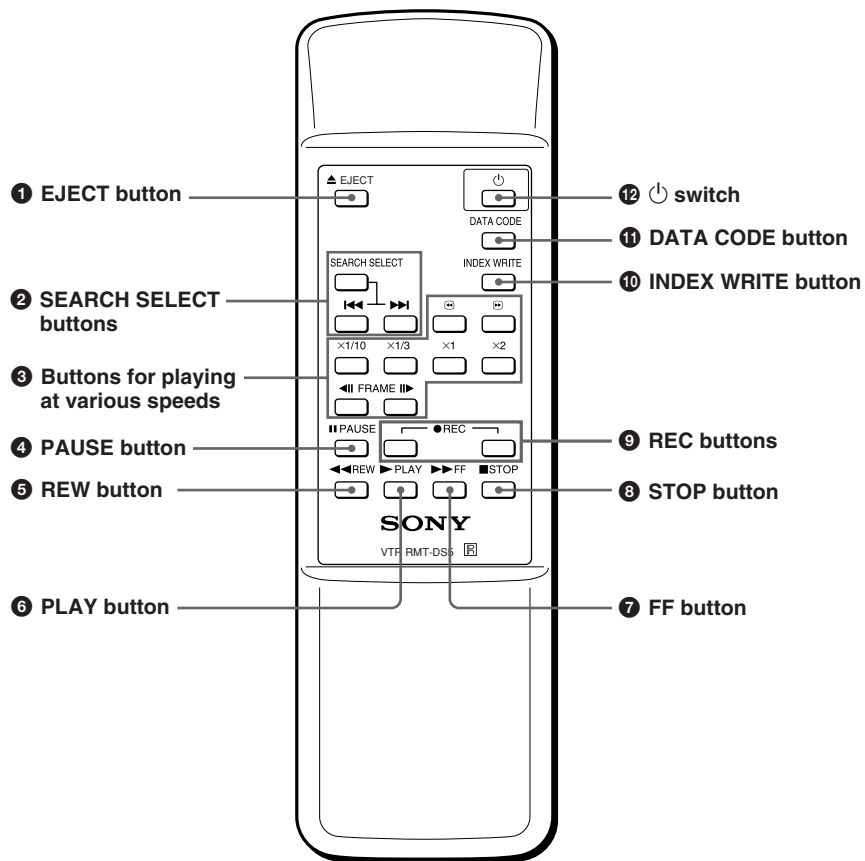

1 EJECT button

2 SEARCH SELECT buttons

Press these buttons to search for scenes using the search function.

For details on the search function, see “Searching using the search function” on page 38.

3 Buttons for playing at various speeds

You can play back a tape at normal speed or at a speed other than normal with these buttons.

For details, see “Playing at various speeds” on page 37.

4 PAUSE button

5 REW (rewind) button

6 PLAY button

7 FF (fast forward) button

8 STOP button

9 REC (record) buttons

When you press both these buttons at the same time, REC indicator and PLAY indicator on the front panel light and recording begins.

10 INDEX WRITE button

Press this button during recording to mark an index. For details on an index, see “Marking an index” on page 47.

11 DATA CODE button

Press this button to display the data codes (recording date/time, camera data).

For details on data codes, see “Displaying information (data codes) recorded on a tape” on page 36.

12 power (on/standby) switch

(Continued)

Location and Function of Parts

Notes

- The command mode of the supplied Remote Commander is set to VTR4. You cannot change command mode setting.
- Set [COMMANDER] in [OTHERS] menu to [WIRELESS] to enable Remote Commander to control the unit.
- In addition to Remote Commander supplied with the unit, the unit accepts signals from any Sony Remote Commander whose command mode is set to VTR4. To disable the control from Remote Commander, set [COMMANDER] in [OTHERS] menu to [CONTROL S].

Notes on batteries

- Make sure that the battery orientation is correct when inserting batteries.
- Do not mix an old battery with a new one, or mix different types of batteries.
- If you do not intend to use Remote Commander for a long time, remove the batteries to avoid damage from battery leakage. If the batteries have leaked, remove them, wipe the battery compartment dry and replace the batteries with new ones.

To remove the batteries

Remove the lid as step 1 and take out the batteries.

Battery installation

- 1 Push and slide the lid to open.

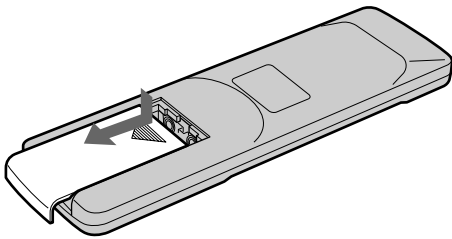

- 2 Install two size AA (R6) batteries (supplied) with the correct polarity.

Be sure to install the battery from the ⊖ side.

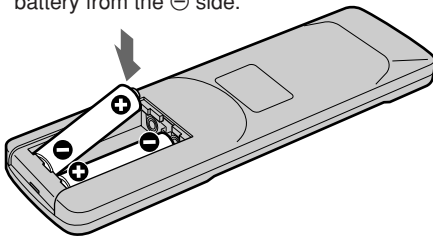

- 3 Put the lid back.

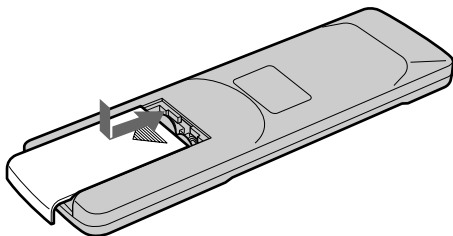

WARNING

Battery may explode or leak if mistreated. Do not recharge, disassemble or dispose of in fire. Check the valid date (month-year) displayed on the batteries.

Displaying Various Data

The unit can display various superimposed text data on the built-in LCD monitor and also an external monitor connected to the unit.

To display text data on an external monitor, set DISPLAY OUTPUT switch to ALL or S VIDEO/VIDEO. You can turn ON/OFF various text data display by pressing DISPLAY button.

In this operation manual, the menu screen etc. is displayed in English. You can change the desired language with the screen language setting.

For details, see page 77.

Note

When images are output in 720p format, some of the text image data (outer frame: underscan portion) may appear cut out, depending on the displayable range of the monitor. In this case, check the text image data on LCD monitor of the unit or on a monitor using S VIDEO OUT jack or VIDEO OUT jack. Also, when your monitor has an underscan function, you can check all the text data on the monitor during the underscan.

Menu screen

Press MENU button to display the menu screen.
For details on the menu, see "Chapter 5 Adjusting and Setting Through Menus" on page 65.

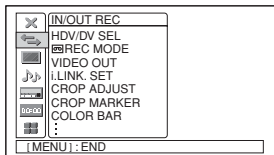

Data display screen

You can display the picture, picture and data, or picture and the time counter on the data screen by pressing DISPLAY button when the unit is turned on.

Data display

You can confirm important information for normal recording or playback, such as time code or remaining tape time, on the screen.

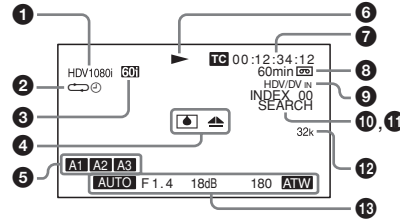

1 Format indicator

[HDV1080i], [DVCAM], or [DV SP] are displayed.

2 Repeat indicator

Displays a repeat indicator when TIMER switch is set to REPEAT. When [START TIME] of [CUSTOM REPEAT] is set to [ON] in [VTR SET] menu, ⊖ is also displayed (page 10).

3 60i/50i indicator

4 Alarm indicator

Displays an alarm indicator.

For details on alarm indicators, see "Warning indicators and messages" on page 87.

5 ASSIGN buttons indicator

Displays ASSIGN button indicator when each ASSIGN button is set other than default functions.

For details on "ASSIGN buttons", see page 77.

6 Tape transport mode indicator

Displays the tape transport mode.

(Continued)

Displaying Various Data

7 Time counter (time code/user bits/count value of the counter) indicator

Displays the count value of the counter, time code, or user bits. By pressing the COUNTER SELECT button on the front panel, you can select the item to be displayed.

When the time code is displayed, **TC** appears to its left. In the drop frame mode, a period is displayed between the minutes and seconds (i.e., 00:12.58:00).

When the user bits are displayed, **UB** appears to their left.

When the count value of the counter is negative, “-” appears as the first digit (leftmost digit). When that value is positive, the first digit is blank.

The count value of the counter consists of seven digits. If the self-diagnostic function is enabled, diagnostics code numbers are displayed.

Note

When you playback a tape without a time code or with a time code recorded in different formats, the time code cannot be displayed correctly.

8 Remaining tape time indicator

Displays the remaining tape time.

For details, see “**REMAINING**” on page 72.

Note

When you insert a cassette in which the tape has been rewound to the beginning, this indicator does not show the remaining tape time. The remaining tape time is displayed after the tape runs for a while.

9 INPUT SELECT indicator

Changes according to the position of INPUT SELECT switch. ([HDV/DV IN], [S VIDEO IN] or [VIDEO IN])

10 **■** (Index) indicator

Displays **■** when an index has been marked.

11 Search indicator

Displays the search mode when you search for scenes using Remote Commander.

For details on the search function, see “Searching using the search function” on page 38.

12 Audio mode indicator

In the recording mode, displays 32k when you select [FS32K] for [AUDIO MODE] in [AUDIO SET] menu. When you select [FS48K], 48k is displayed. During playback or audio dubbing, displays the audio mode recorded on the tape. During i.LINK input, displays the audio mode of the signal input to **i** HDV/DV jack.

Notes

- The audio mode will not be displayed when [HDV/DV SEL] in [IN/OUT REC] menu is set to [HDV].
- Signals other than HDV/DVCAM lock mode will become non-standard audio and NS32k/NS48k is displayed during playback or when the signal is input from **i** HDV/DV jack.

13 Date/time and camera data indicator

When you press DATA CODE button of Remote Commander or set [DATA CODE] in [DISPLAY SET] menu to [DATE] or [CAMERA DATA], you can switch the display between recording date/time and camera data.

For details on the date/time and camera data indicator, see “Displaying information (data codes) recorded on a tape” on page 36.

Time counter screen

To display the time counter on LCD panel, press DISPLAY button. On the time counter screen, it displays the time data (count value of the counter/time code/user bits).

While the time counter is displayed, the position of the time counter moves up and down by pressing **↑/↓** buttons. When the small size time counter is displayed, the position of the time counter moves not only to the up and down, but also to the left and right by pressing **←/→** buttons.

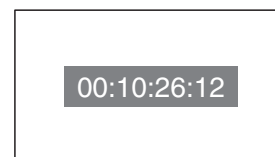

When the count value of the counter is negative, “-” appears as the first digit (leftmost digit). When that value is positive, the first digit is blank. When the format of the displayed time code is the drop frame mode, the drop frame indicator is displayed as a period between the minutes and seconds (i.e., 00:12.58:00).

When user bits are displayed, the space between hour, minute, and second becomes blanked.

Notes

- In the playback mode, if the tape has a portion where recorded signals are not continuous:
 - The count value of the counter may not advance correctly from that portion.
 - The displayed value of the time code or user bits may be temporarily inaccurate.
- When the unit plays back a part of the tape where the recorded system has been changed between 50i and 60i, the displayed value may be inaccurate.
- When the unit plays back a part of the tape where the recording format has been changed among HDV, DVCAM and DV, the displayed value may be inaccurate.
- The counter operates on a ± 12 -hour cycle. You cannot make the counter operate on a 24-hour cycle.
- The count value of the counter consists of seven digits. The tens place of the “hour” is not displayed. (i.e., If the actual count value is “11:22:11:22”, the displayed value will be “1:22:11:22.”) However, the unit recognizes that the hours value is “11”.

Setting the time counter

You can adjust the settings of the time counter display in [COUNTER SET] in [DISPLAY SET] menu.

DISPLAY : Selects whether to display the time counter or not.

SIZE : Selects the size of the time counter.

COLOR : Selects the color of the time counter.

For details on [COUNTER SET], see page 71.

STATUS CHECK screen

To display STATUS CHECK screen, press STATUS CHECK button.

Each time you press \uparrow/\downarrow button, STATUS CHECK screen switches in the order of AUDIO, OUTPUT, ASSIGN, and CUSTOM REPEAT.

To hide STATUS CHECK screen, press STATUS CHECK button again.

Audio Level Meter and Audio setting screen

Audio Level Meter and Audio setting screen is displayed when STATUS CHECK screen is set to [AUDIO].

This screen displays the audio level meter and the setting values of [AUDIO MONI] in [AUDIO SET] menu.

For details, see “AUDIO SET” on page 73.

Audio Level Meter

Audio Level Meter can be used to confirm and adjust the audio level. Audio Level Meter is displayed in different patterns, depending on the settings of [AUDIO MODE] and AUDIO OUTPUT switch.

The unit detects the audio mode as follows:

In the playback mode: Detects the audio mode recorded on the tape.

In the recording/EE mode: Detects the selected audio mode in [AUDIO MODE] in [AUDIO SET] menu.

When INPUT SELECT switch is set to HDV/DV and HDV or DV signals is being input: Detects the audio mode of the signals being input. (The setting of [AUDIO MODE] in [AUDIO SET] menu becomes invalid.)

Audio mode: 48 kHz (2-channel, 16 bits)

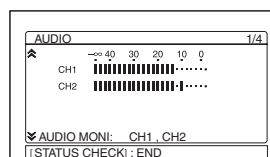

(The levels of two channels, channels 1 and 2, are displayed.)

Audio mode: 32 kHz (4-channel, 12 bits)

(a) When AUDIO OUTPUT SELECT switch is set to CH-1/2 or CH-3/4

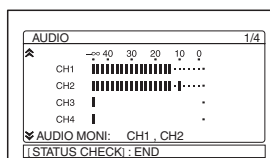

(The levels of four channels, channels 1 to 4, are displayed. During playback, if the sounds are recorded onto channels 3 and 4, their levels meters fluctuate. However, during normal recording, you cannot record sounds onto the channels 3 and 4.)

(Continued)

Displaying Various Data

- (b) When AUDIO OUTPUT SELECT switch is set to MIX

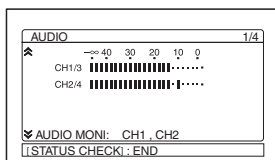

(The mixed level of channels 1 and 3 is displayed on CH1/3; that of channels 2 and 4 is displayed on CH2/4. The audio output level becomes 50% (-6 dB) of the original audio levels.)

- (c) When the unit is in the audio dubbing mode and AUDIO OUTPUT SELECT switch is set to CH-1/2 or CH-3/4

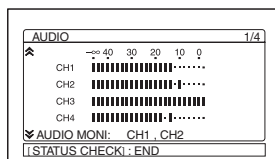

(The levels of playback sound are displayed on CH1 and CH2. The levels of input sound to be dubbed are displayed on CH3 and CH4. When AUDIO OUTPUT SELECT switch is set to MIX, the mixed level of the pair of channels 1 and 3 and that of channels 2 and 4 is displayed. The audio output level becomes 50% (-6 dB) of the original audio levels on each channel. In this case, the meters are as illustrated in (b) on this page. To check only the sound to be dubbed before dubbing, press AUDIO DUB button while the unit is in the stop mode. The level meters fluctuate only when the channels (channel 3 and 4) are selected for audio dubbing.)

Note

In EE, recording, or audio dubbing (only the channels used to dub) mode, if the input levels exceed 0 dB, the portions of the meters turn red. (However, when the audio mode is set to 32 kHz (4-channel, 12 bits), whereas AUDIO OUTPUT SELECT switch is set to MIX, the mixed audio levels that exceed 0 dB do not turn red.) During playback or while HDV/DV signals are input, the levels meters do not turn red.

OUTPUT screen

OUTPUT screen is displayed when STATUS CHECK is set to [OUTPUT].

You can confirm the setting values of [HDV/DV SEL] in [IN/OUT REC] menu, [HDMI/CMPNT] and [DOWN CONVERT] of [VIDEO OUT], and [HDV → DV CONV] and [DOWN CONVERT] of [i.LINK SET] in [IN/OUT REC] menu.

For details on OUTPUT settings, see "IN/OUT REC" menu on page 67.

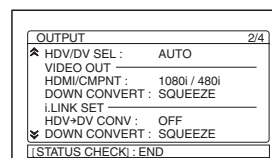

ASSIGN screen

ASSIGN screen is displayed when STATUS CHECK is set to ASSIGN.

You can confirm the setting values of [ASSIGN BTN] in [OTHERS] menu.

For details on ASSIGN buttons, see "ASSIGN BTN" on page 77.

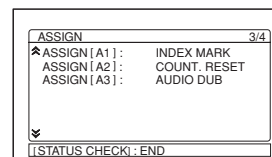

CUSTOM REPEAT screen

CUSTOM REPEAT screen is displayed when STATUS CHECK screen is set to [CUSTOM REPEAT].

The settings of [CUSTOM REPEAT] in [VTR SET] menu are displayed. While CUSTOM REPEAT is in progress, you can also confirm the current status of CUSTOM REPEAT.

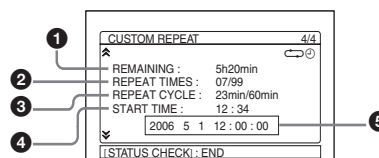

-
- ① **REMAINING** : displays the estimated remaining time of CUSTOM REPEAT.
 - ② **REPEAT TIMES** : displays the times that tape has played, and the total repeat times you have set in [REPEAT TIMES].
 - ③ **REPEAT CYCLE** : displays the playback time and the interval time of the tape which you have set in [REPEAT CYCLE].
 - ④ **START TIME** : displays the time CUSTOM REPEAT starts which you have set in [START TIME].
 - ⑤ **Date and time** : displays the date and time set by [CLOCK SET] in [OTHERS] menu is displayed, when [START TIME] is set to [ON].

Note

Items that have not been set up are displayed as [OFF].
For details on CUSTOM REPEAT, see “CUSTOM REPEAT” menu on page 74.

Playback and Recording

Notes on Power Supply and Video Cassettes

Usable cassettes

We recommend you to use a DigitalMaster™ cassette of standard HDV/DVCAM/DV cassette (such as PHDV-276DM), or mini HDV/DVCAM/DV cassette (PHDVM-63DM) for recording in HDV/DV format. We recommend you to use a standard DVCAM cassette, Mini-DVCAM cassette, or DigitalMaster™ shown above for recording in DVCAM format.

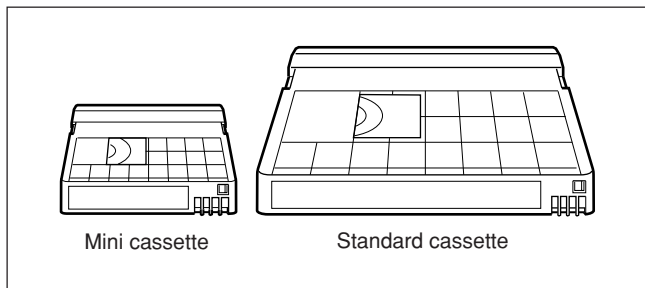

Cassette memory

Some mini cassettes and standard cassettes have the cassette memory (CIII mark). The unit, however, does not support cassette memory. However, if you use the DSR-25/45/50 as a recorder, the unit accesses cassette memory only if the recorder is set to [AUTO CIII].

To save a recording

To prevent accidental erasure of a recording, set REC/SAVE switch on the cassette to SAVE. To record or dub audio on a tape, set the switch to REC.

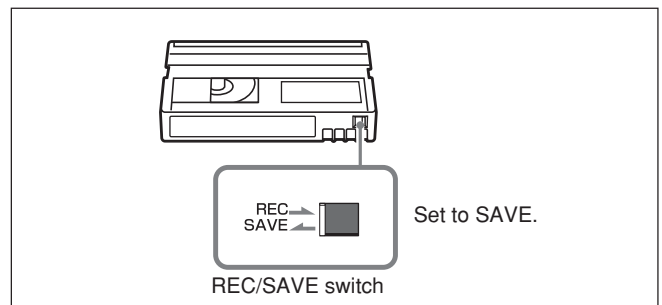

Checking the tape for slack

Using a paper clip or a similar object, turn the reel gently in the direction shown by the arrow. If the reel does not move, there is no slack.

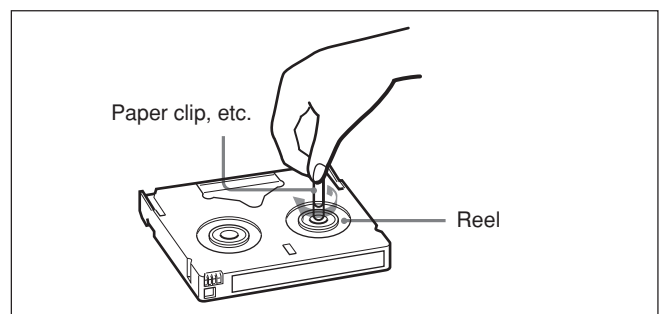

Preparing the Power Supply

Connect the power cord (supplied) to the AC IN connector. Then, connect the power plug to the wall outlet.

When you disconnect from the wall outlet, be sure to unplug the power plug from the wall outlet first. [CLOCK SET] screen appears when you turn on the unit for the first time.

For details on [CLOCK SET], see page 78.

Inserting/Ejecting Cassettes

To insert a cassette

Notes

- Do not insert the cassette forcibly. The unit may be damaged.
- Do not eject/load the cassette in a place subject to light. The internal sensor of the unit may operate incorrectly if too much light falls on the unit.

After checking the tape for slack, hold the cassette so that the tape window is facing upward, then insert it into the unit.

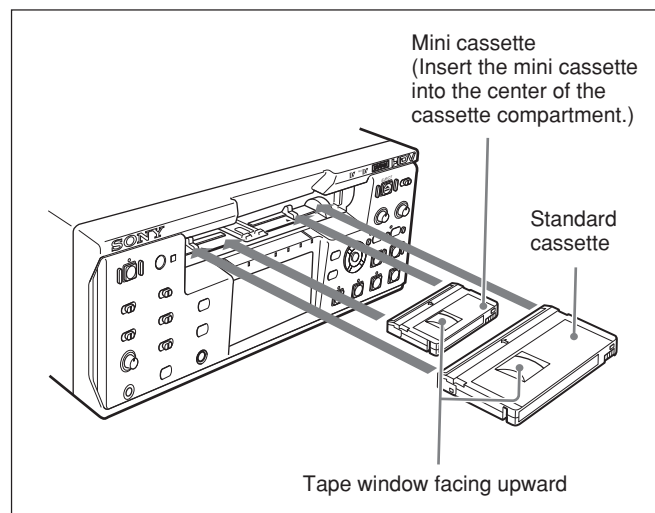

Notes

- When inserting a cassette, hold the back edge of the cassette in the center and push it until the cassette is inserted deep into the unit. If you hold the ends, the cassette may not be loaded properly.

- If the cassette does not load or is loaded only halfway, eject it once, then insert it again. In such a case, if you insert the cassette forcibly, the cassette may not be loaded properly or malfunctions may occur.
- It takes a few seconds for the unit to recognize the cassette and find the proper location on the tape being loaded.

To eject the cassette

With the unit powered on, press EJECT button.

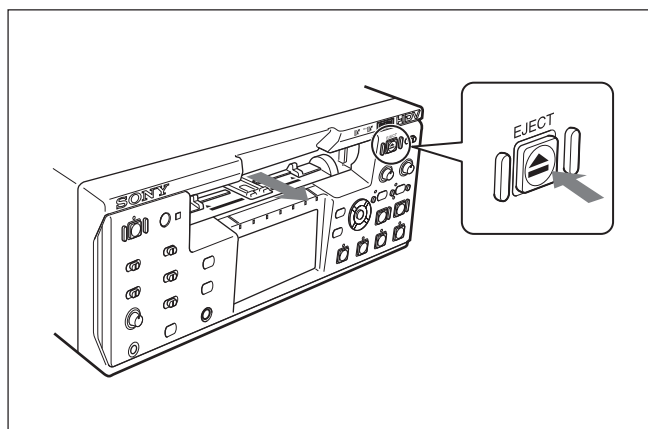

The cassette is unloaded and ejected.

Notes on Playback/Recording

No compensation for contents of the recording

Contents of the recording cannot be compensated for if recording or playback is not successful due to a malfunction of the unit, video tape, etc.

Copyright precautions

Television programs, films, video tapes, and other materials may be copyrighted. Unauthorized recording of such materials may be contrary to the copyright laws.

(Continued)

Notes on Power Supply and Video Cassettes

On recording

You cannot record or output EE signals and any software having copyright protection signals on the unit. If you start recording protected video and audio signals, a warning appears on the monitor screen and the unit stops recording.

During recording, do not change INPUT SELECT switch setting. If you do so, the unit may mistakenly recognize that copyright control signals has been input.

On playback

When you play back software having copyright protected signals on the unit, you may not record or output to other equipment.

Limitations caused by differences in format

The unit can record and play back tapes recorded in HDV (1080/60i, 1080/50i) or DVCAM format. It can also record and play back tapes recorded in DV format (SP mode).

However, due to differences in format, you may not play back or edit some tapes affected by recording conditions of the tape (i.e., a tape originally recorded in DV format is dubbed in DVCAM format).

The unit cannot input/output, record, or play back a tape other than 1080/60i or 1080/50i format such as 1080/30F, 1080/25F, 1080/24F, 720/25p, 720/24p format.

The unit cannot input/output, record, or play back a tape with 4-channel audio signals in HDV extended format.

You can play back HDV720/30p format, whereas you cannot output the video signals from **Ⓜ** HDV/DV jack. For details, see “Compatibility of HDV, DVCAM, and DV Formats” on page 93.

If a tape has both a portion recorded in HDV/DVCAM format and one recorded in DV format (SP mode), the following limitations are applied when you play back the tape with the unit:

- The image may be distorted and noise may occur at the point where the recording format changes on the tape.
- The tape transport control buttons may be disabled until the tape speed is stabilized.

Note on playback on other equipment

A tape recorded in HDV format with the unit cannot be played back with the devices not compatible with HDV1080i format. We recommend confirming the contents of the tape by playing back the tape with the unit before playing back it on another video equipment.

Playback

This section describes the connections and settings for the playback and functions such as playback at various speeds and searching for a specific scene on a recorded tape.

Connections for Playback

Connecting the unit to a monitor without an i.LINK jack

You can connect the unit to video monitor without an i.LINK jack. Use the unit as follows.

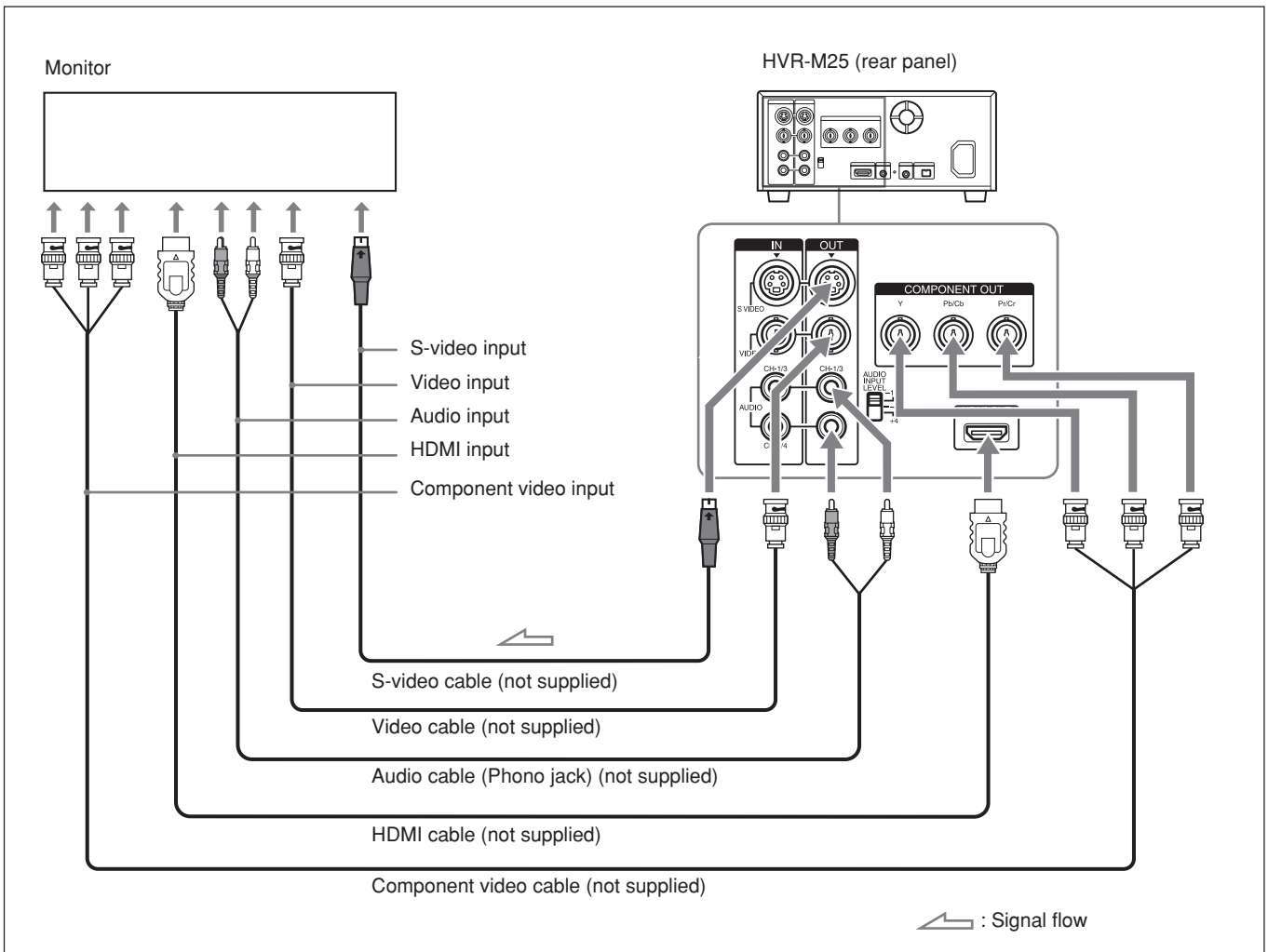

When an HDMI cable is used for connection, Audio cable connection is not necessary.

(Continued)

Notes

- To playback the picture recorded in HDV format when you connect the monitor using an HDMI cable or a component video cable, set [HDMI/CMPNT] of [VIDEO OUT] in [IN/OUT REC] menu according to your monitor (*page 68*). When the picture recorded in DVCAM/DV format is played back, only a picture with a quality equivalent with DVCAM/DV format of 480i (NTSC) or 576i (PAL) is output via COMPONENT OUT jacks regardless of [HDMI/CMPNT] setting.
- For details on output level from HDMI OUT jack and COMPONENT OUT jacks, see “Specifications” (*page 100*).
- To change the output level from COMPONENT OUT jacks, see [480i LEVEL] in [IN/OUT REC] menu (*page 71*).
- There are some restrictions on pictures output from HDMI OUT jack and COMPONENT OUT jacks of the unit.
Refer to HDMI OUT jack 6, COMPONENT OUT jacks 5 in “Rear Panel” of the “Location and Function of Parts” on page 19.
- If you connect the input connectors of the unit to the output connectors of a monitor, a humming noise may be generated or the image may be distorted. If these phenomena occur, use INPUT SELECT switch to select a signal that is not being input or disconnect the cables.
- When you play back a tape with copyright protected signals or input HDV signals with copyright protection to i HDV/DV jack, pictures and audio are not output via HDMI OUT jack.
- When you play back an HDV-formatted tape with copyright protected signals or input i.LINK signals with copyright protection to i HDV/DV jack, pictures may be output in either 480i (NTSC) or 576i (PAL) format regardless of the setting of [HDMI/CMPNT] of [VIDEO OUT] in [IN/OUT REC] menu.
- The unit cannot up convert DVCAM/DV recordings to HDV at output.

Connecting the unit to a monitor equipped with an i.LINK jack

The video and audio signals are sent with hardly any degradation, enabling high-quality playback to a monitor with an i.LINK connector which supports HDV, DVCAM, and DV format.

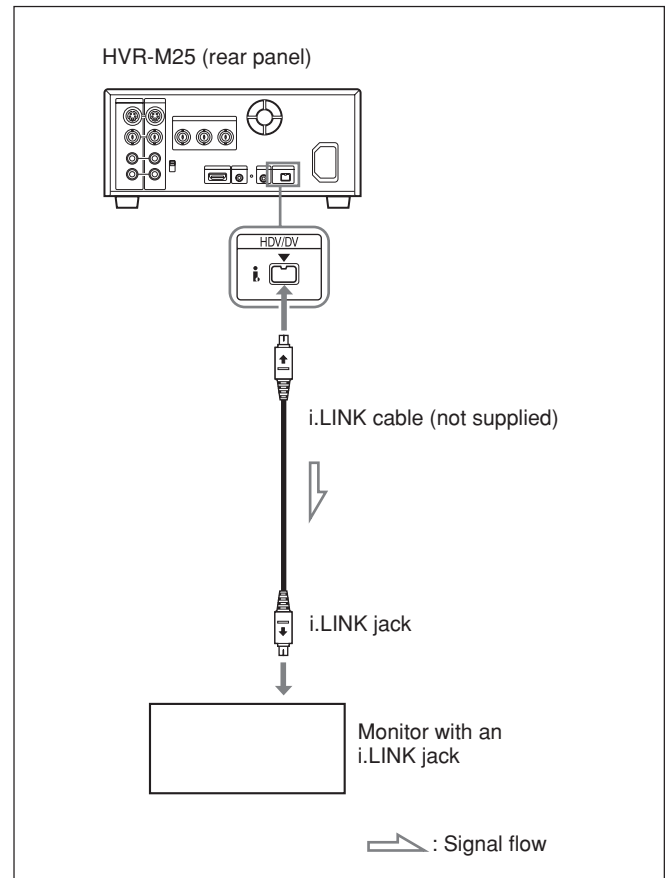

Notes

- Be sure that you set [HDV/DV SEL] in [IN/OUT REC] menu to [AUTO] (default setting) before connecting the monitor to the unit with the i.LINK cable. If you change the setting after connecting the i.LINK cable, the monitor may not recognize the video signals correctly (*page 67*).
- To connect the unit to a monitor equipped with an i.LINK jack, you may need to set the monitor so that it recognizes the unit.
For details, refer to your monitor's instruction manual.
- When i.LINK is connected, the unit cannot output video or audio only.

- If you connect the input connectors of the unit to the output connectors of a monitor, a humming noise may be generated or the image may be distorted. If these phenomena occur, use INPUT SELECT switch to select signals that is not being input or disconnect the cables.
- To connect the i.LINK cable between a monitor and the unit, use an HDV or DV-compatible monitor. To play back a tape recorded in the HDV mode on a DV-compatible monitor, set [HDV → DV CONV] of [i.LINK SET] in [IN/OUT REC] menu to [DVCAM] or [DV SP] before connecting the unit with the i.LINK cable.
For details, refer to your monitor's instruction manual.
- Some general consumer television sets are provided with a function to control equipment connected with the i.LINK cable. Such a function, however, may not work with the unit.

Settings for Playback

Preparation on the unit

Notes

- Text information is superimposed to VIDEO OUT jack, S VIDEO OUT jack, COMPONENT OUT jacks, and HDMI OUT jack. To output video signals without text data, set DISPLAY OUTPUT switch to OFF.

*For details on DISPLAY OUTPUT switch, see page 11.
For details on text data, see "Displaying Various Data" on page 25.*

- To view a tape recorded in HDV format by connecting the unit to a monitor set that has a 4:3 aspect ratio, set [DOWN CONVERT] of [VIDEO OUT] in [IN/OUT REC] menu to the desired mode (page 68).

- 1** Power on the monitor, then set the monitor's input switch according to the signals input.
- 2** Turn the unit on.

Playback Procedures

- 1** Insert a cassette and confirm that  (cassette) indicator lights.
- 2** Press PLAY button on the unit.

The unit starts playback.

To stop playback

Press STOP button on the unit.

To pause playback

Press PAUSE button on the unit.

Notes

- If the unit is playing a portion of a tape where the recording format changes between HDV, DVCAM, and DV, the picture and sound are distorted on such portions.
- You cannot play back an image recorded in DV (LP) mode on the unit.
- If the unit is playing a tape recorded with mixed video signals of the 60i system and 50i system, the picture and sound will be distorted on a portion of a tape where the recording system changes.
- During pause, the picture recorded on a tape in HDV format cannot be output from  HDMI/DV jack.

Playback Functions

This section describes useful functions during playback.

Displaying information (data codes) recorded on a tape

If you record on a tape using a Sony digital HD video camera recorder or digital camcorder, the recording information (data codes) is recorded on the tape. The data codes consist of recording date/time and camera data (the shutter speed, SteadyShot, iris, white balance, program AE mode, gain, date and time). You can check these data items during playback on the unit.

Each time you press DATA CODE button on Remote Commander, the display changes in sequence as follows:

no data code → recording date/time → camera data → no data code Also, you can change the display by setting [DATE] or [CAMERA DATA] of [DATA CODE] in [DISPLAY SET] menu.

For details, see "DATA CODE" on page 72.

Notes

- If data codes were not recorded, "--" appears instead.
- The unit cannot record camera data.
- Some of the camera data items displayed by the unit are different from those shown on the digital camcorder and digital HD video camera recorder.

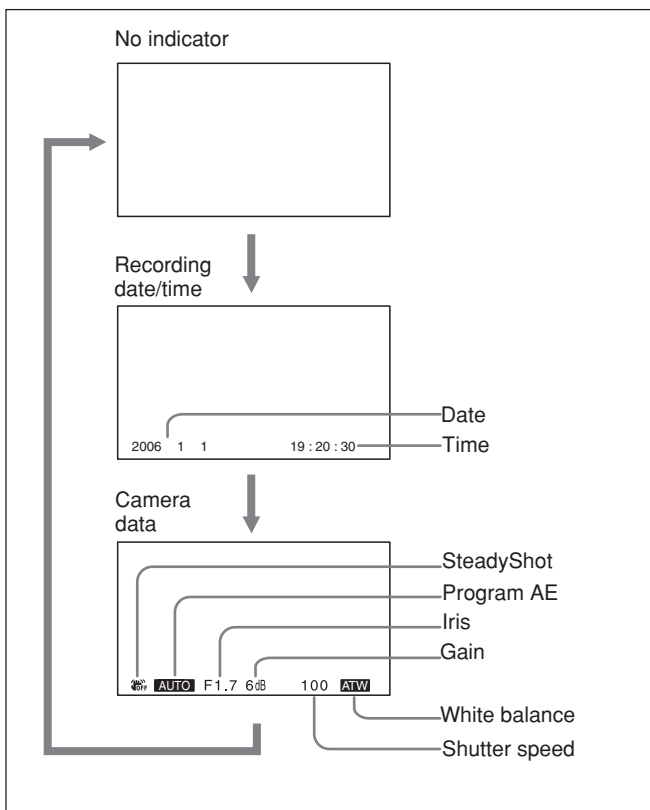

Playing at various speeds

You can playback a tape at various speeds using Remote Commander.

HDV-formatted tape

Button	Operation speed	Panel/analog output		i.LINK output	
		Forward direction	Reverse direction	Forward direction	Reverse direction
× 1/10	One-tenth of normal speed	⊙	—*	—	—*
× 1/3	One-fifth of normal speed	⊙	—*	—	—*
× 1	Playback at normal speed	⊙	○	⊙	○
× 2	Playback at normal speed	—*	—*	—*	—*
FRAME ◀ ▶	Frame-by-frame forward scanning	⊙	—*	—	—*
⏮/⏭	8× speed	○	○	○	○

* The output will be the same as that of ×1.

⊙ : Play at normal speed.

○ : A search simple image is output. (Rough image)

— : No playback takes place.

DVCAM/DV-formatted tape

Playback options	Operation
Play at 1/10 of normal speed	Press × 1/10 button during playback.
Play at 1/3 of normal speed	Press × 1/3 button during playback.
Play at normal speed	Press × 1 button during playback.
Play at twice the normal speed	Press × 2 button during playback.
Play frame by frame	Press FRAME ◀ ▶ buttons during pause. If you keep pressing one of these buttons, playback continues, frame by frame.
Fast forward the tape while monitoring pictures	Press ⏭ button during normal playback or when playing at various speeds.
Rewind the tape while monitoring pictures	Press ⏮ button during normal playback or when playing at various speeds.

To change playback direction

Press FRAME ◀|||▶ buttons during normal playback or when playing at various speeds. To play back in the forward direction, press |||▶ button; in the backward direction, press ◀||| button.

Notes

- When the command mode of a Sony device/remote commander is set to VTR4:
 - if you press ×1/3 button on the supplied Remote Commander while pointing it toward a Sony device other than the unit, the playback speed may turn to 1/5 of normal speed.

- when you playback a tape in DVCAM/DV format and press ×1/5 button on Remote Commander while pointing it toward the unit, the playback speed turns to 1/3 of normal speed.
- If the unit keeps playing at 1/10 of normal speed in forward or reverse for more than 1 minute, the unit begins to play back at normal speed.

Playback

To hear the sound while playing at various speeds

To hear the sound when playing at various speeds, set [JOG AUDIO] in [AUDIO SET] menu to [ON].

For details on [AUDIO SET] menu, see "AUDIO SET" menu on page 73.

Note

You cannot hear the sound while playing back a tape recorded in HDV format at various speeds.

Searching using the search function

The unit can immediately access the following signals recorded on a tape.

- Searching for the beginnings of the recordings: Index search
- Searching for a point on the tape where the recorded date changes: Date search

To search for scenes, use the supplied Remote Commander. Also, you can assign the same search function to ASSIGN buttons.

For details on ASSIGN buttons, see "ASSIGN BTN" in "OTHERS" menu on page 77.

- 1 Press SEARCH SELECT button on Remote Commander to select the search type.

The search type changes in the order of Index search → Date search → (No indication).

When selecting INDEX SEARCH



(The search screens are displayed only on Data display screen.)

- 2 Press ◀◀ / ▶▶ button repeatedly to locate the scene you want.

Each time you press ◀◀ / ▶▶ button, the unit searches for the previous or next search point.

When a search point is located, its number is indicated on the monitor screen.

The unit starts searching backwards or forwards until the number comes to zero, then plays back the scene.

How signals are recorded

There are four different signal types, one for each search method; index, title, date and photo signals. The unit can record either index signals or date signals only on a tape.

Notes

- If you record another program over the beginning of the search signals, you cannot locate the original program.

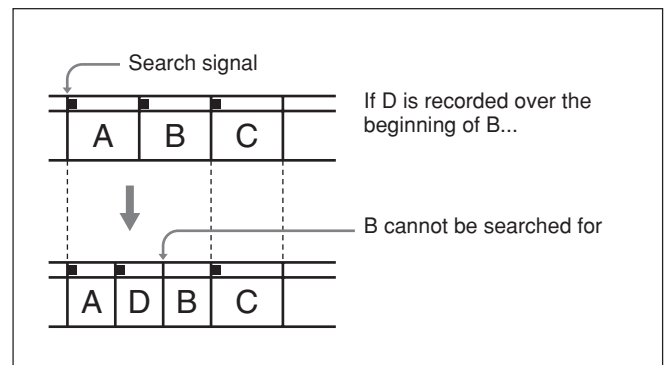

- The interval of a date or index must be 2 minutes or more. If the interval is short, the search signals may not be detected correctly.
- If non-recorded portions are included in the middle of a tape, signal search may not be performed correctly.
- You cannot add search signals after recording.
- The unit does not support searching, reading or writing of data on cassette memory. For duplicating with the DSR-25/45/50, see page 30.
- Searching may not be done correctly if the tapes were not recorded on Sony-brand digital video equipment.

AUTO REPEAT (CUSTOM REPEAT)

The unit can repeat playback of all or a part of a tape. When the following items on the tape are searched, AUTO REPEAT playback starts automatically.

- Index signals
- A portion unrecorded
- A portion recorded in the format set by other than [AUTO] in [HDV/DV SEL] in [IN/OUT REC] menu
- Tape end

By setting up [CUSTOM REPEAT] in [VTR SET] menu, you can customize the repeat times, the repeat cycle, and the start time of repeat playbacks.

To set the CUSTOM REPEAT

Set the following sub menus of [CUSTOM REPEAT] in [VTR SET] menu.

REPEAT TIMES

ON/OFF : Selects either to enable or to disable REPEAT TIMES setting.

TIMES : Sets the number of times to repeat playback.

Repeat times can be set from 1 to 99 times. Set the number of repeat times by pressing \uparrow/\downarrow buttons on the unit.

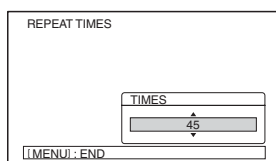

Press EXEC button to complete.

REPEAT CYCLE

ON/OFF : Selects either enable or disable the REPEAT CYCLE setting.

CYCLE: Sets the time of intervals for playback.

Time of repeat interval is equal with the total time of tape in playback, rewind, and stop.

Repeat intervals can be selected from 15 minutes to 300 minutes with 5 minutes increment.

Set the desired number by pressing \uparrow/\downarrow button on the unit.

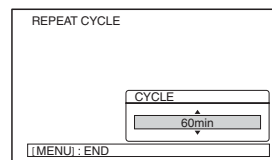

Press EXEC button to complete.

To play back at START TIME, rewind a tape beforehand. If the tape is not rewound, the unit rewinds the tape to its beginning at selected START TIME, then start playback.

START TIME

ON/OFF : Selects either enable or disable [START TIME].

TIME : Sets the start time of [CUSTOM REPEAT].

You can adjust the start time of [CUSTOM REPEAT]. Set the number of each hour and minute by pressing \uparrow/\downarrow button on the unit.

Press EXEC button after the hour is set, then adjust the minute.

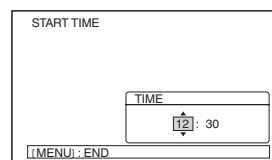

Press EXEC button to complete.

Note

While the unit is in STANDBY mode, even when START TIME setting is applied and the start time comes, the unit will not power on automatically. For details on "CUSTOM REPEAT", see page 74. Also, refer to "TIMER switch" (page 10), "STATUS CHECK screen" (page 27), and "CUSTOM REPEAT screen" (page 28).

Setting the AUTO REPEAT

If [START TIME] is set to [OFF]

- 1 Set TIMER switch to REPEAT.

↻ is displayed on Data display screen (page 25).

- 2 Press REW button. (If the tape is already rewound, press PLAY button.)

The unit rewinds the tape to its beginning and starts playback automatically. When the following items on the tape are searched, AUTO REPEAT playback starts automatically.

- Index signals
- A portion unrecorded
- A portion recorded in the format set by other than [AUTO] in [HDV/DV SEL] in [IN/OUT REC] menu
- Tape end

When [REPEAT CYCLE] is set, the unit continues playback until a few minutes before the time reaches at the actual selected time, or the items listed above is detected on a tape. The tape is rewound to the beginning and restarts playback when the selected CYCLE time comes.

If you set [REPEAT TIMES], the unit repeats playback according to the times you have selected.

Auto Repeat using an external AC timer

- 1 Connect the unit to an external AC timer (not supplied).

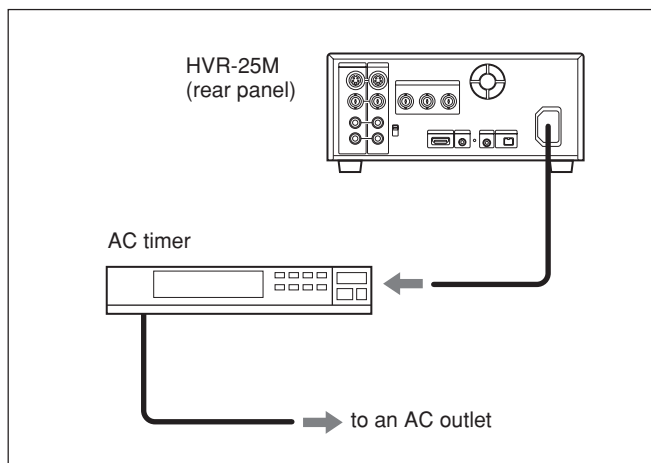

- 2 Set the TIMER switch on the front panel of the unit to REPEAT.

- 3 Set the start time on the external AC timer.

At the preset time, the power of the unit turns on, and after a few to several ten seconds, AUTO REPEAT playback starts automatically. When the following items on the tape are searched, AUTO REPEAT playback starts automatically.

- Index signals
- A portion unrecorded
- A portion recorded in the format set by other than [AUTO] in [HDV/DV SEL] in [IN/OUT REC] menu
- Tape end

If [START TIME] is set to [ON]

Set TIMER switch to [REPEAT].

When the unit is powered on, the unit waits the repeat playback until the time you have set in [START TIME]. Also, when TIMER switch is set to REPEAT and the unit is powered on, auto playback is set to standby until the start time begins.

Notes

- ↻⏪⏩ is displayed on Data display screen. When the tape on the unit is not in the playback mode, such as during recording or when no tape is inserted, ↻⏪⏩ is displayed. When the start time reaches the selected time during this time, auto playback is not operated until the next starts time begins.
- To operate AUTO REPEAT automatically, the tape should be stopped before the start time begins.
- When [START TIME] for [CUSTOM REPEAT] is set, turn the unit on before the actual start time begins.

To stop the AUTO REPEAT while the unit is in progress

Press STOP button on the front panel.

When both [REPEAT TIMES] and [START TIME] are set, if you stop AUTO REPEAT, the unit waits for the START TIME to come, regardless of the REPEAT TIMES setting. When the start time comes, the value of REPEAT TIMES is initialized to zero, and repeat playback starts.

To cancel the AUTO REPEAT

Set TIMER switch to OFF.

By using AUTO REPEAT, you can do the following as examples

Repeat playbacks with 30 minutes interval :

- 1 Set [ON/OFF] of [REPEAT CYCLE] to [ON].
- 2 Set [CYCLE] of [REPEAT CYCLE] to [30 min].
- 3 Press REW or PLAY button.

Repeat playbacks 5 times for 2 hours per day at 9 a.m. :

- 1 Set [ON/OFF] of [REPEAT CYCLE] to [ON].
- 2 Set [CYCLE] of [REPEAT CYCLE] to [120 min].
- 3 Set [ON/OFF] of [REPEAT TIMES] to [ON].
- 4 Set [TIMES] of [REPEAT TIMES] to [5].
- 5 Set [ON/OFF] of [START TIME] to [ON].
- 6 Set [TIME] of [START TIME] at [9:00].
- 7 Turn the unit on before 9 a.m.

Notes

- The unit cannot detect signals for Index signal, a signal other than the one set by [AUTO] in [HDV/DV SEL], or an unrecorded portion within 20 seconds of the beginning of the playback.
- When you intend to turn the unit off, press STOP button on the unit to stop the tape transport operation beforehand. If you turn the unit off while a tape is running, for example, by using an AC timer, the unit or the tape may be damaged.
- The editing software used on the digital non-linear editing system may mark index signals on a tape itself. Therefore, if you use a tape on which signals transmitted from a digital non-linear editing controller are recorded or a copy tape made from one, using digital dubbing, Auto Repeat may not be performed correctly.

EDGE CROP MARKER

The unit allows you to adjust the edge crop position when you output the down converted HDV 16:9 wide screen pictures to 4:3 standard TV mode pictures. By displaying the edge crop marker on the monitor, you can check the crop position on LCD monitor beforehand.

To set EDGE CROP MARKER

Either set [CROP MARKER] in [IN/OUT REC] menu to [ON] after setting [DOWN CONVERT] of [VIDEO OUT] in [IN/OUT REC] menu to [EDGE CROP] or [DOWN CONVERT] of [i.LINK SET] in [IN/OUT REC] to [EDGE CROP].

EDGE CROP MARKER screen displays;

- Crop position of 4:3 aspect screen
- Center marker
- 80% safety zone

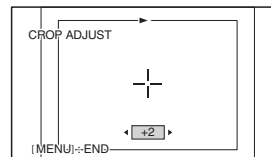

Select [CROP ADJUST] in [IN/OUT REC] menu and press EXEC button again after the confirmation display appears. Then, EDGE CROP MARKER will appear on the monitor. Press \leftarrow/\rightarrow buttons to move the marker to the left and right and adjust the position to crop. Press EXEC button to execute.

Notes

- When CROP MARKER is displayed on LCD monitor, the text data and crop marker displayed on LCD monitor are not output from jacks on the rear panel of the unit. To output 4:3 screen marker, see [MARKER BURN].
- To output an edge cropped picture by down converting the HDV-formatted picture to 4:3, see "VIDEO OUT" (page 68) and "i.LINK SET" (page 69) in "IN/OUT REC" menu.

MARKER BURN

The unit can output to each video jacks and display 4:3 screen marker on the 16:9 screen images. In case of making an editing tape from the original tape, [MARKER BURN] can be used.

To set up MARKER BURN

Set [MARKER BURN] in [DISPLAY SET] menu to [ON].

Notes

- MARKER BURN is effective under the following conditions.
 - While playing back a tape in HDV or an HDV signal is input via  HDV/DV jack, and [DOWN CONVERT] of [VIDEO OUT] in [IN/OUT REC] menu is set to [SQUEEZE] or [LETTER BOX].
 - When wide signals recorded in DVCAM or DV format are played back, or wide screen HDV/DVCAM/DV signals are input to each VIDEO jacks.
- When [DOWN CONVERT] of [VIDEO OUT] in [IN/OUT REC] is set to [EDGE CROP], the marker can not be displayed.
- The markers displayed with EDGE CROP and MARKER BURN show the available horizontal ratio range of the 4:3 screen to be cropped. The displayable image size of the standard 4:3 TV monitor may appear smaller than the size marked on the monitor of the unit.
- When the EDGE CROP MARKER and MARKER BURN are enabled at the same time, the EDGE CROP MARKER is displayed as priority.
- When you set [MARKER BURN] and [ALLSCAN MODE] in [DISPLAY SET] menu to [ON] at the same time, the marker will not appear in the correct position on LCD monitor. This is not a malfunction. The marker will be output correctly via each video jack.

Using the Unit as a Videocassette Recorder

This section describes the connections, settings and operations necessary to perform recording on the unit. The same settings and operations apply whether you are using the unit for dubbing.

Notes

- For connection of the editing devices, refer to the instruction manual of the editing controller and that of the editing software you use.
- Edit functions are specified by the editing software. For details on the editing methods, refer to the instruction manual of the editing software.
For details, see also page 62 and 63.

Connections for Recording

To video equipment without an i.LINK jack

You can connect the unit to video equipment without an i.LINK jack. Use the unit as a recorder as follows.

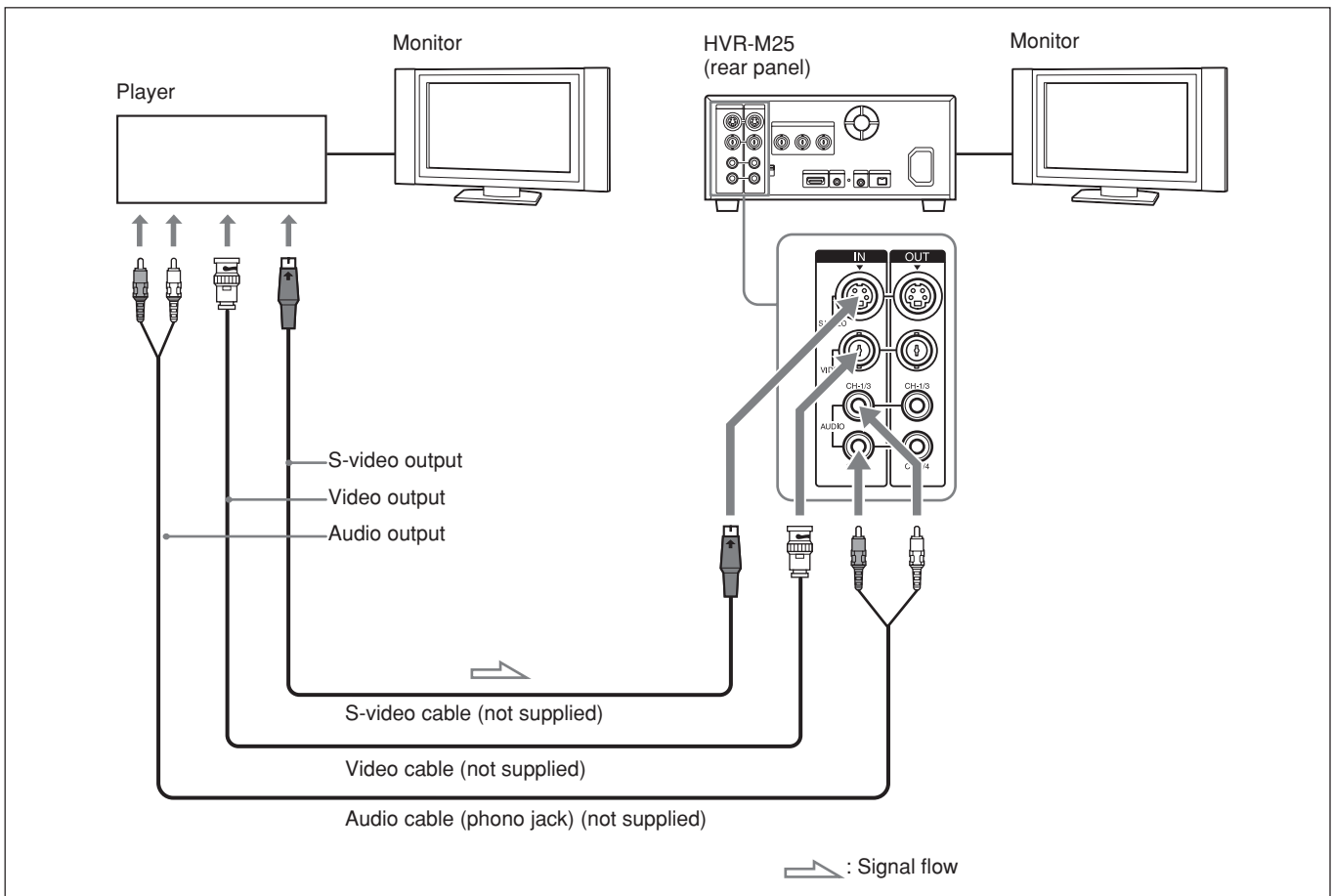

Connect either an S-video cable or a video cable.

(Continued)

Using the Unit as a Videocassette Recorder

Notes

- If you connect the output connectors of the unit to the input connectors of the player, a humming noise may be generated or the image may be distorted. If these phenomena occur, set INPUT SELECT switch to a position where a signal is not currently being input, or disconnect the cables.
- Distorted signals (i.e., when played back at a speed other than normal) may not be recorded or may be distorted.
- When you connect only AUDIO IN jacks when HDV indicator is lit, no audio is input. You must connect VIDEO IN jack at the same time or set [HDV/DV SEL] in [IN/OUT REC] menu to [DV].

To digital video equipment with an i.LINK jack

When you record i.LINK signal of HDV (1080/60i, 1080/50i), DVCAM, or DV format, the video and audio signals are sent without any degradation in quality, enabling high-quality recording. The signal flow is automatically detected so you do not need to make separate connections for input and output.

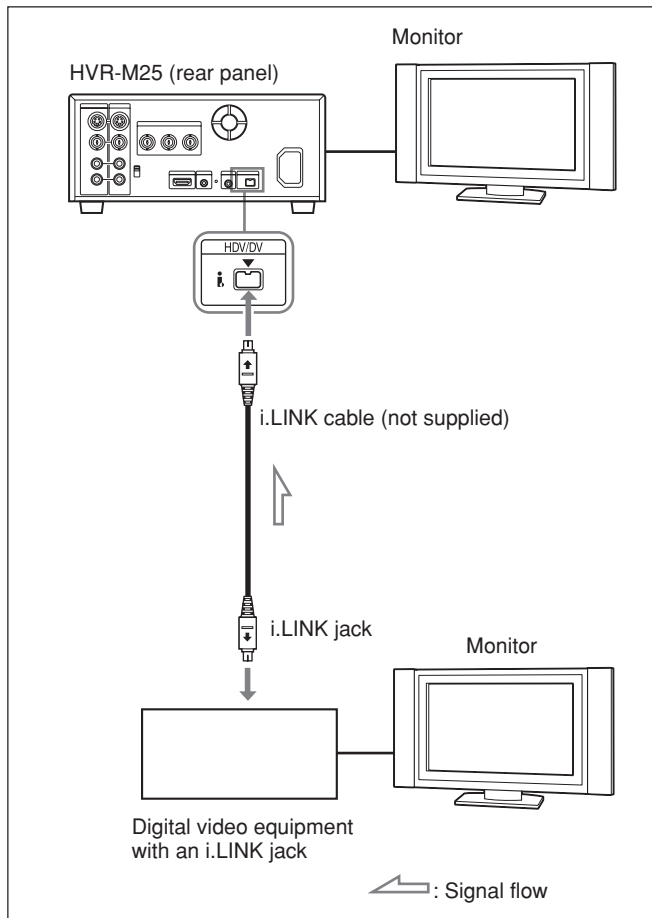

Notes

- When you record video from HDV-compatible equipment, set [HDV/DV SEL] in [IN/OUT REC] menu to [AUTO]. To record video from a DVCAM/DV equipment, set [HDV/DV SEL] in [IN/OUT REC] menu to [AUTO] or [DV] before connecting the i.LINK cable (page 67). If you change the setting after connecting i.LINK cable, the video equipment may not recognize the video signals correctly.
- Copy-protected program such as digital broadcast can not be input via **i**, HDV/DV jack.
- With HDV/DV connection, the sound is recorded in the same audio recording mode as that of the source tape. To record in a different audio recording mode from the source tape, connect as shown in “To video equipment without an i.LINK jack” on page 43.
- With HDV/DV connection, data codes (recording date/time, camera data) recorded on the source tape are transmitted to the recorder (the unit). As a result, when you play back a recorded tape on the unit and press DATA CODE button on the Remote Commander, the same data codes as those recorded on the source tape are displayed on the monitor screen.
- If no picture appears via **i**, HDV/DV jack, disconnect the i.LINK cable, then reconnect it.
- The unit cannot record video or audio separately.
- If you record a picture in DVCAM/DV in the playback pause mode, the picture may be rough. When set to HDV, the picture is not recorded.
- When connecting a device that has a 6-pin i.LINK jack to the unit, first, connect the plug of the cable to the 6-pin i.LINK jack.
- If the unit is connected to a device equipped with an i.LINK jack, when you intend to disconnect or reconnect the i.LINK cable, turn off the device and pull out the plug of its power cord from the AC outlet beforehand. If you connect or disconnect the i.LINK cable while the device is connected to the AC outlet, high-voltage current (8 to 40 V) is output from the i.LINK jack of the device to the unit, which may cause a malfunction.
- If you restart recording after a pause or stop, the images recorded before and after restarting operation will not be continuous.
- If you connect the output connectors of the unit to the input connectors of a player or that of a monitor, a humming noise may be generated or the image may be distorted. If these phenomena occur, use INPUT SELECT switch to select a signal that is not being input or disconnect the cables.

- The unit cannot record MPEG2 signals except HDV1080i signals.
- When you record HDV signals input from **i** HDV/DV jack, the connection between the recorded signals pause for a second.

Settings for Recording

Preparation on the recorder (the unit)

Notes

- Before recording, set the date and time on the unit so that the recording time can be written into the search signal. You can set the date and time by setting [CLOCK SET] in [OTHERS] menu. (*page 78*)
- Editing may not be possible with a signal that is copyright protected.
- During recording, the tape transport control buttons (except STOP and PAUSE) are disabled to prevent the tape running mode from being changed by an incorrect operation. To disable STOP and PAUSE buttons, set KEY INH switch to ON after the unit starts recording. In this case, set KEY INH switch to OFF first, then stop or pause the recording.

- 1** Turn the power on the monitor, then set the monitor's input according to the input signals.
- 2** Set up the player to play back a tape.
For details, refer to the instruction manual of the player.
- 3** Turn the unit on.
- 4** When the player is connected to IN jacks on the unit, set [60i/50i SEL] in [OTHERS] menu according to the input signals.

When you input 60i system signals, set [60i/50i SEL] to [60i]. When you input 50i system signals, set [60i/50i SEL] to [50i]. (*page 79*)

Notes

- Do not change [60i/50i SEL] setting during recording.
- When you select S VIDEO or VIDEO with INPUT SELECT switch, if the field frequency of the input signals is different from that of [60i/50i SEL] setting, the picture mutes.

(Continued)

Using the Unit as a Videocassette Recorder

- When the signals are input through the i.LINK interface, the unit detects the field frequency of the input signal automatically. You do not need to change [60i/50i SEL] setting. When [60i/50i SEL] is set to [50i], however, the time code generated by the unit is fixed to the non-drop frame mode. Even when 60i system signals are input to the i.LINK jack, the time code generated by the unit is the non-drop frame mode, regardless of [TC FORMAT] setting in [TC/UB SET] menu. To record in the drop frame mode, set [60i/50i SEL] to [60i].

5 Select input signals by switching INPUT SELECT switch on the unit.

HDV/DV: to record input signals from **i** HDV/DV jack

S VIDEO: to record input signals from S VIDEO IN jack

VIDEO: to record input signals from VIDEO IN jack

You need to adjust [HDV/DV SEL] (page 67) and [REC MODE] (page 67) in [IN/OUT REC] menu to your desirable recording format.

For details on recording tape format, see page 97.

Note

Do not change INPUT SELECT switch setting during recording. If you change the setting of this switch during the recording, the recording will stop for several seconds. Recording will restart after the internal circuits are switched. During this time, no image is recorded.

6 Select the audio mode. (With an **i** HDV/DV connection, skip this step.)

When you select S VIDEO or VIDEO with INPUT SELECT switch, set the audio mode by setting [AUDIO MODE] in [AUDIO SET] menu (page 73).

FS32K: Switches the audio mode to 4-channel mode

FS48K: Switches the audio mode to 2-channel mode

When recording a tape in DV (SP), you can set [AUDIO LOCK] in [AUDIO SET] menu (page 73).

Note

When signals are input from **i** HDV/DV jack, the audio mode is the same as the one to input signals from the player.

To dub audio after recording, see page 60.

7 Set AUDIO INPUT LEVEL switch on the rear panel properly according to the audio level of the player.

8 Select the recording level adjustment mode using AUDIO INPUT switch.

Note

You cannot adjust the recording level if you record signals input via **i** HDV/DV jack.

9 If necessary, adjust the audio recording level by turning AUDIO REC LEVEL control knobs.

You can adjust the recording level with AUDIO REC LEVEL control knobs if you have selected MANU in step 8. While looking at STATUS CHECK screen, turn AUDIO REC LEVEL control knobs to adjust the recording level. Adjust the audio recording level so that it does not exceed 0 dB when the audio signals are at its maximum. If the recording level exceeds 0 dB, the recorded sound will be distorted.

(When the audio mode is set to FS32K (4-channel mode), sound will be recorded on channel 1 and 2. To listen the audio during recording, set AUDIO OUTPUT SELECT switch to CH-1/2.)

Notes

- When the unit records in DVCAM (DV) format, it supports two audio modes, with either 2-channels at FS48K or 4-channels at FS32K. It is not possible to select other modes (for example with 2-channels at FS32K).
- During recording, you cannot change the audio mode.
- To dub audio after recording using the unit, set [AUDIO MODE] in [AUDIO SET] menu to [FS32K] (4-channel mode) before recording. *For details on [AUDIO SET] menu, see "AUDIO SET" menu on page 73.*
- The unit is able to dub audio on a tape recorded in DVCAM format with 4-channel (FS32k).

Recording Procedures

This section describes the procedures used to record signals sent from another VCR to the unit.

For details on the operation when the unit is connected to a computer via  HDV/DV jack, refer to “Editing (Connecting with a Computer)” (page 62).

- 1** Insert a cassette and confirm that  (cassette) indicator lights up.
- 2** Press the playback button on the player.

The player starts playback.
- 3** On the unit, press PLAY button while holding REC button down.

Note

When the unit records HDV format images, it takes a while until recording starts. This delay, however, is not an error. ([STANDBY] on screen and REC indicator blinks until recording starts.)

To stop recording

Press STOP button on the unit.

To pause recording

Press PAUSE button on the unit.

Note

You cannot up convert NTSC or PAL signals in HDV format for recording.

Recording Functions

Marking an index

By pressing INDEX button on the unit or INDEX WRITE button on Remote Commander during recording, you can mark an index signal at any place on the tape. If you mark an index at the scene you want to search for, you can easily find the scene later. When [AUTO INDEX] in [VTR SET] menu is set to [ON], if you start recording while the tape in stop, the unit automatically marks an index. While the index is being marked,  indicator appears for about seven seconds on Data display screen (page 25).

Notes

- You cannot mark a new index while  indicator is being displayed.
- If you record on a portion of the tape where an index has been marked, the index will be erased. You cannot delete just an index while keeping the image or sound.
- You cannot mark an index during playback or audio dubbing operations. INDEX button and INDEX WRITE button are disabled in these operations.

To use an index during playback

See “Searching using the search function” on page 38.

Using the Unit as a Videocassette Recorder

AC timer recording

By connecting the unit to an external AC timer (not supplied), you can start recording at a preset time.

- 1 Connect the unit to an external AC timer (not supplied).

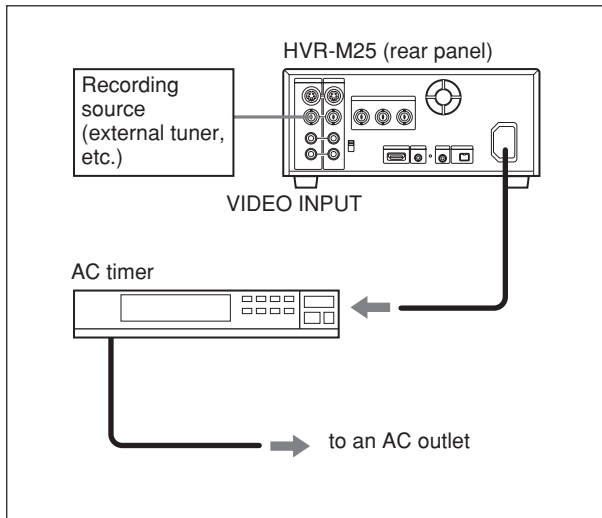

- 2 Insert a tape for recording.
- 3 Set INPUT SELECT switch of the unit to select the input signals.
- 4 Set TIMER switch on the front panel of the unit to REC.
- 5 Set the timer-on time on the connected AC timer.

At the preset time, the power of the unit turns on automatically and recording starts after a few to several ten seconds. Set the timer allowing a margin for the recording to start. You do not need to press REC button.

Note

To turn the unit off, press STOP button on the unit to stop the tape transport operation beforehand. If you turn the unit off while a tape is running, for example, by using an AC timer, the unit or the tape may be damaged.

If the tape ends before the recording source stops operation

The tape stops.

To stop recording during timer recording

Press STOP button on the unit.

To release the AC timer recording mode

Set TIMER switch on the front panel of the unit to OFF.

Setting the Time Code

Setting the Time Code and User Bits

The unit can set, display, record and play back the time code and user bits.

Notes

- When HDV signals are recorded from **i** HDV/DV jack on the unit, user bits are copied automatically. However, these bits cannot be preset. The time code is set in accordance with [TC MAKE] setting. To copy the time code of a source tape, set [HDV/DV IN TC] in [TC/UB SET] menu to [EXTERNAL] (page 76).
- When images recorded in DVCAM/DV format are input via **i** HDV/DV jack, you can preset a user bit time code on the unit. To copy the user bit and time code of a source tape, use [DUPLICATE PLUS] (page 74).
- For a tape recorded both in HDV and DVCAM/DV formats, the time code may become garbled at a connecting portion between scenes on the tape.
- If you play back an HDV tape without signals recorded, the time cord may become disordered.
- The time code and user bits cannot be reset on the unit from with Remote Commander equipped with a counter reset function.

Using the Internal Time Code Generator

You can set the initial time code value generated by the internal time code generator. In addition, you can set the user bits to record data such as the date, time, scene number, reel number, or other useful information. The time data settings are set by using the menu.

For details on the menu, see “Chapter 5 Adjusting and Setting Through Menus” on page 65.

To set the initial time code value

This section describes how to set the time code’s initial value.

Note

To set the initial time code value, you need to set [TC MAKE] in [TC/UB SET] menu to [PRESET] beforehand.

For details on [TC MAKE], see “TC/UB SET” menu on page 76.

- 1 Press MENU button to display the menu.

For details on the menu, see “Operating the Menus” on page 65.

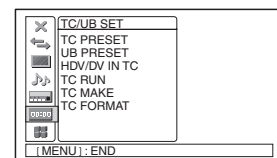

(You can set [TC FORMAT] only when [60i/50i SEL] in [OTHERS] menu is set to [60i].)

(Continued)

Setting the Time Code and User Bits

- 2** Press \uparrow/\downarrow buttons to select [TC/UB SET], then press EXEC button.

The following menus are displayed.

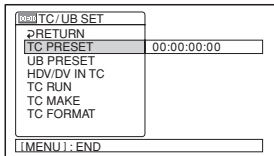

- 3** Press \uparrow/\downarrow buttons to select [TC PRESET], then press EXEC button.

The following menus are displayed.

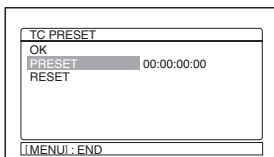

- 4** Press \uparrow/\downarrow buttons to select [PRESET], then press EXEC button.

The following menus are displayed.

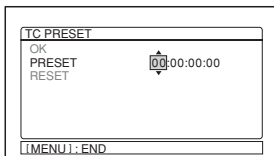

- 5** Set the first two digits. Press \uparrow/\downarrow buttons to select the number, then press EXEC button.

- 6** Repeat step 5 to set the other eight digits.

- 7** Press \uparrow/\downarrow buttons to select [OK], then press EXEC button.

The time code value is set. The menu display returns to that of step 2.

- 8** Press \uparrow/\downarrow buttons to select [OK], then press EXEC button.

The menu display returns to that of step 1.

To cancel the time code setting

Select [CANCEL] in step 7, then press EXEC button.

To reset the time code

Select [RESET] in step 4, then press EXEC button.

To set the value of the user bits

You can set the user bits as eight-digit hexadecimal values (base 16) to have the date, time, scene number, and other information inserted into the time code track.

Note

When HDV signals are input from \mathbf{i} HDV/DV jack, the user bits of HDV signals are applied.

In the event of this, you do not have to follow the procedures below.

When recording the internal color bars in HDV format, user bits can still be set.

- 1** Press MENU button to display the menu.

For details on the menu, see "Operating the Menus" on page 65.

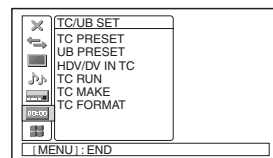

- 2** Press \uparrow/\downarrow buttons to select [TC/UB SET], then press EXEC button.

The following menus are displayed.

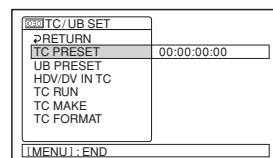

- 3** Press \uparrow/\downarrow buttons to select [UB PRESET], then press EXEC button.

The following menus are displayed.

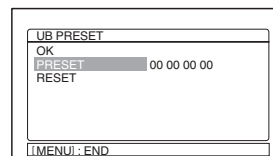

- 4** Press \uparrow/\downarrow buttons to select [PRESET], then press EXEC button.

The following menus are displayed.

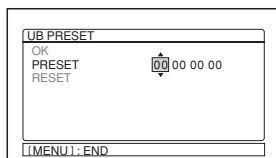

- 5** Set the first two digits. Press \uparrow/\downarrow buttons to select the number, then press EXEC button.
- 6** Repeat step **5** to set the rest of the digits.
- 7** Press \uparrow/\downarrow buttons to select [OK], then press EXEC button.

The user bit value is set. The menu display returns to that of step **2**.

- 8** Press \uparrow/\downarrow buttons to select [OK], then press EXEC button.

The menu display returns to that of step **1**.

To cancel the user bits setting

Select [CANCEL] in step **7**, then press EXEC button.

To reset the user bits

Select [RESET] in step **4**, then press EXEC button.

Note

The user bit is recorded at three-frame intervals for a tape recorded in HDV1080i format.

To select the time code when you record a signal input to \mathbf{i} HDV/DV format

Set [HDV/DV IN TC] in [TC/UB SET] menu to select whether to record the internal time code or an external one.

INTERNAL: Records the time code internally generated.

EXTERNAL: Records the time code with video and audio signals input via \mathbf{i} HDV/DV jack.

Notes

- When this item is set to [EXTERNAL], the time code input via \mathbf{i} HDV/DV jack and the user bits set in [UB PRESET] are recorded.

- When HDV signals are input from \mathbf{i} HDV/DV jack the user bit value is also recorded, regardless of [HDV/DV IN TC] setting.
- When this item is set to [EXTERNAL], INPUT SELECT switch on the front panel is set to HDV/DV, and no signal is input via \mathbf{i} HDV/DV jack, or the software of the editing controller does not output a time code. If you start recording, bars (---:---:---) are recorded as the time code. When time code signals are input, the bars disappear to record the time code signals.
- When this item is set to [EXTERNAL], if you input time code to \mathbf{i} HDV/DV jack that is not continuous or does not advance correctly, the value of the recorded or displayed time code may not be equal to the actual value of the input one. If you use a tape with this problem, you may not perform search or edit, depending on the devices you use.

To set the time code when the recording starts

Set [TC MAKE] in [TC/UB SET] menu to select the time code to be recorded when recording starts.

REGENERATE: The time code value is set to continue the time code from the time code already recorded on the tape. If you start recording from a blank portion of the tape, the time code starts from "00:00:00:00".

PRESET: The time code starts from the value set in [TC PRESET] in [TC/UB SET] menu.

To set the advancement mode

Set [TC RUN] in [TC/UB SET] menu to switch the advancement mode (counting up).

REC RUN: Time code advances only while recording.

FREE RUN: Time code advances even when the unit is not recording and the time indicator is paused. Use this setting to adjust the default time code to the current time and so on.

(Continued)

Setting the Time Code and User Bits

Notes

- If you set the advancement mode to [FREE RUN], the time code will be updated by the internal clock while the unit's power is off. The time code may have been delayed or advanced when if you turn on the unit power again, play back a tape, or set INPUT SELECT switch to HDV/DV.
- If the internal backup battery charge is exhausted, the time code of FREE RUN setting will be initialized. The internal backup battery is fully charged if you connect the power to the unit for about 24 hours. A fully charged internal battery can run for about 3 months.

To set the frame mode (For 60i only)

Set [TC FORMAT] in [TC/UB SET] menu to switch the frame mode.

AUTO: Automatically sets the mode in accordance with the loaded tape.

If nothing is recorded on the tape, the mode is set to the non-drop frame mode. If the unit cannot read the frame mode correctly from the tape, the unit will use the mode that was set in the last position it was able to read correctly on the tape. If you remove the cassette, the mode of the last position it was able to read correctly is cleared and the mode is set to the non-drop frame mode. If [TC MAKE] is set to [PRESET], the mode is also set to the non-drop frame mode.

DF: Selects the drop frame mode.





NDF: Selects the non-drop frame mode.

Note

When you set [60i/50i SEL] in [OTHERS] menu to [50i], the unit applies the 50i system specification. Therefore, the time code generated by the unit during recording is that of the non-drop frame mode. Even if 60i system signals is input to  HDV/DV jack, when [60i/50i SEL] in [OTHERS] menu is set to [50i], the time code generated by the unit is the non-drop frame mode regardless of [TC FORMAT] setting. To set the unit to generate the time code in the drop frame mode, set [60i/50i SEL] to [60i].

HVR-M25U/M25N/M25E/M25P time codes

The unit has a  HDV/DV jack. The time code displayed and recorded on the tape differs as shown below when INPUT SELECT switch is set to HDV/DV and when it is set to other than HDV/DV.

	[HDV/DV IN TC] menu	INPUT SELECT switch	Mode	Time code/User bits displayed and recorded
Playback			Playback Audio dubbing Playback at various speeds ^{a)} DUB1 ^{b)}	Time code/user bits on the tape
EE	INTERNAL	HDV/DV	Duplicate DUPLICATE PLUS1 ^{b)}	Time code/user bits of another device connected to  HDV/DV jack ^{c)}
			Recording Recording Pause REC1 ^{b)}	Time code/user bits internally generated ^{c)} When the input signal is HDV: User bits input via HDV/DV
		S VIDEO VIDEO	Recording Recording Pause REC1 ^{b)}	Time code/user bits internally generated ^{c)}
	EXTERNAL	HDV/DV	Duplicate DUPLICATE PLUS1 ^{b)}	Time code/user bits of another device connected to  HDV/DV jack ^{c)}
			Recording Recording Pause REC1 ^{b)}	Time code input of another device connected to  HDV/DV jack and user bits internally generated When the input signal is HDV: Time code/user bits of another device connected to  HDV/DV jack.
		S VIDEO VIDEO	Recording Recording Pause REC1 ^{b)}	Time code/user bits internally generated ^{c)}

- a) This includes stop, fast-forward or rewind. If the unit cannot read the time code on the tape correctly, the counter displays “- -: - -: - -: - -”.
- b) “DUB1”, “DUPLICATE PLUS1” and “REC1” represent the state of the unit when you press each of these buttons (AUDIO DUB, DUP or REC) in the stop mode.
- c) The time code is also displayed on the time counter screen. For details on the time counter, see page 26.

Dubbing to another equipment using i.LINK jack, Duplication, Audio Dubbing, and Connecting with a Computer

Dubbing to another equipment using i.LINK jack

This section describes the connections and settings necessary to perform dubbing on other equipment, using the unit as a video player.

Connections for Dubbing

Connect the unit to the recorder as shown right using an i.LINK cable.

The signal flow is automatically detected so you do not need to make separate connections for input and output. Also, connecting the unit to an editing controller via **i** HDV/DV jack, you can configure a digital non-linear editing system.

For connections of the editing controller and the unit, refer to the editing controller instruction manual.

Before dubbing, you must set the format in which you want to output signals. Perform [HDV/DV SEL] (page 67) and [i.LINK SET] (page 69) settings in [IN/OUT REC] menu.

For details, refer to "Compatibility of HDV, DVCAM, and DV Formats" (page 93).

To dub a tape recorded in HDV format using duplicate function on such as DSR-25/45/50, select [DVCAM] in [HDV → DV CONV] of [i.LINK SET] in [IN/OUT REC] menu.

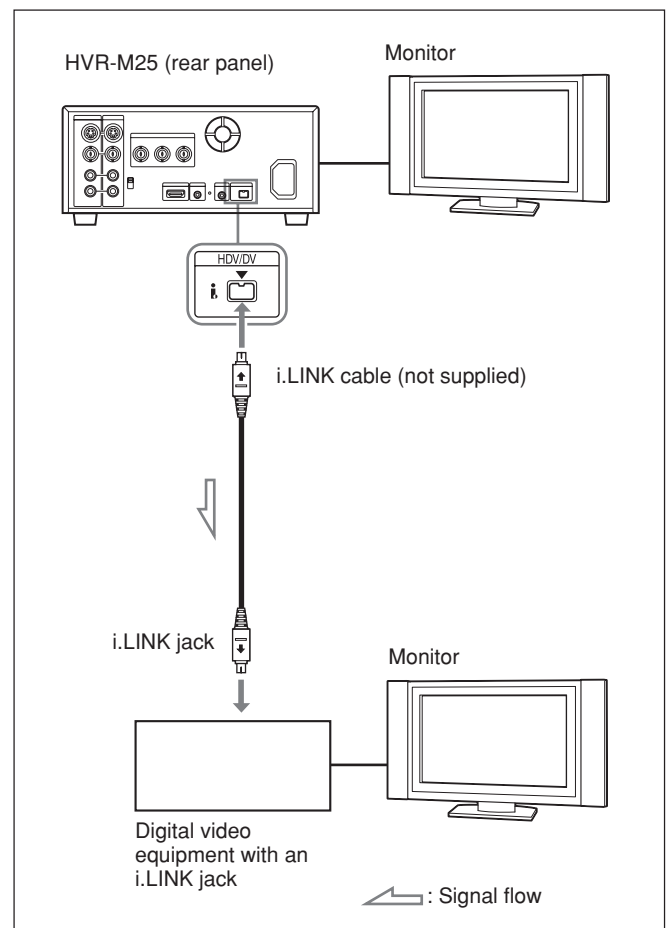

There are some limitations to down convert a tape recorded in HDV format to DVCAM format.

For details, see “i.LINK SET” on page 69.

Notes

- If you output pictures in the playback pause mode when connected with an i.LINK cable, recorded images may appear distorted.
- When the tape is recorded in HDV format, the picture is output as a simplified picture during playback in various speeds (page 37).
- When connected with an i.LINK cable, you cannot output only pictures or sounds separately.
- When you duplicate down converted signals from HDV to DVCAM on an HDV/DV cassette in DVCAM format, the available recording time is reduced to about 2/3 of the recording time indicated on the tape. However, when a DVCAM cassette is recorded using DVCAM format, the available recording time is the same as the recording time indicated on the DVCAM cassette.

Dubbing procedures

1 Prepare the unit.

Refer to “Settings for Recording” on page 45.

2 Prepare the recorder.

If the recorder has an input selector switch, select an input.

For details, refer to your recorder’s instruction manual.

3 Start playback on the unit and start recording on the recorder.

For details, refer to your recorder’s instruction manual.

4 When dubbing is finished, stop recording on the recorder, and then stop playback of the unit.

Duplication (generating a work tape with the same time code)

DUPLICATE PLUS is a dubbing function which duplicates the tape with time codes through i.LINK connection. By using DUPLICATE PLUS, it helps to make a work tape which contains the exact same time code that the original source tape contains.

DUPLICATE PLUS is applicable with HDV1080i, DVCAM, and DV (SP) formats. Also, at the tape end or the tape in PAUSE by operating STOP button, you can change the tape of both the player and recorder during duplication (page 58). Therefore, multiple tapes can be duplicated from multiple resource tapes on a tape continuously.

(The unit does not support cassette memory (C//).)

Note

Use this function when making a one-to-one connection. Also, do not disconnect the i.LINK cable during duplication.

Setting DUPLICATE PLUS mode

Set [DUPLICATE PLUS] mode in [VTR SET] menu.

Setting the duplicating format

Select the duplicating format with [FORMAT SEL] in [DUPLICATE PLUS] mode. The unit functions the same as it has detected a blank portion on a tape, if the unit detects a format other than the selected format (page 58).

ALL : Duplicates the original tape on the recorder.

HDV1080i : The player automatically detects HDV1080i format and duplicate.

DVCAM : The player automatically detects DVCAM format and duplicate.

DV SP : The player automatically detects DV (SP) format and duplicate.

Notes

- If the original signal is mixed with other type of signal as you transfer the image to a computer, the transfer procedures may be interrupted. When transferring an image using a tape dubbed with DUPLICATE PLUS on the unit to a computer, we recommend you to duplicate it in a single format.
- When a non-compatible HDV signals (HDV720p, etc.) is input during duplication after [FORMAT SEL] is set to [ALL], the HDV signals are recorded as an unrecorded portion. Also, when the incompatible DV signals (DV LP etc.) are input, the signal is recorded in DV SP.

- When the format of a tape is switched to a different format during duplication, the portion where the format is switched may be distorted.

Setting the auto rewind function

Set [AUTO REW] in [DUPLICATE PLUS] to select whether you want to use the auto rewind function.

ON : Rewinds the tape on both the player and the recorder, and starts duplication. Also, when you continue to duplicate a resource tape from multiple tapes, the new work tape will be rewound automatically and start duplication.

OFF : Starts duplicating from the current portion of the tape.

Note

Depending on the specification of the player, you may not search on the beginning of a tape. In this case, set [AUTO REW] to [OFF].

Operating DUPLICATE PLUS

The duplicating procedures of DUPLICATE PLUS differs depending on the duplicate settings.

Note

If you operate the player while duplicating, the duplicate process may be interrupted and the tape may not be correctly duplicated. Do not operate the player while duplicating.

When [AUTO REW] in [DUPLICATE PLUS] is set to [ON]:

- 1 Connect the unit and the player using an i.LINK cable (not supplied). After turning on the power of the unit, set INPUT SELECT switch on the unit to HDV/DV.
- 2 Press STOP button on the unit to stop the tape.
- 3 While holding DUPLICATE PLUS button down, press PLAY button on the unit.

The unit and the player will automatically rewind the tape to the beginning. The unit enters the duplicate-standby mode. The player enters the playback pause mode. Then DUPLICATE PLUS and PLAY indicators on the unit light and the duplication starts.

Notes

- Before you start duplication, make sure that the player has finished loading the cassette.
- The duplication starts after the i.LINK connection is established so that the first part of the source tape is dropped on the copied tape.
- If the player has functions such as auto repeat, set them to OFF.
- If the player has a still timer function, set the still timer to the longest time to ensure enough time for rewinding the tape to the beginning.
- When you use a DSR-45 as the player, set REMOTE/LOCAL switch of the DSR-45 to [LOCAL].
- If you operate the player while duplicating and the PLAYER UNCONTROLLABLE warning message appears and duplication stop, press EXEC button on the unit to end duplication once and repeat the procedures.

When [AUTO REW] in [DUPLICATE PLUS] is set to [OFF]:

- 1 Connect the unit and the player using an i.LINK cable (not supplied). After turning on power of the unit and the player, set INPUT SELECT switch on the unit to HDV/DV.
- 2 Locate the points where you want to start playback and recording on each tape.
- 3 Press STOP button on the unit.
- 4 While holding DUPLICATE PLUS button down, press PLAY button on the unit.

The unit enters the duplicate-standby mode. The player enters the playback pause mode. Then DUPLICATE PLUS and PLAY indicators on the unit light and duplication starts.

To adjust the point where duplication starts, while holding DUPLICATE PLUS button down, press PAUSE button and PLAY button in step 4. The unit will not start duplication until you press PAUSE button again.

After confirming that the PLAYER display has changed to [READY] (blinking) on LCD monitor, adjust the duplication start point using the player, then press PAUSE button on the unit to start duplication.

Notes

- Before you start duplication, make sure that the player has finished loading the cassette.
- The duplication starts after the i.LINK connection is established so that the first part of the source tape is dropped on the copied tape. Play back the tape a few frames back of the portion where you want to begin the duplication.
- If the player has functions such as auto repeat, set them to OFF. Also, when the player has an auto rewind function, set the function to ON.
- You may not duplicate the beginning of the source tape. Locate the recorded portion on the source tape, and then start duplication.
- If there is a blank portion on the tape, the first part of the recorded portion that follows may be dropped on the copied tape.
- When the time code on a player operates either discontinuously or incorrectly, the difference in frame values between the numeric time codes may occur.

To cancel duplication

- 1 Press STOP button on the unit, and pause duplicating.

While pausing, the following confirmation display appears.

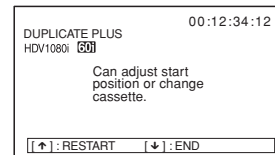

- 2 Press ↓ button.

Duplicating mode ends.

Duplication (generating a work tape with the same time code)

Duplicating a series of tapes

While pausing duplication mode, you can change the tape on the player. Therefore, you can duplicate a series of tapes on a single tape.

To change the tapes

- 1 By playing back the tape on the player to the end or by pressing STOP button on the unit, confirm that the player enters the playback pause mode.

During pause, the confirmation display appears.

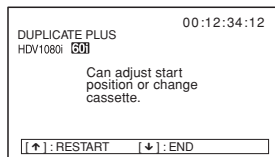

- 2 Eject the tape in the player, and load the another tape.

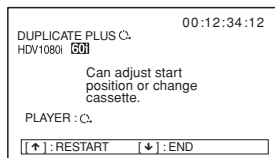

When [AUTO REW] is set to [ON], \mathcal{C} is displayed.

You can eject the tape on the recorder to insert a new tape at this time.

- 3 Press \uparrow button.

Duplication starts again.

When [AUTO REW] is set to [ON], the newly inserted tape is rewound automatically.

Notes

- When you change the source tapes, the beginning of the connecting portion of the recorded content of the work tape may be distorted.
- When you start duplication again, the beginning of the recorded content of the work tape may be distorted as playback starts again.

Detecting a blank portion during duplication

If the unit detects a blank portion on the source tape during duplication, it skips the blank portion automatically, reducing the length of the recorded part of the tape.

The operations of the player and recorder (the unit) when a blank portion is detected are as follows:

Detected status on source tape	Player/Recorder (the unit) operation
Detects a blank portion	Player: Continues playing the tape. Recorder: Continues recording.
Certain seconds after detection of a blank portion	Player: Continues playing the tape another certain seconds and searches forward. Recorder: Stops.
Detects next recorded portion	Player: Rewinds the tape at about -2 times its normal speed to the location immediately before the blank portion ends. Recorder: Remains stopped.
Returns to the location immediately before the blank portion ends	Player: After entering the playback pause mode, starts playing the tape. Recorder: After entering the recording pause mode, starts recording.

The unit performs the above operations automatically to reduce the blank portion of a tape during duplication.

Notes

- Depending on the specifications, the skip function may not work on some players.
- When the unit resumes duplication, the first part of the recorded portion on the source tape may be dropped on the copied tape.
- A recorded portion of less than one minute between two blank portions may not be duplicated.

Warning messages on duplication

If an error occurs during duplication, a STOP/ CAUTION number and warning message will be displayed on LCD monitor and the video output screen.

The following table lists these warnings and messages. If a warning message is displayed, check this table and take the appropriate action.

STOP/ CAUTION No.	Warning Message	Cause/Remedy
00	RECORDER: INPUT SELECT is not set to HDV/DV.	INPUT SELECT switch on the recorder (the unit) is not set to HDV/DV. → Set INPUT SELECT switch to HDV/DV.
01	i.LINK : Cable not connected.	The i.LINK cable is not connected correctly. → Connect the i.LINK cable correctly.
02	i.LINK : Check i.LINK connection.	There are multiple i.LINK connections or the i.LINK connection is looped. → You cannot connect multiple devices. Connect only one player to the unit.
03	i.LINK : Check i.LINK connection.	The i.LINK cable has been unplugged and plugged in again. → Check the i.LINK cable connection. Try to duplicate again.
10	PLAYER: Recording.	The player is in the recording mode.
11	PLAYER: No cassette	There is no cassette in the player.
12	PLAYER: Cannot control.	The player cannot be controlled.
13	PLAYER: Cannot control.	The player rejects control.
14	PLAYER: Cannot control.	The player is disabled or is in a different mode than the recorder (the unit) has requested.
15	PLAYER: Cannot control.	The player is under an inappropriate condition.
16	PLAYER: Cannot record due to copyright protection.	A copyright protected signal is recorded on the cassette in the player. → You cannot duplicate copyright protected signals.
17	PLAYER: Error detected.	The player has detected self-diagnostics.
18	PLAYER: Moisture	Moisture condensation has occurred in the player. → Refer to the instruction manual of the player.
20	RECORDER: No cassette inserted.	There is no cassette in the recorder.
21	RECORDER: The tape is locked. -check the tab.	REC/SAVE switch is set to SAVE switch on the cassette. → Slide REC/SAVE switch to REC on the cassette.
22	RECORDER: Reinsert the cassette.	The recorder (the unit) detected self-diagnostics. → Insert a cassette again.
23	RECORDER: Re-attach the power source	The recorder (the unit) detected self-diagnostics. → Remove the power cord from the recorder.
24	RECORDER: Condensation. Cannot open. Try later.	Moisture condensation has occurred while the cassette is in the recorder (the unit). → Remove the cassette and power on and wait for more than one hour.
25	RECORDER: Moisture condensation. Turn off for 1H.	Moisture condensation has occurred while the cassette is not in the recorder. → Power on the recorder and wait for more than one hour.
26	RECORDER: Dirty video head. Use a cleaning cassette.	The recorder's (the unit) video heads are clogged. → Clean the video heads with the supplied cleaning cassette (<i>see page 90</i>).

Note

When a warning message other than above is displayed, consult your Sony dealer.

Audio Dubbing

You can record just sound on a recorded tape.
(Audio dubbing)

Notes

- You can dub the sound onto a DVCAM-formatted tape recorded in the 32 kHz audio mode (4-channel/12 bits) only. You cannot dub the sound on a tape in the 48 kHz audio mode (2-channel/16 bits). If the audio mode of the recorded tape is 32 kHz, you can dub the sound regardless of [AUDIO MODE] setting in [AUDIO SET] menu.

For details on "AUDIO MODE," see "AUDIO SET" menu on page 73.

- The sound is dubbed only onto channels 3/4.
You cannot dub the sound onto channels 1/2.

Connection of external devices

The following shows an example of a basic connection for audio dubbing.

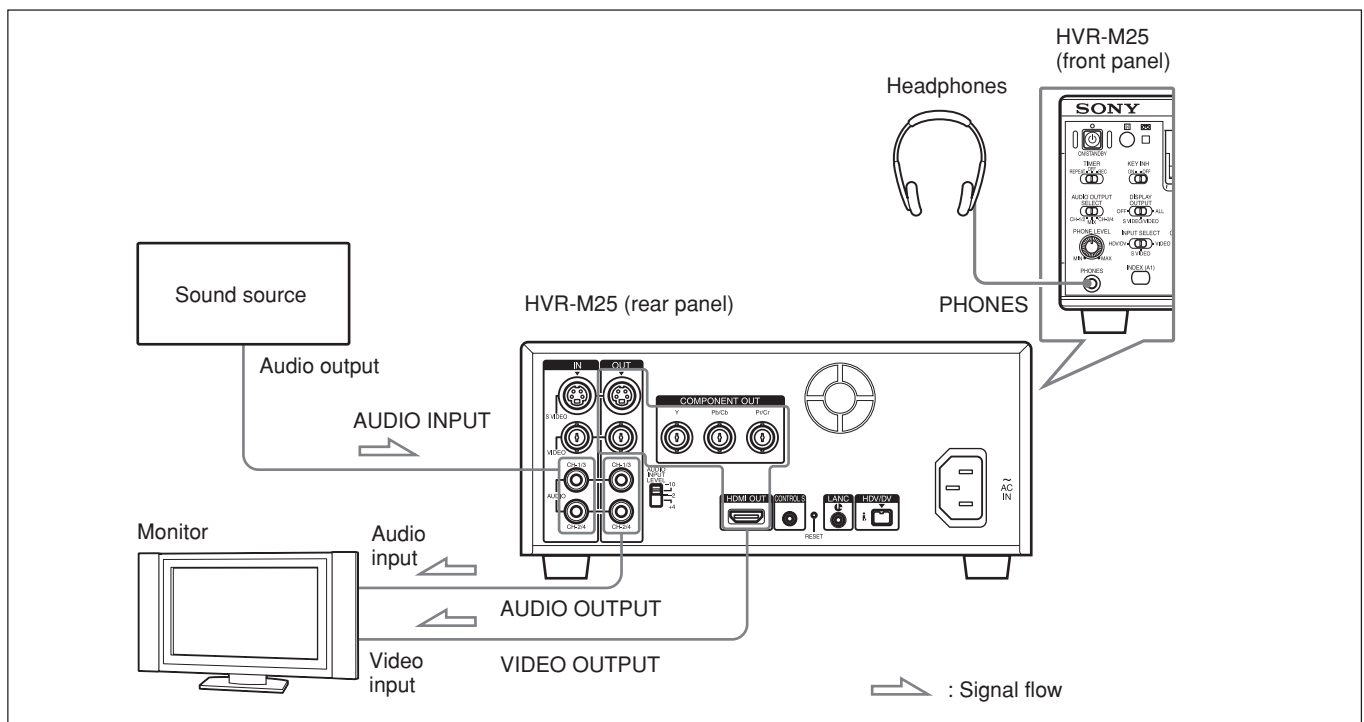

When an HDMI cable is used for connection, Audio cable connection is not necessary.

Dubbing sound

- 1** Connect AUDIO INPUT jack of the unit and the sound source using a phono jack cable (not supplied).
- 2** Set INPUT SELECT switch to a setting other than HDV/DV.
- 3** Switch AUDIO INPUT LEVEL switch to select the audio input signal level (-10, -2 or +4).
- 4** Play back the tape inserted in the unit.
- 5** At the point you want to start dubbing, press PAUSE button to turn the unit to the playback pause mode.
- 6** While holding AUDIO DUB button down, press PLAY button to turn the unit to the audio dubbing pause mode.

AUDIO DUB indicator on the unit lights.
- 7** Set AUDIO INPUT switch to set the adjusting method of the recording level.
- 8** Adjust the recording level by turning AUDIO REC LEVEL control knobs.

You can adjust the recording level with AUDIO REC LEVEL control knobs if you have selected MANU in step 7. While looking at the audio level meters on STATUS CHECK screen, turn AUDIO REC LEVEL control knobs and adjust the recording level. Adjust the audio recording level so that the recording level does not exceed 0 dB when the audio signal is at its maximum. If the recording level exceeds 0 dB, the sound will be distorted.

- 9** Press PAUSE button.

PAUSE indicator goes off and audio dubbing starts.

To pause audio dubbing

Press PAUSE button.

Pressing PAUSE button again resumes audio dubbing.

To stop audio dubbing

Press STOP button.

To monitor the sound you want

Set AUDIO OUTPUT SELECT switch as follows:

CH-1/2: You can listen to sound recorded on channels 1/2 on the tape.

CH-3/4: You can listen to sound to be dubbed on channels 3/4.

MIX: You can listen to the sound on the tape and the dubbed sound.

For details on the audio levels display in the audio dubbing mode, see page 27.

Notes

- You can monitor the sound on the tape while dubbing the sound. However, there are some delays between the sound being recorded and the sound being played. When you play back the tape after audio dubbing, you might hear the dubbed sound later than the sound monitored during audio dubbing.
- You cannot dub sounds onto a blank portion of the tape.

Editing (Connecting with a Computer)

You can set up an editing system by connecting the unit to a computer (editing machine) using **i** HDV/DV jack on the unit.

- For details on the connecting method to the editing machine, refer to the supplied instruction manual of your editing unit.
- The editing functions you can use depend on the editing software. For details on editing methods, refer to the instruction manual of your editing software.

Connecting the Unit to a Computer

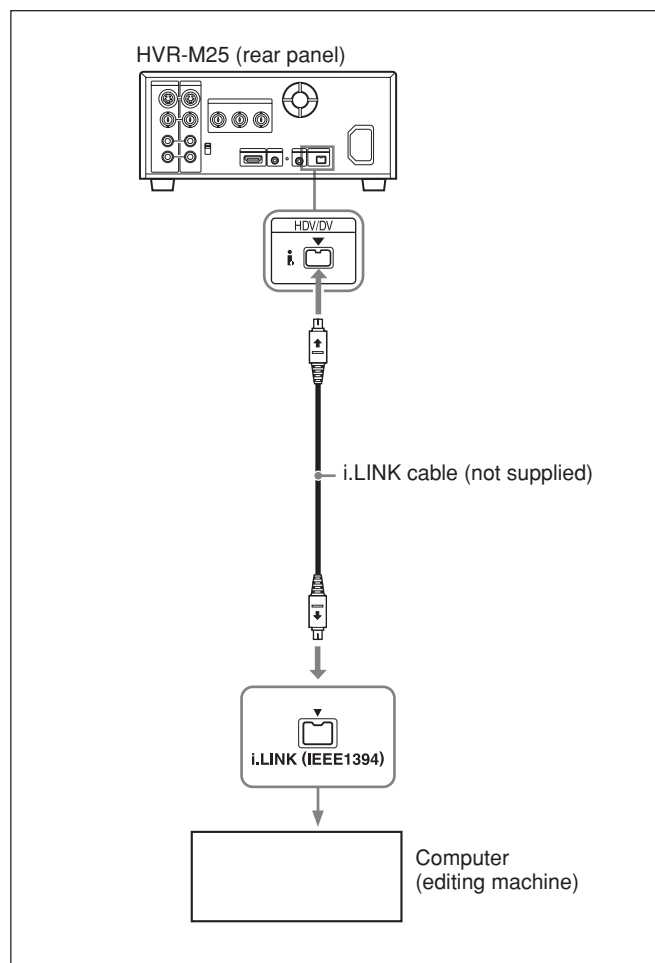

Notes

- Be sure to connect the i.LINK cable to a computer (editing machine) first and then connect it to the unit. If you connect the i.LINK cable to the unit first, it may cause the unit to malfunction because of static electricity.
- If no picture appears via **i** HDV/DV jack, disconnect the i.LINK cable, then reinsert it straight.
- If the unit is connected to a device equipped with an i.LINK jack, when you intend to disconnect or reconnect the i.LINK cable, turn off the device and pull out the plug of its power cord from the wall outlet beforehand. If you connect or disconnect the i.LINK cable while the device is connected to the AC outlet, high-voltage current (8 to 40 V) is output from the i.LINK jack of the device to the unit, which may cause a malfunction.
- Before connecting the i.LINK cable, set [HDV/DV SEL] and [i.LINK SET] in [IN/OUT REC] menu. If you perform the settings after connecting the cable, the computer (editing machine) may not recognize the unit correctly or may freeze.
- If you input or output signals in a format incompatible with the computer (editing machine), the computer may not recognize the unit correctly or may freeze.
- When set to EE mode, the unit outputs analog signals those are input from **i** HDV/DV jack to a computer. S VIDEO or VIDEO signals are output from **i** HDV/DV jack, according to the setting of INPUT SELECT switch. To output the playback image from the unit through **i** HDV/DV jack only, set INPUT SELECT switch to HDV/DV.

Preparations

Transferring picture data from the unit to a computer (editing machine)

- To transfer the picture data recorded on a tape to an editing machine in HDV, set [HDV/DV SEL] in [IN/OUT REC] menu to [HDV] (page 67), then set [HDV→DV CONV] of [i.LINK SET] in [IN/OUT REC] menu to [OFF] (page 69).
- To transfer the picture data recorded on a tape in DVCAM (DV) to an editing machine, set [HDV→DV CONV] of [i.LINK SET] in [IN/OUT REC] menu to [OFF] (page 69).
- To transfer the picture data recorded on a tape in HDV to an editing machine in DVCAM (DV), select [DVCAM] or [DV SP] in [HDV → DV CONV] of [i.LINK SET] in [IN/OUT REC] menu, then set [DOWN CONVERT] (page 69).

Notes

- The operation may not work with some of your editing machine software. Before using the software, confirm that it is compatible with the unit.
 - The unit cannot up convert a tape recorded in DVCAM (DV) format to HDV format when transferring the picture data on an editing machine.
 - If you use a tape recorded both in HDV and DVCAM (DV) formats when [HDV/DV SEL] is set to [AUTO], the computer (editing machine) may not recognize the unit or you may not edit the tape correctly.
 - There are restrictions on the video output when you play back a tape recorded in HDV format at various speeds. Refer to the table for “HDV-formatted tape” in “Playing at various speeds” (page 37).
 - When you use a tape that was down converted from HDV to DVCAM or DV, some conventional DVCAM/DV editing software may not perform the time code search or this operation could result in an error.
 - When you record HDV signals that are input through **i** HDV/DV jack, a connecting portion between scenes on the tape will be displayed as a still picture for approximately 1 second. We recommend you to perform digital nonlinear editing.
- If your editing software has the capability to output the time code as well as the video and audio signals to the unit, and you intend to record that time code, set [HDV/DV IN TC] in [TC/UB SET] menu of the unit to [EXTERNAL].
For details on TC/UB SET menu, see “TC/UB SET” menu on page 75.
 - When [HDV/DV IN TC] in [TC/UB SET] menu is set to [EXTERNAL], if you input time code to the **i** HDV/DV jack that is not continuous or does not advance correctly, the value of the recorder or displayed time code may not be equal to the actual value of the input one. If you use a tape recorded under such condition, you may not perform search or edit the picture, depending on the device you use.
 - For connection of the editing controller and its peripheral devices, refer to the instruction manual of the editing controller and that of the editing software you use.
 - The editing functions you can use depend on the editing software. For details on editing methods, refer to the instruction manual of your editing software.
 - The unit has a function to down convert HDV signals to DVCAM (DV) signals to output from **i** HDV/DV jack. Some software may not edit the DVCAM/DV signals that are down converted from HDV signals correctly. In this case, follow the procedures below for tape duplication, then use the duplicated tape when editing the picture.

Creating a DVCAM compatible tape

Set [HDV → DV CONV] of [i.LINK SET] in [IN/OUT REC] menu to [DVCAM], then perform DVCAM recording using a recording device that accepts DVCAM format.

Creating a general consumer DV compatible tape

Set [HDV → DV CONV] of [i.LINK SET] in [IN/OUT REC] menu to [DV SP], set [DOWN CONVERT] then perform DV recording using a recording device that accepts DV format.

Transferring picture data from a computer (editing machine) to the unit

- To transfer the picture data recorded on a tape to an editing machine in HDV, set [HDV/DV SEL] in [IN/OUT REC] menu to [HDV], then set [HDV → DV CONV] of [i.LINK SET] in [IN/OUT REC] menu to [OFF] (page 69).
- To transfer the picture data to a computer (editing machine) in DVCAM (DV) format, set [HDV/DV SEL] to [DV] (page 67). Then, according to the desired recording format, set [REC MODE] to [DVCAM] or [DV SP] (page 67). Also, according to your edit software, select [DVCAM] or [DV SP] in [HDV → DV CONV] of [i.LINK SET] in [IN/OUT REC] menu (page 69).

Adjusting and Setting Through Menus

Operating the Menu

The unit allows you to set various parameters in the menus. Before you start using the unit, set the internal clock in [CLOCK SET] in [OTHERS] menu. Except for clock setting, you can use all other factory-set default parameters but change them as needed.

Notes

- Do not pull out the power cord plug while operating the menus. Otherwise, the settings of the menu may be changed accidentally.
- If the internal backup battery is exhausted, the time set in the internal clock, 60i/50i setting, and the time code of FREE RUN setting will be initialized. The internal backup battery is fully charged if you connect the power to the unit for about 24 hours. A fully charged internal battery can run for about 3 months.

Displaying the menu

- 1** Press MENU button.
- 2** Pressing \uparrow/\downarrow buttons, select the menu icon you want to change, then press EXEC button.
- 3** Pressing \uparrow/\downarrow buttons, select the submenu you want to change, then press EXEC button.
- 4** Pressing \uparrow/\downarrow buttons, change the setting.
- 5** Press EXEC button to return to the submenu.
- 6** Repeat steps **1** to **5**, as needed.

To return to the previous menu level, press \uparrow/\downarrow buttons and select [↩RETURN].

You can use \leftarrow/\rightarrow buttons to move the menu cursor and to adjust increase/decrease settings.

Operating the Menus

Menu Organization

The menu of the unit consists of the following menus and submenus.

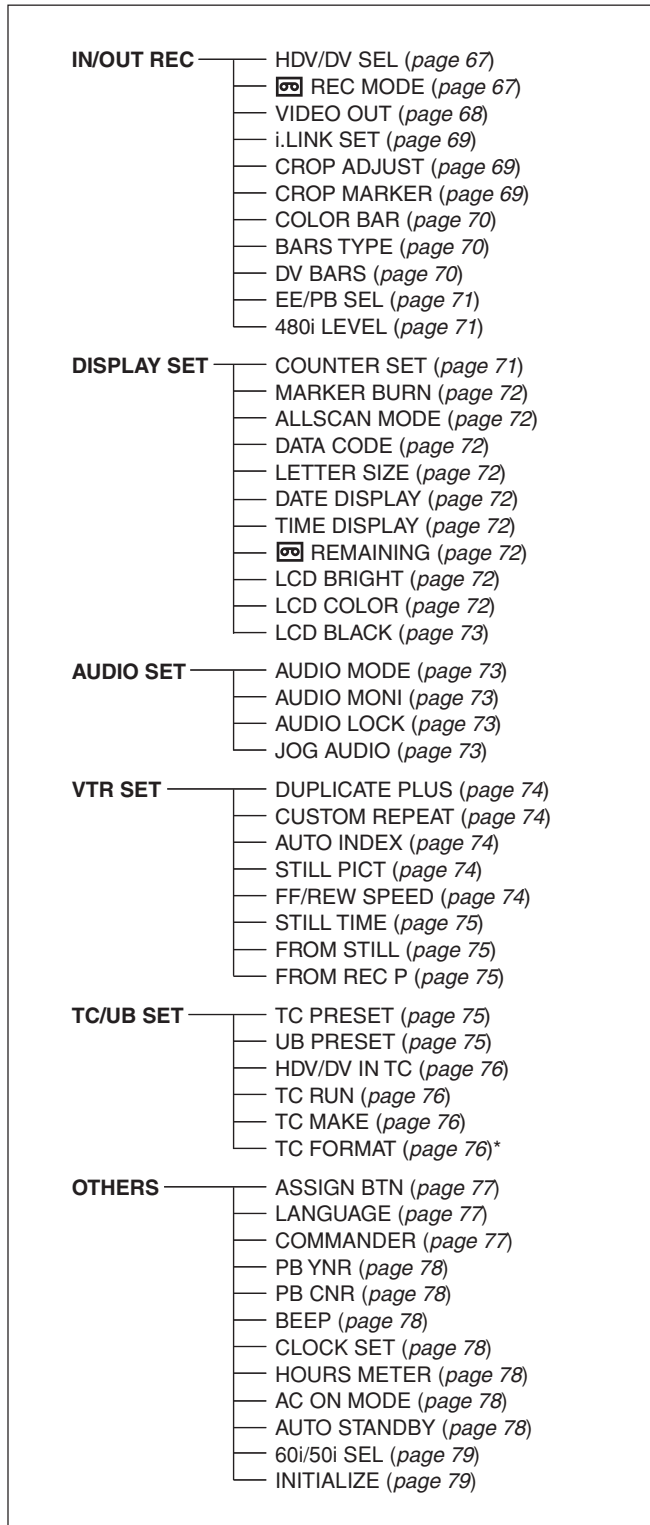





* available only when you use a 60i signal

Menu Contents



Initial settings are indicated with rectangles.

IN/OUT REC menu

Icon/Menu	Submenu	Setting
↔ IN/OUT REC	HDV/DV SEL (page 34, 44, 54, 62)	<p>Normally, set this menu to [AUTO]. Select this menu when you want to limit the output format during tape playback or limit the signals to be input or output from  HDV/DV jack. This setting will affect analog outputs.</p> <p>AUTO : Automatically switches signals to HDV format or DVCAM/DV format during tape playback. When the i.LINK cable is connected, the signals in HDV format or DVCAM/DV format will be switched automatically and signals from  HDV/DV jack will be input /output for recording/playback.</p> <p>HDV : Outputs portions of signals recorded in HDV format during tape playback. When the i.LINK cable is connected, only the signals in HDV format from  HDV/DV jack will be input/output for recording/playback. Also, select this setting when the unit is connected to the i.LINK cable to a computer supporting HDV format (see page 44, 54).</p> <p>DV : Outputs signals of portions recorded in DVCAM/DV format during tape playback. When the i.LINK cable is connected, only the signals in DVCAM/DV format from  HDV/DV jack are input or output for recording/playback. Also select this setting when the unit is connected to the i.LINK cable to a computer that supports DV format (see page 44, 54).</p> <p>Notes</p> <ul style="list-style-type: none"> • Before changing the setting, be sure to disconnect the i.LINK cable, or turn the other device off. If an i.LINK cable is connected when you change the setting, the video equipment may not recognize the signals correctly. • If you select [AUTO], the screen turns off temporarily when HDV signals are switched to DVCAM/DV signals or vice versa. The video and audio also stops at the same time. • For details on the i.LINK output and the recording tape format, see pages 96 and 97.
	 REC MODE	<p>Switches the recording mode between DVCAM and DV format (SP mode only).</p> <p>DVCAM : Records in DVCAM format.</p> <p>DV SP : Records in DV format (SP mode).</p> <p>Note</p> <p>You cannot change the setting during recording.</p>

(Continued)

Operating the Menus

Icon/Menu	Submenu	Setting
↔ IN/OUT REC	VIDEO OUT	<p>Selects the mode of the video output jacks.</p> <p>HDMI/CMPNT Selects the output format from HDMI OUT jack and COMPONENT OUT jacks. Select from [480i], [480p/480i], [1080i/480i], or [720p/480i] when [60i/50i SEL] in [OTHERS] menu is set to 60i. Select from [576i], [576p/576i], [1080i/576i], or [720p/576i] when [60i/50i SEL] in [OTHERS] menu is set to 50i.</p> <p>DOWN CONVERT Selects the setting for down converting images output from HDMI OUT jack and analog video jacks when playing back HDV format or inputting HDV signals from , HDV/DV jack.</p> <p>SQUEEZE: Maintains the image vertically and horizontally by compressing the horizontal ratio. Images appear vertically long.</p> <p>LETTER BOX: Maintains the image vertically by compressing the vertical ratio.</p> <p>EDGE CROP: Maintains the original image size and crops the left and right edges of the images.</p> <p>Notes</p> <ul style="list-style-type: none"> • When you play back an HDV-formatted tape with copyright protected signals, or input HDV format with copyright protected signals to , HDV/DV jack, COMPONENT OUT jacks will output pictures in either 480i or 576i format. • Regardless of the playback tape or of the format input to , HDV/DV jack, the selectable setting values displayed on this menu vary depending on the setting of [60i/50i SEL]. • WSS (Wide Screen Signaling) is not output, when the picture is output to COMPONENT OUT jacks in 480p or 576p. Set the monitor according to the down convert format of the picture, which is output from the unit. • When you play back a tape in DVCAM (DV) format while an EE picture in NTSC/PAL is displayed, the 480i resolution or the 576i resolution is output, regardless of the setting of [HDMI/CMPNT].



Icon/Menu	Submenu	Setting
↔ IN/OUT REC	i.LINK SET (pages 34, 54)	<p>Adjusts the down conversion format. This menu is available when [HDV/DV SEL] is set to [AUTO] or [HDV].</p> <p>HDV → DV CONV</p> <p>OFF: Disables down conversion.</p> <p>DVCAM: Down converts to DVCAM format.</p> <p>DV SP: Down converts to DV SP format.</p> <p>DOWN CONVERT</p> <p>This setting is available when [HDV → DV CONV] is set to [DVCAM] or [DV SP].</p> <p>SQUEEZE: Plays back with compressed horizontal screen image and maintains all images on display. Images appear vertically long.</p> <p>EDGE CROP: Plays back with both left and right sides of the screen images cut off and maintains the original image appearance.</p> <p>Notes</p> <ul style="list-style-type: none"> • When [DVCAM] is selected, there are some limitations described below. <ul style="list-style-type: none"> – ATN (Absolute Track Number) outputs the value counted in DVCAM format during playback at regular speed (×1) or recording of the internal color bars only. During playback at irregular speeds other than described above, ATN outputs the value of a tape recorded in HDV format. – When the unit is playing back at regular speed (×1) while detecting a blank portion on the tape, the unit counts the blank portion as ATN-formatted in DVCAM. – When using the duplicating function that is equipped with a device such as the DSR-25/45/50, select [DVCAM]. – Please note that a duplicated tape and the source tape recorded in HDV format with [DVCAM] selected do not share the same ATN (Time code value is displayed correctly). • When you change the video format setting of [DOWN CONVERT] of [i.LINK SET] in [IN/OUT REC] menu, the video signal output from COMPONENT OUT jacks, S VIDEO OUT jack, or VIDEO OUT jack may be distorted for a moment. • Before changing your setting, be sure to disconnect the i.LINK cable. If you change the setting while i.LINK is connected, the video device may not recognize the new setting. • When you select [EDGE CROP], the outputs of S VIDEO and VIDEO are limited. For details, see page 85.
	CROP ADJUST (page 41)	<p>Adjusts the position of edge cropping when down converting 16:9 to 4:3 aspect ratio. Adjusts the position of the crop marker by pressing ↔ buttons to move either left or right, and press EXEC button to finish. (You can also use ↑/↓ buttons.)</p>
	CROP MARKER (page 41)	<p>Selects whether to display EDGE CROP MARKER or not.</p> <p>OFF: Does not display the crop marker.</p> <p>ON: Displays the crop marker.</p> <p>Notes</p> <ul style="list-style-type: none"> • This setting is only available, when [DOWN CONVERT] of [VIDEO OUT] or [i.LINK SET] in [IN/OUT REC] menu is set to [EDGE CROP]. • EDGE CROP MARKER is displayed when HDV-formatted tape is played back. EDGE CROP MARKER is also displayed when HDV signals are input to i, HDV/DV jacks.

(Continued)

Operating the Menus

Icon/Menu	Submenu	Setting
↔ IN/OUT REC	COLOR BAR	<p>Selects whether to display color bars or not. Also, you may select color bars with or without tone signals (1 kHz full bit –20 dB at 60i, 1 kHz full bit –18 dB at 50i).</p> <p>OFF: Does not display color bars and no tone signals. ON: Displays color bars without tone signals. ON [TONE]: Displays color bars with tone signals.</p> <p>Notes</p> <ul style="list-style-type: none"> • Color bars and tone signals are output from HDMI OUT jack, i, HDV/DV jack, and analog output jacks. • Color bars and tone signals cannot be output when the tape is in playback mode. • The color bars output to i.LINK/the color bars and tone signals recorded on tapes/the format of tone signals can be set by [HDV/DV SEL] and [REC MODE]. <ul style="list-style-type: none"> – When [HDV/DV SEL] is set to [AUTO], the format of the color bar and tone signals will be output/recorded according to the video format displayed in “1 Format indicator” (page 25) of text data display on a monitor. – When [HDV/DV SEL] is set to [HDV], color bars and tone signals are output/recorded in HDV format. – When [HDV/DV SEL] is set to [DV] and [REC MODE] in [IN/OUT REC] menu is set to [DVCAM], color bars and tone signals will be output/recorded in DVCAM format. – When [HDV/DV SEL] is set to [DV] and [REC MODE] in [IN/OUT REC] menu is set to [DV SP], color bars will be output/recorded in DV (SP) format. • When the unit turns off and on again, [COLOR BAR] is automatically set to [OFF].
	BARS TYPE	<p>Selects the type of color bars.</p> <p>TYPE 1: Outputs TYPE 1 color bars. TYPE 2: Outputs TYPE 2 color bars. TYPE 3: Outputs TYPE 3 color bars.</p> <p>Notes</p> <ul style="list-style-type: none"> • When color bars are output in NTSC (60i) mode on the unit, no-setup (0 IRE) signals are output. • Even when the unit’s screen aspect ratio displays 4:3, the color bars are generated as 16:9. To output the edge crop (4:3) in HDV format, select [TYPE 1]. • Color bars on the unit are generated in HDV (1080i) resolution. When a resolution other than HDV (1080i) is output, the color bars are down converted and output. The transition edges between the color bars are distorted. • You cannot change the current setting during recording.
	DV BARS	<p>Selects the aspect ratio of color bars set in [BARS TYPE] (DVCAM/DV (SP) format only).</p> <p>16:9: Sets the aspect ratio of color bars to 16:9. 4:3: Sets the aspect ratio of color bars to 4:3.</p> <p>Note</p> <p>You cannot change the current setting during recording.</p>

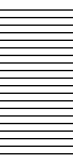

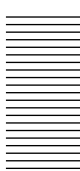

Icon/Menu	Submenu	Setting																	
IN/OUT REC	EE/PB SEL <i>(page 14)</i>	Sets the stop, fast-forward and rewind modes. EE : Outputs EE picture and EE sound. PB : Mutes the image and sound. Note If this item is set to PB, the output from the unit will be as follows when you press any of the REC, DUPLICATE PLUS, or AUDIO DUB buttons separately when the unit is stopped (unless the cassette has been write-protected). <table border="1" style="margin: 10px auto;"> <thead> <tr> <th></th> <th>Image</th> <th>Sound</th> <th>Time code</th> </tr> </thead> <tbody> <tr> <td>REC button</td> <td>EE picture of the input image</td> <td>EE sound of the input sound (CH-1/2)^{a)}</td> <td rowspan="4" style="text-align: center; vertical-align: middle;"><i>(See page 53)</i></td> </tr> <tr> <td>DUPLICATE PLUS button^{b)}</td> <td>Image input to HDV/DV jack</td> <td>Sound input to HDV/DV jack</td> </tr> <tr> <td>AUDIO DUB button</td> <td>Mute screen (black)</td> <td>EE sound of the input sound (CH-3/4)^{a)}</td> </tr> <tr> <td>No button is pressed</td> <td>Mute screen (black)</td> <td>Mute (no sound)</td> </tr> </tbody> </table> <p>a) Set AUDIO OUTPUT SELECT switch appropriately. b) When INPUT SELECT switch is set to HDV/DV.</p>		Image	Sound	Time code	REC button	EE picture of the input image	EE sound of the input sound (CH-1/2) ^{a)}	<i>(See page 53)</i>	DUPLICATE PLUS button ^{b)}	Image input to HDV/DV jack	Sound input to HDV/DV jack	AUDIO DUB button	Mute screen (black)	EE sound of the input sound (CH-3/4) ^{a)}	No button is pressed	Mute screen (black)	Mute (no sound)
		Image	Sound	Time code															
REC button	EE picture of the input image	EE sound of the input sound (CH-1/2) ^{a)}	<i>(See page 53)</i>																
DUPLICATE PLUS button ^{b)}	Image input to HDV/DV jack	Sound input to HDV/DV jack																	
AUDIO DUB button	Mute screen (black)	EE sound of the input sound (CH-3/4) ^{a)}																	
No button is pressed	Mute screen (black)	Mute (no sound)																	
	480i LEVEL	Selects the component output level of luminance and chrominance from either BETACAM or SMPTE signals when the component output is set to 480i. BETACAM : Sets COMPONENT OUT jacks to BETACAM level. SMPTE : Sets COMPONENT OUT jacks to SMPTE level. Note For details on COMPONENT OUT jacks specifications, <i>see page 100</i> .																	

DISPLAY SET menu

Icon/Menu	Submenu	Setting
DISPLAY SET	COUNTER SET	Selects the appearance of the time counter. DISPLAY ON : Enables the time counter display. OFF : Disables the time counter display. SIZE LARGE : Displays the time counter in large letters. SMALL : Displays the time counter in small letters. COLOR TYPE 1 : Displays the time counter with color type 1. TYPE 2 : Displays the time counter with color type 2. TYPE 3 : Displays the time counter with color type 3. TYPE 4 : Displays the time counter with color type 4.

(Continued)



Operating the Menus

Icon/Menu	Submenu	Setting
 DISPLAY SET (page 42)	MARKER BURN	Selects whether to output MARKER BURN or not. OFF : Does not output MARKER BURN. ON : Outputs MARKER BURN. Note There are some limitations to output MARKER BURN. For details, see page 42.
	ALLSCAN MODE	Reduces the image on LCD panel to check the area surrounding the picture frame where the monitors can not display. OFF : Disables the ALLSCAN MODE. ON : Enables the ALLSCAN MODE. Notes <ul style="list-style-type: none"> • ALLSCAN MODE is for HDV format only. ALLSCAN MODE does not activate when DVCAM and DV(SP)-formatted tapes are played. • If formats are mixed on a tape, the part where the format has changed on a tape cause distortion of images. • When [ON] is selected and the output level of COMPONENT OUT is set to 480i, 576i, 480p/480i, or 576p/576i, output images from S VIDEO OUT jack and VIDEO OUT jack down converts to letter box. For details, see page 85. • Once the unit turns off, the setting of [ALLSCAN MODE] sets to [OFF] automatically. • When you set [MARKER BURN] and [ALLSCAN MODE] in [DISPLAY SET] menu to [ON] at the same time, the marker will not appear in the correct position on LCD monitor. This is not a malfunction. The marker will be output correctly via each video jack.
	DATA CODE	Selects whether or not to display the data codes on the analog video output. OFF : Does not display the data codes. DATE : Displays the date and time when recorded. CAMERA DATA : Displays the camera data.
	LETTER SIZE	Selects the letter size of the menu at the cursor. NORMAL : Normal size 2 x : Double height size
	DATE DISPLAY	Selects the date display in the search screen, the data code display, etc. Y/M/D : Displays YY/MM/DD (year/month/day). M/D/Y : Displays MM/DD/YY (month/day/year). (Default setting for HVR-M25U/M25N.) D/M/Y : Displays DD/MM/YY (day/month/year). (Default setting for HVR-M25E/M25P.)
	TIME DISPLAY	Selects the time display in the search screen, the data code display, etc. 12H : Displays 12-hour time. (Default setting for 60i as the factory setting.) 24H : Displays 24-hour time. (Default setting for 50i as the factory setting.)
	REMAINING	AUTO : The remaining tape time is displayed for 8 seconds under the following conditions. – If the remaining tape time is determined when you turn on power while a cassette is loaded in the unit. – When you press PLAY button. Always displays under the following conditions. – Fast forward, rewind – Fast forward during playback, rewind during playback ON : Always displays the remaining tape time.
	LCD BRIGHT	Adjusts LCD monitor brightness. Press \uparrow/\downarrow buttons and EXEC button to adjust the brightness. (The mark under the bar is the factory setting value.)
	LCD COLOR	Adjusts the color density of LCD monitor. Press \uparrow/\downarrow buttons and EXEC button to adjust the brightness. (The mark under the bar is the factory setting value.)

Operating the Menus

Icon/Menu	Submenu	Setting
 DISPLAY SET	LCD BLACK	<p>Mutes the images on LCD panel and display only the text data.</p> <p>OFF: Does not mute the images</p> <p>ON: Mutes the images</p> <p>Note When [ON] is selected, the images output from the rear panel to the external monitor does not mute.</p>

AUDIO SET menu

Icon/Menu	Submenu	Setting
 AUDIO SET	AUDIO MODE <i>(page 27)</i>	<p>Selects the audio mode.</p> <p>FS32K: Switches the audio mode to 4-channel mode (12-bit mode).</p> <p>FS48K: Switches the audio mode to 2-channel mode (16-bit mode). (This setting records the sound in all audio ranges, providing a high-quality sound recording.)</p> <p>Notes</p> <ul style="list-style-type: none"> • When signals are input from , HDV/DV jack, the audio mode of the signals to be recorded is the same as that of the input signals. • Recording performs automatically in [FS48K] mode in HDV format. • You cannot change the current setting during recording. • Noise may occur at the instant you switch the audio mode. • When dubbing a sound source in DVCAM, select [FS32K].
	AUDIO MONI <i>(page 27)</i>	<p>Sets the audio that is output from PHONES jack and HDMI OUT jack.</p> <p>CH1,CH2: Outputs CH1 and CH2 audio to each channel.</p> <p>CH1: Outputs CH1 audio to CH1/2.</p> <p>CH2: Outputs CH2 audio to CH1/2.</p> <p>Note When AUDIO OUTPUT SELECT switch is set to CH3/4, [CH1] and [CH2] are correspond to [CH3] and [CH4], respectively. When it is set to MIX, [CH1] and [CH2] are correspond to CH1/3 synthesis sound and CH2/4 synthesis sound, respectively.</p>
	AUDIO LOCK	<p>UNLOCK MODE: Records the sampling clocks of audio and video independently. This mode applies to a consumer DV tape.</p> <p>LOCK MODE: Synchronizes the sampling clocks of the audio and video for recording. This setting is effective for digital processing and performs a clean splice during the audio editing process.</p> <p>Notes</p> <ul style="list-style-type: none"> • You can set this menu when recording in DV format (SP mode) only. • When recording in HDV or DVCAM format, the menu is set to [LOCK MODE]. • During the i.LINK input, the same setting as that of an input signal is selected regardless of this setting.
	JOG AUDIO <i>(page 38)</i>	<p>Selects either to turn the sound output on or off when the tape is played at a speed other than normal. (Available in DVCAM/DV format only.)</p> <p>OFF: Does not output the sound when playing a tape at a speed other than normal.</p> <p>ON: Outputs the sound when playing a tape at a speed other than normal.</p> <p>Notes</p> <ul style="list-style-type: none"> • When a tape recorded in HDV format is played back, the sound cannot be output in various speeds. • Even if you have set this item to ON, the sound may not be output or may be interrupted depending on the recording format or tape conditions.

Operating the Menus

VTR SET menu

Icon/Menu	Submenu	Setting
 VTR SET	DUPLICATE PLUS (page 56)	<p>Selects the video format and whether to use auto rewind or not while duplication.</p> <p>FORMAT SEL</p> <p>ALL: Duplicates all video formats. HDV1080i : Duplicates HDV1080i format only. DVCAM : Duplicates DVCAM format only. DV SP : Duplicates DV (SP) format only.</p> <p>AUTO REW</p> <p>ON : Rewinds the tape on both the player and the recorder, and starts duplication. Also, when you continue to duplicate a resource tape from multiple tapes, the new work tape will be rewound automatically and start duplication.</p> <p>OFF : Starts duplicating from the current portion of the tape.</p> <p>Note You cannot use these settings during duplication.</p>
	CUSTOM REPEAT (page 39)	<p>Adjusts the REPEAT TIMES, REPEAT CYCLE, and START TIME of the CUSTOM REPEAT.</p> <p>REPEAT TIMES</p> <p>ON/OFF : Selects whether to apply REPEAT TIMES setting or not. TIMES : Sets the number of times to repeat playbacks. Set the number by pressing \uparrow/\downarrow buttons on the unit.</p> <p>REPEAT CYCLE</p> <p>ON/OFF : Selects whether to apply REPEAT CYCLE setting or not. CYCLE : Sets the time of intervals for playback. Set the number by pressing \uparrow/\downarrow buttons on the unit.</p> <p>START TIME</p> <p>ON/OFF : Selects whether to apply START TIME setting or not. TIME : Sets the starting time of CUSTOM REPEAT. Set the number of each hour and minute by pressing \uparrow/\downarrow buttons on the unit. Press \leftarrow/\rightarrow buttons to switch between hour and minute. Press EXEC button to execute.</p>
	AUTO INDEX (page 47)	<p>Selects whether or not to mark an index signal automatically when the unit in the stop mode starts recording.</p> <p>ON: Marks an index signal at the beginning of the recording. OFF: Does not mark an index signal at the beginning of the recording.</p>
	STILL PICT	<p>Selects the image displayed in the still mode (DVCAM/DV (SP) format only).</p> <p>AUTO: Displays an optimized image according to the movement in the image. FRAME: Displays a frame image. FIELD: Displays a field image.</p> <p>Notes</p> <ul style="list-style-type: none"> • If you select [FIELD], the image of field 2 is displayed. • When a tape has been recorded in HDV format, a field image is always displayed.
	FF/REW SPEED (page 15)	<p>Selects the tape transport mode in fast-forward and rewind.</p> <p>FF/REW: Fast-forwards or rewinds the tape at maximum speed without displaying the picture.</p> <p>SHUTTLEMAX : Fast-forwards or rewinds the tape at maximum speed while displaying the picture.</p> <p>DVCAM NTSC: Approx. 14 times of normal speed PAL: Approx. 17 times of normal speed HDV/DV(SP) Approx. 24 times of normal speed</p>

Icon/Menu	Submenu	Setting
 VTR SET	STILL TIME	<p>Selects the time to switch to the tape protection mode from the still mode.</p> <p>30 sec : 30 seconds 1 min : 1 minute 2 min : 2 minutes 3 min : 3 minutes</p> <p>Notes</p> <ul style="list-style-type: none"> • If the unit is left in playback pause mode for a long time, the tape or the video heads may be damaged or the video heads may become clogged. Select the shortest time possible. Particularly, when using a Mini-DV cassette that is longer than 60 minutes, select [30 SEC] or [1 MIN]. • When the setting is changed, the first tape protection mode change uses the time setting from before the settings were changed. From the second tape protection mode change, the new time setting is used.
	FROM STILL	<p>Selects the tape protection mode to change the mode after the time set in [STILL TIME] is past</p> <p>STOP : Stops the tape. STEP FORWARD : Forwards one frame.</p> <p>Note</p> <p>If you play a tape recorded in HDV format with [STEP FORWARD] selected, the tape advances a few frames forward.</p>
	FROM REC P	<p>Selects the tape protection mode which the unit changes after the recording has been paused for more than 3 minutes.</p> <p>STOP : Stops the tape. REC PAUSE : Maintains the recording pause mode.</p> <p>Note</p> <p>When the recording pause mode continues for a long time after you select [REC PAUSE], the tape may be damaged or the video heads may be damaged or clogged. If there is no other reason to do this, select [STOP]. Particularly when you use a Mini-DV cassette that is longer than 60 minutes, select [STOP].</p>

TC/UB SET menu

Icon/Menu	Submenu	Setting
 TC/UB SET	TC PRESET (page 50)	<p>Reset the time code value or set the desired time code value.</p> <p>RESET : Resets the time code value to 00:00:00:00. PRESET : Sets the desired time code value.</p> <p>Note</p> <p>To set the initial time code value, you need to set [TC MAKE] to [PRESET] first. If [TC MAKE] has been set to [REGENERATE], or [HDV/DV IN TC] has been set to [EXTERNAL], this setting is not effective.</p>
	UB PRESET (page 50)	<p>Resets the user bits value or set the desired user bits value.</p> <p>RESET : Resets the user bits value to 00 00 00 00. PRESET : Sets the user bits value. (You can set the user bits as eight-digit hexadecimal values (0 to 9, A to F) (base 16) to have the date, time, scene number, and other information inserted into the user bits.)</p> <p>Note</p> <p>When INPUT SELECT switch is set to HDV/DV and HDV signals are input to the unit, this setting is not effective. (When color bar is displaying or recording, this setting is effective.)</p>

(Continued)

Operating the Menus

Icon/Menu	Submenu	Setting
00:00 TC/UB SET	HDV/DV IN TC (page 49)	<p>Selects whether to record internal time code or external time code while the unit records the signals input from i, HDV/DV jack.</p> <p>INTERNAL : Records the time code generated by the internal time code generator. (If [TC MAKE] is set to [REGENERATE] and no time code is recorded on the tape, the unit records time code from 00:00:00:00. If there is time code already recorded on the tape, the unit records continuous time code from this point.)</p> <p>EXTERNAL : Records the time code with video and audio signals input from i, HDV/DV jack.</p> <p>Notes</p> <ul style="list-style-type: none"> • When this item is set to [EXTERNAL], INPUT SELECT switch on the front panel is set to HDV/DV, and no signal is input from i, HDV/DV jack, if you start recording, bars (—:—:—:—) are recorded as time code. At the point that inputting of a signal begins, the time code of that signal will be recorded. • If you set this item to [EXTERNAL] and the external time code input is discontinuous or does not advance correctly, recording or displaying the time code on the unit may not be done correctly. If there is a discontinuous time code on your recorded tape, you may not edit or search correctly, depending on the device used to edit.
	TC RUN (page 51)	<p>Selects the advancement mode (counting up).</p> <p>REC RUN : Time code value advances only while recording.</p> <p>FREE RUN : Time code value advances even when the unit is not recording. (Use this setting to adjust the initial value of the time code to the present time.)</p> <p>Notes</p> <ul style="list-style-type: none"> • If you set the advancement mode to [FREE RUN], the time code will be updated by the internal clock when the power is off. Therefore, when you turn on the unit again, the time code may have been delayed or advanced somewhat. • If the internal backup battery is exhausted, the time code of [FREE RUN] setting is initialized.
	TC MAKE (page 51)	<p>Selects the time code when you start recording.</p> <p>REGENERATE : The time code value is set to continuous time code from the one already recorded on the tape. If no time code is recorded on the tape, it starts from 00:00:00:00.</p> <p>PRESET : The time code starts from the value set in [TC PRESET] in [TC/UB SET] menu.</p>
	TC FORMAT (page 52)	<p>Selects the recording mode of the time code when 60i format is used.</p> <p>AUTO : Automatically sets the mode in accordance with the mode already set on a cassette tape. (If nothing is recorded on the tape, the non-drop frame mode is set. If the unit cannot correctly read the frame mode on the tape, it will use the frame mode that was set in the last position on the tape that the unit can read correctly. If you remove the cassette, the mode of the last position that the unit was able to read correctly is cleared and the non-drop frame mode is set when recording is restarted from the same position. If [TC MAKE] is set to [PRESET], the non-drop frame mode is set.)</p> <p>DF : Selects the drop frame mode.</p> <p>NDF : Selects the non-drop frame mode.</p> <p>Note</p> <p>When [60i/50i SEL] is set to [50i], the unit operates as a 50i specification model. Therefore, the time code is set to the non-drop frame mode. Even if 60i signals are input to i, HDV/DV jack when [60i/50i SEL] is set to [50i], the time code generated by the unit is in the non-drop frame mode regardless of [TC FORMAT] setting. To set the time code in the drop frame mode, set [60i/50i SEL] to [60i]. As a result, [TC FORMAT] setting will return to the status before [60i/50i SEL] menu was set to [50i].</p>

OTHERS menu

Icon/Menu	Submenu	Setting																																										
OTHERS	ASSIGN BTN (pages 11, 12, 14)	<p>Assigns a function other than the default functions to ASSIGN buttons (INDEX (A1) button, RESET (A2) button, AUDIO DUB (A3) button). The available functions of each ASSIGN button are as listed below.</p> <table border="1"> <thead> <tr> <th>INDEX (A1) button</th> <th>RESET (A2) button</th> <th>AUDIO DUB (A3) button</th> </tr> </thead> <tbody> <tr> <td>INDEX WRITE ^{a)}</td> <td>COUNTER RESET ^{a)}</td> <td>AUDIO DUB ^{a)}</td> </tr> <tr> <td colspan="3">HDV → DV CONV ^{c)}</td> </tr> <tr> <td colspan="3">HDMI/CMPNT ^{c)}</td> </tr> <tr> <td colspan="3">END SEARCH</td> </tr> <tr> <td colspan="3">DATA CODE ^{b)}</td> </tr> <tr> <td colspan="3">ALLSCAN MODE ^{c)}</td> </tr> <tr> <td colspan="3">COLOR BAR ^{c)}</td> </tr> <tr> <td colspan="3">SEARCH SELECT ^{b)}</td> </tr> <tr> <td colspan="3">SEARCH + ^{b)}</td> </tr> <tr> <td colspan="3">SEARCH – ^{b)}</td> </tr> <tr> <td colspan="3">COUNTER SIZE ^{c)}</td> </tr> <tr> <td colspan="3">COUNTER COLOR ^{c)}</td> </tr> <tr> <td colspan="3">FF/REW SPEED ^{c)}</td> </tr> </tbody> </table> <p>a) Default setting b) Same functions as on REMOTE COMMANDER c) The above settings can be set with the menu on the unit. For details, refer to the menu items. END SEARCH: The last five second portion recorded on a tape is played back and stopped. Use END SEARCH to check the last picture recorded. Once you eject the tape from the unit, you cannot use this function.</p> <p>Notes</p> <ul style="list-style-type: none"> The default functions on each ASSIGN buttons can not be assigned to other ASSIGN buttons. If you assign other functions, A1, A2, and A3 will be displayed on left corner of the Data display screen. 	INDEX (A1) button	RESET (A2) button	AUDIO DUB (A3) button	INDEX WRITE ^{a)}	COUNTER RESET ^{a)}	AUDIO DUB ^{a)}	HDV → DV CONV ^{c)}			HDMI/CMPNT ^{c)}			END SEARCH			DATA CODE ^{b)}			ALLSCAN MODE ^{c)}			COLOR BAR ^{c)}			SEARCH SELECT ^{b)}			SEARCH + ^{b)}			SEARCH – ^{b)}			COUNTER SIZE ^{c)}			COUNTER COLOR ^{c)}			FF/REW SPEED ^{c)}		
	INDEX (A1) button	RESET (A2) button	AUDIO DUB (A3) button																																									
INDEX WRITE ^{a)}	COUNTER RESET ^{a)}	AUDIO DUB ^{a)}																																										
HDV → DV CONV ^{c)}																																												
HDMI/CMPNT ^{c)}																																												
END SEARCH																																												
DATA CODE ^{b)}																																												
ALLSCAN MODE ^{c)}																																												
COLOR BAR ^{c)}																																												
SEARCH SELECT ^{b)}																																												
SEARCH + ^{b)}																																												
SEARCH – ^{b)}																																												
COUNTER SIZE ^{c)}																																												
COUNTER COLOR ^{c)}																																												
FF/REW SPEED ^{c)}																																												
	LANGUAGE	You can select the desired language on Data display screen. You can choose Simplified English if your native language is not available among the options.																																										
	COMMANDER (page 24)	<p>Selects the control device.</p> <p>WIRELESS: Enables the control of Remote Commander. CONTROL S: Enables the control of the remote control unit DSRM-10 (not supplied) connected to CONTROL S IN jack. (Remote Commander is disabled.)</p> <p>Notes</p> <ul style="list-style-type: none"> The unit accepts signals from any Sony Remote Commander whose command mode is set to VTR4, not only the supplied one. To disable the control from any Remote Commander, set this item to CONTROL S. You can use the DSRM-20 (no longer manufactured: not supplied). 																																										

(Continued)

Operating the Menus

Icon/Menu	Submenu	Setting
OTHERS	PB YNR	<p>Selects the noise reduction level for the luminance signals when a tape is played.</p> <p>OFF: No noise reduction LOW : Low noise reduction HIGH : High noise reduction</p> <p>Notes</p> <ul style="list-style-type: none"> • When you use noise reduction, there may be an afterimage depending on the condition of the picture. • Noise reduction is also available with pictures output from i HDV/DV jack. Use caution when dubbing and editing a picture in HDV/DV.
	PB CNR	<p>Selects the noise reduction level for the chrominance signals when a tape is played.</p> <p>OFF: No noise reduction LOW : Low noise reduction HIGH : High noise reduction</p> <p>Notes</p> <ul style="list-style-type: none"> • When you use noise reduction, there may be an afterimage depending on the condition of the picture. • Noise reduction is also available with pictures output from i HDV/DV jack. Use caution when dubbing and editing a picture in HDV/DV.
	BEEP	<p>Selects whether or not the unit beeps.</p> <p>ON: Enables the beep. OFF : Disables the beep.</p>
	CLOCK SET	<p>1 Press \uparrow/\downarrow buttons to adjust the number, then press \leftarrow/\rightarrow buttons to set the month, day, hour, and minute.</p> <p>2 Press EXEC button to execute.</p> <p>Notes</p> <ul style="list-style-type: none"> • 12:00 AM stands for midnight and 12:00 stands for noon when [TIME DISPLAY] is set to [12H]. • If you do not use the unit for 3 months or more, the built-in rechargeable battery will become completely discharged, and the settings of the day and the time may be cleared from the memory. In this case, charge the built-in rechargeable battery and set the clock again (page 92).
	HOURS METER (page 92)	<p>Displays the accumulated time counts (by the digital hours meter) in units of 10 hours or 10 counts.</p> <p>OPERATION : Power on duration DRUM RUN: Drum rotation duration TAPE RUN: Tape run duration THREADING: Tape unthreading count</p>
	AC ON MODE	<p>Switches the state into which the unit goes when the unit is connected to the AC outlet.</p> <p>STANDBY: Makes the unit go into the standby mode. ON: Turns the unit on.</p>
	AUTO STANDBY	<p>Selects whether the unit goes into the standby mode or not, if the unit has been in the stop mode and no key operations have been attempted for more than one hour.</p> <p>OFF: Leaves the unit in the stop mode. ON: Makes the unit go into the standby mode.</p>

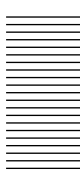

Icon/Menu	Submenu	Setting
OTHERS	60i/50i SEL <i>(page 45)</i>	Switches to 1080/60i (NTSC) or 1080/50i (PAL). 1 Press \uparrow/\downarrow buttons to select [YES], then press EXEC button. <div data-bbox="842 366 1118 521" style="border: 1px solid black; padding: 5px; margin: 10px auto; width: fit-content;">60i/50i SEL Change to 50i? Reboots after change. ----- YES NO</div> 2 Press \uparrow/\downarrow buttons to select [YES] again, then press EXEC button.
	INITIALIZE	Resets the menu to preset settings except CLOCK SET. 1 Press \uparrow/\downarrow buttons to select [YES], and then press EXEC button. <div data-bbox="842 676 1118 832" style="border: 1px solid black; padding: 5px; margin: 10px auto; width: fit-content;">INITIALIZE Reset all settings except "CLOCK SET" to defaults. ----- YES NO</div> 2 Press \uparrow/\downarrow buttons to select [YES] again , then press EXEC button.

Maintenance

Troubleshooting

Please check the following before contacting your Sony dealer.

General Operation Troubles

Symptom	Cause/Remedy
A menu item is not available.	<ul style="list-style-type: none"> The KEY INH switch is set to ON. → First, set the switch to OFF, then adjust the menu. There are menus that cannot be used depending in [IN/OUT REC] menu setting. → Change [IN/OUT REC] menu settings (page 67). Some menu items are only available in EE mode or playback mode. → Set the unit to EE mode or playback mode. Some menu items are only available when the tape is inactive. There are some menus you cannot use without setting the clock.
Some menu item settings change accidentally.	<ul style="list-style-type: none"> You have pulled out the power cord during a menu operation or LCD monitor brightness adjustment. → Adjust the menu again. To prevent this incident recurring, do not pull out the plug while adjusting the menu or the brightness of LCD monitor.
The unit operates by itself.	<ul style="list-style-type: none"> [COMMANDER] in [OTHERS] menu is set to WIRELESS and a Sony Remote Commander whose command mode is set to VTR4 is operated near the unit. → Set [COMMANDER] to [CONTROL S]. When TIMER switch is set to REPEAT and [START TIME] of [CUSTOM REPEAT] in [VTR SET] menu is set to [ON], the unit starts to repeat playbacks at the start time you have set. → Set TIMER switch to OFF, or turn [START TIME] to [OFF].
The supplied wireless Remote Commander does not work.	→ Set [COMMANDER] in [OTHER] menu to [WIRELESS].
Even though the settings on the unit are correct, you cannot make the unit record using the Remote Control Unit DSRM-10 (not supplied).	→ On the Remote Control Unit DSRM-10, press PLAY button while holding REC button down.
Even though KEY INH switch is set to ON, the unit responds to operations input using Remote Commander.	• Setting KEY INH switch to ON does not disable Remote Commander. To disable the control of the Remote Commander, set [COMMANDER] in [OTHERS] menu to [CONTROL S].

Symptom	Cause/Remedy
Whenever you connect the unit to an AC outlet, the unit turns on automatically.	<ul style="list-style-type: none"> • [AC ON MODE] in [OTHERS] menu is set to [ON]. → Set [AC ON MODE] to [STANDBY]. • There is a cassette inside the unit and TIMER switch is set to REPEAT or REC. → Set TIMER switch to OFF.
No picture on LCD monitor.	<ul style="list-style-type: none"> • [LCD BLACK] in [DISPLAY SET] menu is set to [ON]. → Set it to [OFF]. • With an analog connection, the current setting of [60i/50i SEL] in [OTHERS] menu is not appropriate. → Set it to the appropriate position for the device you are using.

Power sources

Symptom	Cause/Remedy
The power cannot be turned on.	<ul style="list-style-type: none"> • AC power cord is disconnected. → Connect the AC power cord. • KEY INH switch is set to ON. → Set the switch to OFF.
The unit will not operate even if the power has been turned on.	<ul style="list-style-type: none"> • KEY INH switch is set to ON. → Set the switch to OFF. • Moisture condensation has occurred (<i>page 91</i>). • The cassette is not inserted straight. → Eject and reinsert it straight. → Disconnect the power supply and then reconnect it after about 1 minute. If the unit does not operate even after you reconnect the power, use a sharp-tipped ballpoint pen or similar tool to press RESET button. When you press RESET button, all settings including the date, time, and 60i/50i are initialized.

Cassette tapes

Symptom	Cause/Remedy
The cassette cannot be inserted.	<ul style="list-style-type: none"> • There is moisture condensation on the head drum (<i>page 91</i>). → With the unit powered on, wait more than one hour. • The cassette is not inserted straight. → Eject and reinsert it straight. • Another cassette has been loaded already. → Remove the cassette and insert the one you want to load.
It takes time to eject the cassette.	<ul style="list-style-type: none"> • This is not a malfunction. → The unit ejects the cassette slowly to protect the tape. While the cassette is being ejected,  (cassette) indicator blinks.
A cassette tape cannot be removed.	→ Check whether the power supply is connected properly.
The cassette tape is not ejected when you press EJECT button.	<ul style="list-style-type: none"> • Moisture condensation has occurred in the unit (<i>page 91</i>).

(Continued)

Troubleshooting

Symptom	Cause/Remedy
The cassette memory data and title are not displayed when using a cassette tape with the cassette memory function.	<ul style="list-style-type: none"> The unit does not support the cassette memory function and therefore such data is not displayed.
The remaining tape time is not displayed.	→ To always display the remaining tape time, set [REMAINING] in [DISPLAY SET] menu to [ON].

Output/Playback

Symptom	Cause/Remedy
Cannot playback.	→ If a tape has reached its end, rewind the tape.
Cannot playback in reverse at various speeds.	<ul style="list-style-type: none"> The unit cannot play back a tape recorded in HDV format in the reverse direction at various speeds (<i>page 37</i>).
Horizontal lines are displayed on an image. An image has block noise. An image is blurred or not displayed.	<ul style="list-style-type: none"> The video heads are dirty. → Clean the video heads using the supplied cleaning cassette. A damaged tape is loaded. → Remove the cassette and insert another one. You have tried to make the unit play back a tape recorded in LP mode of DV format. → The unit can play back only tapes recorded in HDV, DVCAM format or in SP mode of DV format. A tape recorded in LP mode of DV format cannot be played back on the unit.
No picture is output via i.LINK HDV/DV jack.	<ul style="list-style-type: none"> → Reconnect the i.LINK cable (not supplied). INPUT SELECT switch is set to a position other than HDV/DV. → Set the switch to HDV/DV.
EE picture and EE sound are not output.	<ul style="list-style-type: none"> [EE/PB SEL] in [IN/OUT REC] menu is set to [PB]. → Set [EE/PB SEL] to [EE]. The setting of INPUT SELECT switch does not match the signal input. → Set the switch according to the signal input.
The audio breaks up.	<ul style="list-style-type: none"> A damaged tape is loaded. → Remove the cassette and insert another one. The video heads are dirty. → Clean the video heads using the supplied cleaning cassette. You have tried to make the unit play back a tape recorded in LP mode of DV format. → The unit can play back only tapes recorded in HDV, DVCAM or DV (SP) format. A tape recorded in LP mode of DV format cannot be played back on the unit.
Duplication does not function.	<ul style="list-style-type: none"> Check the STOP/CAUTION No. and the warning messages displayed on LCD monitor. Take the appropriate action (<i>See page 59</i>).
Cannot perform a date search and index search.	<ul style="list-style-type: none"> There is a portion with no recording at the beginning or in the middle of a tape. This is not a malfunction.
The time code is not reset to "00:00:00:00" after rewinding a tape to the recording starting point.	<ul style="list-style-type: none"> The time code is not displayed correctly at the starting point of recording. This condition, however, is not a malfunction. When you restart playback, the time code and images are displayed correctly from the starting point.

Symptom	Cause/Remedy
A user bit is not displayed correctly during fast-forward/rewind.	<ul style="list-style-type: none"> When input video signals without a user bit are recorded while HDV is input to i.LINK, the user bit is not displayed correctly. Either “— — — —” or “00 00 00 00” is displayed during playback and fast-forward/rewind, respectively.
“— — — —” appears on the date display (page 36).	<ul style="list-style-type: none"> The tape has been played back without setting the date and time. <ul style="list-style-type: none"> → Set the date and time. The tape portion being played back has no recording. If there is a scratch or noise on the tape, the data code cannot be read.
Although the HDMI cable or component video cable is connected properly to a television set or monitor to play back a tape, no image or audio is output.	<ul style="list-style-type: none"> → Use the correct setting for [HDMI/CMPNT] in [VIDEO OUT] in [IN/OUT REC] menu in accordance with the equipment to be connected. No audio is output from COMPONENT OUT jacks. <ul style="list-style-type: none"> → Connect also an audio cable.
When you connect the unit to a 4:3 television set, the displayed image appears flattened.	<ul style="list-style-type: none"> → When you output from HDMI OUT jack and COMPONENT OUT jacks, set [HDMI/CMPNT] and [DOWN CONVERT] of [VIDEO OUT] in [IN/OUT REC] menu correctly before play back. <ul style="list-style-type: none"> When you output from i.LINK jack, set [HDV → DV CONV] and [DOWN CONVERT] of [i.LINK SET] in [IN/OUT REC] menu correctly before play back. When you output from S VIDEO jack and VIDEO jack, set [DOWN CONVERT] of [VIDEO OUT] in [IN/OUT REC] menu correctly before play back. → DVCAM/DV tape images recorded in the wide mode are not displayed properly. Use a widescreen-compatible monitor.
Even though [HDV/DV IN TC] in [TC/UB SET] menu is set to [EXTERNAL], the time code of the input i.LINK signal is not recorded.	<ul style="list-style-type: none"> The i.LINK signal output from the digital non-linear editing controller does not include a time code. <ul style="list-style-type: none"> → Confirm that the editing software you are using is capable of outputting a time code. INPUT SELECT switch is not set to HDV/DV. <ul style="list-style-type: none"> → Set it to HDV/DV.
After playing at 1/10 of normal speed in forward or reverse for more than 1 minute, normal playback forward starts.	<ul style="list-style-type: none"> To protect a tape, the unit is set to start normal playback after playing at 1/10 of normal speed in forward or reverse for more than 1 minute. <ul style="list-style-type: none"> → Play back the tape at 1/3 of normal speed in forward or reverse.
Playback pause mode is released and the unit goes into the stop mode.	<ul style="list-style-type: none"> To protect the tape, the unit is set to go into the stop mode after the playback pause mode continues for a certain period. <ul style="list-style-type: none"> → Set [FROM STILL] in [VTR SET] menu to [STEP FORWARD]. If you do so, the tape will forward by one frame for each time interval set in [STILL TIME].
Playback pause mode is released and the tape forwards for each preset time interval.	<ul style="list-style-type: none"> To protect the tape, the unit is set to forward the tape after the playback pause mode continues for a certain period. <ul style="list-style-type: none"> → Set [FROM STILL] in [VTR SET] menu to [STOP]. If you do so, the unit goes into the stop mode after the playback pause mode continues for the interval set in [STILL TIME].
After the unit has been left in the stop mode and no key operations have been attempted for more than one hour, the unit goes into the standby mode (the unit's power turns off).	<ul style="list-style-type: none"> [AUTO STANDBY] in [OTHERS] menu is set to [ON]. <ul style="list-style-type: none"> → Set [AUTO STANDBY] to [OFF].
The pause mode of playback, recording, or audio dubbing is released automatically.	<ul style="list-style-type: none"> To protect the tape and the video heads, the unit goes into the stop mode after the pause mode of recording, audio dubbing, or duplicating continues for more than 3 minutes. <ul style="list-style-type: none"> → To maintain the pause mode, set [FROM REC P] in [VTR SET] menu to [REC PAUSE].

(Continued)

Troubleshooting

Symptom	Cause/Remedy
When the tape is rewound to its beginning, the playback automatically starts.	<ul style="list-style-type: none"> • TIMER switch is set to REPEAT. → Set TIMER switch to OFF. • You pressed PLAY button while holding REW button down. → If you do this, the unit rewinds the tape to its beginning and begins playback (See page 15).
During playback, the unit starts rewinding suddenly.	<ul style="list-style-type: none"> • TIMER switch is set to REPEAT. → When TIMER switch is set to REPEAT, the unit starts rewinding at the moment when a signal for index search or a blank portion is detected. Set TIMER switch to OFF.
When the tape reaches its end, rewinding starts automatically.	<ul style="list-style-type: none"> • TIMER switch is set to REPEAT. → When TIMER switch is set to REPEAT, the unit starts rewinding at the moment when the end of the tape is detected. Set TIMER switch to OFF.
The unit does not function as part of a digital non-linear editing system.	<ul style="list-style-type: none"> • INPUT SELECT switch is set to a setting other than HDV/DV. → Set it to HDV/DV. • The editing controller or the editing software is not compatible with the unit. → Refer to the instruction manuals of the controller or the software and consult their manufacturers.
Although the i.LINK cable is connected, the image from an external equipment is not displayed.	<ul style="list-style-type: none"> → Disconnect and then reconnect the i.LINK cable correctly. • INPUT SELECT switch is set to a setting other than HDV/DV. → Set it to HDV/DV.
No image is displayed even though the video cable is connected correctly.	<ul style="list-style-type: none"> • There are output restrictions for some [HDMI/CMPNT] settings of [VIDEO OUT] in [IN/OUT REC] menu. For details, see page 68. • INPUT SELECT switch setting does not match the cable connected to the unit. → Set INPUT SELECT switch to S VIDEO or VIDEO to match the cable connection.
The image loses color or is distorted when you play back the tape on a television set or monitor connected to the unit.	<ul style="list-style-type: none"> → Connect the unit to a television set or monitor that is compatible with its [60i/50i SEL] format. → Set [60i/50i SEL] in [OTHERS] menu, according to the signal-format (page 79).
2/2-ST is displayed on the screen.	<ul style="list-style-type: none"> • This icon is displayed when you playback a tape recorded with 4-channel microphone recording on another device. This unit does not support 4-channel microphone recording. (The icon is displayed when you play back a tape recorded with 4-channel microphone in DVCAM or DV (SP) format. However, it is not displayed during playback of a tape recorded with 4-channel microphone in HDV format.)

Symptom	Cause/Remedy																												
The output from S VIDEO OUT jack and VIDEO OUT jack is different from [DOWN CONVERT] setting of [VIDEO OUT] in [IN/OUT REC].	<p>The output from S VIDEO jack and VIDEO jack is set as follows.</p> <ul style="list-style-type: none"> When the playback format is set shown below, the output from S VIDEO jack or VIDEO jack is fixed in EDGE CROP. <table border="1"> <thead> <tr> <th colspan="2">Menu item</th> <th>Setting</th> </tr> </thead> <tbody> <tr> <td colspan="2">Playback format</td> <td>HDV (HDV1080i)</td> </tr> <tr> <td rowspan="2">[VIDEO OUT] in [IN/OUT REC]</td> <td>[DOWN CONVERT]</td> <td>SQUEEZE or LETTER BOX</td> </tr> <tr> <td>[HDMI/CMPNT]</td> <td>480p/480i, 576p/576i</td> </tr> <tr> <td rowspan="2">[i.LINK SET] in [IN/OUT REC]</td> <td>[HDV → DV CONV]</td> <td>DVCAM or DV SP</td> </tr> <tr> <td>[DOWN CONVERT]</td> <td>Set to EDGE CROP</td> </tr> </tbody> </table> <ul style="list-style-type: none"> When the playback format is set shown below, the output from S VIDEO jack or VIDEO jack is fixed in LETTER BOX. <table border="1"> <thead> <tr> <th colspan="2">Menu item</th> <th>Setting</th> </tr> </thead> <tbody> <tr> <td colspan="2">Playback format</td> <td>HDV (HDV1080i or HDV720p)</td> </tr> <tr> <td>[VIDEO OUT] in [IN/OUT REC]</td> <td>[HDMI/CMPNT]</td> <td>480i, 576i, 480p/480i, 576p/576i</td> </tr> <tr> <td colspan="2">[ALLSCAN MODE] in [DISPLAY SET]</td> <td>ON</td> </tr> </tbody> </table>	Menu item		Setting	Playback format		HDV (HDV1080i)	[VIDEO OUT] in [IN/OUT REC]	[DOWN CONVERT]	SQUEEZE or LETTER BOX	[HDMI/CMPNT]	480p/480i, 576p/576i	[i.LINK SET] in [IN/OUT REC]	[HDV → DV CONV]	DVCAM or DV SP	[DOWN CONVERT]	Set to EDGE CROP	Menu item		Setting	Playback format		HDV (HDV1080i or HDV720p)	[VIDEO OUT] in [IN/OUT REC]	[HDMI/CMPNT]	480i, 576i, 480p/480i, 576p/576i	[ALLSCAN MODE] in [DISPLAY SET]		ON
Menu item		Setting																											
Playback format		HDV (HDV1080i)																											
[VIDEO OUT] in [IN/OUT REC]	[DOWN CONVERT]	SQUEEZE or LETTER BOX																											
	[HDMI/CMPNT]	480p/480i, 576p/576i																											
[i.LINK SET] in [IN/OUT REC]	[HDV → DV CONV]	DVCAM or DV SP																											
	[DOWN CONVERT]	Set to EDGE CROP																											
Menu item		Setting																											
Playback format		HDV (HDV1080i or HDV720p)																											
[VIDEO OUT] in [IN/OUT REC]	[HDMI/CMPNT]	480i, 576i, 480p/480i, 576p/576i																											
[ALLSCAN MODE] in [DISPLAY SET]		ON																											

Recording/Dubbing

Symptom	Cause/Remedy
Whenever you connect the unit to an AC outlet, the unit automatically starts recording.	<ul style="list-style-type: none"> TIMER switch is set to REC. → When TIMER switch is set to REC, the unit starts recording whenever the power is connected. Set TIMER switch to OFF.
Even though KEY INH switch is set to ON, the unit starts recording/playback by itself.	<ul style="list-style-type: none"> TIMER switch is set to REPEAT or REC. → TIMER switch setting has a higher priority than KEY INH switch setting. Set TIMER switch to OFF. When [COMMANDER] in [OTHERS] menu is set to [WIRELESS], the unit responds to signals from Remote Commander even though KEY INH switch is set to ON. → Set [COMMANDER] to [CONTROL S].
No picture is output via  HDV/DV jack.	<ul style="list-style-type: none"> → Reconnect the i.LINK cable (not supplied). INPUT SELECT switch is set to a position other than HDV/DV. → Set the switch to HDV/DV. → Set [HDV/DV SEL] in [IN/OUT REC] menu correctly.

(Continued)



Troubleshooting

Symptom	Cause/Remedy
<p>When you set AUDIO INPUT LEVEL switch:</p> <ul style="list-style-type: none"> You do not know how to adjust the input level. The recorded level is too low. The recorded sound is distorted. 	<p>Confirm the level of the sound output from the player by referring to the player's instruction manual. According to that output level, set AUDIO INPUT LEVEL switch on the rear panel of the unit so as to obtain an optimum level.</p> <p>If you are not clear about the player's output level, try the following procedures.</p> <ol style="list-style-type: none"> Specify the output level by types of audio output connectors available on the player. <ul style="list-style-type: none"> If the player is equipped with phono jacks: -10. If the player is equipped with XLR connectors: +4 or -2. Set AUDIO INPUT switch on the front panel to AUTO and play back the tape which you intend to use for playback. When the playback audio level is at its maximum, if the audio levels meters exceed 0 dB, set AUDIO INPUT LEVEL switch to the lower step (+4). Either, set AUDIO INPUT switch to MANU and turn AUDIO REC LEVEL control knobs to adjust the recording level. The recorded sound at the portion where the meters exceed 0 dB will be distorted.
<p>Audio dubbing cannot be done. Audio dubbing is interrupted.</p>	<ul style="list-style-type: none"> You are trying to dub the sound onto an HDV or DV-formatted tape. <ul style="list-style-type: none"> Sounds can be dubbed only onto a DVCAM-formatted tape (recorded) in the 32 kHz audio mode (4-channel). If the unit detects the following, audio dubbing will automatically abort, an alarm message will be superimposed on LCD monitor and on an external monitor. <ul style="list-style-type: none"> A blank portion A section recorded in other than 32 kHz audio mode (4-channel) A portion recorded in other than DVCAM format You have tried to dub the sound onto channels 1/2. <ul style="list-style-type: none"> Only channels 3/4 can be used for dubbing. You cannot dub the sound onto channels 1/2.
<p>No sound or undesired sound is output from HDMI OUT jack, AUDIO OUT jacks, or PHONE jack.</p>	<ul style="list-style-type: none"> When the audio mode is set to 32 kHz (4-channel), you can select the audio channel to output the sound using the AUDIO OUTPUT SELECT selector on the front panel. Check the setting of [AUDIO MONI] in [AUDIO SET] menu.
<p>Cannot hear CH3 and CH4 audio.</p>	<p>→ Set AUDIO OUTPUT SELECT switch to MIX or CH-3/4.</p>
<p>If an i.LINK cable is connected when you edit the dubbing, the monitor does not display any image.</p>	<p>→ Use the correct setting for [HDV/DV SEL] in [IN/OUT REC] menu in accordance with the equipment to be connected.</p>
<p>The unit does not function as part of a digital non-linear editing system. The functions on the unit do not operate.</p>	<ul style="list-style-type: none"> The INPUT SELECT switch is set to a setting other than HDV/DV. <ul style="list-style-type: none"> Set it to HDV/DV. The editing controller or the editing software is not compatible with the unit. <ul style="list-style-type: none"> Refer to the instruction manuals of the controller or the software and consult their manufacturers.

Warning indicators and messages

Self-diagnosis display/Warning Indicators

The following alarm indicators may appear on LCD monitor or an external monitor. For further information about each symptom and recovery method, see the relevant page indicated in the parentheses.







Message/Alarm Indicator	Cause/Corrective Action
C:□□:□□/E:□□:□□ (Self-diagnosis display)	<p>If an error still recurs after you retry the corrective actions several times, contact Sony Customer Service or your place of purchase.</p> <p>C:21:□□ → Condensation has occurred. Remove the cassette and insert it again after approximately 1 hour (<i>page 91</i>).</p> <p>C:22:□□ → The video head is dirty. Use a cleaning cassette to clean the head (<i>page 89</i>).</p> <p>C:31:□□/C:32:□□ → Symptoms other than the above are occurring. Insert a cassette again and retry the operation. Do not take this action, however, if there is negligible condensation in the unit (<i>page 91</i>). → Unplug the power cord, plug it in again, and then retry the operation. → Replace the tape.</p>
 (Moisture condensation warning)*	→ Remove the cassette, unplug the power cord, and leave the unit for approximately 1 hour (<i>page 91</i>).
 (Warning indicator pertaining to the tape)	<p>The icon blinks slowly.</p> <ul style="list-style-type: none"> The remaining tape time is less than 5 minutes.
 (Eject cassette warning)*	<p>The icon blinks rapidly.</p> <ul style="list-style-type: none"> Condensation has occurred (<i>page 91</i>). The self-diagnostics message is displayed (<i>page 87</i>).

* An alarm beep will be emitted when an alarm indicator or message is displayed (*page 78*).

Warning indicators and messages

Alarm Messages

The following alarm messages will appear together with the alarm indicators. Take corrective action according to the displayed message.

Item	Message	Cause/Corrective Action
Moisture condensation	 ▲ Moisture condensation. Eject the cassette.	→ See page 91 for details.
	 Moisture condensation. Turn off for 1H.	→ See page 91 for details.
Cassette/Tape	 Insert a cassette.	→ See page 31.
	▲ Reinsert the cassette.	• Check for damage on a tape or other irregularities.
	 ▲ The tape is locked -check the tab.	→ See page 30.
	 The tape has reached the end.	—
Audio dubbing	Cannot add audio. INPUT SELECT is set to HDV/DV	—
	Not recorded in DVCAM mode. Cannot add audio.	—
	Cannot add audio.	• You cannot add audio unless the recorded audio format is 32 kHz (4-channel, 12 bit). Make sure that [60i/50i SEL] in [OTHERS] menu is set correctly..
	Cannot add audio on the blank portion of a tape.	—
	HDV recorded tape. Cannot add audio.	—
	Cannot add audio. "HDV/DV SEL" is set to HDV.	—
Others	Cannot record due to copyright protection.	—
	Change to correct tape format.	• This is an unsupported format and cannot be played back.
	No output image in "HDV/DV SEL". Change format.	Stop playback or signal input, or change [HDV/DV SEL] setting (page 67).
	 Dirty video head. Use a cleaning cassette.	→ See page 89.
	Unplug power cable.	—
	Reinsert the cassette.	—
	Invalid input signal.	The signal that has been input to the unit is invalid. Check the input signal.
	Power voltage error.	—

Notes on the Videocassette Recorder

Do not use the unit in a place subject to direct sunlight or heat sources

If you do, its cabinet, mechanical parts, etc., may be damaged.

Do not place the unit in humid places

Do not place the unit in places where they may be exposed to water-splash or to humidity. Do not place water-filled containers or vases on the unit. Doing so may cause the unit malfunction.

Do not use the unit in an extremely hot place

If the unit is left in a car parked with the windows closed (especially in summer), its cabinet, mechanical parts, etc., may be damaged or it may not work correctly.

If the unit is brought directly from a cold to a warm location

Moisture may condense inside the unit and cause damage to the video heads and tape. If you use the unit in a place subject to direct cold currents from an air conditioner, moisture may also condense inside the unit.

Do not place a heavy object on the unit

The cabinet, mechanical parts, etc., may be damaged, or the unit may not work correctly.

Do not handle the unit roughly

Avoid rough handling or mechanical shock to the unit.

To avoid damaging the cabinet's finish

Plastic is often used for the surface finishing of the unit. Do not spray a volatile solvent such as an insecticide toward the cabinet or place rubber or vinyl products on the cabinet for a long time. If you do, the finish of the cabinet may be damaged or the coating may come off.

Do not clean the cabinet with thinner or benzine

The cabinet may be damaged or its coating may come off. When you use a chemical-impregnated cloth, use it according to its directions.

Clean the cabinet with a soft dry cloth

When the cabinet is very dirty, clean it with a soft dry cloth lightly moistened with a mild detergent solution and finish it with a dry cloth.

Do not put magnetic objects close to the unit

Magnetic fields may damage the recording.

To prevent electromagnetic interference caused by radio communication equipment such as cellular phones, transceivers, etc.

The use of the radio communication equipment such as cellular phones or transceivers near the unit may cause a malfunction and can affect the audio/video signals. Cellular phones or transceivers near the unit should be switched off.

Do not use the unit in an area exposed to radiation

A malfunction may occur.

Checking the video heads every 1000 hours

A VCR is a high-precision piece of equipment that records and plays back the picture recorded on a magnetic tape. In particular, the video heads and other mechanical parts may become dirty or worn. To maintain a clean picture, we recommend maintenance every 1000 hours, even though the conditions of use may differ depending on temperature, humidity, dust, etc.

About connecting other equipment

When you connect the unit to another equipment or a computer using an i.LINK cable, confirm the direction of the jack. If you forcibly insert the jack, the terminal may be damaged or cause the unit to malfunction.

Cleaning of the Video Heads

With clogged video heads, the unit cannot record properly. Clean the video heads to prevent noise on the recorded picture or audio. For cleaning, use the supplied cleaning cassette.

Before recording an important event

The unit cannot record properly with the clogged video heads. To ensure normal recording and clear pictures and sound, clean the video heads before recording an important event.

(Continued)

Notes on Use

Every 50 hours



If you repeat the tape transport operation, the video heads will become dirty and coated with fine dirt or dust. Clean the heads every 50 hours.

After using a tape prone to clog the heads

After using such a tape causes the symptoms illustrated below, clean the heads.

When the symptoms caused by clogged video heads appear

Even if you clean the heads periodically, clogging of the heads may occur anyway. Clean the heads when:

- mosaic-pattern noise appears on the playback picture.
- the playback picture freezes.
- a part of the playback picture does not move.
- playback pictures do not appear.
- playback audio is interrupted.
- “  Dirty video head. Use a cleaning cassette.” appears during recording.

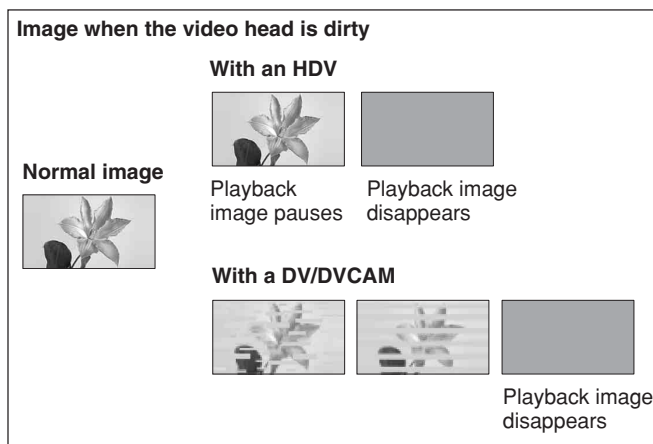

To use the cleaning cassette

Clean the video head by playing the cleaning cassette for ten seconds.

- * If the playback image continues to be stationary or any of the symptoms on the above remain even after cleaning with the cleaning cassette, there may be a problem with the tape. Avoid using that tape.

For details, refer to your cleaning cassette's instruction manual.

Note

Using the unit as below will make the video head dirty.

- Subjecting the unit to temperature change or high humidity.

→ Condensation occurs. See page 91.

- Using a damaged tape.
- Using the unit for a long time.
- Using the unit where there is a lot of dirt, dust, or sand.
- Leaving a tape in the unit for a long time.

Cleaning cassettes are replaceable. After using the supplied cleaning cassette for the specified number of times, buy a cleaning cassette for replacement.

After prolonged use, the video heads may become worn out. If optimum picture quality is not restored even after you have cleaned the video heads with the cleaning cassette, the video heads may have worn out. In that case, you have to replace the video heads with new ones. Please consult your Sony dealer.

Notes on the Video Cassettes

Note that using a tape such as those below can damage the unit.

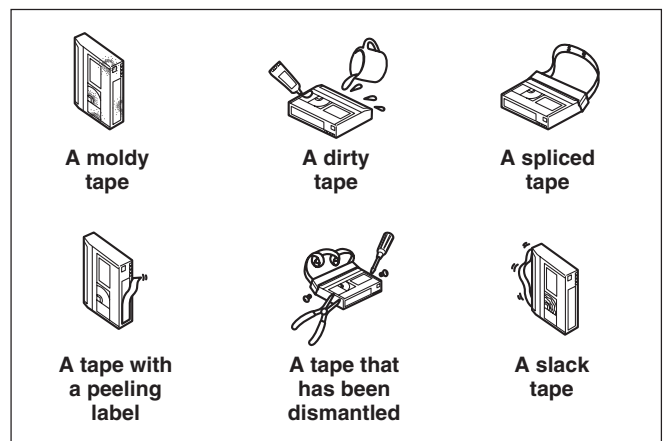

Using cassettes

- When using a cassette for the first time we recommend that you run the tape for about five seconds before recording.
- When using a cassette that has been stored for a long time we recommend that you fast-forward and rewind it for some time. This will correct any winding irregularity in the cassette.
- Do not repeatedly insert and remove a cassette without running it. The tape may become slacked or damaged.

Cleaning the terminal

If the gold-plated terminals of a cassette become dirty, or dirt accumulates on the terminals, the correct remaining tape time may not be displayed.

Clean the terminal with a swab once every ten times you eject a cassette.

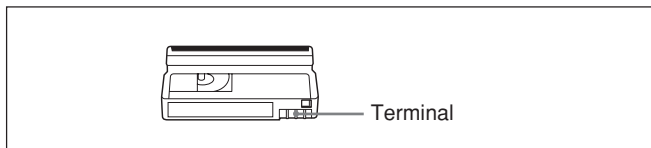

When affixing a label to the cassette

Be sure to affix a label only on the correct location so as not to cause malfunction of the unit.

Storing cassettes

- After using the tape rewind it, put it in its case and store vertically. (To prevent picture and sound distortion.)
- Do not store tapes in the following places:
 - Where the temperature gets high (in strong sunshine, inside a car or near a heater)
 - Where there is high humidity
 - In a strong magnetic field (near a TV or speakers)

Notes on LCD Screen

LCD screen is manufactured using high-precision technology. The ratio of effective pixels is 99.99% or more. However, there may be some tiny black points and/or bright points (red, blue, green or white) that constantly appear on LCD screen. These points do not affect the recorded picture in any way.

Do not place the unit with LCD screen pointing toward the sun. Otherwise, the unit may be damaged.

To clean LCD screen

To remove dirt or to clean fingerprints from LCD screen, use an LCD cleaning kit (not supplied). When you use the LCD cleaning kit, do not pour the cleaning liquid directly on LCD. Always soak the liquid in cleaning paper and wipe LCD with this paper.

About Moisture Condensation

If the unit or cassette is brought directly from a cold to a warm location, moisture may condense inside or outside the unit or tape. If you use the tape or video heads in this condition, the tape may adhere to the head drum, and the video heads or the tape may be damaged, or a malfunction may occur.

When condensation occurs, the alarm messages “☒ ▲ Moisture condensation. Eject the cassette” or “☒ Moisture condensation. Turn off for 1H.” appears. Moisture condensation is likely to occur under the following conditions:

- The unit or cassette is brought from the cold outdoors to a warm indoor location.
- The unit or cassette is brought from the air-conditioned indoors to the hot outdoors.
- The unit is used in a place subject to cold currents from an air conditioner.

When bringing the unit or cassette from a cold place to a warm place or vice versa, put it in a plastic bag and seal the bag tightly. After bringing it into the new place, leave the bag on for more than one hour, and remove the bag when the air temperature inside it has reached the temperature surrounding it.

If moisture condensation occurred

Remove the cassette immediately. While the alarm indicator is displayed, you cannot operate the unit except to press EJECT button.

Turn off the power until the condensation disappears (approximately 1 hour). If the alarm message does not appear when you turn on the unit, and if ☒ or ▲ does not blink when you insert a cassette and press the video operation button, you can use the unit again. If there is negligible condensation in the unit, this condensation may not be detected. In that case, the cassette may not be ejected for approximately 10 seconds. This is not a malfunction.

Digital Hours Meter

The digital hours meter keeps cumulative counts of the total operation time, the head drum rotation time, the tape running time and the number of unthreading operations. These counts can be displayed on the menu. Use them as guidelines for scheduling maintenance.

In general, consult your Sony dealer about necessary periodic maintenance checks.

The digital hours meter has the following four display modes and you can check them in [HOURS METER] of [OTHERS] menu (*page 78*).

- **OPERATION mode**

The cumulative total hours of operating time is displayed in 10-hour increments.

- **DRUM RUN mode**

The cumulative total hours of drum rotation with tape threaded is displayed in 10-hour increments.

- **TAPE RUN mode**

The cumulative total hours of tape running time is displayed in 10-hour increments.

- **THREADING mode**

The cumulative number of tape unthreading operations is displayed in 10-operation increments.

Notes on the License

ANY USE OF THIS PRODUCT OTHER THAN CONSUMER PERSONAL USE IN ANY MANNER THAT COMPLIES WITH THE MPEG-2 STANDARD FOR ENCODING VIDEO INFORMATION FOR PACKAGED MEDIA IS EXPRESSLY PROHIBITED WITHOUT A LICENSE UNDER APPLICABLE PATENTS IN THE MPEG-2 PATENT PORTFOLIO, WHICH LICENSE IS AVAILABLE FROM MPEG LA, L.L.C., 250 STEELE STREET, SUITE 300, DENVER, COLORADO 80206.

About the Built-in Rechargeable Battery

The unit is provided with a rechargeable battery that retains the date/time and various settings regardless of power-on and power-off. The rechargeable battery is charged as long as the unit is operated. If the period of operating the unit is short, the battery discharges gradually and if it is not used at all for approximately 3 months, the battery will discharge completely. If that case, charge the battery and then start using the unit. If you do not need to record the date and time when the rechargeable battery is not fully charged, you can use the unit in this state.

Charging the rechargeable battery

Connect the unit to an AC output using the power cord for about 24 hours. (The unit does not need to be turned on.)

Appendix

Compatibility of HDV, DVCAM, and DV Formats

HDV format is an HD VCR format based on DV format of the globally widespread general consumer digital VCR system. This format has the newly defined data recording specifications for HD signals compressed by MPEG2. It applies the same cassette, tape speed, and track pitch as DV format.

The differences, compatibility, and restrictions in editing of HDV1080i, DVCAM, and DV formats are explained below.

Main differences between HDV1080i, DVCAM, and DV Formats

(The unit and other equipment for professional use may be functionally extended. For details, see the notes below the table.)

Specification	HDV1080i	DVCAM	DV (SP)
Track pitch	10 μm	15 μm	10 μm
Audio sampling frequency	16 bit: 48 kHz	12 bit: 32 kHz 16 bit: 48 kHz	12 bit: 32 kHz 16 bit: 32 kHz, 44.1 kHz, 48 kHz ²⁾
Audio recording mode ¹⁾	Lock mode	Lock mode	Unlock mode ³⁾
Time code	Drop frame mode (60i only) ⁴⁾ No user bits ⁴⁾	NTSC: SMPTE time code (DF/NDF, including user bits) PAL: EBU time code (including user bits)	Drop frame mode (NTSC only) ⁴⁾ No user bits ⁴⁾

- 1) There are two modes for audio signals recording: Lock mode and Unlock mode. In Lock mode, the sampling frequencies of audio and video are synchronized. In Unlock mode, adopted by the consumer DV format, the two sampling frequencies are independent. Lock mode maintains high compatibility with higher formats and offers better digital processing and smooth transition than Unlock mode when you edit audio.
- 2) The unit cannot record in DV format with 16 bit:32 kHz or 44.1 kHz.
- 3) The unit has been functionally extended with a function for switching between Lock mode and Unlock mode.
- 4) The unit has been functionally extended with a function to enable selecting DF/NDF and user bits setting for 60i with HDV or DV (SP) format.

Compatibility of HDV, DVCAM, and DV Formats

Playback compatibility

The compatibility between playback tape format and player is summarized in the table below.

Player Playback tape format	DV format model	DVCAM format model	HDV1080i format model (The unit)
DV	Playback is possible. (Some equipment cannot play a tape recorded in the LP mode.)	Only playback of a tape recorded in SP mode is possible. Some equipment can play a tape recorded in LP mode.	Only playback of a tape recorded in SP mode is possible. Some equipment can play a tape recorded in LP mode. (The unit can play back a DV-formatted tape in SP mode only.)
DVCAM	Playback may be possible on some models.	Playback is possible	Playback is possible
HDV	No playback is possible.	No playback is possible.	Playback is possible*

- * The unit can play back for HDV720/30p format, but you cannot output the video signals from  HDV/DV jack. The unit cannot play back other than HDV1080/60i, HDV1080/50i, such as HDV1080/30F, HDV1080/25F, HDV1080/24F, HDV720/25p, and HDV720/24p format. The unit cannot input/output, record, or play back extended HDV signals. On the unit, you cannot input/output 4-channel audio signals, record or playback in HDV extension.

Cassette compatibility

A DV format cassette tape can be used for HDV. The recording bit rate and recording track pitch on a tape of the HDV1080i system used for HVR-M25U/M25N/M25E/M25P are about 25 Mbps and 10 μ m, respectively. The specifications are the same as that of home use DV (SP) tapes. The recording time on an HDV tape is also the same as that of DV (SP).

The track pitch of DVCAM is 15 μ m, which is 1.5 times of HDV/DV (SP). Therefore, the recording time using DVCAM recording on a same tape will be two-thirds of the time available when HDV/DV (SP) recording is used.

Dubbing with S VIDEO or VIDEO jacks

When you use the unit as a recorder to perform dubbing between the unit and another equipment using S VIDEO jack and VIDEO jack, the format to be used for recording is set in accordance with [📺 REC MODE] setting in [IN/OUT REC] menu.

For details, see the following table.

Playback and editing of a tape may be restricted for some dubbing methods. Read Chapter 4 “Dubbing to another equipment using i.LINK jack, Duplication, Audio Dubbing, and Connecting with a Computer” before dubbing a tape.

Some editing software can correctly edit even a tape created in [LOCK MODE]. In that case, select [LOCK MODE] if required.

Recording tapes used when the unit serves as a recorder

Input signal format	Menu item		Recording tape format (AUDIO MODE)
	📺 REC MODE	AUDIO LOCK	
NTSC or PAL	DVCAM	—	DVCAM (LOCK MODE)
	DV SP	LOCK MODE	DV (LOCK MODE)
		UNLOCK MODE	DV (UNLOCK MODE)

—: Setting independent

Compatibility of HDV, DVCAM, and DV Formats

Dubbing with i HDV/DV jack

When you perform dubbing between the unit and digital video equipment connected with the i.LINK cable using the unit as a player, i HDV/DV jack output format is determined in accordance with the playback tape format and menu setting of the unit.

If you use the unit as a recorder, the format of a tape used for recording is determined in accordance with i HDV/DV jack input format and menu setting of the unit. For details, check the following table on page 97.

Playback and editing using this tape may be limited for some dubbing methods. Before dubbing, read Chapter 4 “Dubbing to another equipment using i.LINK jack, Duplication, Audio Dubbing, and Connecting with a Computer.”

i.LINK output when the unit is used as a player

Playback tape format	Menu item		i.LINK output format (AUDIO MODE)
	HDV/DV SEL	i.LINK SET	
		HDV→DV CONV	
HDV	AUTO	OFF	HDV (LOCK MODE)
		DVCAM	DVCAM (LOCK MODE)
		DV (SP)	DV (UNLOCK MODE)
	HDV	OFF	HDV (LOCK MODE)
		DVCAM	DVCAM (LOCK MODE)
		DV (SP)	DV (UNLOCK MODE)
	DV	—	No output
DVCAM	AUTO	—	DVCAM (Complies with playback tape)
	HDV	—	No output
	DV	—	DVCAM (Complies with playback tape)
DV	AUTO	—	DV (Complies with playback tape)
	HDV	—	No output
	DV	—	DV (Complies with playback tape)

Notes

- When you play back a tape employed with a copy-protection signal on the unit, recording is prevented to record images from the unit to other equipment.
- You cannot up convert DVCAM(DV) format to HDV format on the unit.
- During playback in HDV, if [DV SP] is selected from [HDV→DV CONV] in [i.LINK SET], AUDIO MODE is fixed to UNLOCK MODE.
- When you play back a tape in DVCAM or DV format, the unit cannot convert between DVCAM and DV format, or switch between LOCK MODE and UNLOCK MODE.

Recording tape when the unit is used as a recorder

i.LINK input format	Menu item		Recording tape format (AUDIO MODE) ³⁾
	HDV/DV SEL	 REC MODE ¹⁾	
HDV	AUTO	—	HDV (LOCK MODE)
	HDV	—	HDV (LOCK MODE)
	DV	—	No recording
DVCAM	AUTO	DVCAM	DVCAM (Complies with input signals)
		DV SP	DV (Complies with input signals)
	HDV	—	No recording
	DV	DVCAM	DVCAM (Complies with input signals)
		DV SP	DV (Complies with input signals)
DV	AUTO	DVCAM	DVCAM ²⁾ (Complies with input signals)
		DV SP	DV (Complies with input signals)
	HDV	—	No recording
	DV	DVCAM	DVCAM ²⁾ (Complies with input signals)
		DV SP	DV (Complies with input signals)

- 1) When the unit is used as a recorder, the recording format is determined by [ REC MODE] setting on [IN/OUT REC] menu if the input signal format is DVCAM or DV.
- 2) If you duplicate a tape when the unit is set to DVCAM to be used as a recorder, the time code format of the duplicated tape will be partially different from the time code format specified as DVCAM (note, however, that this does not affect editing accuracy in special cases).
- 3) The unit cannot switch between LOCK MODE and UNLOCK MODE. AUDIO MODE complies with input signals.

Notes

- On the unit, HDV signals input from i.LINK cannot be down converted to DVCAM(DV) for recording.
- If you use the tapes described in 2) above for editing, you may encounter function limitations regardless of the player and recorder formats.
- Some DV video equipment may playback a DVCAM-formatted tape, however the contents cannot be guaranteed. Therefore, even if you use a proper DVCAM-formatted tape for playback, the unit may dub and create a DVCAM-formatted tape. The time code will be partially different from the time code format specified as DVCAM on other DV video equipment.
- You cannot use the unit to record video and audio recorded with copyright protection signals. If you try to record such a video or audio, the message “Cannot record due to copyright protection.” appears on LCD monitor. Pictures output from COMPONENT OUT jacks are switched to either 480i or 576i automatically, regardless of the menu you have set on the unit.

Limitations on editing

During editing, you will encounter limitations according to the format differences on a tape dubbed or edited using  HDV/DV jack.

For details, refer to Chapter 4 “Dubbing to another equipment using i.LINK jack, Duplication, Audio Dubbing, and Connecting with a Computer.”

About i.LINK

The **i** HDV/DV jack provided on the unit is an i.LINK-compliant jack. This section describes the i.LINK standard and its features.

What is i.LINK?

i.LINK is a digital serial interface for sending and receiving digital video, digital audio, and other data between the unit and other equipment equipped with an i.LINK terminal. You can also control other equipment using i.LINK.

i.LINK-compatible equipment can be connected using an i.LINK cable. Possible applications are operations and data exchange with various digital AV equipment. When two or more i.LINK-compatible equipment are connected to the unit, operations and data exchange are possible with equipment directly connected to the unit and also with equipment connected to the unit via other equipment.

Note, however, that the method of operation may vary depending on the characteristics and specifications of the equipment to be connected. Also, there are cases where operations and data exchange may not be possible even if the connection is made.

Notes

- Normally, only one device can be connected to the unit using i.LINK cable. When you connect the unit to HDV/DVCAM (DV)-compliant equipment that allows multiple connections, refer to the operating instructions of the equipment to be connected.
- i.LINK is an easy-to-remember term for the IEEE 1394 proposed by Sony, and is a trademark approved by many corporations in Japan and overseas.
- IEEE 1394 is an international standard standardized by the Institute of Electrical and Electronics Engineers.

About the i.LINK baud rate

The maximum baud rate of i.LINK varies depending on the equipment. There are three types.

S100 (Approximately 100 Mbps*)

S200 (Approximately 200 Mbps)

S400 (Approximately 400 Mbps)

The baud rate is listed under “Specifications” in the operating instructions of individual equipment. It may be indicated near the i.LINK interface on some equipment.

The baud rate may vary from the indicated value when the unit is connected to equipment with a different maximum baud rate.

*What is Mbps?

Mbps stands for “megabits per second,” or the volume of data that can be sent or received in 1 second. For example, a baud rate of 100 Mbps means that 100 megabits of data can be sent in 1 second.

To use i.LINK functions of the unit

For details on how to perform dubbing when the unit is connected to other video equipment that has an i.LINK jack, *see page 44, 54.*

The unit can also be connected to other i.LINK-compatible equipment made by Sony (i.e., a VAIO series computer) as well as video equipment.

The unit may not be able operate with some i.LINK video equipment such as digital televisions, DVD recorders/players, and MICROMV recorders/players even if they are equipped with i.LINK jack. Before connecting to another equipment, confirm whether this equipment is HDV/DVCAM (DV) compatible.

For details on precautions on connections and whether or not software applications compatible with the unit are available, refer to the operating instructions of the equipment to be connected.

Notes

- When you connect with the i.LINK cable to a computer and the unit, check the direction of the jack. If you forcibly insert the jack, the terminal may be damaged or cause the unit to malfunction. Align **▲** mark of the i.LINK cable with **▼** mark on the unit and insert the i.LINK cable.
- Be sure to connect the i.LINK cable to a computer first and then connect it to the unit. If you connect the i.LINK cable to the unit first, it may cause the unit to malfunction because of static electricity.
- When you connect the unit to equipment equipped with a 6-pin type i.LINK jack, connect the cable to the 6-pin type i.LINK jack first.
- When you connect the unit to equipment equipped with an i.LINK jack using the i.LINK cable, power off the equipment and remove the power cord from the AC outlet before connecting (or disconnecting) the i.LINK cable. If the i.LINK cable is connected (or disconnected) while the equipment power cord is connected to the AC outlet, a high-voltage current (8 to 40 V) output from the i.LINK jack of the equipment flows into the unit and damage it.

About required i.LINK cable

Use a Sony i.LINK cable.

i.LINK and **i** are trademarks of Sony Corporation.

Specifications

System

Video/Audio recording/playing head system
Rotating dual-head helical scan

Audio recording format (HDV)
MPEG-1 Audio Layer2
16-bit 48 kHz (stereo)
Transfer rate 384 kbps

Audio recording format (DVCAM (DV))
12-bit Fs32K (Channel 1/2,
Channel 3/4)
16-bit Fs48K (Channel 1/2)

Video signal
1080/60i, NTSC color,
EIA standard system
1080/50i, PAL color,
CCIR standard system

Usable cassettes
Standard DVCAM cassettes with
 mark
Mini DVCAM cassettes with
 mark

Tape speed (HDV)
Approx. 18.812 mm/s

Tape speed (DVCAM)
Approx. 28.218 mm/s

Tape speed (DV) SP: Approx. 18.812 mm/s

Recording/playback time (HDV)
Approx. 276 min
(using PHDV-276DM)
Approx. 63 min
(using PHDVM-63DM)

Recording/playback time (DVCAM)
Approx. 184 min
(using PHDV-276DM)
Approx. 41 min
(using PHDVM-63DM)

Recording/playback time (DV SP)
Approx. 276 min
(using PHDV-276DM)
Approx. 63 min
(using PHDVM-63DM)

AUDIO jacks

IN
Pin jack: -10/-2/+4 dBu
Impedance: Minimum 47 k Ω
(kilo ohms), unbalanced
Maximum input level:
-10: +18 dBu (approx. 6 Vrms)
-2: +24 dBu (approx. 12.5 Vrms)
+4: +30 dBu (approx. 25 Vrms)

OUT

PHONES

VIDEO jacks

IN/OUT

S VIDEO jacks

IN/OUT

HDMI OUT jack

Video

Audio

Pin jack

Impedance: Maximum 1 k Ω
(kilo ohms)

Output level: 47 k Ω (kilo ohms)
loading, unbalanced
-10 dBu (= full bit -20 dB)
60i system
-10 dBu (= full bit -18 dB)
50i system

Stereo minijack (\varnothing 3.5),
8 Ω (ohms) loading

BNC type, unbalanced

1.0 Vp-p
(75 Ω (ohms), sync negative)

Sync signal:
0.286 Vp-p (60i/NTSC)
0.3 Vp-p (50i/PAL)

Burst signal:
0.286 Vp-p (60i/NTSC)
0.3 Vp-p (50i/PAL)

Mini DIN 4-pin, unbalanced

Luminance signal:
1.0 Vp-p
(75 Ω (ohms), sync negative)

Sync signal:
0.286 Vp-p (60i/NTSC)
0.3 Vp-p (50i/PAL)

Chrominance signal:
0.286 Vp-p (60i/NTSC)
(burst, 75 Ω (ohms))
0.3 Vp-p (50i/PAL)
(burst, 75 Ω (ohms))

Type A (19 pin)

480i, 576i, 480p, 576p, 1080i,
720p

2 channel liner

PCM 48 kHz/16 bits

COMPONENT OUT jacks

OUT BNC type

Output at 480i NTSC

With [BETACAM] selected in [IN/OUT REC] menu

Y: 1.0 Vp-p
(with 0.286 Vp-p sync negative, output impedance 75 Ω (ohms), unbalanced)

Pb/Cb/B-Y, Pr/Cr/R-Y: 0.7 Vp-p
(output impedance 75 Ω (ohms), unbalanced)
(75% color bars with 7.5 IRE setup)

With [SMPTE] selected in [IN/OUT REC] menu

Y: 1.0 Vp-p
(with 0.3 Vp-p sync negative, output impedance 75 Ω (ohms), unbalanced)

Pb/Cb/B-Y, Pr/Cr/R-Y: 0.7 Vp-p
(output impedance 75 Ω (ohms), unbalanced)
(100% color bars with no setup)

Output with other settings

Y: 1.0 Vp-p
(output impedance 75 Ω (ohms), unbalanced)

Pb/Cb/B-Y, Pr/Cr/R-Y: 0.7 Vp-p
(output impedance 75 Ω (ohms), unbalanced)
(100% color bars with no setup)

480i/480p:

Y: with 0.3 Vp-p sync negative

1080i/720p:

Y/Pb/Pr: with 0.6 Vp-p 3-level sync

i HDV/DV jack

i.LINK (IEEE1394,
4-pin connector S100)

Remote control

LANC Stereo mini-minijack (ø 2.5)

CONTROL S IN Stereo minijack (ø 3.5)

LCD screen

Picture 6.8 cm (2.7 type)

Total dot number 211 200 dots

960 (Horizontal) × 220 (Vertical)

General

Peak inrush current

Hot switching inrush current, measured in accordance with European standard EN55103-1: 13.0 A (230 V)

Power requirements

HVR-M25U
AC120 V, 60 Hz
HVR-M25N
AC100-240 V, 50/60 Hz
HVR-M25E
AC220-240 V, 50 Hz
HVR-M25P
AC100-240 V, 50/60 Hz

Power consumption (during play back)

12 W

Operating temperature

5 °C to 40 °C (41 °F to 104 °F)

Storage temperature

-20 °C to +60 °C
(-4 °F to +140 °F)

Dimensions Approx. $212 \times 98 \times 390.3$ mm
($8 \frac{3}{8} \times 3 \frac{7}{8} \times 15 \frac{3}{8}$ inches)
(w/h/d, including projecting parts
and controls)

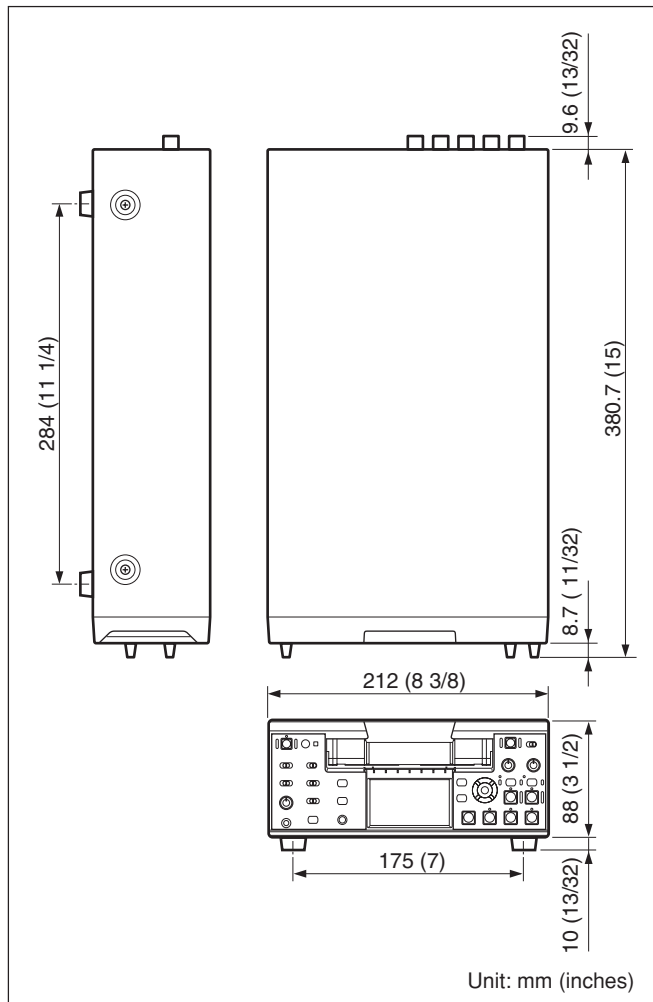

Mass Approx. 4.3 kg (9 lb. $7 \frac{5}{8}$ oz.)

Supplied accessories

- Remote Commander (1)
- Power cord (1)
- Size AA batteries (2)
- Cleaning cassette (1)
- Operating Instructions (1)

Design and specifications are subject to change
without notice.

A

Alarm message	88
Audio dubbing	60
Audio mode	27

C

Camera data	36
Cassette	30
Cassette memory	30
Cleaning cassette	89
Clock	78

D

Data code	36
Data display screen	25
Date search	38
Drop Frame	93
DV cassette	30
DV format	93
DVCAM cassette	30
DVCAM format	94

E

EE mode	13
---------------	----

F

FS32K	46
FS48K	46

H

HDMI OUT jack	20
HDV/DV jack	21, 44, 54, 62
HDV cassette	30
HDV format	93

I

i.LINK	98
Index	47
Index search	38

L

LANC jack	21
LCD monitor	13
Lock mode	93

M

Menu	66
Menu screen	25
Mini DV cassette	30
Moisture condensation	91

N

Non Drop Frame	93
----------------------	----

P

Playback	
at various speeds	37
frame by frame	37

R

Recording	43
Remaining tape time	26
Remote Commander	23

S

Search	38
Self-diagnosis	87

T

Time code	49
Troubleshooting	80

U

Unlock mode	93
Usable cassette	30
User bits	49



Submenu Index

Numerics

480i LEVEL	71
60i/50i SEL	79

A

AC ON MODE	78
ALLSCAN MODE	72
ASSIGN BTN	77
AUDIO LOCK	73
AUDIO MODE	73
AUDIO MONI	73
AUTO INDEX	74
AUTO STANDBY	78

B

BARS TYPE	70
BEEP	78

C

CLOCK SET	78
COLOR BAR	70
COMMANDER	77
CROP ADJUST	69
CROP MARKER	69
COUNTER SET	71
CUSTOM REPEAT	74

D

DATA CODE	72
DATE DISPLAY	72
DUPLICATE PLUS	74
DV BARS	70

E

EE/PB SEL	71
-----------------	----

F

FF/REW SPEED	74
FROM REC P	75
FROM STILL	75

H

HDV/DV IN TC	76
HDV/DV SEL	67
HOURS METER	78

I

i.LINK SET	69
INITIALIZE	79

L

LANGUAGE	77
LCD BLACK	73
LCD BRIGHT	72
LCD COLOR	72
LETTER SIZE	72

M

MARKER BURN	72
-------------------	----

P

PB CNR	78
PB YNR	78

R

REC MODE	67
REMAINING	72

S

STILL PICT	74
STILL TIME	75

T

TC FORMAT	76
TC MAKE	76
TC PRESET	75
TC RUN	76
TIME DISPLAY	72

U

UB PRESET	75
-----------------	----

V

VIDEO OUT	68
-----------------	----

<http://www.sony.net/>



Printed on 70% or more recycled paper using
VOC (Volatile Organic Compound)-free
vegetable oil based ink.

Printed in Japan



Free Manuals Download Website

<http://myh66.com>

<http://usermanuals.us>

<http://www.somanuals.com>

<http://www.4manuals.cc>

<http://www.manual-lib.com>

<http://www.404manual.com>

<http://www.luxmanual.com>

<http://aubethermostatmanual.com>

Golf course search by state

<http://golfingnear.com>

Email search by domain

<http://emailbydomain.com>

Auto manuals search

<http://auto.somanuals.com>

TV manuals search

<http://tv.somanuals.com>