

SONY

VIDEO CASSETTE RECORDER **Beta**

GCS-50

OPERATING INSTRUCTIONS

Before operating the unit, please read this manual thoroughly, and retain it for future reference.

OWNER'S RECORD

The model and serial numbers are located at the rear. Record the serial number in the space provided below. Refer to these numbers whenever you call upon your Sony dealer regarding this product.

Model No. GCS-50 Serial No. _____



Super Betahi-fi

This unit can be used with any **Beta** video cassette tapes. It is compatible with the **Beta II** type recording and playback format, and will play back tapes recorded in the **Beta I** and **Beta III** formats.

TABLE OF CONTENTS

Warning.....	2
Features.....	2
Precautions.....	3
Location and function of parts and controls.....	4
Connections.....	8
Connection diagram.....	8
About the AC outlet.....	10

Basics

Inserting/ejecting cassettes.....	11
Use of the safety tab.....	11
About the audio track.....	11

Operations

Recording.....	12
Audio recording level adjustment.....	13
Playback.....	14
Tracking adjustment.....	14
Betascan.....	14
Beta Skipscan.....	15
Freeze picture.....	15
Playback using JOG dial and SHUTTLE ring.....	16
Use of the time counter.....	17
Index function.....	17
Two ways to actuate the index function.....	18
To erase index signals.....	19

Advanced operations

Editing tapes.....	19
Audio and video insert.....	20
Preparation.....	20
Operation.....	21

General

Video head cleaning.....	22
Specifications.....	22
Recommended video equipment and accessories.....	23
Trouble checks.....	Back cover

WARNING

To prevent fire or shock hazard, do not expose the unit to rain or moisture.



This symbol is intended to alert the user to the presence of uninsulated "dangerous voltage" within the product's enclosure that may be of sufficient magnitude to constitute a risk of electric shock to persons.



This symbol is intended to alert the user to the presence of important operating and maintenance (servicing) instructions in the literature accompanying the appliance.

INFORMATION

This equipment generates and uses radio frequency energy and if not installed and used properly, that is, in strict accordance with the manufacturer's instructions, may cause interference to radio and television reception. It has been type tested and found to comply with the limits for a Class B computing device in accordance with the specifications in Subpart J of Part 15 of FCC Rules, which are designed to provide reasonable protection against such interference in a residential installation. However, there is no guarantee that interference will not occur in a particular installation. If this equipment does cause interference to radio or television reception, which can be determined by turning the equipment off and on, the user is encouraged to try to correct the interference by one or more of the following measures:

- reorient the receiving antenna
- relocate the equipment with respect to the receiver
- move the equipment away from the receiver
- plug the equipment into a different outlet so that equipment and receiver are on different branch circuits.

If necessary, the user should consult the dealer or an experienced radio/television technician for additional suggestions. The user may find the following booklet prepared by the Federal Communications Commission helpful:

"How to Identify and Resolve Radio-TV Interference Problems".

This booklet is available from the U.S. Government Printing Office, Washington, DC 20402, Stock No. 004-000-00345-4.

FEATURES

The GCS-50 incorporates the best of Sony video/audio technologies in an advanced Beta hi-fi VCR.

SHARP, CLEAR PICTURES

- This VCR produces sharp and accurate pictures with high resolution and contrast for beautiful, high quality video recording and reproduction.
- Crystal clear freeze frame provides sharp, clear pictures for precise viewing of any selected frame on the tape.
- Rotary erase head ensures clean pictures at the beginning and the end of the editing part.
- EDIT switch ensures optimum picture quality of edited tapes.
- HI-BAND switch makes possible high-quality recording and playback.

OUTSTANDING SOUND QUALITY

- Beta hi-fi recording provides excellent sound reproduction.
- Independent left and right channel sound level controls

SOPHISTICATED ARRAY OF FUNCTIONS, EASY OPERATION

Versatile JOG Dial/SHUTTLE Ring

- JOG dial for special effects playback—slow motion in both the forward and reverse directions for easy location of a desired frame.
- SHUTTLE ring allows forward or reverse playback at the desired (X1/5, x1 or x2) speed and "Betascan" of the tape.

Editing Functions

- Easy audio or video insert editing function allows insertion of pictures and sound from another VCR or other sources on previously recorded tapes. Video, audio channel 1 and audio channel 2 are independently selected when the insert mode of operation is activated.
- Connecting the optional Sony RM-E50 automatic editing controller enables automatic assemble editing. This allows another connected VCR to start and stop simultaneously with the playback of this VCR, within the preset start and stop points on the tape. During assemble editing, video, audio channel 1 and audio channel 2 are edited simultaneously.
- Framing servo system ensures correct frame orientation at the editing point.
- The Automatic Gain Control circuits maintain the proper video recording level, assuring optimum video recording.
- The audio recording level may be controlled manually using the level meters to monitor the signal.
- Two sets of audio/video output jacks and one set of audio/video input jacks allow editing with little deterioration.

PRECAUTIONS

Convenience Functions

- **Quick location of index signals (index scan or index search)** allows easy program confirmation.
- **Auto rewind function** automatically rewinds the tape when the end of the tape is reached during recording or playback.
- Power turns on automatically when a cassette is loaded while the power is off.

WHAT IS BETA HI-FI RECORDING?

In conventional recording, audio signals are recorded on the audio track and video signals on the video track. In Beta hi-fi recording, audio signals are recorded on the video track together with the video signals using two rotary video heads.

The Beta hi-fi audio signals are frequency-modulated and recorded on 2 channels, so that you can record a stereo program with sound quality far superior to that of a conventional audio recording. When recording in stereo, the source on the left side is recorded on Channel 1, and the source on the right side is recorded on Channel 2.

Beta hi-fi recording pattern on the video tape

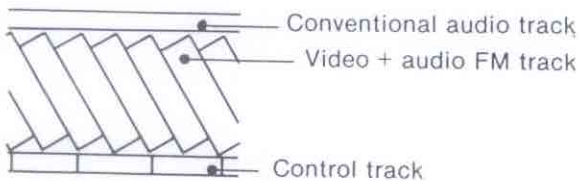

Video heads
For recording/playback of video and Beta hi-fi audio signals

Audio/control heads
For recording/playback of conventional audio signals and control signals.

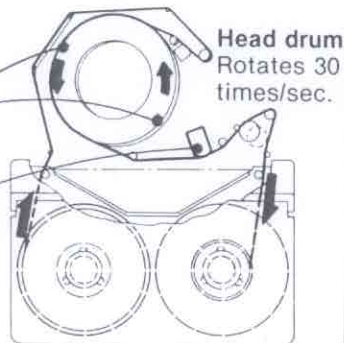

When the BETA HI-FI switch is set to ON, this recorder records audio signals both on the video track (Beta hi-fi recording) and on the conventional audio track (stereo) at the same time, so that these tapes can also be played back on any ordinary video cassette recorder without a Beta hi-fi system.

Safety

- Before operating, check to see that the operating power voltage and frequency of the unit are identical with those of your local power supply.
- Should any solid object or liquid fall into the cabinet, unplug the unit and have it checked by qualified personnel before operating it any further.
- Unplug the unit from the wall outlet if it is not to be used for an extended period of time. To disconnect the cord, pull it out by the plug. Never pull the cord itself.

Installation

- Allow adequate air circulation to prevent internal heat build-up.
- Do not place the unit on surfaces (rugs, blankets) or near materials (curtains, draperies) that may block the ventilation slots.
- Do not install the unit near a heat source such as a radiator or air duct or in a place subject to direct sunlight, excessive dust, mechanical vibration or shock.
- The unit is designed for operation in a horizontal position. Do not install it in an inclined position.
- Keep the unit and cassette tapes away from equipment with strong magnets, such as a microwave oven or a large loudspeaker.
- Do not place any heavy object on the unit.
- Store cassettes in their cases and keep them in an upright position to prevent uneven winding and intrusion of dust.

Operation

- When the unit is not in use, turn the power off to conserve energy and to prolong its life.
- Remove and store video cassettes after use.

Cleaning

Clean the cabinet, panel and controls with a dry soft cloth, or a soft cloth lightly moistened with a mild detergent solution.

Do not use any type of solvent, such as alcohol or benzene, which might damage the finish.

Repacking

Do not throw away the carton and packing materials. They make an ideal container in which to transport the unit. When shipping the unit to another location, repack it as illustrated on the carton.

If you have any questions about this unit, contact the authorized Sony dealer.

Caution

Television programs, films, video tapes and other materials may be copyrighted. Unauthorized recording of such material may be contrary to the provisions of the copyright laws.

LOCATION AND FUNCTION OF PARTS AND CONTROLS

Front panel

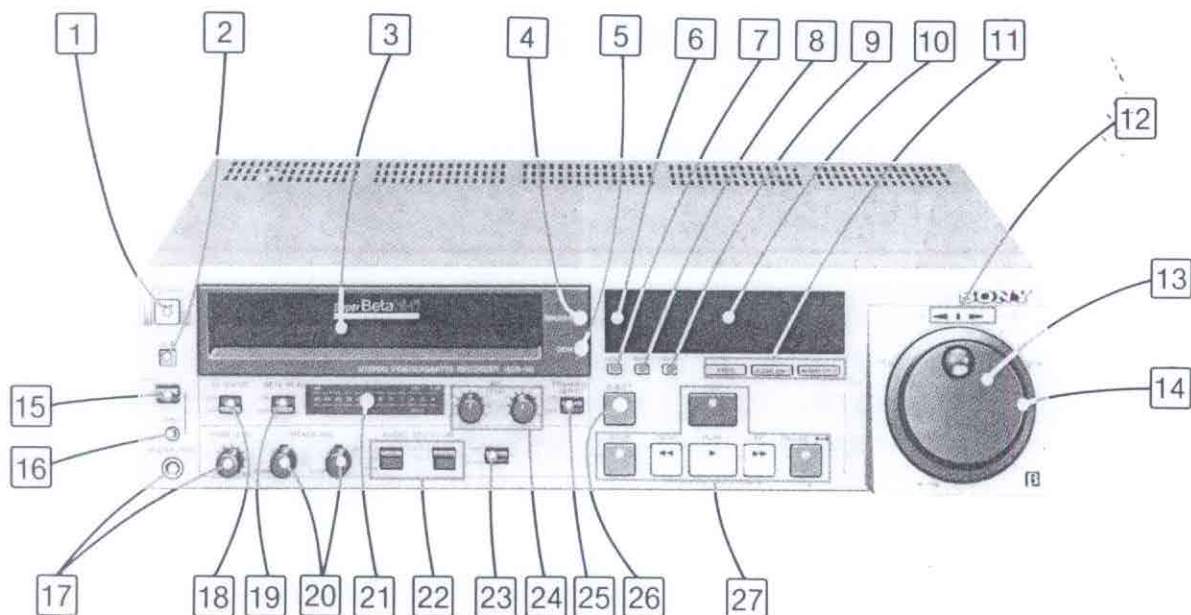

1 POWER switch and lamp

Press to turn the power on. The lamp will light up. To turn the unit off, press this switch again.

2 LOCAL button

When the power is turned on, this button lights up to show that the tape transport can be controlled with the buttons on this unit (local mode).

When you start operation with the optional RM-E50 editing control unit, the button's light will automatically go off to show that the tape transport can be controlled only with the RM-E50 (remote mode).

To cancel the remote mode and reset the unit in the local mode, press the LOCAL button.

3 Cassette compartment

Insert a cassette. If the cassette is inserted when the unit is turned off, the power will be turned on automatically.

4 BETA HI-FI indicator

Lights up when a recording is being made with the Beta hi-fi system with the BETA HI-FI switch set to ON, or when a tape that has been recorded with the Beta hi-fi system is being played back.

5 DEW indicator

Blinks when moisture has condensed inside the unit. When this indicator starts to blink, the loaded cassette will be ejected, and the unit cannot be operated until the moisture evaporates and the indicator goes off. Do not insert a cassette while the indicator is blinking.

6 RESET button

Press to reset the time counter to "0h00m00s".

7 INDEX button

Press before pressing the REW button or the FF button for the index-search or index-scan operation.

8 MARK button

To record index signals on the tape during playback or recording, press this button. The MARK indicator will light up in the display window.

9 ERASE button

To erase the index signals on the tape, press this button. The ERASE indicator will light up in the display window.

10 Display window

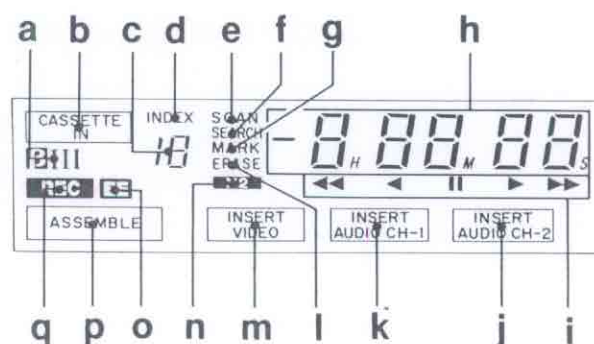

a Recording tape mode (speed)

b Lights up when a cassette is inserted. Flashes for a few seconds when recording on a cassette without the safety tab is attempted.

- c Index number for indexed programs to be searched or scanned. Lights up when index signals are being erased.
- d Flashes during the index-search and index-scan operation. Lights up when the index signal is being recorded or erased.
- e Flashes during the index scan operation.
- f Flashes during the index search operation.
- g Lights up when an index signal is being recorded.
- h Time counter which indicates the tape running time by the hour (H), minute (M) and second (S).
- i Show the tape operation modes.
 - ◀◀: rewind, ◀: reverse playback, ||: pause (still), ▶: playback, ▶▶: fast forward,
 - ◀◀◀: review (reverse Betascan high-speed playback) or Beta skipscan
 - ▶▶▶: cue (forward Betascan high-speed playback) or Beta skipscan
- j Lights up when the AUDIO CH-2 INSERT button is pressed for editing and goes off when the button is pressed again.
- k Lights up when the AUDIO CH-1 INSERT button is pressed for editing and goes off when the button is pressed again.
- l Lights up when an index signal is being erased.
- m Lights up when the VIDEO INSERT button is pressed for editing and goes off when the button is pressed again.
- n Lights up during double-speed playback in the forward and reverse directions.
- o Lights up when the unit is in the E-to-E* mode.
 - *The video input signal which is frequency-modulated and then demodulated in the recorder, is called the "E-to-E" (Electronics to Electronics) mode signal.
 - This VCR will be in the E-to-E mode during the stop, fast forward, rewind or recording mode, when the REC button is pressed during playback or when the cassette is being ejected.
- p Lights up during the assemble operation controlled by the automatic editing controller.
- q Lights up when the unit is set in the recording mode.

11 INSERT buttons

Press any or all of these buttons to set the unit in the insert edit mode and to select the input signal to be inserted onto part of a recorded tape. The corresponding indicator lights up in the display window. To cancel the selected mode, press the same button again and the indicator will go off.

VIDEO button: Press to insert the video signals.

AUDIO CH-1 button: Press to insert the audio signals on Channel 1.

AUDIO CH-2 button: Press to insert the audio signals on Channel 2.

12 Playback indicators

Indicate the forward or reverse movement or the pause mode of the tape during playback.

13 JOG dial

When the unit is in the playback pause mode, turn this dial. The picture will be played back at a speed (from slow to normal) which is determined by the speed you are turning the dial. Turn it clockwise for forward playback and counterclockwise for reverse playback.

14 SHUTTLE ring

When this ring is turned during the playback or stop mode, you will be able to play back the tape at double, normal or one-fifth of normal speed. When the ring is fully turned (REV or CUE position), you will be able to "Betascan" (see page 15) the picture. Turn it clockwise for forward playback and counterclockwise for reverse playback.

15 MIC (microphone) channel selector

Select the audio channel for microphone recording, CH-1/CH-2 (Channel 1 + Channel 2); CH-1 or CH-2.

16 MIC jack (minijack)

By connecting a microphone here, you will be able to record the sound from the microphone on the conventional audio track.

17 HEADPHONES jack (stereo phone jack) and PHONE LEVEL (headphones level) control

Connect headphones here to monitor the sound. The sound volume can be adjusted with the PHONE LEVEL control. When the PHONE LEVEL control is set to 0, there will be no sound from the headphones.

18 HI-BAND switch

Normally keep this switch at the ON position to obtain high quality recording/playback picture. Set this switch to OFF, if it is the only means of eliminating noise during playback of tapes recorded on other VCRs. Also, when playing back a tape recorded in the **BI** format, set the switch to OFF. For details, see page 13.

19 BETA HI-FI switch

This switch activates only on recording.

ON: Normally, keep this switch at this position.

Recording will be made with the Beta hi-fi system which produces the sound of high fidelity. (Recording in the conventional system will be made simultaneously so that tapes recorded on this VCR can be played back in the conventional system.)

OFF: Set the switch in this position if you desire to record the sound only in the conventional system.

20 TRACKING NORM (normal)/SLOW controls

Normally keep these controls at the center detent positions. Turning either of these controls may help clear possible streaks on the screen especially for cassettes recorded on other recorders. Turn the **NORM control** when playing back the tape at the normal speed or at double speed. Turn the **SLOW control** when playing back the tape at a slow speed by turning the JOG dial or the SHUTTLE ring.

21 Peak level meters

These meters show the peak input level of Channel 1 (left) and Channel 2 (right) during recording. They also register the levels during playback.

22 AUDIO MONITOR selectors

Select the sound (audio track on the tape) to be played back and monitored.

BETA HI-FI/MIX/NORM selector

BETA HI-FI: The sound recorded on the Beta hi-fi audio track will be heard.

MIX: The sound recorded on both the Beta hi-fi audio track and on the conventional audio track will be heard.

NORM: Only the sound recorded on the conventional audio track will be heard.

CH-1/CH-2 selector

This selector works for both the Beta hi-fi and the conventional audio track.

CH-1/CH-2: Both the sound recorded on Channel 1 and the sound recorded on Channel 2 will be heard. The sound on Channel 1 will be heard on the left and the sound on Channel 2 will be heard on the right.

CH-1: The sound recorded on Channel 1 will be heard.

CH-2: The sound recorded on Channel 2 will be heard.

23 EDIT switch

When editing tapes with two VCRs, set the switch to EDIT. In other cases, set the switch to NORM.

24 REC LEVEL controls

These controls adjust the audio recording level on the recording. The CH-1 control is for the left channel, and CH-2 is for the right channel. Normally set them to 5 for recording, and adjust manually to achieve optimum results.

25 FRAMING SERVO switch

Use this switch when using this unit as a recorder. Set the switch to ON to activate the framing servo system. Always set it to ON when editing the tape recorded with the optional Sony GCS-1 Betamovie. However, when editing a tape recorded with the VCR which is not equipped with the framing servo system or with this switch set to OFF, set the switch to OFF. Otherwise, the playback picture may be unstable at the edit point.

Also when the switch is set to ON from the OFF position during recording, the playback picture may be unstable.

26 EJECT button

Press to eject the cassette.

When the EJECT button is pressed during playback, rewind or fast-forward operation, the tape transport will stop, and the cassette will be ejected.

27 Tape transport buttons

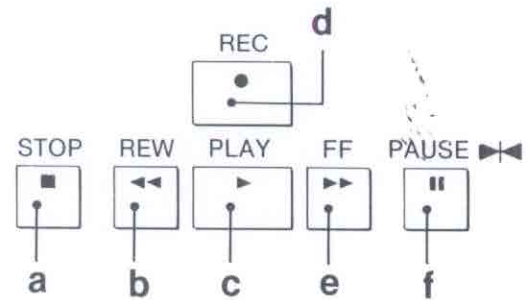

- a ■ **STOP:** Press to stop the tape.
- b ◀◀ **REW (rewind):** Press to rewind the tape, or to activate the reverse Betascan or Beta skipscan operation.
- c ▶ **PLAY:** Press to play back the tape.
- d ● **REC (record):** While pressing this button, press the PLAY button to start recording. Press this button during playback pause mode to set the unit in the recording pause mode.
- e ▶▶ **FF (fast-forward):** Press to advance the tape rapidly, or to activate the forward Betascan or Beta skipscan operation.
- f || ▶◀ **PAUSE (still):** Press to stop the tape momentarily during recording or playback. A freeze (still) picture will be displayed when the PAUSE button is pressed during playback. Press again to release the pause mode.

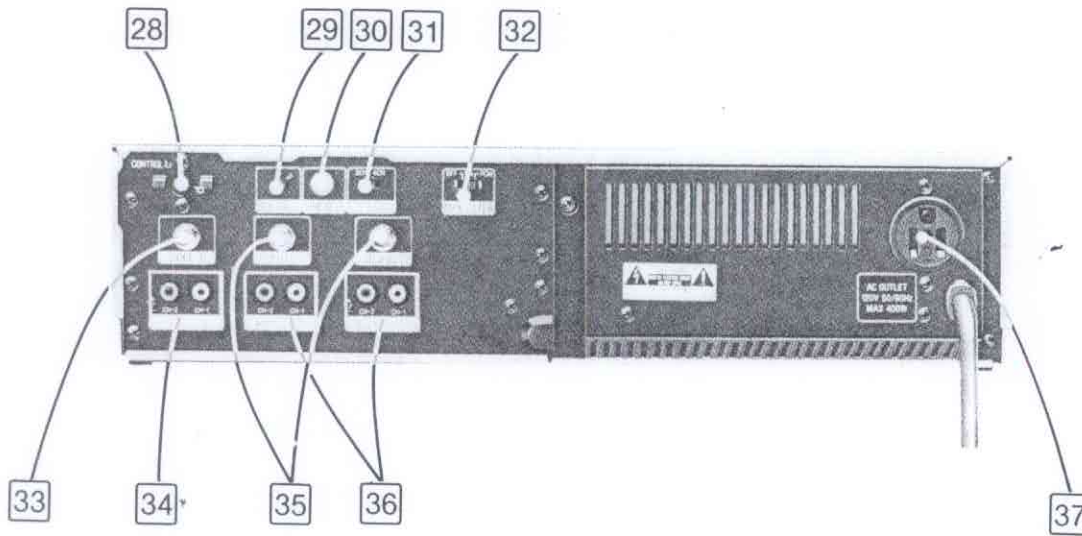
**28 CONTROL LF connector (5 pin)**

Connect to the CONTROL LF connector of the optional Sony RM-E50 automatic editing controller.

29 STILL ADJ (still picture adjustment) knob

If the still playback picture appears to jiggle, turn this knob until it stabilizes.

30 VHF OUT terminal

Connect to the VHF antenna terminal of a TV receiver. The output of this VCR will be converted to Channel 3 or 4 and supplied to the TV receiver by this connection (see page 10).

31 RF UNIT selector

Set this selector to 3CH (Channel 3) or 4CH (Channel 4), whichever is not active in your area. This selector converts the VCR's VHF output to either Channel 3 or 4 so that you will be able to view the VCR's picture by selecting either of these channels on the TV.

32 MPX FILTER (multiplex filter) selector

When using the unit as a recorder, set as follows.

OFF: Normally set the selector to this position.

ON: For recording FM radio broadcast programs. (If your FM tuner is equipped with an MPX filter, set this selector to OFF.)

PCM: For PCM recording and playback. After the PCM recording or playback is finished, be sure to set the selector to OFF.

33 VIDEO IN (input) jack (BNC type)

Connect to the video output of another unit such as a VCR or a TV receiver for recording. For PCM recording, connect a PCM digital audio processor.

34 AUDIO IN (input) jacks (phono jack) (CH-1 and CH-2)

Connect to the audio outputs of another VCR or to the line outputs of a sound source such as a tape recorder or a radio.

35 VIDEO OUT (output) 1 and 2 jacks (BNC type)

Connect to the video inputs of another VCR, a color monitor or a TV. For PCM playback, connect to a PCM digital audio processor.

36 AUDIO OUT (output) 1 and 2 jacks (phono jack)

Connect to the audio inputs of another VCR, a color monitor, a TV or a stereo system.

37 AC OUTLET (120 V 50/60 Hz MAX 400 W)

This unswitched outlet supplies AC power to other audio or video equipment even when this unit's power is turned off.

CONNECTIONS

Notes on connections

- Connect the AC power cord after all the other connections have been completed.
- Make firm connections. Loose connection may cause distorted picture and sound.
- Note that the white plugs of the connecting cord are for the audio CH-1 (left channel) connection, and the red plugs are for the audio CH-2 (right channel) connection.
- When disconnecting the power cord from the wall outlet, be sure this unit's power is turned off.

CONNECTION DIAGRAM

Connection for tape-to-tape editing using video editing control unit—for quick and easy editing

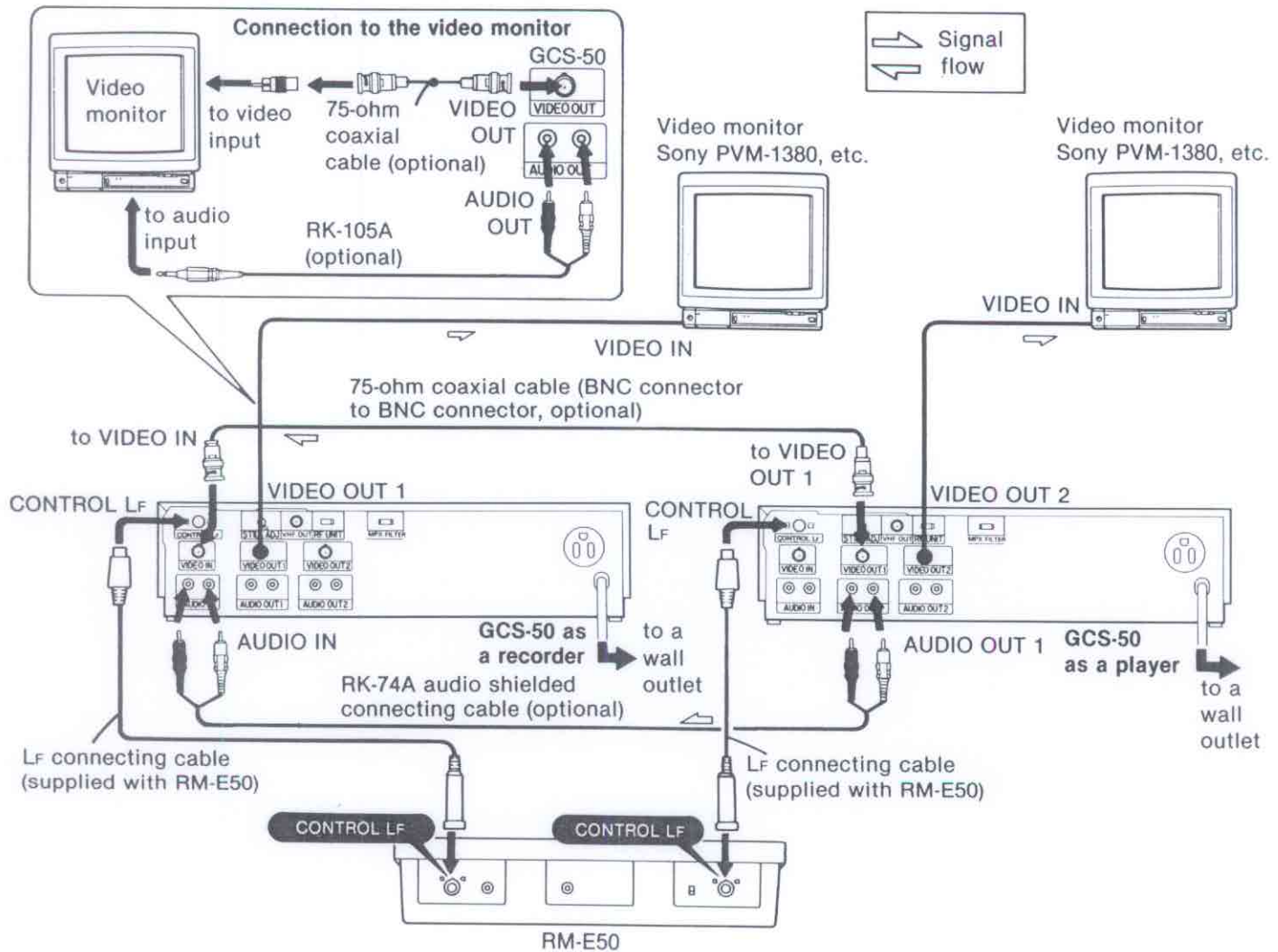

With the automatic editing controller, you will be able to preset the locations of the scenes you want to record (up to 64) in the controller, and with a press of a button, these scenes will be recorded automatically by the VCR in the preset order (**assemble editing**). For details, refer to the RM-E50 instruction manual.

How to attach the supplied connector lock clasp

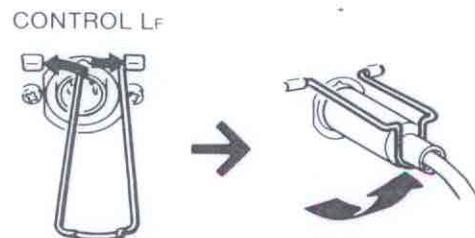

Connecting two GCS-50s for tape-to-tape editing

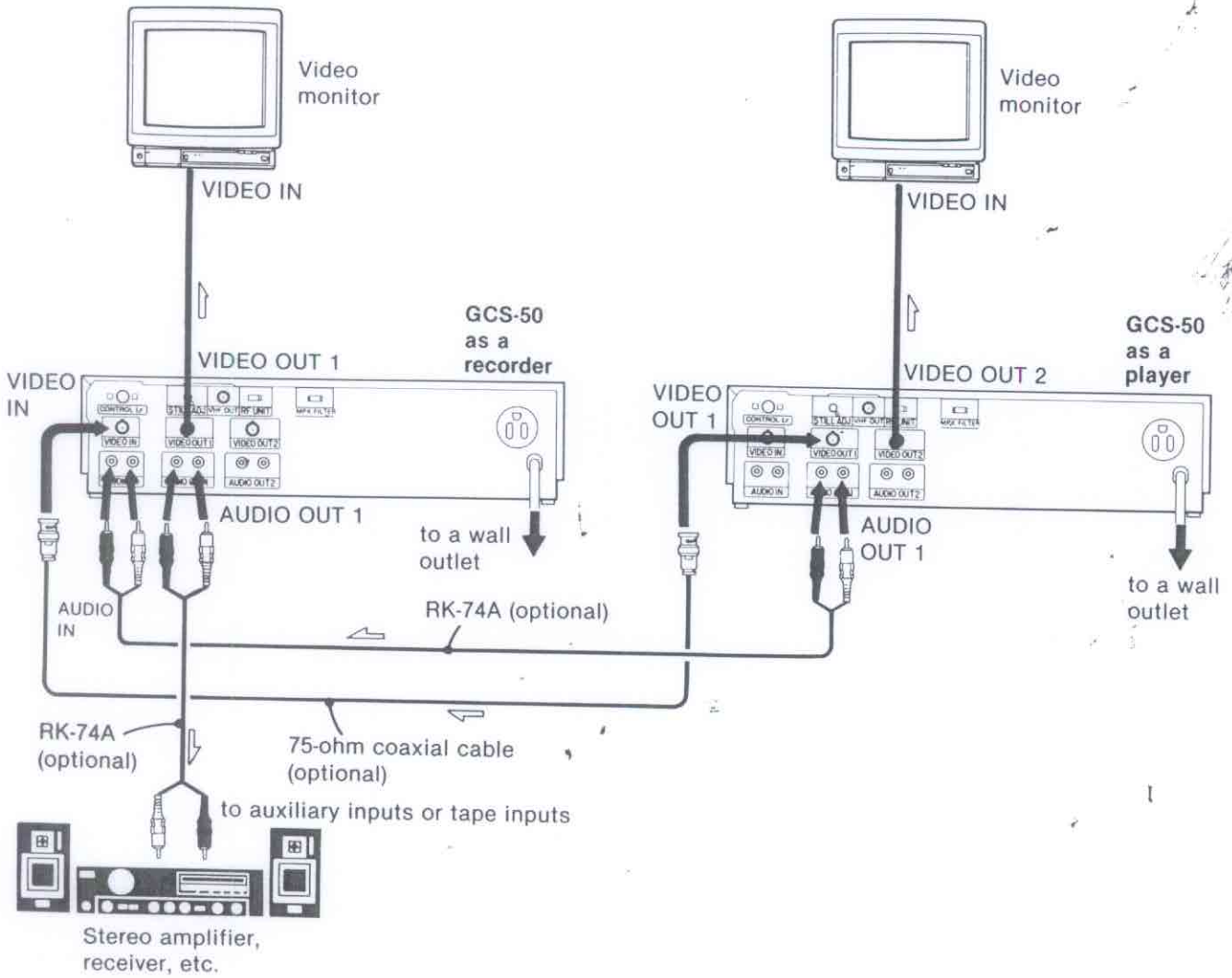

You can experience a more dynamic sound from tapes recorded in Beta hi-fi when the recorder is connected to a stereo system.

When connecting a conventional TV receiver instead of a video monitor, use the supplied ANS-34 antenna switch. The antenna switch automatically selects the antenna input or the VCR playback signal for TV viewing.

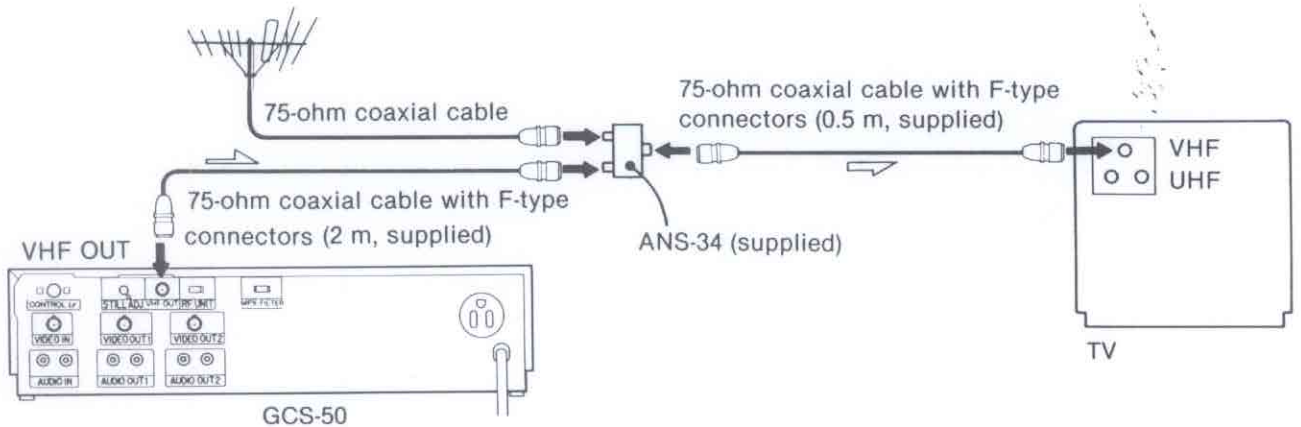

Connection for TV program recording/playback/monitoring

Connecting a TV tuner and a video monitor

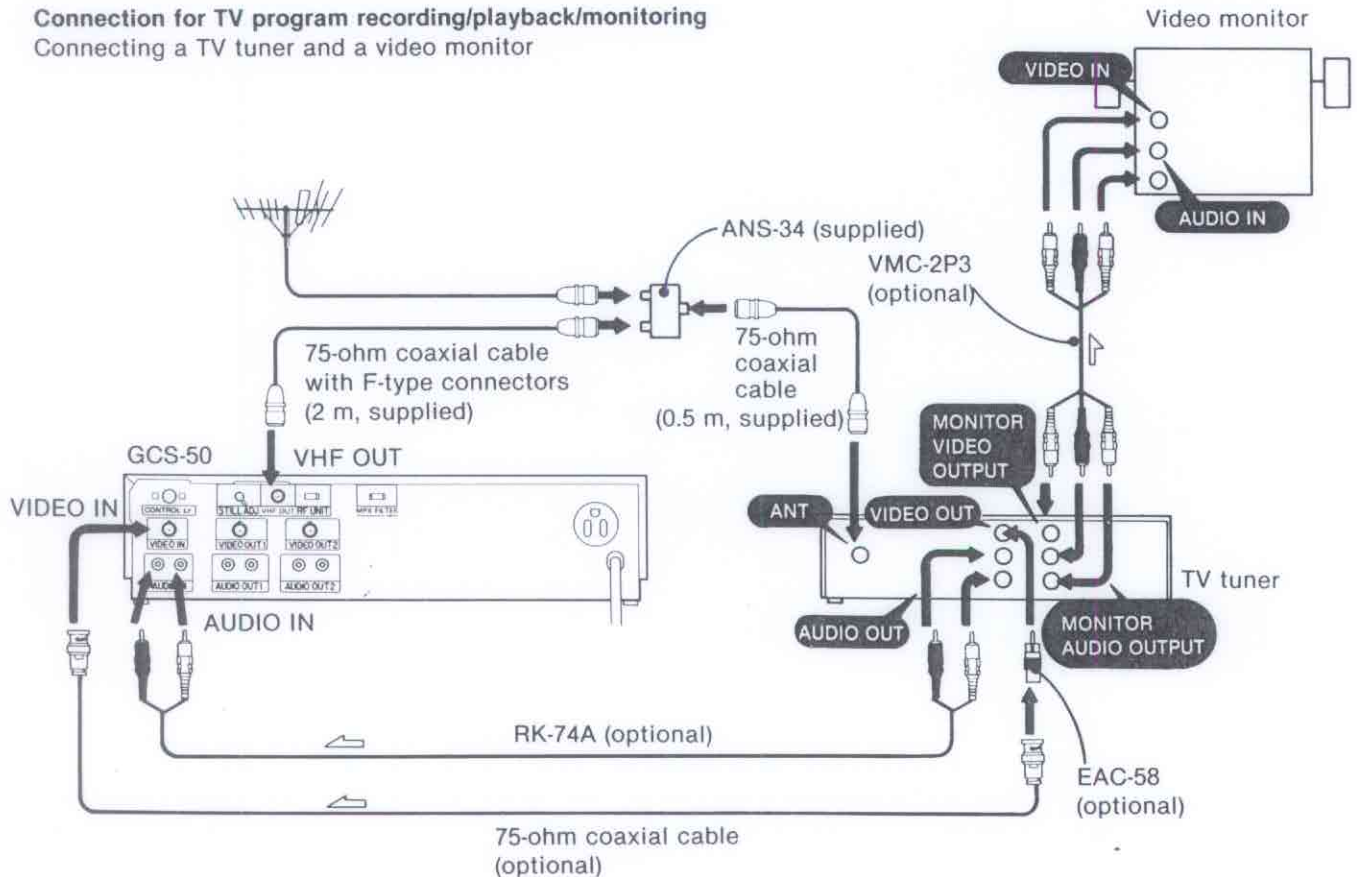

ABOUT THE AC OUTLET

This socket provides a convenient AC power source for other audio or video equipment whose power consumption is under 400 watts. Power will be supplied to the connected equipment even when this unit is turned off.

Do not connect any electrical home appliances whose power consumption exceeds 400 watts, such as an electric iron or fan.

BASICS

INSERTING/EJECTING CASSETTES

Insert a cassette gently into the compartment until it starts sliding in. An arrow on the cassette indicates the direction in which it should be inserted.

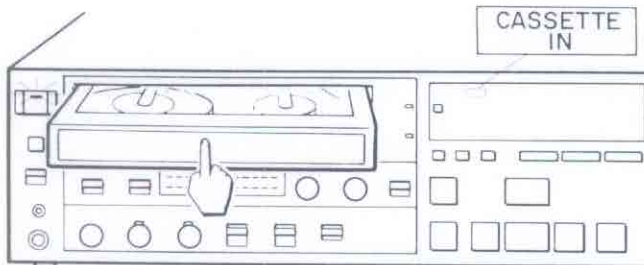

The CASSETTE IN indicator will light up.

The power of this VCR will turn on automatically whenever a cassette is newly inserted.

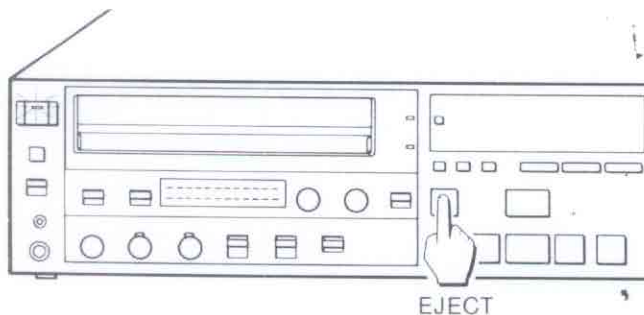

To eject the cassette, press the EJECT button. The CASSETTE IN indicator will go off.

USE OF THE SAFETY TAB

When a new recording is made on a previously recorded cassette, the previous recording will be automatically erased.

To avoid erasing the recording

Break off the safety tab using a screwdriver or a similar object. The CASSETTE IN indicator will flicker for a few seconds when you attempt to start recording. The recording mode will not be activated.



To re-record on a cassette which has had its safety tab removed

Cover the hole with a piece of plastic tape.



ABOUT THE AUDIO TRACK

In the Beta hi-fi recording system, sound is recorded simultaneously on two tracks of the tape as illustrated below.

Tape

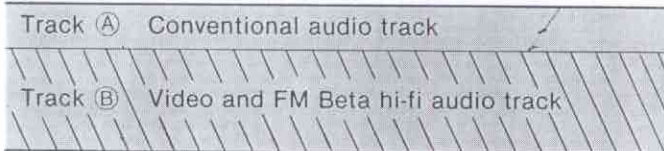

On track A, a stereo recording is made so that tapes recorded on this VCR can also be played back on VCRs that are not equipped with a Beta hi-fi system.

It is on track B that the Beta hi-fi recording of high-fidelity stereo sound is made. The Beta hi-fi recordings can only be played back on Beta hi-fi VCRs.



The BETA HI-FI switch should be set to ON to make Beta hi-fi recordings. When it is set to OFF, sound recordings will be made only on the conventional audio track.

In the illustrations in this instruction manual, Track A refers to the conventional audio track and Track B to the Beta hi-fi audio track.

Selecting the audio track to be monitored

You can listen to the sound tracks separately or together by setting the AUDIO MONITOR selector as follows during recording or playback.



Position	Selected sound
BETA HI-FI	Beta hi-fi recording sound (Track B)
MIX	Mixed sound of Beta hi-fi and conventionally recorded sound (Track A and B)
NORM	Conventionally recorded sound (Track A)

When tapes recorded on other non-Beta hi-fi VCRs are played back, the conventional audio track of such tapes will be automatically selected and played back regardless of the switch position.

Selecting the audio channel to be monitored

When monitoring sound, you can also listen to the sound on Channel 1 and Channel 2 separately or together.

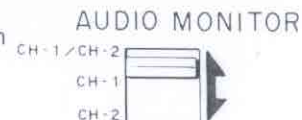

Position	Selected sound
CH-1/CH-2 (stereo)	The sound on both audio Channel 1 and audio Channel 2
CH-1	The sound on audio Channel 1 (left)
CH-2	The sound on audio Channel 2 (right)

OPERATIONS

RECORDING

Before recording

- Make the necessary connections (see pages 8 to 10).
- Make sure that the safety tab on the cassette is **not** broken off.
- Make the preparatory settings of switches and controls.

Recording is made in the **REC** mode.

Recording time available in the **REC** mode

Cassette used	Available recording time
L-125	30 minutes
L-250	1 hour
L-370	1 hour and 30 minutes
L-500	2 hours
L-750	3 hours

For optimum performance, use a video cassette with a model number of L-750 or lower.

Recording

When operating the unit with the buttons on the unit, make sure that the LOCAL button light is on.

The numbers in the illustration show the sequence of operations.

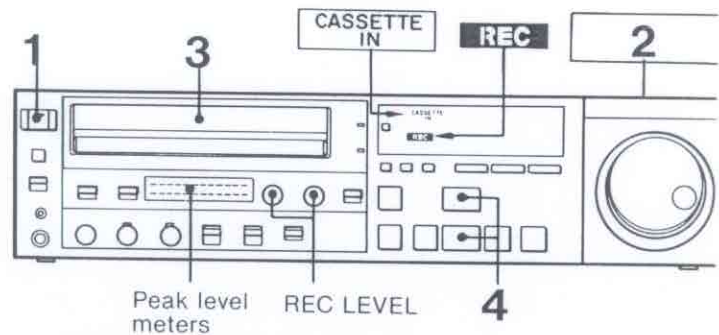

- 1 Press the POWER switch to turn the power on.
- 2 Prepare the program source to be recorded.
To edit a tape, cue the tape to be edited on the player.
- 3 Insert a video cassette (in the recorder).
- 4 While pressing the REC button, press the PLAY button to start recording. The REC indicator on the display window will light up.

During recording, when the tape reaches its end, it will be automatically rewound to its beginning.

To stop recording, press the STOP button.

To eject the cassette, press the STOP button, then the EJECT button.

To stop the tape momentarily, press the PAUSE button. The **||** indicator will light up.

To resume recording, press the PAUSE button again.

If you do not resume recording for more than about 8 minutes, the pause mode will be automatically cancelled and the tape will stop. -

When operating the unit for editing with the automatic editing controller, refer to the RM-E50 instruction manual.

AUDIO RECORDING LEVEL ADJUSTMENT

The recording level can be set manually for both Beta hi-fi and non-Beta hi-fi recordings. Usually proper recording levels can be obtained by setting the REC LEVEL controls to "5" (center detent position).

However, when recording a sound source which contains a wide range of signals, it may be necessary to manually adjust the recording level to obtain a better recording.

Adjust the controls while monitoring the peak level meters. If the recording level setting is too high, the sound will be distorted; if the setting is too low, a noisy recording will result. The recording level should be set as high as possible, without creating distortion. Normally, adjust the REC LEVEL controls so that the meters deflect occasionally to the red element at the highest signal level.

Notes

- Set both the REC LEVEL controls to the same positions.
- When the REC LEVEL controls are set to the minimum position, sound cannot be recorded.

PAUSE

When the PAUSE button is pressed during recording, an E-to-E mode picture and sound will still be projected on the monitor, but not recorded.

To switch from the playback mode to the recording mode, first press the PAUSE button, then press the REC button, and press the PAUSE button again.

NOTE

ABOUT THE HI-BAND (SUPER BETA) SWITCH

Normally keep this switch in the "ON" position to obtain high picture quality recordings and playback.

The frequency of the intensity signal carrier becomes high during recording so that you can get a high-quality picture when playing back the recorded cassette.

Tapes recorded in other conventional VCRs without HI-BAND (or SUPER BETA) switch can be played on SuperBeta VCRs.

Tapes recorded with the HI-BAND switch set to ON can be played on other non-SuperBeta VCRs. However, some over-modulation noise may appear in the picture during playback. If you intend to play back on the non-SuperBeta VCRs, set the HI-BAND switch to the "OFF" position when making your recordings.

PLAYBACK

Before playing back the tape

Make the preparatory switch settings indicated below.

HI-BAND



For tapes recorded with this switch ON → ON

For tapes recorded with this switch OFF or tapes recorded on VCRs without this switch → OFF

AUDIO MONITOR

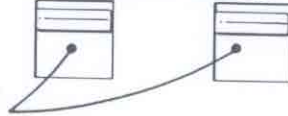

→ For the desired audio track or channel
(See page 11.)

Playback

When operating the unit with the buttons on this unit, make sure that the LOCAL button light is on.

The numbers in the illustration show the sequence of operations.

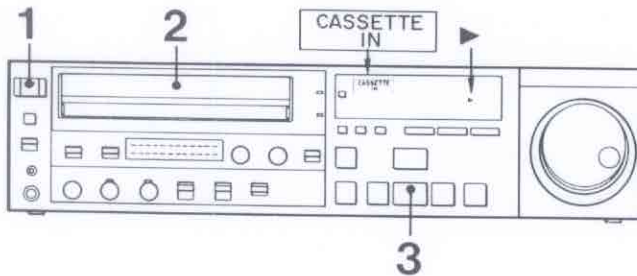

- 1 Press the POWER switch to turn the power on.
- 2 Insert a recorded cassette.
- 3 Press the PLAY button. Playback will begin and the ► indicator on the display window will light up.

When the tape is played back to the end, it will be automatically rewound to the beginning.

To stop the playback, press the STOP button.

When operating the unit for editing with the automatic editing controller, refer to the RM-E50 instruction manual.

Playback of stereo sound recordings

If the VCR's AUDIO OUT CH-1 or CH-2 jacks are connected to the stereo audio input jacks of a TV or to a stereo system, or if stereo headphones are connected to the HEADPHONES jack, you can enjoy the stereo sound reproduction of stereo program recording.

Be sure that the AUDIO MONITOR selector is set to the CH-1/CH-2 position when playing back stereo programs. For details, read "About the audio track" on page 11.

TRACKING ADJUSTMENT

If the playback picture of a tape recorded on other VCRs seems distorted or snowy, adjust the TRACKING controls to obtain the best possible picture.

Turn the TRACKING NORM control for a tape being played back at normal or double speed.

For a tape being played back at slow speed with the JOG dial or the SHUTTLE ring (see page 16), turn the TRACKING SLOW control.

Be sure to return the controls to their center detent positions after viewing the tape.

BETASCAN

Viewing the picture at high speed to find a particular scene

Press the REW or FF button during playback. When you release the button, normal playback will resume.

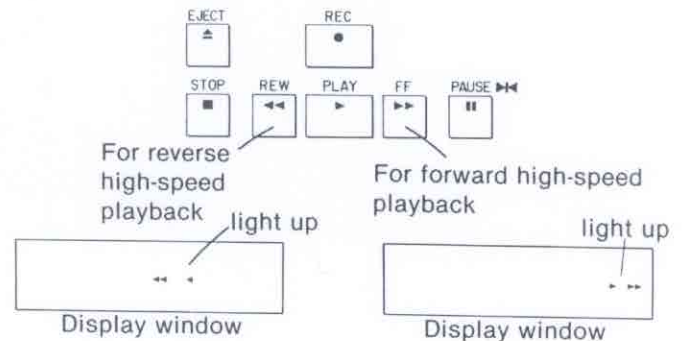

BETA SKIPSCAN

Viewing the picture momentarily during fast-forward or rewind

Press the REW or FF button during **fast-forward** or **rewind** mode.

When you release the button, the fast-forward or rewind mode will resume.

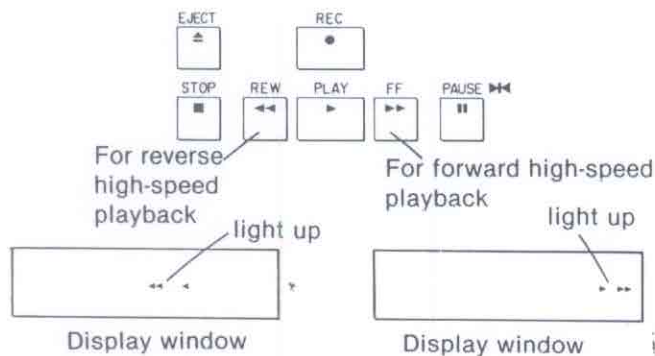

Notes on Betascan and Beta skipscan

- In Betascan or Beta skipscan operation, slanted stripes or bars may appear, or the picture may roll at the beginning or end of the tape (on some monitors), even though Betascan or Beta skipscan is functioning correctly. If such a symptom appears at the middle part of a tape, adjust the horizontal and vertical hold controls on the monitor. If such a condition still exists, consult your authorized Sony dealer.
- Streaks or double images may appear in the Betascan or Beta skipscan picture, even though Betascan or Beta skipscan is functioning correctly.
- On some monitors, the Betascan or Beta skipscan picture may become monochrome.
- When using a tape recorded in **FI**, **FI II** or **FI III** mode, play back the tape at normal speed so that the corresponding playback mode lamp lights up. Then proceed with the Beta skipscan operation. The picture in the Beta skipscan mode will be unstable if the playback mode of the tape has not been detected.

FREEZE (STILL) PICTURE

Press the PAUSE button during playback.

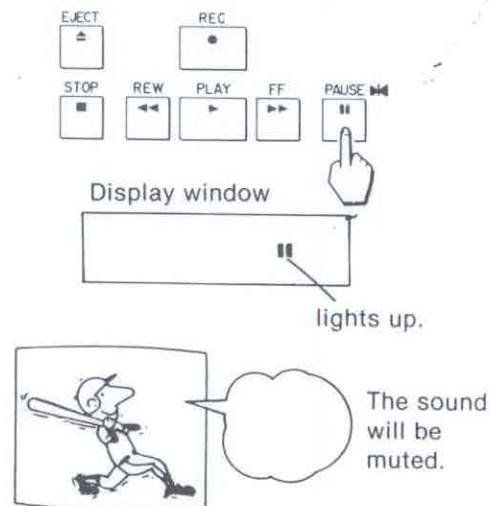

To resume playback, press the PAUSE button again or press the PLAY button.

Notes

- If the displayed freeze picture jiggles, turn the STILL ADJ (adjustment) control at the rear until the picture stabilizes. As long as the same monitor is used with this VCR, it should not be necessary to make this adjustment frequently. This control may not work for particular tapes recorded in the **FI** mode.
- If streaks or noise appear, play back the tape at slow speed (see next page), adjust the TRACKING SLOW control and freeze the picture with the **II** (pause) button again.
- To protect the video heads and the tape, the pause mode will be automatically cancelled after about 8 minutes and playback will resume.

PLAYBACK USING JOG DIAL AND SHUTTLE RING

Lights up during the playback pause mode.

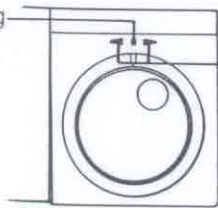

Indicate the forward or reverse playback of the tape.

Using the JOG dial

- 1 Play back a tape and stop the playback with the PAUSE button.
- 2 Turn the dial.



The tape will be played back at a speed (from slow to normal speed) which is determined by the speed of the dial's rotation.

Turn it clockwise for forward playback or counter-clockwise for reverse playback.

Note

The JOG dial activates only when the SHUTTLE ring is set to the center position.

Using the SHUTTLE ring

Turn the ring and set it to the desired position.

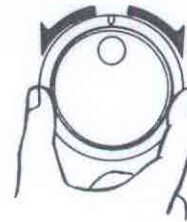

Turn the ring as much as desired for playback at one-fifth the normal speed, at normal speed, or at double speed. When the ring is fully turned (REV or CUE position), you will be able to "Betascan" the picture. Turn it clockwise for forward playback or counter-clockwise for reverse playback.

When the ring is returned to the center position, the tape pauses and a freeze picture will appear on the monitor screen.

Notes

- During the playback using the SHUTTLE ring, if the unit is once set in the pause mode and the pause mode is cancelled, the unit will return to the normal playback mode, regardless of the position of the SHUTTLE ring.
- Streaks will appear during playback at speeds other than the normal speed. In addition, the sound on the Beta hi-fi track will be muted except when the tape is being played back at double speed. (Set the AUDIO MONITOR switch to the MIX or NORM position to monitor the sound.)
- The tape recorded in **BI** mode will be played back at normal speed even when the SHUTTLE ring is set at the x2 position.

If the picture of a tape played back at a speed slower than the normal speed seems distorted or snowy, turn the TRACKING SLOW control to obtain the best possible picture. (By this picture adjustment of slow playback, the freeze picture of that recording will be adjusted as well.)

Be sure to return the control to the center detent position after viewing the tape.

USE OF THE TIME COUNTER

The time counter indicates the running time of the tape and the relative position of programs on the tape.

Before starting recording or playback, press the RESET button to set the counter to "0H 00M 00S".



By noting the counter reading at the desired point, you can easily find that point later by referring to the counter. Use the label on the cassette to list the programs and their counter readings.

Notes

- The counter reading is automatically reset to zero when a cassette is newly inserted.
- The counter reading will be retained in the unit's memory even after the power is turned off, as long as the cassette remains in the cassette compartment.
- The counter does not operate when a blank tape is used. Therefore, you can easily locate a blank part of the tape by observing the point at which the counter stops.

INDEX FUNCTION

The index function allows easy location (and playback) of a desired program. The desired program can be located by the index signals recorded on the tape.

An index signal is automatically recorded on the tape when the recording is started by pressing the REC and PLAY buttons.

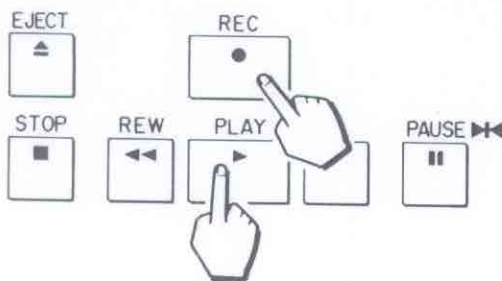

"INDEX" and "MARK" light up while the index signal is being recorded.



Notes

- An index signal will not be recorded on the tape when the recording is started by releasing the recording pause mode.
- The index function operates also with index signals recorded on other VCRs equipped with an index function, such as the Sony SL-2500, SL-2700 or SL-HF900.

Index signals can be recorded at any desired point on the tape during recording or playback.

At the point where an index signal is to be recorded, press the MARK button.

"INDEX" and "MARK" light up while the index signal is being recorded.

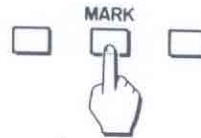

Notes

- During playback, the sound will be muted while the index signal is being recorded, but the recording will not be affected.
- Do not attempt to record an index signal immediately before a point on the tape where the recording tape speed (II or III) changes. In such a case, the index signal may not register.
- Index signals can be recorded on cassette tapes without safety tabs (including commercially available pre-recorded video tapes).

The length of the index signal recorded during recording is approx. 8 seconds. However, the length of the index signal recorded during playback varies according to the tape speed at which it was recorded.

- II : approx. 4 seconds.
- II : approx. 8 seconds.
- III : approx. 12 seconds.

TWO WAYS TO ACTUATE THE INDEX FUNCTION: Index scan and Index search

Index scan

This function allows you to play back the beginning of each program on the tape.

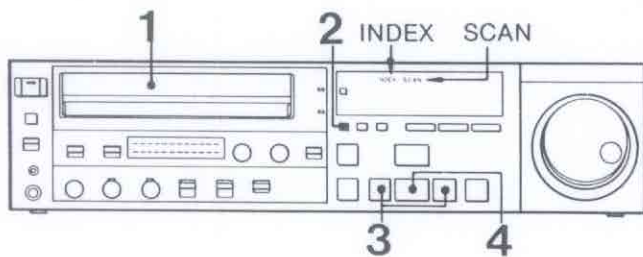

- 1 Insert a cassette that has index signals recorded.
- 2 Press the INDEX button once. The INDEX and SCAN indicators will flash alternately and \square will be displayed.
- 3 When scanning the previous programs, press the REW (rewind) button. When scanning the programs ahead, press the FF button. The INDEX and SCAN indicators will light continuously and the tape will rewind or advance rapidly to the next index signal recorded. Whenever an index signal is detected, the tape will play back for approx. 10 seconds, and then rewind or advance rapidly to the next index signal.
- 4 When the desired program is located, press the PLAY button. Playback of that program will begin.

Index search

You can locate the desired program and play it back automatically by designating its index signal number. Up to the nineteenth index signal away from the current tape position can be located.

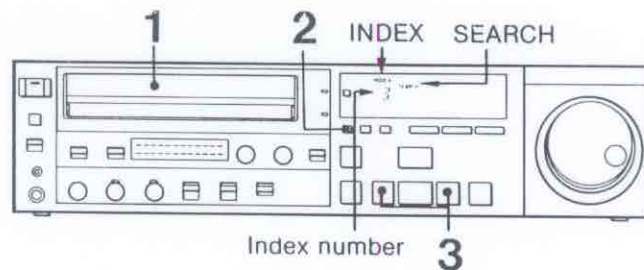
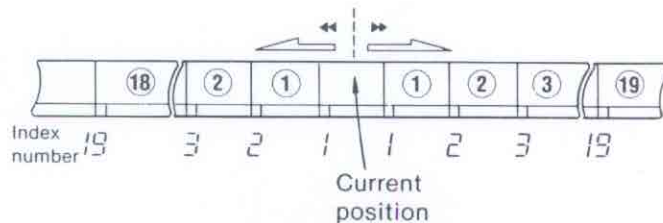

- 1 Insert a cassette that has index signals recorded.
- 2 Press the INDEX button several times until the number of the desired program is displayed. For instance, to locate the second program ahead, two index signals will have to be detected, so press the button until "2" is displayed. On the other hand, to locate the second program back, three signals will have to be detected, so press the button until "3" is displayed.
- 3 When locating a previous program on the tape, press the REW button. When locating a program ahead, press the FF button.

The tape will rewind or advance rapidly. Every time an index signal is detected, the displayed number will decrease. When the desired program is located, playback of the program will start. The displayed index number will go off after several seconds.

Notes

- The index function can be activated during playback, as well as from the stop mode.
- While the index signals are being scanned or searched for, there will be no picture or sound.
- If the tape is rewound to the beginning during index scan, playback will begin automatically.

When the desired program cannot be played back with an index function, check the following:

- Is the program less than one minute in length? Such a program will not be counted.
- The nearest index signal may not have been counted.

If the point where you pressed the REW or FF button is fairly close (within one minute of the normal tape-run) to the nearest index signal, the nearest index signal will not be counted. In such a case, designate one number less than the actual number.

- Is there a space of more than 2 minutes between each index signal? If there is more than one index signal recorded within a two-minute space of the normal tape-run, the mechanism may not function properly.

TO ERASE INDEX SIGNALS

Note

Index signals that were recorded by pressing the REC and PLAY buttons on an unrecorded portion (with no CTL signal recorded) of the tape and the index signals that were recorded immediately before a point on a tape where the recording tape speed had been changed cannot be erased.

Scan-erasing (erasing the nearest index signal one after another)

- 1 Stop the tape by pressing the STOP button.
- 2 Press the INDEX button. The INDEX and SCAN indicators will flash alternately.
- 3 To scan-erase the previous index signals on the tape, press the REW button. To scan-erase index signals ahead, press the FF button. The tape will rewind or advance rapidly to the nearest index signal.
- 4 When each index signal is found, the tape will play back for approx. 10 seconds. While the tape is being played back, **press the ERASE button**. The ERASE indicator will light while the index signal is being erased.

During the erasure, the sound will be muted, but the recorded audio will not be affected.

To stop the scan-erasing operation, press the STOP button.

Search erasing (designating the index signal to be erased)

- 1 Stop the tape by pressing the STOP button.
- 2 Count the number of the index signals from the current position of the tape to the signal you want to erase and set the number (on the left of the time counter) by pressing the INDEX button repeatedly.
- 3 To search for and erase a previous index signal on the tape, press the REW button. To search for and erase an index signal ahead, press the FF button. The INDEX and SEARCH indicators will light up and the designated index signal will be searched for.
- 4 When the designated index signal is found, the tape will be played back.

Press the ERASE button while the INDEX and SEARCH indicators are still displayed. A slight automatic adjustment of the tape position will be made and then erasing will begin. The ERASE indicator will light up while the index signal is being erased.

When the erasing of the index signal ends, the displayed number will go off.

EDITING TAPES

For tape-to-tape editing, you will need two VCRs (two GCS-50s): one to playback the original tape and the other to record a second tape.

For quick and easy editing, use the optional Sony RM-E50 automatic editing controller.

By setting the EDIT switch to the EDIT position, deterioration of the quality of the edited picture can be prevented. Be sure to return the switch to the NORM position when you have finished editing.

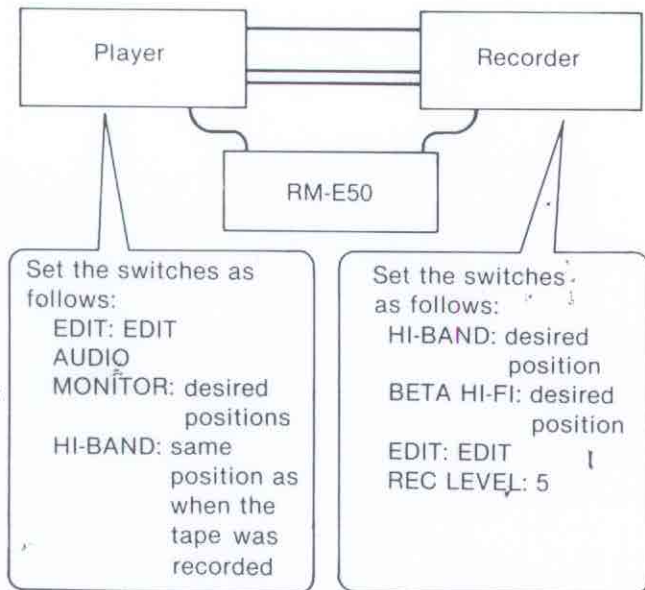

After making preparatory settings of the switches, start editing by operating the RM-E50. For details, read the instruction manual supplied with the RM-E50. For connections, see the connection diagram on page 8.

When recording the playback of this VCR on a VCR which is not equipped with a Beta hi-fi system

If the sound on the Beta hi-fi audio track and on the conventional audio track of the tape were originally recorded separately (such as when the SAP of a TV program is recorded on the conventional audio track and the main sound is recorded on the Beta hi-fi audio track in other VCR), be sure to select the audio track to be played back with the AUDIO MONITOR selector. The selected sound (and only the selected sound) will be recorded by the other VCR.

Note that if the switch is set to MIX, the sound of the two audio tracks will be mixed. With VCRs that are not equipped with a Beta hi-fi system, they will be reproduced mixed as well.

AUDIO AND VIDEO INSERT

For automatic assemble editing using the automatic editing controller, refer to the instruction manual of the RM-E50.

By using the INSERT buttons, you can easily insert (re-record) new sound and/or picture onto a recorded tape. Use only already recorded tapes, because the CTL (control) signals must be recorded in advance for insert operation.

(The tape recorded on **IBI** or **IBIII** mode cannot be used.)

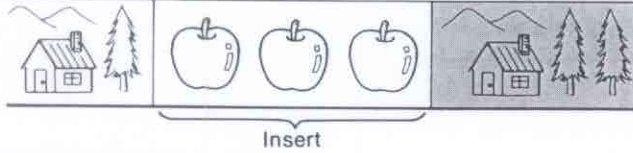

Use audio/video insertion

- When adding music or narration to a tape on video signal is already recorded.
- When adding a video signal to a tape on which audio is already recorded.
- When replacing a part of the audio and/or video signals of an already recorded tape.

Video insert —Inserts a new picture and Beta hi-fi sound, without erasing the original sound on the conventional audio track.

Audio CH-1 insert —Inserts new sound on the audio Channel 1 track (conventional audio track) without erasing the original picture, Beta hi-fi sound or the sound on the audio Channel 2 track of the tape.

Audio CH-2 insert —Inserts new sound on the audio Channel 2 track (conventional audio track) without erasing the original picture, Beta hi-fi sound or the sound on the audio Channel 1 track of the tape.

Only the desired signals are replaced by new signals; VIDEO, AUDIO CH-1 and AUDIO CH-2 can be selected independently and any combination may be used.

Examples of the recording on the tape after audio and/or video insertion

Example 1: AUDIO CH-1 insert	<p>TRACK (A) 2 Original sound on audio Channel 2 track 1 Newly inserted sound (left channel)</p> <p>TRACK (B) Original picture *</p>
Example 2: VIDEO insert	<p>TRACK (A) Original sound on conventional audio track</p> <p>TRACK (B) Newly inserted picture and/or Beta hi-fi sound</p>
Example 3: AUDIO CH-1 and AUDIO CH-2 insert	<p>TRACK (A) 2 Newly inserted sound (right channel) 1 Newly inserted sound (left channel)</p> <p>TRACK (B) Original picture *</p>
Example 4: AUDIO CH-1, CH-2 and VIDEO insert	<p>TRACK (A) 2 Newly inserted sound (right channel) 1 Newly inserted sound (left channel)</p> <p>TRACK (B) Newly inserted picture and/or Beta hi-fi sound</p>

* and Beta hi-fi sound, if the tape was originally recorded in the Beta hi-fi system.

When the tape is being played back or also while the insertion is being made, you can select the sound on Track (A) (Beta hi-fi track) and/or Track (B) (conventional audio track) by setting the AUDIO MONITOR selector to the desired position. If you select Track (A) by setting the selector to NORM, you can select the sound on Track (A)-1 (Channel 1) or Track (A)-2 (Channel 2).

Note

The tape which is recorded on several recording tape modes, such as **IBI**, **IBII** and **IBIII**, cannot be used as the recorder's tape for insert editing.

PREPARATION

Select the desired audio and/or video source for the insertion and connect the source to the VCR. Examples are shown below.

Another VCR



See page 8 for the connection.

A monaural radio, tape recorder etc.

To AUDIO IN of VCR



RK-105A (optional)



To (audio output) LINE OUT, or MONITOR jack

A stereo tape recorder, amplifier etc.

To AUDIO IN of VCR



RK-74A (optional)

To LINE OUT (outputs)

A microphone

To MIC jack of VCR

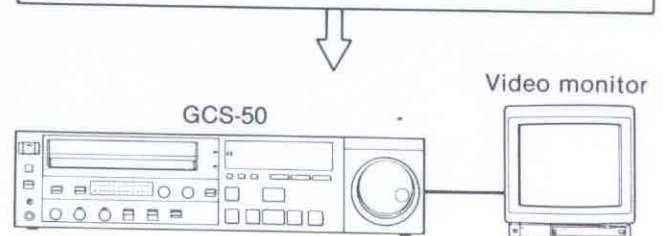
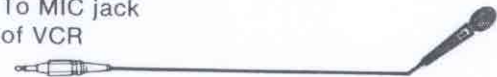

After the connection is made, set the switches on the VCR to the appropriate positions.

OPERATION —using the buttons on the VCR

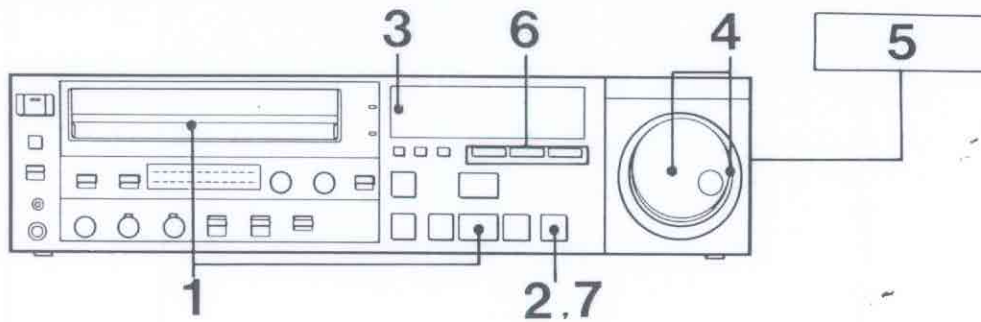

- 1 Play back the original tape. Make sure that the LOCAL button light is on. Set the HI-BAND switch to the same position as when the tape was recorded.
- 2 At the point where you want to end the insertion, press the PAUSE button.

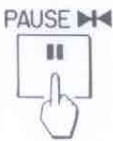

(If necessary, turn the JOG dial or the SHUTTLE ring to cue the point accurately.)

- 3 Press the RESET button. The time counter will be reset to "0h00m00s".
- 4 Turn the JOG dial or the SHUTTLE ring counterclockwise or press the REW button. At the point where you desire to begin the insertion, release the JOG dial or the REW button, or return the SHUTTLE ring to the center position.

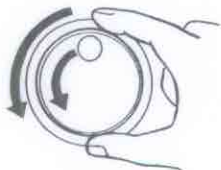

- 5 Turn on and play the audio and/or video source that have been connected.
- 6 Press one, two or all of the INSERT buttons and select the source to be inserted. The corresponding indicator(s) will light up.

If you press the INSERT button(s) or the STOP button after you have pressed one of the INSERT buttons, the sound will be muted for a moment.

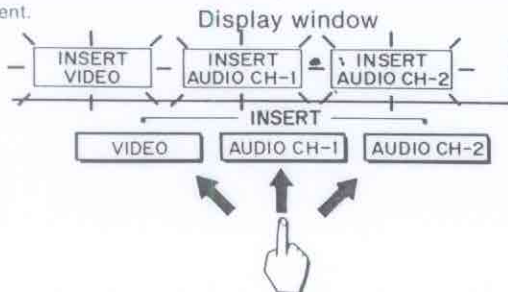

When these buttons are pressed, you will be able to monitor the sound and/or picture of the connected source.

- 7 Press the PAUSE button. The video and/or audio insertion will start.

When the time counter reaches 0h00m00s, the recording will stop.

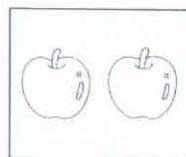

The picture of the connected video source will still be displayed even after the insertion ends.

Steps 2 through 7 can be controlled with the RM-E50 automatic editing controller if the LOCAL button light is not on. For details, read the instruction manual of the RM-E50.

Audio and/or video insertion can be made simply by stopping the playback with the PAUSE button and then repeating Steps 6 and 7. However, remember that the recording will stop at the point where the counter reads "0h00m00s".

To stop an insertion that has started, press the STOP button.

At this time the sound is muted for a moment.

Notes

- During the insertion, the PLAY, REW and FF buttons will not function.
- If a microphone is connected to the MIC jack, the sound from the microphone will always be recorded on the conventional audio track.
- If the safety tab has been removed, the CASSETTE IN indicator on the display window will blink when the INSERT buttons are pressed and the insertion cannot be made.
- The tape onto which an insertion is to be made must have a continuously recorded control track throughout the section where insertion is to be made. Otherwise, the picture of the edited tape will be snowy.

VIDEO HEAD CLEANING

If the video head becomes soiled with dust or magnetic particles, the S/N (signal-to-noise) ratio will drop and the picture and sound quality will be reduced. Since the head can be dirty even when it looks clean, it should be cleaned once every two or three months if the VCR is used frequently.

When the head has been used for about 1,000 hours, it should be checked by a qualified technician. For details, consult a Sony dealer or contact your nearest authorized service facility.

SPECIFICATIONS**System**

Video recording system	Rotary two-head helical scanning
Audio recording system	Beta hi-fi system (2 channels) (Recording on the conventional audio track is also stereo)
Video signal	EIA standard, NTSC color
Usable cassettes	Cassettes having the mark ⓑ ⓑIII : 1.33 cm/sec. (for playback only) ⓑII : 2.0 cm/sec. ⓑI : 4.0 cm/sec. (for playback only)
Maximum recording time	ⓑII : 3 hours (with a Sony L-750 cassette)
Fast-forward and rewind time	Approx. 3½ min. (L-500)
Audio frequency response	BETA HI-FI ON, MPX FILTER OFF ⓑII : 20–20,000 Hz
Wow and flutter	BETA HI-FI ON Less than 0.005% WRMS
Dynamic range	BETA HI-FI ON More than 80 dB

Inputs and outputs

Video input	VIDEO IN (BNC type) 1 V p-p ± 0.8 p-p, 75 ohms, unbalanced, sync negative
Video outputs	VIDEO OUT 1, 2 (BNC type) 1 V p-p ± 0.2 p-p, 75 ohms, unbalanced, sync negative
Audio inputs	AUDIO IN (CH-1, CH-2) (phono jacks) –10 dBs (0 dBs = 0.775 V rms), more than 47 k ohms
Audio outputs	AUDIO OUT 1, 2 (CH-1, CH-2) (phono jacks) –10 dBs (at load impedance 47 k ohms) more than 10 k ohms
Control jack	CONTROL L _F (5 pin)
Microphone input	MIC (minijack) –60 dBs, for low-impedance microphone
Headphones jack	HEADPHONES (stereo phone jack) –∞ to –20 dBs, 8 ohms

General

Power requirements	120 V ac $\pm 10\%$, 50/60 Hz $\pm 0.5\%$
Power consumption	55 W
AC outlet	Unswitched, max. 400 W
Operating temperature	5°C to 40°C (41°F to 104°F)
Storage temperature	-20°C to +60°C (-4°F to +140°F)
Dimensions	Approx. 430 × 105 × 458 mm (w/h/d) (17 × 4 $\frac{1}{4}$ × 18 inches)
Weight	incl. projecting parts and controls Approx. 12.1 kg (26 lb 11 oz) net

Accessories supplied

75-ohm coaxial cable with F-type connectors (2 m, 6 $\frac{1}{2}$ feet).....	1
(0.5m, 1 $\frac{1}{2}$ feet).....	1
Antenna switch ANS-34.....	1
Connector lock clasp.....	1

Design and specifications subject to change without notice.

RECOMMENDED VIDEO EQUIPMENT AND ACCESSORIES

Automatic editing controller	RM-E50
Color video monitor	PVM-1380
Video cleaning cassette	L-25CL
Audio shielded connecting cable (2 phono plugs to 2 phono plugs)	RK-74A
Audio connecting cable (miniplug to 2 phono plugs)	RK-105A
Audio/video connecting cable (3 phono plugs to 3 phono plugs)	VMC-2P3
Plug adaptor (BNC type connector to phono plug)	EAC-58
Rack mount adaptor (for mounting the unit in a 19-inch EIA standard rack)	RMM-50

TROUBLE CHECKS

If any difficulty should arise during operation, first check the power cord connection, and then proceed through the following list.

Should the difficulty persist, unplug the unit and contact the Sony dealer from whom this unit was purchased, or consult a local authorized Sony service facility.

	SYMPTOM	POSSIBLE CAUSES AND CORRECTIONS
POWER	POWER switch does not function.	<ul style="list-style-type: none"> ● Verify that the power cord is securely connected to the wall outlet. ● The safety device has been activated. Unplug the power cord; then connect it again.
	No picture during recording or playback.	<ul style="list-style-type: none"> ● Connect the video monitor firmly to the VCR.
RECORDING AND PLAYBACK	The displayed picture is not clear.	<ul style="list-style-type: none"> ● When you are not using a PCM processor, keep the MPX FIL selector set to the position other than PCM. ● The cassette being played back has been recorded on another VCR. Adjust the TRACKING NORM or SLOW control. ● The EDIT switch is set to EDIT. Set it to NORM.
	Noisy picture.	<ul style="list-style-type: none"> ● The video heads may be contaminated. Have the heads cleaned at the Sony service facility.
	The picture is distorted during Beta skipscan or during playback at 1/5 the normal speed.	<ul style="list-style-type: none"> ● The recording mode was switched when the tape was recorded. The distortion can be cleared up by playing back the tape once at normal speed.
	Distorted or noisy sound.	<ul style="list-style-type: none"> ● Adjust the recording level properly.
	Sound drop-outs on a tape recorded in the Beta hi-fi system.	<ul style="list-style-type: none"> ● The tape is defective. Use a new video cassette tape.
	No sound.	<ul style="list-style-type: none"> ● Incorrect setting of the AUDIO MONITOR selectors.
	No sound from the headphones.	<ul style="list-style-type: none"> ● The PHONE LEVEL control is set to 0.
	Stereo programs are heard in monaural.	<ul style="list-style-type: none"> ● Set the AUDIO MONITOR selector to CH-1/CH-2.
	The tape operation buttons do not activate.	<ul style="list-style-type: none"> ● The safety device has been activated. Unplug the power cord; then connect it again. ● Press the LOCAL button if it is not illuminated and set the unit in the local mode.
	Recording cannot be made.	<ul style="list-style-type: none"> ● The cassette's safety tab has been removed. Cover the slot with plastic tape.
OTHERS	The time counter does not operate even when the tape moves.	<ul style="list-style-type: none"> ● The tape is brand-new. ● The unrecorded portion of a tape is being played back.
	A cassette cannot be inserted.	<ul style="list-style-type: none"> ● Another cassette has already been inserted.
	The cassette cannot be ejected.	<ul style="list-style-type: none"> ● A recording is being made.
	A cassette is ejected as soon as it is inserted.	<ul style="list-style-type: none"> ● Moisture has condensed inside the unit. Wait until the DEW indicator stops blinking.
	The tape stops suddenly during operation.	<ul style="list-style-type: none"> ● The safety device which protects the video cassette tape and the recorder has been activated. Reactivate the previous tape transport mode.

Free Manuals Download Website

<http://myh66.com>

<http://usermanuals.us>

<http://www.somanuals.com>

<http://www.4manuals.cc>

<http://www.manual-lib.com>

<http://www.404manual.com>

<http://www.luxmanual.com>

<http://aubethermostatmanual.com>

Golf course search by state

<http://golfingnear.com>

Email search by domain

<http://emailbydomain.com>

Auto manuals search

<http://auto.somanuals.com>

TV manuals search

<http://tv.somanuals.com>