



Video Cassette Recorder

Operating Instructions

Owner's record

The model and serial numbers are located at the rear of the unit. Record these numbers in the spaces provided below. Refer to them whenever you call upon your Sony dealer regarding this product.

Model No. _____

Serial No. _____

SLV-998HF
SLV-998HF CS
SLV-998HF MX
SLV-998HF PX

© 1998 by Sony Corporation

WARNING

To prevent fire or shock hazard, do not expose the unit to rain or moisture.

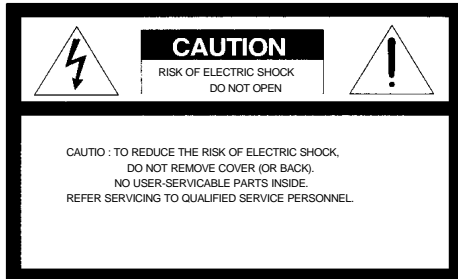

This symbol is intended to alert the user to the presence of unisolated "dangerous voltage" within the products enclosure that may be of sufficient magnitude to constitute a risk of electric shock to persons.



This symbol is intended to alert the user to the presence of important operating and maintenance (servicing) instructions in the literature accompanying the appliance.

CAUTION (SLV-998HF)

To prevent electric shock, do not use this polarized AC plug with an extension cord, receptacle or other outlet unless the blades can be fully inserted to prevent blade exposure.

WARNING

The AC power cord must be changed at a qualified service shop.

Precautions Safety

- * For SLV-998HF/998HF MX, operate the unit only on 120 V AC, 60 Hz. For SLV-998HF PX/998HF CS, operate the unit on 110 to 240 V AC, 50/60 Hz.
- * If anything falls into the cabinet, unplug the unit and have it checked by qualified personnel before operating it any further.
- * This unit is not disconnected from the AC power source (mains) as long as it is connected to the wall outlet, even if the unit itself has been turned off.
- * (SLV-998HF only) One blade of the plug is wider than the other for the purpose of safety and will fit into the power outlet only one way. If you are unable to insert the plug fully into the outlet, contact your Sony dealer.
- * Unplug the unit from the wall outlet if you do not intend to use it for an extended period of time. To disconnect the cord, pull it out by the plug, never the cord.

Installing

- * Allow adequate air circulation to prevent internal heat buildup.
- * Do not place unit on surfaces (rugs, blankets, etc.) or near materials (curtains, draperies) that may block the ventilation slots.
- * Do not install the unit near heat sources such as radiators or air ducts, or in a place subject to direct sunlight, excessive dust, mechanical vibration or shock.
- * Do not install the unit in an inclined position. It is designed to be operated in a horizontal position only.
- * Keep the unit and cassettes away from equipment with strong magnets, such as microwave ovens or large loudspeakers.
- * Do not place heavy objects on the unit.
- * If the unit is brought directly from a cold to a warm location, moisture may condense inside the VCR and cause damage to the video head and tape. When you first install the unit, or when you move it from a cold to a warm location, wait for about one hour before operating the unit.

Information

For customers in the USA (SLV-998HF/998HF PX)

You are cautioned that any changes or modifications not expressly approved in this manual could void your authority to operate this equipment.

This equipment has been tested and found to comply with the limits for a Class B digital device, pursuant to Part 15 of the FCC Rules. These limits are designed to provide reasonable protection against harmful interference in a residential installation. This equipment generates, uses, and can radiate radio frequency energy and, if not installed and used in accordance with the instructions, may cause harmful interference to radio communications. However, there is no guarantee that interference will not occur in a particular installation. If this equipment does cause harmful interference to radio or television reception, which can be determined by turning the equipment off and on, the user is encouraged to try to correct the interference by one or more of the following measures:

- * Reorient or relocate the receiving antenna.
- * Increase the separation between the equipment and receiver.
- * Connect the equipment into an outlet on a circuit different from that to which the receiver is connected.
- * Consult the dealer or an experienced radio/TV technician for help.

Caution

Television programs, films, video tapes and other materials may be copyrighted. Unauthorized recording of such material may be contrary to the provisions of the copyright laws. Also, use of this recorder with cable television transmission may require authorization from the cable television transmission and/or program owner.

Table of contents

Getting Started

- 4 Step 1: Unpacking
 - 5 Step 2: Setting up the remote commander
 - 8 Step 3: Hookups
 - 32 Selecting a language
 - 33 Setting the clock
 - 39 Setting up the cable box control
 - 44 Presetting the channels
 - 48 Setting up VCR Plus+*
-

Basic Operations

- 53 Playing a tape
- 55 Recording TV programs
- 59 Locating a channel by Station ID
- 60 Recording TV programs using VCR Plus+
- 63 Setting the timer manually

Additional Operations

- 66 Playing / searching at various speeds
- 69 Searching for a selected point on the tape
- 71 Skip searching automatically
- 72 Creating a favorite channel list with Station ID
- 74 Recording TV programs using the quick timer
- 75 Checking / changing / canceling timer settings
- 77 Recording stereo and bilingual programs

- 79 Searching using the index function
- 80 Adjusting the picture
- 81 Changing menu options

Editing

- 82 Editing methods
- 83 Hooking up to a VCR or stereo system
- 84 Basic editing
- 85 Insert editing

Additional Information

- 87 General setup information
- 89 Troubleshooting
- 92 Specifications
- 93 Index to parts and controls
- 98 Index
- back cover**
Quick reference to using the VCR

* VCR Plus+ and PlusCode are trademarks of Gemstar Development Corporation. VCR Plus+ system is manufactured under license from Gemstar Development Corporation

Step 1

Unpacking

Check that you have received the following items with the VCR:

Remote commander

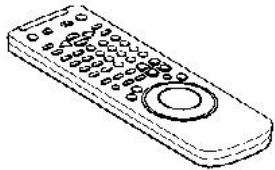

75-ohm coaxial cable with F-type connectors

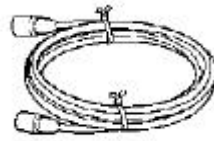

Size AA (R6) batteries

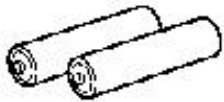

Jack cover



Audio / video cable (3-phono, 1 mini to 3-phono, 1 mini)

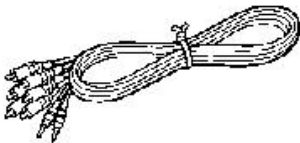

Plug adaptor (SLV-998HF PX/ 998HF CS only)

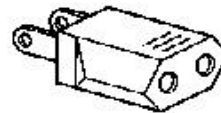

Cable Mouse (cable box controller)



Step 2

Setting up the remote commander

Inserting the batteries

Insert two size AA (R6) batteries by matching the + and - on the batteries to the diagram inside the battery compartment.

Insert the negative (-) end first, then push in and down until the positive (+) end clicks into position.

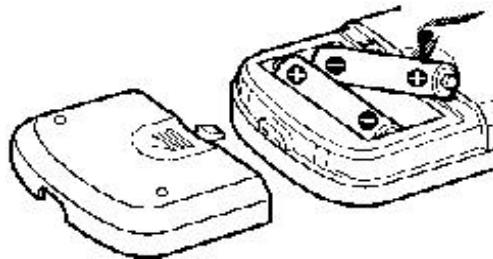

Using the remote commander

You can use this remote commander to operate this VCR and a Sony TV or AV receiver. Buttons on the remote commander marked with a dot can be used to operate your Sony TV.

The RECEIVER VOL +/- and MUTING buttons can be used to operate your Sony AV receiver.

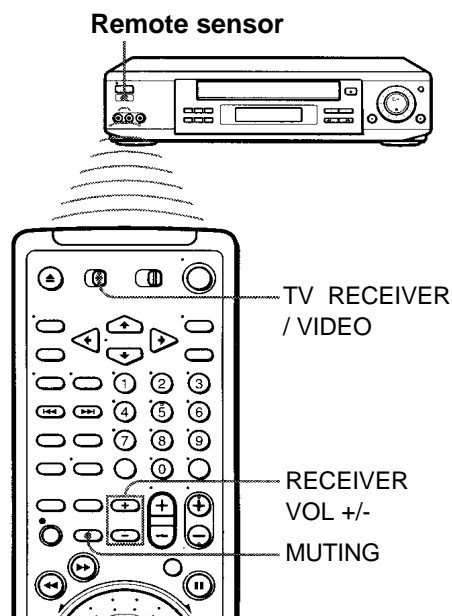

To operate	Set TV / RECEIVER / VIDEO to
the VCR	VIDEO and point at the remote sensor on the VCR
a Sony TV or AV receiver	TV / RECEIVER and point at the remote sensor on the TV or AV receiver

Notes

- * With normal use, the batteries should last about three to six months.
- * If you do not use the remote commander for an extended period of time, remove the batteries to avoid possible damage from battery leakage.
- * Do not use a new battery with an old one.
- * Do not use different types of batteries.
- * Some Sony AV receivers may not be operated with the remote commander.

continued

Setting the COMMAND MODE switch

To remotely control the VCR with the remote commander, set COMMAND MODE on the remote commander to the same position as that on the VCR. Usually set to VTR 3. Change the position as shown below to control other Sony VCR's:

- VTR 1** For Sony Betamax format VCR's
- VTR 2** For Sony 8mm format VCR's
- VTR 3** For Sony VHS format VCR's

To change the command mode position of the VCR, press and hold COMMAND MODE on the VCR for two seconds and repeat until the desired position appears in the display window.

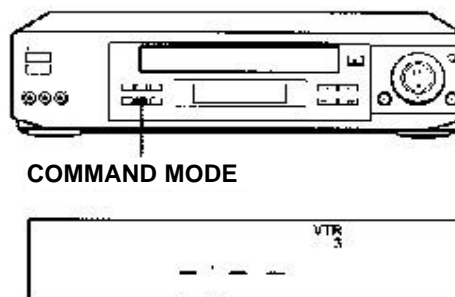
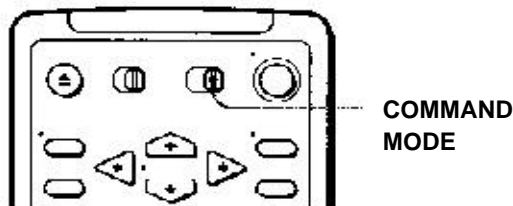

Controlling other TV's with the remote commander

The remote commander is preprogrammed to control non-Sony TV's. If your TV is listed in the table below, set the appropriate manufacturer's code number.

- 1** Set TV / RECEIVER / VIDEO at the top of the remote commander to TV / RECEIVER.
- 2** Hold POWER down, and enter your TV's code number(s) using the number buttons. Then release POWER.

Now you can use the POWER, VOL +/-, CH +/-, and TV / VIDEO buttons to control your TV. You can also use the buttons marked with a dot to control a Sony TV. To control the VCR, reset TV / RECEIVER / VIDEO to VIDEO.

Tip

If you set your TV's code number correctly while the TV is turned on, the TV turns off automatically.

Code numbers of controllable TVs

If more than one code number is listed, try entering them one at a time until you find the one that works with your TV.

Manufacturer	Code number
Sony	01
Akai	04
AOC	04
Centurion	12
Coronado	03
Curtis-Mathes	12
Daytron	12
Emerson	03,04,14
Fisher	11
General Electric	06,10
Gold Star	03,04,17
Hitachi	02,03
J.C.Penny	04,12

Manufacturer	Code number
JVC	09
KMC	03
Magnavox	03,08,12
Marantz	04,13
MGA/Mitsubishi	04,12,13,17
NEC	04,12
Panasonic	06,19
Philco	03,04
Philips	08
Pioneer	16
Portland	03
Quasar	06,18
Radio Shack	05,14

Manufacturer	Code number
RCA	04,10
Sampo	12
Sanyo	11
Scott	12
Sears	07,10,11
Sharp	03,05,18
Sylvania	08,12
Teknika	03,08,14
Toshiba	07
Wards	03,04,12
Yorx	12
Zenith	15

Notes

- * If the TV uses a different remote control system from the one programmed to work with the VCR, you cannot control your TV with the remote commander.
- * If you enter a new code number, the code number previously entered will be erased.
- * When you replace the batteries of the remote commander, the code number automatically resets to (01) Sony. Reset the appropriate code number.

Step 3

Hookups

Selecting the best hookup option

There are many ways in which your VCR can be hooked up. To hook up your VCR so that it works best for you, first scan through the table below. Then use the accompanying diagrams and procedures on the following pages to set up your VCR.

If you have	Use	Refer to
TV that has audio/video inputs	Audio/video (A/V) hookup , then follow one of the hookups below.	Pages 9 and 10
Cable box that is compatible with the VCR's cable box control feature	Hookup 1	Pages 11 to 13
No cable box or incompatible cable box with only a few scrambled channels	Hookup 2	Pages 14 to 16
Antenna only, no cable TV	Hookup 3	Pages 17 to 19
Incompatible cable box with many scrambled channels	Hookup 4	Pages 20 to 23
DSS* receiver	Hookup 5	Pages 24 to 26
Incompatible cable box with only a few scrambled channels, using an A/B switch	Hookup 6	Pages 27 to 31

After you've completed the connections, follow the instructions for setup. During setup, if you need more details on the procedure described, page numbers are provided where you can find complete, step by step instructions.

After you've completed the setup, you're ready to use your VCR. Procedures differ depending on the hookup you used. For an overview, refer to "Quick reference to using the VCR" on the back cover.

Before you get started

- * Turn off the power to all equipment.
- * Do not connect the AC power cords until all of the connections are completed.
- * Be sure you make connections firmly. Loose connections may cause picture distortion.
- * If your TV doesn't match any of the examples provided, see your nearest Sony dealer or qualified technician.

* DSS is a registered trademark of DIRECTV, Inc., a unit of Hughes Electronics Corporation.

If your TV has audio / video (A / V) input jacks, you will get a better picture and sound if you hook up your VCR using these connections. In addition, for a true "home theater" experience, you should connect the audio outputs of your VCR or TV to your stereo system. If your TV doesn't have A / V inputs, see the following pages for antenna or cable hookups.

If your TV has the S-Link™* (A / V bus control) function, hook up your VCR using the connection shown on page 10. Your TV will automatically switch to the A / V inputs for your VCR when you play back or operate menu on the VCR.

If you're not planning to use your VCR to record programs, you're finished setting up the VCR after you've made the connections shown on pages 9 and 10. If you want to record off-air or off your cable TV system, complete these connections first, then go to the following pages for antenna or cable hookups.

* S-Link™ is a trademark of Sony Corporation

A Use this hookup if your TV has stereo jacks

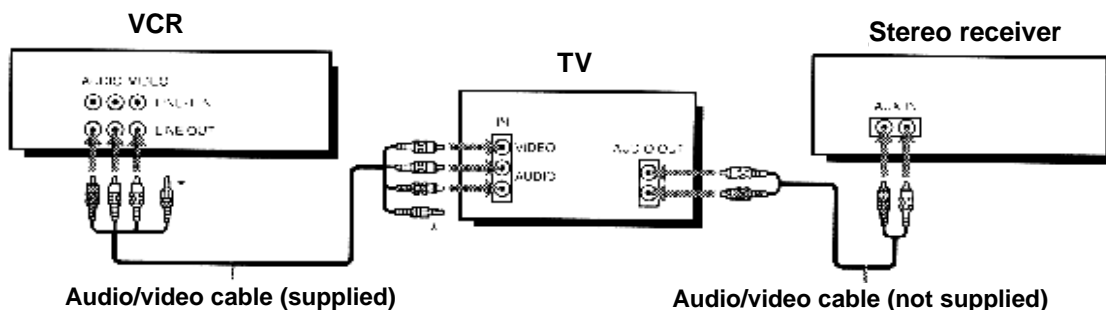

* Do not connect the miniplugs for this hookup.

B Use this hookup if your TV doesn't have stereo jacks

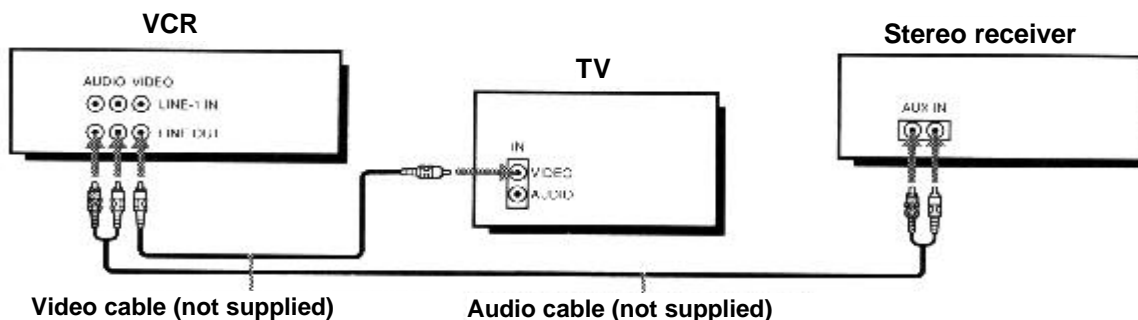

continued

Step 3: Hookups (continued)

C Use this hookup if your TV has the S-Link™ function

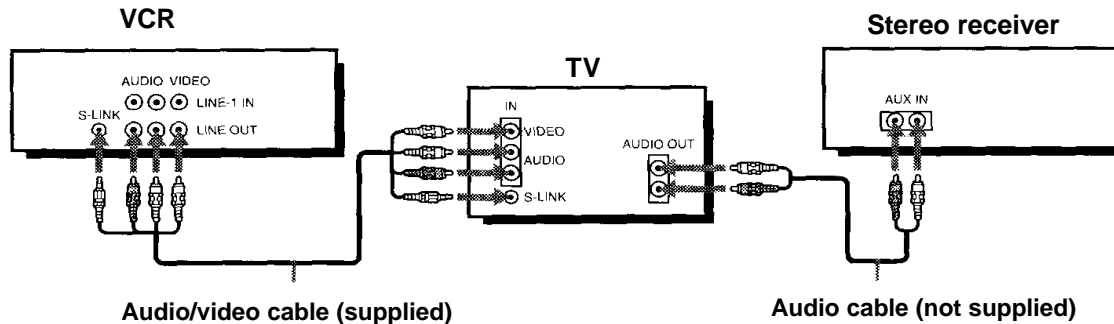

Note

* To play a tape in stereo, you must use the A / V connection.

A / V hookup: VCR setup

After you've connected your TV and completed antenna or cable hookup, use the following procedure to set up the VCR.

Press **MENU** and select **ADVANCED OPTIONS**.

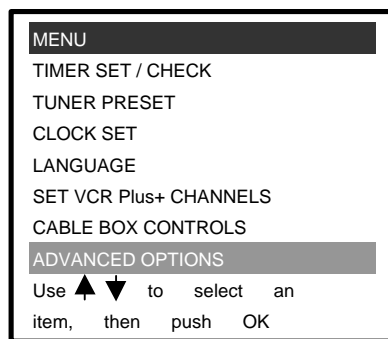

Set **Auto ANT SEL** to **OFF** and press **OK**.

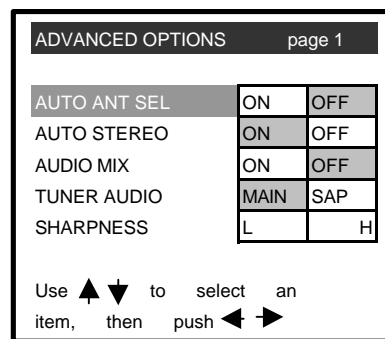

Caution

Connections between the VCR's VHF / UHF connector and the antenna terminals of the TV receiver should be made only as shown in the following instructions. Failure to do so may result in operation that violates the regulations of the Federal Communications Commission regarding the use and operation of RF devices. Never connect the output of the VCR to an antenna or make simultaneous (parallel) antenna and VCR connections at the antenna terminals of your receiver.

Note to CATV system installer (in USA)

This reminder is provided to call the CATV system installer's attention to Article 820-40 of the NEC that provides guidelines for proper grounding and, in particular, specifies that the cable ground shall be connected to the grounding system of the building, as close to the point of cable entry as practical.

Using cable box control

Recommended use

You should use this hookup if you have a cable box, especially if your cable system scrambles all or most of the channels. This hookup allows the VCR's cable box control feature to control the channel on the cable box, simplifying the recording process. A list of compatible cable boxes is on pages 40 and 41.

What you can do with this hookup

Record any channel using the VCR's cable box feature to select channels on the cable box

What you can't do

Record with the cable box turned off
 Record one channel while watching another channel

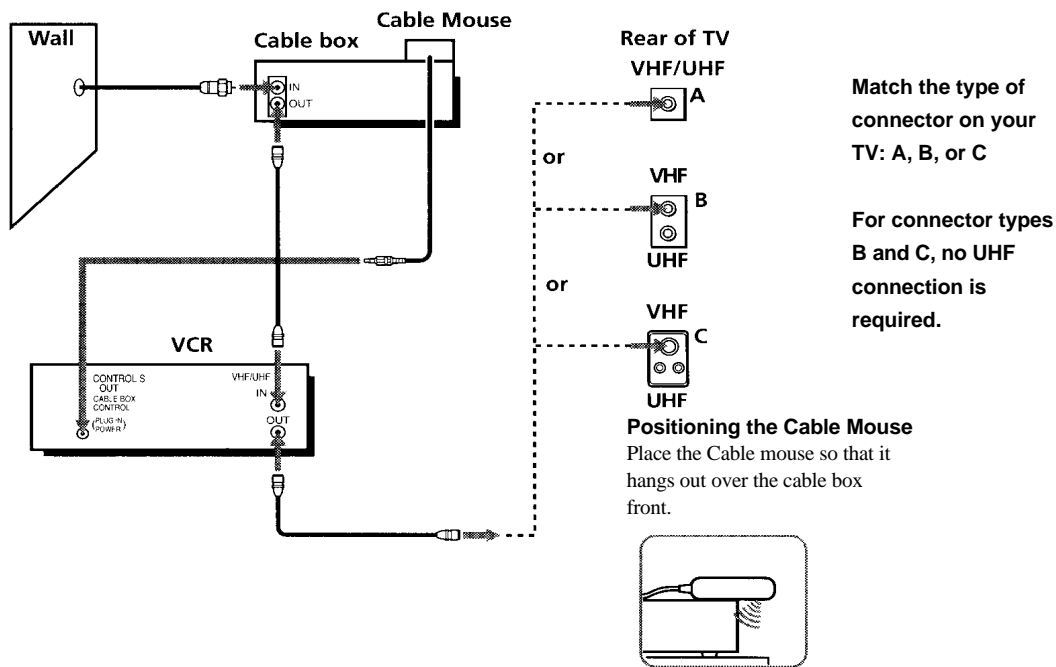

Step 3: Hookups (continued)

Hookup 1: VCR setup

- 1 Set the RF UNIT switch to CH 3 or CH 4, whichever channel is not used in your area. If both are used, set the switch to either channel. For details, see page 87. If you made A / V connections (from page 9), you can skip this step.
- 2 Turn on your cable box.
- 3 Press EASY SET UP on the VCR.
 - 1 The LANGUAGE menu appears. Change the on-screen display language to Spanish (ESPAÑOL) or French (FRANCAIS) if desired, and press OK. For details, see page 32.

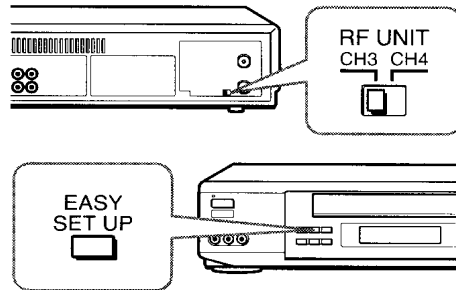

- 2 The CLOCK SET menu appears. Select AUTO and press OK. For details, see page 33

- 3 The SMART CH MAPPING menu appears. Press CURSOR \uparrow \downarrow \leftarrow \rightarrow to enter the ZIP / POSTAL CODE in your area and press OK. (You can also use the number buttons to enter the ZIP / POSTAL CODE.)

- 4 The CABLE BOX menu appears. Select ON. For details, see page 39.

- 5 Enter your cable box code number and press CURSOR \downarrow For details, see page 40.

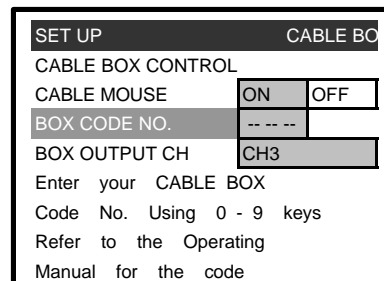
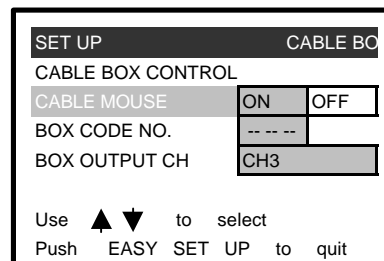
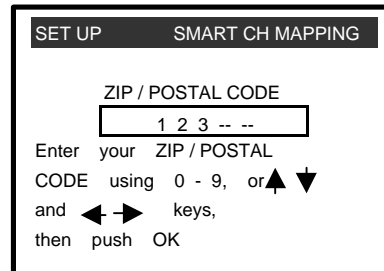
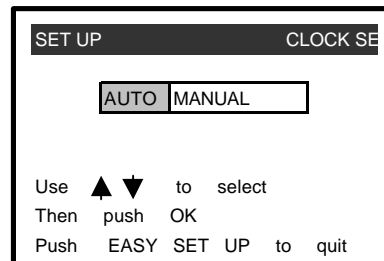
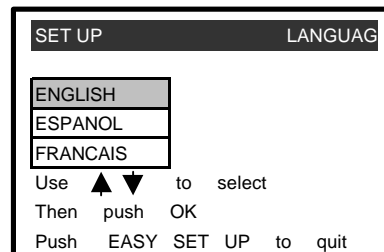

- 6** Select your cable box output channel and press OK.

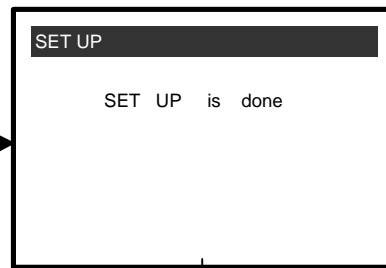
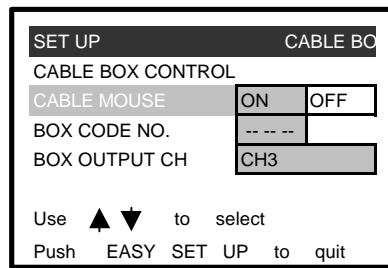

Normal display

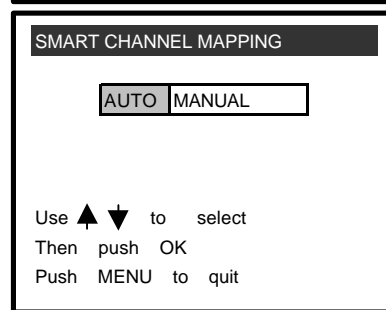
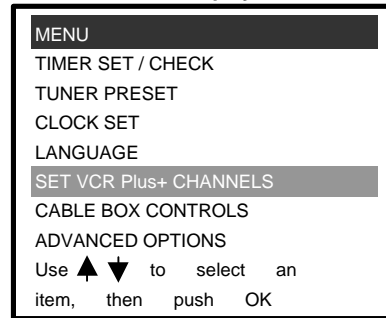

Hookup 1: VCR Plus+ channel setup

- 1** Press MENU and select SET VCR Plus+ CHANNELS.
- 2** Press CURSOR AUTO and press OK.
- 3** Press POWER to turn off the VCR.

The VCR receives the program information signal from 0:00 am to 5:00 am while the VCR is turned off, and set up the channel for VCR Plus+ recording. After channel setup is finished, you can record TV programs using VCR Plus+. For details, see page 49.

Notes

- * To use auto VCR Plus+ channel setup feature, leave the cable box on.
- * It takes about 1 hour to complete channel setup.
- * The VCR can receive the program information signal only while the VCR is turned off and no timer recordings are set.
- * If the channels in your area don't carry the program information signals, set the program guide channels manually. For details, see page 51.
- * If the Choose you Cable CH MAP menu appears the first time you turn on the VCR after finishing channel setup, select the MAP number. For details, see page 50.

Automatic clock setting

Once you've set up the VCR, it automatically sets the clock the first time you turn off the VCR. After that, whenever you turn off the VCR, it checks the time and adjusts the clock, even for Daylight Saving Time. The VCR sets the clock by picking up a time signal provided by some TV channels.

If you want to use the timer to record right away, or if the channels in your area do not carry time signals, set the clock manually. For details, see page 37.

Note

- * To use the automatic clock setting feature, leave the cable box on.

No cable box, or incompatible cable box with only a few scrambled channels

Recommended use

Use this hookup if you do not have a cable box. Also use this hookup if your cable company cannot supply a cable box that is compatible with the VCR's cable box control feature, and your cable system scrambles only a few channels.

What can you do with this hookup

- * Record any unscrambled channel by selecting the channel on the VCR

What you can't do

- * Record scrambled channels that require a cable box

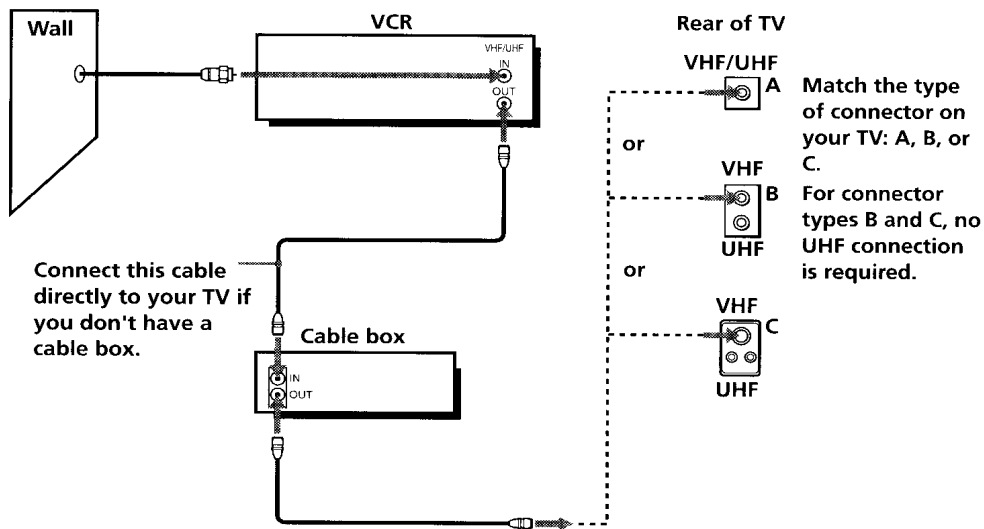

Hookup 2: VCR setup

- 1 Set the RF UNIT switch to CH 3 or CH 4, whichever channel is not used in your area. If both are used, set the switch to either channel. For details, see page 87. If you made A / V connections (from page 9), you can skip this step.
- 2 Press EASY SET UP on the VCR.

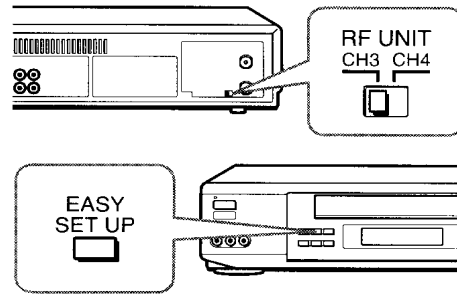

- 1 The LANGUAGE menu appears. Change the on-screen display language to Spanish (ESPAÑOL) or French (FRANCAIS) if desired and press OK. For details, see page 32.

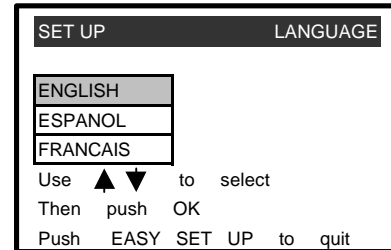

- 2 The CLOCK SET menu appears. Set AUTO and press OK. For details, see page 33.

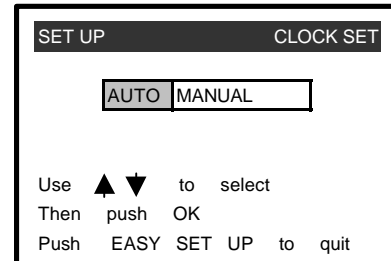

- 3 The SMART CH MAPPING menu appears. Press CURSOR ▲▼◀▶ to enter the ZIP / POSTAL CODE in your area and press OK. (You can also use the number buttons to enter the ZIP / POSTAL CODE.)

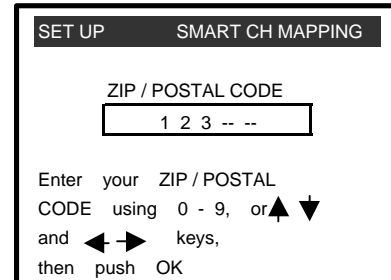

- 4 The CABLE BOX menu appears. Select OFF and press OK.

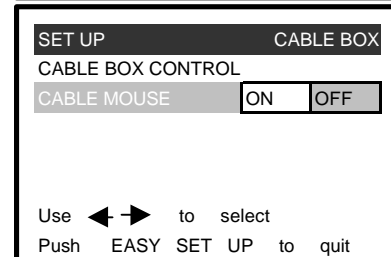

- 5 The TUNER PRESET menu appears. Set ANTENNA / CABLE to CABLE and press OK. For details, see page 44.

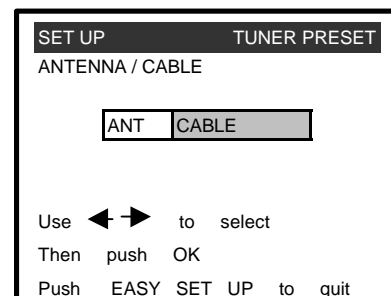

Step 3: Hookups (continued)

- 6 The AUTO PRESET starts.

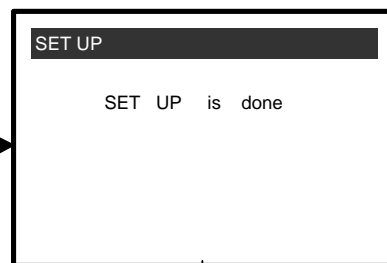
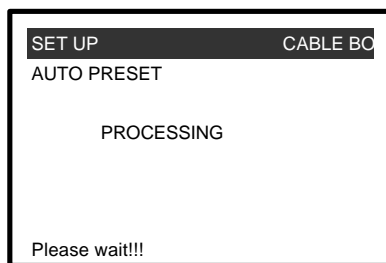

Normal display

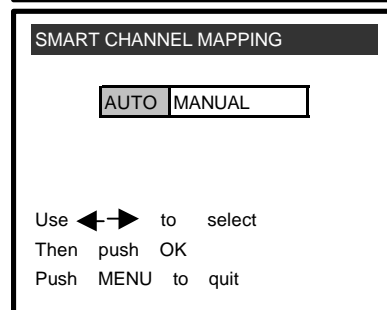
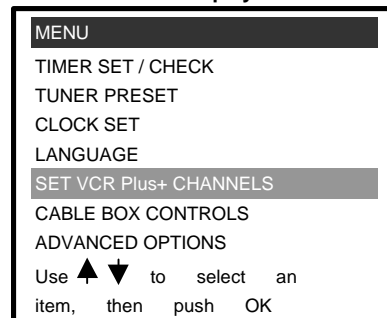

Hookup 2: VCR Plus+ channel setup

- 1 Press MENU and select SET VCR Plus+ CHANNELS.
- 2 Press CURSOR ← → to select AUTO and press OK.
- 3 Press POWER to turn off the VCR.

The VCR receives the program information signal from 0:00 am to 5:00 am while the VCR is turned off, and set up the channel for VCR Plus+ recording. After channel setup is finished, you can record TV programs using VCR Plus+. For details, see page 49.

Notes

- * It takes about 1 hour to complete channel setup.
- * The VCR can receive the program information signal only while the VCR is turned off and no timer recordings are set.
- * If the channels in your area don't carry the program information signals, set the program guide channels manually. For details, see page 51.
- * If the Choose you Cable CH MAP menu appears the first time you turn on the VCR after finishing channel setup, select the MAP number. For details, see page 50.

Automatic clock setting

Once you've set up the VCR, it automatically sets the clock the first time you turn off the VCR. After that, whenever you turn off the VCR, it checks the time and adjusts the clock, even for Daylight Saving Time. The VCR sets the clock by picking up a time signal provided by some TV channels.

If you want to use the timer to record right away, or if the channels in your area do not carry time signals, set the clock manually. For details, see page 37.

Antenna hookup

Make the following connections if you're using an antenna (if you don't have cable TV.)

A Use this hookup if you're using:

- * VHF / UHF antenna (you get channels 2-13 and channels 14 and higher)
- * UHF-only antenna (you get channels 14 and higher)
- * Separate VHF and UHF antennas

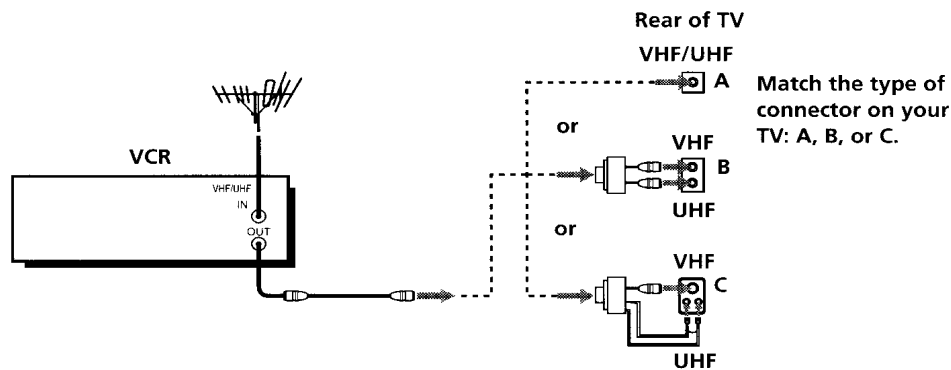

B Use this hookup if you're using a VHF-only antenna (you get channels 2-13 only)

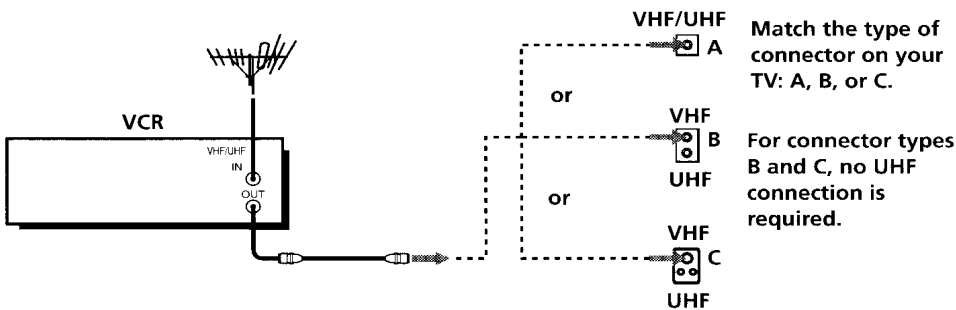

If you cannot connect your antenna cable to the VCR directly

If your antenna cable is a flat cable (300-ohm twin lead cable), attach an external antenna connector (not supplied) so you can connect the cable to the VHF / UHF IN connector. If you have separate cables for VHF and UHF antennas, you should use a U / V band mixer (not supplied). For details, see page 88.

Step 3: Hookups (continued)

Hookup 3: VCR setup

- 1 Set the RF UNIT switch to CH 3 or CH 4, whichever channel is not used in your area. If both are used, set the switch to either channel. For details, see page 87. If you made A / V connections (from page 9), you can skip this step.

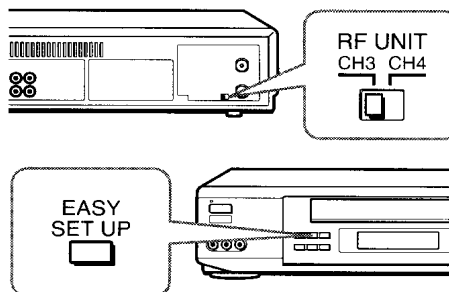

- 2 Press EASY SET UP on the VCR

- 1 The LANGUAGE menu appears. Change the on-screen display language to Spanish (ESPAÑOL) or French (FRANÇAIS) if desired, and press OK. For details, see page 32.

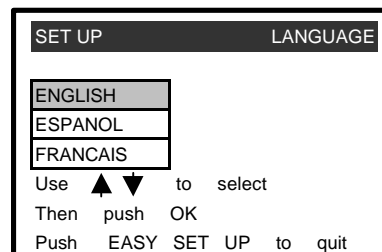

- 2 The CLOCK SET menu appears. Select AUTO and press OK. For details, see page 33.

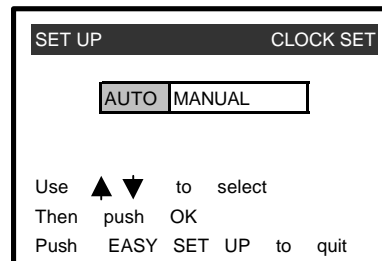

- 3 The SMART CH MAPPING menu appears. Press CURSOR ▲ ▼ ◀ ▶ to enter the ZIP / POSTAL CODE in your area and press OK. (You can also use the number buttons to enter the ZIP / POSTAL CODE.)

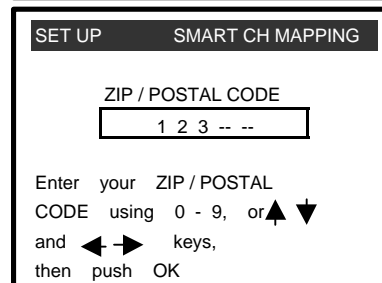

- 4 The CABLE BOX menu appears. Select OFF and press OK.

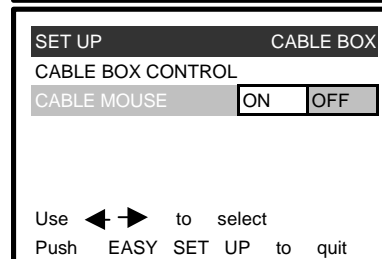

- 5 The TUNER PRESET menu appears. Set ANTENNA / CABLE to ANT and press OK. For details, see page 44.

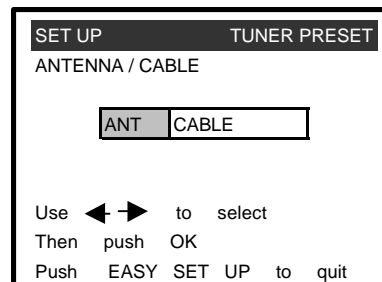

- 6** The AUTO PRESET starts.

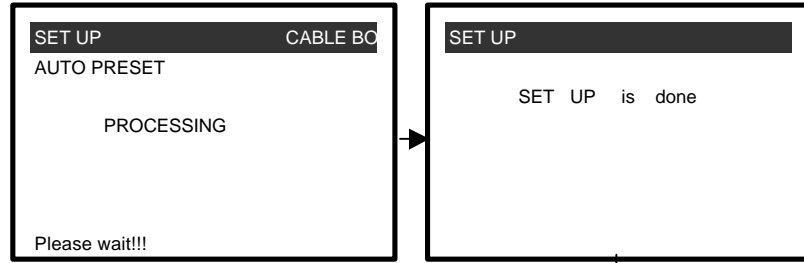

Hookup 3: VCR Plus+ channel setup

- 1 Press MENU and select SET VCR Plus+ CHANNELS.
- 2 Press CURSOR $\leftarrow \rightarrow$ to select AUTO and press OK.
- 3 Press POWER to turn off the VCR.

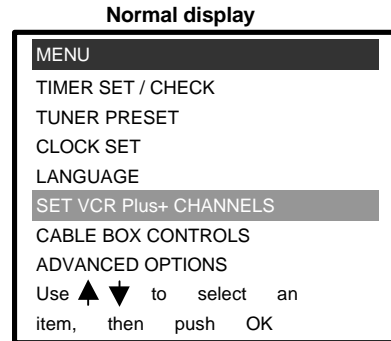

Normal display

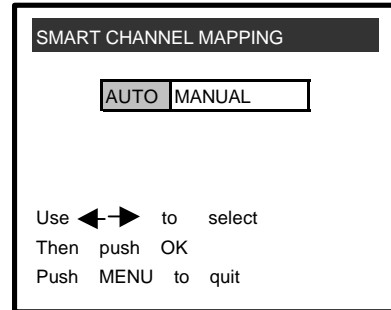

The VCR receives the program information signal from 0:00 am to 5:00 am while the VCR is turned off, and set up the channel for VCR Plus+ recording. After channel setup is finished, you can record TV programs using VCR Plus+. For details, see page 49.

Notes

- * It takes about 1 hour to complete channel setup.
- * The VCR can receive the program information signal only while the VCR is turned off and no timer recordings are set.
- * If the channels in your area don't carry the program information signals, set the program guide channels manually. For details, see page 51.
- * If the Choose your Cable CH MAP menu appears the first time you turn on the VCR after finishing channel setup, select the MAP number. For details, see page 50.

Automatic clock setting

Once you've set up the VCR, it automatically sets the clock the first time you turn off the VCR. After that, whenever you turn off the VCR, it checks the time and adjusts the clock, even for Daylight Saving Time. The VCR sets the clock by picking up a time signal provided by some TV channels.

If you do not want to use the timer to record right away, or if the channels in your area do not carry time signals, set the clock manually. For details, see page 37.

Incompatible cable box with many scrambled channels

Recommended use

Use this hookup if your cable company cannot supply a cable box that is compatible with the VCR's cable box control feature, and your cable system scrambles all or most channels.

What you can do with this hookup

- * Record any channel by selecting the channel on the cable box

What you can't do

- * Record with the cable box turned off
- * Record one channel while watching another channel
- * Select channels directly on the VCR

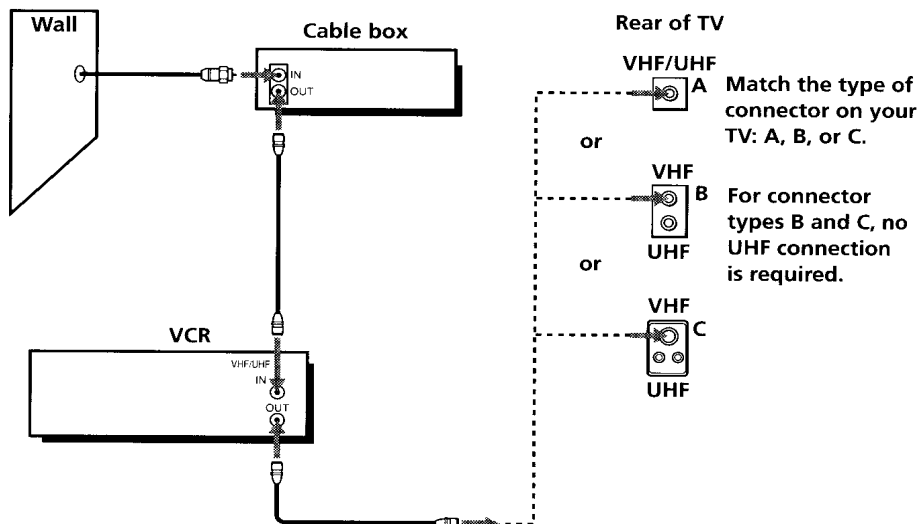

Hookup 4: VCR setup

- 1 Set the RF UNIT switch to CH 3 or CH 4, whichever channel is not used in your area. If both are used set the switch to either channel. For details, see page 87. If you made A / V connections (from page 9), you can skip this step.

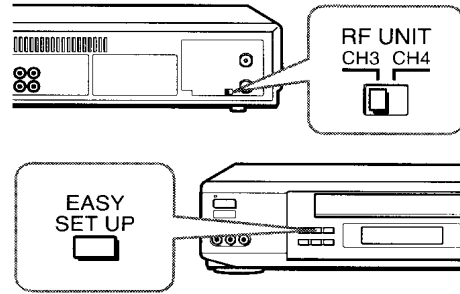

- 2 Turn on your cable box.
- 3 Press EASY SET UP on the VCR.

- 1 The LANGUAGE menu appears. Change the on-screen display language to Spanish (ESPAÑOL) or French (FRANÇAIS) if desired, and press OK. For details, see page 32.

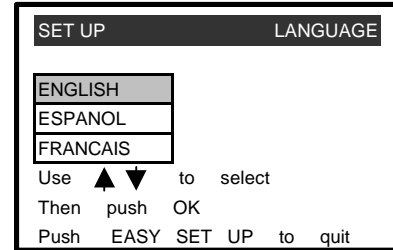

- 2 The CLOCK SET menu appears. Select MANUAL, press OK, and set the clock manually. For details, see page 37.

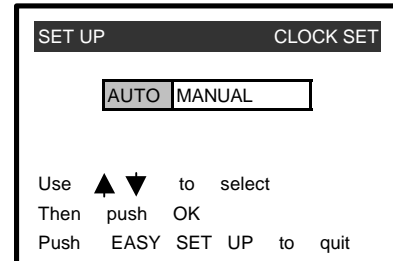

- 3 The SMART CH MAPPING menu appears. Press CURSOR to enter the ZIP / POSTAL CODE in your area and press OK. (You can also use the number buttons to enter the ZIP / POSTAL CODE.)

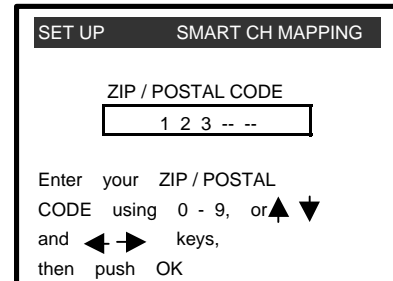

- 4 The CABLE BOX menu appears. Select OFF and press OK.

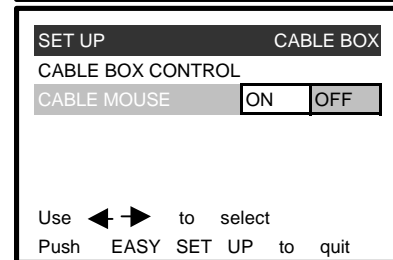

- 5 The TUNER PRESET menu appears. Set ANTENNA CABLE to ANT and press OK. For details, see page 44.

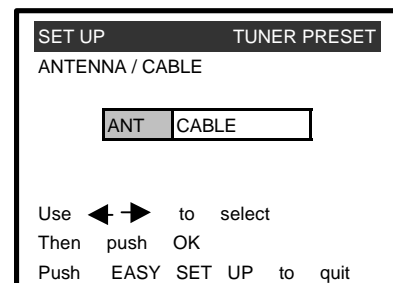

Step 3: Hookups (continued)

- 6 The AUTO PRESET starts.

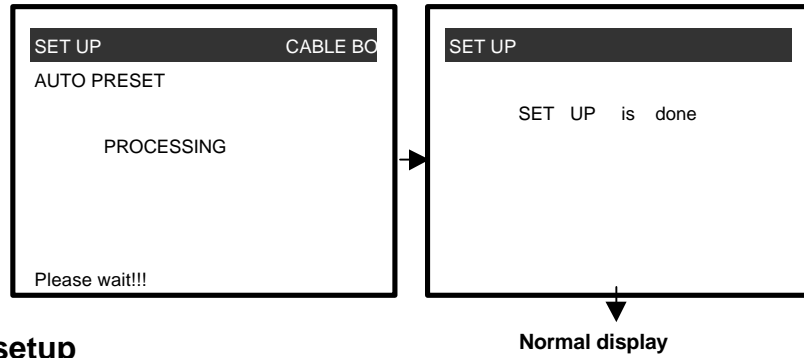

Hookup 4: VCR Plus+ channel setup

- 1 Find the VCR Plus+ Channel Listing in your program guide. For details, see page 48.
- 2 Enter all the channels you want to record and the cable box output channel (usually 2, 3 or 4). For details, see page 51.

- 1 Press MENU and select SET VCR Plus+ CHANNELS.

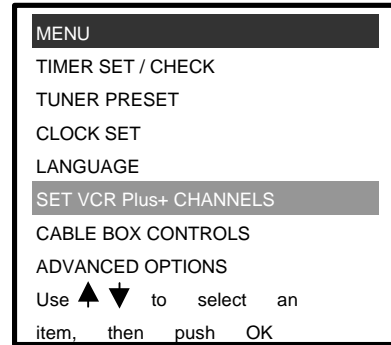

- 2 Press CURSOR \leftarrow \rightarrow to select MANUAL.

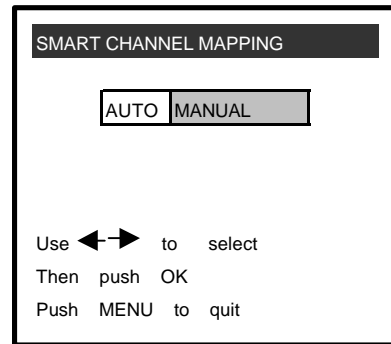

- 3 Enter the program guide channel, then the cable box output channel.

- 4 Press OK.

- 5 Press MENU.

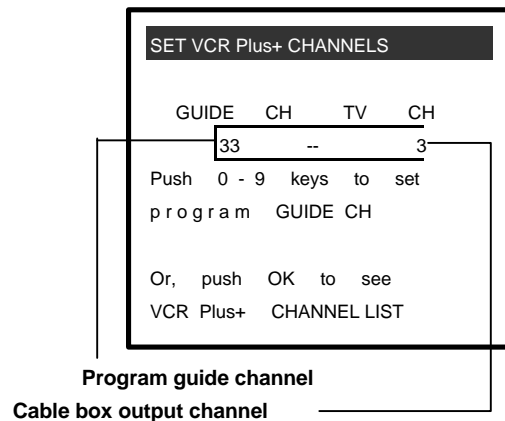

Automatic clock setting

To use the Auto Clock Set feature with this hookup, you need to manually select a channel that carries a time signal.

- 1** Tune the cable box to a channel that carries a time signal.
- 2** Select AUTO in the CLOCK SET menu to turn on the Auto Clock Set feature.
- 3** Turn off the VCR. It automatically sets the clock and adjusts for Daylight Saving Time by picking up the time signal.

If you want to use the timer to record right away, or if the channels in your area do not carry time signals, set the clock manually. For details, see page 37.

Note

- * To use the automatic clock setting feature, leave the cable box on.

continued

DSS (Digital Satellite System) receiver

Recommended Use

Use this hookup if you have a DSS receiver. It allows the VCR's cable box control feature to control the channel on the DSS receiver, simplifying the recording process. A list of compatible DSS receivers is on page 41.

DSS (Digital Satellite System) is a satellite broadcast that provides superior digital-quality video and crisp digital-quality audio. A variety of program packages are available through your program providers. It also has program guides that are sorted by program categories.

What you can do with this hookup

- * Record any channels using the VCR's cable box control feature to select channels on the DSS receiver.

What you can't do

- * Record with the DSS receiver turned off
- * Record any channels from cable or an antenna
(To record channels from cable or an antenna, turn off the cable box control feature.)
- * Use a cable box
- * Record programs with VCR Plus+

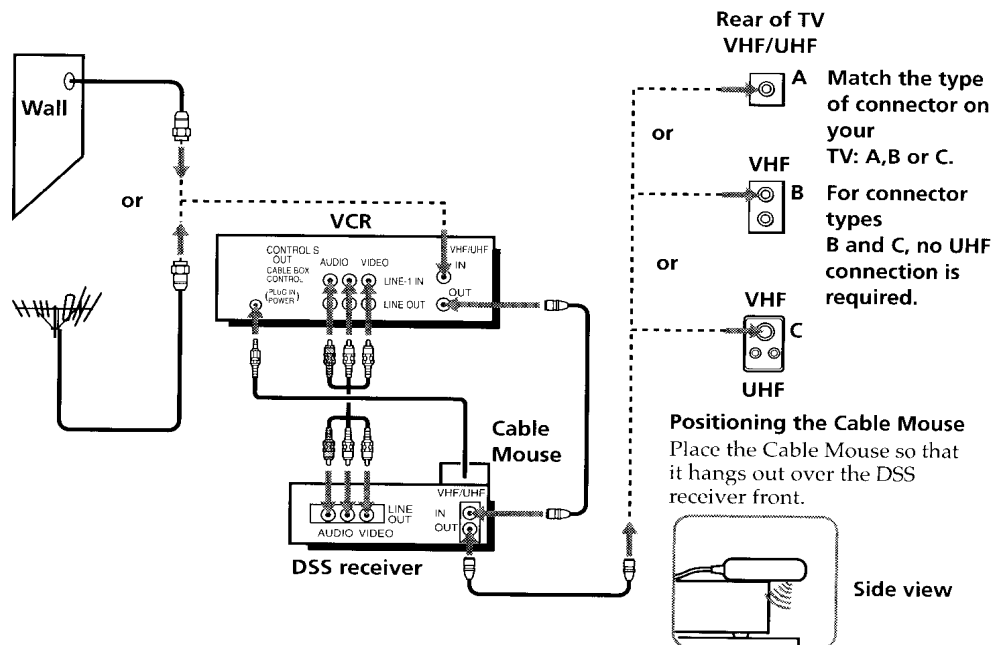

Hookup 5: VCR setup

- 1 Set the RF UNIT switch to CH 3 or CH 4, whichever channel is not used in your area. If both are used set the switch to either channel. For details, see page 87. If you made A / V connections (from page 9), you can skip this step.

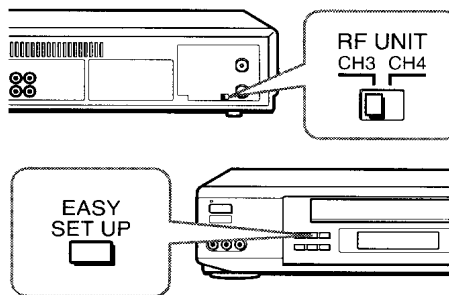

- 2 Turn on your DSS receiver.
- 3 Press EASY SET UP on the VCR.

- 1 The LANGUAGE menu appears. Change the on-screen display language to Spanish (ESPAÑOL) or French (FRANÇAIS) if desired, and press OK. For details, see page 32.

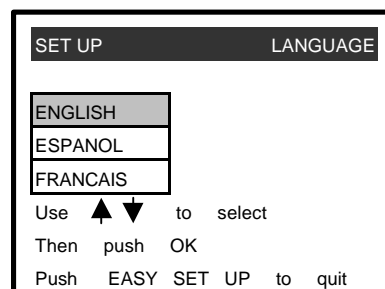

- 2 The CLOCK SET menu appears. Select AUTO and press OK. For details, see page 33.

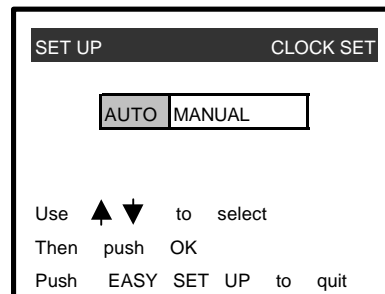

- 3 The SMART CH MAPPING menu appears. Press CURSOR ◀ ▶ to enter the ZIP / POSTAL CODE in your area and press OK. (You can also use the number buttons to enter the ZIP / POSTAL CODE.)

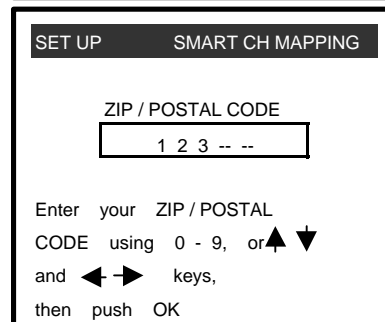

- 4 The CABLE BOX menu appears. Select ON. For details, see page 39.

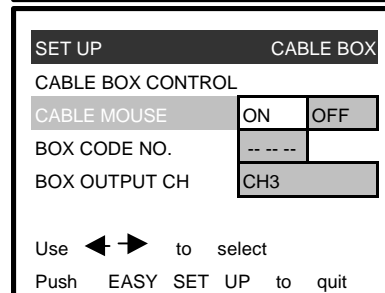

continued

Step 3: Hookups (continued)

- 5 Enter your DSS receiver code number and press CURSOR \blacktriangledown . For details, see page 40.

SET UP		CABLE BOX	
CABLE BOX CONTROL			
CABLE MOUSE	ON	OFF	
BOX CODE NO.	----		
BOX OUTPUT CH	CH3		
Enter your CABLE BOX			
Code No. Using 0 - 9 keys			
Refer to the Operating			
Manual for the Code			

- 6 Set your DSS receiver output channel (BOX OUTPUT CH) to LINE and press OK.

SET UP		CABLE BOX	
CABLE BOX CONTROL			
CABLE MOUSE	ON	OFF	
BOX CODE NO.	----		
BOX OUTPUT CH	CH3		
Use \leftarrow \rightarrow to select CABLE			
Box CH. Then push OK			

SET UP	
SET UP is done	

Normal display

Automatic clock setting

Once you've set up the VCR, it automatically sets the clock the first time you turn off the VCR. After that, whenever you turn off the VCR, it checks the time and adjusts the clock, even for Daylight Saving Time. The VCR sets the clock by picking up a time signal provided by some TV channels.

If you want to use the timer to record right away, or if the channels in your areas do not carry time signals, set the clock manually. For details, see page 37.

Note

* To successfully record a program from the DSS receiver, proceed as follows:

- Leave the DSS receiver on all the time.
- Turn off the display (menu screen, channel number, etc.) of the DSS receiver.
- To record or receiver locked channels, unlock the channel before the VCR starts recording.
- To set pay-per-view programs in the timer setting, order the pay-per-view program before the VCR starts recording.
- Some programs are copy protected. You cannot record these programs.

Incompatible cable box with only a few scrambled channels, using A/B switch

Recommended Use

By using an A / B switch (not supplied), this hookup allows you to record both scrambled and unscrambled channels conveniently.

What you can do with this hookup

- * Record any unscrambled channel by selecting the channel directly on the VCR (the A / B switch is set to A).
- * Record any scrambled channel by selecting the channel on the cable box (the A / B switch is set to B)

What you can't do

- * Record one scrambled channel while watching another channel (the A / B switch is set to B)

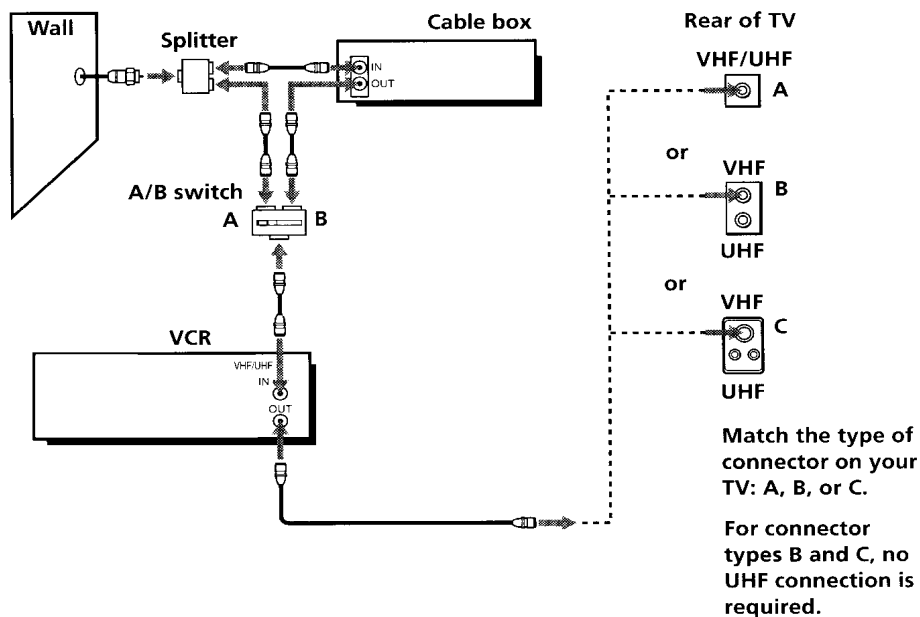

continued

Hookup 6: VCR setup

- 1 Set the RF UNIT switch to CH 3 or CH 4, whichever is not being used in your area. If both are used, set the switch to either channel. For details, see page 87. If you made A / V connections (from page 9), you can skip this step.
- 2 Set the A / B switch to "A."
- 3 Press EASY SET UP on the VCR.

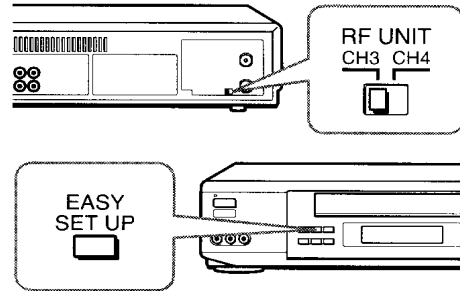

- 1 The LANGUAGE menu appears. Change the on-screen display language to Spanish (ESPAÑOL) or French (FRANÇAIS) if desired, and press OK. For details, see page 32.
- 2 The CLOCK SET menu appears. Select AUTO and press OK. For details, see page 33.

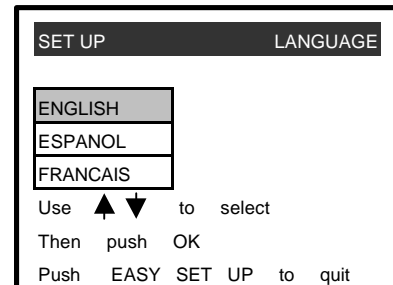

- 3 The SMART CH MAPPING menu appears. Press the CURSOR to enter the ZIP / POSTAL CODE in your area and press OK. (You can also use the number buttons to enter the ZIP / POSTAL CODE.)

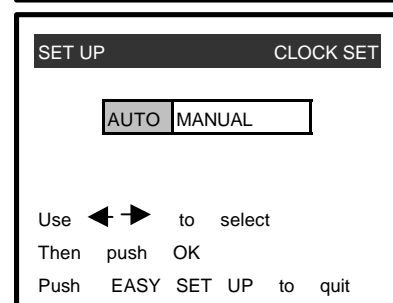

- 4 The CABLE BOX menu appears. Select OFF and press OK.

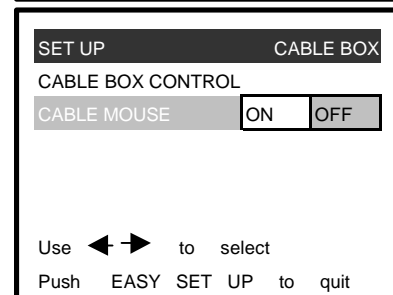
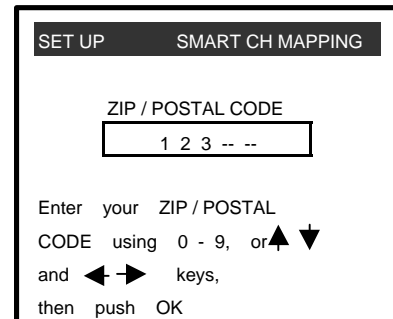

- 5 The TUNER PRESET menu appears. Set ANTENNA / CABLE to CABLE and press OK. For details, see page 44.

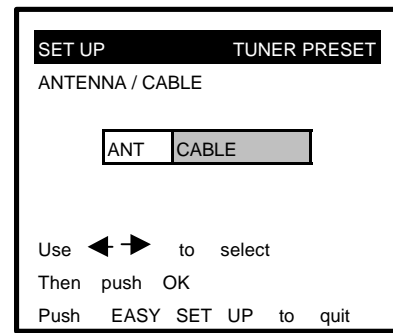

- 6 The AUTO PRESET starts.

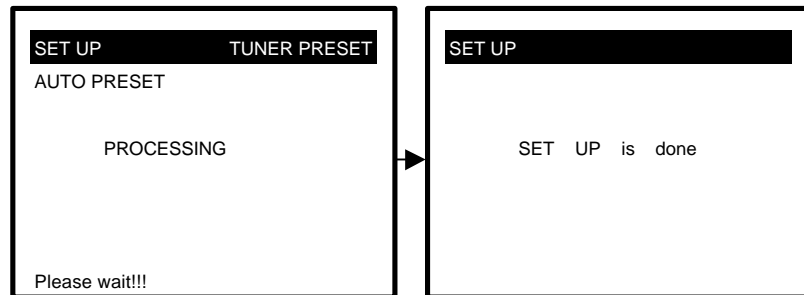

Normal display

- 4 Preset the cable box output channel (usually 2, 3, or 4). For details, see page 46.

- 1 Press MENU and select TUNER PRESET.

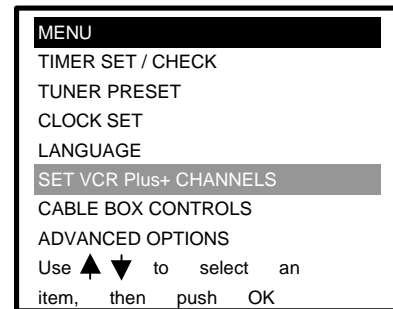

- 2 Enter the cable box output channel. Set MANUAL SET to ADD and press OK.

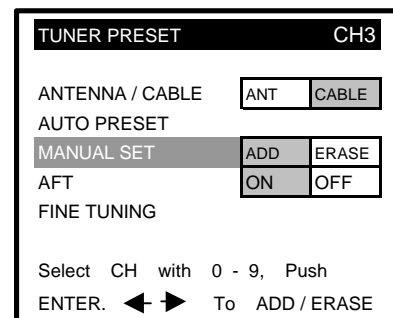

continued

Step 3: Hookups (continued)

Hookup 6: VCR Plus+ channel setup

- 1 Press MENU and select SET VCR Plus+ CHANNELS.
- 2 Press CURSOR to select AUTO and press OK.
- 3 Press POWER to turn off the VCR.

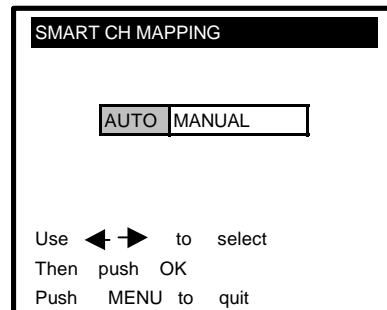
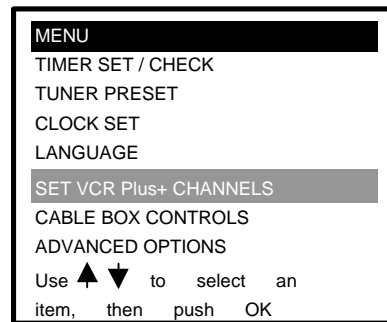

The VCR receives the program information signal from 0:00 am to 5:00 am while the VCR is turned off, and set up the channel for VCR Plus+ recording. After channel setup is finished, you can record TV programs using VCR Plus+. For details, see page 49.

Notes

- * To use the smart channel mapping feature, set the A / B switch to A.
- * It takes about 1 hour to complete channel setup.
- * The VCR can receive the program information signal only while the VCR is turned off and no timer recordings are set.
- * If the channels in your area don't carry the program information signals, set the program guide channels manually. For details, see page 51.
- * If the Choose your Cable CH MAP menu appears the first time you turn on the VCR after finishing channel setup, select the MAP number. For details, see page 50.

VCR Plus+ channel setup for scrambled channels

To set the program guide channels for scrambled channels, enter all the scrambled channels you want to record and the cable box output channel (usually 2, 3, or 4) after finishing smart channel mapping. For details, see page 51.

- 1 Find the VCR Plus+ Channel Listing in your program guide. For details, see page 48.
- 2 Press MENU and select SET VCR Plus+ CHANNELS then press OK.

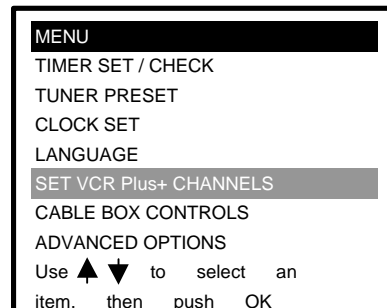

3 Press CURSOR \leftarrow \rightarrow to select MANAL

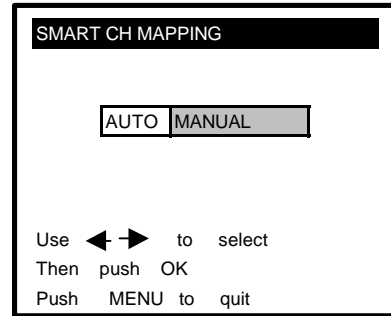

4 Enter the program guide channel, then the cable box output channel.

5 Press OK.

6 Press MENU.

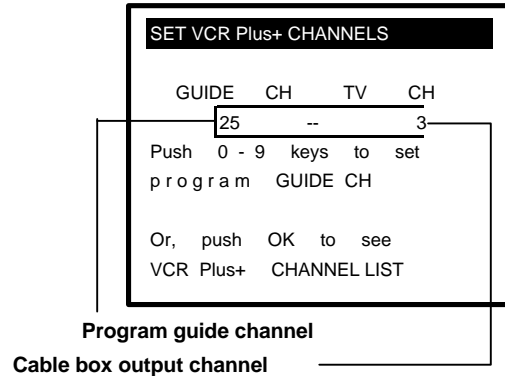

Automatic clock setting

Once you've set up the VCR, it automatically sets the clock the first time you turn off the VCR. After that, whenever you turn off the VCR, it checks the time and adjusts the clock, even for Daylight Saving Time. The VCR sets the clock by picking up a time signal provided by some TV channels.

If you want to use the timer to record right away, or if the channels in your area do not carry time signals, set the clock manually. For details, see page 37.

Note

* To use the automatic clock setting feature, set the A / B switch to A.

Selecting a language

You can change the on-screen display language.

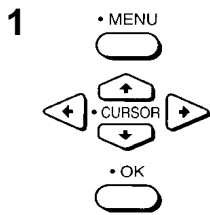
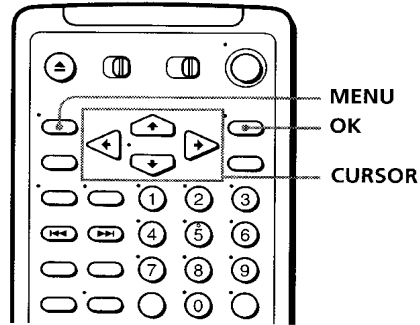

Press MENU, then press CURSOR \blacktriangle \blacktriangledown to move the cursor to LANGUAGE and press OK.
When using the EASY SET UP procedure, skip this step.

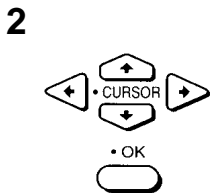
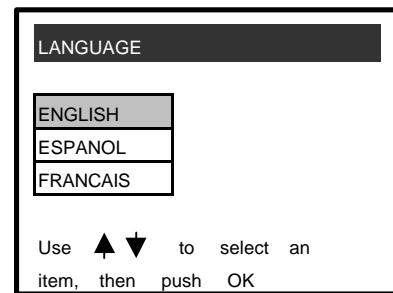

Press CURSOR \blacktriangle \blacktriangledown to select ENGLISH, ESPANOL, or FRANCAIS, then press OK.

Setting the clock

Using the Auto Clock Set feature

Some TV and cable channels transmit time signals with their broadcasts. Your VCR can pick up this time signal to automatically set the clock.

The Auto Clock Set feature works only if a channel in your area is broadcasting a time signal. If broadcasters in your area are not yet sending time signals, set the time manually (page 37).

Before you start....

- * Turn on the VCR and the TV.
- * Set the TV to the VCR channel (channel 3 or 4). If your TV is connected to the VCR using A / V connections, set the TV to video input.
- * Press TV / VIDEO to display the VIDEO indicator in the VCR's display window.
- * Press INPUT SELECT so that a channel number appears in the VCR's display window.

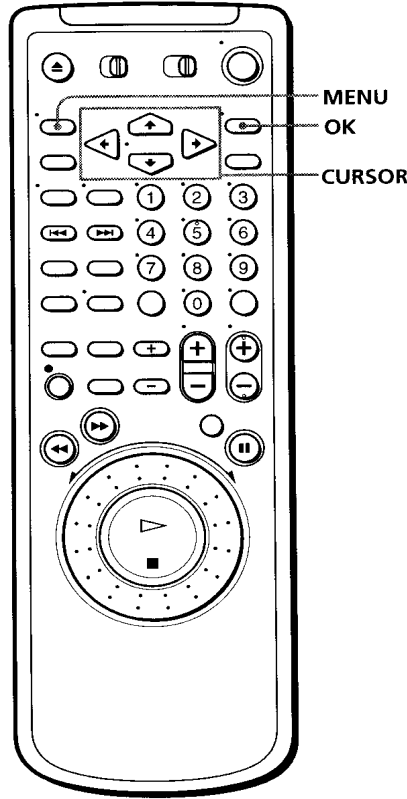

- 1**
- MENU
- CURSOR
- OK
- Press MENU, then press CURSOR \blacktriangle \blacktriangledown to move the cursor to CLOCK SET and press OK.
- When using the EASY SET UP procedure, skip this step.

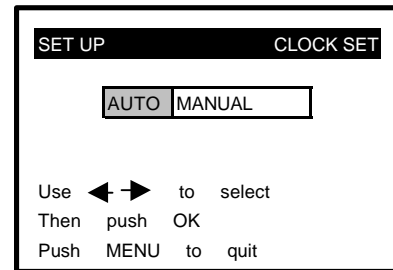

- 2**
- CURSOR
- OK
- Press CURSOR \leftarrow \rightarrow to select AUTO, then press OK.

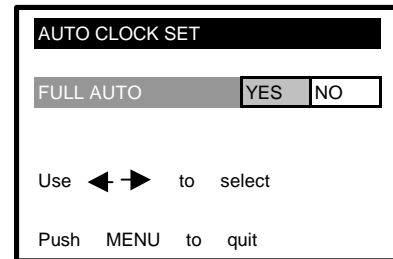

continued

Setting the clock (continued)

3

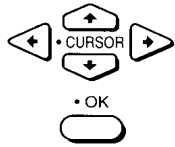

Press CURSOR ◀ ▶ to select YES, then press OK.

4

To activate the Auto Clock Set function, turn off the VCR.

The VCR automatically sets the clock by searching for a channel that carries a time signal and sets your time zone and Daylight Saving Time (if applicable).

If your clock is set to the wrong time zone or Daylight Saving Time, you can adjust these settings without turning off the Auto Clock Set feature (page 35).

Notes

- * The clock cannot be set automatically if you don't receive a channel that carries a time signal in your area. If so, set the clock manually.
- * If there are only a few channels in your area that carry time signals, setting the clock automatically may take up to about 30 minutes. If nothing happens even after you wait about 30 minutes, set the clock manually.
- * If you use Hookup 1, make sure you leave the cable box on.

If the clock is not activated

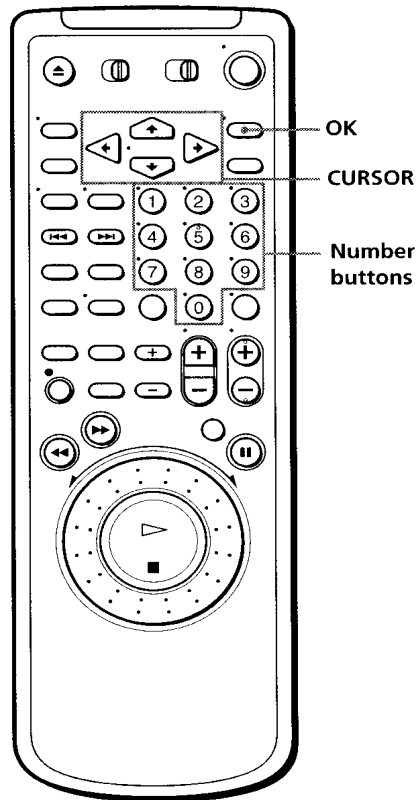

1

Follow steps 1 and 2 in "Using the Auto Clock Set feature."
The AUTO CLOCK SET menu is displayed.

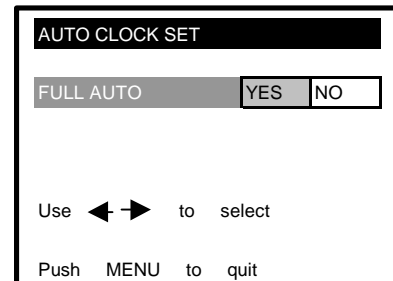

2

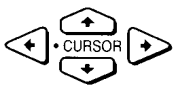

Press CURSOR ← → to select NO for
FULL AUTO.

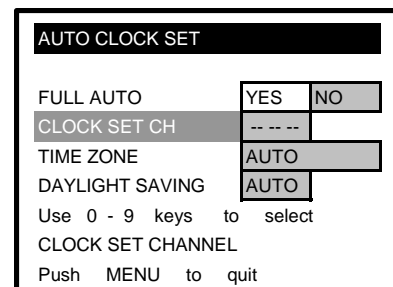

continued

Setting the clock (continued)

3



Press the CURSOR \uparrow \downarrow to highlight the item you want to set, then press CURSOR \leftarrow \rightarrow to make the setting.

* For CLOCK SET CH
Leave the setting to "____" to have the VCR automatically search for a channel that carries a time signal.

Press the number buttons to select a channel that carries a time signal.

Use this option if you know of a channel that carries a time signal. Most PBS member stations broadcast a time signal. For the fastest response, select your local PBS station.

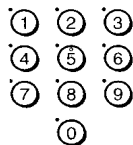

* For TIME ZONE
Select the time zone of your area, or select AUTO to have the VCR automatically set your time zone.
The options are: AUTO \rightarrow ATLANTIC
 \rightarrow EASTERN \rightarrow CENTRAL \rightarrow
MOUNTAIN \rightarrow PACIFIC \rightarrow ALASKA
 \rightarrow HAWAII \rightarrow AUTO

* For DAYLIGHT SAVING
Select ON or OFF (standard time), or AUTO to have the VCR automatically set the daylight saving time.

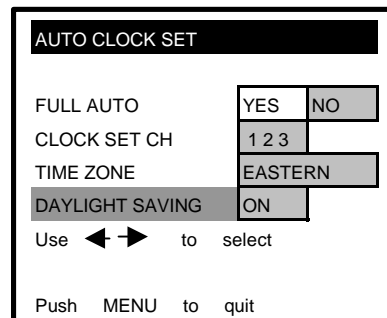

4



Press OK.

5

To activate the Auto Clock Set function, turn off the VCR.

Note

- * If you use both the cable box control feature and the Auto Clock Set feature, the VCR automatically changes channels on the cable box until a channel that carries a time signal is found, whenever you turn off the VCR.

If you want to stop the search, change the channel on the cable box with the channel buttons either on the VCR or on the remote commander.

Using Manual Clock Set

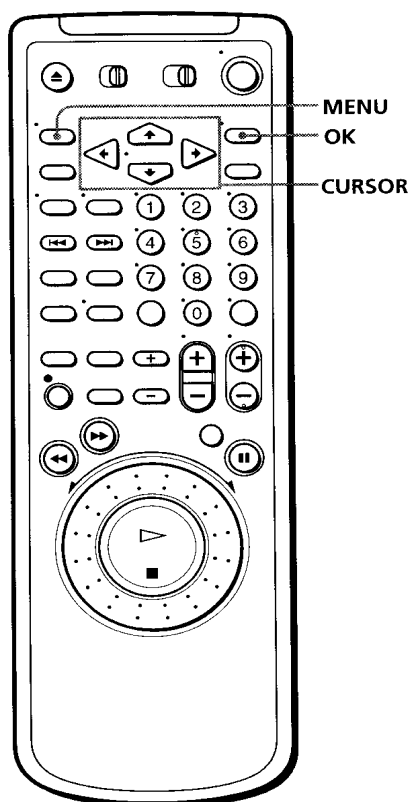

- 1** Press MENU, then press CURSOR $\uparrow \downarrow$ to move the cursor to CLOCK SET and press OK.

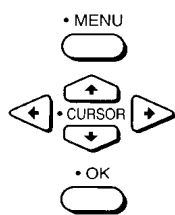

When using the EASY SET UP procedure, skip this step.

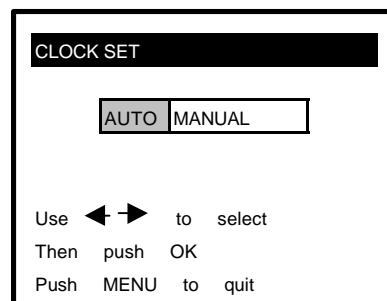

- 2** Press CURSOR $\leftarrow \rightarrow$ to select MANUAL, then press OK.

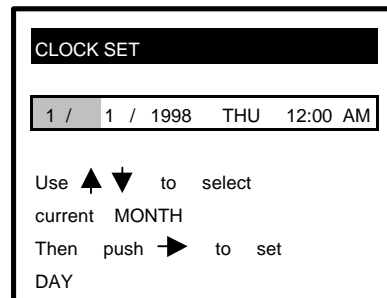
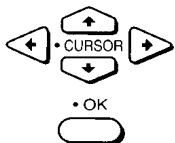

continued

Setting the clock (continued)

- 3 Press CURSOR ▲ ▼ to set the month.

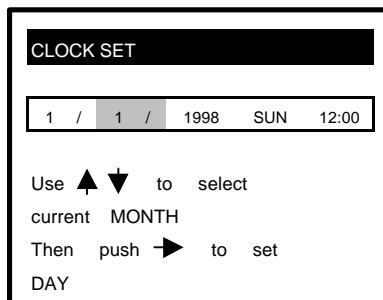

- 4 Press CURSOR ► to highlight the day and press CURSOR ▲ ▼ to set the day.

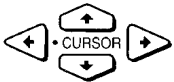

The day of the week is set automatically.

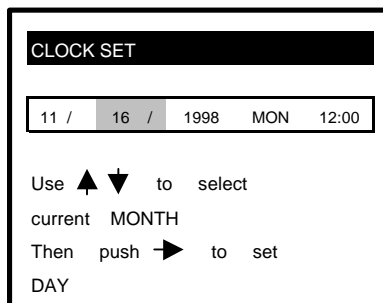

- 5 Set the year, hour and minutes in the same way as the day.



- 6 Press OK to start the clock.



Setting up cable box control

(Skip this section if you are using Hookup 2, 3, 4, or 6.)

Your VCR includes a cable box control feature that allows the VCR to control most brands of cable boxes / DSS receivers via the CABLE Mouse. With cable box control, the VCR controls channels on the cable box / DSS receiver for timer recording. You can also use the VCR's remote commander to change channels on the cable box / DSS receiver whenever the cable box / DSS receiver is turned on even if the VCR is turned off. To use the cable box control, you need to connect the Cable Mouse (pages 11 and 24) and set the code number and output channel.

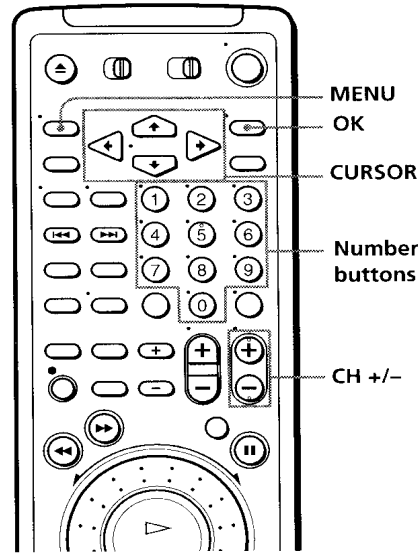

This VCR is programmed with codes necessary to control channel selection on most brands of cable boxes at the time this VCR was manufactured. It is possible that new cable boxes may be introduced that cannot be controlled with this VCR's Cable Mouse. If you have a cable box that is incompatible with this VCR, contact your cable operator - they may be able to provide you with a compatible cable box.

- 1
- MENU
 - CURSOR
 - OK
- Press MENU, then press CURSOR $\blacktriangle \blacktriangledown$ to move the cursor to CABLE BOX CONTROL and press OK.
- When using the EASY SET UP procedure, skip this step.

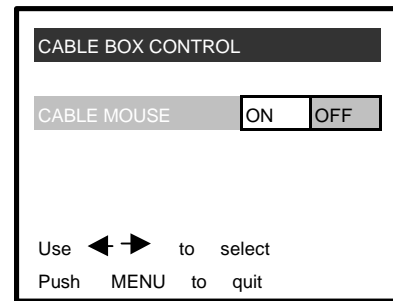

- 2
- CURSOR
- Press CURSOR $\blacktriangleleft \blacktriangleright$ to select ON, then press CURSOR \blacktriangledown .

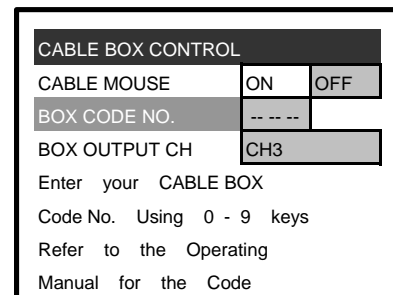

continued

Setting up cable box control (continued)

3

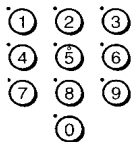

Press the number buttons to enter the cable box / DSS receiver code number, then press CURSOR ▼.

Find your cable box / DSS receiver code number from the chart below.



CABLE BOX CONTROL		
CABLE MOUSE	ON	OFF
BOX CODE NO.	123	
BOX OUTPUT CH	CH3	

Use ← → to select CABLE BOX CH. Then push OK

4

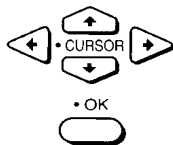

If you want to control a cable box, press CURSOR ← → to select the output channel for the cable box, then press OK.

If you want to control a DSS receiver, select LINE, then press OK.

Cable box and DSS receiver brand and the corresponding code numbers

If more than one code number is listed, try entering them one by one, until you come to the correct code for your equipment.

Cable box brand	Code numbers
ABC	018, 022, 024, 028, 217
Antronix	218
Archer	033, 050, 164, 218, 808
BBT	278
Cable Star	067
Cabletenna	033
Cable time	172, 388, 459
Century	164
Citizen	164, 326, 327
Clyde Cablevision	097
Colour Voice	036, 042
Comband	243, 244
Comtronics	051, 071
Decsat	434
Diamond	046
Eagle Comtronics	051

Cable box brand	Code numbers
Eastern	013, 285
Electricord	089
Electus	055
Focus	411
Garrard	164
GC Electronics	027, 067, 341
GE	243, 244
GEC	097
Gemini	026, 068, 081
General Instrument	022, 287, 487
Hamlin	020, 031, 045, 270, 284
Hitachi	022
Jasco	164, 326
Jerrold	014, 022, 025, 026, 035, 037
	058, 109, 287, 487
Linsay	451

Cable box	Code numbers
Macom	044
Magnavox	038, 043, 080
Memorex	011
Movie Time	089, 167, 214
Northcoast	325
Novaplex	629
NSC	074, 081, 167, 214
Oak	018, 030, 259
Panasonic	032, 118
Paragon	011
Phillips	036, 038, 039, 040, 041, 042, 071, 301
Pioneer	034, 155, 271, 544, 695
Popular Mechanics	411
Pulsar	011
Radio Shack	808
RCA	032
Realistic	218
Recoton	411
Regal	031, 270, 284, 290
Regency	013
Rembrandt	081
Samsung	051, 155
Scientific Atlanta	017, 019, 028, 288
Seam	521
Sharp	324
Signal	051
Signature	022
SL Marx	051
Spectravision	069
Sprucer	032, 318
Standard Components	107, 166
Starcom	014, 026, 058, 109
Stargate	026, 051

Cable box	Code numbers
STS	167
Sylvania	012
T-Cable Teletext	116
Tandy	269
Tatung	108
Teknica	157
TeleCaption	232
Teleservice	292
Texscan	012, 107
TFC	321
Timeless	429
Tocom	023, 024
Toshiba	011
Tudi	297
TV86	074
TV COM	018, 030, 259
Uniden	236
Unika	033, 164, 218
United Artists	018
United Cable	014
Universal	033, 050, 067, 088, 089, 164, 202, 218, 333
Videoway	261
Vidtech	255
Viewstar	038, 071, 074, 122, 222, 269, 300
Zenith	411
Zentek	576
Wave Master	
DSS receiver	Code numbers
brand	
RCA	577
Sony	650

continued

To ensure correct operation

- * Place the Cable Mouse so that it hangs out over the cable box / DSS receiver front.
- * Do not place the cable box / DSS receiver on top of the VCR.
- * Position the cable box / DSS receiver away from the VCR.
- * Point the remote commander at the VCR, not at the cable box / DSS receiver.

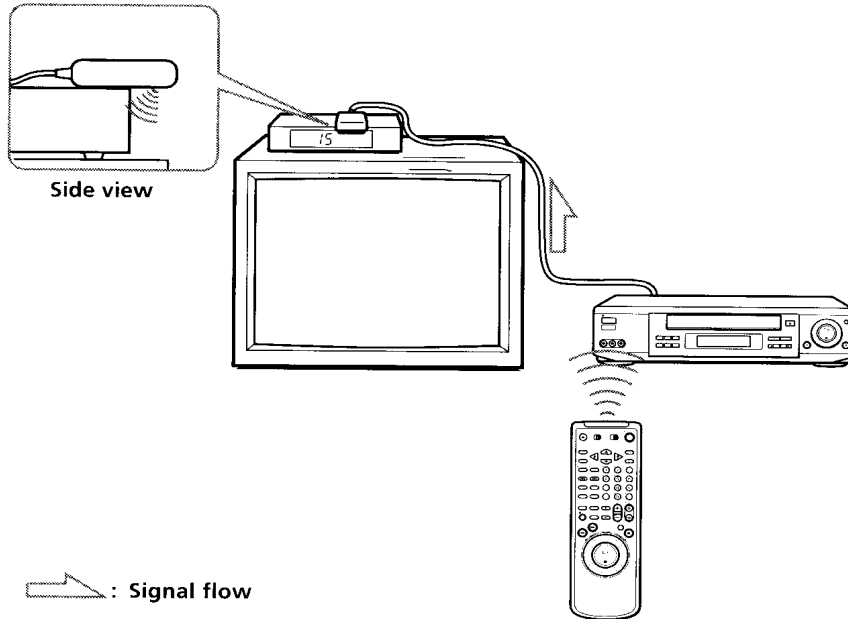

To check the cable box control setting

- 1** Press CH + / - on the remote commander. Does the channel indicator on the cable box / DSS receiver change? (Point the remote commander at the VCR, not at the cable box / DSS receiver.)

- 2** Press all 10 number buttons (0 to 9) on the remote commander. Does the channel indicator on the cable box / DSS receiver change?

If the answer to both 1 and 2 is "yes" you have made the correct setting.

Free Manuals Download Website

<http://myh66.com>

<http://usermanuals.us>

<http://www.somanuals.com>

<http://www.4manuals.cc>

<http://www.manual-lib.com>

<http://www.404manual.com>

<http://www.luxmanual.com>

<http://aubethermostatmanual.com>

Golf course search by state

<http://golfingnear.com>

Email search by domain

<http://emailbydomain.com>

Auto manuals search

<http://auto.somanuals.com>

TV manuals search

<http://tv.somanuals.com>