

Digital Videocassette Recorder

Operating Instructions

Before operating the unit, please read this manual thoroughly and retain it for future reference.



DSR-1500/1500P

Owner's Record

The model and serial numbers are located at the bottom. Record these numbers in the spaces provided below. Refer to them whenever you call upon your Sony dealer regarding this product.

Model No. _____ Serial No. _____

WARNING

To prevent fire or shock hazard, do not expose the unit to rain or moisture.

To avoid electrical shock, do not open the cabinet. Refer servicing to qualified personnel only.

THIS APPARATUS MUST BE EARTHED.

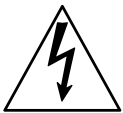
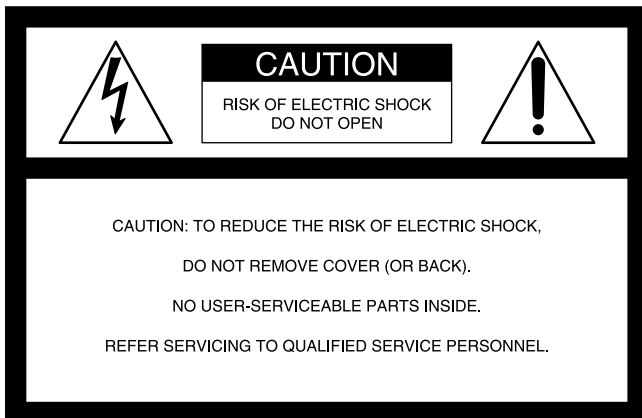

This symbol is intended to alert the user to the presence of uninsulated "dangerous voltage" within the product's enclosure that may be of sufficient magnitude to constitute a risk of electric shock to persons.



This symbol is intended to alert the user to the presence of important operating and maintenance (servicing) instructions in the literature accompanying the appliance.

WARNING: THIS WARNING IS APPLICABLE FOR USA ONLY.

Using this unit at a voltage other than 120 V may require the use of a different line cord or attachment plug, or both. To reduce the risk of fire or electric shock, refer servicing to qualified service personnel.

For customers in the USA

This equipment has been tested and found to comply with the limits for a Class A digital device, pursuant to Part 15 of the FCC Rules. These limits are designed to provide reasonable protection against harmful interference when the equipment is operated in a commercial environment. This equipment generates, uses, and can radiate radio frequency energy and, if not installed and used in accordance with the instruction manual, may cause harmful interference to radio communications. Operation of this equipment in a residential area is likely to cause harmful interference in which case the user will be required to correct the interference at his own expense.

You are cautioned that any changes or modifications not expressly approved in this manual could void your authority to operate this equipment.

The shielded interface cable recommended in this manual must be used with this equipment in order to comply with the limits for a digital device pursuant to Subpart B of Part 15 of FCC Rules.

Caution

Television programs, films, video tapes and other materials may be copyrighted. Unauthorized recording of such material may be contrary to the provisions of the copyright laws.

For customers in Europe (DSR-1500P only)

This product with the CE marking complies with both the EMC Directive (89/336/EEC) and the Low Voltage Directive (73/23/EEC) issued by the Commission of the European Community.

Compliance with these directives implies conformity to the following European standards:

- EN60065: Product Safety
- EN55103-1: Electromagnetic Interference (Emission)
- EN55103-2: Electromagnetic Susceptibility (Immunity)

This product is intended for use in the following Electromagnetic Environment(s):

E1 (residential), E2 (commercial and light industrial), E3 (urban outdoors) and E4 (controlled EMC environment, ex. TV studio).

Table of Contents

Chapter 1 Overview

Features.....	5
DVCAM Format	5
Variety of Interfaces.....	6
Compact Size	6
Facilities for High-Efficiency Editing.....	6
Other Features	7
Optional Accessories.....	7
Location and Function of Parts.....	8
Front Panel	8
Rear Panel	18

Chapter 2 Recording and Playback

Usable Cassettes	23
Inserting and Ejecting Cassettes	25
Recording.....	27
Settings for Recording	27
Recording Procedure.....	30
Playback	33
Settings for Playback	33
Playback Procedure.....	34
Repeat Playback—Automatic Cyclical Playback.....	36
Setting Points A and B for Repeat Playback.....	36
Cuing Up to Any Desired Position Set as Point A or B	42

Chapter 3 Convenient Functions for Editing Operation

Setting the Time Data.....	43
Displaying Time Data and Operation Mode Indications	43
Using the Internal Time Code Generator	45
Synchronizing Internal and External Time Codes	46
Rerecording the Time Code—TC Insert Function.....	47
High-Speed and Low-Speed Search—Quickly and Accurately Determining Editing Points	50
Search Operations via External Equipment	50
Digitally Dubbing Signals in DVCAM Format.....	51

Chapter 4 Menu Settings

Menu Organization	55
Menu Contents.....	58
Setup Menu	58
Auto Mode (AUTO FUNCTION) Execution Menu	71
Changing Menu Settings	72
Buttons Used to Change Settings	72
Changing the Settings of Basic Items	72
Displaying Enhanced Items	74
Changing the Settings of Enhanced Items	74
Returning Menu Settings to Their Factory Default Settings	75
Displaying Supplementary Status Information.....	76

Chapter 5 Connections and Settings

Connections for a Digital Non-Linear Editing System	79
Connections for a Cut Editing System	81
Connections for an A/B Roll Editing System.....	83
Connections for SDTI (QSDI) Dubbing	89
Connections for Analog Recording	90
Adjusting the Sync and Subcarrier Phases	91

Chapter 6 Maintenance and Troubleshooting

Maintenance	93
Condensation.....	93
Regular Checks	93
Head Cleaning.....	95
Troubleshooting	96
Error Messages.....	98
Alarm Messages.....	98

Appendixes

Precautions	101
Specifications	102
ClipLink Guide	105
What Is ClipLink?.....	105
Example System Configuration and Operation Flow	106
Data Generated When Shooting.....	107
Glossary	110
Index	113

Features

The DSR-1500/1500P is a $\frac{1}{4}$ -inch digital videocassette recorder using the DVCAM™ digital recording format. The unit is equipped with a full range of output interfaces, so that it can be used as a low-cost, compact feeder/viewer in a non-linear editing system* without requiring any optional boards. When using the unit as a recorder, the optional boards available for the unit allow you to select required input signal formats.

The unit is playback-compatible with tapes recorded in DV format (excluding tapes recorded in LP mode) as well as DVCPRO (25 Mbps) format. Playing back such tapes on the unit does not require any adapter.

These and other features of the unit make it suitable for use under diversified conditions. It can be used, for example, for desk-top editing or for such applications as electronic news gathering (ENG) and non-linear editing aboard outside broadcast vans, at production houses or at broadcasting stations.

* Non-linear editing: This is an editing method that uses video and audio signals digitally encoded and recorded on a hard disk as digital data. When compared with conventional (linear) editing methods, non-linear editing offers vastly improved efficiency in editing operations, for example, by eliminating tape transport time.

The following are the principal features of the unit.

DVCAM Format

DVCAM is a professional $\frac{1}{4}$ -inch digital recording format developed by Sony from the consumer DV component digital format.

High picture quality and high stability

Video signals are separated into color difference signals and luminance signals, which are encoded and compressed

to one-fifth size before being recorded to ensure stable and superb picture quality.

Because the recording is digital, multi-generation dubbing can be performed with virtually no deterioration of quality.

Wide track

The recording track width is 15 μm , 50% wider than the 10 μm of the DV format. This ensures adequate reliability for professional use.

High-quality PCM digital audio

PCM recording makes for a wide dynamic range and a high signal-to-noise ratio, thereby enhancing sound quality.

There are two recording modes: 2-channel mode (48-kHz sampling and 16-bit quantization), which offers sound quality equivalent to the DAT (Digital Audio Tape) format, or 4-channel mode (32-kHz sampling and 12-bit quantization).

Superior playback compatibility with DV and DVCPRO (25 Mbps) formats

Tapes recorded in DV format (excluding the tapes recorded in LP mode) as well as DVCPRO (25 Mbps) format can be played back on this unit without requiring a cassette adapter. You can use the recordings on such tapes as source material for editing, applying such functions as the jog audio and digital slow-motion playback as required. Using the material, editing can be carried out to single-frame precision.

Note

When playing back a tape recorded in DVCPRO (25 Mbps) format, the outputs in SDTI and DV (i.LINK) formats of this unit are muted. Furthermore, it is not possible to playback the cue-audio track of the tape.

Support for three cassette sizes

There are two sizes of DVCAM cassette: standard and mini. You can use either size with this unit.

The unit also accepts L and M sizes of DVCPRO cassette.

- When a cassette is inserted, the reel mechanism of the unit automatically adjusts to the size of the inserted cassette.
- The capacity of a standard cassette is 184 minutes of recording/playback, and that of a mini cassette is 40 minutes.

Variety of Interfaces

Digital interfaces

The following optional digital interfaces are available for use with the unit.

- **SDTI (QSDI)* (optional DSBK-1501 Digital Input/Output Board):** When the unit is fitted with the optional DSBK-1501 board, SDTI (QSDI)-format video, audio and time code signals can be transferred between the unit and the Sony EditStation at normal speed. When this unit is connected to another DVCAM VCR, it is possible to copy compressed signals between the two VCRs. (You cannot use the SDTI (QSDI) and SDI (*see next paragraph*) interfaces at the same time. You can select either of the two using front panel buttons for input or with a menu item for output.)
- **SDI (serial digital interface)/AES/EBU (optional DSBK-1501 Digital Input/Output Board):** When the unit is fitted with the optional DSBK-1501 board, it can input and output D1 (component) format digital video and audio signals and also AES/EBU-format digital audio signals.
- **i.LINK (DV)** (optional DSBK-1503 i.LINK/DV Input/Output Board):** When the unit is fitted with the optional DSBK-1503 board, it can input and output digital video and audio signals in DV format.

* SDTI is the name of a standard interface established as SMPTE 305M. QSDI is a type of SDTI. This unit uses SDTI to transmit DV data, and the input/output connectors are labeled "SDTI (QSDI)."

** i.LINK and  are trademarks and indicate that this product is in agreement with IEEE1394-1995 specifications and their revisions.

Analog interfaces

The unit can also use the following analog interfaces.

- **Analog video:** These interfaces include a component interface, composite interface, and S-video interface. The same BNC type input and output connectors are used to input and output signals in different formats selected with front panel buttons for input and menu items for output.
- **Analog audio:** The unit has two audio channels. When in 4-channel mode, you can input two channels of audio either as channels 1 and 2 or as channels 3 and 4. The two

audio channels can be output also either as channels 1 and 2 or as channels 3 and 4.

The analog output interfaces are provided as standard so that the unit can readily be used as a viewer, for example, at broadcasting stations and aboard outside broadcast vans without requiring any optional boards.

Inputting analog video and audio signals requires the optional DSBK-1504/1504P Analog Input Board.

Compact Size

The compact size of the unit makes the unit suitable for use as a desk-top editor or feeder machine for non-linear editing or as a viewer compatible with a full range of digital and analog signal formats aboard an outside broadcast van.

Facilities for High-Efficiency Editing

Digital slow motion playback

Using the frame memory function, noiseless slow motion playback is possible at any speed in the range ± 0.5 times* normal speed.

* The positive direction refers to forward movement of the tape, and the negative direction to reverse movement.

Digital jog sound function

When searching at speeds in the range ± 0.5 times normal speed, the digital jog sound function is enabled. The audio signal is saved in temporary memory, and replayed according to the search speed. This allows searching on the sound track.

Remote control

The unit can be operated by remote control from an editing control unit that supports the RS-422A interface or an optional SIRCS*-compatible remote control unit such as the DSRM-10.

* SIRCS (Sony Integrated Remote Control System): A command protocol to remote control Sony professional videocassette recorders/players.

High-speed search function

The unit has a picture search function that allows you to view color picture at playback speeds up to 85 times normal speed in forward and reverse directions.

When remote-controlling this unit in shuttle mode from an editing control unit or a remote control unit, you can search at any speed in the range 0 (still) to 60 times normal speed in both directions. You can also search frame-by-frame in jog mode.

At search speeds up to 10 times normal speed in both directions, you can also hear playback audio.

Quick mechanical response

When you use the tape transport buttons of the unit, the tape inserted in the unit responds quickly.

Superimposition function

Time code values, operation mode indications, error messages, and other text data can be superimposed and output in analog composite video signals.

Other Features

Menu system for functionality and operation settings

The unit provides a menu system to make its various functions easier to use and set up its operation conditions.

Easy maintenance functions

Self-diagnostic/alarm function: This function automatically detects setup and connection errors, operation faults, and other problems. It also displays a description of the problem, its cause, and the recommended response on the video monitor screen or time counter display.

Digital hours meter: The digital hours meter functions include four kinds of tally operations for operating hours, head drum usage hours, tape transport hours, and tape threading/unthreading times. The tally results can be viewed on the video monitor or the time counter display.

AC operations

The unit operates with an AC power source in the range 100 to 240 V, 50/60 Hz.

Internal and external time codes

An internal time code generator and reader enables time code compliant with SMPTE (for DSR-1500)/EBU (DSR-1500P) format to be recorded and played back. This allows editing to single frame precision.

Outputting or inputting time code (LTC) to or from an external device is also possible using the TC IN/OUT connectors.

The unit is also compatible with VITC.

Internal test signal generator

The unit has built-in video and audio test signal generators. The video test signal generator can produce either a color bar signal or a black burst signal. The audio test signal generator can generate either a silent signal or a 1-kHz sine wave signal. Menu items are provided for selecting the test signals to be generated.

Support for ClipLink function

In response to commands sent from the EditStation, index pictures recorded on tape or ClipLink log data recorded in the cassette memory can be transferred to the EditStation. The EditStation operator can then efficiently use these pictures and data in a preliminary editing session.

For an overview of the ClipLink function, see the appendix "ClipLink Guide" (page 105).

Video process control

For analog video output and SDI-format video output, you can use menu items to adjust the video output level, chroma signal output level, setup level (for DSR-1500), black level (for DSR-1500P), and chroma phase.

Reference signal connection

The reference video input connector of the unit is provided with a loop-through connector which can be used to connect the input reference video signal to other equipment. When there is no loop-through connection, the reference video input connector is automatically provided with a 75-ohm termination.

Closed caption compatibility

Whether or not to include closed captions in a recording can be determined with menu items (for DSR-1500 only).

Optional Accessories

DSBK-1501 Digital Input/Output Board

This interface enables digital video and audio signals in the SDI or SDTI (QSDI) format (either format to be selected with front panel buttons for input or with a menu item for output) and also AES/EBU-format digital audio signals to be transferred between this unit and digital Betacam VCRs or other digital equipment.

DSBK-1503 i.LINK/DV Input/Output Board

This interface allows you to connect the unit to other equipment provided with a Sony DV connector to carry out editing or dubbing of digital video and audio signals.

DSBK-1504/1504P Analog Input Board

When this interface is installed, the unit can input analog video and audio signals. The same BNC type input connectors are used to input analog video signals in different formats selected with front panel buttons. The analog video signals that can be input are as follows.

- Composite video signals
- S-video signals
- Component video signals (Y, R-Y and B-Y)

Location and Function of Parts

Front Panel

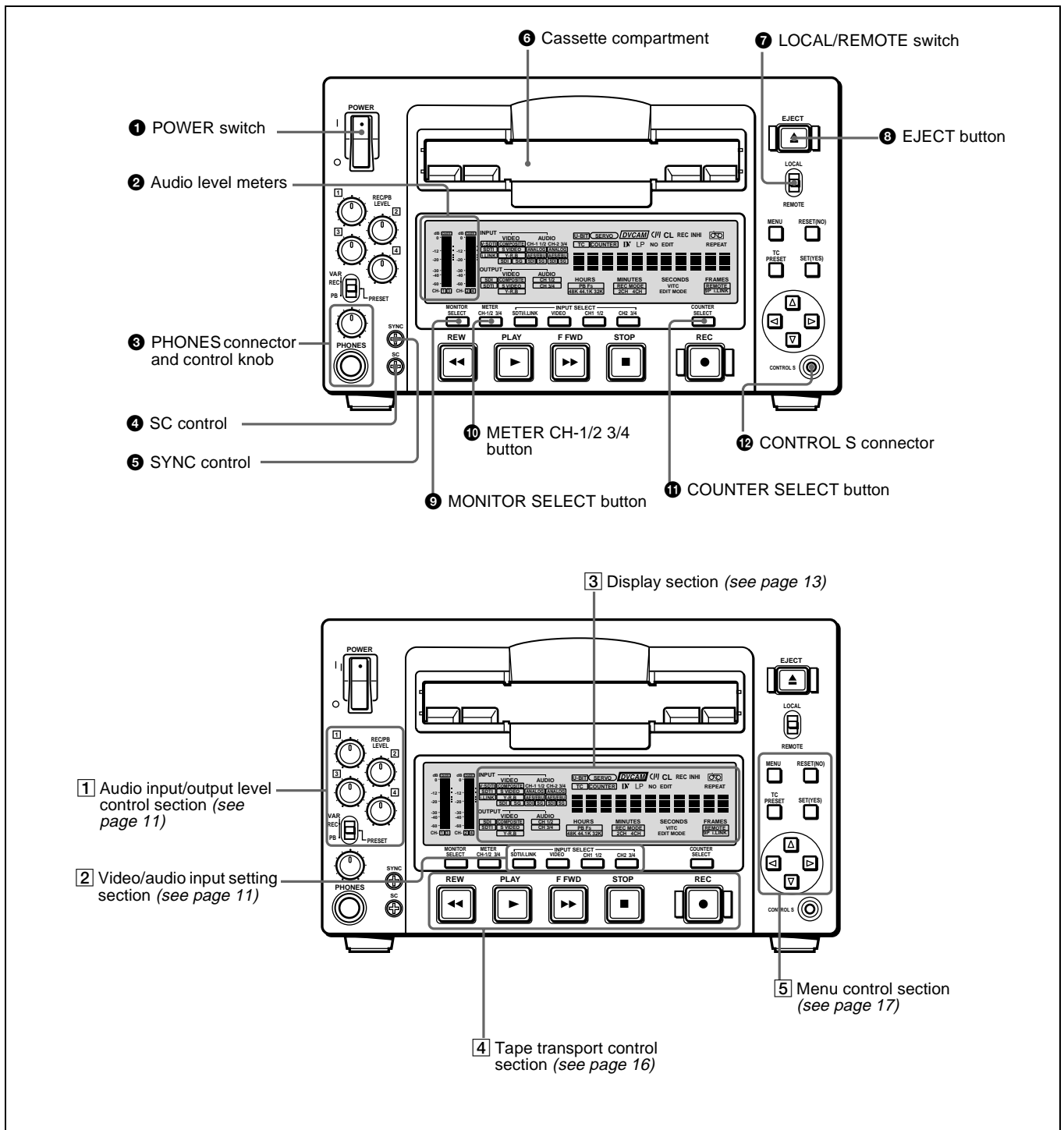

1 POWER switch

Press the “I” side to power on the unit. This causes the audio level meters and the display section to light. To power off the unit, press the “O” side of the switch.

2 Audio level meters

These two meters indicate the recording audio levels during recording or EE mode* and the playback audio levels during playback. When the audio level indicated on a meter exceeds 0 dB, the OVER indicator for the meter lights.

The short bars to the right of level indication bars indicate that those levels are reference audio recording levels.

The settings made with the METER CH-1/2 3/4 button and MONITOR SELECT button select the audio channels for level indications on these meters as follows.

When CH-1/2 mode is selected with the METER CH-1/2 3/4 button:

Every time the MONITOR SELECT button is pressed, the audio channel selection for level indications on the two meters cycles through the following options.

- CH-1 (channel 1) only
Only the CH-1 indicator lights.
- CH-2 (channel 2) only
Only the CH-2 indicator lights.
- CH-1 and CH-2 (channels 1 and 2)
Both the CH-1 and CH-2 indicators light.

When CH-3/4 mode is selected with the METER CH-1/2 3/4 button:

Every time the MONITOR SELECT button is pressed, the audio channel selection for level indications on the two meters cycles through the following options.

- CH-3 (channel 3) only
Only the CH-3 indicator lights.
- CH-4 (channel 4) only
Only the CH-4 indicator lights.
- CH-3 and CH-4 (channels 3 and 4)
Both the CH-3 and CH-4 indicators light.

* E-E mode: Abbreviation of “Electric-to-Electric mode.” In this mode, video and audio signals input to the VCR are output after passing through internal electric circuits, but not through magnetic conversion circuits such as heads and tapes. This can be used to check input signals and for adjusting input signal levels.

3 PHONES connector (stereo phone jack) and control knob

Connect stereo headphones to the connector for audio monitoring during recording or playback. The control knob controls the volume of the headphones. It also controls the level of the audio signal output from the MONITOR connector on the rear panel.

The settings made with the METER CH-1/2 3/4 button and MONITOR SELECT button select the audio channels for audio output via this connector. The same channel selection as for the audio level meters applies to this connector.

4 SC (subcarrier phase) control

Turn this control to accurately adjust the subcarrier phase of the composite video output signal of the unit with respect to the reference video signal. Use a cross-point (Phillips) screwdriver to turn it.

5 SYNC (synchronization phase) control

Turn this control to accurately adjust the synchronization phase of the output video signal of the unit with respect to the reference video signal. Use a cross-point (Phillips) screwdriver to turn it.

6 Cassette compartment

Accepts DVCAM, DV and DVCPRO (25 Mbps) videocassettes.

For details of usable cassettes, see page 23.

7 LOCAL/REMOTE switch

Selects whether the unit is operated from its front panel or from external equipment.

REMOTE: The unit is operated from external equipment connected to the REMOTE connector or i.DV IN/OUT connector (when the optional DSBK-1503 i.LINK/DV Input/Output Board is installed) on the rear panel.

LOCAL: The unit is operated from its front panel or from a SIRCS-compatible remote control unit connected to the CONTROL S connector on the front panel.

8 EJECT button

When you press this button, the cassette is automatically ejected after a few seconds.

9 MONITOR SELECT button

Use this button and the **METER CH-1/2 3/4** button to select the audio channels:

- for level indications on the audio level meters
- for audio output via the **PHONES** connector on the front panel
- for audio output via the **MONITOR** connector on the rear panel

Depending on the setting made with the **METER CH-1/2 3/4** button, the channels for output to the above meters and connectors are selected as follows.

When CH-1/2 mode is selected with the METER CH-1/2 3/4 button:

Audio level meters	PHONES connector	MONITOR connector
CH-1 (channel 1) only. Only the left meter lights.	Channel 1 only (monaural)	Channel 1 only
CH-2 (channel 2) only. Only the right meter lights.	Channel 2 only (monaural)	Channel 2 only
CH-1 and CH-2 (channels 1 and 2). Both the left and right meters light.	Channels 1 and 2 (stereo)	Channels 1 and 2 (mixed)

When CH-3/4 mode is selected with the METER CH-1/2 3/4 button:

Audio level meters	PHONES connector	MONITOR connector
CH-3 (channel 3) only. Only the left meter lights.	Channel 3 only (monaural)	Channel 3 only
CH-4 (channel 4) only. Only the right meter lights.	Channel 4 only (monaural)	Channel 4 only
CH-3 and CH-4 (channels 3 and 4). Both the left and right meters light.	Channels 3 and 4 (stereo)	Channels 3 and 4 (mixed)

10 METER CH-1/2 3/4 button

Pressing this button toggles the audio level meter mode between **CH-1/2** (channels 1 and 2) and **CH-3/4** (channels 3 and 4).

The settings made with this button and the **MONITOR SELECT** button select the channels for level indications and audio output.

For more details, see “**9 MONITOR SELECT button.**”

11 COUNTER SELECT button

Selects the type of time data to be shown in the time counter display. Each press of this button cycles through the following three indicator display options:

- **COUNTER** (CNT: count value of the time counter)
- **TC** (time code)
- **U-BIT** (user bits)

Note

If the **LOCAL/REMOTE** switch is set to **REMOTE**, the **COUNTER SELECT** button does not operate while the tape is moving. In this case, make the time data selection via the external equipment connected to the **REMOTE** connector on the rear panel.

12 CONTROL S connector (stereo minijack)

Connect a **SIRCS**-compatible remote control unit such as the **DSRM-10** to this connector.

1 Audio input/output level control section

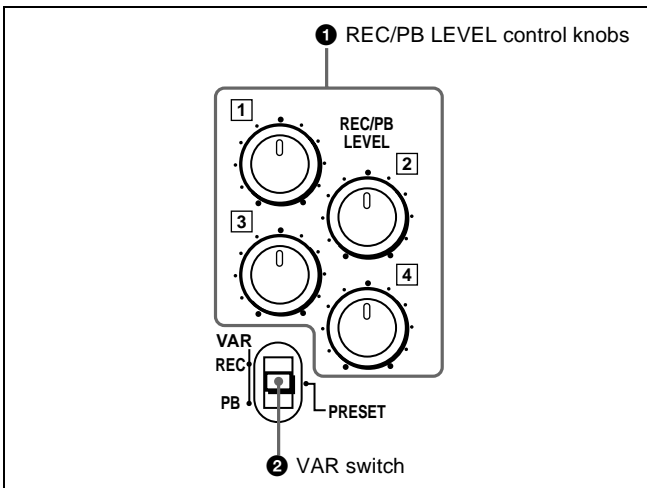

1 REC/PB LEVEL control knobs

These knobs used to control audio levels function differently depending on the setting of the VAR switch as follows.

VAR switch setting	Functions of control knobs
PRESET	Control knobs are not effective. The analog audio input/output levels are set to the reference level set with the LEVEL SELECT menu item (see page 66).
REC	Control the analog/digital audio input levels on channels 1 to 4 during recording.
PB	Control the analog/digital audio output levels on channels 1 to 4 during playback.

2 VAR switch

Use to switch the way in which the REC/PB LEVEL control knobs function.

2 Video/audio input setting section

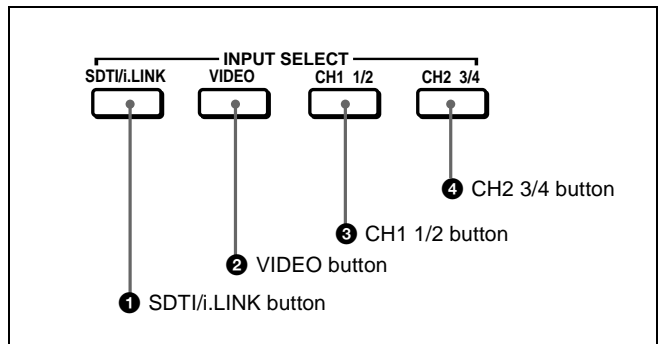

1 SDTI/i.LINK (SDTI (QSDI) interface/i.LINK selection) button

Each press of this button cycles through the following input signal selection options.

- **Digital video signal** in SDTI (QSDI) format input to the SDI/SDTI (QSDI) IN connector (optional DSBK-1501 board required)
When this is selected, use the CH1 1/2 button and CH2 3/4 button to select the required input audio signals.

Note

In this case, the phases of the selected audio signals will be about two frames ahead of the phase of the digital video signal in SDTI (QSDI) format.

- **Digital video and audio signals** in SDTI (QSDI) format input to the SDI/SDTI (QSDI) IN connector (optional DSBK-1501 board required)
- **Digital video and audio signals** in i.LINK-compatible DV format input to the i.DV IN/OUT connector (optional DSBK-1503 board required)

The selection made with this button is indicated in the INPUT signal display section (see page 14).

2 VIDEO button

Each press of this button cycles through the following input video signal selection options.

- Composite video signal input to the VIDEO IN connector (optional DSBK-1504/1504P board required)
- S-video (separated Y and C) signals input to the VIDEO IN connectors (optional DSBK-1504/1504P board required)
- Y, R-Y and B-Y component video signals input to the VIDEO IN connectors (optional DSBK-1504/1504P board required)
- SDI video signal input to the SDI/SDTI (QSDI) IN connector (optional DSBK-1501 board required)
- Video test signal (selected with the INT VIDEO SG menu item (see page 64)) generated by the internal signal generator

The selection made with this button is indicated by the VIDEO indicators in the INPUT signal display section (see page 13).

3 CH1 1/2 (audio channel 1 or 1/2) button

Each press of this button cycles through the following input audio signal selection options for audio channel 1 (when in 2-channel mode) or for audio channels 1 and 2 (when in 4-channel mode).

- Analog audio signal input to the AUDIO IN 1/3 connector (optional DSBK-1504/1504P board required)
- Digital audio signal in AES/EBU format input to the AUDIO (AES/EBU) IN 1/2 connector (optional DSBK-1501 board required)
- SDI audio signal input to the SDI/SDTI (QSDI) IN connector (optional DSBK-1501 board required)
- Audio test signal (selected with the INT AUDIO SG menu item (*see page 66*) generated by the internal signal generator

The selection made with this button is indicated by the AUDIO CH-1 1/2 indicators in the INPUT signal display section (*see page 13*).

When analog audio is selected (optional DSBK-1504/1504P board required), the signal input to the AUDIO IN 1/3 connector is recorded either on channel 1 (when in 2-channel mode) or on channels 1 and 3 (when in 4-channel mode). That is, in 4-channel mode, the same analog audio signal is recorded on channels 1 and 3. Using the REC/PB LEVEL control knobs with the VAR switch set to REC, it is possible to adjust the audio levels on the two channels separately.

You can switch the audio recording mode with the REC MODE menu item (*see page 65*). The selection is indicated by the REC MODE display on the front panel.

4 CH2 3/4 (audio channel 2 or 3/4) button

Each press of this button cycles through the following input audio signal selection options for audio channel 2 (when in 2-channel mode) or for audio channels 3 and 4 (when in 4-channel mode).

- Analog audio signal input to the AUDIO IN 2/4 connector (optional DSBK-1504/1504P board required)
- Digital audio signal in AES/EBU format input to the AUDIO (AES/EBU) IN 3/4 connector (optional DSBK-1501 board required)
- SDI audio signal input to the SDI/SDTI (QSDI) IN connector (optional DSBK-1501 board required)
- Audio test signal (selected with the INT AUDIO SG menu item (*see page 66*) generated by the internal signal generator

The selection made with this button is indicated by the AUDIO CH-2 3/4 indicators in the INPUT signal display section (*see page 13*).

When analog audio is selected (optional DSBK-1504/1504P board required), the signal input to the AUDIO IN 2/4 connector is recorded either on channel 2 (when in 2-channel mode) or on channels 2 and 4 (when in 4-channel mode). That is, in 4-channel mode, the same analog audio signal is recorded on channels 2 and 4. Using the REC/PB LEVEL control knobs with the VAR switch set to REC, it is possible to adjust the audio levels on the two channels separately.

You can switch the audio recording mode with the REC MODE menu item (*see page 65*). The selection is indicated by the REC MODE display on the front panel.

3 Display section

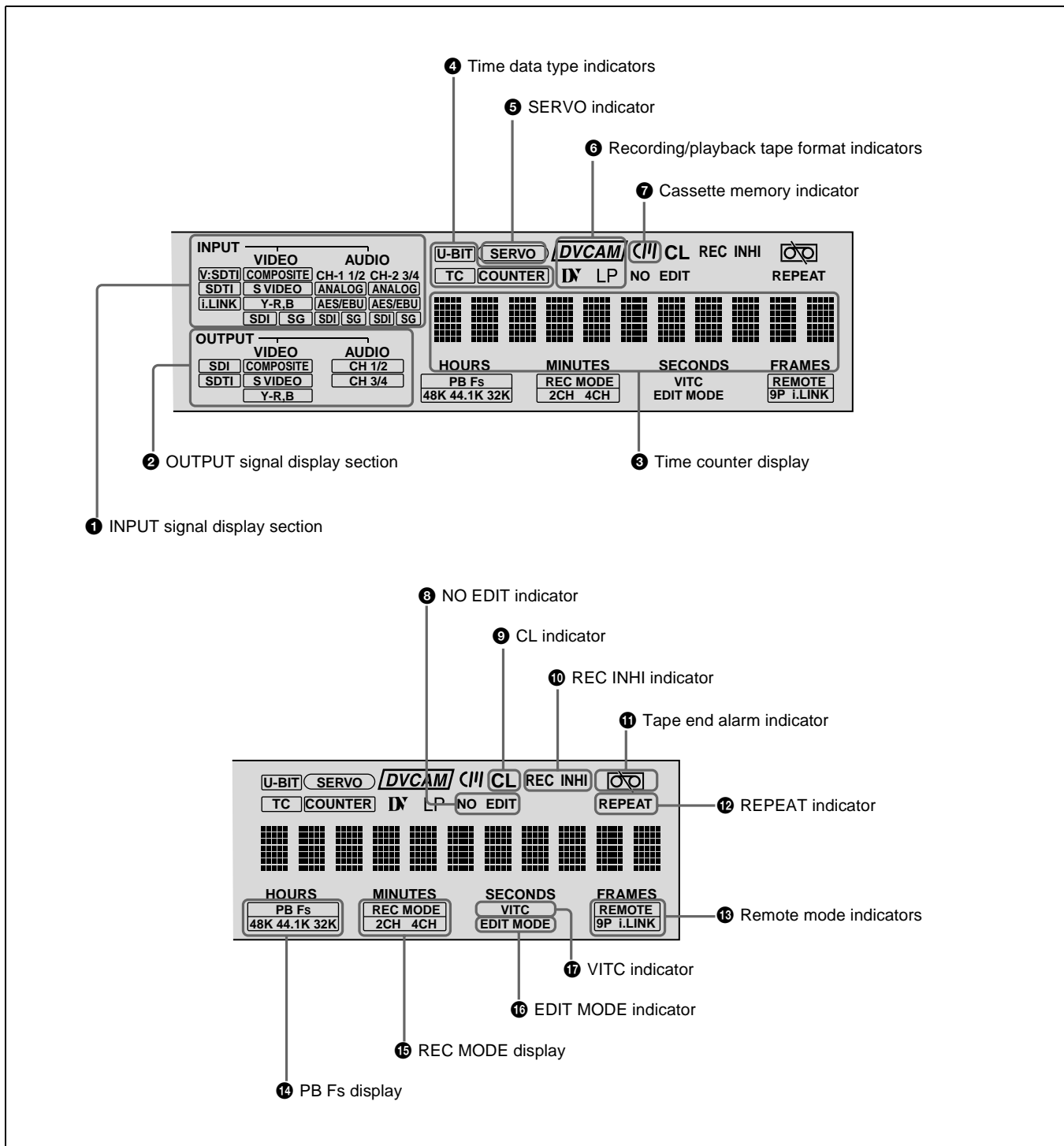

1 INPUT signal display section

Indicates the input video and audio signal formats selected with the INPUT SELECT buttons (SDTI/i.LINK, VIDEO, CH1 1/2, and CH2 3/4 buttons).

Note

The indicators without the corresponding optional boards installed in the unit do not light.

V:SDTI indicator: Lights when the digital video signal only in SDTI (QSDI) format is selected (optional DSBK-1501 board required).

SDTI indicator: Lights when the digital video and audio signals in SDTI (QSDI) format are selected (optional DSBK-1501 board required).

i.LINK indicator: Lights when the digital video and audio signals in i.LINK-compatible DV format are selected (optional DSBK-1503 board required).

VIDEO indicators: The indicator (COMPOSITE, S VIDEO, Y–R,B, SDI, or SG) corresponding to the selected input video signal format lights.

Indicators	Meanings
COMPOSITE	Composite video signal (optional DSBK-1504/1504P board required)
S VIDEO	S-video (separated Y and C) signals (optional DSBK-1504/1504P board required)
Y–R,B	Y, R–Y and B–Y component video signals (optional DSBK-1504/1504P board required)
SDI	SDI video signal (optional DSBK-1501 board required)
SG	Video test signal (factory default setting)

AUDIO indicators: Comprise the CH-1 1/2 indicator and CH-2 3/4 indicator, under each of which there are four more indicators (ANALOG, AES/EBU, SDI, and SG). They indicate the selected input audio signal formats.

Indicators	Functions
CH-1 1/2 (ANALOG, AES/EBU, SDI, SG)	The indicator corresponding to the signal format selected for audio input to channel 1 (when in 2-channel mode) or to channels 1 and 2 (when in 4-channel mode) lights. ANALOG: Analog audio signal (optional DSBK-1504/1504P board required) AES/EBU: Digital audio signal in AES/EBU format (optional DSBK-1501 board required) SDI: SDI audio signal (optional DSBK-1501 board required) SG: Audio test signal (factory default setting)
CH-2 3/4 (ANALOG, AES/EBU, SDI, SG)	The indicator corresponding to the signal format selected for audio input to channel 2 (when in 2-channel mode) or to channels 3 and 4 (when in 4-channel mode) lights. ANALOG: Analog audio signal (optional DSBK-1504/1504P board required) AES/EBU: Digital audio signal in AES/EBU format (optional DSBK-1501 board required) SDI: SDI audio signal (optional DSBK-1501 board required) SG: Audio test signal (factory default setting)

2 OUTPUT signal display section

Indicates the output video and audio signal format selected with the INTERFACE SELECT menu items (*see page 67*).

Note

The indicators without the corresponding optional boards installed in the unit do not light.

SDI indicator: Lights when the digital video and audio signals in SDI format are selected (optional DSBK-1501 board required).

The SDI video and audio signals are output to the SDI/SDTI (QSIDI) OUT1 and OUT2 connectors.

SDTI indicator: Lights when the digital video and audio signals in SDTI (QSIDI) format are selected (optional DSBK-1501 board required).

The video and audio signals in SDTI (QSIDI) format are output to the SDI/SDTI (QSIDI) OUT1 and OUT2 connectors.

VIDEO indicators: The indicator (COMPOSITE, S VIDEO, or Y–R,B) corresponding to the selected output analog video signal format lights.

Indicators	Meanings
COMPOSITE	Composite video signal
S VIDEO	S-video (separated Y and C) signals
Y–R,B	Y, R–Y and B–Y component video signals

This selection determines the signals output from the Y/CPST, R–Y/C/CPST, and B–Y/CPST (SUPER) connectors as follows.

- **When COMPOSITE is selected:**

Connectors	Output signals
Y/CPST	Composite signal
R–Y/C/CPST	Composite signal
B–Y/CPST (SUPER)	Composite signal

- **When S VIDEO is selected:**

Connectors	Output signals
Y/CPST	Y signal
R–Y/C/CPST	C signal (3.58 MHz for DSR-1500/ 4.43 MHz for DSR-1500P)
B–Y/CPST (SUPER)	Composite signal

- **When Y–R,B is selected:**

Connectors	Output signals
Y/CPST	Y signal
R–Y/C/CPST	R–Y signal
B–Y/CPST (SUPER)	B–Y signal

AUDIO indicators: Comprise the CH 1/2 indicator and CH 3/4 indicator to indicate the channel selection for analog audio output from the AUDIO OUT 1/3 and AUDIO OUT 2/4 connectors.

Indicators	Functions
CH 1/2	Lights when channels 1 and 2 are selected for analog audio output from the AUDIO OUT 1/3 and AUDIO OUT 2/4 connectors.
CH 3/4	Lights when channels 3 and 4 are selected for analog audio output from the AUDIO OUT 1/3 and AUDIO OUT 2/4 connectors.

You can change the channel selection with the AUDIO OUTPUT menu item (see page 67).

3 Time counter display

Indicates the count value of the time counter, time code, VITC, or user bit data depending on the settings of the COUNTER SELECT button and the TC SELECT menu item (see page 62).

Also used to display error messages, edit data, setup menu data, etc.

4 Time data type indicators

One of the three indicators (COUNTER, U-BIT, or TC) lights to indicate the type of time data currently shown in the time counter display.

COUNTER: Count value of the time counter

U-BIT: User bit data

TC: SMPTE time code (for DSR-1500) or EBU time code (for DSR-1500P)

5 SERVO (servolock) indicator

Lights when the drum servo and capstan servo are locked.*

* Servolock: Synchronizing the drum rotation phase and tape transport phase with a reference signal during playback and recording so that the video heads scan the tape in the same pattern during playback and recording.

6 Recording/playback tape format indicators

DVCAM: This lights when a tape recorded in DVCAM format is played back.

DV: This lights when a tape recorded in consumer DV format is played back.

LP: This flashes along with “DV” when a tape recorded in LP mode is played back.

Video recorded in LP mode cannot be played back correctly and audio is muted.

When a tape recorded in DVCPRO (25 Mbps) format or any other format than those mentioned above is played back, none of the above indicators lights.

7 Cassette memory indicator

Lights when a cassette provided with a memory chip (“cassette memory”) is loaded.

8 NO EDIT (not editable) indicator

Lights during playback of a tape that contains a recording in other than the DVCAM format. When this indicator is lit, the recordings contained in the tape can be used as source material for editing, but editing operations such as insert editing and assemble editing cannot be performed. This indicator also lights when the audio recording mode selected on this unit does not coincide with that of the loaded tape during editing operation.

9 CL (ClipLink) indicator

Lights when a cassette is loaded on which ClipLink log data is stored in the cassette memory.

For details of ClipLink log data, see the appendix “ClipLink Guide” (page 105).

10 REC INHI (recording inhibit) indicator

Lights when the REC/SAVE switch on the loaded cassette is in the SAVE position (recording inhibited).

11 Tape end alarm indicator

Starts flashing when the remaining capacity of the tape is for about 2 minutes.

12 REPEAT (repeat playback) indicator

Lights when the REPEAT MODE menu item (see page 58) is set to ON to enable the repeat playback function.

13 Remote mode indicators

REMOTE: Lights when the LOCAL/REMOTE switch is set to REMOTE to remote control the unit from either an editing control unit connected to the REMOTE connector or equipment connected to the i.DV IN/OUT connector (when the optional DSBK-1503 board is installed).

9P: Lights when the REMOTE I/F menu item (see page 67) is set to 9PIN.

i.LINK: Lights when the REMOTE I/F menu item (see page 67) is set to i.LINK (optional DSBK-1503 board required).

14 PB Fs (playback audio sampling frequency) display

During playback, this indicates the playback audio mode in which the tape being played back was recorded.

48K indicator: Lights during playback of a tape recorded in 2-channel mode (48 kHz).

44.1K indicator: Lights during playback of a tape recorded in 2-channel mode (44.1 kHz).

32K indicator: Lights during playback of a tape recorded in 4-channel mode (32 kHz).

15 REC MODE (audio recording mode) display

This indicates the audio recording mode currently selected with the REC MODE menu item (*see page 65*).

2CH indicator: Lights in 2-channel mode (48 kHz).

4CH indicator: Lights in 4-channel mode (32 kHz).

16 EDIT MODE indicator

Lights when this unit is selected as the recorder VCR under the control of either an editing control unit connected to the REMOTE connector or equipment connected to the i.DV IN/OUT connector (when the optional DSBK-1503 board is installed).

17 VITC indicator

Lights when VITC is being read or recorded regardless of the data shown in the time counter display.

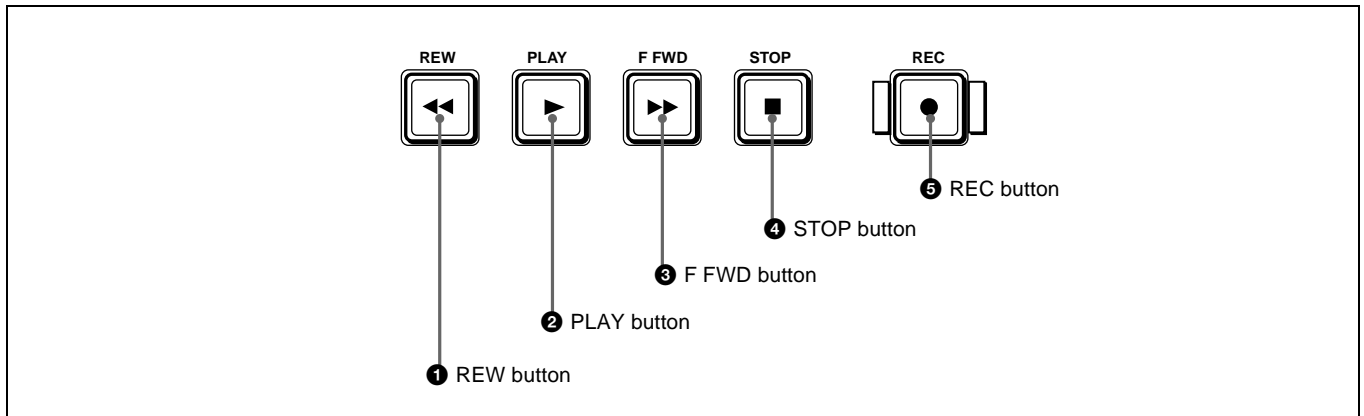
4 Tape transport control section**1 REW (rewind) button**

When you press this button, it lights and the tape starts rewinding.

When the F. FWD/REW menu item under the AUTO EE SELECT menu item (*see page 59*) is set to PB, the picture appears on the monitor during rewind (maximum 85 times normal speed).

2 PLAY button

When you press this button, it lights and playback begins. If you press this button during recording or editing, the recording or editing operation is stopped and this unit enters playback mode.

3 F FWD (fast forward) button

When you press this button, it lights and the tape is fast forwarded.

When the F. FWD/REW menu item under the AUTO EE SELECT menu item (*see page 59*) is set to PB, the picture appears on the monitor during fast forward (maximum 85 times normal speed).

4 STOP button

Press this button to stop the current tape transport operation.

5 REC (record) button

When you press this button while holding down the PLAY button, it lights and recording begins.

Note

When the LOCAL/REMOTE switch is set to REMOTE (the REMOTE indicator is lit), no tape transport control buttons other than the EJECT and STOP buttons will work. This can be changed with the LOCAL ENABLE menu item (*see page 59*).

5 Menu control section

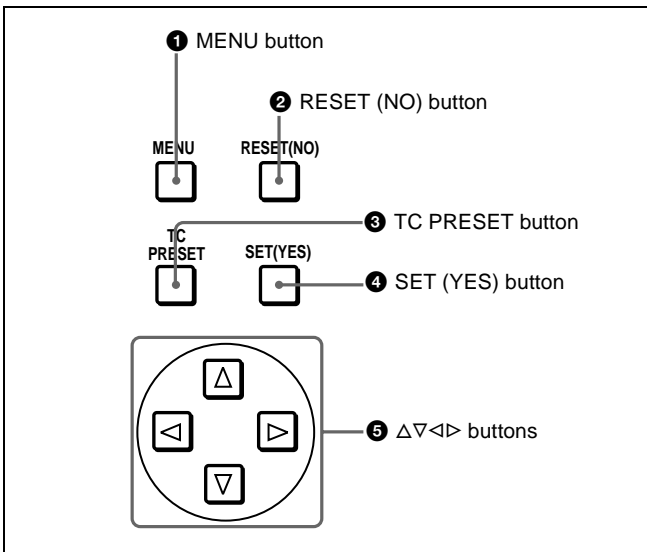

1 MENU button

Press this button to display the menu on the monitor screen and the time counter display. Press it again to exit the menu display.

On how to use the menu, see Chapter 4 “Menu Settings.”

2 RESET (NO) button

Press this button to:

- reset menu settings,
- reset the time data shown in the time counter display to zero, or
- send a negative response to the prompts issued by the unit.

3 TC (time code) PRESET button

Use this button to set the initial value of the time code produced by the internal time code generator and user bit data.

For details on setting an initial time code value and user bit data, see “To set the initial time code value and user bit data” on page 45.

4 SET (YES) button

Press this button to:

- save new settings, such as selected menu items and time code settings, to memory, or
- send a positive response to the prompts issued by the unit.

5 Δ∇◀▶ (arrow) buttons

Use these buttons to move around the menu items, and also to modify the initial time code value and user bit data. When the SEARCH ENABLE menu item (*see page 59*) is set to ENABLE, you can also use these buttons to carry out the following playback operations.

Playback type	Direction	Operation to carry out
Playback in range ±10 times normal speed	Forward	Press the ▶ button.
	Reverse	Press the ◀ button.
Frame-by-frame playback	Forward	Press the Δ button.
	Reverse	Press the ∇ button.
Continuous playback in jog mode	Forward	Hold down the Δ button.
	Reverse	Hold down the ∇ button.

For details on modifying the time code value, see “To set the initial time code value and user bit data” on page 45.

Rear Panel

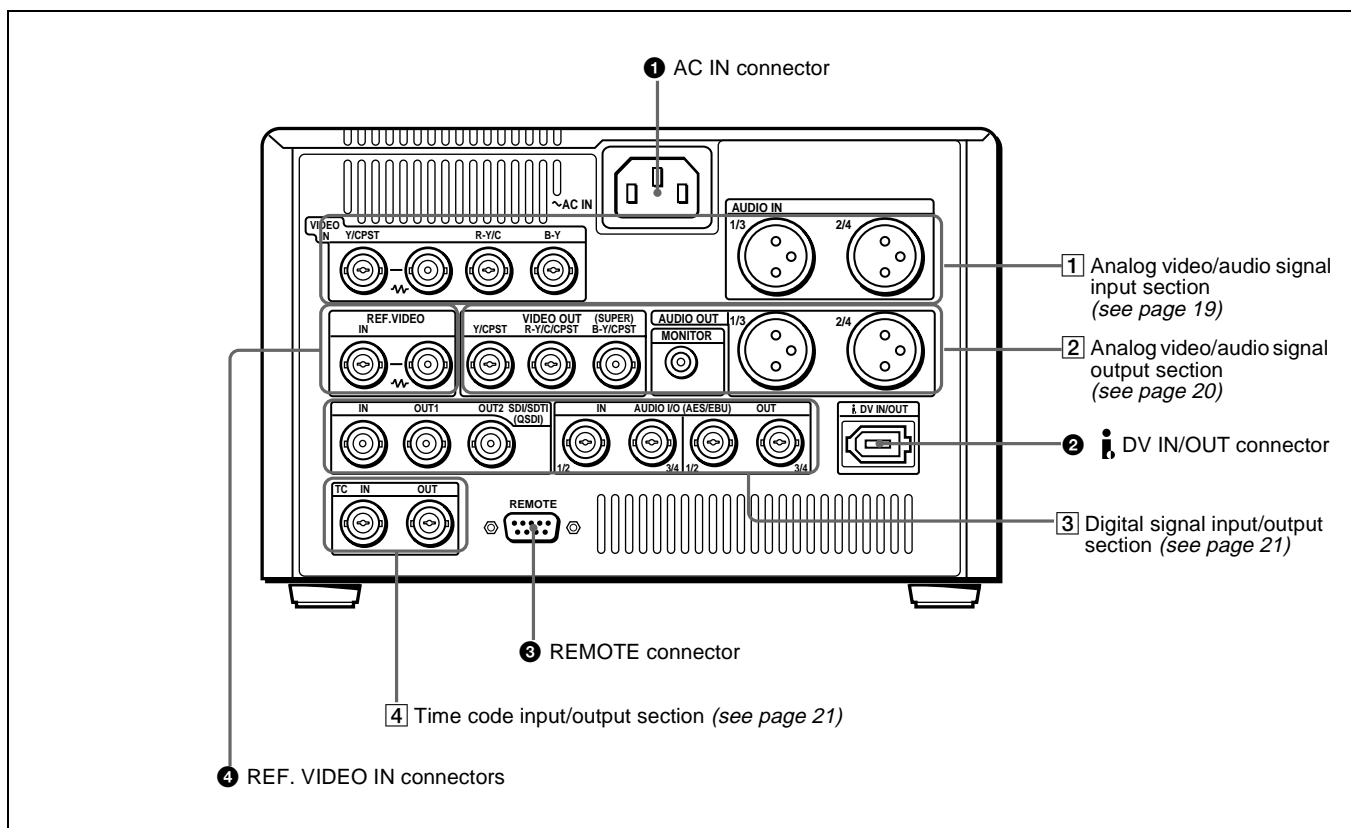

1 AC IN connector

Use the supplied power cord to connect this to an AC outlet.

2 i DV IN/OUT connector (6-pin IEEE-1394) (optional DSBK-1503 i.LINK/DV Input/Output Board)

This connector is available when the optional DSBK-1503 board is installed. It inputs and outputs digital video and audio signals in DV format.

Note

When searching at speeds in the range $+1/2$ to $+1/30$ or $-1/30$ to $-1/2$ times normal speed, the audio signal output from this connector and monitored on external equipment may sound differently from the audio signal played back on this unit.

3 REMOTE connector (D-sub 9-pin)

When controlling this unit from an editing control unit such as the ES-7, PVE-500, BVE-600/800/910, or RM-450/450CE, connect the editing control unit to this connector using the optional 9-pin remote control cable.

4 REF. (reference) VIDEO IN connectors (BNC type)

Input a reference video signal. The two connectors are loop-through connectors. You can connect the reference video signal input to the left connector to other equipment via the right connector (marked ∞). When no connection is made to the right connector, the left connector is terminated with an impedance of 75Ω automatically.

1 Analog video/audio signal input section (optional DSBK-1504/1504P Analog Input Board)

The connectors in this section are available when the optional DSBK-1504/1504P board is installed.

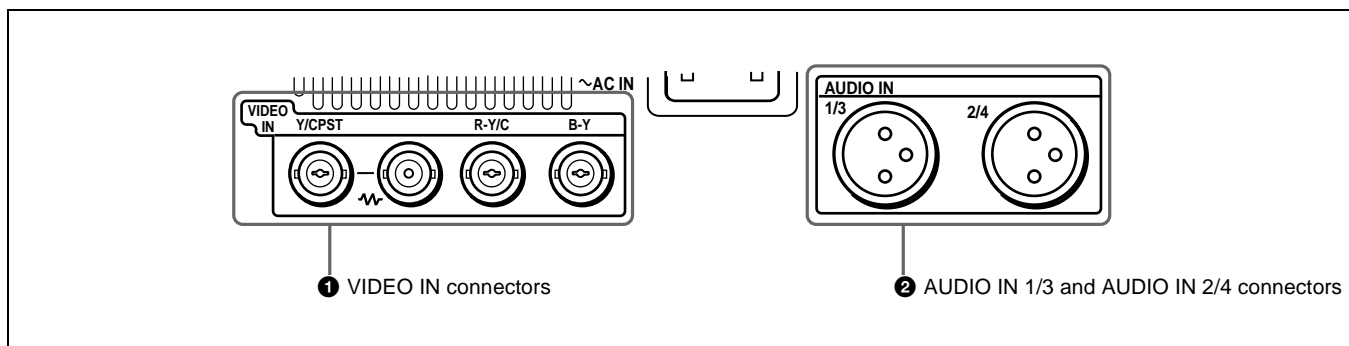

1 VIDEO IN connectors (BNC type)

There are the following VIDEO IN connectors for inputting analog video signals:

- Y/CPST (loop-through connectors)
- R-Y/C
- B-Y

The signals you can connect to these connectors depend on the selection made with the VIDEO button in the video/audio input selection section. The selection is indicated by the VIDEO indicators in the INPUT signal display section. The analog video signals that can be input to these connectors are as follows.

When COMPOSITE is selected:

Connectors	Input signals
Y/CPST	Composite signal
R-Y/C	— (not usable)
B-Y	— (not usable)

The two Y/CPST connectors are loop-through connectors. When using the signal input to the left Y/CPST connector as a reference video signal, for example, you can bridge-connect the signal to other equipment via the right Y/CPST connector (marked \sim). When no connection is made to the right Y/CPST connector, the left Y/CPST connector is terminated with an impedance of 75 Ω automatically.

When S VIDEO is selected:

Connectors	Input signals
Y/CPST	Y signal
R-Y/C	C signal (3.58 MHz for DSR-1500/ 4.43 MHz for DSR-1500P)
B-Y	— (not usable)

When Y-R,B is selected:

Connectors	Input signals
Y/CPST	Y signal
R-Y/C	R-Y signal
B-Y	B-Y signal

2 AUDIO IN 1/3 and AUDIO IN 2/4 connectors (XLR-3 pin, female)

Use these connectors to input analog audio signals from an external video cassette player or other audio equipment. The signals input to these connectors are recorded on the audio channels determined by the current audio recording mode, as follows.

When in 2 CH (48 kHz) mode:

Input connectors	Audio channels on which input signals are recorded
AUDIO IN 1/3	Audio channel 1
AUDIO IN 2/4	Audio channel 2

When in 4 CH (32 kHz) mode:

Input connectors	Audio channels on which input signals are recorded
AUDIO IN 1/3	Audio channels 1 and 3
AUDIO IN 2/4	Audio channels 2 and 4

You can switch the audio recording mode with the REC MODE menu item (*see page 65*). The selection is indicated by the REC MODE display on the front panel.

2 Analog video/audio signal output section

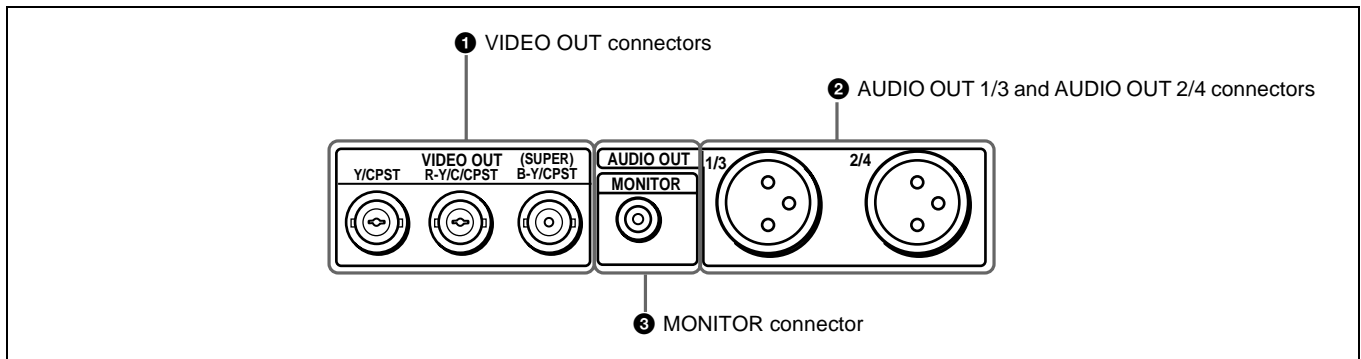

1 VIDEO OUT connectors (BNC type)

There are the following VIDEO OUT connectors for outputting analog video signals:

- Y/CPST
- R-Y/C/CPST
- B-Y/CPST (SUPER)

The signals output from these connectors depend on the setting of the VIDEO OUTPUT menu item (*see page 67*). The setting is indicated by the VIDEO indicators in the OUTPUT signal display section on the front panel. The analog video signals that can be output from these connectors are as follows.

When COMPOSITE is selected:

Connectors	Output signals
Y/CPST	Composite signal
R-Y/C/CPST	Composite signal
B-Y/CPST (SUPER)	Composite signal

When the CHARA. DISPLAY menu item (*see page 60*) is set to ON (factory default setting), the B-Y/CPST (SUPER) connector outputs a composite video signal with superimposed text information.

When S-VIDEO is selected:

Connectors	Output signals
Y/CPST	Y signal
R-Y/C/CPST	C signal (3.58 MHz for DSR-1500/ 4.43 MHz for DSR-1500P)
B-Y/CPST (SUPER)	Composite signal

When the CHARA. DISPLAY menu item (*see page 60*) is set to ON (factory default setting), the B-Y/CPST (SUPER) connector outputs a composite video signal with superimposed text information.

When Y-R, B is selected:

Connectors	Output signals
Y/CPST	Y signal
R-Y/C/CPST	R-Y signal
B-Y/CPST (SUPER)	B-Y signal

2 AUDIO OUT 1/3 and AUDIO OUT 2/4 connectors (XLR-3 pin, male)

These connectors output analog audio signals. The output audio channels are determined by the playback audio mode and the setting (1/2 CH or 3/4 CH) of the AUDIO OUTPUT menu item (*see page 67*) as follows.

When in 2 CH (48 kHz or 44.1 kHz) mode:

Output connectors	Output audio channels
AUDIO OUT 1/3	Audio channel 1 (when 1/2 CH is selected) or silent (when 3/4 CH is selected)
AUDIO OUT 2/4	Audio channel 2 (when 1/2 CH is selected) or silent (when 3/4 CH is selected)

When in 4 CH (32 kHz) mode:

Output connectors	Output audio channels
AUDIO OUT 1/3	Audio channel 1 (when 1/2 CH is selected) or audio channel 3 (when 3/4 CH is selected)
AUDIO OUT 2/4	Audio channel 2 (when 1/2 CH is selected) or audio channel 4 (when 3/4 CH is selected)

The current playback audio mode is indicated by the PB Fs display on the front panel.

3 MONITOR connector (RCA phono jack)

This connector outputs audio signals for monitoring. The audio signals to be output from this connector can be selected with the MONITOR SELECT button and METER CH-1/2 3/4 button on the front panel.

3 Digital signal input/output section (optional DSBK-1501 Digital Input/Output Board)

The connectors in this section are available when the optional DSBK-1501 board is installed.

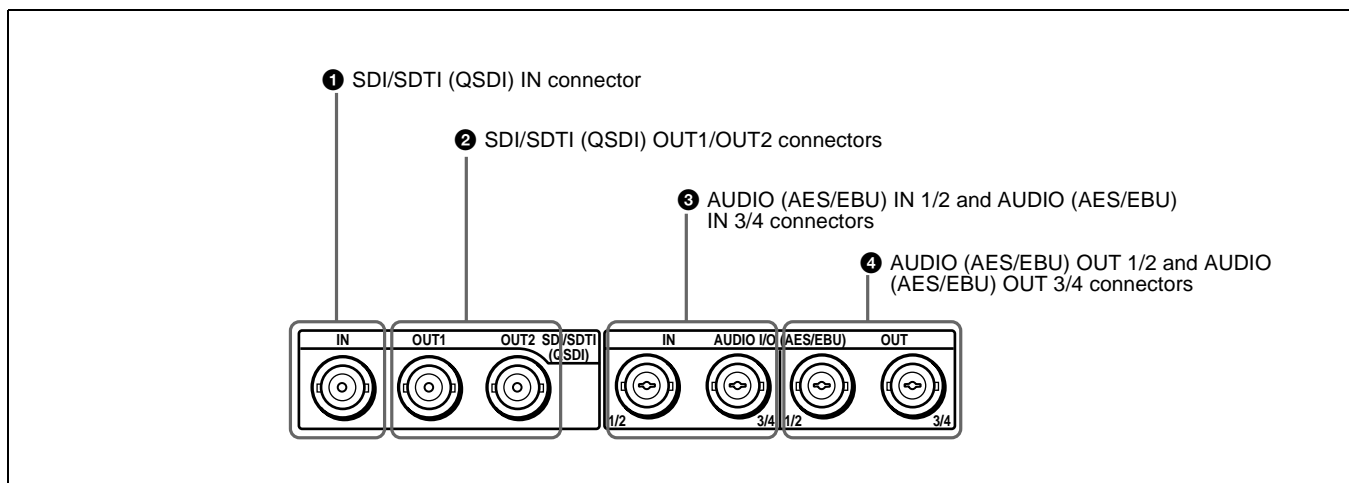

1 SDI/SDTI (QSDI) IN (Serial Digital Interface/Serial Data Transport Interface (QSDI) input) connector (BNC type)

This connector inputs digital video and audio signals in SDTI (QSDI) or SDI format. To select the required input signal formats, use the SDTI/i.LINK button or VIDEO button on the front panel. The current input signal selections are indicated in the INPUT signal display section on the front panel.

2 SDI/SDTI (QSDI) OUT1/OUT2 (Serial Digital Interface/Serial Data Transport Interface (QSDI) output 1/output 2) connectors (BNC type)

These connectors output digital video and audio signals in SDTI (QSDI) or SDI format. To select these output signal formats, use the DIGITAL OUTPUT menu item (*see page 67*). The current output signal selections are indicated in the OUTPUT signal display section on the front panel.

Note

When searching at speeds in the range $+1/2$ to $+1/30$ or $-1/2$ to $-1/30$ times normal speed, the audio signal output from these connectors in SDTI (QSDI) format and monitored on external equipment may sound differently from the audio signal played back on this unit.

3 AUDIO (AES/EBU) IN 1/2 and AUDIO (AES/EBU) IN 3/4 connectors (BNC type)

Input digital audio signals in AES/EBU format to these connectors. The left connector (1/2) is for audio channels 1 and 2, and the right connector (3/4) is for audio channels 3 and 4.

4 AUDIO (AES/EBU) OUT 1/2 and AUDIO (AES/EBU) OUT 3/4 connectors (BNC type)

These connectors output digital audio signals in AES/EBU format.

The left connector (1/2) is for audio channels 1 and 2, and the right connector (3/4) is for audio channels 3 and 4.

4 Time code input/output section

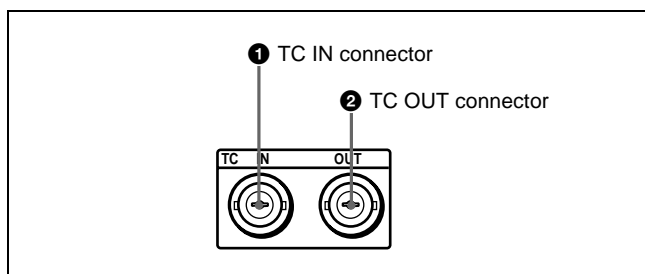

1 TC IN (time code input) connector (BNC type)

Input externally generated SMPTE time code (for DSR-1500) or EBU time code (for DSR-1500P) to this connector.

2 TC OUT (time code output) connector (BNC type)

This connector outputs a time code according to the operating state of the unit, as follows:

During playback: the playback time code

During recording: the time code generated by the internal time code generator or the time code input to the TC IN connector. When the EE OUT PHASE menu item (*see page 63*) is set to MUTE, no time code is output.



Usable Cassettes

This unit can use the DVCAM cassettes listed below.

Model name	Size
PDV-64ME/94ME/124ME/184ME	Standard size
PDVM-12ME/22ME/32ME/40ME	Mini size

The numbers in each model name indicate the maximum recording/playback time (in minutes) for each model. For example, the PDV-184ME has a maximum recording/playback time of 184 minutes.

Cassettes usable for playback only

All consumer DV cassettes and large- and medium-size DVCPRO (25 Mbps) cassettes are usable for playback only.

Notes

- If you insert an incorrect type of cassette, it will be automatically ejected.
- When operating this unit as a player, you can also use DV cassettes on the unit. However, it is the best choice to always use DVCAM cassettes because they are more reliable than DV cassettes whatever your purpose may be: playback, editing, or long-period storage of recordings.
- Cassettes that have been recorded by a DV-format recorder can be played back on this unit but cannot be used for recording at editing operation. When you insert such a cassette into this unit, the NO EDIT indicator lights up in the display section on the front panel of this unit.

DVCAM cassettes

The following figure illustrates the DVCAM cassettes.

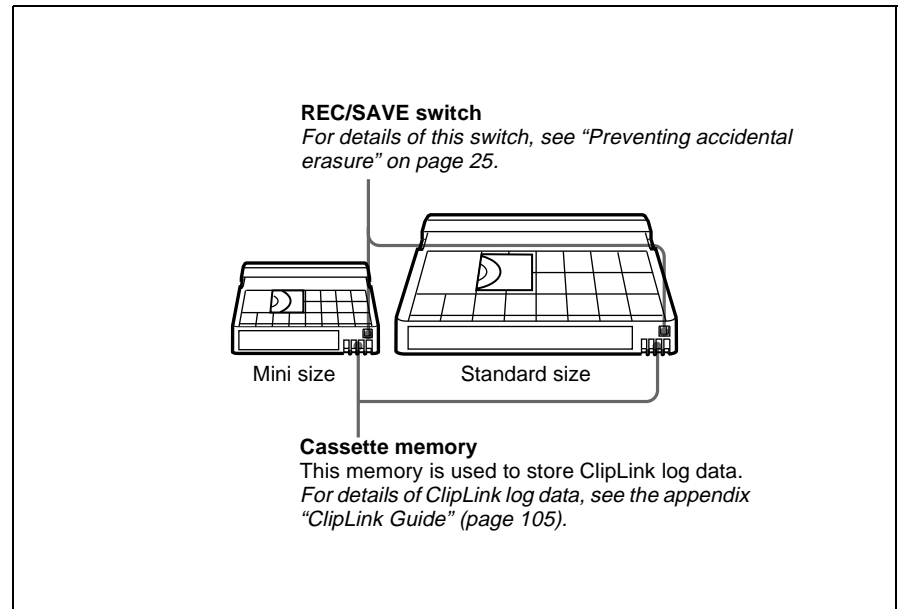

Notes on using cassettes

- Before storing the cassette for a long period of time, rewind the tape to the beginning and be sure to put the cassette in its storage case, preferably on end instead of flat on its side.
Storing a cassette in any other condition (not rewound, out of its case, etc.) may cause the video and audio contents to become damaged over time.
- If the cassette memory connector (contact point) becomes dirty, connection problems may occur, causing a loss of functions. Remove away any dust or dirt from this area before using the cassette.
- If the cassette is dropped on the floor or otherwise receives a hard impact, the tape may become slackened and may not record and/or play back correctly.

For information about how to check the tape for slack, see the next section.

Checking the tape for slack

Using a paper clip or a similar object, turn the reel gently in the direction shown by the arrow. If the reel does not move, there is no slack. Insert the cassette into the cassette compartment, and after about 10 seconds take it out.

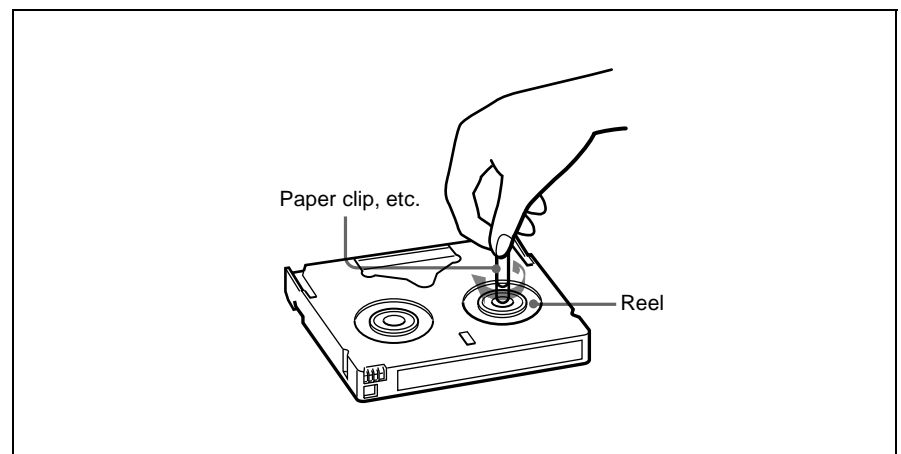

Preventing accidental erasure

Set the REC/SAVE switch on the cassette to SAVE to prevent accidental erasure of recorded contents.

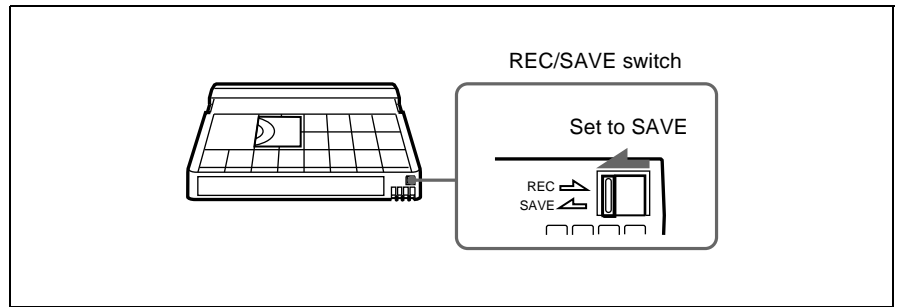

To enable re-recording

Set the REC/SAVE switch to REC.

When this switch is set to SAVE, the unit cannot record on the tape.

Inserting and Ejecting Cassettes

Inserting a cassette

This unit accepts three sizes of cassette: L (standard size), M (medium size: DVCPRO) and S (mini size). When inserting a cassette in the unit, make sure its tape window faces upward as shown in the following figure.

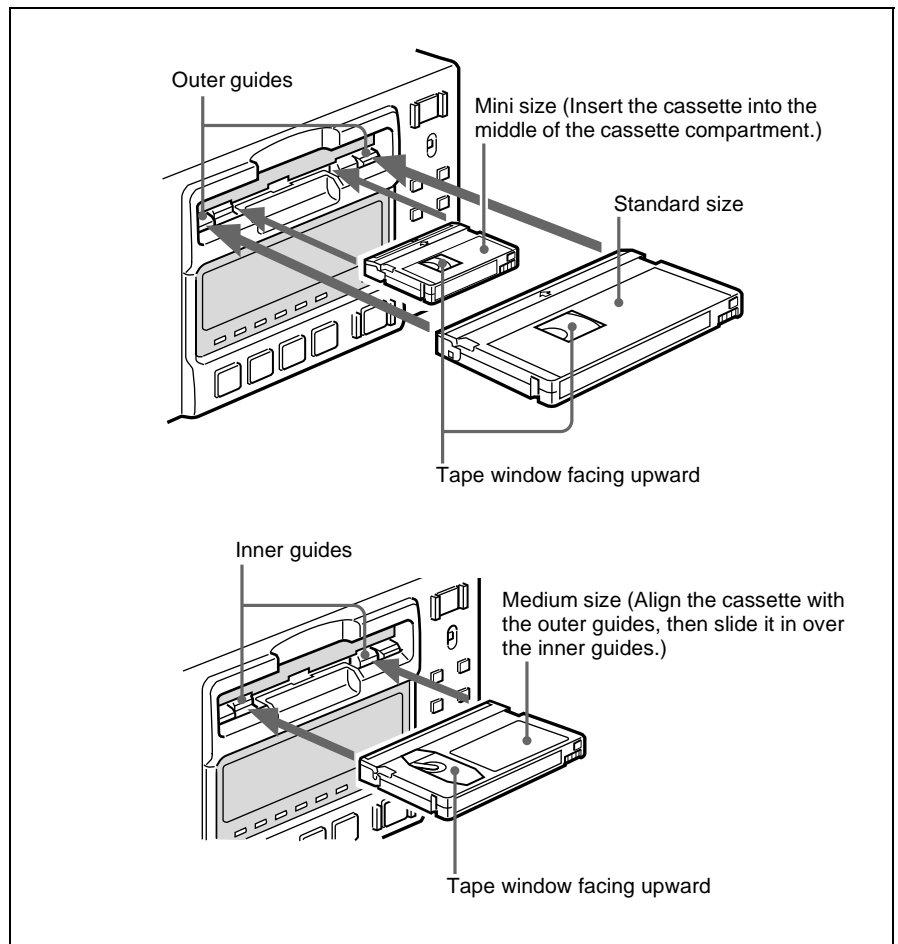

No double insertion of cassettes

When you insert a cassette, the orange lock-out plate appears in the cassette compartment to prevent double insertion.

Ejecting a cassette

Press the EJECT button.

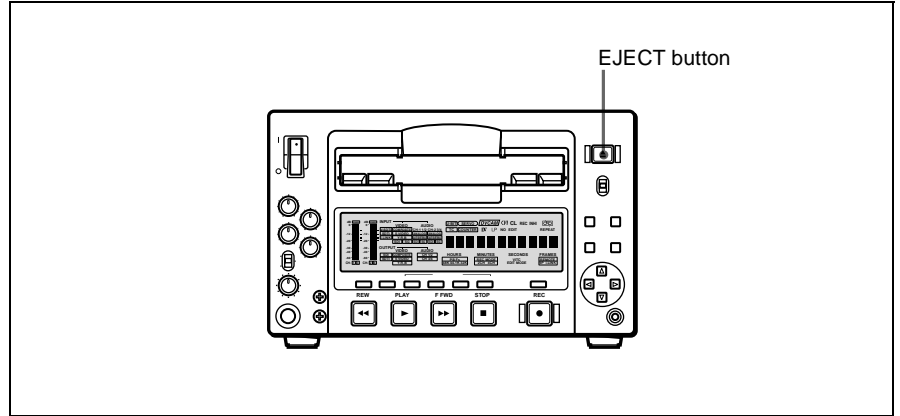

Recording

This section describes the necessary settings and operations to perform recording on this unit. The same settings and operations apply whether you are using the unit as part of an editing system, for dubbing, or as a stand-alone recorder.

For the necessary connections for recording and the settings not covered in this section, see Chapter 5 “Connections and Settings.”

For dubbing of SDTI (QSDI) format signals, use the AUTO FUNCTION menu item SDTI DUBBING (see page 71). For details, see “Digitally Dubbing Signals in DVCAM Format” on page 51.

Note

When using the unit as a recorder, the optional boards corresponding to the input signal formats to be used are required.

For details about the optional boards, see “Optional Accessories” (page 7).

Settings for Recording

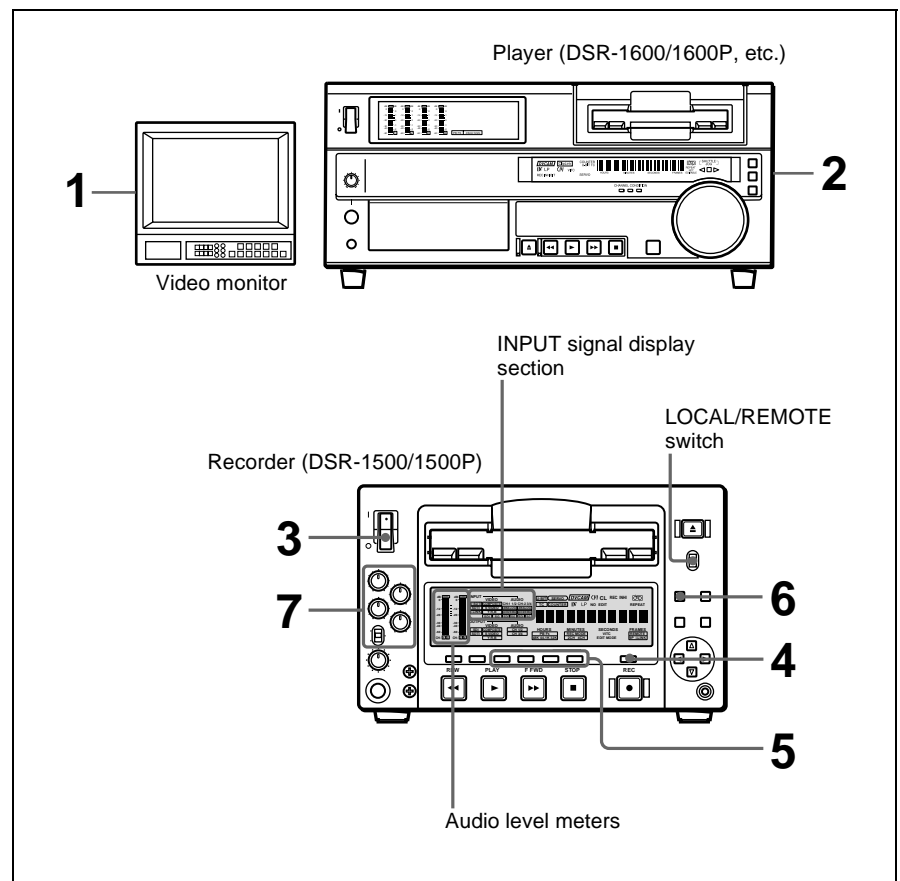

When controlling this unit from an editing control unit connected to the REMOTE connector, see “LOCAL/REMOTE switch” on page 9 and the description of the REMOTE I/F menu item on page 67.

- 1** Power on the video monitor, then set its input switches according to the signals input from this unit.
- 2** Set up the player to play back a tape.
For details, refer to the operating instructions for the player.
- 3** Power on this unit by pressing on the | side of the POWER switch.
- 4** When the REMOTE indicator is off (the external editing control unit is not used), use the COUNTER SELECT button to select the type of time data to be used.

Each press of this button cycles through three options: COUNTER (CNT value), TC (time code), and U-BIT (user bit data). The time data type indicator for each option lights as it is selected.

Selected time data	Time data type indicator
Count value of the time counter	COUNTER
Time code	TC
User bit data	U-BIT

When the REMOTE indicator is lit, selection of the time data type is carried out at the editing control unit.

- 5** Select the formats of video and audio input signal to be recorded. Use the INPUT SELECT buttons in the video/audio input setting section to select the desired signal formats. Each selection is shown by a lit indicator in the INPUT signal display section.

Video input signal (input connector)	Corresponding INPUT SELECT button	Lit indicator in the INPUT signal display section ^{a)}
Composite signal (VIDEO IN: Y/CPST)	VIDEO	COMPOSITE in VIDEO group
Separated Y/C signal (VIDEO IN: Y/CPST and R-Y/C)	VIDEO	S VIDEO in VIDEO group
Component signal (VIDEO IN: Y/CPST, R-Y/C, and B-Y)	VIDEO	Y-R,B in VIDEO group
SDI signal (SDI/SDTI (QSDI) IN)	VIDEO	SDI in VIDEO group
SDTI (QSDI) signal (SDI/SDTI (QSDI) IN)	SDTI/i.LINK	SDTI: both SDTI video and audio input signals are recorded. V:SDTI: only SDTI video input signal is recorded.
i.LINK-compatible digital video signal in DV format (i.DV IN/OUT)	SDTI/i.LINK	i.LINK
Internal test video signal	VIDEO	SG in VIDEO group

a) The indicators without the corresponding optional boards (DSBK-1501/1503/1504/1504P) installed in the unit do not light.

Audio input signal (input connector)	Corresponding INPUT SELECT button	Lit indicator in the INPUT signal display section ^{a)}
Analog signal (AUDIO IN 1/3 and AUDIO IN 2/4)	CH1 1/2 and CH2 3/4	ANALOG in AUDIO group
AES/EBU signal (AUDIO (AES/EBU) IN)	CH1 1/2 and CH2 3/4	AES/EBU in AUDIO group
SDI signal (SDI/SDTI (QSDI) IN)	CH1 1/2 and CH2 3/4	SDI in AUDIO group
SDTI (QSDI) signal (SDI/SDTI (QSDI) IN)	SDTI/i.LINK	SDTI
i.LINK-compatible digital audio signal in DV format (i.DV IN/OUT)	SDTI/i.LINK	i.LINK
Internal test audio signal	CH1 1/2 and CH2 3/4	SG in AUDIO group

a) The indicators without the corresponding optional boards (DSBK-1501/1503/1504/1504P) installed in the unit do not light.

Caution

Once you have started recording, you cannot change the input signal selection.

- 6** Select the audio mode.
 Select either two-channel mode (2 CHANNEL) or four-channel mode (4 CHANNEL) with the REC MODE menu item (*see page 65*). The corresponding indicator lights in the REC MODE display.

Audio mode	Lit indicator in the REC MODE display
2-channel mode	2CH
4-channel mode	4CH

Cautions

- In the DVCAM format, there are two audio recording modes, with either two channels at 48 kHz or four channels at 32 kHz. It is not possible to select other modes (for example with four channels at 48 kHz).
- During audio editing, if a signal used in assemble or insert editing is in a different mode from the base tape, the signals will be discontinuous at the edit points, and correct editing will not be obtained. For this reason, audio editing between different modes is inhibited on this unit.
 For smooth editing operations, check the audio recording mode of the base tape beforehand.
- Once you have started recording, you cannot change the audio mode selection.
- If on a tape there is a point where the audio mode is switched, it is not possible to carry out insert editing over a section including that point.
- When, in 4-channel mode, analog audio is selected for all four channels (channels 1/2 and 3/4), the same analog audio signals are recorded on channels 1 and 3 and on channels 2 and 4, respectively.

- 7** With the VAR switch on the front panel set to REC, use the REC/PB LEVEL control knobs to adjust audio input levels. Watching the audio level meter, adjust the level so that the meter does not indicate higher values than 0 dB when the audio signal is at its maximum. When the level exceeds 0 dB, the OVER indicator lights.

The factory-preset audio recording level is -20 dB (DSR-1500) or -18 dB (DSR-1500P). This setting can be changed using the LEVEL SELECT menu item (see page 66).

Recording Procedure

This section describes the procedure to perform recording on this unit, showing an example session in which playback signals coming from a player VCR will be recorded on the tape loaded in the unit.

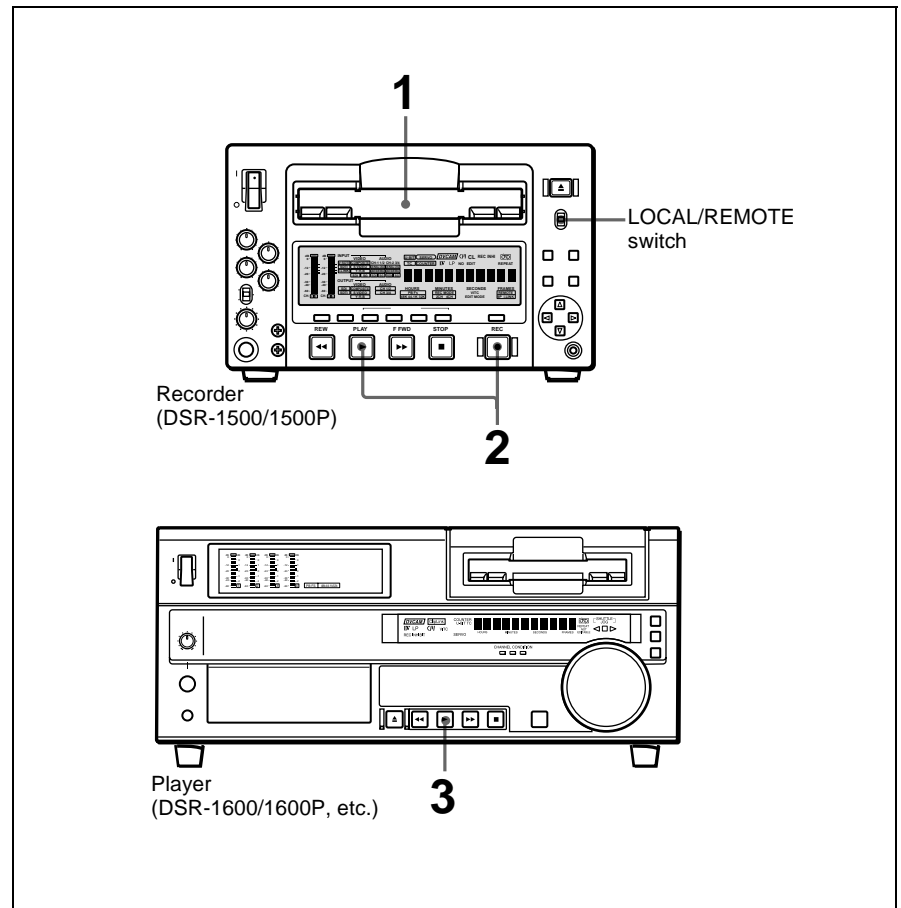

Notes

- When controlling this unit from an editing control unit connected to the REMOTE connector of this unit, set the LOCAL/REMOTE switch to REMOTE, turning the REMOTE indicator on. When not, set the switch to LOCAL, turning the indicator off.
- If you intend to use a tape recorded on this unit in a system comprising a DSR-85/85P and an ES-7 EditStation, it is recommended to record color bars on at least the first 40 seconds of the tape. When transferring digital signals from the DSR-85/85P to the ES-7 EditStation at four times normal speed, there must be recording for approximately 40 seconds before the IN point.

- 1 After checking the following items, hold the cassette with the tape window facing upward, then insert it into the recorder (this unit) as illustrated on page 25.

Item to check	See section
Make sure that the REC/SAVE switch of the cassette is set to REC.	"Preventing accidental erasure" on page 25
Check for tape slack.	"Checking the tape for slack" on page 24
Make sure that the "HUMID!" alarm is not shown in the time counter display.	"Condensation" on page 93

The cassette is automatically drawn into the unit and the tape is wound round the head drum. The tape is stationary while the head drum rotates, and the STOP button lights.

If the REC INHI indicator lights:

It indicates that the REC/SAVE switch of the loaded cassette has been set to SAVE. Press the EJECT button in the tape transport control section to remove the cassette, then set the REC/SAVE switch to REC and reload the cassette.

Note

When ejecting and loading cassettes, make sure that the unit has been powered on.

- 2 Hold down the REC button and press the PLAY button.

This puts the unit into recording mode, and the tape starts moving.

- 3 Press the PLAY button on the player.

The player starts the playback operation, at which point this unit starts recording the input playback signals.

Cautions

- Once you have started recording, you cannot change the audio mode selection.
- If on a tape there is a point where the audio mode is switched, it is not possible to carry out insert editing over a section including that point.

If the following indicators light when a cassette is loaded

Indicator	It means:
Cassette memory indicator	The loaded cassette contains a cassette memory.
CL indicator	<p>There is ClipLink log data stored in the cassette memory on the loaded cassette.</p> <p>Caution With such a cassette, carrying out recording destroys the ClipLink log data.</p>
NO EDIT indicator	<p>The recording format of the tape is "DV," or a DVCPRO tape is inserted. Replace the tape with one that has been recorded in DVCAM format.</p> <p>During editing operation The audio recording mode selected on this unit does not coincide with that of the tape. In this case, set the unit for the same audio recording mode as with the tape. However, If your current purpose is recording only, you can use the tape as it is.</p> <p><i>For more details, see "Troubleshooting" on page 96.</i></p>

To perform the following operations

Operation	Do this:
Stop recording.	Press the STOP button. The unit enters stop mode, and will automatically switch to standby off mode after the time period set with the STOP TIMER menu item (<i>see page 63</i>) for tape protection.
Remove the cassette.	Press the EJECT button. After a few seconds, the tape is unwound from the head drum and the cassette is automatically ejected. If a CNT value is shown on the time counter display (the time data type indicator "COUNTER" is lit), the CNT value is reset.
Inhibit the unit from outputting text information (time data, operation mode indications, etc.) to the video monitor.	Set the CHARA. DISPLAY menu item (<i>see page 60</i>) to OFF.
Change the time period before the unit switches from stop mode to standby off mode.	Change the setting of the STOP TIMER menu item (<i>see page 63</i>).

Playback

This section describes the settings and operations necessary to perform playback on this unit. The same settings and operations apply whether you are using the unit as part of an editing system, for dubbing, or as a stand-alone player VCR.

For the necessary connections for playback and the settings not covered in this section, see Chapter 5 “Connections and Settings” (page 79).

Settings for Playback

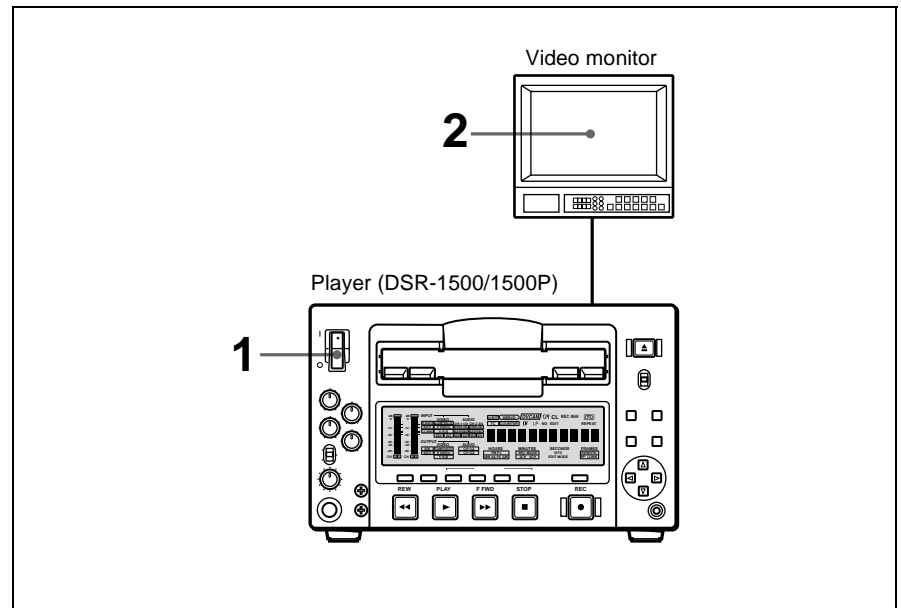

- 1** Power on this unit by pressing on the | side of the POWER switch.
- 2** Power on the video monitor and set its switches as shown below.

Switch	Setting
75 Ω termination switch	ON (or attach a 75 Ω terminator.)
Input switch	Set according to the type of input signal from this unit.

Playback Procedure

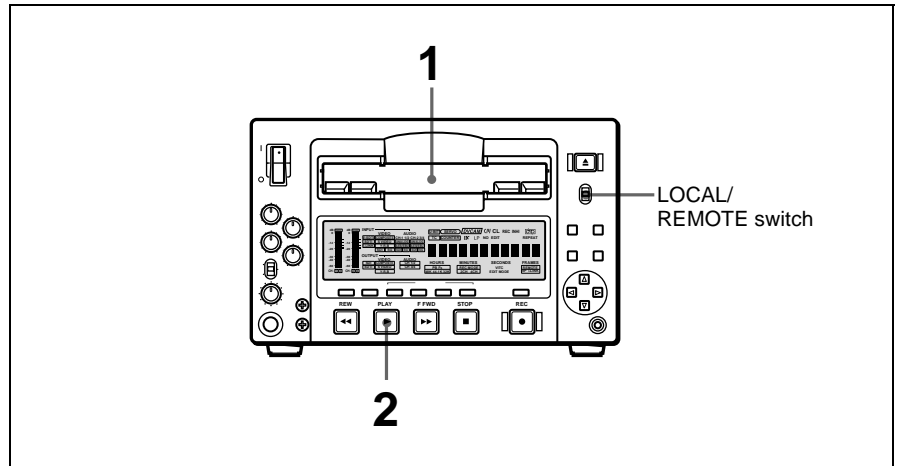

Note

When controlling this unit from an editing control unit connected to the REMOTE connector of this unit, set the LOCAL/REMOTE switch of this unit to REMOTE, turning the REMOTE indicator on. When not, set the switch to LOCAL, turning the indicator off.

1 Insert a cassette.

For details of cassette insertion see page 25, and for usable cassette types see page 23.

The cassette is automatically drawn into the unit and the STOP button lights. A few seconds later, if the STOP menu item under the AUTO EE SELECT menu item (*see page 59*) is set to PB, a still image will appear on the monitor screen.

2 Press the PLAY button.

This starts the playback operation. When the tape is played back all the way to the end, the unit automatically rewinds it and then stops.

If the following indicators light when a cassette is loaded

Indicator	It means:
Cassette memory indicator	The loaded cassette contains a cassette memory.
CL indicator	There is ClipLink log data stored in the cassette memory on the loaded cassette.
NO EDIT indicator	The tape was recorded in the DV format, or a DVCPRO tape is inserted. You cannot use it as a recording tape for editing.

To perform the following operations

Operation	Do this:
Stop playback.	Press the STOP button. The unit enters stop mode, and will automatically switch to standby off mode after the time set with the STOP TIMER menu item (see page 63) for tape protection.
Adjust the audio playback level.	Use the PHONES control knob on the front panel (outputs from the PHONES connector on the front panel and the MONITOR connector on the rear panel are adjusted).
Play back in shuttle mode while monitoring the video. ^{a)}	To carry out a high-speed search (10 times normal speed) in forward or reverse direction, press the ▷ or ◁ button. To return to normal-speed playback, press the PLAY button. Note When performing these operations, set the LOCAL/REMOTE switch on the front panel to LOCAL.
Play back in jog mode while monitoring the video. ^{a)}	To carry out frame-by-frame playback in forward or reverse direction, press the Δ or ▽ button. When you hold down the Δ or ▽ button, playback is continued in jog mode ($-1/2$ times normal speed) in forward or reverse direction. Note When performing these operations, set the LOCAL/REMOTE switch on the front panel to LOCAL.
Inhibit the unit from outputting text information (time data, operation mode indications, etc.) to the video monitor.	Set the CHARA. DISPLAY menu item (see page 60) to OFF.
Remove the cassette.	Press the EJECT button. If a CNT value is shown in the time counter display, the CNT value is reset.
Disable the automatic rewind function.	Set the AUTO REW menu item (see page 60) to DISABLE.
Change the time period before the unit switches from stop mode to standby off mode.	Change the setting of the STOP TIMER menu item (see page 63).

a) When the SEARCH ENABLE menu item (see page 59) is set to ENABLE.

Repeat Playback—Automatic Cyclical Playback

Proceed as follows to perform automatic cyclical playback of recording (repeat playback) between selected start and end points.

- 1** Set the desired repeat start and end points with the REPEAT FUNCTION menu item (*see page 58*).
You can set points A and B as start and end points by following the procedure described in the next section.
- 2** Set the REPEAT MODE menu item (*see page 58*) to ON.
The REPEAT indicator lights.
- 3** Press the SET (YES) button to save the new setting and close the menu.
- 4** Press the PLAY button.
The unit repeats playback between the repeat start and end points set in step 1.

Setting Points A and B for Repeat Playback

You can set the repeat playback start point (point A) and end point (point B) by using the current tape position or inputting time code values.

To perform repeat playback after setting points A and B, press the PLAY button when the REMOTE indicator is off. When the DSRM-10 Remote Control Unit is connected to the CONTROL S connector on the front panel, you can also start repeat playback by pressing its PLAY button with the REMOTE indicator of this unit off.

Note

When performing repeat playback using points A and B as the playback start and end points, make sure that the REPEAT TOP and REPEAT END menu items (*see page 58*) are set to A POINT and B POINT, respectively.

Setting the current tape position as point A or B

Proceed as follows to set the current tape position as point A or B for repeat playback.

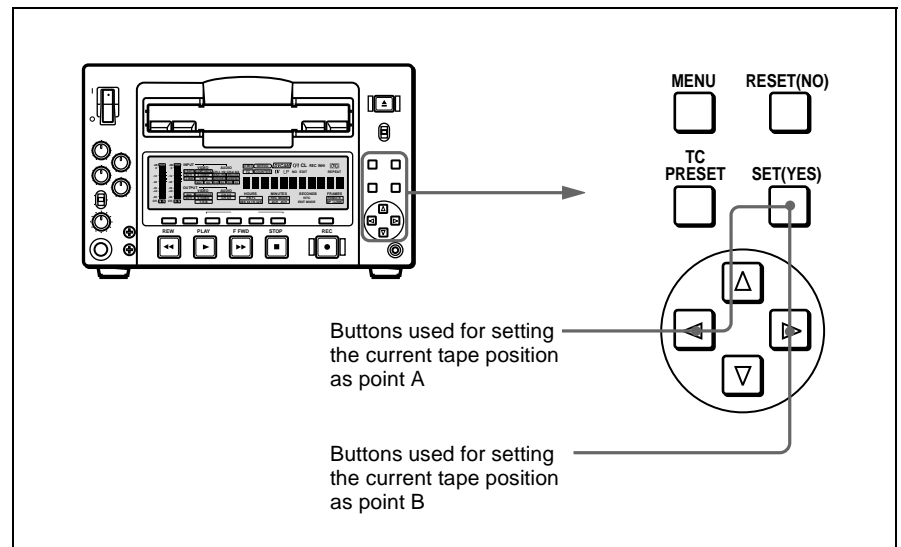

While holding down the SET (YES) button in the menu control section, press the ◀ or ▶ button. The time code value of the current tape position is set as point A or B, and a message "A set" or "B set" is displayed for 0.5 second in the time counter display.

Once set, the point A or B time code value is held in the non-volatile memory of the unit until changed. It is not lost when the unit is powered off.

Note

When setting point A or B, you can only use a time code value. Even when COUNTER is selected with the COUNTER SELECT button, you cannot use a CNT value to set point A or B.

To check the point A or B time code value

Press the ◀ or ▶ button in the menu control section. While the button is held down, the point A or B time code value is displayed on the monitor and in the time counter display.

If you hold down the ◀ and ▶ buttons simultaneously, the value shown is the point B time code value minus the point A time code value. If the point A time code value is greater than the point B time code value, a minus sign (-) is shown before the value.

Inputting time code values for points A and B

Using the following procedure, you can modify the time code value for point A or B.

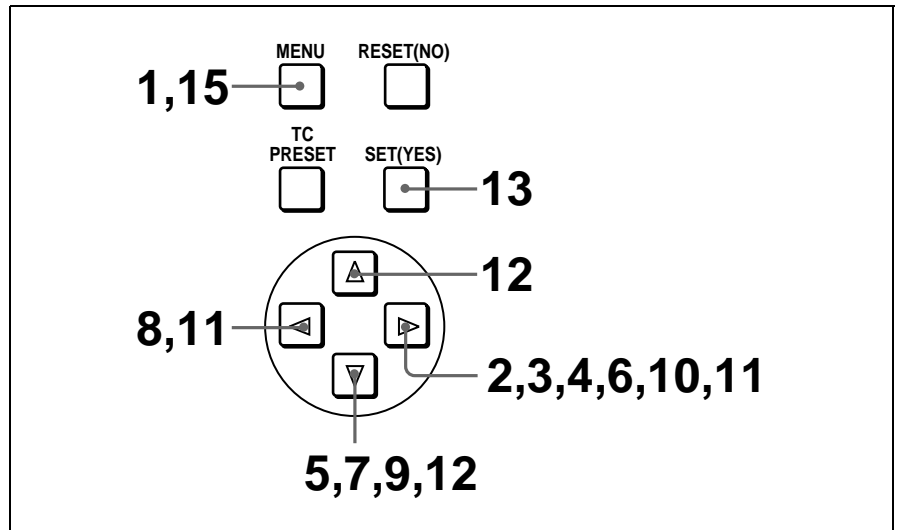

- 1 Press the MENU button.

The following menu display appears.

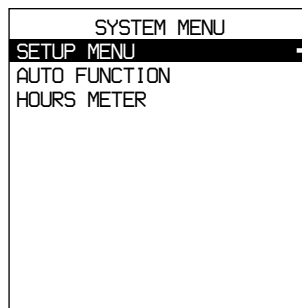

Monitor screen

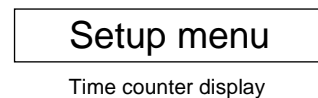

- 2 With "SETUP MENU" selected, press the ▷ button.

The display changes as follows.

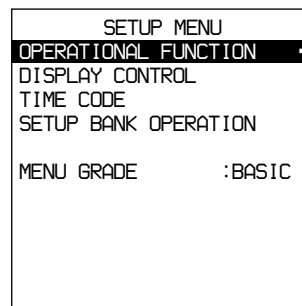

Monitor screen

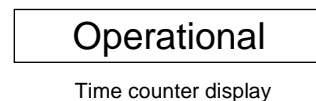

- 3** With “OPERATIONAL FUNCTION” selected, press the ▷ button.
The display changes as follows.

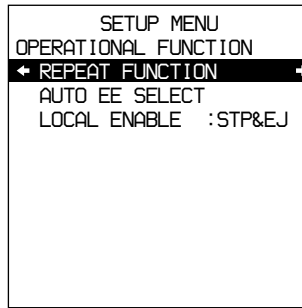

Monitor screen



Time counter display

- 4** With “REPEAT FUNCTION” selected, press the ▷ button.
The contents of the REPEAT FUNCTION menu item are displayed.

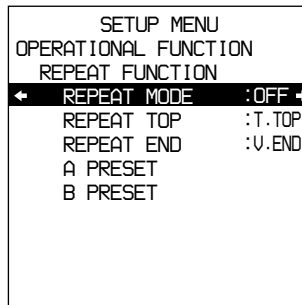

Monitor screen



Time counter display

- 5** Press the ▽ button to select “REPEAT TOP.”

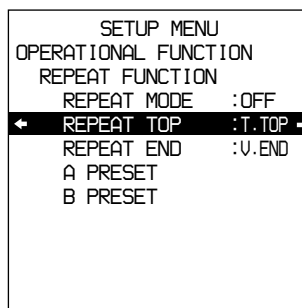

Monitor screen



Time counter display

6 Press the ▷ button.

The display changes as follows.

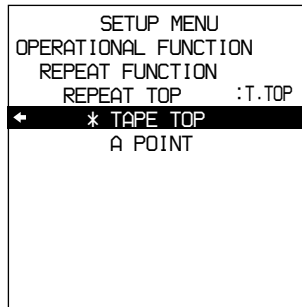

7 Press the ▽ button to select “A POINT.”

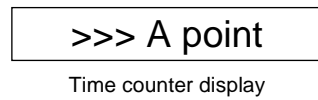
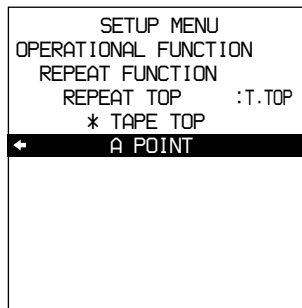

8 Press the ◀ button.

The display changes as follows.

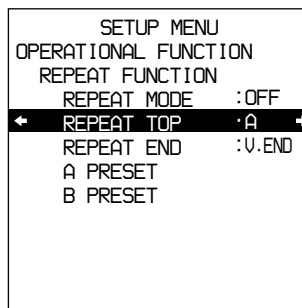

9 Press the ▾ button to select “A PRESET.”

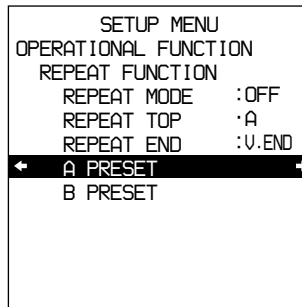

Time counter display

Monitor screen

10 Press the ▷ button.

The A PRESET MODE screen appears. The time code value of the current point A is displayed below the screen title.

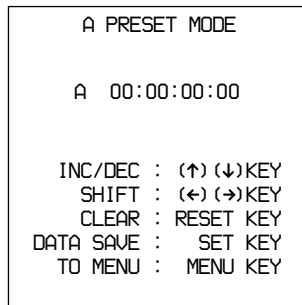

Monitor screen

11 Use the ◀ or ▶ button to select the digit in the time code value display that you want to change.

Each press of the button causes the digit to the left or right to begin flashing. Holding the button down moves the flashing digit continuously. If you want to clear the time code value, press the RESET (NO) button. The value is cleared to 00:00:00:00, and the leftmost digit begins flashing.

12 Press the Δ or ▽ button to increment or decrement the value of the flashing digit.

Each press of the button increments or decrements the value. Holding the button down increments or decrements the value continuously. To change other digits, return to step **11**.

13 Press the SET (YES) button to confirm the defined value.

The message “NOW SAVING...” is displayed on the monitor screen and “Saving...” is shown in the time counter display while the new setting is being saved in memory.

Caution

The new setting may be lost if you power off the unit during the saving operation. Wait until the saving operation is completed before powering the unit off.

If you want to discard the changed value

Press the MENU button instead of pressing the SET (YES) button to return to the menu display, then press the MENU button again to end the menu operation without saving the changed value into memory.

After the saving operation is completed, the monitor screen and time counter display return to the REPEAT FUNCTION setting display as shown in step 9.

14 To set point B, refer to steps 5 to 13. (Select “REPEAT END” in step 5, “B POINT” in step 7, and “B PRESET” in step 9.)

15 Press the MENU button to close the menu.

Cuing Up to Any Desired Position Set as Point A or B

You can set any desired tape position as point A or B and cue up to the set point when required. To cue up to point A or B, holding down the ◀ or ▶ button in the menu control section, press the REW button in the tape transport control section.

For the methods of setting points A and B, see the previous section.

Convenient Functions for Editing Operation

Chapter

3

Setting the Time Data

This unit is provided with the following functions related to time data.

- Display and reset CNT value
- Set, display, record, and play back SMPTE/EBU time code and user bit data
- Set, display, record, and play back VITC

The unit can output the time code read from the tape as an analog (LTC) signal while in normal-speed playback mode, and receive an external analog time code (LTC) signal.

Note

The unit outputs no signal from the TC OUT connector unless it is in normal-speed playback mode.

The following explains how to use these functions.

Displaying Time Data and Operation Mode Indications

Time data and operation mode indications can be displayed on the monitor screen.

Time data can also be displayed in the time counter display on this unit.

To view time data and operation mode indications on the monitor screen

Set the CHARA. DISPLAY menu item (*see page 60*) to ON (factory default setting).

The time data and the indication of the current operation mode are superimposed on the video signal that is being output from the B-Y/CPST (SUPER) connector, and can be viewed on the monitor screen.

Use the DISPLAY CONTROL menu items (*see page 60*) to select the information displayed and the character type and position of the indications.

When you set the SUB STATUS menu item (*see page 61*) to other than OFF, you can also display supplementary status information on the monitor screen such as editing mode settings and the operating mode of the internal time code generator.

For details of supplementary status information, see “Displaying Supplementary Status Information” on page 76.

Monitor screen contents

The contents of the monitor screen are shown below.

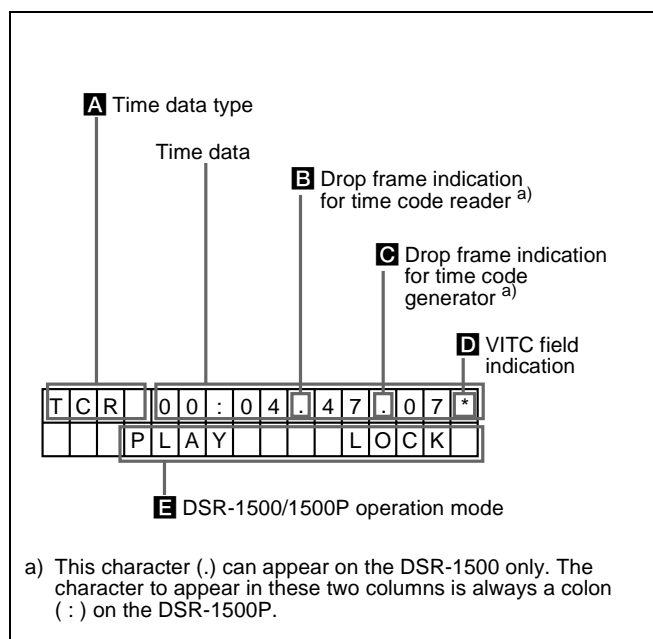

a) This character (.) can appear on the DSR-1500 only. The character to appear in these two columns is always a colon (:) on the DSR-1500P.

A Time data type

The following time data type indications are displayed.

Indication	Description
CNT	Count value of the time counter
TCR	Time code data from time code reader (factory default setting)
UBR	User bit data from time code reader
TCR.	Time code data from VITC reader ^{a)}
UBR.	User bit data from VITC reader ^{a)}
TCG	Time code data from time code generator
UBG	User bit data from time code generator
T*R ^{b)}	Time code data from time code reader. The asterisk indicates an interpolation by the time code reader to make up for the time code data not correctly read from the tape.
U*R ^{b)}	User bit data from the time code reader. The asterisk indicates that last data is retained by the time code reader, as the new data has not been read correctly from the tape.

a) You can switch between TC and VITC using the TC SELECT menu item (see page 62).

b) "*" is displayed when data cannot be read in correctly.

B Drop frame indication for time code reader (on DSR-1500 only)

.	Drop frame mode (factory default setting)
:	Non-drop frame mode

C Drop frame indication for time code generator (for DSR-1500 only)

.	Drop frame mode (factory default setting)
:	Non-drop frame mode

D VITC field indication

(blank)	Display fields 1 and 3.
*	Display fields 2 and 4.

E DSR-1500/1500P operation mode

Display	Operation mode
CASSETTE OUT	Cassette is not loaded.
THREADING	Tape loading
UNTHREADING	Tape unloading
STANDBY OFF	Standby off mode
T. RELEASE	Tape tension released
STOP	Stop mode
F. FWD	Fast forward mode
REW	Rewind mode
PREROLL	Preroll mode
PLAY	Playback mode (servo unlocked)
PLAY LOCK	Playback mode (servo locked)
PLAY-PAUSE	Temporary stop of playback
REC	Record mode (servo unlocked)
REC LOCK	Record mode (servo locked)
REC-PAUSE	Temporary stop of recording
EDIT	Edit mode (servo unlocked)
EDIT LOCK	Edit mode (servo locked)
JOG STILL	Still picture in jog mode
JOG FWD	Jog mode in forward direction
JOG REV	Jog mode in reverse direction
SHUTTLE (Speed)	Shuttle mode
AUTO EDIT	Automatic editing mode
PREVIEW	Preview mode
REVIEW	Review mode

To display the desired time data in the time counter display

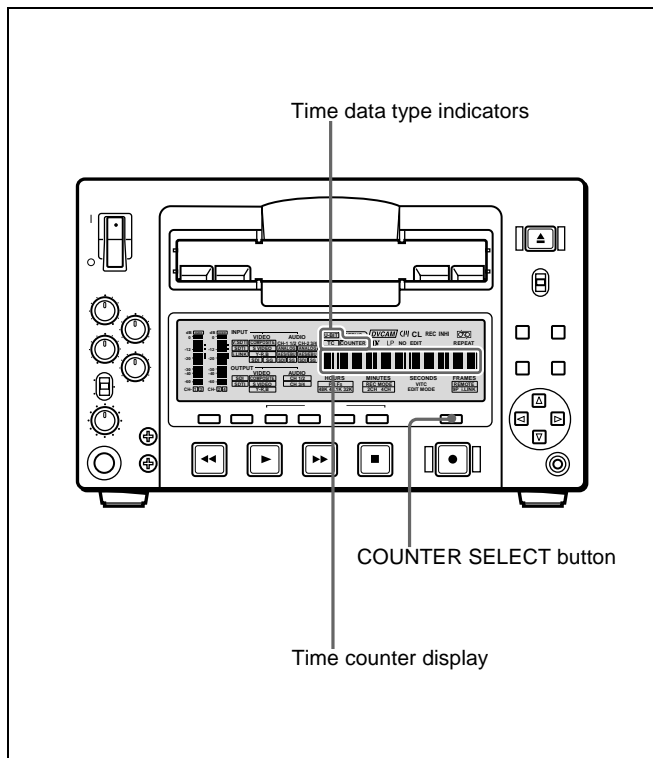

Press the COUNTER SELECT button on the front panel. Each press of this button cycles through three options: CNT value, time code, and user bit data. The time data type indicator for each option lights as it is selected.

Time data type indicator	Time data shown in the time counter display
COUNTER	CNT (count value of the time counter)
TC	Time code (when recording, the time code is generated by the internal time code generator; when playing back, the time code is read from the tape.)
U-BIT	User bit data (when recording, the user bit data is according to the most recent settings; when playing back, the user bit data is read from the tape.)

Note

When the REMOTE indicator in the front panel display section is lit, the COUNTER SELECT button does not operate while the tape is moving. In such cases, use the external equipment connected to the REMOTE connector on the rear panel to select the time data.

To reset the CNT value

Press the RESET (NO) button in the menu control section. This resets the CNT value to 0:00:00:00.

Note

During playback, if the recording on the tape includes discontinuities, the counter may operate incorrectly at the corresponding points.

Using the Internal Time Code Generator

You can set the initial time code value before recording the time code generated by the internal time code generator onto a tape. In addition, you can use the user bits to record such data as the date, time, scene number, reel number, or other useful information.

When an external time code generator is connected to the TC IN connector, the internal time code generator can be locked to (synchronized with) an external time code.

To set the initial time code value and user bit data

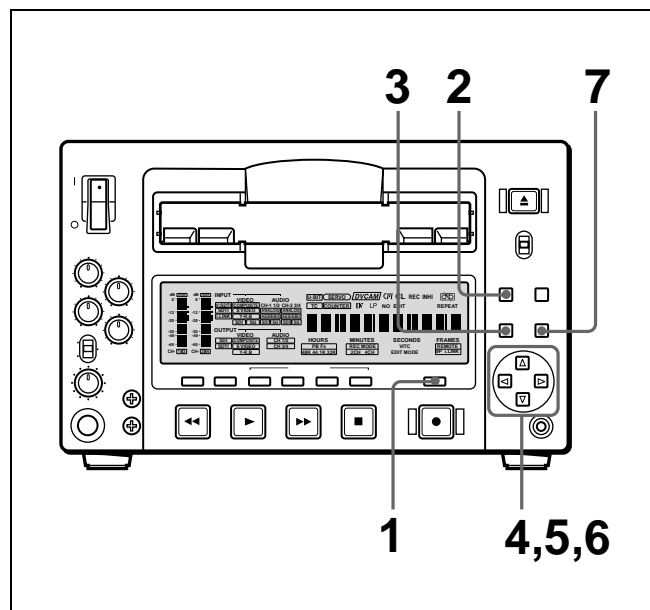

1 Press the COUNTER SELECT button to light the time data type indicator “TC” or “U-BIT.”

TC: To set the initial time code value

U-BIT: To set user bit data

The current time code value or user bit data is shown in the time counter display.

- 2** Set the TIME CODE menu items (*see page 62*) as shown below.

Menu item	Setting
TC MODE	"INT PRESET"
RUN MODE	"FREE RUN" or "REC RUN"
DF MODE (for DSR-1500 only)	Normally "ON (DF)"

- 3** Press the TC PRESET button in the menu control section.

The current setting is shown on the monitor screen and in the time counter display on the front panel. The leftmost digit keeps flashing.

One of the following menu screens is displayed on the monitor depending on the setting made in step **1**.

TC PRESET MODE	UB PRESET MODE
TCG 00:00:00:00	UBG 00:00:00:00
INC/DEC : (↑)(↓)KEY SHIFT : (←)(→)KEY CLEAR : RESET KEY DATA SAVE : SET KEY ABORT : TC PRESET KEY	INC/DEC : (↑)(↓)KEY SHIFT : (←)(→)KEY CLEAR : RESET KEY DATA SAVE : SET KEY ABORT : TC PRESET KEY

Initial time code value setting screen

User bit setting screen

Note

If you press the TC PRESET button while CNT value is being displayed, the message "COUNTER MODE IS SELECTED." will appear on the monitor screen and "CNT mode!" will appear in the time counter display on the front panel. If this happens, press the COUNTER SELECT button to light the time data type indicator "TC" or "U-BIT."

- 4** Use the ◀ and ▶ buttons to move the flashing digit to the value to be changed.
- 5** Use the ▲ and ▼ buttons to change the value of the flashing digit.
- Enter hexadecimal values (0 to 9, A to F) when setting user bit data.
- 6** Repeat steps **4** and **5** until you have set the desired values for all digits.
- To set a value of 00:00:00:00, simply press the RESET (NO) button.

- 7** Press the SET (YES) button.

The message "NOW SAVING..." appears on the monitor screen, "Saving..." appears in the time counter display, and the new settings are stored in memory. After this saving operation is completed, the monitor screen and the time counter display return to their usual status.

Note

The set data may be lost if you power off the unit while the above saving operation is in progress. Wait until the saving operation is completed before powering off.

Advancement of internal time code generator

The internal time code generator can advance in either of two modes, which can be set with the RUN MODE menu item (*see page 62*).

FREE RUN: Advancement starts when the data saving operation is completed.

REC RUN: Advancement starts when recording starts and stops when recording stops.

To set the current time as the initial time code value

In step **2** above, set the RUN MODE menu item to FREE RUN, then set the current time (format: HH:MM:SS:FF = hours: minutes:seconds:frame number) in step **3** and subsequent steps.

Synchronizing Internal and External Time Codes

The internal time code generator can be synchronized with an external time code (LTC) input to this unit.

To synchronize the internal time code to external time code

Input an external time code (LTC) signal to the TC IN connector, then set the TC MODE menu item (*see page 62*) to EXT REGEN.

The internal time code generator locks onto the external time code and starts advancing. Once the internal time code generator has been synchronized in this way, you can disconnect the external time code input and this unit will maintain the synchronized time code.

Note

When the selected input mode is "SDTI" or "i.LINK" (the SDTI or i.LINK indicator is lit in the INPUT signal display section), setting the TC MODE menu item to EXT REGEN causes the internal time code generator to

automatically synchronize with the external time code input to the unit via the SDTI or i.LINK interface.

Once an external time code signal has been input, the internal time code advancement mode and frame count mode are automatically set as follows:

Advancement mode: FREE RUN

Frame count mode: Same as external time code (drop frame or non-drop frame)

To confirm external synchronization

Press the STOP button to put the unit into stop mode, then press the REC button.

Look at the time counter display and check that the time code value displayed there matches the external time code value.

Rerecording the Time Code—TC Insert Function

The TC insert function makes it possible to use the internal time code generator to rewrite time code or user bits when the time code recorded on a tape is discontinuous. You can start recording time code from an initial value which can be set freely (*see page 45*).

Notes

- Use a tape which is recorded in the DVCAM format. (You cannot use the TC insert function with a tape recorded in DV format.)
- The time code recording starts from the current tape position. Cue the tape up beforehand to the required start position.
- If you use a tape on which ClipLink log data is recorded, the ClipLink log data will be lost.

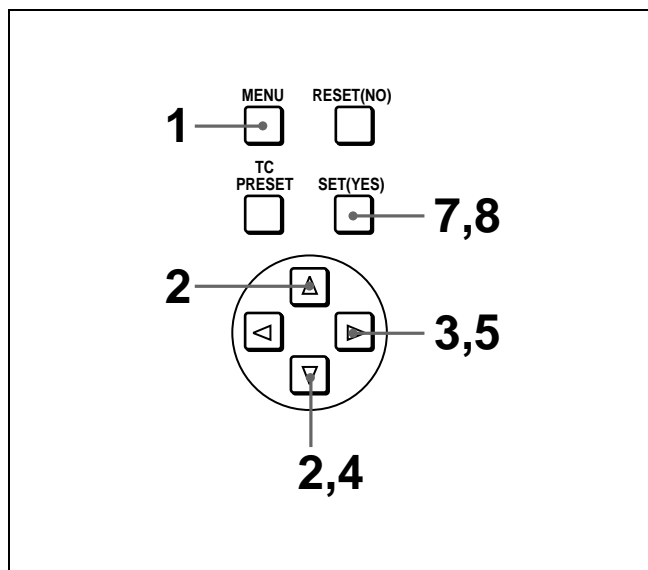

- 1 Press the MENU button in the menu control section.

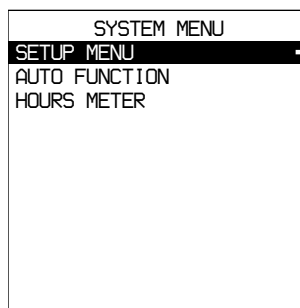

Monitor screen

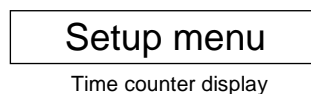

Setup menu

Time counter display

2 Press the Δ or ∇ button to select “AUTO FUNCTION.”

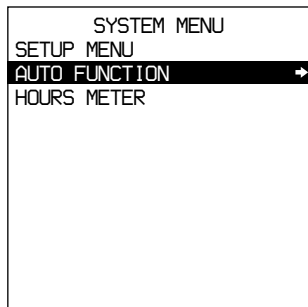

Monitor screen

Auto func

Time counter display

5 Press the \triangleright button.

The following message appears.

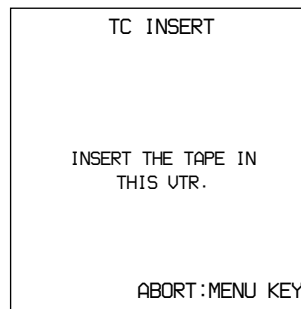

Monitor screen

Set tape!

Time counter display

3 Press the \triangleright button.

This displays the items in the level 1 of the auto mode execution menu.

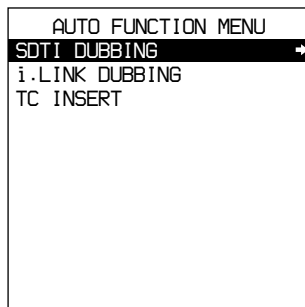

Monitor screen

SDTI DUB

Time counter display

6 Insert the cassette.

A message to confirm the TC insert operation appears.

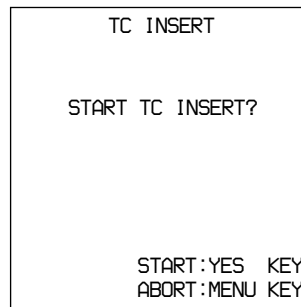

Monitor screen

TC insert?

Time counter display

4 Press the ∇ button to select “TC INSERT.”

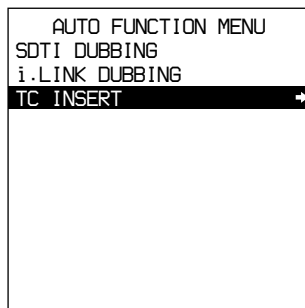

Monitor screen

TC insert

Time counter display

To cancel the TC insert operation
Press the MENU button.

7 Press the SET (YES) button.

Time code recording starts from the current tape position.

```
TC INSERT

EXECUTING.

TCR 00:00:00:00
UBR 00:00:00:00

ABORT:MENU KEY
```

Monitor screen

```
Executing
```

Time counter display

When the recording ends, the message “TC INSERT COMPLETED. PUSH THE YES BUTTON.” appears on the monitor screen and “Completed” appears in the time counter display.

8 Press the SET (YES) button to exit the menu.

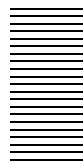

High-Speed and Low-Speed Search—Quickly and Accurately Determining Editing Points

Use the search function to easily locate the desired scene and to quickly and accurately determine edit points.

When F. FWD/REW under the AUTO EE SELECT menu item (*see page 59*) is set to PB (factory default setting), you can use the F FWD and REW buttons on this unit or external equipment for high-speed search.

Search Operations via External Equipment

You can control the unit in the following operation modes from an editing control unit (ES-7, PVE-500, etc.) connected to the REMOTE connector on the rear panel, a SIRCS-compatible remote control unit such as the DSRM-10 connected to the CONTROL S connector (on the front panel), or control equipment connected to the i.DV IN/OUT connector.

Shuttle: Use this mode to view color video playback at speeds ranging from 0 to 60 times normal speed in both directions.

Note

When controlling the unit from the DSRM-10 for shuttle-mode search, the maximum search speed is 16 times normal speed in both directions.

Jog: Use this mode for low-speed search and frame-by-frame search.

Digital slow: Use this mode for noise-free color video playback at speeds ranging from 0 to $\frac{1}{2}$ times normal speed in both directions.

Still: Use this mode to view a still picture of any field.

Jog audio: Use this mode to monitor the audio at speeds ranging from 1 to $\frac{1}{30}$ times normal speed in both directions.

Note

When controlling this unit from external equipment, set the REMOTE I/F menu item (*see page 67*) and the LOCAL/REMOTE switch so that the remote mode indicators in the display section are on or off as follows.

- When using an editing control unit connected to the REMOTE connector:

Switch/menu item	Setting
LOCAL/REMOTE switch	REMOTE (REMOTE indicator lights.)
REMOTE I/F menu item	9PIN (9P indicator lights.)

- When using a SIRCS-compatible remote control unit connected to the CONTROL S connector:

Switch/menu item	Setting
LOCAL/REMOTE switch	LOCAL
REMOTE I/F menu item	—

- When using equipment connected to the i.DV IN/OUT connector:

Switch/menu item	Setting
LOCAL/REMOTE switch	REMOTE (REMOTE indicator lights.)
REMOTE I/F menu item	i.LINK (i.LINK indicator lights.)

For description on how to carry out search operations via external equipment, see the operating instructions for the equipment.

Digitally Dubbing Signals in DVCAM Format

In addition to straightforward tape dubbing, you can also use this unit to dub automatically from the beginning of the tape to the end through the SDTI (QSDI) or i.LINK interface.

- To use the SDTI (QSDI) interface, the optional DSBK-1501 board is required.
- To use the i.LINK interface, the optional DSBK-1503 board is required.

When a tape recorded on a DSR-1/1P Digital Videocassette Recorder or DSR-130/130P Digital Camcorder is dubbed, the ClipLink log data held in the cassette memory is also copied.

Notes

- Use a tape recorded in the DVCAM format. A tape recorded in DV format cannot be used as a source tape for dubbing through the SDTI (QSDI) or i.LINK interface.
- Regardless of the audio recording mode setting of this unit, dubbing is performed with the original audio recording mode unchanged (two-channel/48 kHz mode or four-channel/32 kHz mode).
- Approximately the last 2 minutes of the tape may not be copied because of differences in tape lengths. (If an index picture is recorded in this portion, it may also not be copied.)
- A continuous recorded section of approximately 5 seconds is required before the recording start point. It is recommended to record beforehand color bars or a similar signal at the start point of the source tape to be dubbed on this unit.

Connections for dubbing via SDTI (QSDI) interface

To carry out dubbing through the SDTI (QSDI) interface, connect the REMOTE and SDTI (QSDI) IN/OUT connectors on this unit to those on the DSR-85/85P/80/80P/60/60P/70/70P/2000/2000P/1800/1800P/1600/1600P/1500/1500P.

For details of the connections and switch settings, see "Connections for SDTI (QSDI) Dubbing" on page 89.

Connections for dubbing via i.LINK interface

To carry out dubbing through the i.LINK interface, connect the i.DV IN/OUT connectors on this unit and the player.

Use the following procedure.

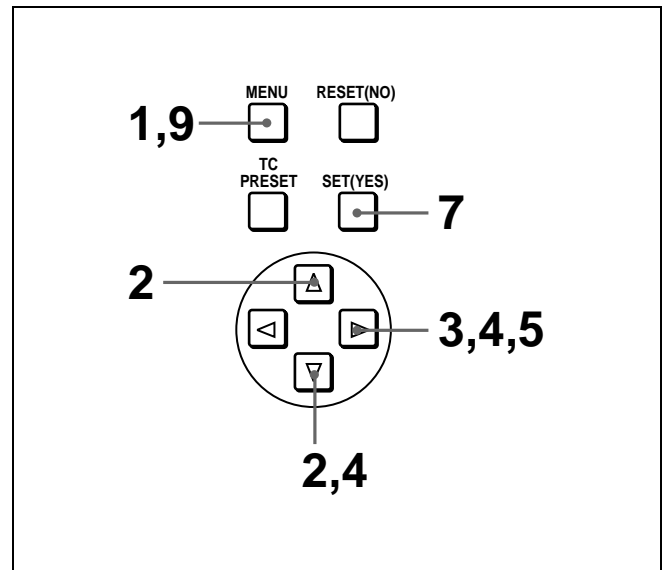

- 1 Press the MENU button in the menu control section.

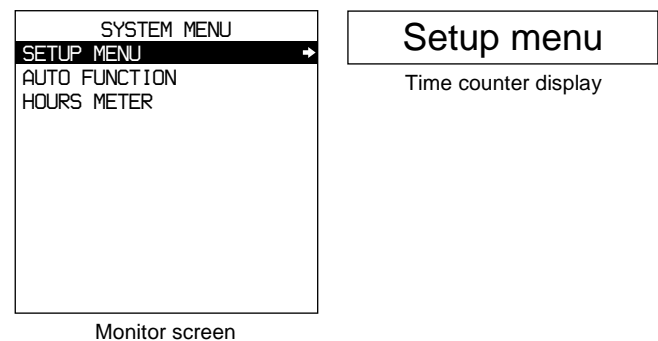

- 2 Press the Δ or ∇ button to select "AUTO FUNCTION."

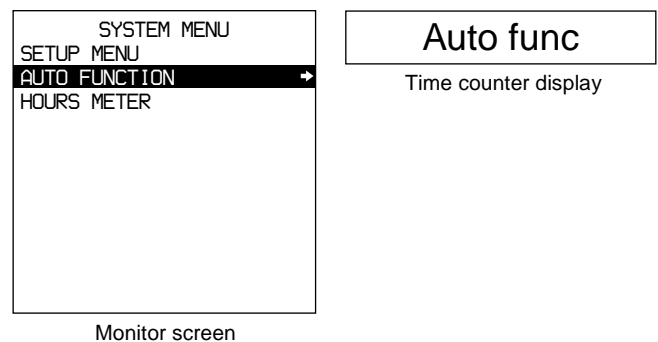

3 Press the \triangleright button.

This displays the items on level 1 of the auto mode execution menu.

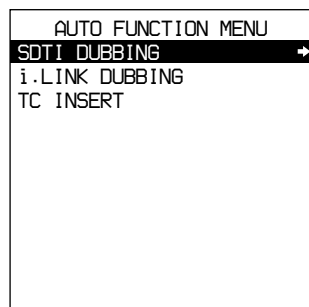

Monitor screen



Time counter display

6 Insert the source tape in the player, and the recording tape in this unit.

A message to confirm the dubbing operation appears.

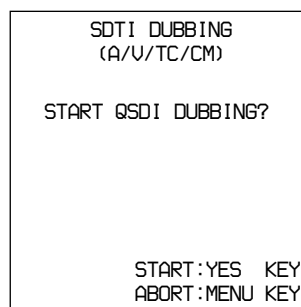

Monitor screen

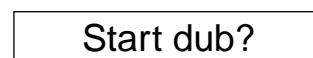

Time counter display

4 Press the \triangleright button to display the menu level 2 for the item "SDTI DUBBING," and select the data to be dubbed with the ∇ button.

Example: Selecting "A/U/TC/CM"

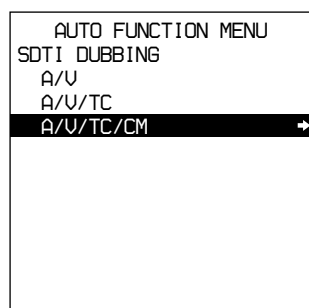

Monitor screen



Time counter display

To cancel the dubbing operation

Press the MENU button.

7 Press the SET (YES) button.

The tape is automatically wound back to the beginning, and dubbing starts.

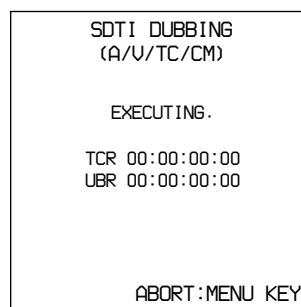

Monitor screen

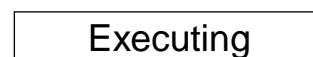

Time counter display

5 Press the \triangleright button.

The following message appears.

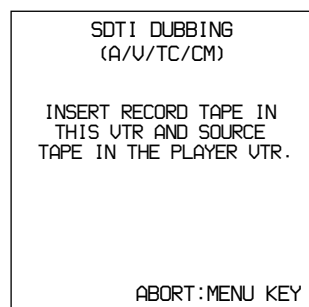

Monitor screen



Time counter display

To end the dubbing operation while it is in progress

Press the STOP button.

When the dubbing is completed, message "COMPLETED" appears on the monitor screen and "Completed" in the time counter display. The source tape and recording tape are both automatically rewound to the beginning, and the cassettes ejected. When the cassette is ejected, this unit returns to the state in step **5**.

8 To continue by dubbing another tape, repeat steps **6** and **7**.**9** When the dubbing is completed, press the MENU button to exit the menu.

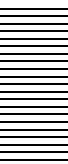

If the following message appears in step 6 for an A/V/TC/CM dubbing operation

```

SDTI DUBBING
(A/V/TC/CM)

CM MEMORY STORAGE
CAPACITY OF THE RECORD
TAPE IS TOO SMALL.

ABORT:MENU KEY

```

Monitor screen

CM capacity!

Time counter display

When carrying out A/V/TC/CM dubbing, if you insert the cassettes in step 6, the cassette memory capacity of the cassettes inserted in both this unit and the player are checked automatically.

If the cassette memory capacity of the source tape is larger than that of the recording tape, the above message appears. In this case, replace the recording tape by a tape with a larger cassette memory capacity.

If the following message appears in step 7 for an A/V/TC/CM dubbing operation

```

SDTI DUBBING
(A/V/TC/CM)

SDTI DUBBING IS ABORTED.
EXECUTE CM COPY?

COPY :YES KEY
NOT COPY:NO KEY

```

Monitor screen

Copy CM?

Time counter display

When carrying out A/V/TC/CM dubbing, if you press the STOP button to stop dubbing in step 7, or if dubbing stops because the source tape is longer than the recording tape, the above message appears to confirm whether or not to copy the contents of the cassette memory.

To copy the contents of the cassette memory, press the SET (YES) button.

If you do not wish to copy the contents of the cassette memory, press the RESET (NO) button. If you press the RESET (NO) button, however, the contents of the cassette memory may not agree with the material recorded on the tape.



Menu Organization

As shown in the following figure, the menu system consists of four levels and is functionally divided into three subsystems: the setup menu, the auto mode (AUTO FUNCTION) execution menu and the digital hours meter display menu.

This chapter mainly describes the setup menu, showing its contents and how to operate it.

For details of the AUTO FUNCTION menu, see “Digitally Dubbing Signals in DVCAM Format” on page 51 and “Rerecording the Time Code—TC Insert Function” on page 47.

For details of the digital hours meter display, see “Regular Checks” on page 93.

The items of the setup menu are divided into several functional groups on level 1, and except for the MENU GRADE item the settings themselves are made on level 2 or level 3.

Also, the menu items are divided into two categories according to how frequently they are accessed: the “basic” items, to which frequent access is normally required, and the “enhanced” items, which are less frequently used. In the following figure, the items shown in boldface are basic items, and the other items are enhanced items.

The menu settings are saved in non-volatile memory, which means they are not erased when you power off the unit after executing the setting operation.

Menu organization

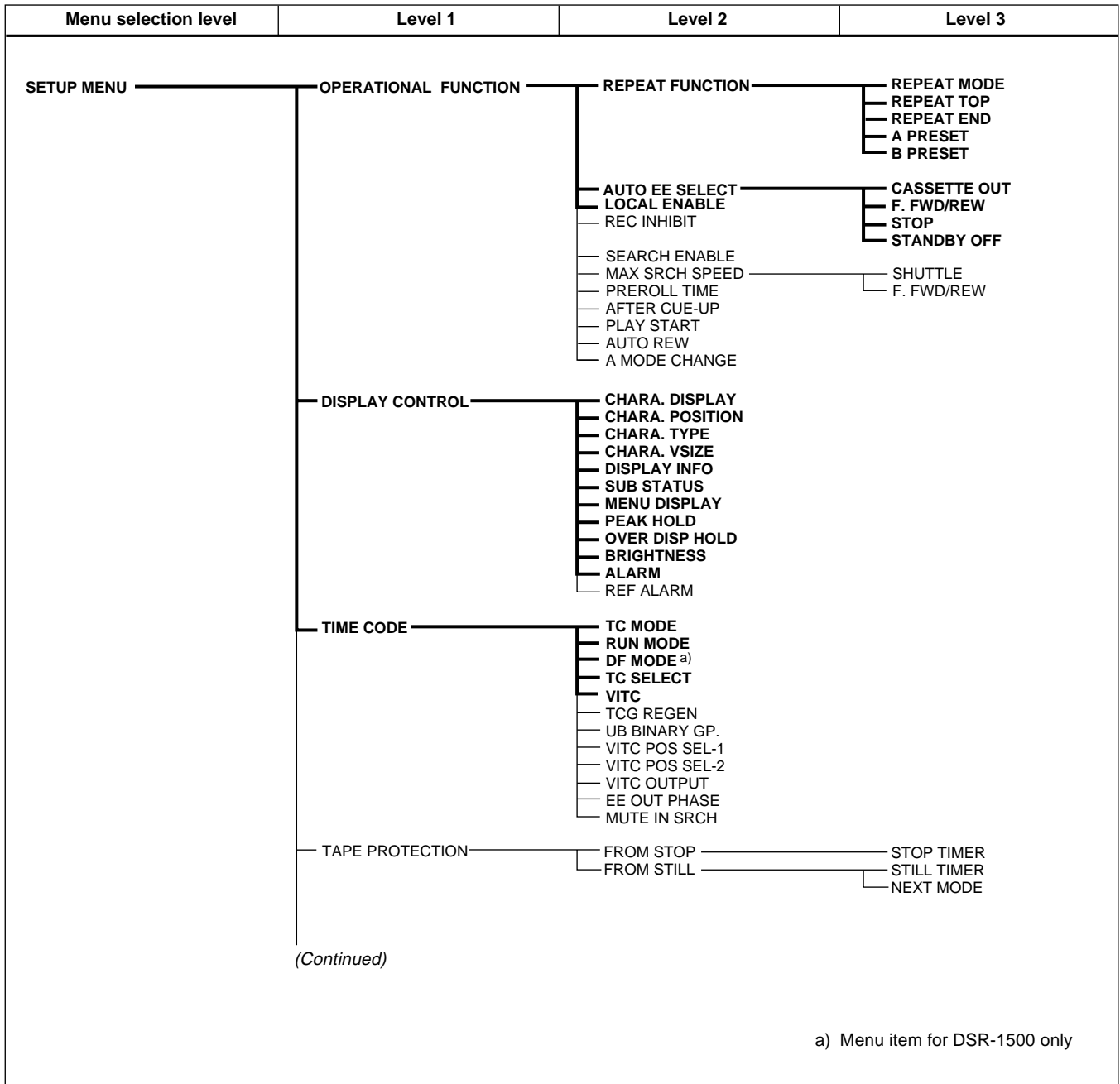

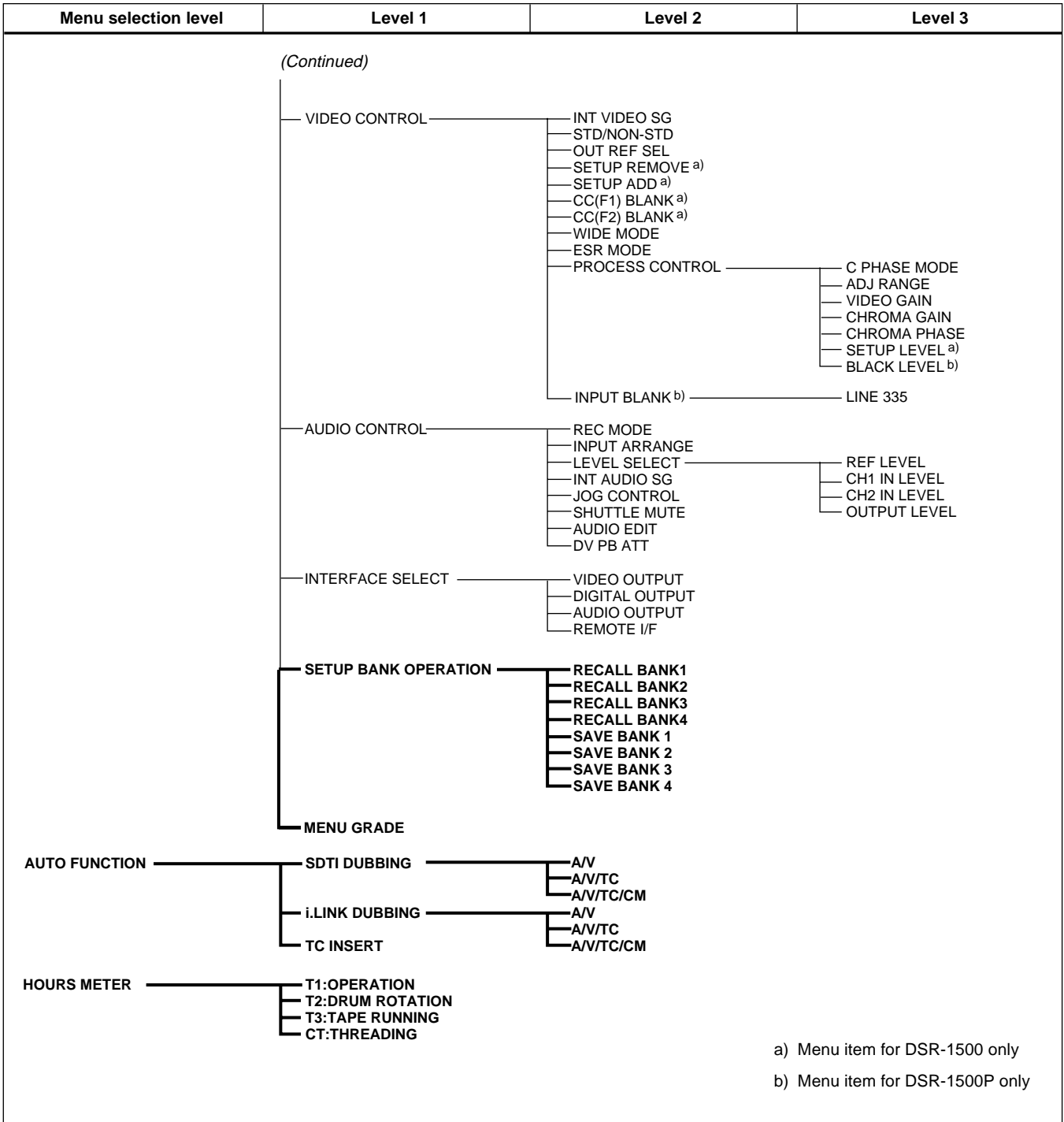

Menu Contents

Setup Menu

The purpose and settings of the setup menu items are described below.

Indications of menu items and settings

- In the table below entitled “Menu contents,” the indication of each menu item or setting on the monitor screen is shown first, then the indication of the same item or setting in the time counter display of this unit is shown in square brackets ([]).

Examples:

Indication on monitor screen	Indication in time counter display
OPERATIONAL FUNCTION	[Operational]
CASSETTE OUT	[>> Cass. out]
*EE	[>>> EE]

- Settings preceded by an asterisk (such as *EE) are factory default settings.
- In the time counter display, one to three “>” symbols may precede item or setting indications depending on the current menu level. Larger numbers of “>” symbols indicate lower menu levels.

Menu contents

OPERATIONAL FUNCTION [Operational]: Operation settings	Description of settings
REPEAT FUNCTION [> REP FUNC]: Make settings for repeat playback mode.	REPEAT MODE [>> REPEAT MD]: Determine whether or not to put the unit into repeat playback mode.
	REPEAT TOP [>> REP TOP]: Determine whether the repeat start point is the beginning of tape or point A.
	REPEAT END [>> REP END]: Determine whether the repeat end point is the end of the video recorded portion, the end of tape or point B.
	A PRESET [>> A preset]: Specify a time code value to be used as the setting of point A.
	B PRESET [>> B preset]: Specify a time code value to be used as the setting of point B.
	*OFF [>>> OFF]: Do not put the unit into repeat playback mode. ON [>>> ON]: Put the unit into repeat playback mode. ON (FREEZE) [>>> FREEZE]: Put the unit into freeze playback mode. In this case, while the unit is cueing up to the repeat start point, the freeze picture of the repeat end point is displayed.
	*TAPE TOP [>>> Tape top]: The repeat start point is the beginning of tape. A POINT [>>> A point]: The repeat start point is point A as set by the user.
	*VIDEO END [>>> VD end]: The repeat end point is the end of the video recorded portion. TAPE END [>>> Tape end]: The repeat end point is the end of tape. B POINT [>>> B point]: The repeat end point is point B as set by the user.
	<i>For details, see “Setting Points A and B for Repeat Playback” on page 36.</i>
	<i>For details, see “Setting Points A and B for Repeat Playback” on page 36.</i>

OPERATIONAL FUNCTION [Operational]: Operation settings		Description of settings
AUTO EE SELECT [> Auto EE]: Determine whether the unit enters EE mode or PB mode when audio and video signals from other equipment are input. When this unit is used as the recorder for cut editing, it is possible to output the input audio and video signals to the monitor. This enables editing operation to be carried out using a single monitor.	CASSETTE OUT [>> Cass. out]: Operations when the cassette has been ejected	*EE [>>> EE]: Output video and audio signals received from other equipment. PB [>>> PB]: Mute video and audio signals.
	F. FWD/REW [>> F. FWD/REW]: Operations when in fast forward or rewind mode	EE [>>> EE]: Output video and audio signals received from other equipment. *PB [>>> PB]: The unit enters playback mode and outputs a playback video signal. Audio signals are muted.
	STOP [>> STOP]: Operations when in stop mode	EE [>>> EE]: Output video and audio signals received from other equipment. *PB [>>> PB]: The unit enters playback mode and outputs a still picture.
	STANDBY OFF [>> STBY OFF]: Operations when in standby off mode	EE [>>> EE]: Output video and audio signals received from other equipment. *PB [>>> PB]: The unit enters playback mode and outputs a still picture.
LOCAL ENABLE [> Local ENA]: Select which of the tape transport control buttons (EJECT, REW, PLAY, F FWD, STOP, and REC) operate when the LOCAL/REMOTE switch is set to "REMOTE."		ALL DISABLE [>> All DIS]: All of the tape transport control buttons are disabled. *STOP & EJECT [>> STOP&EJ]: Only the STOP and EJECT buttons are enabled. ALL ENABLE [>> All ENA]: All of the tape transport control buttons are enabled, and settings such as preroll time change or time data display selection are effective.
REC INHIBIT [> REC INH]: Determine whether to prohibit recording on tape.		*OFF [>> OFF]: Do not prohibit recording on tape. ON [>> ON]: Prohibit recording on tape. (The REC INHI indicator in the display section lights.)
SEARCH ENABLE [> Search ENA]: Select whether to enable playback in shuttle/jog mode by the use of the arrow ($\Delta \nabla \triangleleft \triangleright$) buttons.		*DISABLE [>> DISABLE]: Do not enable. ENABLE [>> ENABLE]: Enable.
MAX SRCH SPEED [> Max SRCH]: Specify the maximum tape speed in search (shuttle) mode and F. FWD (fast forward)/REW (rewind) mode.	SHUTTLE [>> SHUTTLE]: Specify the maximum tape speed in search (shuttle) mode.	X60 [>>> X60]: Maximum 60 times normal speed *X32 [>>> X32]: Maximum 32 times normal speed X16 [>>> X16]: Maximum 16 times normal speed
	F. FWD/REW [>> F. FWD/REW]: Specify the maximum tape speed in F. FWD/REW mode.	MAX [>>> MAX]: No maximum tape speed is specified. *X85 [>>> X85]: Maximum 85 times normal speed X60 [>>> X60]: Maximum 60 times normal speed X32 [>>> X32]: Maximum 32 times normal speed Note When this item is set to MAX, the playback video signal is muted.
PREROLL TIME [> Preroll]: Set the preroll time.		15 SEC [>> 15 sec] to 0 SEC [>> 0 sec]: The preroll time can be set in one-second increments to between 0 and 15 seconds. A preroll time of at least 5 seconds is recommended when using this unit for editing. When an editing control unit such as the PVE-500 has been connected, this setting is disabled and the setting on the editing control unit is in effect. Operations such as the preroll time setting and the time data switching operation are also performed on the editing control unit. Factory default setting: 5 SEC [>> 5 sec]
AFTER CUE-UP [> After CUE]: Select the operating mode following cue-up.		*STOP [>> STOP]: Stop mode STILL [>> STILL]: Output still pictures in search mode.

OPERATIONAL FUNCTION [Operational]: Operation settings	Description of settings
PLAY START [> PLAY start]: Set the timing for switching from stop mode to playback mode. In an editing system including an editing control unit such as the PVE-500, you can adjust this setting so that the delay before switching to playback mode is the same on all the decks of the editing system. It is then no longer necessary to synchronize the decks for editing, and the preroll time can be shortened.	16 FRAME DELAY [>> 16 delay] to 4 FRAME DELAY [>> 4 delay]: The larger the numerical value, the longer the delay. Factory default setting: 5 FRAME DELAY [>> 5 delay] (for DSR-1500) or 4 FRAME DELAY [>> 4 delay] (for DSR-1500P)
AUTO REW [> Auto REW]: Select whether to rewind the tape automatically when recording or playback reaches the end of a tape.	DISABLE [>> DISABLE]: Do not rewind the tape automatically. *ENABLE [>> ENABLE]: Rewind the tape automatically.
A MODE CHANGE [> Aud change]: Determine whether or not to permit audio insert editing that uses a different audio recording mode (2- or 4-channel mode) from that which was used for the tape loaded in the recorder.	*OFF [>> OFF]: Do not permit. ON [>> ON]: Permit.

DISPLAY CONTROL [Display]: Settings related to indications on the monitor and the unit	Description of settings
CHARA. DISPLAY [> Chara disp]: Determine whether or not to output text (such as time code values) from the B-Y/CPST (SUPER) connector.	OFF [>> OFF]: Do not output text. (In spite of this setting, pressing the MENU button causes menu text to be output.) *ON [>> ON]: Output text.
CHARA. POSITION [> Chara pos]: Set the position of text superimposed on output from the B-Y/CPST (SUPER) connector to the monitor.	Use the $\Delta \nabla < \triangleright$ buttons in the menu control section to adjust the text position while watching the monitor screen. To return to level 1 of the setup menu, press the MENU button.
CHARA. TYPE [> Chara type]: Set the type of characters in text superimposed on output from the B-Y/CPST (SUPER) connector to the monitor.	Make the following settings while watching the monitor screen. *WHITE (WITH BKGD) [>> White]: White characters on black background BLACK (WITH BKGD) [>> Black]: Black characters on white background WHITE/OUTLINE [>> W/outline]: White characters with black outline BLACK/OUTLINE [>> B/outline]: Black characters with white outline
CHARA. VSIZE [> Chara size]: Determine the vertical size of characters such as time code output from the B-Y/CPST (SUPER) connector for superimposed display on the monitor.	Make the selection while watching the monitor screen. *x1 [>> x1]: Standard size x2 [>> x2]: 2 times standard size
DISPLAY INFO [> DISP info]: Select information superimposed on output from the B-Y/CPST (SUPER) connector to the monitor.	*TIME DATA & STATUS [>> Time&STA]: Time data and operating mode indications TIME DATA & UB [>> Time&UB]: Time data selected using the COUNTER SELECT button, and user bit data (When user bit data is selected using the COUNTER SELECT button, user bit data and time code are shown.) TIME DATA & CNT [>> Time&CNT]: Time data selected using the COUNTER SELECT button, and CNT value (When CNT is selected using the COUNTER SELECT button, CNT value and time code are shown.) TIME DATA & TIME [>> Time&Time]: Time data and VITC TIME DATA ONLY [>> Time]: Time data only REC DATE & TIME [>> REC Date]: The time data selected with the COUNTER SELECT button is shown in the time counter display, and the date and time of recording are shown on the monitor screen.

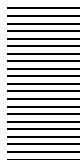

DISPLAY CONTROL [Display]: Settings related to indications on the monitor and the unit	Description of settings
SUB STATUS [> Sub status]: Select supplementary status information superimposed on output from the B–Y/CPST (SUPER) connector to the monitor.	*OFF [>> OFF]: Nothing of supplementary status information EDIT PRESET [>> Edit pre]: Indications of the editing mode settings made from the connected editing control unit TC MODE [>> TC mode]: Indications of the operating mode of internal time code generator REMAIN [>> Remain]: Remaining capacity of the tape AUDIO MIXING [>> Aud Mix]: Indications of input audio mixing ALL [>> ALL]: All of the above-mentioned items of supplementary status information <i>For details of supplementary status information displayed on the monitor when a setting other than OFF is selected, see "Displaying Supplementary Status Information" on page 76.</i>
MENU DISPLAY [> Menu DISP]: Set the type of characters in menu text superimposed on output from the B–Y/CPST (SUPER) connector to the monitor.	Make the following settings while watching the monitor screen. *WHITE (WITH BKGD) [>> White]: White characters on black background BLACK (WITH BKGD) [>> Black]: Black characters on white background WHITE/OUTLINE [>> W/outline]: White characters with black outline BLACK/OUTLINE [>> B/outline]: Black characters with white outline
PEAK HOLD [> Peak hold]: Set the peak hold time for the audio level meters.	1.5 SEC [1.5 sec] to OFF [>> OFF]: Set the peak hold time in the range of OFF (no peak hold) to 1.5 seconds in 0.1 second steps. Factory default setting: OFF [>> OFF]
OVER DISP HOLD [> Hold OVER]: Determine whether or not to hold the OVER indication display on the audio level meters once the indications light.	*OFF [>> OFF]: Do not hold the OVER indication display. ON (HOLD) [>> ON]: Hold the OVER indication display. Note With ON selected, once the display is held it will remain held unless you change the setting to OFF.
BRIGHTNESS [> Brightness]: Set the brightness of front panel indicators.	Set brightness as a percentage of the maximum. 100 % [>> 100%] *75 % [>> 75%] 50 % [>> 50%]
ALARM [> ALARM]: Determine whether alarm messages are issued or not.	OFF [>> OFF]: Alarm messages are not issued. *ON [>> ON]: Alarm messages are issued.
REF ALARM [> REF ALARM]: Determine whether alarm messages related to reference video signal are issued or not.	OFF [>> OFF]: Alarm messages are not issued. *ON (LIMITED) [>> ON (Limit)]: Alarm messages are issued only during recording mode, EE mode, REC-pause mode, and edit mode. ON [>> ON]: Alarm messages are issued.

TIME CODE [Time code]: Settings related to the time code generator	Description of settings
<p>TC MODE [> TC mode]: Determine the time code to use: internal time code using a preset initial value, regenerated internal time code (locked to time code read from tape), or external time code.</p>	<p>*INT PRESET [>> PRESET]: Use internal time code with a preset initial value.</p> <p>INT REGEN [>> REGEN]: Use internal time code locked to time code read from tape.</p> <p>EXT REGEN [>> EXT]: Use external time code selected as follows.</p> <ul style="list-style-type: none"> • When TC is selected External time code input to the TC IN connector • When VITC is selected The VITC time code present in the input video signal <p>Note When the selected input mode is SDTI or i.LINK (the V:SDTI, SDTI, or i.LINK indicator is lit in the INPUT signal display section), setting this item to EXT REGEN causes the internal time code generator to automatically synchronize with the external time code input to the unit via the SDTI or i.LINK interface.</p>
<p>RUN MODE [> RUN mode]: Select the advancement (RUN) mode of the time code generator.</p>	<p>*FREE RUN [>> FREE RUN]: Time code generator keeps running.</p> <p>REC RUN [>> REC RUN]: Time code generator only runs while recording.</p> <p>Note Set to FREE RUN when carrying out editing with an editing control unit. With the REC RUN setting, editing will not be carried out correctly.</p>
<p>(For DSR-1500 only)</p> <p>DF MODE [> DF mode]: Select whether the time code generator and time counter operate in drop frame mode or non-drop frame mode. Normally select drop frame mode to keep in synchronization with real time. The non-drop frame mode is useful for example when using computer graphics, and working on a frame count basis.</p>	<p>*ON (DF) [>> ON (DF)]: Drop frame mode</p> <p>OFF (NDF) [>> OFF (NDF)]: Non-drop frame mode</p>
<p>TC SELECT [> TC select]: Determine which to display in the time counter display, TC or VITC.</p>	<p>VITC [>> VITC]: Display VITC.</p> <p>*TC [>> TC]: Display TC.</p>
<p>VITC [> VITC]: Determine whether to record the internally generated time code as VITC.</p>	<p>OFF [>> OFF]: Do not record the internally generated time code as VITC. (VITC present in the input video signal is recorded unchanged.)</p> <p>*ON [>> ON]: Record the internally generated time code as VITC.</p>
<p>TCG REGEN [> TCG regen]: Select the signal to be regenerated when the time code generator is in the regeneration mode (i.e., when the TC MODE menu item is set to INT REGEN or EXT REGEN).</p>	<p>*TC & UB [>> TC & UB]: Both the time code and user bits are regenerated.</p> <p>TC [>> TC]: Only the time code is regenerated.</p> <p>UB [>> UB]: Only the user bits are regenerated.</p>
<p>UB BINARY GP. [> Binary Gp.]: Select the user bit binary group flag of the time code generator.</p> <p>Note When the TC MODE menu item is set to EXT REGEN, the user-bit binary group flag setting follows the setting on the time code input to this unit.</p>	<p>*000: NOT SPECIFIED [>> 000]: Character set not specified</p> <p>001: ISO CHARACTER [>> 001]: 8-bit characters conforming to ISO 646 and ISO 2022</p> <p>010: UNASSIGNED-1 [>> 010]: Undefined</p> <p>011: UNASSIGNED-2 [>> 011]: Undefined</p> <p>100: UNASSIGNED-3 [>> 100]: Undefined</p> <p>101: PAGE/LINE [>> 101]: Multiplex</p> <p>110: UNASSIGNED-4 [>> 110]: Undefined</p> <p>111: UNASSIGNED-5 [>> 111]: Undefined</p>

TIME CODE [Time code]: Settings related to the time code generator	Description of settings
VITC POS SEL-1 [> VITC pos-1]: Select a line to insert the VITC in. Note You can insert the VITC signal in two places. To insert it in two places, set both this item and also VITC POS SEL-2.	(For DSR-1500) 20 LINE [>> 20 line] to 12 LINE [>> 12 line]: Select any line from 12 to 20. Factory default setting: 16 LINE [>> 16 line]
VITC POS SEL-2 [> VITC pos-2]: Select a line to insert the VITC in. Note You can insert the VITC signal in two places. To insert it in two places, set both this item and also VITC POS SEL-1.	(For DSR-1500P) 22 LINE [>> 22 line] to 9 LINE [>> 9 line]: Select any line from 9 to 22. Factory default setting: 19 LINE [>> 19 line]
VITC POS SEL-2 [> VITC pos-2]: Select a line to insert the VITC in. Note You can insert the VITC signal in two places. To insert it in two places, set both this item and also VITC POS SEL-1.	(For DSR-1500) 20 LINE [>> 20 line] to 12 LINE [>> 12 line]: Select any line from 12 to 20. Factory default setting: 18 LINE [>> 18 line]
VITC POS SEL-2 [> VITC pos-2]: Select a line to insert the VITC in. Note You can insert the VITC signal in two places. To insert it in two places, set both this item and also VITC POS SEL-1.	(For DSR-1500P) 22 LINE [>> 22 line] to 9 LINE [>> 9 line]: Select any line from 9 to 22. Factory default setting: 21 LINE [>> 21 line]
VITC OUTPUT [> VITC out]: Select the time code to be output as VITC.	OFF [>> OFF]: Do not output VITC. TC [>> TC]: Output TC after converting it into VITC. *VITC [>> VITC]: Output VITC.
EE OUT PHASE [> EE out]: Determine the output phase for the LTC signal output from the TC OUT connector when recording time code and in STOP REC mode (forced EE mode).	*MUTE [>> mute]: Mute the output. THROUGH [>> through]: Output the time code input to the TC IN connector as it is. (See example configuration on page 69.) VIDEO INPUT PHASE [>> V input]: Output the time code with the same phase as the input video signal phase. (See example configuration on page 69.) VIDEO OUTPUT PHASE [>> V output]: Output the time code with the same phase as the output video signal phase. (See example configuration on page 70.)
MUTE IN SRCH [> Mute in SR]: Select whether to mute the output from the TC OUT connector in search (jog/shuttle) mode.	OFF [>> OFF]: Do not mute. *ON [>> ON]: Mute.

TAPE PROTECTION [Tape protct]: Settings related to tape and video head protection		Description of settings
FROM STOP [> From STOP]: Set the time to switch from stop mode to tape protection mode.	STOP TIMER [>> STP timer]: Set the time to switch from stop mode to tape protection mode.	0.5 SEC [>>> 0.5 sec] to 5 MIN [>>> 5 min]: Select time from 12 settings ranging from 0.5 second to 5 minutes in steps of 0.1 second. Factory default setting: 1 MIN [>>> 1 min]
FROM STILL [> From STILL]: Set the time to switch from still search mode to tape protection mode. Also select the type of tape protection mode.	STILL TIMER [>> STL timer]: Set the time to switch from still search mode to tape protection mode.	0.5 SEC [>>> 0.5 sec] to 5 MIN [>>> 5 min]: Select time from 12 settings ranging from 0.5 second to 5 minutes in steps of 0.1 second. Factory default setting: 1 MIN [>>> 1 min]
	NEXT MODE [>> Next mode]: Select the type of tape protection mode to follow still search mode when the time set with the STILL TIMER menu item elapses.	



VIDEO CONTROL [Video]: Settings related to video control	Description of settings
<p>INT VIDEO SG [> Video SG]: Select the test signal to be output from the internal test signal generator. When SG is selected using the VIDEO button in the video/audio input setting section, the internal test signal generator outputs the selected test signal. This signal can be recorded.</p>	<p>(For DSR-1500) *75% COLOR BARS [>> 75% bars]: 75% color bar signal BLACK BURST [>> BB]: Black burst signal</p> <p>(For DSR-1500P) *100% COLOR BARS [>> 100% bars]: 100% color bar signal 75% COLOR BARS [>> 75% bars]: 75% color bar signal BLACK BURST [>> BB]: Black burst signal</p>
<p>STD/NON-STD [> STD/N-STD]: Select the STD or NON-STD mode in accordance with the composite video or S-video input.</p>	<p>*FORCED STD [>> STD]: The STD mode is always used (forced STD mode). FORCED NON-STD [>> NON-STD]: Use this setting when the input video signal is unstable (forced NON-STD mode).</p>
<p>OUT REF SEL [> Out Ref]: Select the reference video signal to use.</p>	<p>*REF VIDEO [>> REF]: Use the signal input to a REF. VIDEO IN connector as the reference video signal. The input video signal to be edited is required to be in synchronization with the reference video signal. INPUT VIDEO [>> INPUT]: Use the input video signal selected with the VIDEO button in the video/audio input setting section.</p>
<p>(For DSR-1500 only) SETUP REMOVE [> Setup rmv]: Determine whether or not to remove black setup (7.5 IRE) from input analog video signals when converting them into digital signals.</p>	<p>*OFF [>> OFF]: Do not remove black setup. ON (REMOVE) [>> ON]: Remove black setup.</p>
<p>(For DSR-1500 only) SETUP ADD [> Setup add]: Determine whether or not to add black setup to analog video output signals.</p>	<p>*OFF [>> OFF]: Do not add black setup. ON (ADD) [>> ON]: Add black setup.</p>
<p>(For DSR-1500 only) CC(F1) BLANK [> CC1 blank]: Select whether to mute the closed caption signal to be superimposed on the 1st field of the output video signal.</p>	<p>*OFF [>> OFF]: Do not mute. ON [>> ON]: Mute.</p>
<p>(For DSR-1500 only) CC(F2) BLANK [> CC2 blank]: Select whether to mute the closed caption signal to be superimposed on the 2nd field of the output video signal.</p>	<p>*OFF [>> OFF]: Do not mute. ON [>> ON]: Mute.</p>
<p>WIDE MODE [> Wide mode]: Determine whether to retain wide-screen aspect ratio information accompanying video being recorded or played back.</p>	<p>*AUTO [>> Auto]: When video being recorded or played back is accompanied by wide-screen aspect ratio information, retain the information. OFF [>> OFF]: Ignore wide-screen aspect ratio information. ON [>> ON]: Whenever recording or playing back video, retain wide-screen aspect ratio information.</p>
<p>ESR MODE [> ESR mode]: Select whether to enable the edge subcarrier reducer (ESR).</p>	<p>*OFF [>> OFF]: Do not enable. ON [>> ON]: Enable. When playing back a composite signal, set this to ON.</p>

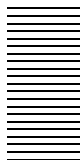

VIDEO CONTROL [Video]: Settings related to video control		Description of settings
PROCESS CONTROL [> Proc ctrl]	C PHASE MODE [>> C Phas MD]: Select the phase rotation mode for chroma phase control. The effect of this setting applies to the output levels of all of the composite video, S-video, SDI and component video signals.	* U/V (COMPOSITE) [>>> Cmpst]: Select this setting when observing the composite video output level using a composite vectorscope. PB/PR (COMPONENT) [>>> Cmpnt]: Select this setting when observing the component video output level using a component vectorscope.
	ADJ RANGE [>> Adj range]: Select the variable range of the VIDEO and CHROMA gains.	* -3 to +3 (dB) [>>> -3/+3]: -3 dB to +3 dB WIDE [>>> wide]: -∞ to +3 dB
	VIDEO GAIN [>> V gain]: Adjust the video output level.	000 [>>> 000] to 3FF [>>> 3FF] Factory default setting: 200H
	CHROMA GAIN [>> C gain]: Adjust the chroma output level.	000 [>>> 000] to 3FF [>>> 3FF] Factory default setting: 200H
	CHROMA PHASE [>> C phase]: Adjust the chroma phase.	00 [>>> 00] to FF [>>> FF] Factory default setting: 80H
	(For DSR-1500 only) SETUP LEVEL [>> Setup lev]: Adjust the black setup level.	000 [>>>000] to 3FF [>>> 3FF] Factory default setting: 200H
	(For DSR-1500P only) BLACK LEVEL [>> Black lev]: Adjust the black level.	000 [>>> 000] to 3FF [>>> 3FF] Factory default setting: 200H
(For DSR-1500P only) INPUT BLANK [> Input blk]	LINE 335 [>> Line 335]: Switch blanking on or off for the 335th line of the input video signal. BLANK [>>> blank]: Blank. THROUGH [>>> through]: Do not blank.	

AUDIO CONTROL [Audio]: Settings related to audio control	Description of settings
REC MODE [> REC mode]: Select the audio recording mode.	* 2 CHANNEL (48kHz) [>> 2 ch]: 2-channel, 48-kHz mode 4 CHANNEL (32kHz) [>> 4 ch]: 4-channel, 32-kHz mode

AUDIO CONTROL [Audio]: Settings related to audio control		Description of settings
INPUT ARRANGE [> Input arrng]: Make settings for input audio mixing. Note When, in 4-channel mode, analog audio is selected for all four channels (channels 1/2 and 3/4), the same analog audio signals are recorded on channels 1 and 3 and on channels 2 and 4, respectively. That is, the analog signal recorded on channel 1 is also recorded on channel 3 and the analog signal recorded on channel 2 is also recorded on channel 4. You can adjust the audio level on each of the four channels separately using the REC/PB LEVEL control knobs with the VAR switch set to REC.		Set the channels on which to record the input audio signals as follows. (1) Use the $\Delta \nabla \triangleleft \triangleright$ buttons to move the cursor and the SET (YES) button to toggle the setting on and off. (2) To save the settings, press the MENU button to return to the previous screen, then press the SET (YES) button. Example settings: <div style="text-align: center;"> <pre> AUDIO INPUT SOURCE ARRANGE ----- in1 in2 in3 in4 ----- ch1: *on ch2: on on ch3: on ch4: on ON/OFF : SET KEY TO MENU : MENU KEY </pre> </div> <ol style="list-style-type: none"> ① Input audio channel 1 ("in1") is recorded on audio channel 1 ("ch1") on tape. ② Input audio channels 2 and 4 ("in2" and "in4") are recorded mixed on audio channel 2 ("ch2") on tape. ③ Input audio channel 4 ("in4") is recorded on audio channel 3 ("ch3") on tape. ④ Input audio channel 3 ("in3") is recorded on audio channel 4 ("ch4") on tape.
LEVEL SELECT [> Level Sel]	REF LEVEL [>> REF Level]: Select the audio reference level (headroom) for recording on tape.	* -20 dB [>>> -20dB] (factory default setting for DSR-1500) * -18 dB [>>> -18dB] (factory default setting for DSR-1500P) -16 dB [>>> -16dB] -12 dB [>>> -12dB]
	CH1 IN LEVEL [>> CH1 input]: Select the audio level setting according to the audio level of the signal input to the AUDIO IN 1/3 connector.	* +4 dBm [>>> +4dBm] 0 dBm [>>> 0dBm] -3 dBm [>>> -3dBm] (for DSR-1500P only) -6 dBm [>>> -6dBm]
	CH2 IN LEVEL [>> CH2 input]: Select the audio level setting according to the audio level of the signal input to the AUDIO IN 2/4 connector.	* +4 dBm [>>> +4dBm] 0 dBm [>>> 0dBm] -3 dBm [>>> -3dBm] (for DSR-1500P only) -6 dBm [>>> -6dBm]
	OUTPUT LEVEL [>> Out Level]: Select the analog audio output reference level.	* +4 dB [>>> +4dB] 0 dB [>>> 0dB] -3 dB [>>> -3dB] (for DSR-1500P only) -6 dB [>>> -6dB]
INT AUDIO SG [> Audio SG]: Select the operation of the internal audio test signal generator.		SILENCE [>> silence]: Silent signal * 1kHz SINE [>> 1kHz]: 1-kHz, -20 dB FS (for DSR-1500) or -18 dB FS (for DSR-1500P) sine wave signal When you select SG (audio test signal) as the audio input in the video/audio input setting section on the front panel, the audio test signal generated by the internal audio test signal generator is input.
JOG CONTROL [> Jog ctrl]: Select whether to adjust the audio playback speed during slow playback.		OFF [>> OFF]: Do not adjust the audio playback speed. * ON [>> ON]: Adjust the audio playback speed.

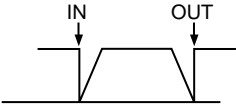
AUDIO CONTROL [Audio]: Settings related to audio control	Description of settings
SHUTTLE MUTE [> Shuttle mute]: Set the audio muting conditions during shuttle playback.	*OFF [>> OFF]: Not muted. *CUEUP or PREROLL [>> CUEUP]: Muted during cue-up or preroll operations. *FULL [>> FULL]: Muted in shuttle mode.
AUDIO EDIT [> Audio edit]: Specify the type of editing for audio signals.	*CUT EDIT [>> Cut edit]: Cut editing (Discontinuity in audio signal may result at the editing point, causing noise during playback.) *FADE IN/OUT [>> Fade]: Fade in and fade out 
DV PB ATT [> DV PB ATT]: When playing back a tape recorded in consumer DV format, select whether to attenuate the audio output level.	*OFF [>> OFF]: Do not attenuate. *ON [>> ON]: Attenuate.

INTERFACE SELECT [Interface]: Settings related to external interfaces	Description of settings
VIDEO OUTPUT [> Video Out]: Select the format of analog video signals to be output from the three VIDEO OUT connectors (Y/CPST, R-Y/C/CPST, and B-Y/CPST (SUPER)). Note When this menu item is set to Y-R, B, the B-Y/CPST (SUPER) connector outputs the B-Y signal. In this case, changing the setting of an internal switch allows the text data for superimposition on the monitor screen to be output from the right-hand REF. VIDEO IN connector (marked VR). For more information about this, consult your Sony dealer.	*COMPOSITE [>> Composite]: Composite video signals *S-VIDEO [>> S-Video]: S-video (separated Y and C) and composite video signals *Y-R, B [>> Y-R, B]: Y, R-Y and B-Y component video signals
DIGITAL OUTPUT [> Digit Out]: Select the format of signals to be output from the SDI/SDTI (QSDI) OUT1/OUT2 connectors (optional DSBK-1501 board required).	*SDI [>> SDI]: SDI format *SDTI [>> SDTI]: SDTI (QSDI) format
AUDIO OUTPUT [> Audio Out]: Select the channels for audio output from the AUDIO OUT 1/3 and 2/4 connectors.	*1/2 CH [>> 1/2CH]: Output channel 1 to the AUDIO OUT 1/3 connector and channel 2 to the AUDIO OUT 2/4 connector. *3/4 CH [>> 3/4CH]: Output channel 3 to the AUDIO OUT 1/3 connector and channel 4 to the AUDIO OUT 2/4 connector.
REMOTE I/F [> Remote I/F]: When remote-controlling this unit with the LOCAL/REMOTE switch set to REMOTE, select either the REMOTE connector or i.DV IN/OUT connector (optional DSBK-1501 board required) for connecting a remote control unit.	*9PIN [>> 9PIN]: Remote-control via the REMOTE connector. *i.LINK [>> i.LINK]: Remote-control via the i.DV IN/OUT connector.

SETUP BANK OPERATION [Setup Bank]: Settings related to menu bank operations	Description of settings
RECALL BANK1 [> Recall 1]: Recall menu settings from menu bank 1.	(1) Select the bank you want to recall, then press the ▷ button. Message "RECALL OK?" appears. (2) To recall, press the SET (YES) button. To quit recalling, press the RESET (NO) button.
RECALL BANK2 [> Recall 2]: Recall menu settings from menu bank 2.	
RECALL BANK3 [> Recall 3]: Recall menu settings from menu bank 3.	
RECALL BANK4 [> Recall 4]: Recall menu settings from menu bank 4.	

SETUP BANK OPERATION [Setup Bank]: Settings related to menu bank operations	Description of settings
SAVE BANK 1 [> Save 1]: Save current menu settings to menu bank 1.	(1) Select the bank you want to save, then press the ▷ button. Message "SAVE OK?" appears. (2) To save, press the SET (YES) button. To quit saving, press the RESET (NO) button.
SAVE BANK 2 [> Save 2]: Save current menu settings to menu bank 2.	
SAVE BANK 3 [> Save 3]: Save current menu settings to menu bank 3.	
SAVE BANK 4 [> Save 4]: Save current menu settings to menu bank 4.	
Menu banks This unit allows four different complete sets of menu settings to be saved in what are termed "menu banks" numbered 1 to 4. Saved sets of menu settings can be recalled for use as required.	

MENU GRADE [Menu grade]: Selection of menu items to be displayed	Description of settings
Determine whether to display basic items only or both basic and enhanced items on the monitor screen and in the time counter display when using the menu.	*BASIC [> Basic]: Display basic items only. ENHANCED [> Enhanced]: Display both basic and enhanced items.



EE OUT PHASE settings for time code output

Use the following as reference information when setting the EE OUT PHASE menu item (see page 63).

THROUGH mode

In this mode, the LTC signal is output with the phase synchronized with the input time code signal. This mode is appropriate when recording signals from multiple devices on a number of VCRs.

When the camcorder is in genlock mode, the time code precision is ± 0 frames. When the camcorder is not in genlock mode, it is ± 1 frame.

Note

The optional boards (see page 7) corresponding to the input signal formats to be used are required.

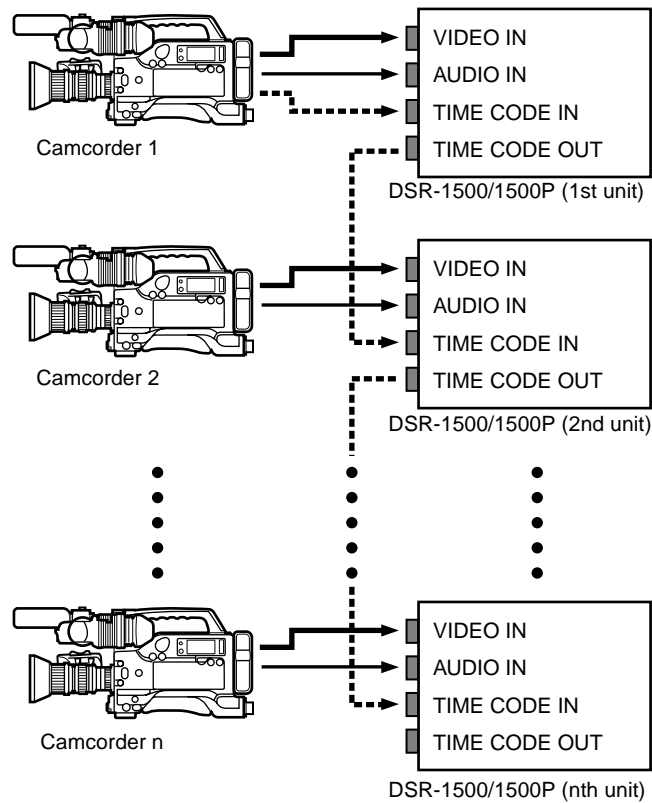

- Composite video or S-video signal
- Audio signal
- - - Time code signal

VIDEO INPUT PHASE mode

The time code output signal is synchronized with the input video signal.

This mode is appropriate when the output from a single device is recorded on a number of VCRs. The connections are loop-through connections.

In this mode, the same time code is recorded on all of the VCRs 1 to n.

Note

The optional boards (see page 7) corresponding to the input signal formats to be used are required.

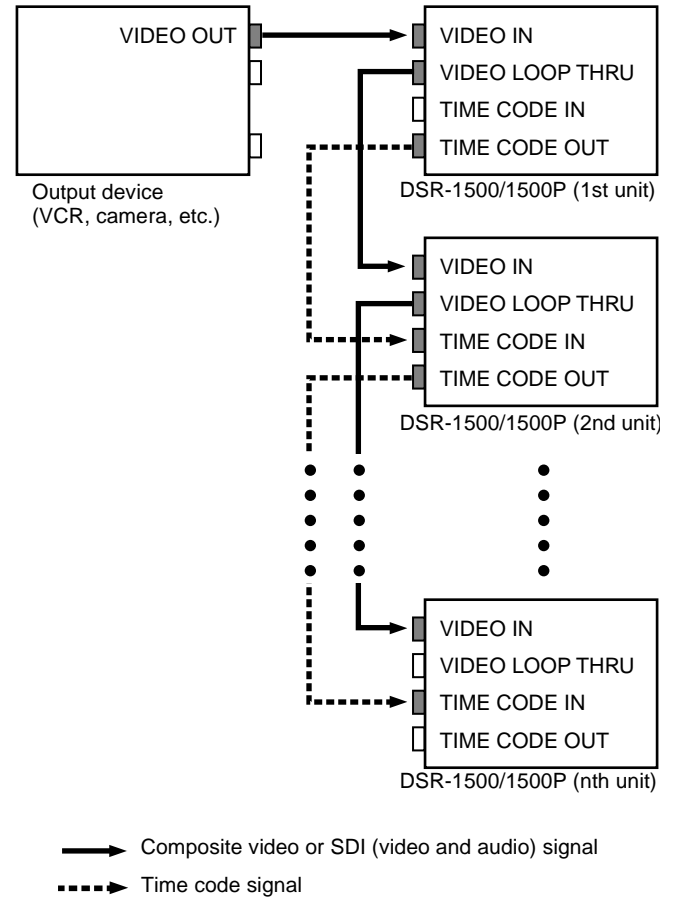

VIDEO OUTPUT PHASE mode

The time code output signal is synchronized with the output video signal.

This mode is appropriate when outputting signals from a single device to a number of VCRs using separate cables for video, audio, and time code.

In this mode, the same time code is recorded on all of the VCRs 1 to n.

Note

The optional boards (see page 7) corresponding to the input signal formats to be used are required.

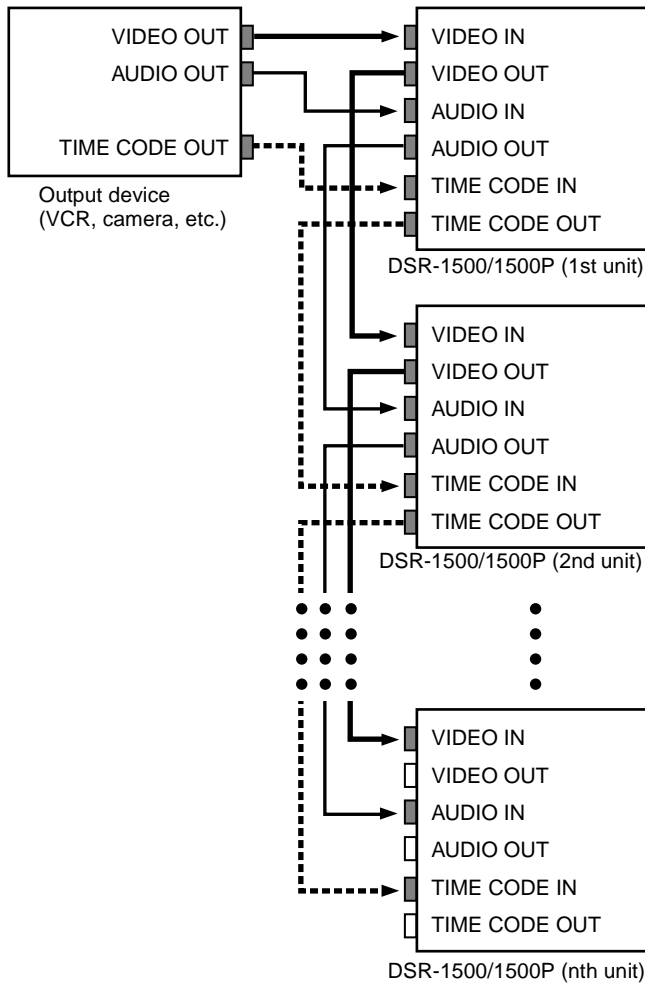

- • Composite video signal
- • S-video signal
- • Analog component signal
- • SDI (video and audio) signal
- Audio signal
- - - - - Time code signal

Auto Mode (AUTO FUNCTION) Execution Menu

The following table shows the purpose and function of the items in the auto mode execution menu.

For details of the use of individual items, see “Digitally Dubbing Signals in DVCAM Format” on page 51 and “Rerecording the Time Code—TC Insert Function” on page 47.

Menu contents

SDTI DUBBING [SDTI DUB]: Selection of data for SDTI dubbing	Settings
For dubbing through the SDTI (QSDI) interface, select data that the dubbing applies to.	<p>A/V [> A/V]: Dub the audio and video. A/V/TC [> A/V/TC]: Dub the audio, video, and time code. A/V/TC/CM [> A/V/TC/CM]: Dub the audio, video, time code, and cassette memory contents.</p> <p>Note When A/V is selected, the time code recorded follows the setting of the TIME CODE menu items (see page 62) in the setup menu.</p>
i.LINK DUBBING [i.LINK DUB]: Selection of data for i.LINK dubbing	Settings
For dubbing through the i.LINK interface, select data that the dubbing applies to.	<p>A/V [> A/V]: Dub the audio and video. A/V/TC [> A/V/TC]: Dub the audio, video, and time code. A/V/TC/CM [> A/V/TC/CM]: Dub the audio, video, time code, and cassette memory contents.</p> <p>Note When A/V is selected, the time code recorded follows the setting of the TIME CODE menu items (see page 62) in the setup menu.</p>
TC INSERT [TC insert]: Time code rewriting	Settings
Rewrite the time code from an initial value which can be set freely.	—

Changing Menu Settings

This section explains how to change menu settings.

Buttons Used to Change Settings

Use the following buttons in the menu control section to change the menu settings.

Menu control buttons	Functions
MENU button	<ul style="list-style-type: none"> Opens the menu and launches menu control mode. Closes the menu and exits menu control mode.
△ and ▽ buttons	These buttons move the highlighted cursor up and down within the current level to select an item or setting. Hold down one of these buttons to make the highlighted cursor move continuously.
◀ and ▶ buttons	<ul style="list-style-type: none"> Press the ▶ button to go down one level. Press the ◀ button to go up one level. Hold down one of these buttons to make the highlighted cursor move continuously.
RESET (NO) button	<ul style="list-style-type: none"> Returns the setting to the factory default setting. Sends a negative response to prompts on the monitor screen.
SET (YES) button	<ul style="list-style-type: none"> Saves the new setting in memory. Sends a positive response to prompts on the monitor screen.

Changing the Settings of Basic Items

The factory default setting is to display only the basic items. To change the settings of basic items proceed as follows.

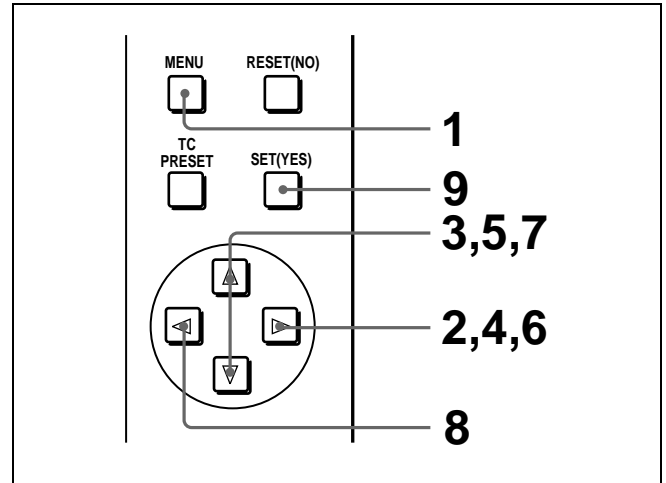

1 Press the MENU button in the menu control section.

The menu selection level display appears on the monitor.

In the figure below, "SETUP MENU" is selected (shown in reverse video).

The time counter display of this unit shows only the currently selected item. When the item name is long, it is abbreviated.

Menu selection level display

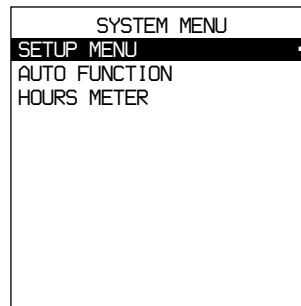

Monitor screen

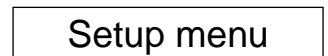

Time counter display

2 With “SETUP MENU” selected, press the ▷ button.

This displays all items on menu level 1.

Level-1 menu display

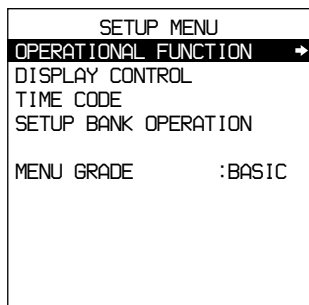

Monitor screen

Operational

Time counter display

3 Press the Δ or ▽ button to select the required item.

Example: Display when “DISPLAY CONTROL” is selected

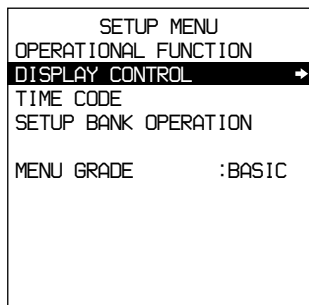

Monitor screen

Display

Time counter display

4 Press the ▷ button.

This displays menu level 2 for the menu item selected in step 3.

Example: Level-2 display for “DISPLAY CONTROL”

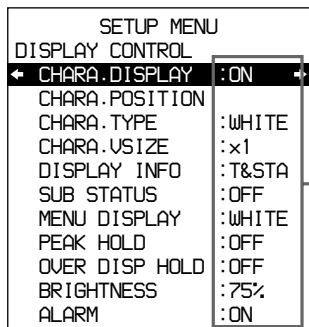

Monitor screen

> Chara disp

Time counter display

Current settings

5 Press the Δ or ▽ button to select the item whose setting you wish to change.

For menu items on level 3, press the ▷ button to go to level 3, then press the Δ or ▽ button to select the item whose setting you wish to change.

Example: Display when “BRIGHTNESS” is selected

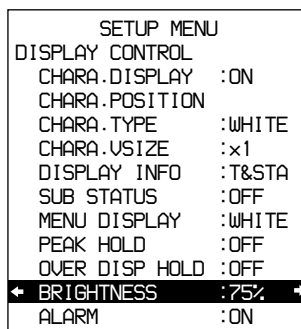

Monitor screen

> Brightness

Time counter display

6 Press the ▷ button.

This displays all possible settings for the item selected in step 5.

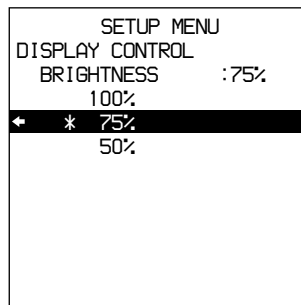

Monitor screen

>> 75%

Time counter display

7 Press the Δ or ▽ button to change the setting of the item.

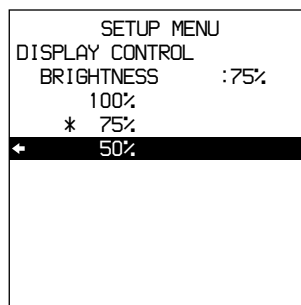

Monitor screen

>> 50%

Time counter display

8 To change other settings, press the < button to return to the previous screen, then repeat steps **5** to **7** as required.

9 When you have completed the settings, press the SET (YES) button.

The message "NOW SAVING..." appears on the monitor screen, and "Saving..." appears in the time counter display, while the new settings are saved in memory.

When the saving operation is completed, the monitor screen and time counter display return to their normal indications.

Notes

- If you power off the unit before saving operation is completed, settings may be lost. Wait until the saving is completed before powering off the unit.
- If, instead of pressing the SET (YES) button, you press the MENU button, the new settings are not saved. The message "ABORT !" appears on the monitor screen and "Abort !" in the time counter display for about 0.5 second, and the system exits the menus. To change more than one setting, be sure to press the SET (YES) button after making the settings.

Meanings of indications on the monitor screen

On-screen indication	Meaning
Right-pointing arrow (→) at the right of a menu item <i>See step 1 of the foregoing operating procedure.</i>	Pressing the ▷ button switches to the next lower menu level or to a setting selection screen.
Left-pointing arrow (←) at the left of a menu item <i>See step 4 of the foregoing operating procedure.</i>	Pressing the < button returns to the previous (higher) menu level.
Character string at the right of a menu item <i>See step 4 of the foregoing operating procedure.</i>	Current setting of the menu item When shown with a colon (:): the current setting is the same as the factory default setting. When shown with a raised dot (•): the current setting is different from the factory default setting. <i>See step 2 of the operating procedure in "Changing the Settings of Enhanced Items."</i>
An asterisk in a complete list of settings <i>See step 6 of the foregoing operating procedure.</i>	Factory default setting

Displaying Enhanced Items

The factory default setting is not to display enhanced items.

To display enhanced items, set the MENU GRADE menu item (*see page 68*) to ENHANCED, following the procedure in the previous section "Changing the Settings of Basic Items." (In step **3**, first select "MENU GRADE," and next select "ENHANCED," then press the SET (YES) button to save the setting in memory.)

With this done, when you press the MENU button and the ▷ button to display the setup menu, all basic and enhanced items on menu level 1 appear.

Changing the Settings of Enhanced Items

To change the settings of enhanced items, first carry out the procedure in the previous section "Displaying Enhanced Items," then proceed as follows.

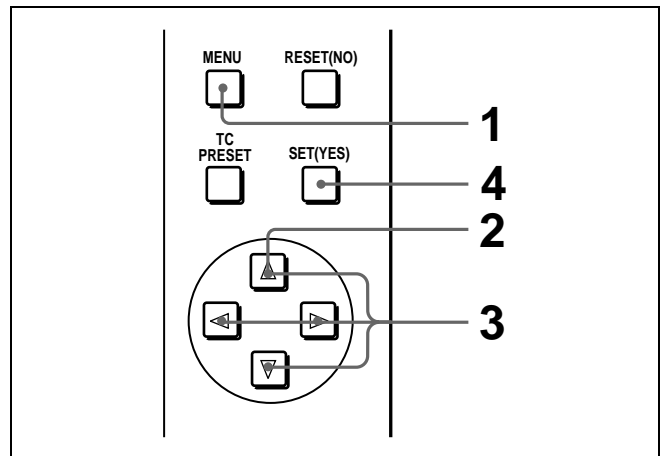

- 1** Press the MENU button in the menu control section.
The menu selection level display appears on the monitor.

2 With “SETUP MENU” selected, press the ▷ button.

This displays all basic and enhanced items on menu level 1.

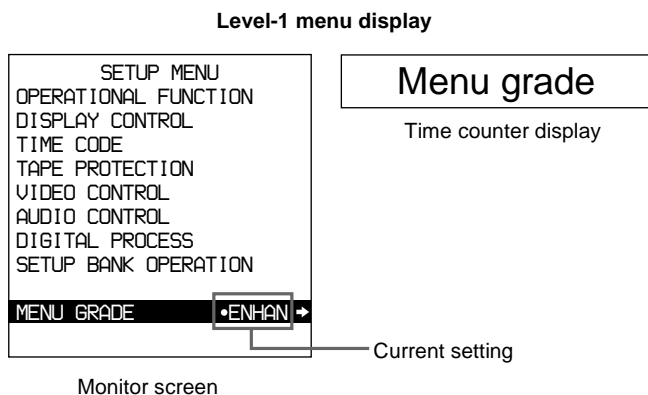

3 Follow the same procedure as in steps **3** to **8** of the procedure in the section “Changing the Settings of Basic Items” (page 72) using the Δ▽◀▶ buttons to select an item and change its setting.

4 When you have completed the settings, press the SET (YES) button.

The message “NOW SAVING...” appears on the monitor screen, and “Saving...” appears in the time counter display, while the new settings are saved in memory.

When the saving operation is completed, the monitor screen and time counter display return to their normal indications.

Returning Menu Settings to Their Factory Default Settings

After making menu setting changes, to return settings to their factory default settings (setting initialization), use the following procedure.

To return a particular setting to its factory default setting

In the section “Changing the Settings of Basic Items” (page 72), carry out the procedure up to step **6**, then with the current setting displayed (in the example, if the factory default setting has been changed, the current setting will be 100% or 50%), proceed as follows.

1 Either press the RESET (NO) button or select the default setting using the Δ or ▽ button.

2 Press the SET (YES) button.

The setting returned to its factory default is saved in memory as the current setting.

To return all settings to their factory default settings

1 Press the MENU button in the menu control section.

The menu selection level display appears on the monitor screen.

2 Press the ▷ button to display level 1 of the setup menu.

3 Press the RESET (NO) button.

A message appears, to confirm whether or not you wish to return all settings to their factory default settings.

Monitor screen message	Message in the time counter display
INITIALIZE ALL ITEMS TO FACTORY PRESET VALLUES?	Init setup?

4 Press the SET (YES) button.

The message “NOW SAVING...” appears on the monitor screen, and “Saving...” appears in the time counter display, while the settings of all items are returned to their factory default settings. These factory default settings are saved in memory.

Note

If you power off the unit while settings are being saved, settings may not be correctly returned to their factory default settings. Wait until the saving is completed before powering off the unit.

To abandon the resetting operation

Instead of pressing the SET (YES) button, press the RESET (NO) button. The display returns to menu level 1, leaving the settings unchanged.

Displaying Supplementary Status Information

When you set the SUB STATUS menu item (see page 61) to other than OFF, you can view supplementary status information on the monitor screen below the operating mode display area.

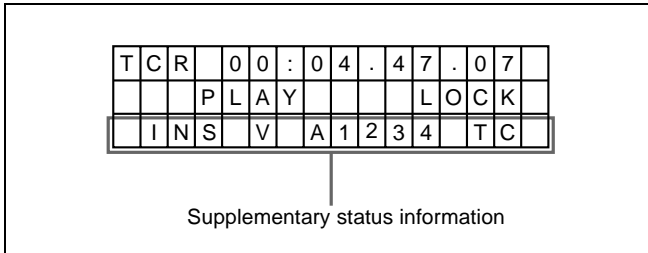

The following items of supplementary status information are displayed depending on the setting of the SUB STATUS menu item.

Setting of SUB STATUS menu item	Items of supplementary information displayed
EDIT PRESET	Editing mode settings made on the editing control unit
TC MODE	Operating mode of the internal time code generator
REMAIN	Remaining capacity of the tape
AUDIO MIXING	Setting for input audio mixing
ALL	All of the above items

The following tables show the on-screen indications of supplementary information and their meaning. In each table, the indications given in brackets such as [ASM] are the indications displayed when the SUB STATUS menu item is set to ALL.

For the display format when ALL is selected, see the next section.

When the SUB STATUS menu item is set to EDIT PRESET:

On-screen indication	Meaning
ASM [ASM]	Assemble editing mode
INS V A1234 TC [V1234T]	INS: Insert editing mode V A1234 TC: Channels or signals selected for insert editing V: Video A1234: Audio 1, 2, 3, 4 TC: Time code

When the SUB STATUS menu item is set to TC MODE:

On-screen indication	Meaning
INT PRST FREE [IP F]	The internal time code generator is operating in FREE RUN mode.
INT PRST REC [IP R]	The internal time code generator is operating in REC RUN mode.
INT REGEN-T&U [IRTU]	The internal time code generator is in synchronization with the playback time code (LTC) read from tape.
EXT LTC-T&U [ELTU]	The internal time code generator is in synchronization with the external time code (LTC) input to the unit and is generating the same time code value and user bit value as those of the external time code (regeneration).
EXT VITC-T&U [EVTU]	The internal time code generator is in synchronization with VITC present in the external video signal input to the unit and is generating the same time code value and user bit value as those of the external time code (regeneration).
EXT QSDI-T&U [EQTU]	The internal time code generator is in synchronization with the external time code input to the unit via the SDTI (QSDI) interface and is generating the same time code value and user bit value as those of the external time code (regeneration).
EXT QSDI. V-T&U [EQTU]	The internal time code generator is in synchronization with the external VITC input to the unit via the SDTI (QSDI) interface and is generating the same time code value and user bit value as those of the external time code (regeneration).
EXT DVIN-T&U [EDTU]	The internal time code generator is in synchronization with the external time code input to the unit via the i.LINK (i.DV IN) interface and is generating the same time code value and user bit value as those of the external time code (regeneration).
EXT DVIN. V-T&U [EDTU]	The internal time code generator is in synchronization with the external VITC input to the unit via the i.LINK (i.DV IN) interface and is generating the same time code value and user bit value as those of the external time code (regeneration).

When the SUB STATUS menu item is set to REMAIN:

On-screen indication	Meaning
REMAIN 184 min	Remaining capacity of the tape in minutes. When the remaining capacity has not been calculated, "REMAIN --- min" appears.

When the SUB STATUS menu item is set to AUDIO MIXING:

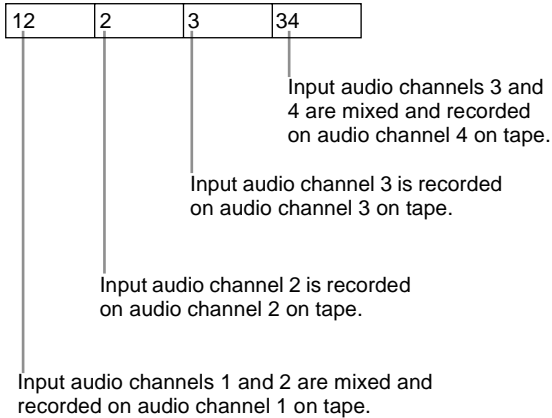
On-screen indication	Meaning
1 2 3 4 [MIX]	Input audio channels selected for mixing 1 2 3 4: Input audio channels 1, 2, 3 and 4
<p>Example display:</p> 	

Display format of supplementary status information when the SUB STATUS menu item is set to ALL

All items of supplementary status information are displayed in the order shown below.

T	C	R	0	0	:	0	4	:	4	7	.	0	7	
			P	L	A	Y				L	O	C	K	
V	1	2	3	4	T	M	I	X	E	D	T	U	V	

Editing mode settings

Setting for input audio mixing

Operating mode of the internal time code generator (The rightmost "V" appears when the VITC menu item (see page 62) is set to ON.)



Connections for a Digital Non-Linear Editing System

This unit can be connected to an ES-7 EditStation to configure a digital non-linear editing system.

If you use the SDTI (QSDI) interface with the optional DSBK-1501 board installed in the unit, you can transfer video, audio, time code, and other compressed data between this unit and the ES-7.

The unit supports ClipLink functions, enabling index pictures recorded on tape and ClipLink log data stored in cassette memory to be transferred to the ES-7 in an instant.

For a general description of ClipLink functions, see the appendix "ClipLink Guide" (page 105).

The following figure shows a connection diagram for a non-linear editing system in which this unit serves as the recorder.

For connections of the ES-7 and its peripheral devices such as the ESBK-7011 Control Panel, the ESBK-7045 Disk Unit, etc., refer to your ES-7 Operating Instructions.

Note

The DSR-1500/1500P unit shown in the following figure is fitted with the optional DSBK-1501, DSBK-1503, and DSBK-1504/1504P boards.

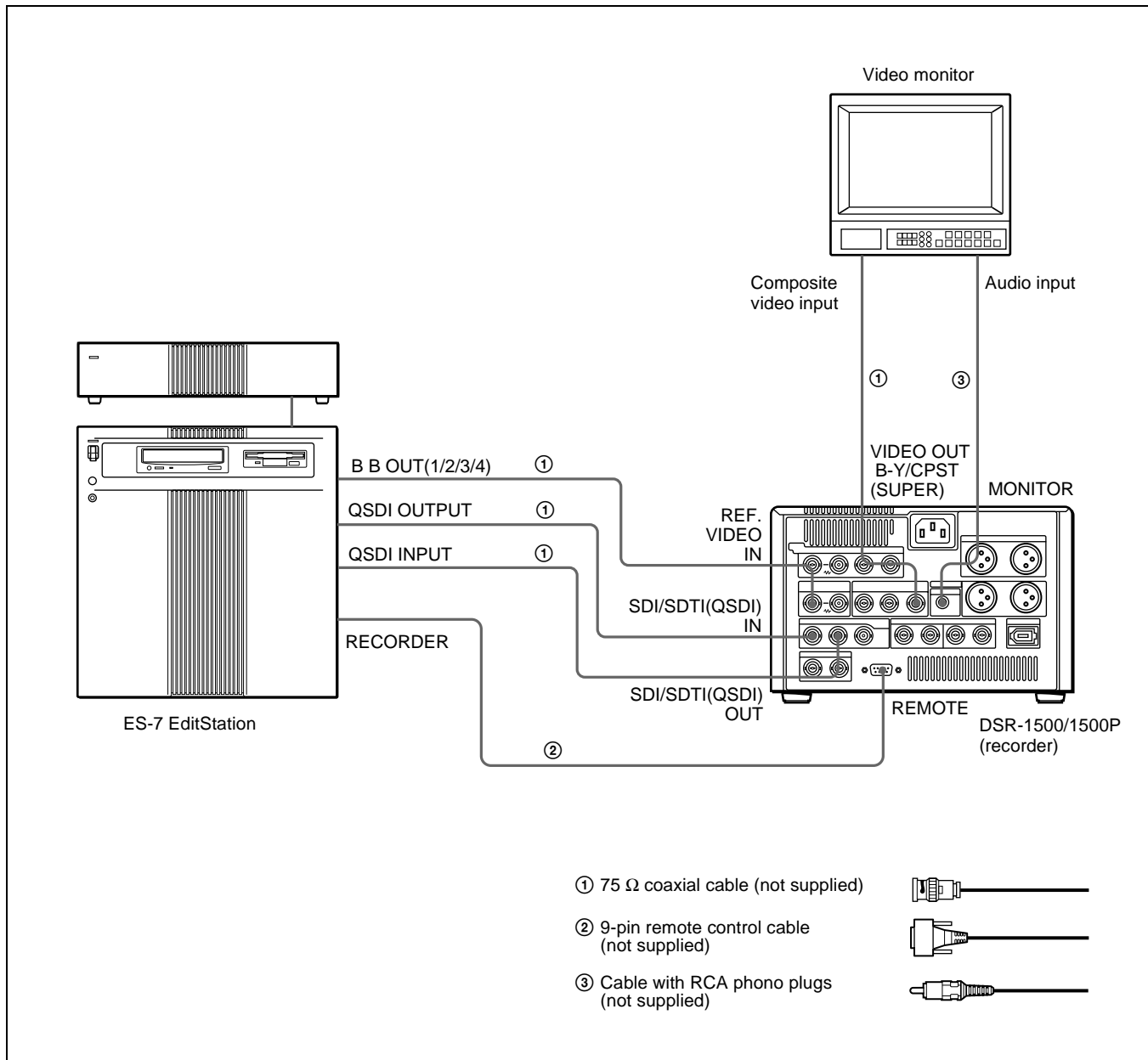

Settings on the DSR-1500/1500P

Switch/menu item	Setting
LOCAL/REMOTE switch	REMOTE (REMOTE indicator lights.)
DIGITAL OUTPUT menu item (see page 67)	SDTI (SDTI indicator lights.)
REMOTE I/F menu item (see page 67)	9PIN (9P indicator lights.)

For details of video/audio input and audio mode settings, see "Settings for Recording" on page 27.

Connections for a Cut Editing System

The following figure shows a cut editing system configuration that includes two DSR-1500/1500P units to serve as the player and recorder.

For details of connecting devices other than the DSR-1500/1500P, refer to the instruction manual for each device.

Notes

- This application requires both of the DSR-1500/1500P units (recorder and player) to be fitted with the optional DSBK-1501 board.
- The DSR-1500/1500P units shown in the following figure are fitted with the optional DSBK-1501, DSBK-1503, and DSBK-1504/1504P boards.

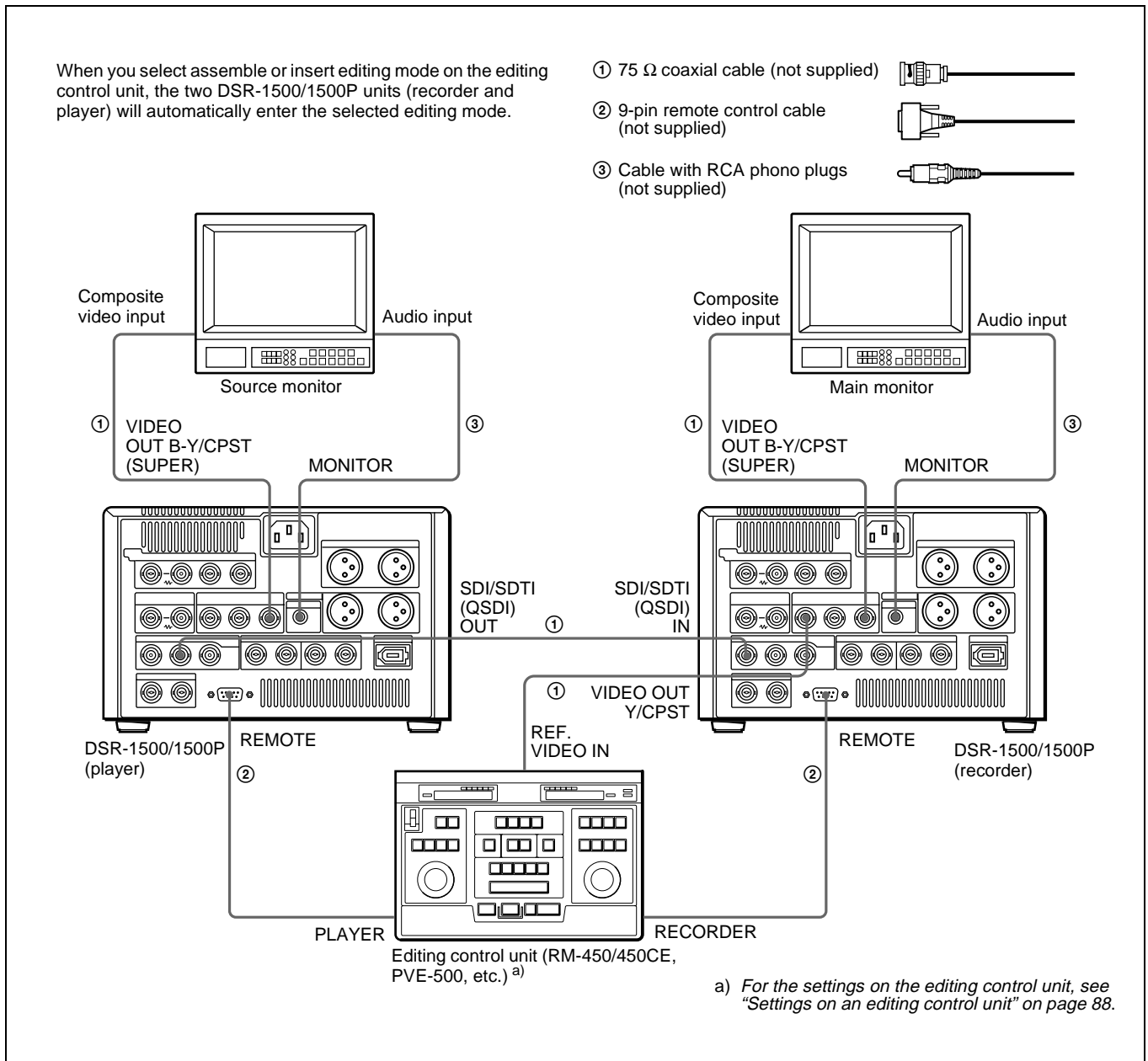

Settings on the DSR-1500/1500Ps (recorder and player)

Switch/menu item	Setting
LOCAL/REMOTE switch	REMOTE (REMOTE indicator lights.)
DIGITAL OUTPUT menu item (see page 67)	SDTI (for player only) (SDTI indicator lights.)
REMOTE I/F menu item (see page 67)	9PIN (9P indicator lights.)

For details of the video/audio input and audio mode settings for the recorder, see “Settings for Recording” on page 27.

About reference video signals

In order to provide stable video and audio signals for analog editing, it is necessary for the built-in time base corrector (TBC) to operate correctly. To ensure this, input a reference video signal synchronized with the video signal to the REF. VIDEO IN connector.

Connections for an A/B Roll Editing System

The following is an example configuration of A/B roll editing system using the DSR-1500/1500P.

In this configuration, two DSR-1500/1500P units are used, one as the recorder and the other as player 1, and an analog Betacam UVW-1600/1600P Videocassette Player unit is used as player 2. To create a final tape (a tape that contains a completely packaged program) in Betacam format, use a Betacam VCR such as the UVW-1800/1800P as the recorder.

Notes

- This application requires the DSR-1500/1500P unit used as the recorder to be fitted with the optional DSBK-1504/1504P board.
- The DSR-1500/1500P units shown in the following figure are fitted with the optional DSBK-1501, DSBK-1503, and DSBK-1504/1504P boards.

The purpose of the following figure is to indicate the flow of signals among the component devices in the system. The specific connections and settings are described beginning on *page 85*.

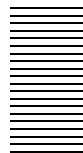

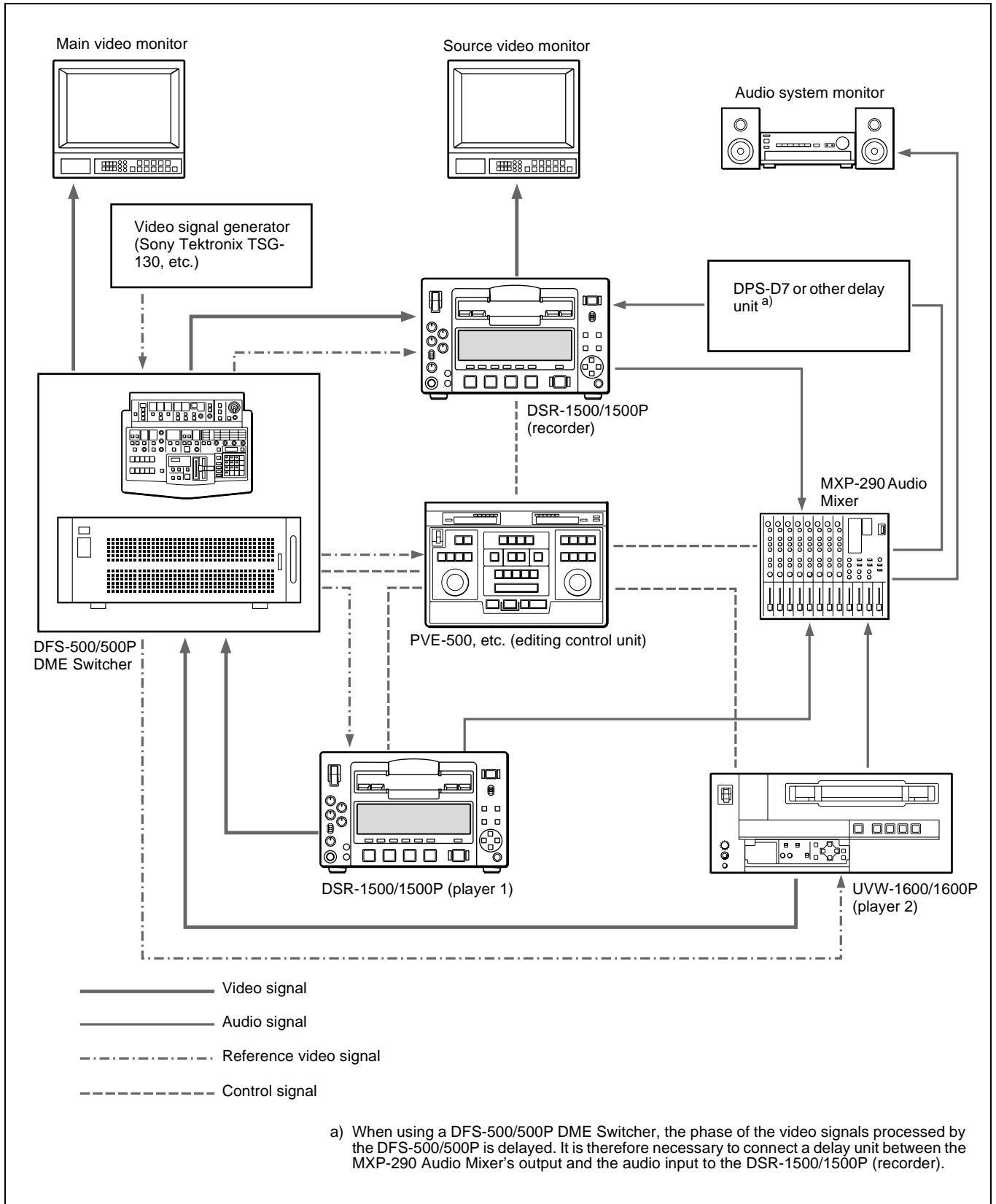

Audio monitor system connections

The following shows an example of audio monitor system connections.

For details of these connections, refer to the instruction manual for each connected device.

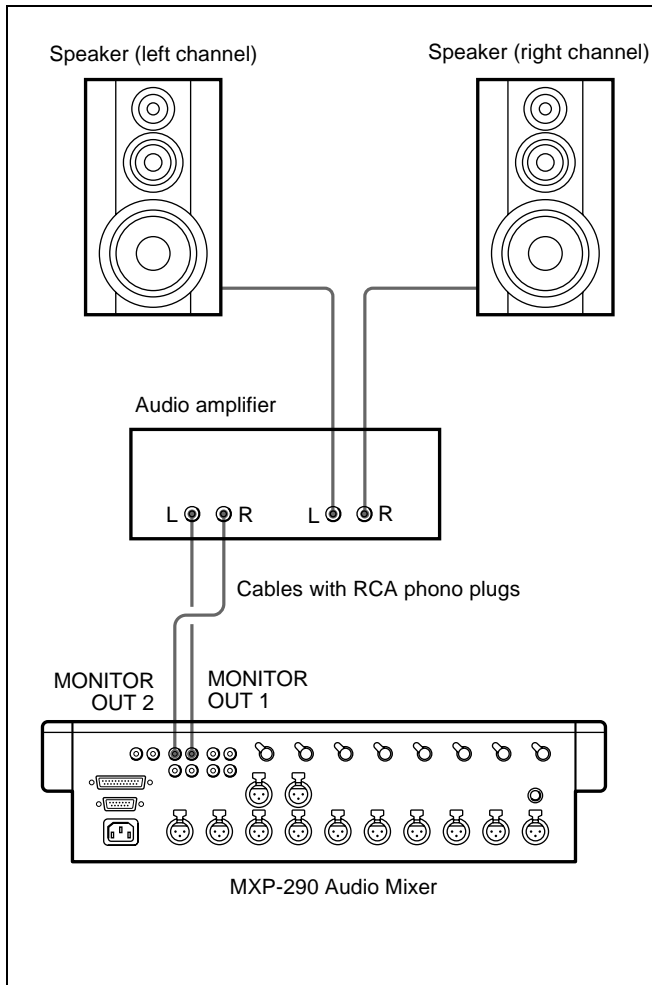

Reference video signal connection

When you perform recording, be sure to input a reference video signal.

For details of reference video signals, see "About reference video signals" on page 82.

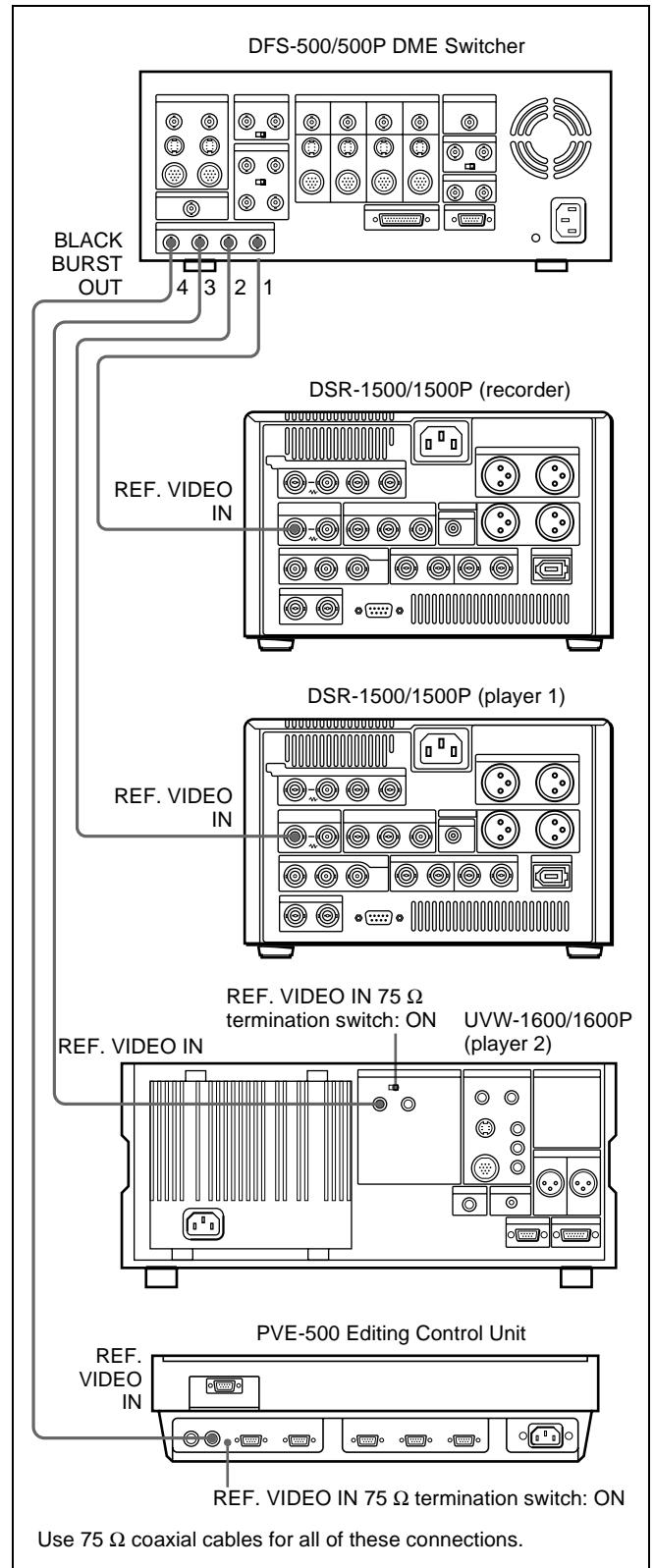

Control signal connections

The following shows an example of control signal connections to enable the editing control unit to control all other A/B roll editing system devices.

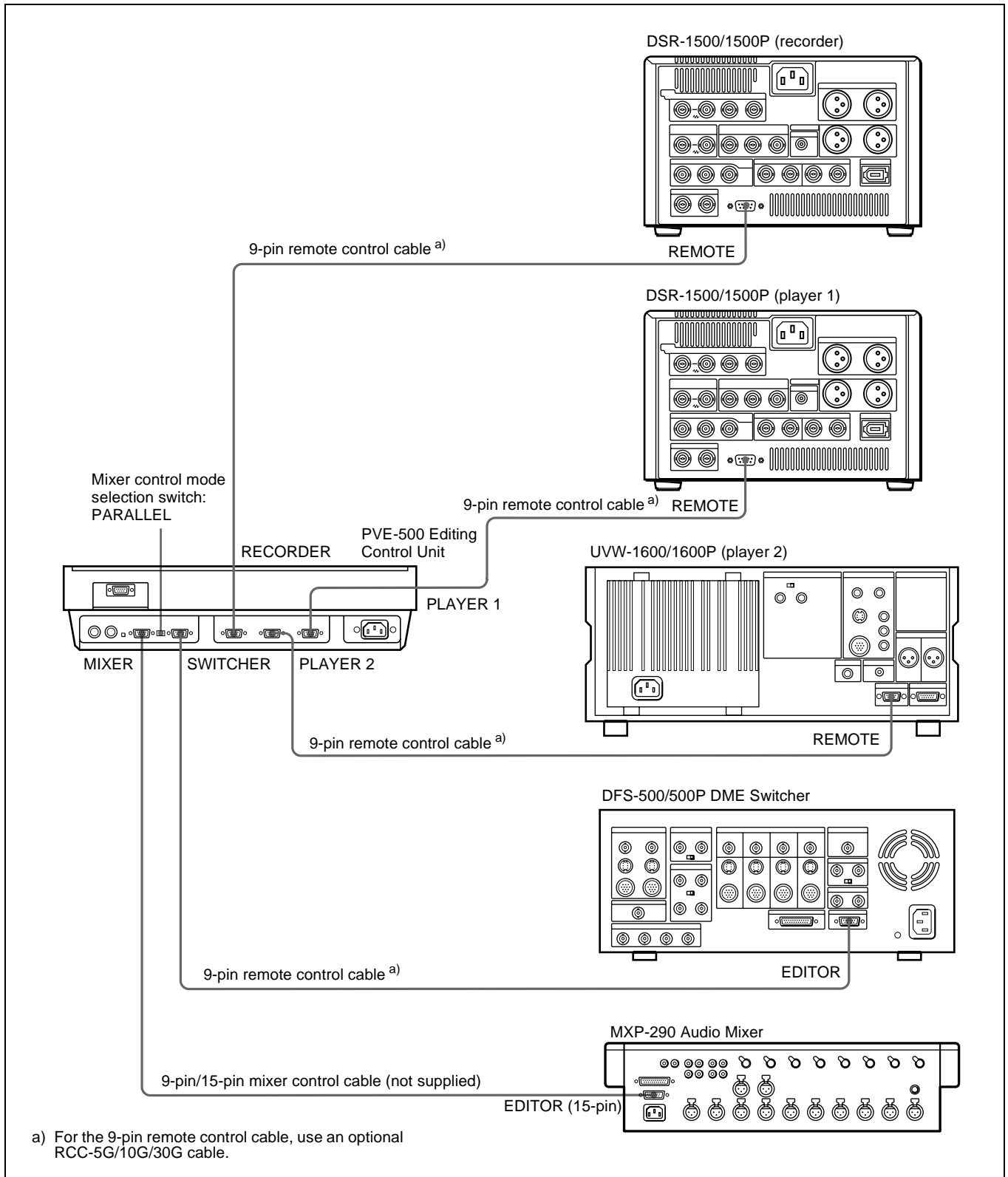

Video/audio signal connections

The following shows an example of video/audio signal connections in an A/B roll editing system.

In this example, analog component signals are used as the video signals and XLR 3-pin connectors are used as audio input/output connectors.

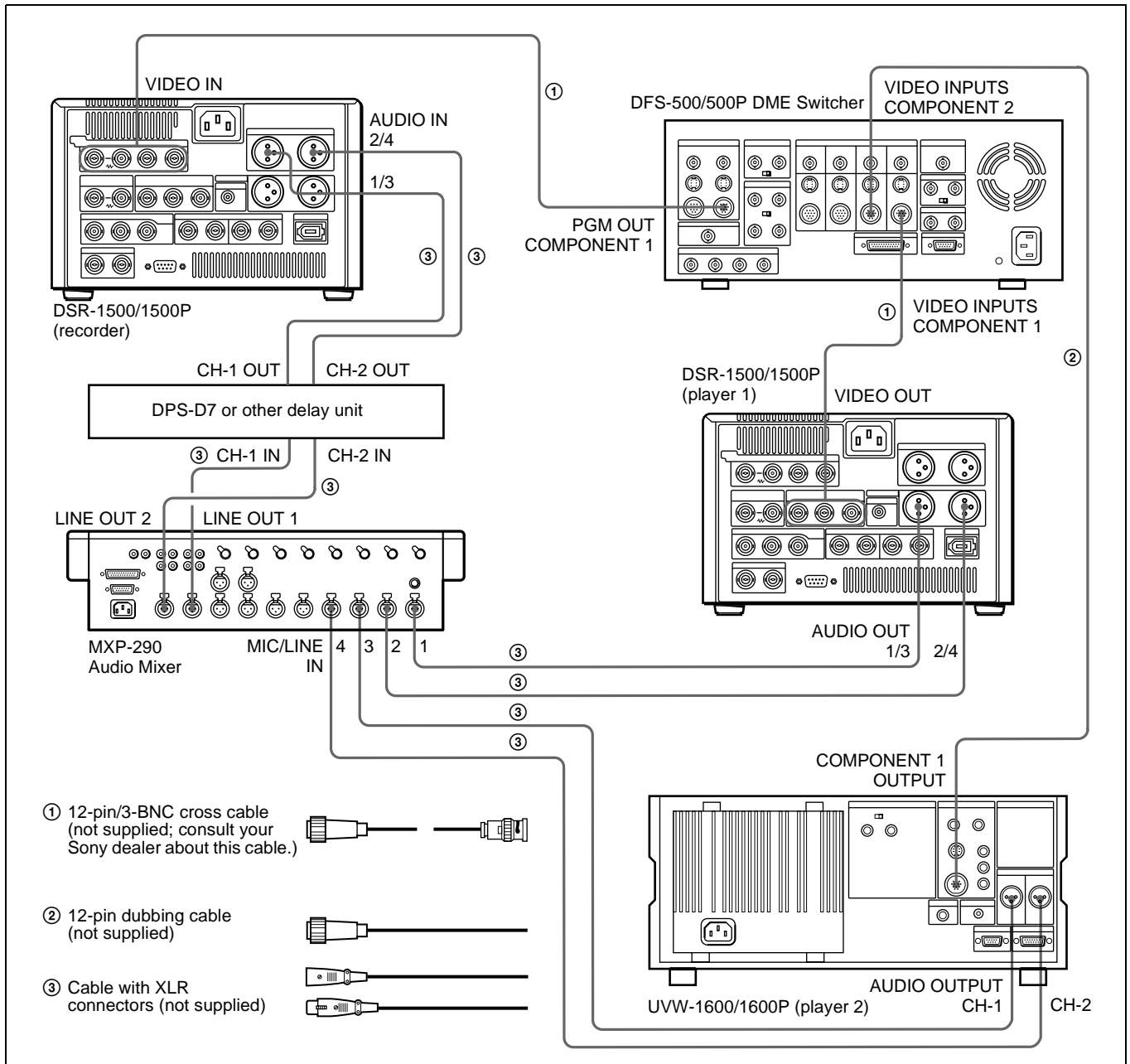

Settings on the DSR-1500/1500P (recorder)

Switch/menu item	Setting
LOCAL/REMOTE switch	LOCAL
CH1 IN LEVEL and CH2 IN LEVEL menu items (see page 66)	Normally +4 dBm

For details of the video/audio input and audio mode settings, see "Settings for Recording" on page 27.

Settings on the DSR-1500/1500P (player)

Switch/menu item	Setting
LOCAL/REMOTE switch	LOCAL
OUTPUT LEVEL menu item (see page 66)	Normally +4 dBm
VIDEO OUTPUT menu item (see page 67)	Y-R, B (Y-R,B indicator lights.)
AUDIO OUTPUT menu item (see page 67)	1/2 CH or 3/4 CH (CH 1/2 or CH 3/4 indicator lights.)

Connection of a video monitor

Set up the following connections to enable monitoring of video and audio signals on a video monitor. In addition to the video and audio signals, you can have time data, the operation mode of the unit, alarm messages, and other information displayed as text on the monitor screen by setting the CHARA. DISPLAY menu item (see page 60) to ON (factory default setting).

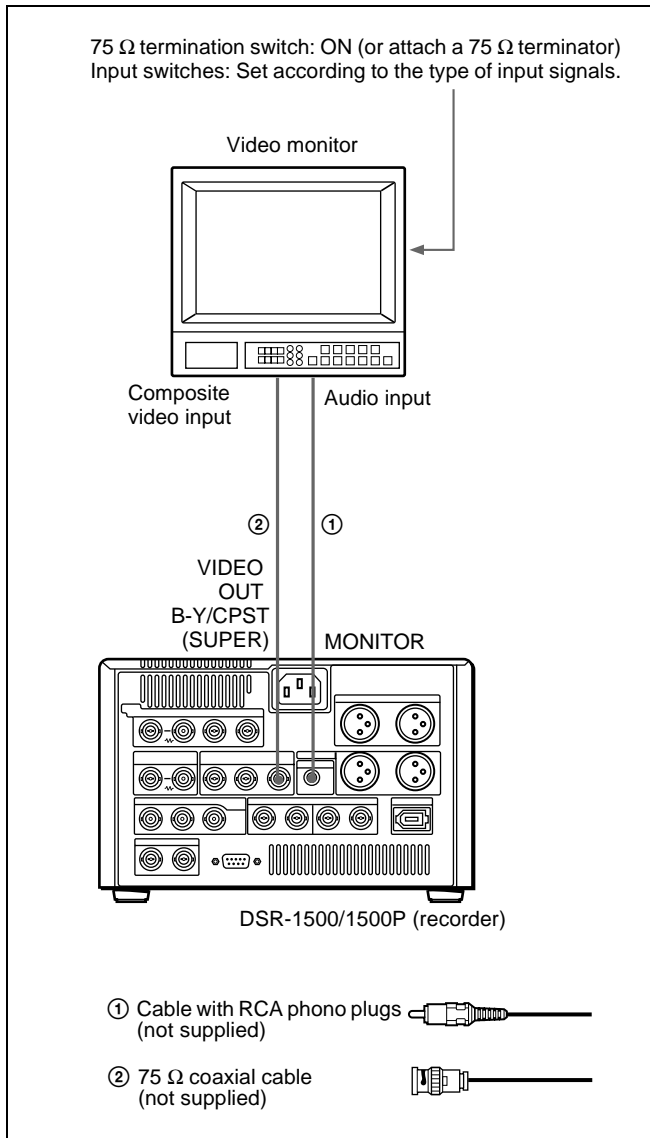

Settings on an editing control unit

When connecting an editing control unit, make the settings as follows, according to the model.

PVE-500

No settings are required.

BVE-600/900/910/2000 (NTSC model) or FXE-100/120

Set the VCR constants as follows.

1	2	3	4	5	6	7	8	9	10	11	12	13	14	15
80	17	00	96	05	05	03	80	0A	08	FE	00	80	5A	FF

BVE-600/900/910/2000 (PAL model) or FXE-100P/120P

Set the VCR constants as follows.

1	2	3	4	5	6	7	8	9	10	11	12	13	14	15
81	17	00	7D	05	05	02	80	0A	07	FE	00	80	4C	FF

RM-450/RM-450CE

Set the DIP switches as follows.

• Left switches

7	6	5	4	3	2	1	0
OFF	-	-	OFF	-	-	-	-

• Right switches (RM-450)

7	6	5	4	3	2	1	0
OFF	-	OFF	ON	OFF	OFF	ON	ON

• Right switches (RM-450CE)

7	6	5	4	3	2	1	0
ON	-	OFF	ON	OFF	OFF	ON	ON

BVE-800

Set the DIP switches as follows.

• SW2

1	2	3	4	5	6	7	8
ON	OFF	ON	ON	-	ON	ON	-

• SW3 (NTSC model)

1	2	3	4	5	6	7	8
ON	ON	ON	OFF	-	ON	OFF	OFF

• SW3 (PAL model)

1	2	3	4	5	6	7	8
OFF	OFF	OFF	ON	-	ON	OFF	OFF

Connections for SDTI (QSDI) Dubbing

The following shows an example of connections for digitally dubbing SDTI (QSDI) signals (*see page 51*) using a pair of DSR-1500/1500P units.

Notes

- This application requires both of the DSR-1500/1500P units (recorder and player) to be fitted with the optional DSBK-1501 board.
- The DSR-1500/1500P units shown in the following figure are fitted with the optional DSBK-1501, DSBK-1503, and DSBK-1504/1504P boards.

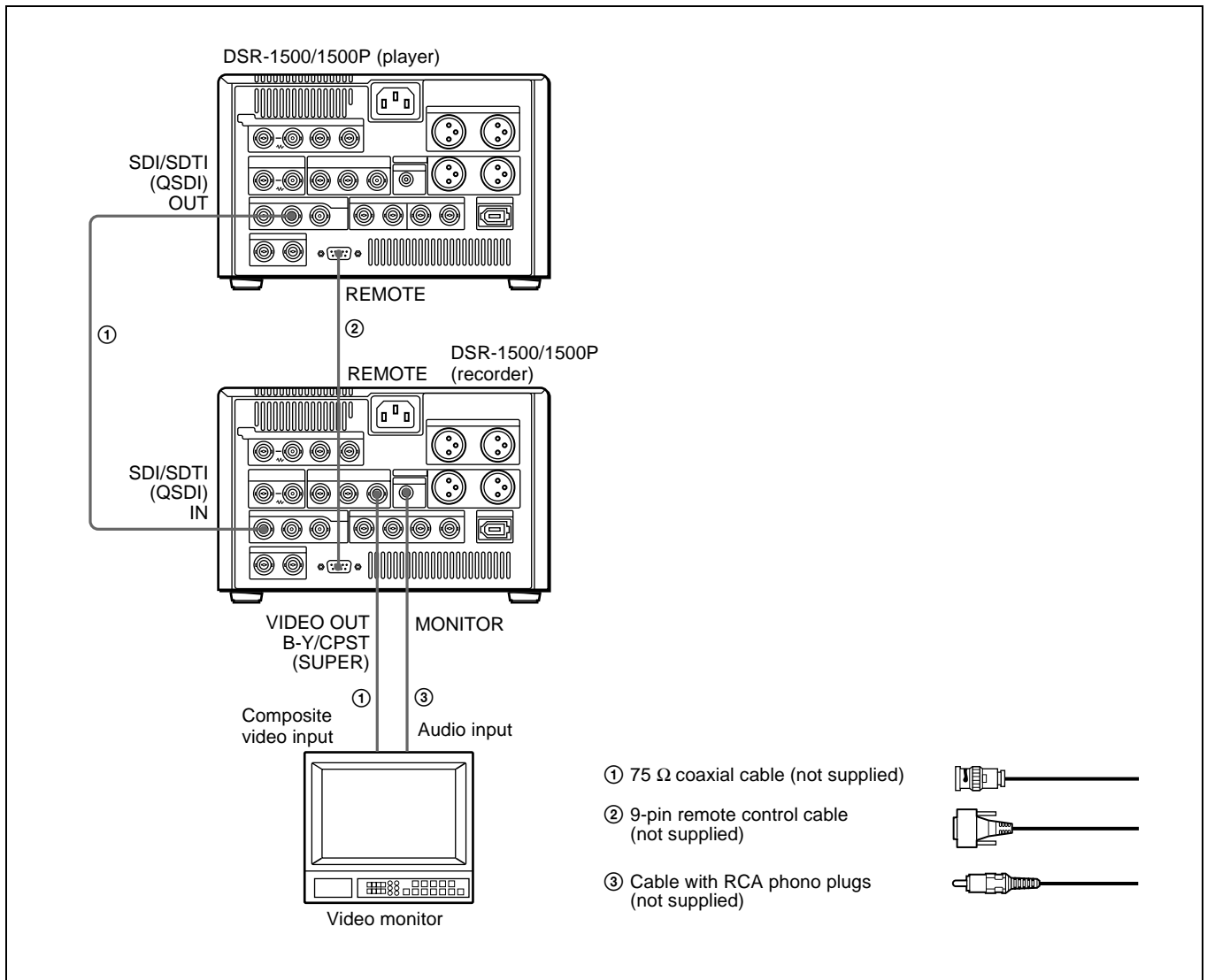

Settings on the DSR-1500/1500P (recorder)

Switch/menu item	Setting
LOCAL/REMOTE switch	LOCAL

Settings on the DSR-1500/1500P (player)

Switch/menu item	Setting
LOCAL/REMOTE switch	REMOTE (REMOTE indicator lights.)
DIGITAL OUTPUT menu item (<i>see page 67</i>)	SDTI (SDTI indicator lights.)
REMOTE I/F menu item (<i>see page 67</i>)	9PIN (9P indicator lights.)

Connections for Analog Recording

It is possible to record analog playback signals from another recorder or player on this unit. The following shows connections for a system in which analog component video signals and two channels of audio signals are recorded between two DSR-1500/1500P units.

Notes

- This application requires the DSR-1500/1500P unit used as the recorder to be fitted with the optional DSBK-1504/1504P board.
- The DSR-1500/1500P units shown in the following figure are fitted with the optional DSBK-1501, DSBK-1503, and DSBK-1504/1504P boards.

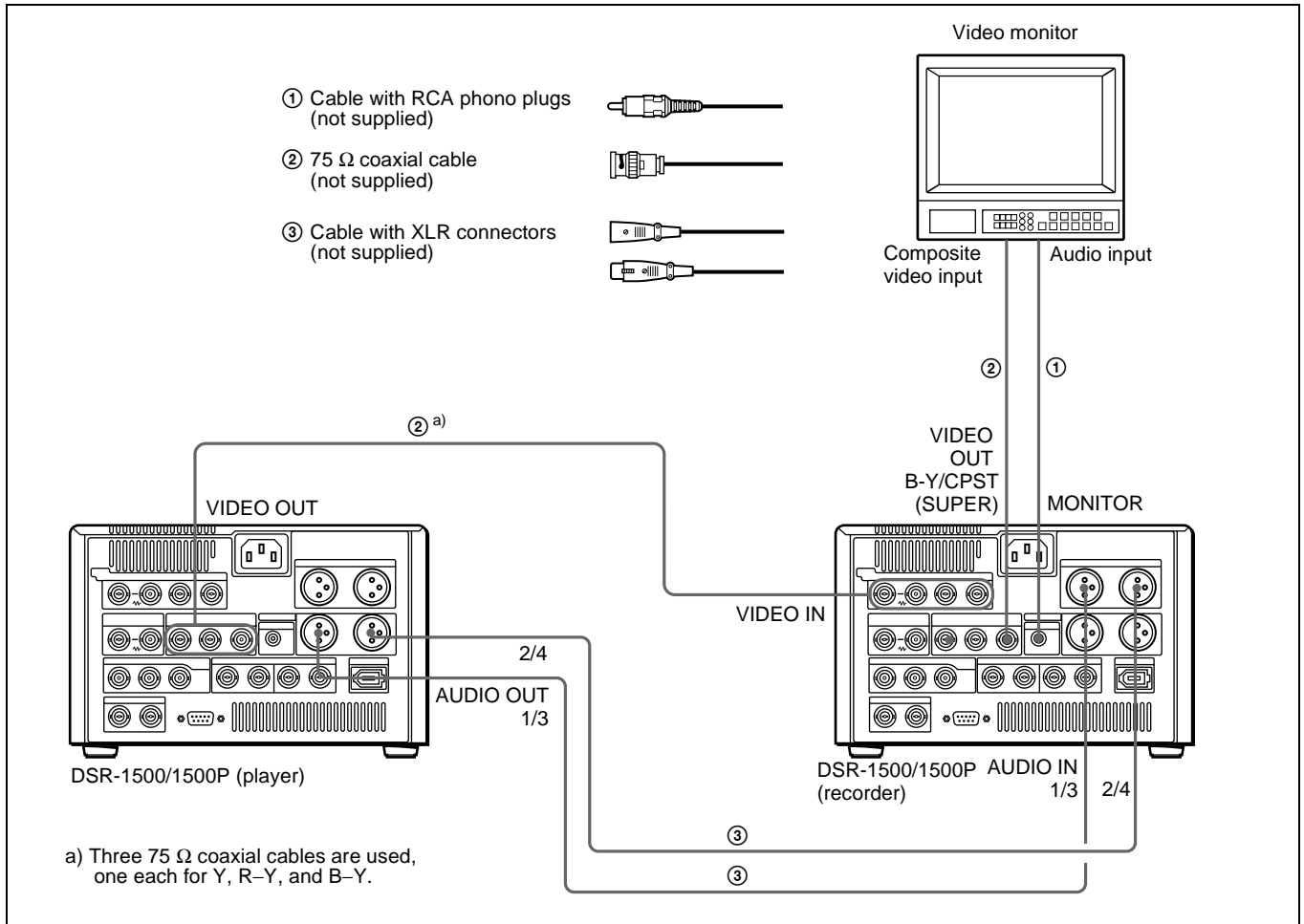

Settings on the DSR-1500/1500P (recorder)

Switch/menu item	Setting
LOCAL/REMOTE switch	LOCAL
CH1 IN LEVEL and CH2 IN LEVEL menu items (see page 66)	Normally +4 dBm
REC MODE menu item (see page 65)	2 CHANNEL (48kHz) (REC MODE 2CH indicator lights.)

Settings on the DSR-1500/1500P (player)

Switch/menu item	Setting
LOCAL/REMOTE switch	LOCAL
OUTPUT LEVEL menu items (see page 66)	Normally +4 dBm
VIDEO OUTPUT menu item (see page 67)	Y-R, B (Y-R,B indicator lights.)
AUDIO OUTPUT menu item (see page 67)	1/2 CH or 3/4 CH (CH 1/2 or CH 3/4 indicator lights.)

For details of the video/audio input and audio mode settings, see "Settings for Recording" on page 27.

Adjusting the Sync and Subcarrier Phases

When using two or more players, as in an A/B roll editing system, it is necessary to synchronize the sync and subcarrier (for composite signals) phases of the signals to be edited. If they are not synchronized, picture instabilities or color break-up may occur at edit points.

After configuring the editing system, use a vectorscope to adjust the sync and subcarrier phases of the recorder and players. Subcarrier phase adjustment is necessary when using composite signals and Y/C signals.

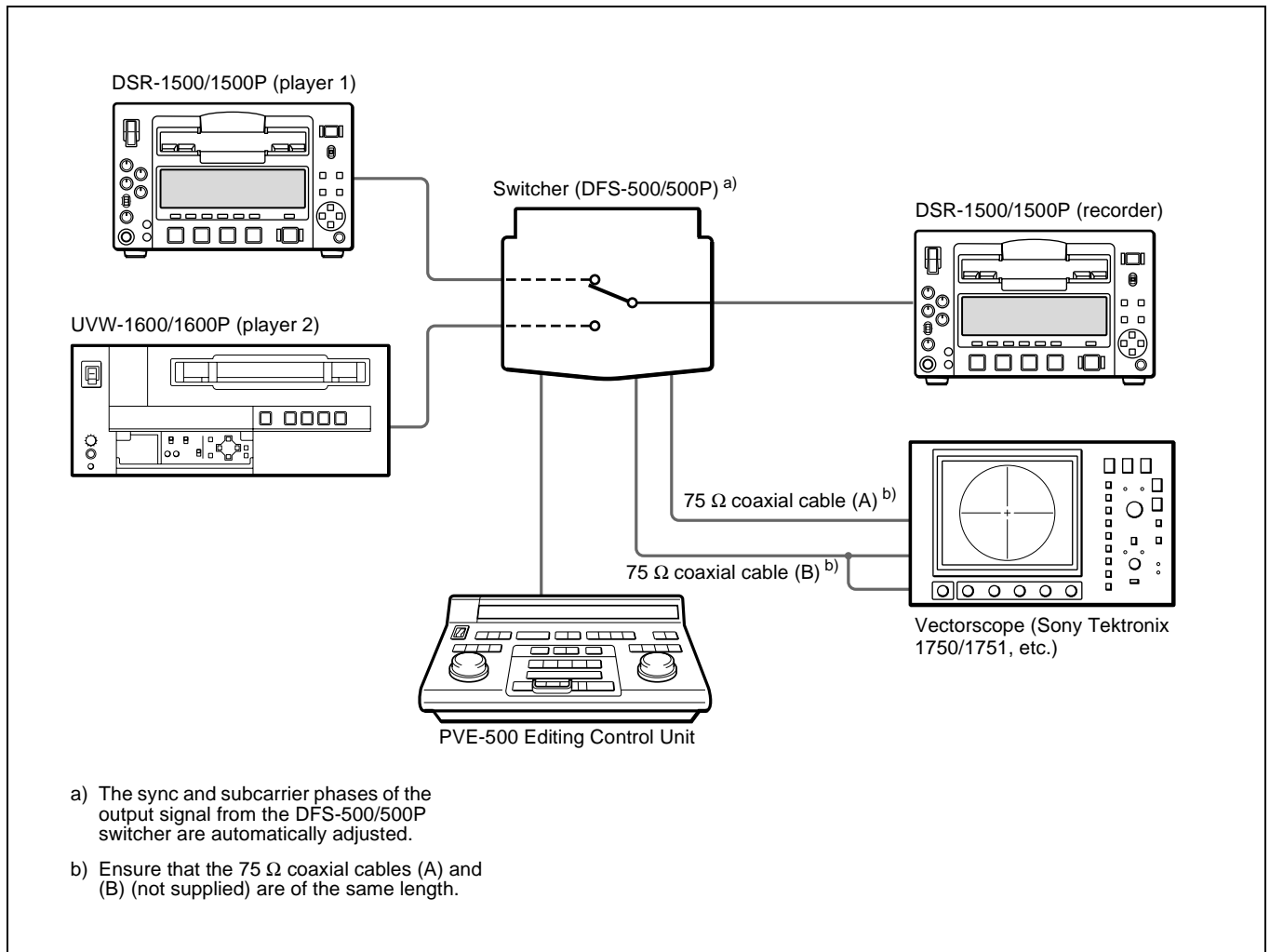

Performing a phase adjustment operation

- 1 Press the SCH button on the vectorscope.
The vectorscope switches to SCH mode.
- 2 Press the B channel button on the vectorscope.
This displays the black burst signal from the switcher.
- 3 Press the EXT button on the vectorscope.
This switches the vectorscope to external synchronization mode.
- 4 Adjust the phase synchronization control on the vectorscope so that the sync and subcarrier phases are close to the reference line.

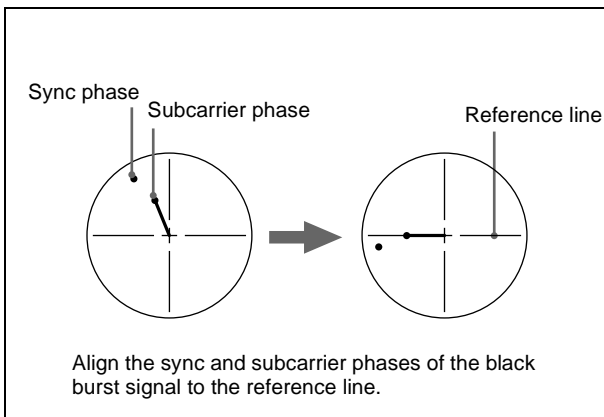

- 5 Output the player 1 signal from the PVE-500.
- 6 Press the A channel button on the vectorscope.
This displays the sync and subcarrier phases (composite signals only) of the signal from player 1.
- 7 On player 1, adjust the front panel SYNC PHASE and SC PHASE controls, using a Phillips screwdriver, so that the output from player 1 on channel A is in correct phase alignment with the black burst signal on channel B.

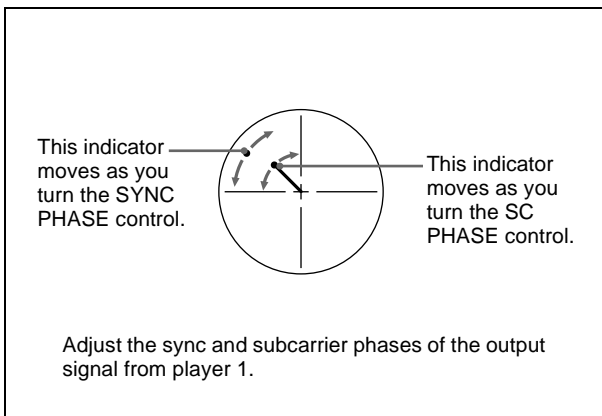

Note

When component signals are used the subcarrier phase indicator does not appear.

- 8 Output the player 2 signal from the PVE-500, and repeat steps 6 and 7 to adjust the sync and subcarrier phases of the output from player 2.

Maintenance and Troubleshooting

Chapter

6

Maintenance

Condensation

If you move the unit suddenly from a cold to a warm location, or if you use it in a very humid place, moisture from the air may condense on the head drum. This is called condensation, and if a tape is run in this state, the tape may stick to the drum and can be easily damaged. To lessen the risk of this occurring, this unit is equipped with a condensation detection system.

If condensation occurs while the unit is operating:

The alarm message “MOISTURE HAS BEEN DETECTED.” appears on the monitor screen, and the alarm message “HUMID!” in the time counter display. At the same time the unit ejects the cassette automatically. If this happens, leave the unit powered on and wait until the alarm messages disappear.

If the condensation alarm message appears immediately after powering on:

Leave the unit powered on and wait until the alarm message disappears. You cannot load a cassette into the unit while the alarm message is being displayed. Once the alarm message disappears, the unit is ready for use.

Regular Checks

Digital hours meter

The digital hours meter keeps cumulative counts of the total operating time, the head drum rotation time, the tape transport operating time, and the number of threading/unthreading operations. These counts can be displayed on the monitor screen and in the time counter display of this unit. Use them as guidelines for scheduling maintenance. In general, consult your Sony dealer about necessary periodic maintenance checks.

Digital hours meter display modes

The digital hours meter has the following four display modes.

- **T1 (OPERATION) mode**
The cumulative total hours during which the unit is powered on is displayed in 10-hour increments.
- **T2 (DRUM ROTATION) mode**
The cumulative total hours of drum rotation with tape threaded is displayed in 10-hour increments.
- **T3 (TAPE RUNNING) mode**
The cumulative total hours of tape transport operation for fast forward, rewind, playback, and search (except in still search mode) is displayed in 10-hour increments.
- **CT (THREADING) mode**
The cumulative number of tape threading/unthreading operation pairs is displayed in 10-operation pair increments.

For all modes except T1 (OPERATION), there are two types of count: a “trip” count, which is resettable, and the cumulative total from manufacture, which is unresettable.

Displaying the digital hours meter

Use the following procedure.

- 1 Press the MENU button in the menu control section.

The menu selection level display appears on the monitor screen and in the time counter display.

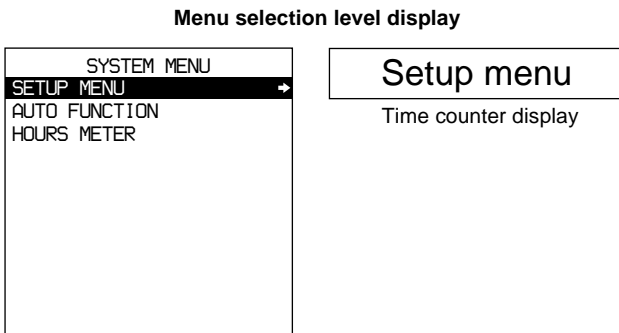

Monitor screen

- 2 Press the ▽ button to select "HOURS METER."

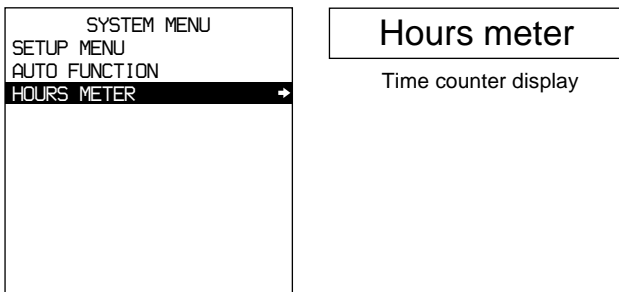

Monitor screen

- 3 Press the ▷ button.

The cumulative counts by the digital hours meter are indicated on the monitor screen and in the time counter display.

Digital hours meter indications on the monitor screen

All four counts (T1, T2, T3, and CT) are indicated on the monitor screen.

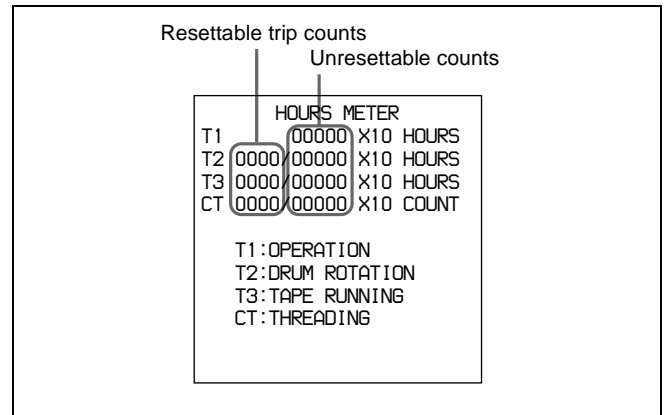

The four-digit value to the left of the slash (/) is the resettable trip count, and the right value is the cumulative total from manufacture.

Digital hours meter indications in the time counter display

One of the four indications appears in the time counter display at a time. Use the Δ and ▽ buttons in the menu control section to change the item displayed.

Initially, only the trip value appears. Hold down the ▷ button to display also the cumulative total from manufacture, which will appear to the right of the trip value and the slash (/).

The following illustrates the digital hours meter indications in the time counter display in all four display modes. The right-hand indication for each display mode is the indication you can view while holding down the ▷ button in the menu control section.

T1 (OPERATION) mode:



T2 (DRUM ROTATION) mode:



T3 (TAPE RUNNING) mode:



CT (THREADING) mode:



To end the digital hours meter display

Press the MENU button in the menu control section.

To reset the trip values

About this operation, consult your Sony dealer.

Head Cleaning

Always use the DVM12CL (mini size) or DV12CL (standard size) Cleaning Cassette to clean the video and audio heads. You can run the cleaning cassette for 10 seconds per cleaning operation. Follow the instructions for the cleaning cassette, as inappropriate use of the cleaning cassette can damage the heads.

To clean the heads

Insert the cleaning cassette. This automatically starts cleaning. You cannot operate any tape transport control buttons other than the EJECT button during the cleaning operation.

After about 10 seconds, the cleaning cassette will be automatically ejected.

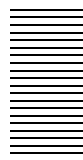

Troubleshooting

If an alarm message appears on the monitor screen, or if the unit appears to be malfunctioning, please check the following before contacting your Sony dealer.

Tape problems		
Symptom	Cause	Remedy
Recording is not possible.	The cassette's REC/SAVE switch is set to SAVE.	Set the REC/SAVE switch to REC, or use another cassette.
The unit's tape transport control buttons (PLAY, F FWD, REW, etc.) do not work.	The REMOTE indicator in the display section is lit and the LOCAL ENABLE menu item is set to STOP & EJECT or ALL DISABLE.	Set the LOCAL/REMOTE switch to LOCAL to turn the REMOTE indicator off, or change the setting of the LOCAL ENABLE menu item (<i>see page 59</i>) to ALL ENABLE.
	No cassette is loaded.	Insert a cassette (<i>see page 25</i>).
The NO EDIT indicator on the front panel lights up.	The audio recording mode selected on this unit does not coincide with that of the loaded tape.	<ul style="list-style-type: none"> When your current purpose is editing, set the LOCAL/REMOTE switch to LOCAL to turn the REMOTE indicator off and set the unit for the same audio recording mode as with the tape using the REC MODE menu item (<i>see page 65</i>), then set the switch to REMOTE to light the REMOTE indicator again. When your current purpose is recording, you can use the tape currently loaded in the unit.
	The recording format of the currently loaded tape is "DV" or "DVCPRO."	Replace the tape with one recorded in the DVCAM format.

Time data problems		
Symptom	Cause	Remedy
Cannot freely set the initial time data value.	The TC MODE menu item is set to EXT REGEN.	Change the setting of the TC MODE menu item (<i>see page 62</i>) to INT PRESET.
	CNT is selected as the time data type to be displayed (the COUNTER time data type indicator is lit).	Press the COUNTER SELECT button to make the TC or U-BIT time data type indicator light up (the CNT value cannot be set freely).
	The REMOTE indicator in the display section is lit and the LOCAL ENABLE menu item is set to STOP & EJECT or ALL DISABLE.	Set the LOCAL/REMOTE switch to LOCAL to turn the REMOTE indicator off or change the setting of the LOCAL ENABLE menu item (<i>see page 59</i>) to ALL ENABLE.
The tape is running, but the time data is not shown in the time counter display.	The MENU button or TC PRESET button in the menu control section has been pressed.	Press the button once again to exit the menu control mode, time code preset mode, or digital hours meter display mode. (In either of the menu control mode and time code preset mode, the time data is not shown in the time counter display.)
	The U-BIT time data type indicator is lit.	Press the COUNTER SELECT button to make the COUNTER or TC time data type indicator light up.

Input problem		
Symptom	Cause	Remedy
It is not possible to record an SDTI (QSDI) signal.	No SDTI signal is input to the unit, or the SDTI format has not been selected.	Connect an SDTI signal to the SDI/SDTI (QSDI) IN connector, or set the DIGITAL OUTPUT menu item (<i>see page 67</i>) to SDTI.

Monitor problems		
Symptom	Cause	Remedy
Data is not superimposed on the monitor screen.	The CHARA. DISPLAY menu item is set to OFF.	Set the CHARA. DISPLAY menu item (<i>see page 60</i>) to ON.
	The monitor is not connected to the B-Y/CPST (SUPER) connector of this unit.	Connect the monitor to the B-Y/CPST (SUPER) connector. (You must make this connection to display any type of text on the monitor.)
The image on the monitor screen is too bright.	The 75 Ω termination switch for video input on the monitor is in the OFF position, or a 75 Ω terminator is not fitted to its video input connector.	Set the 75 Ω termination switch to ON or connect a terminator.
The image on the monitor screen is too dark.	In a video signal loop-through connection of video monitors, 75 Ω termination switches for video input on monitors other than the loop-end monitor are in the ON position.	Set the 75 Ω termination switches to OFF on all monitors other than the loop-end monitor.
The image is too dark when recording a composite video signal.		

Audio problem		
Symptom	Cause	Remedy
The REC/PB LEVEL control knobs do not work.	The VAR switch on the front panel is set to PRESET.	Set the VAR switch to REC when recording, or set it to PB when playing back.

Editing restriction	
Symptom	Cause
Execution of video editing in insert mode erases subcode data (user bit data, etc.) recorded on tape other than time code data.	This phenomenon cannot be avoided with an editing system using this unit as the recorder.

Error Messages

This unit is provided with a self-diagnostic function that detects internal abnormalities. When it detects an abnormality, it outputs an error message to the monitor screen and indicates an error code in the time counter display.

Note

To display error messages on the monitor screen, connect the monitor to the B-Y/CPST (SUPER) connector, and set the CHARA. DISPLAY menu item (*see page 60*) to ON (factory default setting).

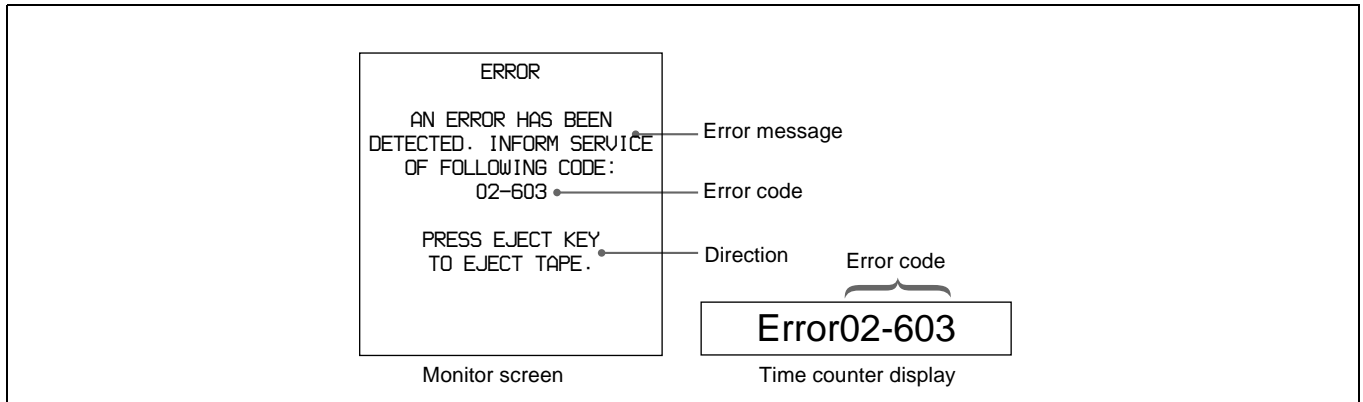

If an error message appears, follow the direction indicated on the monitor screen.

Alarm Messages

When operating this unit, the unit may sometimes output alarm messages such as the one shown below to the monitor screen and the time counter display.

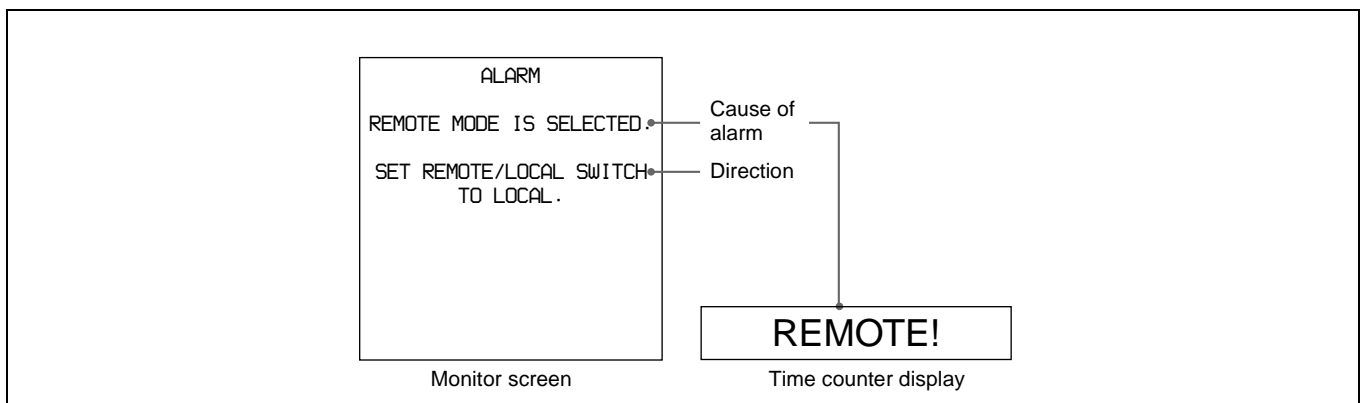

If such an alarm message appears, a connection or operation error may have been made, or condensation on heads may have occurred. Follow the direction indicated on the monitor screen.

Note

To display alarm messages on the monitor screen, it is necessary for the monitor to be connected to the B-Y/CPST (SUPER) connector, and set the following menu items to ON.

- CHARA. DISPLAY (*see page 60*)
- ALARM (*see page 61*)
- REF ALARM (*see page 61*)

Alarm messages and associated directions

Alarm message on monitor screen (Cause)	Direction	Alarm message in time counter display
A cleaning tape has been inserted.	The tape will automatically be ejected after cleaning is completed.	Cleaning Tp!
A non-standard signal is being used for input video.	Use a standard signal.	VIN NON-STD
A non-standard ref. signal is being used for REF. VIDEO.	Use a standard signal.	REF NON-STD
Abnormal settings selected in setup menu.	Correct the setup menu settings. Contact your Sony dealer if this alarm message appears again after making corrections.	ILL. SETUP!
Audio mixing mode cannot be changed during recording.	–	REC mode!
Audio not editable on this tape.	Use a tape recorded in 2-channel/48 kHz or 4-channel/32 kHz mode.	2CH/32kHz! Fs 44.1kHz!
	Use a tape having audio signals recorded in locked mode.	UNLOCK mode
Audio REC mode selection different from audio on tape.	Select the same audio recording mode as that of the tape.	A mode err
Audio REC (recording) mode cannot be changed during recording.	–	REC mode!
Cassette adaptor not usable.	Use a tape without cassette adaptor.	Adaptor!
Counter mode is selected.	Use the COUNTER SELECT button to light the TC or U-BIT time data type indicator in the display section.	CNT mode!
Input selection cannot be changed in REC (recording) mode.	–	REC mode!
Input signal does not conform to DVCAM/DV format.	–	Unknown Sig
Input signal is 625/50. (For DSR-1500)	–	625/50 sig! (For DSR-1500)
Input signal is 525/60. (For DSR-1500P)	–	525/60 sig! (For DSR-1500P)
Input video is not detected.	Check the VIDEO indicator in the INPUT signal display section and supply an appropriate video signal.	No INPUT!
Input video signal does not synchronize with REF. VIDEO signal.	Use a reference video signal.	ILL. REF!
Moisture has been detected.	Keep the power on and wait until this alarm message disappears.	HUMID!
No cassette in VTR.	Load a cassette.	No Cass.!
Rec inhibit mode is selected.	Set the REC INHIBIT menu item (<i>see page 59</i>) to OFF.	REC INHI.!
Record inhibit plug on the cassette is set to inhibit.	Set the REC/SAVE switch on the cassette to REC.	REC INHI.!
Remote mode is selected.	Set the LOCAL/REMOTE switch to LOCAL.	REMOTE!
Tape cannot be replayed.	Use a tape recorded in 525/60 format. (For DSR-1500)	625/50 Tape (For DSR-1500)
	Use a tape recorded in 625/50 format. (For DSR-1500P)	525/60 Tape (For DSR-1500P)
Tape end has been detected.	Use a new cleaning tape.	Tape end!

Alarm messages and associated directions

Alarm message on monitor screen (Cause)	Direction	Alarm message in time counter display
Tape not editable.	Use a tape recorded in DVCAM format.	Not DVCAM!
	Use a tape recorded in 525/60 format. (For DSR-1500)	625/50 Tape (For DSR-1500)
	Use a tape recorded in 625/50 format. (For DSR-1500P)	525/60 Tape (For DSR-1500P)
Tape not recordable.	Use a DVCAM/DV ME tape.	REC INHI.!
Tape not usable.	Use a DVCAM/DV/DVCPRO (25 Mbps) tape.	ILL. Tape!
TC EXTERNAL is selected.	Set the TC MODE menu item (<i>see page 62</i>) to INT PRESET.	TC EXT!
TCG REGEN mode is selected.	Set the TC MODE menu item (<i>see page 62</i>) to INT PRESET.	REGEN mode!
TCG RUN mode is set to REC RUN.	Set the RUN MODE menu item (<i>see page 62</i>) to FREE RUN.	REC RUN!



Appendixes

Precautions

On safety

- Should any liquid or solid object fall into the cabinet, unplug the unit and have it checked by qualified personnel before operating it further.
- Unplug the unit from the wall outlet if it is not to be used for an extended period of time.
- To disconnect the cord, pull it out by the plug. Never pull the cord itself.

On operation and storage locations

Avoid operation or storage in any of the following places.

- Location subject to extremes of temperature (operating temperature range 5°C to 40°C (41°F to 104°F))
- Location subject to direct sunlight for long periods, or close to heating appliances (Note that the interior of a car left in summer with the windows closed can exceed 50°C (122°F).)
- Damp or dusty places
- Location subject to severe vibrations
- Location near equipment generating strong electromagnetic emissions
- Location near transmitting stations generating strong radio waves

Operate the unit in a horizontal position

This unit is designed to be operated in a horizontal position. Do not operate it on its side, or tilted through an excessive angle (exceeding 20°).

Avoid violent impacts

Dropping the unit, or otherwise imparting a violent shock to it, is likely to cause it to malfunction.

Do not obstruct ventilation openings

To prevent the unit from overheating, do not obstruct ventilation openings, by for example wrapping the unit in a cloth while it is in operation.

On cleaning

If the casing or panel is dirty, wipe it gently with a soft dry cloth. In the event of extreme dirt, use a cloth steeped in a neutral detergent to remove the dirt, then wipe with a dry cloth. Applying alcohol, thinners, insecticides, or other volatile solvents may result in deforming the casing or damaging the finish.

On repacking and shipping

Save the original shipping carton and packing material; they will come in handy if you ever have to ship your unit. For maximum protection, repack your unit as it was originally packed at the factory, and take care not to impart violent shocks in transit.

Specifications

General

Signal system	DSR-1500: NTSC DSR-1500P: PAL
Power requirements	100 V to 240 V AC, 50/60 Hz
Power consumption (with all options installed)	65 W
Peak inrush current	(1)Power ON, current probe method: 30 A (100 V), 30 A (240 V) (2)Hot switching inrush current, measured in accordance with European standard EN55103-1: 20 A (230 V)
Operating temperature	5°C to 40°C (41°F to 104°F)
Storage temperature	-20°C to +60°C (-4°F to +140°F)
Operating relative humidity	Less than 80%
Storage relative humidity	Less than 90%
Mass	6.0 kg (13 lb 3 oz)

External dimensions (w/h/d)

211 × 137 × 420 mm
(8³/₈ × 5¹/₂ × 16⁵/₈ inches)

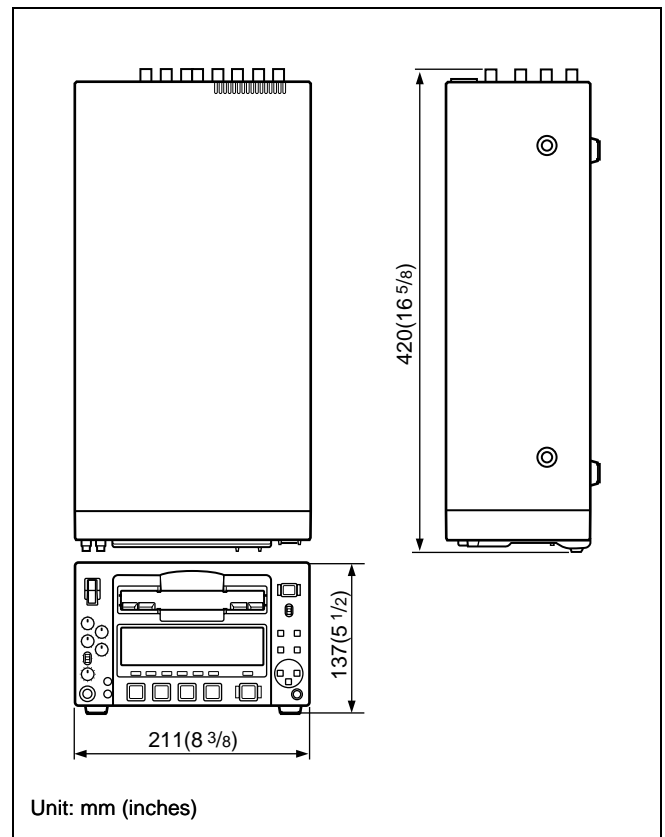

Tape transport control system

Tape speed	DSR-1500: 28.193 mm/s DSR-1500P: 28.221 mm/s
Recording/playback time	Using PDV-184ME standard-size cassette: Maximum 184 minutes Using PDVM-40ME mini-size cassette: Maximum 40 minutes
Fast forward/rewind time	Using PDV-184ME standard-size cassette: Less than 3 minutes Using PDVM-40ME mini-size cassette: Less than 1 minute
Search speed	When controlling via RS-422A interface: Maximum 60 times normal speed in both directions When controlling from DSRM-10 Remote Control Unit: Jog mode: 0 (still) to 2 times normal speed in both directions Shuttle mode: 8 speeds from 0 (still) to 16 times normal speed in both directions

Video performance

Band width	Composite/S-video (DSR-1500): 30 Hz to 4.2 MHz ± 1.0 dB (Y) Composite/S-video (DSR-1500P): 25 Hz to 4.8 MHz ± 1.0 dB (Y) Component (DSR-1500): 30 Hz to 5.0 MHz ± 1.0 dB (Y), 30 Hz to 1.5 MHz +1.0/-5.0 dB (R-Y/ B-Y) Component (DSR-1500P): 25 Hz to 5.0 MHz ± 1.0 dB (Y), 25 Hz to 2.0 MHz +1.0/-2.0 dB (R-Y/ B-Y)
S/N	Composite/S-video I/O (Y): 52 dB or more Component I/O (Y): 55 dB or more
Y/C delay	30 ns or less
K-factor	2.0% or less (K2T, KPb)

Processor adjustment range

Video level*	± 3 dB/- ∞ to 3 dB selectable
Chrome level*	± 3 dB/- ∞ to 3 dB selectable
Setup/Black level*	± 30 IRE (± 210 mV)
Chroma phase*	$\pm 30^\circ$
System phase**	Sync: ± 1 μ s SC: $\pm 180^\circ$

* Adjust with menu settings.

** Adjust with controls on the front panel.

Audio performance

Frequency response	Two-channel (48 kHz) mode: 20 Hz to 20 kHz ± 1.0 dB Four-channel (32 kHz) mode: 20 Hz to 14.5 kHz ± 1.0 dB
Dynamic range	More than 87 dB
Distortion (THD + N)	Less than 0.07% (48 kHz)

Input connectors

Digital signal inputs

SDI/SDTI (QSDI) IN (optional DSBK-1501 Digital Input/
Output Board required)

BNC type
SDTI (QSDI) format (270 Mbps)
SDI format (270 Mbps), SMPTE 259M/
CCIR656-III

AUDIO (AES/EBU) IN (optional DSBK-1501 Digital
Input/Output Board required)

BNC type ($\times 2$), complying with AES-
3id-1995

i.DV IN/OUT (optional DSBK-1503 i.LINK/DV Input/
Output Board required)

6-pin IEEE 1394 connector

Analog video inputs

REF. VIDEO IN

BNC type ($\times 2$, loop-through with 75 Ω
automatic terminator)

Black burst

0.286 V (DSR-1500) or 0.3 V (DSR-
1500P), 75 Ω , negative sync

Composite sync

VIDEO IN (optional DSBK-1504/1504P Analog Input
Board required)

BNC type ($\times 3$ and 1 loop-through
connector with 75 Ω automatic
terminator), composite/component/S-
video switchable

Composite

Y/CPST and 1 loop-through connector
with 75 Ω automatic terminator: 1.0
Vp-p, 75 Ω , sync negative

Component

Y/CPST: 1.0 Vp-p, 75 Ω , negative sync
R-Y/C and B-Y: 0.7 Vp-p (75% color
bars for DSR-1500 or 100% color bars
for DSR-1500P), 75 Ω

S-video

Y/CPST: 1.0 Vp-p, 75 Ω , negative sync
R-Y/C: 0.286 Vp-p (DSR-1500) or 0.3
Vp-p (DSR-1500P), 75 Ω (burst level)

Analog audio inputs

AUDIO IN (optional DSBK-1504/1504P Analog Input
Board required)

XLR 3-pin, female ($\times 2$), +4/0/-3*/-6
dBm, high impedance, balanced

* For DSR-1500P only

Time code input

TC IN

BNC type, SMPTE time code (DSR-
1500) or EBU time code (DSR-
1500P), 0.5 Vp-p to 18 Vp-p, 3.3 k Ω ,
unbalanced

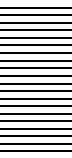

Output connectors

Digital signal outputs

SDI/SDTI (QSDI) OUT (optional DSBK-1501 Digital Input/Output Board required)

- BNC type (×2)
- SDTI (QSDI) format (270 Mbps)
- SDI format (270 Mbps), SMPTE 259M/CCIR656-III

AUDIO (AES/EBU) OUT (optional DSBK-1501 Digital Input/Output Board required)

- BNC type (×2), complying with AES-3id-1995

i.DV IN/OUT (optional DSBK-1503 i.LINK/DV Input/Output Board required)

- 6-pin IEEE 1394 connector

Analog video outputs

VIDEO OUT BNC type (×3), composite/component/S-video switchable

Composite

Y/CPST, R–Y/C/CPST, and B–Y/CPST (SUPER): 1.0 Vp-p, 75 Ω, sync negative

Component

Y/CPST: 1.0 Vp-p, 75 Ω, negative sync
R–Y/C/CPST and B–Y/CPST (SUPER):
0.7 Vp-p (75% color bars for DSR-1500 or 100% color bars for DSR-1500P), 75 Ω

S-video

Y/CPST: 1.0 Vp-p, 75 Ω, negative sync
R–Y/C/CPST: 0.286 Vp-p (DSR-1500)
or 0.3 Vp-p (DSR-1500P), 75 Ω (burst level)

Analog audio outputs

AUDIO OUT XLR 3-pin, male (×2), +4/0/–3*/–6 dBm, 600 Ω loading, low impedance, balanced

MONITOR

Phono jack, –∞ to –11 dBu ±1 dBu, 47 kΩ, unbalanced

* For DSR-1500P only

Output for headphones

HEADPHONES

Stereo phone jack, –∞ to –13 dBu, 8 Ω, unbalanced

Time code output

TC OUT

BNC type, SMPTE time code (DSR-1500), EBU time code (DSR-1500P), 2.2 Vp-p ±3 dB, 600 Ω, unbalanced

Remote control connectors

- REMOTE D-sub 9-pin, for connection of editing control unit*, RS-422A standard
- CONTROL S Stereo minijack, for connection of SIRCS-compatible remote control unit (DSRM-10)
- i.DV IN/OUT (optional DSBK-1503 i.LINK/DV Input/Output Board required)
6-pin IEEE 1394 connector

* ES-7, PVE-500, RM-450/450CE, BVE-600/800/910/2000/9100/9100P, etc.

Supplied accessories

- AC power cord (1)
- Operating Instructions (1)

Optional accessories

- DSBK-1501 Digital Input/Output Board
- DSBK-1503 i.LINK/DV Input/Output Board
- DSBK-1504/1504P Analog Input Board
- RCC-5G/10G/30G 9-pin remote control cable (length: 5 m (16 ft)/10 m (33 ft)/30 m (98 ft))
- Digital video cassette
 - Standard size: PDVM-64ME/94ME/124ME/184ME
 - Mini size: PDVM-12ME/22ME/32ME/40ME
- Cleaning cassette
 - DV12CL (standard size), DVM12CL (mini size)

Related equipment

- ES-3/7 EditStation
- Linear editing control unit: PVE-500, RM-450/450CE, BVE-600/800/910/2000/9100/9100P
- DME switcher: DFS-300/300P, DFS-500/500P, DFS-700/700P
- DXC-D30/D30P Color Video Camera
- DSR-1/1P/300A Digital Videocassette Recorder
- DSR-85/85P/70/70P/80/80P/1800/1800P/2000/2000P Digital Videocassette Recorder
- DSR-60/60P/1600/1600P Digital Videocassette Player
- DSR-300/300P/500WS/500WSP/130/130P/150/150P Digital Camcorder
- DSRM-10 Remote Control Unit

Design and specifications are subject to change without notice.



ClipLink Guide

What Is ClipLink?

The ClipLink function greatly improves the efficiency of the video production process as a whole by recording various editing-related data on tape when shooting. As such, ClipLink is a revolutionary function that transcends the conventional separation of shooting and editing.

How ClipLink Changes Video Production Techniques

The following describes various ways in which ClipLink* video production differs from conventional video production.

* The ClipLink system is a video production system which uses the cassette memory function.

Recording of ClipLink log data lightens the shooting workload

When you start shooting a scene, ClipLink log data such as the scene number and time code data are automatically recorded into the cassette memory. This eliminates the need for a conventional “shot list” compiled by someone using a stopwatch, clipboard and pencil. You can also designate unwanted scenes as “NG” (no good) and automatically skip all “NG” scenes when editing.

Recorded index pictures drastically cut editing time

The ClipLink function also features index pictures as a time-saving tool for rough editing. Each index picture is a compressed image taken from the start of each scene, which is recorded onto the tape as a still picture. When editing, begin by transferring only the index pictures and the ClipLink log data to the EditStation’s hard disk. You can also transfer OK scenes only (“NG” scenes are skipped).

Next, begin rough editing by viewing the index pictures on the EditStation’s GUI display and rearranging them as you wish. This eliminates the difficult work of matching up a handwritten shot list with recorded scenes. After you have completed this rough editing, you can then transfer only the recordings needed for your video program.

High-speed transfer of recordings

It is also possible to transfer the editing material itself between the DSR-85/85P and ES-7 at four times normal speed. In other words, the transfer can be carried out in one fourth of the real time duration. It is of course possible to carry out a transfer at four times normal speed when backing up video and audio data recorded on the disk drive to the DSR-85/85P, or in the opposite direction when loading data backed up on the DSR-85/85P to the disk drive. Thus the time required is much shorter than with conventional equipment (for which, for example, transferring a 40-minute segment of video takes 40 minutes).

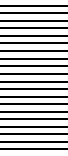

Example System Configuration and Operation Flow

The following illustration shows an example system configuration for using the ClipLink function and a typical ClipLink operation flow.

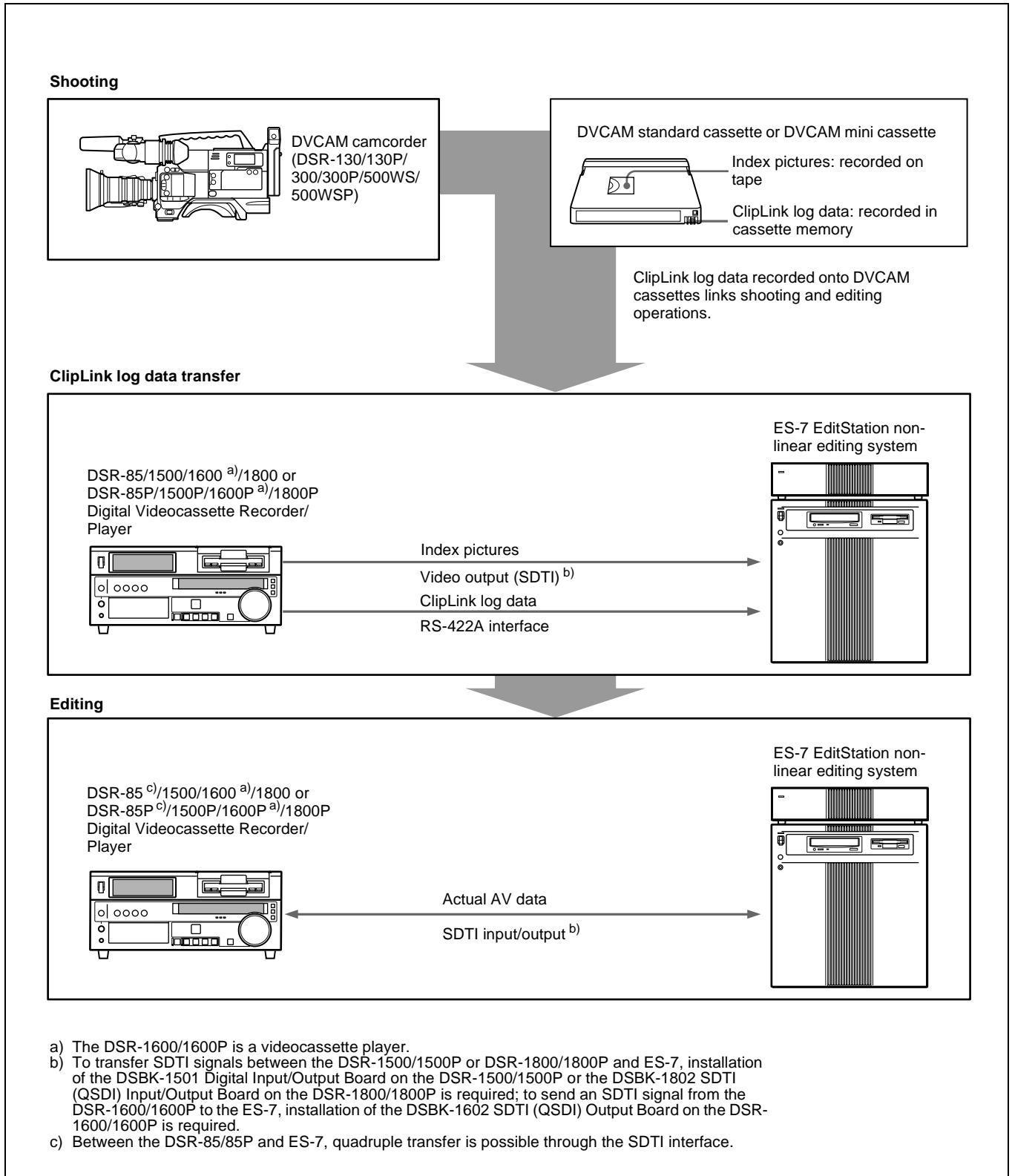

Data Generated When Shooting

The following describes the kinds of data that is generated when using the ClipLink function.

Index pictures

When shooting, a single-frame image from the Mark IN point at the start of each scene is recorded as a still picture into the camcorder's internal memory. These images are called "index pictures." When you finish shooting, the index pictures from all scenes are recorded onto the tape after the last scene.

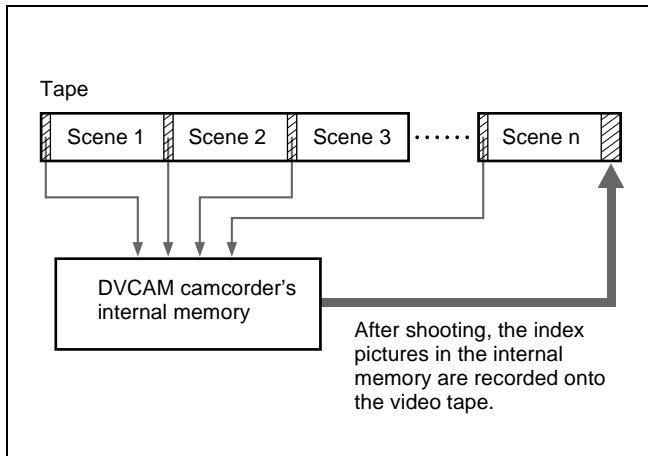

Up to 32 index pictures can be recorded onto the tape space normally occupied by one frame, as shown below.

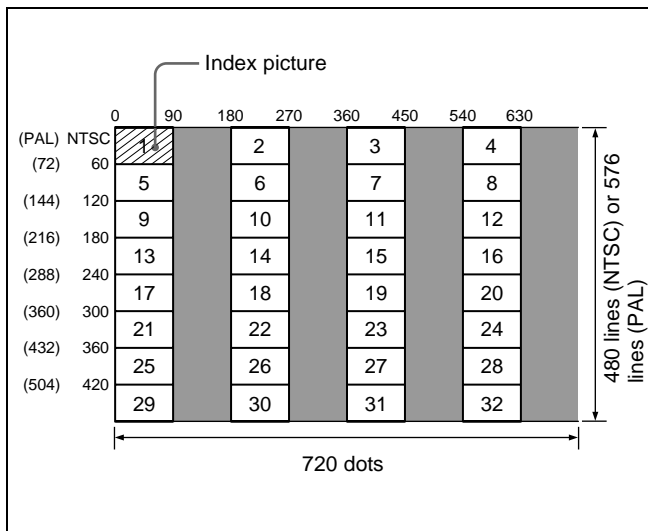

Seven frame spaces are reserved at the end of the last scene as a recording area for index pictures. (A cassette with 16 Kbits of cassette memory can record up to 198 index pictures, and a cassette with 4 Kbits of cassette memory can record up to 45 index pictures.)

ClipLink log data

ClipLink log data can be recorded automatically or manually into the cassette memory for use as a convenient alternative to the conventional "shot list."

ClipLink log data includes the following items.

ClipLink log data	Description
Reel number (cassette number)	Data (maximum length: 8 digits) consisting of alphanumeric characters and/or symbols (This is left blank at shipping.)
Scene number	A three-digit number from 001 to 198 (starts at 001 and is automatically incremented with each scene.)
Take number	This cannot be changed (set to "1" at shipping).
OK/NG	Indicates the OK/NG status of a particular scene. (In the OK case, nothing is recorded.)
Mark IN/OUT point time codes	These are the time codes that indicate the Mark IN and Mark OUT points for each scene (HH:MM:SS). These time codes are recorded when the camera has been set to MARK mode. The time code value is rounded up at each Mark IN point and rounded down at each Mark OUT point, to a whole number of seconds. <i>For details, see "Time codes recorded for Mark IN/OUT points" on page 109.</i>
Cue point time code	This is the time code that indicates the cue points (valid up to the frame digit). This time code is recorded when the camera has been set to CUE mode. When in this mode, the time codes at the start and end of a recording (the Rec IN and Rec OUT time codes) are automatically recorded as Mark IN and OUT points, respectively.

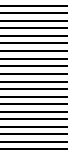

How to record ClipLink log data

The following describes how to record the various ClipLink log data items.

OK/NG status

To designate a scene as “NG,” press the NG button on the camera while shooting the scene or at any time before you begin shooting the next scene.

All scenes that do not receive an “NG” designation are recorded as “OK” scenes.

(When you exit the VCR recording mode, changing the OK/NG status is no longer possible.)

Mark IN/OUT point time codes

This data is especially useful when shooting a video program for which a scenario has been created.

Set the camera to MARK mode before you start shooting. While shooting, each time you press the camera’s TAKE button, Mark IN and Mark OUT point time codes are recorded alternately.

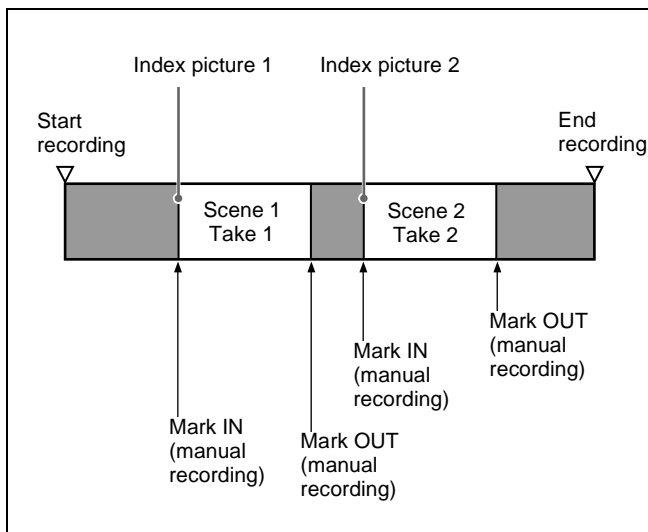

Cue point time codes

This type of data is especially useful when shooting scenes that may contain unexpected events, such as when shooting for sports coverage or documentaries.

Set the camera to CUE mode before you start shooting.

While shooting, each time you press the camera’s TAKE button, the current time code is recorded as a cue point time code.

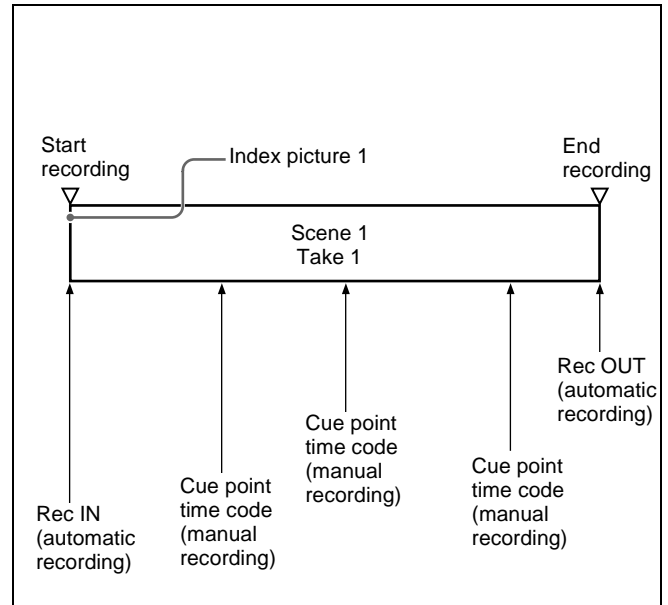

Time codes recorded for Mark IN/OUT points

There is a gap between actual time codes and Mark IN/OUT time codes recorded in the cassette memory, as shown in the figure below. The time code value is rounded

up at each Mark IN point and rounded down at each Mark OUT point, to a whole number of seconds.

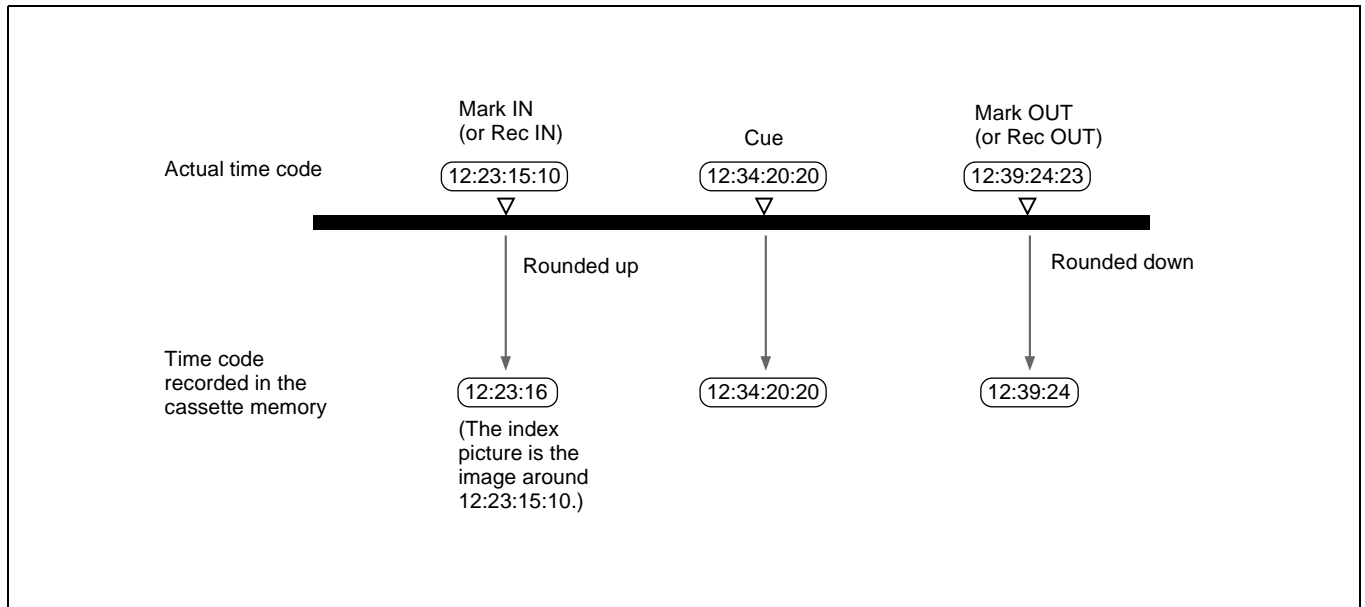

Recording capacity for Mark IN/OUT point time codes and cue point time codes

When in MARK mode, up to 198 pairs of Mark IN and Mark OUT points can be recorded (if using a cassette with 16 Kbits of cassette memory).

When in CUE mode, up to 396 time code points (including all cue point time codes and all Mark (Rec) IN and Mark (Rec) OUT point time codes) can be recorded (if using a cassette with 16 Kbits of cassette memory).



Glossary

A/B roll editing

An editing method that uses two or more playback VCRs to create special effects such as dissolve and wipe, and uses one record VCR to record the results of the editing. Using an editing control unit allows efficient control of the VCRs and very precise editing.

AES/EBU format

A unified format for digital audio signals. It allows a single connector to carry the signals for two channels.

B–Y signal

A chrominance signal determined by subtracting the Y (luminance) signal from the B (blue) signal. One of the component signals.

Capstan

A drive mechanism that moves the tape at a specified speed. Its rotation normally synchronizes with a reference sync signal.

Chrominance signal

Color signal containing color information such as hue and saturation. Also called C signal.

Component signals (YRB)

A video signal consisting of a luminance signal (Y) and two chrominance signals (R–Y, B–Y).

Composite signal

A composite video signal containing video, burst and sync signals.

Condensation

Condensation of moisture on the tape transport mechanisms of VCRs including the head drum. If moisture condenses on the head drum, the tape adheres to the drum and causes malfunction.

Drop frame mode

Time code runs at 30 frames/sec. The NTSC system, however, runs at about 29.97 frames/sec. Drop frame mode adjusts this difference. The time code and video are synchronized by dropping the first two frames of the time code every minute, except at the ten-minute marks.

EE mode

EE is an abbreviation of “Electric to Electric”. Video and audio signals are supplied to the VCR’s internal circuits, but not to the recording heads.

Head drum

A metal cylinder to which a video head is attached. This drum is rotated at high speeds in synchronization with the sync signal during recording and playback.

Linear editing

Editing while playing back video and audio signals recorded on video tape. *See also “Non-linear editing.”*

Loading

When being loaded, the tape is pulled out of the cassette case and threaded along the specified tape path and wrapped round the drum to be ready for recording or playback. Generally, this is done automatically when you place the cassette at the cassette entrance of the VCR. Also called threading.

Loop-through connection

A connection which allows a signal input to an input connector to pass through the unit and exit from an output connector as input to external equipment. Also called bridging connection.

Luminance signal

The signal that determines the brightness of the picture. Also called Y signal. One of the component signals.

Non-drop frame mode

The number of frames of the time code and video run is not adjusted. When you use the time code in non-drop frame mode, the real playback time will be about 86 seconds shorter per day than the time code. If you edit frame by frame or if you determine the length of a shot by counting the time code, use drop frame mode.

Non-linear editing

Editing while playing back video and audio signals recorded on hard disks. Video scenes stored on disk can be cued up quickly, for increased editing efficiency. *See also “Linear editing.”*

PCM audio

This is an audio signal represented by pulse code modulation. The analog audio signal is first broken down into a sequence of pulses, and these are then represented digitally.

Preroll

Running of a video tape to a prior to an edit-start point to enable the tape to reach a steady speed and to be synchronized with other video tapes.

R–Y signal

A chrominance signal determined by subtracting the Y (luminance) signal from the R (red) signal. One of the component signals.

Reference video signal

A video signal consisting of a sync signal or sync and burst signals, used as a reference.

Setup (for DSR-1500)

The difference between the reference black level and the blanking level of a composite signal.

SMPTE

Abbreviation of Society of Motion Picture and Television Engineers, a professional association established in the USA.

S/N

Abbreviation of Signal-to-Noise (ratio). The higher the S/N value, the less noise and higher the picture quality.

Search mode

A VCR operating mode used when searching for specific scenes, by viewing the video output or time code values while playing back the tape at various speeds in forward or reverse direction.

Servo lock

Synchronizing the drum rotation phase and tape transport phase with a reference signal during playback and recording so that the video heads scan the tape in the same pattern during playback and recording.

Standby Off mode

One of two conditions in the stop mode. The drum does not rotate and tape is slackened. There is no damage to the video heads and the tape, but the VCR is not ready for immediate recording or playback.

Standby On mode

One of two conditions in the stop mode. The drum is rotating and the tape is wrapped round the drum. The VCR is ready for recording or playback, so a still picture can be obtained.

Subcarrier

A sine wave imposed on the luminance portion of a video signal and modulated to carry color information. Its amplitude represents color saturation and its phase represents hue.

Superimpose

To put a set of characters onto a picture so that both can be seen at the same time.

S-video

A signal format in which Y (luminance) and C (chrominance) signals are separated to reduce interference between them so that noiseless images are reproduced.

Sync signal

A reference signal consisting of vertical and horizontal sync signals used for synchronizing the scanning patterns of the video camera and the monitor.

TBC

Abbreviation of Time Base Corrector. Electronic circuits to electrically stabilize the playback signals by removing color variation and roll in the playback picture caused by irregularity in drum rotation and tape movement. Time base correction reduces deterioration of picture quality when transmitting or copying playback signals.

Threading

See "Loading."

Time code

Signals recorded on the tape to supply information on tape position such as the hour, minute, second and frame, to assist in setting edit points or searching for particular scenes.

Unloading

When the EJECT button is pressed, the VCR automatically winds the tape back into the cassette case. Also called "Unthreading."

User bits

Sections of time code information consisting of a total of 32 bits that can be used for recording information such as date, tape ID number, program ID number, etc.



Index

Numerics

- 2CH indicator 16
- 32K indicator 15
- 44.1K indicator 15
- 48K indicator 15
- 4CH indicator 16
- 9P indicator 15

A

- A/B roll editing system 83
- AC IN connector 18
- Accessories 104
- AES/EBU
 - format 12
 - indicator 14
- Alarm messages 98
- Analog
 - audio 6
 - audio input(s) 12, 103
 - audio outputs 104
 - Input Board 7
 - interfaces 6
 - recording 90
 - video 6
 - video inputs 103
 - video outputs 104
 - video/audio signal input section 19
 - video/audio signal output section 20
- ANALOG indicator 14
- Arrow buttons 17
- Audio
 - input/output level control section 11
 - level meters 9
 - performance 103
 - problem 97
 - test signal 12
- AUDIO (AES/EBU)
 - IN 1/2 and 3/4 connectors 21
 - OUT 1/2 and 3/4 connectors 21
- AUDIO IN 1/3 and 2/4 connectors 19
- AUDIO indicators 14, 15
- AUDIO OUT 1/3 and 2/4 connectors 20
- AUTO FUNCTION 71
- Auto mode execution menu 71
- Automatic cyclical playback 36

B

- B-Y connector 19
- B-Y/CPST (SUPER) connector 20

C

- Cassette 23
 - compartment 9
 - memory indicator 15
- CH1 1/2 button 12
- CH-1 1/2 indicator 14
- CH2 3/4 button 12
- CH-2 3/4 indicator 14
- CL indicator 15
- ClipLink 7
 - Guide 105
 - index pictures 107
 - log data 107
 - log data recording 108
 - log data recording capacity 109
 - system configuration 106
- Closed caption 7
- CNT 10
 - value resetting 45
- Component video input 11
- COMPOSITE indicator 14
- Composite video input 11
- Condensation 93
- Connections 79
 - A/B roll editing system 83
 - analog recording 90
 - audio monitor system 85
 - control signal 86
 - cut editing system 81
 - digital non-linear editing system 79
 - reference video signal 85
 - SDTI (QSDI) dubbing 89
 - video monitor 88
 - video/audio signal 87
- CONTROL S connector 10
- COUNTER 10, 15
 - SELECT button 10
- Cue point 108
- Cuing up 42
- Cut editing system 81
- Cyclical playback 36

D

- Digital
 - hours meter 7
 - Input/Output Board 7
 - interfaces 6
 - jog sound 6
 - non-linear editing system 79
 - signal input/output section 21
 - signal inputs 103

- signal outputs 104
- slow motion playback 6, 50
- Digital hours meter 93
- Display section 13
- Drop frame indication 44
- DSBK-1501/1503/1504/1504P 7
- Dubbing 51
 - SDTI (QSDI) 89
- DV 15
 - input 11
- DVCAM 15, 51
 - cassettes 24
 - digital dubbing 51
 - format 5

E

- EBU time code 15
- EDIT MODE indicator 16
- Editing
 - control unit settings 88
 - points 50
 - restriction 97
- EE OUT PHASE 69
- EJECT button 9
- Error messages 98

F

- F FWD button 16
- FREE RUN 46
- Front panel 8

H

- Head cleaning 95
- High-speed
 - search 6, 50
 - transfer 105
- Hours meter 7, 93

I

- i.DV IN/OUT connector 18
- i.LINK 11
 - indicator 13, 15
- i.LINK (DV) 6
- i.LINK DUBBING 71
- i.LINK/DV Input/Output Board 7
- Index pictures 107
- Input problem 96
- INPUT signal display section 13
- Interfaces 6
- Internal test signal generator 7
- Internal time code generator 45
 - advancement 46

- J**
 Jog 50
 audio 50
 sound 6
- L**
 LOCAL/REMOTE switch 9
 LP 15
- M**
 Maintenance 7, 93
 Mark IN/OUT points 108, 109
 Menu 55
 AUDIO CONTROL 65
 AUTO FUNCTION 71
 changing settings 72
 contents 58
 DISPLAY CONTROL 60
 indications 58
 INTERFACE SELECT 67
 MENU GRADE 68
 OPERATIONAL FUNCTION 58
 organization 55
 resetting to default settings 75
 SETUP BANK OPERATION 67
 TAPE PROTECTION 63
 TIME CODE 62
 VIDEO CONTROL 64
 MENU button 17
 Menu control section 17
 METER CH-1/2 3/4 button 10
 MONITOR
 connector 20
 SELECT button 10
 Monitor
 problems 97
 screen contents 44
- N**
 NO EDIT indicator 15
- O**
 OK/NG status 108
 Operation mode 44
 indications 43
 Optional boards 7
 OUTPUT signal display section 14
- P**
 PB Fs display 15
 PCM digital audio 5
 Phase adjustment 91
 PHONES
 connector 9
 control knob 9
 PLAY button 16
 Playback 33
 compatibility 5
 cyclical 36
 procedure 34
 settings 33
 slow motion 6
 Points A and B 36
 POWER switch 9
 Precautions 101
 Processor adjustment range 103
- R**
 Rear panel 18
 REC button 16
 REC INHI indicator 15
 REC MODE display 16
 REC RUN 46
 REC/PB LEVEL control knobs 11
 Recording 27
 procedure 30
 settings 27
 Recording/playback tape format indicators 15
 REF. VIDEO IN connectors 18
 Reference video signals 82
 Regular checks 93
 Related equipment 104
 REMOTE
 connector 18
 indicator 15
 Remote
 control 6
 control connectors 104
 mode indicators 15
 REPEAT indicator 15
 Repeat playback 36
 Rerecording time code 47
 RESET (NO) button 17
 REW button 16
 R-Y/C connector 19
 R-Y/C/CPST connector 20
- S**
 S VIDEO indicator 14
 SC control 9
 SDI 6
 audio input 12
 indicator 14
 video input 11
 SDI/SDTI (QSDI)
 IN connector 21
 OUT1/OUT2 connectors 21
 SDTI (QSDI) 6, 89
 input 11
 SDTI DUBBING 71
 SDTI indicator 13, 14
 SDTI/i.LINK button 11
 Search 50
 via external equipment 50
 SERVO indicator 15
 SET (YES) button 17
 Setup menu 58
 SG indicator 14
 Shuttle 50
 Slow motion playback 6
 SMPTE time code 15
 Still 50
 STOP button 16
 Subcarrier phase 91
 Superimposed text 20
 Superimposition 7
 Supplementary status information 76
 S-video input 11
 SYNC control 9
 Sync phase 91
- T**
 Tape
 end alarm indicator 15
 problems 96
 transport control section 16
 TC 10, 15
 IN connector 21
 INSERT 71
 insert function 47
 OUT connector 21
 PRESET button 17
 Test signal generator 7
 THROUGH mode 69
 Time code 7
 input 103
 input/output section 21
 output 104
 rerecording 47
 synchronization 46
 value setting 45
 Time code generator 45
 advancement 46
 Time counter display 15
 Time data
 displaying 43, 45
 problems 96
 setting 43
 type 44
 type indicators 15
 Troubleshooting 96
- U**
 U-BIT 10, 15

Usable cassettes 23
User bit data setting 45

V

V SDTI indicator 13

VAR switch 11

VIDEO

button 11

IN connectors 19

indicators 14

INPUT PHASE mode 69

OUT connectors 20

OUTPUT PHASE mode 70

Video

performance 103

process control 7

test signal 11

Video/audio input setting section 11

VITC

field indication 44

indicator 16

W

Wide track 5

Y

Y/CPST connector 19, 20

Y-R,B indicator 14

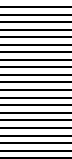



Free Manuals Download Website

<http://myh66.com>

<http://usermanuals.us>

<http://www.somanuals.com>

<http://www.4manuals.cc>

<http://www.manual-lib.com>

<http://www.404manual.com>

<http://www.luxmanual.com>

<http://aubethermostatmanual.com>

Golf course search by state

<http://golfingnear.com>

Email search by domain

<http://emailbydomain.com>

Auto manuals search

<http://auto.somanuals.com>

TV manuals search

<http://tv.somanuals.com>