

Head Mounted Display

Reference Guide

Before Initial Use

Refer to the “Startup Guide” for instructions on connecting the system, wearing the unit, and completing initial settings.

Warning

To reduce the risk of fire or electric shock, do not expose this apparatus to rain or moisture.

To reduce the risk of fire, do not cover the ventilation opening of the appliance with newspapers, tablecloths, curtains, etc.

Do not expose the appliance to naked flame sources (for example, lighted candles).

To reduce the risk of fire or electric shock, do not expose this appliance to dripping or splashing, and do not place objects filled with liquids, such as vases, on the appliance.

Install this system so that the power cord (mains lead) can be unplugged from the wall outlet (mains) immediately in the event of trouble.

Do not install this equipment in a confined space such as a bookshelf or similar unit.

Precautions

The set is not disconnected from the AC power source (mains) as long as it is connected to the wall outlet (mains), even if the set itself has been turned off.

Notice for customers in the U.S.A. and Canada

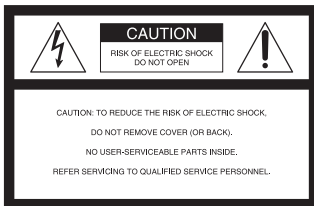

This symbol is intended to alert the user to the presence of uninsulated “dangerous voltage” within the product’s enclosure that may be of sufficient magnitude to constitute a risk of electric shock to persons.



This symbol is intended to alert the user to the presence of important operating and maintenance (servicing) instructions in the literature accompanying the appliance.

Notice for customers in the U.S.A.

Owner’s Record

The model and serial numbers are located at the back of the processor unit and right inside of the head mounted unit.

Record the serial number in the space provided below. Refer to them whenever you call upon your Sony dealer regarding this product.

Model No. HMZ-T2

Processor Unit HMZ-T2P

Head Mounted Unit HMZ-T2H

Serial No. _____

Important Safety Instructions

- 1) Read these instructions.
- 2) Keep these instructions.
- 3) Heed all warnings.
- 4) Follow all instructions.
- 5) Do not use this apparatus near water.
- 6) Clean only with dry cloth.
- 7) Do not block any ventilation openings. Install in accordance with the manufacturer’s instructions.
- 8) Do not install near any heat sources such as radiators, heat registers, stoves, or other apparatus (including amplifiers) that produce heat.
- 9) Do not defeat the safety purpose of the polarized or grounding-type plug. A polarized plug has two blades with one wider than the other. A grounding type plug has two blades and a third grounding prong. The wide blade or the third prong are provided for your safety. If the provided plug does not fit into your outlet, consult an electrician for replacement of the obsolete outlet.
- 10) Protect the power cord (mains lead) from being walked on or pinched particularly at plugs, convenience receptacles, and the point where they exit from the apparatus.
- 11) Only use attachments/accessories specified by the manufacturer.
- 12) Use only with the cart, stand, tripod, bracket, or table specified by the manufacturer, or sold with the apparatus. When a cart is used, use caution when moving the cart/ apparatus combination to avoid injury from tip-over. 
- 13) Unplug this apparatus during lightning storms or when unused for long periods of time.
- 14) Refer all servicing to qualified service personnel. Servicing is required when the apparatus has been damaged in any way, such as power-supply cord or plug is damaged, liquid has been spilled or

objects have fallen into the apparatus, the apparatus has been exposed to rain or moisture, does not operate normally, or has been dropped.

The following FCC statement applies only to the version of this model manufactured for sale in the U.S.A. Other versions may not comply with FCC technical regulations.

NOTE:

This equipment has been tested and found to comply with the limits for a Class B digital device, pursuant to Part 15 of the FCC Rules. These limits are designed to provide reasonable protection against harmful interference in a residential installation.

This equipment generates, uses, and can radiate radio frequency energy and, if not installed and used in accordance with the instructions, may cause harmful interference to radio communications.

However, there is no guarantee that interference will not occur in a particular installation. If this equipment does cause harmful interference to radio or television reception, which can be determined by turning the equipment off and on, the user is encouraged to try to correct the interference by one or more of the following measures:

- Reorient or relocate the receiving antenna.
- Increase the separation between the equipment and receiver.
- Connect the equipment into an outlet on a circuit different from that to which the receiver is connected.
- Consult the dealer or an experienced radio/TV technician for help.

If you have any questions about this product, you may call: Sony Customer Information Center 1-800-222-SONY (7669) or <http://www.sony.com/>. The number below is for the FCC related matters only.

Regulatory Information

Declaration of Conformity

Trade Name: SONY
Model No.: HMZ-T2
Responsible Party: Sony Electronics Inc.
Address: 16530 Via Esprillo, San Diego, CA 92127 U.S.A.
Telephone No.: 858-942-2230



This device complies with Part 15 of the FCC Rules. Operation is subject to the following two conditions.: (1)This device may not cause harmful interference, and (2)this device must accept any interference received, including interference that may cause undesired operation.

You are cautioned that any changes or modifications not expressly approved in this manual could void your authority to operate this equipment.

Notice for customers in Canada

THIS CLASS B DIGITAL APPARATUS COMPLIES WITH CANADIAN ICES-003.

Notice for customers in the United Kingdom

A molded plug complying with BS1363 is fitted to this equipment for your safety and convenience. Should the fuse in the plug supplied need to be replaced, a fuse of the same rating as the supplied one and approved by ASTA or BSI to BS1362, (i.e., marked with  or  mark) must be used.

If the plug supplied with this equipment has a detachable fuse cover, be sure to attach the fuse cover after you change the fuse. Never use the plug without the fuse cover. If you should lose the fuse cover, please contact your nearest Sony service station.

Notice for customers: the following information is only applicable to equipment sold in countries applying EU directives.

This product has been manufactured by or on behalf of Sony Corporation, 1-7-1 Konan Minato-ku Tokyo, 108-0075 Japan. Inquiries related to product compliance based on European Union legislation shall be addressed to the authorized representative, Sony Deutschland GmbH, Hedelfinger Strasse 61, 70327 Stuttgart, Germany.

For any service or guarantee matters, please refer to the addresses provided in the separate service or guarantee documents.

This equipment has been tested and found to comply with the limits set out in the EMC Directive using a connection cable shorter than 3 meters.



Disposal of Old Electrical & Electronic Equipment (Applicable in the European Union and other European countries with separate collection systems)

This symbol on the product or on its packaging indicates that this product shall not be treated as household waste. Instead it shall be handed over to the applicable collection point for the recycling of electrical and electronic equipment. By ensuring this product is disposed of correctly, you will help prevent potential negative consequences for the environment and human health, which could otherwise be caused by inappropriate waste handling of this product. The recycling of materials will help to conserve natural resources. For more detailed information about recycling of this product, please contact your local Civic Office, your household waste disposal service or the shop where you purchased the product.

Health Precautions

Age Limitations

Watching video images or playing games by this device may affect the health of growing children. This device should not be used by children 15 and under.

Use password protection feature (page 26) of this device to restrict children from using this device.

Watching Video with the Head Mounted Display

- Some people may experience discomfort (such as eye strain, fatigue, nausea, or motion sickness) while watching video images or playing games. Sony recommends that all viewers take regular breaks while watching video images or playing games. The length and frequency of necessary breaks will vary from person to person. You must decide what works best. If you experience any discomfort, you should stop watching the video images or playing games until the discomfort ends; consult a doctor if you believe necessary.
- Avoid wearing the unit in environments where your head may shake, or while you are walking or performing exercise, because there is a higher possibility that you experience discomfort.
- You should also review (i) the instruction manual of any other device or media used with this device and (ii) our website below for the latest information.

For customers in Europe, Russia, Ukraine and UK:

<http://support.sony-europe.com/>

For customers in the U.S.A. and Latin America:

<http://esupport.sony.com/>

For customers in Canada:

<http://esupport.sony.com/CA/>

For customers in China:

<http://service.sony.com.cn/index.htm>

For customers in other countries/regions:

<http://www.sony-asia.com/support/>

Correct Use

- Ensure that you are wearing the head mounted unit correctly.
 - For instructions on wearing the unit, refer to the “Startup Guide.”
 - To avoid watching with the screens skewed, check screen alignment by referring to the confirmation screen displayed initially.
 - Note that dropping the unit or handling it roughly may skew the screens.
- The head mounted unit can be adjusted in a range of 55 mm – 72 mm (2 1/4 in. – 2 7/8 in.) to suit the distance between your eyes (interpupillary distance). If you cannot use the system within this range, refrain from using the system.
- By default, a warning message for automatic shutdown will be displayed after three hours of continuous viewing. If you clear the message and continue watching, the system will automatically turn off after another 3 hours.

For Comfortable Viewing

Images are perceived as appearing some distance from the viewer.

If you normally wear glasses or contact lenses, wear them as usual during use (with the exception of reading glasses). Note that watching with bifocals may be less than optimal.

Precautions

Power Supply

Position the system near the wall outlet (mains) used. In case of strange noises, fumes, or smoke from the system, immediately unplug the AC power cord (mains lead) to turn all power off. Only pressing the power button on the head mounted unit will not turn the system off completely.

Installation Environment

Avoid installation in the following environments.

- Places subject to vibration
- In direct sunlight, or where it is very hot or humid
- Places that are extremely cold

Also avoid putting liquid-filled containers (such as flower vases) on top of the processor unit, or using the system where it may be splashed. The system may be damaged if splashed with water.

Condensation

Condensation occurs when moisture in the air condenses on metal panels or other parts, forming droplets. Condensation may form on outer surfaces or internally if the system is suddenly moved from a cold to a warm environment, or when a heater is turned on in a cold room where the system is installed. If condensation forms, do not use the system until the droplets evaporate.

- If the system is not plugged into a wall outlet (mains)
 - Leave the system unplugged, and wait until the droplets evaporate.
- If the system is not on
 - Leave the system off, and wait until the droplets evaporate.
- If the system is on
 - Leave the system on, and wait until the droplets evaporate.

Using the system when condensation has formed may damage it.

Lens Care

- Handle the lenses on the head mounted unit carefully to avoid smears or scratches. If the lenses become dirty, wipe them gently with a soft lens-cleaning cloth.
- Do not use liquid solutions, such as lens-cleaning fluid, water, or alcohol-based cleaners.

Cleaning the System

Clean outer surfaces of the system using a soft cloth lightly moistened with a mild detergent. Do not use solvents, such as thinner, benzene, or alcohol, which may damage surfaces.

Headphone Care

- A dirty headphone plug may cause static or skipping. To ensure optimal sound, clean the plug with a soft cloth occasionally.
- Also clean the earbuds. Remove the earbuds from the headphones and hand-wash them using a mild detergent. After washing, dry the earbuds thoroughly before use.

Extended Listening at High Volume

Listening at high volume over extended periods may harm hearing. To protect your hearing, avoid listening at excessive volume.

Initial Volume

To avoid sudden loud output, keep the initial volume low. Increase the volume gradually until the desired level is reached.

Packaging Materials

Keep the original box and protective cushioning for future use, in case you move or need to ship the system for repair or other reasons.

HDMI Jacks and Connectors

Take these precautions to avoid damaging HDMI jacks and connectors.

- When inserting cables, note the shape and orientation of the connector and the HDMI jack on the back of the processor unit.

HDMI input and output

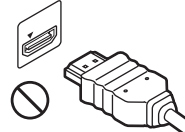

The connector is upside-down

HDMI input and output

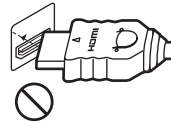

The connector is not straight

- Before moving the processor unit, always disconnect the HDMI cable.



- When connecting or disconnecting HDMI cables, hold the connector straight. Do not hold the connector at an angle or force it into the HDMI jack.
- Use either the supplied HDMI cable or a commercially available High-Speed HDMI cable.

Head Mounted Unit Cord Handling

Take these precautions to avoid damaging the HMD OUT jack or cord connector.

- When inserting the connecting cord, note the shape and orientation of the connector and the HMD OUT jack on the front of the processor unit.
- Before moving the processor unit, always disconnect the connecting cord.
- When connecting or disconnecting the connecting cord, hold the connector straight. Do not hold the connector at an angle or force it into the HMD OUT jack.

Headphone Handling

- If you experience an allergic reaction to the supplied headphones, stop using them at once and contact a doctor.
- When you unplug the headphones from the head mounted unit, make sure to hold the headphone plug to unplug it. Pulling by the headphone cord itself may damage it.
- Earbuds may deteriorate after extended use or storage.

Contents

Health Precautions	4
Precautions	5
Product Highlights	9
Supplied Accessories	9
Parts and Controls	11
Fitting the Head Mounted Unit	13
Confirming Screen Alignment	17
System Settings	19
Troubleshooting	29
Specifications	36
License and Trademark Notice.	37

Product Highlights

Wearing the head mounted display, you can watch 3D movies and play 3D games from connected Blu-ray Disc™ player and game consoles.

Product highlights are as follows.

- Enjoy video with impact, simulating the big-screen cinematic experience through a wide 45° horizontal field of view.
- Watch high-contrast, high-definition video produced by Sony HD OLED (Organic Light-Emitting Diode) panels in the head mounted unit.
- Connect the system to 3D-compatible equipment for a realistic 3D viewing experience. Simultaneous display on both OLED screens eliminates the cross-talk (double images) that older systems with alternating images are susceptible to.
- Hear immersive multi-channel virtual surround-sound with depth, produced by the headphones and Virtualphones Technology (VPT).
- Enjoy more immersive gameplay with accurate sound localization by listening in Game mode, which produces a soundstage specifically designed for games with multi-channel surround-sound effects. Game mode soundstage design for this system was supervised by sound designers at Sony Computer Entertainment.

Supplied Accessories

Make sure the following items are included with the system after purchase. If any items are missing, contact your Sony dealer or a local authorized Sony service center.

- AC power cord (mains lead) (1)
Use the supplied AC power cord (mains lead) only with this system, not with other electronics.
- HDMI cable (1)

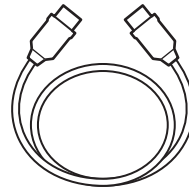

- Light blocker (Top) (1 each for the left and right)

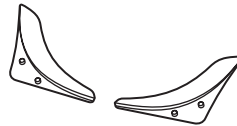

- Light blocker (Bottom) (1)

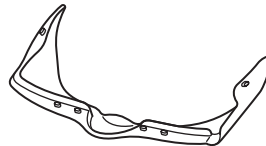

- Connecting cord holder (1)



- Forehead supporter cover (1)

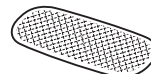

- Headphones (1)

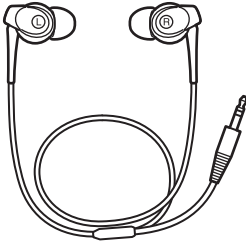

- Earbuds (Size S, L) (1 pair for each size)
Medium-sized earbuds are initially attached, at the time of purchase.
- Reference Guide (this guide)
- Startup Guide

Parts and Controls

Head Mounted Unit

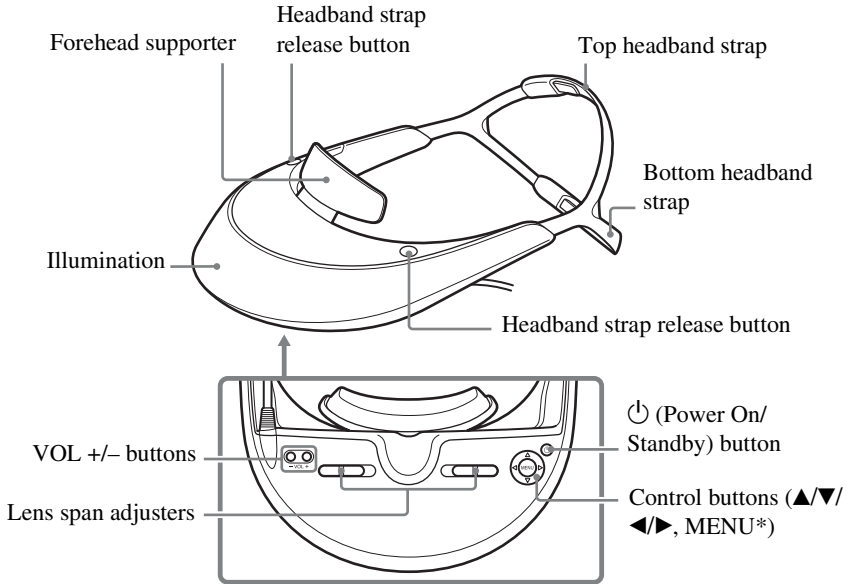

* The MENU button serves two purposes.
Press the MENU button to view setting menus as well as to confirm setting changes (when it functions as an Enter button).

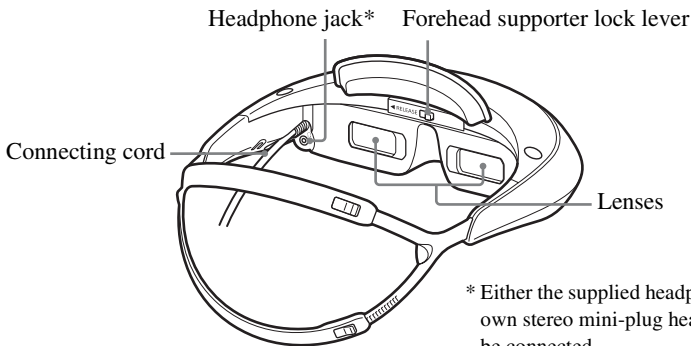

Processor Unit (Front)

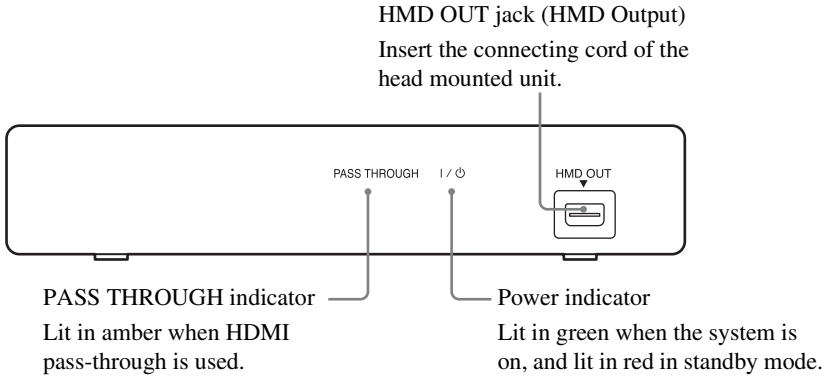

Processor Unit (Back)

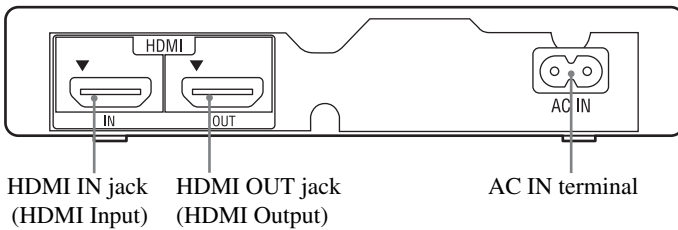

Note

- Source signals cannot be passed through the HDMI OUT jack until the HDMI pass-through is enabled (page 26) and the Head Mount system is turned off.

Fitting the Head Mounted Unit

The head mounted unit can be adjusted in several ways to ensure a personalized, comfortable fit. For a more comfortable fit, always adjust the head mounted unit before putting it on.

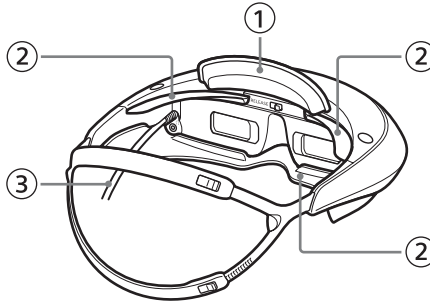

① Adjusting the forehead supporter

The forehead supporter can be adjusted back and forth in a range of four positions to change the point of contact with your forehead. Adjust the forehead supporter for a good fit accounting for sharp image focus, no contact with your nose, ample space between your glasses and the unit, and so on.

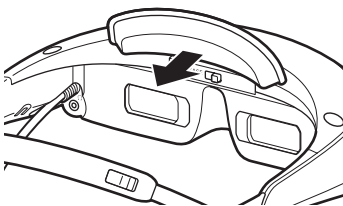

To move the forehead supporter backward, simply pull the supporter toward the back.

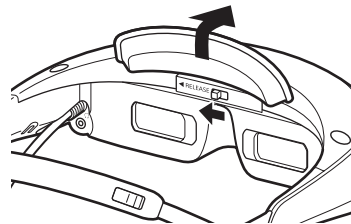

To move the forehead supporter forward, as you hold the forehead supporter lock lever toward the left, push the supporter forward, keeping the supporter lifted up.

Attach the forehead supporter cover as desired.



Attach the included cover to the forehead supporter.

Note

- Make sure the forehead supporter fits securely, so that it stays in contact with your forehead during viewing. If the unit detects that the forehead supporter is not against your forehead during viewing, the screens will automatically turn off.

② Light blocker

If external light reflected on the screens is distracting, attach the light blockers.

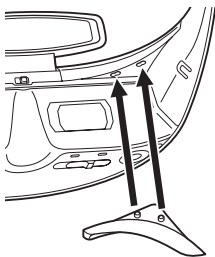

Light blocker (Top)

The upper-left light blocker is labeled "L," and the upper-right one, "R." Attach the correct top light blocker on each side by pushing the tabs into the two holes on the top of the lens section.

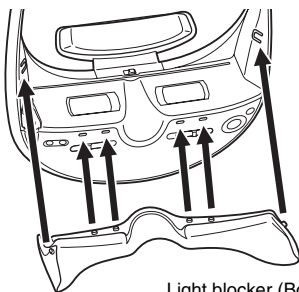

Light blocker (Bottom)

Attach the bottom light blocker by pushing the tabs into the four holes on the bottom of the lens section and the two holes on the side before wearing the unit.

Notes

- It may not be possible to attach the light blockers when wearing some sorts of glasses.
- If external light is still distracting with the light blockers on, dim the room lights or move away from external light.

③ Attaching the connecting cord holder

To keep the connecting cord of the head mounted unit out of the way, use the supplied connecting cord holder and attach the connecting cord to the lower headband strap.

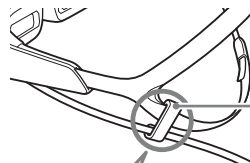

Connecting cord holder



Hook for bottom headband strap

Hook for connecting cord

For a Comfortable Fit

Have the weight of the head mounted unit balanced between your forehead and the back of your head

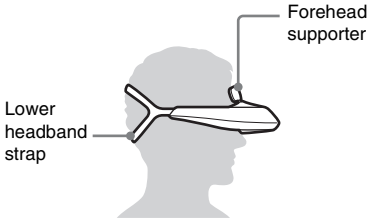

Wear the head mounted unit so that it feels balanced between the forehead supporter and lower headband strap, and after repositioning it to bring the lenses in front of your eyes, make sure it fits securely. Be sure to leave a space between the bridge of the head mounted unit (between the lenses) and your face, so that the unit does not touch your nose.

Ensure a secure fit

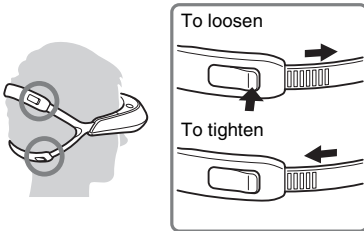

If either headband strap is too loose or too tight, adjust the strap length for a better fit. To loosen, hold down the fastener button as you pull the right end of the strap out a little. To tighten, push the right end of the strap in a little.

Note

- When loosening the straps, make sure that you can still see the guide lines on the straps. If a guide line is no longer visible, the strap may come out of the fastener.

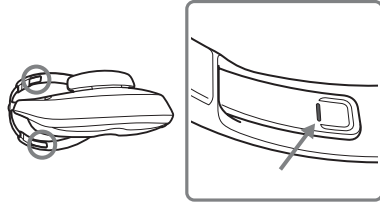

Attaching and Replacing Earbuds

Bass may be inaudible unless earbuds fit well. For a better listening experience, try a different earbud size or adjust the position of the earbuds, so that they fit perfectly in your ears.

Medium-sized earbuds are initially attached to the headphones, at the time of purchase. If the earbuds feel uncomfortable, try replacing them with the supplied large or small earbuds. Earbud sizes are color-coded and can be identified by the color inside. To avoid having the earbuds come off in your ear, be sure to attach earbuds securely to the headphones when replacing them.

Earbud sizes (inside color)

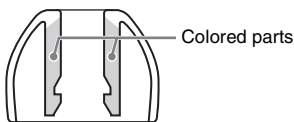

Small



Large

S (Orange)	M (Green)	L (Light blue)
---------------	--------------	-------------------

To detach an earbud

While holding the headphone securely, twist the earbud as you pull it off.

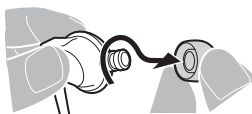

Tip

- If the earbud slips in your fingers and remains attached, try holding it with a dry cloth for a better grip.

To attach an earbud

Twist the earbud as you push the colored inner part over the headphone stem, until the stem is fully covered.

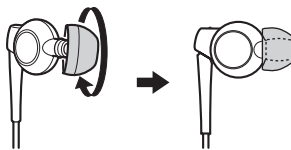

Replacing Consumables

The following replacement parts are available.

- Earbuds*
- Forehead supporter cover
- Light blocker (Top) (1 each for the left and right)
- Light blocker (Bottom)
- Connecting cord holder

When these consumables break or show signs of wear, consult your nearest Sony dealer or Sony service center.

* Purchase small, medium, or large earbuds as needed.

Confirming Screen Alignment

Confirm screen alignment by referring to the confirmation screen displayed initially after lens span adjustment. Screens on the head mounted unit are described below, with an explanation of how to confirm alignment.

The display section of the head mounted unit consists of two small screens, on the left and right. Images on each screen overlap to form a single image.

Always check screen alignment by referring to the confirmation screen before use to make sure the screens are aligned properly.

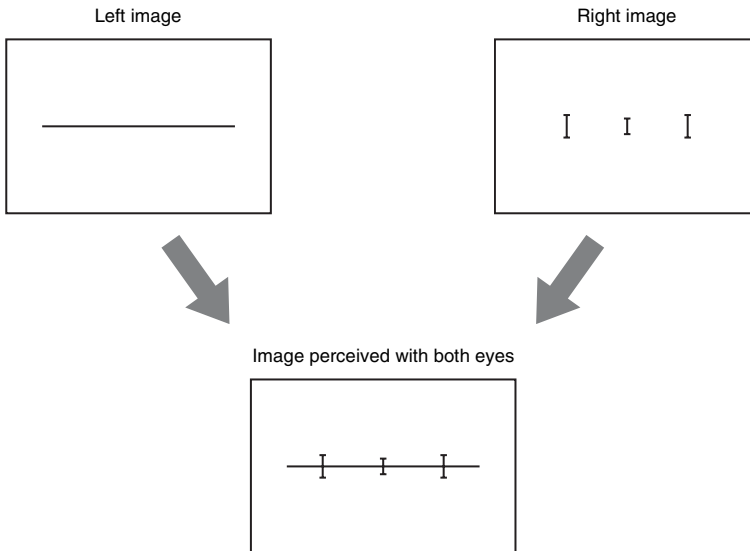

Correct Display

For correct display, slide the lens span adjusters as needed so that all three “I” marks and the horizontal line intersect.

It is acceptable if the “I” marks and the horizontal line intersect in a position other than the center of the screen.

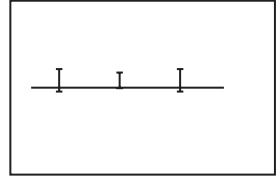
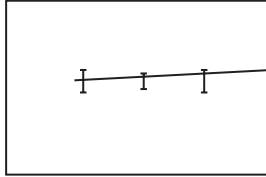
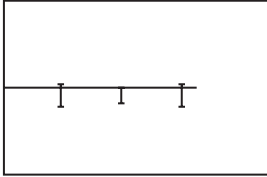

Incorrect Display

If even one of the “I” marks and the horizontal line do not intersect, the head mounted unit may have been bent out of shape, or it may be damaged. If this condition occurs, contact your nearest Sony dealer or local authorized Sony service center.

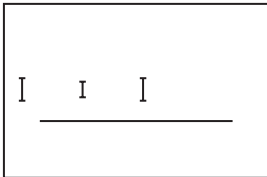

“I” marks and the horizontal line do not intersect.

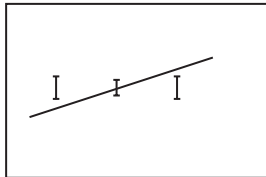

The horizontal line appears to be extremely slanted.

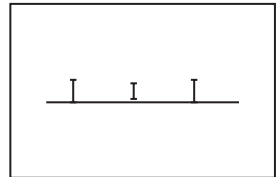

The middle “I” mark does not intersect the horizontal line.

System Settings

Setting menus can be accessed at any time to change or adjust a variety of system settings, such as video picture quality, audio output format, and 3D display format. To view the menus, press the MENU button on the head mounted unit.

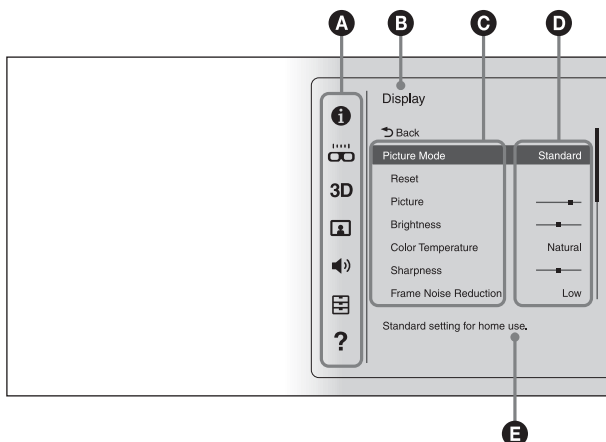

Basic Menu Operations

- 1 Press the MENU button on the head mounted unit.
- 2 Press the ▲/▼ button to select the desired setting category icon, and then press the MENU button.
- 3 Press the ▲/▼ button to select the desired menu, and then press the MENU button.
- 4 Press the ▲/▼/◀/▶ buttons to change or adjust settings as needed, and then press the MENU button to enter your changes.

- A Setting category icons
- B Category
- C Setting menu
- D Current settings in each menu
- E Summary of the selected menu

Note

- After 90 seconds of inactivity, the setting menu will automatically close.

Tips

- To return to the previous menu, press the ◀ button.
- To exit the setting menu, press the ◀ button in the setting category icon menu.

Menus

Default settings are underlined>.

i Information

Identifies input signals (video and audio signals) from the equipment connected to the processor unit. “Unsupported signal” indicates that the input signal is incompatible with the system, and “No signal” is shown when no signals are input.

Lens span adjustment

Back	Returns to the previous menu.
Lens span adjustment	<p>Adjusts the lens span of the head mounted unit to match the distance between your eyes (interpupillary distance), for an optimal viewing experience. Use the lens span adjusters on the head mounted unit for adjustment. For details, refer to the “Startup Guide.”</p> <p>Notes</p> <ul style="list-style-type: none">• Without the lens span adjusted correctly, you cannot enjoy an optimal viewing experience. Always adjust the lens span before use.• Audio is muted during adjustment.• The volume cannot be changed during adjustment.

3D 3D Settings

Back	Returns to the previous menu.
Reset	Resets all “3D Settings” items to the original default values.

3D Display

Manually select the display format for 3D content. Available settings vary depending on whether the source signal includes a 3D format identification signal, as follows.

Example of 3D display

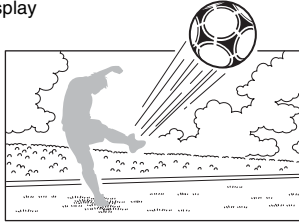

For 3D content without a 3D format identification signal

Side-by-Side: Select for side-by-side 3D content, with similar images displayed side by side.

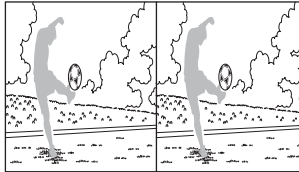

Off: Select to display content in 2D format.

Over-Under: Select for top-and-bottom 3D content, with similar images displayed on top and bottom.

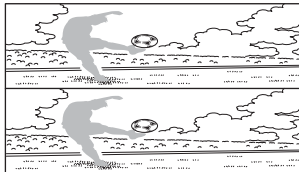

For 3D content with a 3D format identification signal

On: Select to display content in 3D format.

Off: Select to display content in 2D format.

Notes

- If 3D content is not displayed correctly using the selected settings, try changing “Side-by-Side” to “Over-Under” or vice-versa.
- When selecting “Side-by-Side” or “Over-Under,” change the setting to “Off” after viewing 3D content.

Auto 3D	<p>On: Automatically switches to 3D display mode when a 3D format identification signal is detected. If the 3D format identification signal is no longer detected, the system will automatically switch to 2D display mode.</p> <p>Off: Deactivates this function.</p> <p>Note</p> <ul style="list-style-type: none"> • If images do not appear in 3D when “Auto 3D” is set to “On,” try changing the “3D Display” setting.
3D Signal Notification	<p>On: Notifies you when a 3D format identification signal is detected.</p> <p>Off: Deactivates this function.</p>

Display

Back	Returns to the previous menu.
Picture Mode Details of the “Picture Mode” option you choose here can be adjusted in the settings from “Reset” to “Contrast Remaster” below.	<p>Vivid: Vivid colors and sharp contrast, for concerts, sports, and other televised content.</p> <p>Standard: Emphasizes a natural picture. Standard picture quality for a variety of video sources.</p> <p>Cinema: Picture quality designed especially for cinematic content.</p> <p>Game: Picture quality designed for games.</p> <p>Custom: Stores your customized preferred picture quality, adjusting from original flat picture.</p>
Reset	Restores all the values (except for values of “24p True Cinema,” “Wide Mode,” and “Overscan” in “Display”) of the selected mode in the “Picture Mode” menu to the default settings when selecting “Yes.”
Picture	Adjusts image contrast.
Brightness	Adjusts the brightness of the image.
Color Temperature	Adjusts image color temperature. <p>Natural: Automatically optimizes color temperature for each “Picture Mode,” based on characteristics of human vision.</p> <p>Cool: Cool blue color tones.</p> <p>Medium: Color tones between “Cool” and “Warm 1/Warm 2.”</p> <p>Warm 1/Warm 2: Warm red color tones. “Warm 2” is redder than “Warm 1.”</p>
Sharpness	Enhances image edges to make images stand out, or smooths edges for a softer effect.

<p>Frame Noise Reduction</p> <p>Not available with 1080/24p frame packing format.</p>	<p>Reduces random image noise, similar to static. High/Medium/Low: Select the level of this effect. Off: Deactivates this function.</p>
<p>Block Noise Reduction</p> <p>Not available with 1080/24p frame packing format.</p>	<p>Reduces mosaic-like block noise in the image. High/Medium/Low: Select the level of this effect. Off: Deactivates this function.</p>
<p>Mosquito Noise Reduction</p> <p>Not available with 1080/24p frame packing format.</p>	<p>Reduces faint “mosquito” noise around image edges. High/Medium/Low: Select the level of this effect. Off: Deactivates this function.</p>
<p>Panel Drive Mode</p>	<p>Select the type of display method for image motion. Normal: Standard image appearance. Clear: Reduces blurring of fast-moving images.</p> <p>Notes</p> <ul style="list-style-type: none"> • Although selecting “Clear” reduces blurring of fast-moving images, it also darkens the screen as a whole. If this is distracting, select “Normal.” • The screen as a whole may appear to flicker, depending on the source signal. If this is distracting, select “Normal.”
<p>Cinema Conversion</p> <p>Available only when “Picture Mode” is set to “Cinema” or “Custom.” Not available with 1080/24p frame packing format.</p>	<p>Auto: The system automatically detects whether you are watching video content (such as TV dramas and animation) or film content (movies) and switches to the corresponding conversion method. Video: The system always displays in a format for video content, whether playing video or film content.</p>
<p>Clear Black</p>	<p>Adjusts the appearance of dark image areas. Beautiful black reproduction, without a loss of overall shading.</p>
<p>Contrast Remaster</p>	<p>Automatically optimizes black and white levels, for good contrast without faded blacks or whites. High/Medium/Low: Select the level of this effect. Off: Deactivates this function.</p>

<p>24p True Cinema</p>	<p>On: Displays 24 fps video faithfully at 24 fps. Cinematic content of this kind is available on Blu-ray disc. Provides a viewing experience similar to that in theaters.</p> <p>Off: Deactivates this function. 24 fps video signals are displayed after upconversion to 60 fps.</p> <p>Note</p> <ul style="list-style-type: none"> • Activating this function when “Panel Drive Mode” is set to “Clear” may make the screen appear to flicker (depending on the source signal), which may be distracting. In this case, either deactivate this function or set “Panel Drive Mode” to “Normal.”
<p>Wide Mode Not available during 3D playback.</p>	<p>Normal: Displays the images at the original 4:3 aspect ratio.</p> <p>Full: Displays 4:3 content in full-screen, stretching the images horizontally. 16:9 content is also displayed full-screen, at the original aspect ratio.</p> <p>Zoom: Enlarges the images vertically and horizontally, preserving the original aspect ratio.</p> <p>Note</p> <ul style="list-style-type: none"> • “Normal” is not available with HD input sources (1080i, 720p, or 1080p).
<p>Overscan Not available during 3D playback.</p>	<p>Adjusts the display area.</p> <p>Auto: Automatically adjusts the picture to the optimal display area.</p> <p>On: Hides image edges. Select in case of issues such as noise at images edges.</p> <p>Off: Displays the entire image.</p>

Sound

Back	Returns to the previous menu.
Reset	Resets all “Sound” settings to the original default values.
Surround	<p>Standard: Standard acoustic setting, providing a spacious soundstage for a range of content.</p> <p>Cinema: Emphasizes a natural soundstage rivaling the impressive acoustics of movie theaters, especially for spoken dialog. Immersive, with each channel blended naturally. A good choice for movies.</p> <p>Game: Ideal for games. Provides pinpoint sound localization, for a clear sense of where sounds originate. For immersive gameplay in games with multi-channel surround-sound effects. Especially suitable for games that have a multi-channel soundtrack.</p> <p>Music: Emphasizes detail and purity of source audio. Faithful reproduction, similar to monitor equipment at recording studios. A good choice for music.</p> <p>Off: Deactivates surround-sound effects.</p> <p>Note</p> <ul style="list-style-type: none"> • Volume may vary depending on the source audio signal and selected surround-sound mode.
Treble	Adjusts high-frequency audio output.
Bass	Adjusts low-frequency audio output.
Harmonics Equalizer Not available with source signals other than Dolby Digital or AAC audio.	<p>On: Retrieves the tail shape of the waveform which would likely be omitted by audio compression algorithms due to its low amplitude.</p> <p>Off: Deactivates this function.</p>
A/V SYNC	<p>Corrects out-of-sync audio and video signals by delaying audio output. Audio output can be delayed in 10-millisecond increments, in a range of 0-100 ms.</p> <p>Note</p> <ul style="list-style-type: none"> • Some out-of-sync audio and video cannot be corrected with this function, depending on the source signal.

<p>Type of Headphones</p>	<p>Switches to the optimal virtual surround-sound setting for the type of headphones used.</p> <p>Inner Ear: Ideal for headphones worn in your ears, such as the supplied headphones.</p> <p>Overhead: Ideal for headphones worn over or on your ears.</p> <p>Note</p> <ul style="list-style-type: none"> • Surround-sound effects may not be produced correctly unless this setting matches the type of headphones used.
<p>Dual Mono</p> <p>Not available with source signals other than Dolby Digital or AAC dual mono audio.</p>	<p>Switches Dolby Digital or AAC dual mono audio source signals to main or sub audio output.</p> <p>Main: Both left and right headphone output consists solely of the main audio content.</p> <p>Sub: Both left and right headphone output consists solely of the sub audio content.</p> <p>Main/Sub: Headphone output on one side consists of the main audio content. Output on the other side consists of the sub audio content.</p>

General Setup

<p>Back</p>	<p>Returns to the previous menu.</p>
<p>Set password</p> <p>The name of this setting item changes to “Cancel password” after your password is entered.</p>	<p>A password can be set to restrict use of the system. Once a password is specified, it must be entered each time the system is turned on.</p> <p>To cancel password protection, select “Cancel password” and enter the password.</p> <p>Note</p> <ul style="list-style-type: none"> • The system automatically turns off in the following situations. Either turn the system on and enter the password again or cancel password protection. <ul style="list-style-type: none"> – When the password is entered incorrectly, and you close the displayed setting menu by using the MENU or ◀ button – After 90 seconds of inactivity on the password input screen
<p>LPCM Multi-Ch. Mode</p>	<p>On: Enables reception of multi-channel LPCM source signals by the processor unit.</p> <p>Off: Deactivates this function.</p>
<p>HDMI pass-through</p>	<p>On: Activates pass-through, enabling you to watch or listen to content on a TV or other display device when the system is in standby mode. For details, refer to the “Startup Guide.”</p> <p>Off: Deactivates this function. To save power, select “Off” when a TV or other display device is not connected to the processor unit.</p>

<p>Control for HDMI</p>	<p>On: Activates control for HDMI CEC (Consumer Electronic Control)-compatible equipment connected to the processor unit using the ▲/▼/◀/▶ buttons on the head mounted unit.</p> <p>▲ button: Starts playback.</p> <p>▼ button: Pauses playback.</p> <p>◀ button: Jumps to the previous chapter. Hold the button down for fast-rewind.</p> <p>▶ button: Jumps to the next chapter. Hold the button down for fast-forward.</p> <p>Off: Deactivates this function. Use the remote control of the connected equipment to control it.</p> <p>Note</p> <ul style="list-style-type: none"> • If control is not possible with this setting activated, the connected equipment is not compatible with the system’s “Control for HDMI” function. Control connected equipment directly.
<p>Power off when unmounted</p>	<p>On: Turns the system off automatically 30 minutes after you take the head mounted unit off.</p> <p>Off: Deactivates this function.</p> <p>Tip</p> <ul style="list-style-type: none"> • Regardless of this setting, the screens will go off automatically 10 seconds after you remove the head mounted unit.
<p>Illumination</p>	<p>On: Activates the illumination on the head mounted unit.</p> <p>Off: Deactivates this function.</p>
<p>Language setting</p>	<p>Sets the language used for menus and other interface elements.</p> <p>Notes</p> <ul style="list-style-type: none"> • Audio is muted while this setting is configured. • The volume cannot be adjusted while this setting is configured.
<p>Prolonged viewing warning</p>	<p>On: Activates automatic display of a warning about whether to turn the power off after 3 hours of continuous viewing. Selecting “Yes” on the warning screen will turn the power off. Selecting “No” will cause the power to be turned off 3 hours later, after 6 hours of continuous viewing.</p> <p>Off: Deactivates this function.</p> <p>Notes</p> <ul style="list-style-type: none"> • When the warning is displayed after 3 hours of viewing, if no response is made in 90 seconds, the power will automatically be turned off. • A warning screen will be displayed at 30 minutes and 5 minutes before the system will turn itself off.
<p>Startup viewer warning</p>	<p>On: Activates automatic display of a startup warning.</p> <p>Off: Deactivates this function.</p>

Reset to factory settings	Resets all settings to the original default values. Note <ul style="list-style-type: none">• The password set in “Set password” (in “General Setup”) will also be cleared.
----------------------------------	--

? Guide of HDMI device control

Displays the operation guide for head mounted unit buttons that can be used with “Control for HDMI” function (page 27).

Troubleshooting

If the following symptoms occur when using the system, check the Cause/Action column before requesting service. If the issue persists, contact your Sony dealer or local authorized Sony service center.

Power Supply

Symptom	Cause/Action
The system does not turn on	<ul style="list-style-type: none">→ Confirm that the AC power cord (mains lead) is fully plugged in.→ Make sure the head mounted unit connecting cord is fully inserted in the HMD OUT jack.→ Startup normally takes a few seconds.
The system does not go off	<ul style="list-style-type: none">→ Hold down the  (Power On/Standby) button for at least one second.

Video

Symptom	Cause/Action
<p>No video, or output video is distorted</p>	<ul style="list-style-type: none"> → Refer to the “Startup Guide” and confirm that the AC power cord (mains lead), HDMI cable, and connecting cord of the head mounted unit are connected correctly. → Make sure that equipment connected to the HDMI IN jack on the processor unit is on. → Confirm that the source signal is supported by the system. For information on supported signals, see “Supported HDMI input and output signals:” in “Specifications” (page 36). → When the PlayStation®3 (PS3™) is used with this system and if the video and audio output settings on the PS3™ do not match those of this system or the cable and TV in use, there may be no video and audio outputs. If such symptoms occur, turn off the PS3™, and then turn it on again by pressing its power button for at least 5 seconds until you hear a beep sound twice. The video and audio output settings will automatically be reset to the standard settings. → If there is no video output when this system is used with playback equipment other than the PlayStation®3 (PS3™), momentarily stop playback, and then resume playback. If the issue persists, try restarting the playback equipment. → The HDMI cable may be loose. Confirm that the HDMI cable is fully plugged in. If video quality does not improve, the HDMI cable may be damaged. In this case, try a new cable. → When selecting “Side-by-Side” or “Over-Under” in “3D Display” (in “3D Settings”), change the setting to “Off” after viewing 3D content (page 21). → If equipment is connected to the processor unit via an AV amplifier (receiver), try connecting the equipment directly to the processor unit instead. For details, refer to the instruction manual of the equipment used. → When using an HDMI selector, make sure the input on the selector is switched correctly. → Use either the supplied HDMI cable or a commercially available HDMI cable identified as a High-Speed cable. → Make sure to disable video output with the Deep Color signal on the connected equipment. If this option is not available on the equipment and the content is being output at 1080/60p, change the HDMI video output mode to 1080i video mode.
<p>The screen is dark or blurry</p>	<ul style="list-style-type: none"> → Refer to the “Startup Guide” and confirm that the AC power cord (mains lead), HDMI cable, and connecting cord of the head mounted unit are connected correctly, and that you are wearing the head mounted unit correctly. → The lens span may have been adjusted incorrectly (page 18). Perform adjustment again by accessing “Lens span adjustment” in the setting menu (page 20). → If the lenses in the head mounted unit are dirty, wipe them with a soft dry cloth to clean them.

Symptom	Cause/Action
The screens suddenly go off	<ul style="list-style-type: none"> → After 3 hours of continuous viewing, the system will display a warning screen and go off after 90 seconds of inactivity. If you clear the message and continue watching, the system will automatically go off after another 3 hours to encourage healthy viewing habits. For details, see “Prolonged viewing warning” (page 27). → Wear the head mounted unit correctly. 10 seconds after the sensor in the head mounted unit detects that you have removed the unit, the displayed screen will automatically go off. For details, see “Power off when unmounted” (page 27).
Image display dims over time	<ul style="list-style-type: none"> → Although image display of photos or nearly motionless images may dim over time, this does not indicate system damage. To restore normal brightness, perform some operation on the head mounted unit or the connected equipment directly.
Some pixels on the screens are not lit, or some pixels are always lit	<ul style="list-style-type: none"> → Although OLED panels are produced using extremely high-precision manufacturing technologies, in some cases pixels may be permanently black or lit in red, blue, or green. This does not indicate system damage.
Some scenes on a Blu-ray disc recorded at 24 fps (matching the original movie) look unnatural	<ul style="list-style-type: none"> → In this case, try activating “24p True Cinema.” For details, see “24p True Cinema” (page 24).
The screen flickers	<ul style="list-style-type: none"> → Some source signals may cause the screen as a whole to appear to flicker when “Panel Drive Mode” is set to “Clear,” or when “24p True Cinema” is activated. For details, see “Panel Drive Mode” (page 23) and “24p True Cinema” (page 24).

Symptom	Cause/Action
Video is not shown in 3D	<ul style="list-style-type: none"> → If the same image is displayed side by side or on top and bottom, the 3D display format setting may be incorrect. Try changing the “3D Display” setting in “3D Settings” (page 21). → 3D perception varies by viewer. → If the “3D Settings” menu is displayed but images are not shown in 3D, try restarting the connected equipment used for 3D playback. → The system does not support 2D to 3D conversion (simulated 3D). → Viewing anaglyphic images in 3D requires anaglyphic glasses (with red and blue lenses, for example). → Also check the settings of playback equipment connected to the processor unit. → When the PlayStation®3 (PS3™) is used with this system and if the video and audio output settings on the PS3™ do not match those of this system or the cable and TV in use, there may be no 3D video output. If such symptoms occur, turn off the PS3™, and then turn it on again by pressing its power button for at least 5 seconds until you hear a beep sound twice. The video and audio output settings will automatically be reset to the standard settings. → If there is no 3D video output when this system is used with playback equipment other than the PlayStation®3 (PS3™), momentarily stop playback, and then resume playback. If the issue persists, try restarting the playback equipment.
3D display is not activated automatically	<ul style="list-style-type: none"> → Make sure the “Auto 3D” setting in “3D Settings” is set to “On” (page 22). → 3D content without a 3D format identification signal is not automatically displayed in 3D. Try changing the “3D Display” setting in “3D Settings” to “Side-by-Side” or “Over-Under” (page 21).

Audio

Symptom	Cause/Action
<p>There is no sound / There is static / Volume cannot be increased</p>	<ul style="list-style-type: none"> → The headphone plug is not connected properly. If the headphones are connected improperly, the sound from the headphones will be impaired. Insert the headphone plug until it clicks into place (page 11). → The headphone plug is dirty. Clean the headphone plug with a soft dry cloth. → Adjust the volume using the VOL +/- buttons. → Refer to the “Startup Guide” and confirm that the AC power cord (mains lead), HDMI cable, and connecting cord of the head mounted unit are connected correctly. → Confirm that the source signal is supported by the system. For information on supported signals, see “Supported HDMI input and output signals:” in “Specifications” (page 36). If the input signal is unsupported, check the audio output settings of connected equipment. → When the PlayStation®3 (PS3™) is used with this system and if the video and audio output settings on the PS3™ do not match those of this system or the cable and TV in use, there may be no video and audio outputs. If such symptoms occur, turn off the PS3™, and then turn it on again by pressing its power button for at least 5 seconds until you hear a beep sound twice. The video and audio output settings will automatically be reset to the standard settings. → If there is no video output when this system is used with playback equipment other than the PlayStation®3 (PS3™), momentarily stop playback, and then resume playback. If the issue persists, try restarting the playback equipment. → If equipment is connected to the processor unit via an AV amplifier (receiver), try connecting the equipment directly to the processor unit instead. For details, refer to the instruction manual of the equipment used. → When the system is connected to HDMI CEC-compatible home theater systems or AV amplifiers (receivers), check the following settings. <ul style="list-style-type: none"> – Make sure the “Control for HDMI” setting in “General Setup” is set to “On” (page 27). – Make sure “Control for HDMI” is activated on the AV amplifier (receiver) or other equipment. For details, refer to the instruction manual of the equipment used. → For multi-channel LPCM input, make sure the “LPCM Multi-Ch. Mode” setting in “General Setup” is set to “On” (page 26).
<p>There is no surround-sound effect</p>	<ul style="list-style-type: none"> → Make sure the “Surround” setting in “Sound” is not set to “Off” (page 25). → Make sure the “Type of Headphones” setting in “Sound” is correct for the type of headphones in use (page 26). → Sound perception varies by listener.
<p>There is no bass</p>	<ul style="list-style-type: none"> → Make sure that the earbuds fit snugly in your ears (page 16).

Symptom	Cause/Action
There is no audio input in Dolby Digital or AAC format	→ The playback equipment may be configured to convert Dolby Digital or AAC audio output signals to LPCM signals. In this case, in the playback equipment settings, disable Dolby Digital or AAC conversion, and then resume playback. For details, refer to the instruction manual of the equipment used.
Audio playback is not in the right format	→ For dual mono audio, change the “Dual Mono” setting in “Sound” (page 26). For other audio formats, check the settings of connected equipment.

HDMI Control

Symptom	Cause/Action
Connected equipment cannot be controlled using the buttons on the head mounted unit	<ul style="list-style-type: none"> → Make sure the connected equipment supports the HDMI CEC functions. → Make sure “Control for HDMI” setting of the connected equipment is configured correctly. For details, refer to the instruction manual of the equipment used. → The connected AV amplifier (receiver) may not be compatible with the system’s “Control for HDMI” function. “Control for HDMI” function will not work correctly in this case. → Controlling connected equipment by pressing buttons on the head mounted unit may not be possible immediately after turning the system on, or immediately after activating “Control for HDMI” in “General Setup.” → Make sure the “Control for HDMI” setting in “General Setup” is set to “On” (page 27).

Other Issues

Symptom	Cause/Action
The power indicator keeps flashing in red	<ul style="list-style-type: none"> → If the indicator flashes twice every 3 seconds, the head mounted unit or processor unit may be damaged. Contact your Sony dealer or local authorized Sony service center. → If the indicator flashes three times every 3 seconds, the processor unit has overheated. Wait until the unit cools off and flashing stops. Make sure not to cover or obstruct the ventilation openings of the processor unit for proper ventilation. → If the indicator flashes four times every 3 seconds for a minute, the head mounted unit has overheated. Wait until the unit cools off and flashing stops. → If the indicator flashes five times every 3 seconds for a minute, both the head mounted unit and processor unit have overheated. Wait until the units cool off and flashing stops.

Symptom	Cause/Action
When the system is off, video and audio from the playback equipment is not played on a TV connected to the HDMI OUT jack	<ul style="list-style-type: none"> → Confirm that the HDMI cables are fully connected. → Set “HDMI pass-through” in “General Setup” to “On” (page 26). → Switch the input source on the TV to this system. → Check the HDMI output settings on the playback equipment.
“Control for HDMI” on a TV cannot be used to control the playback equipment even when the system’s HDMI pass-through is used	<ul style="list-style-type: none"> → Refer to the instruction manual supplied with your TV, and in the TV’s “Control for HDMI” setting, specify playback equipment connected to the processor unit as the controlling device.
Head mounted unit buttons are unresponsive	<ul style="list-style-type: none"> → Buttons on the head mounted unit do not function unless you are wearing it.
“DEMO” appears in the upper-right corner of the setting menu screen	<ul style="list-style-type: none"> → Contact your Sony dealer or local authorized Sony service center.
Cannot adjust “Language setting” because the setting menu is in an unfamiliar language	<ul style="list-style-type: none"> → If initial setup is not finished, press the ◀ button repeatedly to return to the language selection screen, and then select your preferred language again. → If you have finished initial setup, follow these steps to restore the system to the original, factory settings and specify the correct language. <ol style="list-style-type: none"> 1 Press the MENU button to display the setting menus. 2 Press the ▼ button and select  (the “General Setup” icon). 3 Press the ► button and move the cursor to the right. 4 Press the ▼ button and move the cursor to the bottom setting. 5 Press the MENU button. (A “Reset to factory settings” confirmation message is displayed.) 6 Press the ◀ button, and then press the MENU button. (The system will restart.) 7 After the initial setting screen is displayed, press the ▲/▼ buttons to select your preferred language, and then press the ► button. 8 Follow the instructions displayed to finish initial setup.

Specifications

Power requirement

North American model:

120 V AC, 60 Hz

UK, Hong Kong, European, Middle Eastern, South African, and Oceania models:

220 V – 240 V AC, 50/60 Hz

Russian and Ukrainian models:

220 V – 240 V AC, 50/60 Hz

Taiwan model:

110 V AC, 60 Hz

Chinese model:

220 V – 240 V AC, 50/60 Hz

South Korean model:

220 V AC, 60 Hz

Indian model:

220 V – 240 V AC, 50/60 Hz

Mexican model:

120 V AC, 50/60 Hz

Other models:

110 V – 240 V AC, 50/60 Hz

Power consumption

15 W (in operation)

0.25 W (in standby mode)

1.6 W (in standby mode using HDMI pass-through)

Operating temperature

5 °C to 35 °C (41 °F to 95 °F)

Operating humidity

25 % to 80 %

Dimensions (W×H×D, including largest protrusions)

Head mounted unit:

Approx. 187 mm × 104 mm × 254 mm

(7 3/8 in. × 4 1/8 in. × 10 in.)

Processor unit:

Approx. 180 mm × 36 mm × 168 mm

(7 1/8 in. × 1 7/16 in. × 6 5/8 in.)

Mass

Head mounted unit:

Approx. 330 g (12 oz) (excluding connecting cord)

Processor unit:

Approx. 600 g (22 oz) (excluding AC power cord (mains lead))

Display resolution

1,280 dots (horizontal) × 720 dots (vertical)

Interpupillary distance

55 mm – 72 mm (2 1/4 in. – 2 7/8 in.)

Inputs and outputs

HMD OUT:

Dedicated 15-pin connector

HDMI IN and HDMI OUT*:

HDMI 19-pin standard connector

Supported HDMI input and output signals:

Video input (2D formats):

480/60p, 576/50p, 720/24p, 720/50p, 720/60p, 1080/50i, 1080/60i, 1080/24p, 1080/50p, 1080/60p

Video input (3D: Frame Packing, Side-by-Side and Top-and-Bottom formats):

720/50p, 720/60p, 1080/50i, 1080/60i, 1080/24p

Audio input:

Linear PCM (2/multi-channel, 32/44.1/48 kHz), Dolby Digital (2/multi-channel, 32/44.1/48 kHz), AAC (2/multi-channel, 32/48 kHz)

Headphone jack:

Stereo minijack

* When HDMI pass-through is activated, signals supplied to the processor unit are passed through the processor unit to the HDMI output. However, the following signals are not compatible with pass-through.

- Deep Color signals
- Video signals at 4k resolution (at a high resolution exceeding 3,840 (horizontal) × 2,160 (vertical) pixels)

Headphones (supplied)

Frequency response:

5 Hz - 24,000 Hz

Impedance:

16 Ω (1 kHz)

Supplied accessories

See “Supplied Accessories” (page 9).

System specifications and appearance are subject to change for improvement without notice.

License and Trademark Notice

Trademarks

- The terms HDMI™ and HDMI High-Definition Multimedia Interface, and the HDMI Logo are trademarks or registered trademarks of HDMI Licensing LLC in the United States and other countries.

HDMI

- Manufactured under license from Dolby Laboratories.
Dolby and the double-D symbol are trademarks of Dolby Laboratories.
- “PlayStation” is a registered trademark of Sony Computer Entertainment Inc. Also, “PS3” is a trademark of the same company.
- VPT, Virtualphones Technology is a registered trademark of Sony Corporation.
- Other system and product names are generally trademarks or registered trademarks of the manufacturers. ™ and ® marks are not indicated in this document.

Notices and Licenses for Software Used in this Product

Portions of the software in this product are licensed under the FreeType Project License.

Portions of this software are copyright © 2006 The FreeType Project (www.freetype.org). All rights reserved.

<http://www.sony.net/>

Printed on 70% or more recycled
paper using VOC (Volatile Organic
Compound)-free vegetable oil
based ink.



© 2012 Sony Corporation Printed in Japan

4-439-019-12(1)

Free Manuals Download Website

<http://myh66.com>

<http://usermanuals.us>

<http://www.somanuals.com>

<http://www.4manuals.cc>

<http://www.manual-lib.com>

<http://www.404manual.com>

<http://www.luxmanual.com>

<http://aubethermostatmanual.com>

Golf course search by state

<http://golfingnear.com>

Email search by domain

<http://emailbydomain.com>

Auto manuals search

<http://auto.somanuals.com>

TV manuals search

<http://tv.somanuals.com>