

Preliminary

PROGRESSIVE

HDV

HDV 1080i



HVR-Z7E

HVR-S270E

Digital HD Video Camera Recorder

HVR-M35E

Digital HD Videocassette Recorder

SONY

www.sonybiz.net/hdv



Interchangeable lens system, native progressive recording and solid-state memory recording – Sony's commitment to the HDV world brings a remarkable evolution in next-generation products.

Sony is proud to introduce two new HDV™ camcorders that deliver the enhanced functionality professionals have been waiting for: an interchangeable lens system, native progressive recording and solid-state memory recording.

Introducing the HVR-Z7E, the world's first HDV handheld camcorder that uses 1/3-inch bayonet joint interchangeable lenses and the HVR-S270E shoulder-mount camcorder which supports standard-size cassettes for extended recording times.

A streamlined nonlinear editing workflow can be achieved using the supplied Memory Recording Unit, which provides HDV/DVCAM/DV file recording on a widely available CompactFlash® solid-state memory card.

These groundbreaking new camcorders feature the 1080/25p HDV native progressive recording mode and they also have HDMI or HD/SD-SDI output.

This next-generation system features the HVR-M35E Video Cassette Recorder which has HD/SD-SDI output.

These new solutions enhance the operational versatility of Sony's professional HDV line-up and open up a world of possibilities for high-definition digital video production. Whether it's for general TV production, low-budget movies, music videos, Internet, education, or a wide range of live events and corporate videos, Sony's new HDV camcorders are ideal.

HDV
HDV 1080i

3 ClearVid
CMOS sensor

Exmor™

PROGRESSIVE



■ HVR-Z7E

(with supplied lens)



(with ENG lens*)



(with cinema lens*)





■ HVR-M35E



■ Memory Recording Unit
(supplied with the HVR-Z7E/S270E)

■ HVR-S270E

(with supplied lens)

(with ENG lens*)

(with cinema lens*)



*These lenses, adaptors and matte box sets are not supplied.

New Line-up Expanding the HDV format World

Sony's commitment to HDV has resulted in the remarkable evolution of cutting-edge technology equipment, such as the HVR-Z7E and HVR-S270E which use the popular HDV1080i recording specification.

The HDV1080i specification uses one of the "MPEG2 Long GOP" compression profiles. This highly efficient and robust "MPEG2 Long GOP" codec - which is also used in the Sony XDCAM HD and XDCAM EX series - enables users to record stunning-quality HD video.

The HVR-Z7E provides over 60 minutes*2 of recording time using the widely available miniDV videotape. While the HVR-S270E has the additional option of using standard-size cassettes that provide over 4.5 hours*3 of continuous recording.

*2 When Sony's recommended Professional HDV tape DigitalMaster™ model PHDVM-63DM is used, approx. 63 min. recording time.

*3 When Sony's recommended Professional HDV tape DigitalMaster™ model PHDV-276DM is used, approx. 276 min. (4 hrs. 36 min.) recording time.

HDV

HDV 1080i

Switchable Recording and Playback – HDV1080i/DVCAM/DV

The HVR-Z7E and HVR-S270E can switch between HDV 1080i, DVCAM and DV recording, providing full flexibility to record in either standard definition or high definition depending on your production needs.



Native editing in the HDV format is supported by most of the popular NLE (Nonlinear editing) software manufacturers. Additionally, the HDV signals can be recorded as a file on non-tape media. For example, when using the supplied CompactFlash (CF) Memory Recording Unit, images can be stored on a standard CF card for quick nonlinear editing. The optional HVR-DR60 Hard Disk Recording Unit can be used in the same manner, with images being recorded on to its large-capacity 60GB hard drive, which provides 4.5 hours of recording time.



PHDVM-63DM

PHDV-276DM



Memory Recording Unit (supplied)*
*CF card is not included.

HVR-DR60 (option)

Built-in Down-converter for SD Production

The HVR-Z7E and S270E can convert material from 1080i down to 576i and output the video signals through its i.LINK interface and other SD output connectors. This allows users to edit recorded material with a compatible nonlinear editing system using current DV editing software, as well as record SD signals to an external VTR.

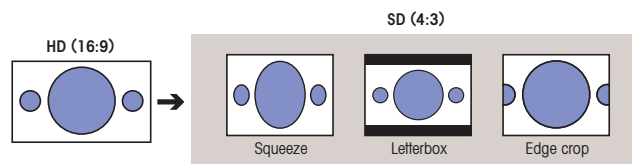

*Letterbox mode is not available from the i.LINK connector. i.Link is a trademark of Sony used only to designate that a product contains an IEEE 1394 connector. Not all products with an i.LINK connector will necessarily communicate with each other. For information on compatibility, operating conditions and proper connection, please refer to the documentation supplied with any device with an i.LINK connector. For information on devices that include an i.LINK connection, please contact your nearest Sony office.

Cutting-edge imaging System for New Camcorders

❖ 1/3 inch-type 3 ClearVid CMOS Sensor system

The newly developed 1/3-inch type 3 ClearVid CMOS Sensor™ system has 45-degree rotated pixels on each chip in order to increase the signal density, while each pixel maintains sufficient surface area.

In combination with Enhanced Imaging Processor™ (EIP), the 3 ClearVid CMOS Sensor system achieves high resolution, high sensitivity, wide dynamic range and excellent colour reproduction.

The pixel shift interpolation technique has been traditionally used in small 3CCD camcorders. However, it normally requires the combination of all three colour element (RGB) signals to maximise resolution. If an object lacks one or more colour elements, the resolution of the object may be degraded.

The 3 ClearVid CMOS Sensor system is different. It can always produce maximum resolution, regardless of the balance between colour elements, thanks to its unique and sophisticated interpolation technology.

3 ClearVid CMOS sensor

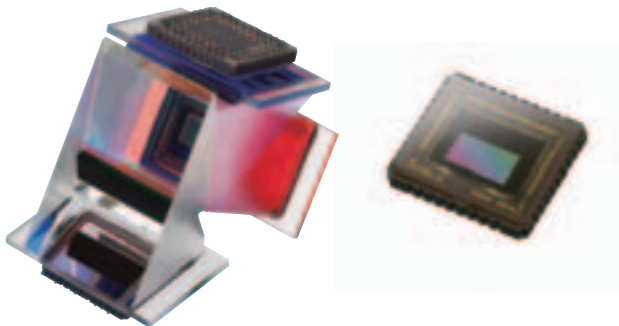

Pixel Layout

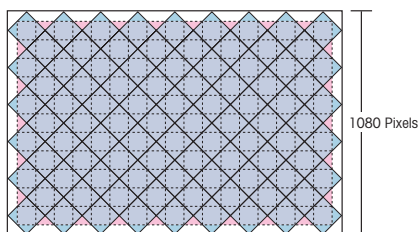

- ◆ Pixels (Photo Diodes)
- ▨ Signals after interpolation

❖ Enhanced Functionality due to “Exmor” Technology

Both the HVR-Z7E and HVR-S270E offer cutting-edge features, such as the “Exmor™” technology developed by Sony, which utilises the full potential of the 3 ClearVid CMOS Sensor system.

The “Exmor” technology, which features the column-parallel A/D conversion technique and the dual noise cancelling method are also used in other new camera products from Sony, such as the PMW-EX1. Multiple A/D (analogue to digital) converters on each pixel row convert analogue signals to digital as soon as they are generated, unlike traditional technology that only has one A/D converter on each chip. The “Exmor” technology can eliminate the influence of external noise that enters the signal chain during transfer to the A/D converter, resulting in high-quality digital signals with extremely low noise. This significantly enhances shooting in low-light environments.

By adopting this groundbreaking technology, the new 1/3-inch 3 ClearVid CMOS Sensor system enables the HVR-Z7E and HVR-S270E to achieve a low light sensitivity of just 1.5 lux*.

* at 1/25 shutter, auto iris and auto gain.

Current Technology

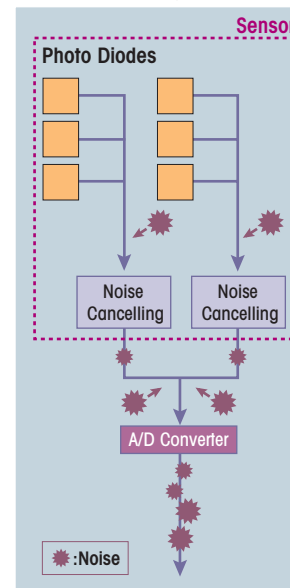

“Exmor” technology

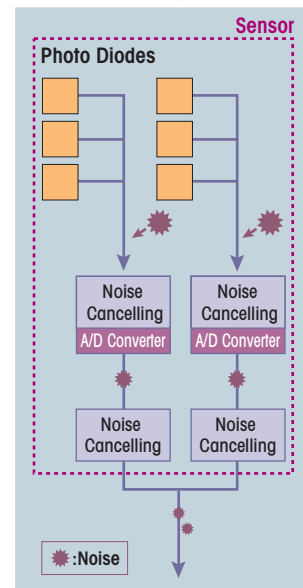

Exmor™

Interchangeable Lens System Offers Unlimited Possibilities

Various video lenses can be attached to the HVR-S270E and HVR-Z7E which are both equipped with a universal standard 1/3-inch bayonet mount mechanism for quick changing of lenses.

✦ Carl Zeiss Lens for HD Video as Standard

A high-quality, multi-purpose Carl Zeiss lens for HD video comes as standard with the HVR-S270E and HVR-Z7E. Stunning resolution and contrast is achieved thanks to the Carl Zeiss Vario-Sonnar™ T* coating, which suppresses unwanted reflections. A specially designed wide-angle lens is also available as an option to suit a diverse range of shooting requirements.

Lens		Optical Zoom	Focal Length*4	F number
Standard lens (supplied)	VCL-412BWH (for HVR-Z7E)	12x	32mm-384mm (16:9)	1.6 - 2.0
	VCL-412BWS (for HVR-S270E)			
Wide lens (option)	VCL-308BWH (for HVR-Z7E)	8x	24mm-192mm (16:9)	1.6 - 2.4
	VCL-308BWS (for HVR-S270E)			

*4 These values are calculated to be equivalent to 35 mm film.



✦ Easy-to-use Interchangeable Lens for Fixed-lens Camcorder Users

These lenses give Sony's two new HDV camcorders the same functionality as popular fixed-lens camcorders like the HVR-Z1E and HVR-V1E, thanks to built-in features such as auto-focus, optical stabiliser, and automatic back-focus adjustment.

Current users of the above camcorders will easily become adept at using the HVR-Z7E and HVR-S270E, even if they have never used interchangeable lenses.

✦ Natural-touch Lens Operation

Focus

The newly designed focus ring offers two types of manual focus, plus an auto focus mode that can be easily switched by sliding the focus ring forward or backward.

When the focus ring is in the front position, the lens works in the same way as the HVR-Z1E, HVR-V1E and DSR-PD170P. In this case, either manual or auto focus mode can be selected by the assignable button on the lens. On the other hand, when the focus ring is set to the rear position, the focus ring has a physical stop at infinity and works in the same way as a professional interchangeable lens, with fixed-focus-position and distance indicators.

Zoom

Fast, intuitive manual-zoom response is provided by an internal gearwheel mechanism that provides accurate zoom positioning. A high-quality servo-motor provides the smooth zooming performance that industry professionals have come to rely on.

Iris

The iris ring encircles the lens barrel. Manual iris adjustment is possible with an ENG-type ring system that allows fine exposure control for challenging lighting situations.



Front : AF/MF



Back : Full MF



AF/MF Mode

- Full AF
- MF with One-push AF

Full MF Mode

- Full MF (absolute focus position)

✦ Wide Range of Lenses

The flexible bayonet lens attachment system allows you to use a wide range of lenses.

Standard 1/3-inch HD video lenses, from manufacturers such as Fujinon and Canon, can be attached directly to the HVR-Z7E and HVR-S270E.

If you'd like to attach a 2/3-inch or 1/2-inch HD video lens on the HVR-Z7E or HVR-S270E, it is possible to do so by adding a standard lens adaptor from the lens manufacturer.

The HVR-S270E and HVR-Z7E camcorders have 12-pin lens connectors allowing compatibility with professional ENG lenses.

This feature is very useful, not only for those who already have these professional HD video lenses, but also for those who prefer to use HD digital cinema lenses for their unique contrast, colour and atmosphere.



Lens adaptor



Cinema lens on HVR-S270E with an adaptor

✦ α Lens Compatibility

With a special adaptor from Sony, it is also possible to use the α lens series designed for Sony Digital SLR stills cameras.

By using α lenses in various configurations, creative effects can be achieved.

This approach is ideal for filmmakers on a budget or those who already own α lenses.

Note:

The focal length is doubled with a 2/3-inch lens adaptor

The focal length is increased 1.3 times with a 1/2-inch lens adaptor

The focal length is increased 7 times with an α lens adaptor

Some lenses may not be compatible and not all lens functions may be available



α lenses

Operational Versatility

✦ New Manual Camera settings

Three ND filters

The HVR-Z7E and HVR-S270E have three built-in ND (Neutral Density) filters, which help users to reduce light intensity under bright shooting conditions.

Negative Gain

Negative gain settings of -6 and -3 dB have also been added to help reduce sensitivity under bright lighting conditions. When the iris needs to be opened to create a short depth of field, a suitable brightness can be achieved with this function.

Smooth Gain

The Smooth Gain function is a smooth transition gain system that avoids sudden brightness changes caused by manual gain-level adjustment. With this function, the brightness changes gradually when the gain-level position is switched and avoids any sudden, unwanted iris adjustment.

Smooth WB (White Balance)

The Smooth WB feature is a smooth transition white balance system that avoids unnatural sudden colour temperature changes between preset white balance settings. For example, this function is useful when you move from an artificial, low-light environment inside a building, to bright natural sunlight outside.



Three ND filters

Shooting Support Functions

Advanced Histogram

The Histogram Indicator for brightness can be displayed on the LCD monitor and viewfinder, allowing operators to easily evaluate the brightness of captured images. A target window appears in the centre of the screen and the brightness level is indicated by a vertical red line in the histogram. The zebra indicator level appears as a yellow vertical line in the histogram as reference for proper exposure.



Focus Marking

When the focus position needs to be manually moved to pre-decided positions, you can put up to two markers (A and B) on a focus position indicator in the LCD/EVF as reference points. When the focus position becomes aligned with one of these markers, it will begin to flash. This allows you to keep your eye on the subject of your shot, without having to check the focus indicator on the lens.



Camera Leveling

The HVR-Z7E and HVR-S270E both have a built-in three-dimensional gravity (3G) sensor, which detects the horizontal level of the camcorder and displays it via an indicator in the LCD/EVF. This digital leveler function makes it possible to obtain a horizontal level reading even when shooting without a tripod.

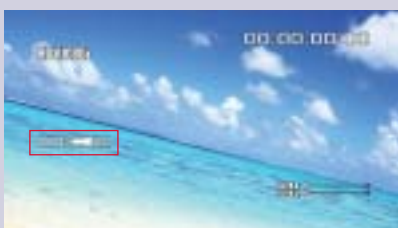

AE Window

Six types of AE (Auto Exposure) can be selected to automatically adjust the exposure to the most suitable level.

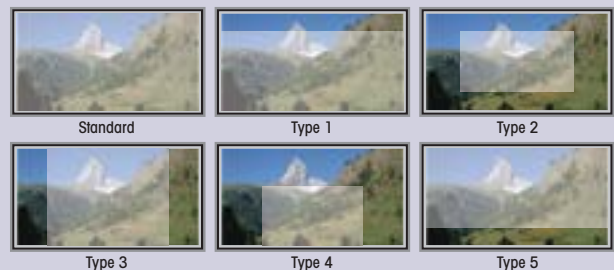

Picture Profile

Up to six different picture-quality settings, including gamma and colour settings, can be registered in the memory as picture profiles. This labour-saving function allows operators to easily recall customised picture-quality settings for various shooting conditions. It is also useful for matching footage shot at different times or for multi-camera setups.

The picture-profile functions of the HVR-Z7E and HVR-S270E include enhanced versions from the HVR-Z1E or HVR-V1E, plus a selection of new functions.

Colour Depth

Generally, the brightness of a video image increases as the colour level becomes more vivid. In these new camcorders, the brightness and colour level are processed independently so that more flexible tone – for instance, a dark image with a vivid colour – is realised by 3D-LUT colour processing.

Note: 3D-LUT = three-dimensional look-up table

Colour Correction

The Colour Correction function of the HVR-Z1E has been improved in the HVR-Z7E and HVR-S270E camcorders. Colour Correction provides two functions for creative shooting. The Colour Extraction function can retain up to two desired colours of monitored pictures in the screen, while making all other colours black and white. The advanced function allows users to select the colour simply by pressing a button to memorise the centre colour of the captured image.

The Colour Revision function can change the hue of only the colour designated by the Colour Extraction function. This function is good not only for creating impressive images, but also for blue- or green-screen shooting in order to normalise uneven colour.

The colour data is stored in each Picture Profile so that users can select the most suitable colour setting for each shooting situation.



Normal

Colour Extraction

Colour Revision

Colour Correction Images Simulated

WB Shift

The WB (White Balance) Shift function allows users to create an impressive colour or to adjust the colour temperature of the camcorder.

There are two WB Shift options to choose from:

- LB-CC type: adjusting the LB axis (colour temperature) and CC filter effect
- R-B level type: adjusting the red and blue levels

Skintone Detail

This function allows users to change the sharpness of an object with a specific colour and is particularly good for making skin tones look more natural. The target colour can be specified by controlling the Phase/Range/Saturation/Y Level/Y Range parameters or by pressing a button to specify the colour of an object with a colour picker. If the sharpness of the background object is decreased, the blur looks more natural.

Improved Microphone Sound Quality

❖ New Supplied Monaural Microphone ECM-XM1

The supplied ECM-XM1 microphone's S/N ratio is 78 dB, a sensitivity increase of 14 dB over its predecessor, the ECM-NV1*⁶.

*⁶ The ECM-NV1 is a supplied microphone with DSR-PD170P, DSR-250P, HVR-A1E and HVR-V1E.

Microphone	ECM-XM1	ECM-NV1
Sensitivity (at 1 KHz)	-30 dB±3.5 dB* ⁷	-44 dB±4.0 dB
Signal-to-noise ratio	78 dB, typical	70 dB
Frequency Response	50~20,000 Hz	100~15,000 Hz
Maximum input sound pressure level* ⁸	127 dB SPL, typical	121 dB SPL
Dynamic Range	111 dB, typical	97 dB

*⁷ 0 dB=1 V/Pa. at 1 kHz

*⁸ 0 dB SPL=20 μPa.

Selectable Progressive Modes

The HVR-Z7E and HVR-S270E have two types of progressive shooting modes.

❖ 25p HDV Native Progressive Recording Modes

PROGRESSIVE

The HVR-Z7E and HVR-S270E camcorders newly feature a 25p HDV native progressive recording mode. The 3 ClearVid CMOS Sensor system and EIP create true 1080p images, which can then be recorded as a progressive signal by the HVR-Z7E and HVR-S270E camcorders in HDV format.

The progressive HDV stream can be output from an i.LINK connector and used for progressive editing with compatible NLE software.

The native progressive recording mode is suitable for output to film, CG composition, viewing on a progressive monitor, or as an Internet movie.

Note: interlaced video is output from connectors other than i.LINK

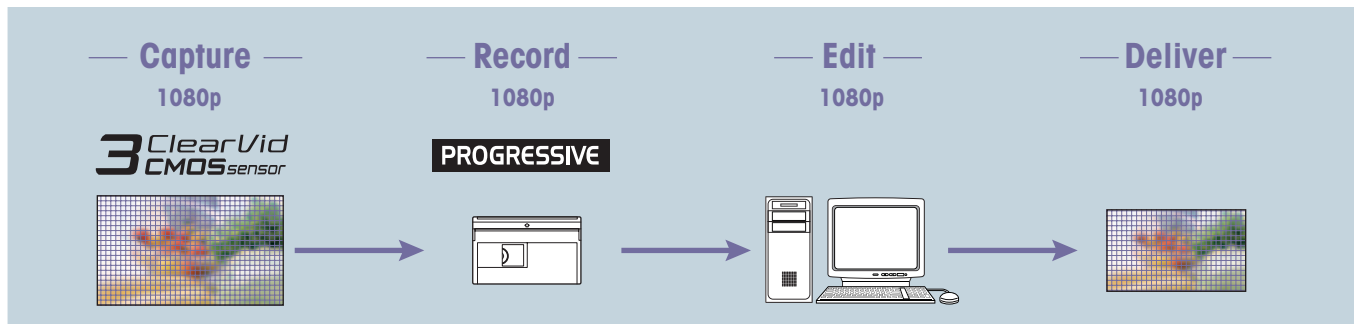

❖ 25p Progressive Scan Mode

In this mode, the 1080p image captured by the 3 ClearVid CMOS Sensor system is also recorded as an interlaced signal by dividing each frame into two fields. This enables compatibility with current editing and monitoring equipment that only accept interlace signals, while maintaining the quality of the 1080p image. The progressive scan mode is suitable for feature films,

documentaries and music videos, which have to be recorded as interlaced video for viewing on interlaced monitors, but want to offer a "progressive look" to their motion.

It is also possible to edit footage recorded in the "25p scan" mode as progressive material.

Most NLE software can output the edited timeline in progressive format by merging odd and even fields.

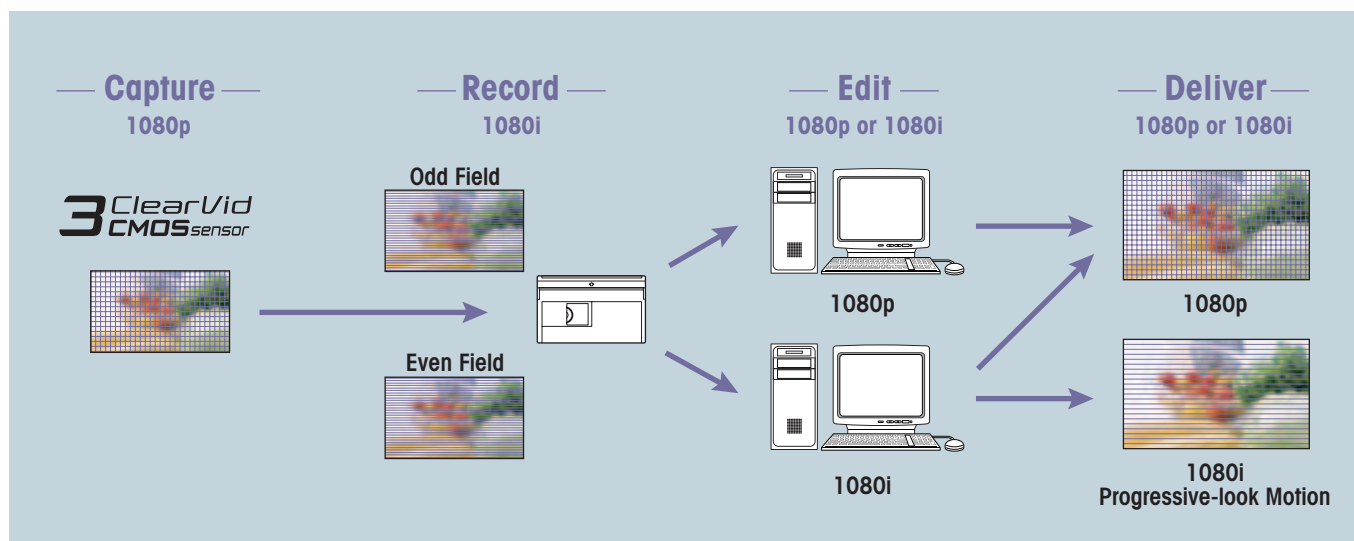

Memory Recording Unit

HDV in IT Workflow by CompactFlash Memory Recording Unit

The Memory Recording Unit is supplied with each camcorder to support HDV tape recording. It captures the HDV1080i, DVCAM, or DV stream output from the camcorder and records it as movie file while you are simultaneously recording to tape. You can use a standard CompactFlash (CF) card*, which offers secure recording, high-speed access, large data capacity, removable media convenience and high durability against external vibration.

*Not supplied.

The CF card was selected for these HDV camcorders because the media is easily obtainable. So, in the same way as miniDV tape is easily obtainable for HDV recordings, CF will be easily available for file recording. This general versatility is very important for those who frequently need to obtain media quickly, such as someone shooting a documentary or news reports while moving from city to city.

HDV/DVCAM/DV File Recording on Easily Obtained CompactFlash Card

The recording time on a 16-GB CF card*⁹ in HDV, DVCAM and DV format*¹⁰ is approximately 72 minutes.

CF card capacity	Recording time(approximately)
16GB	72 minutes
8GB	36 minutes
4GB	18 minutes
2GB	9 minutes

*⁹ At least 133x speed and 2-GB capacity is required. The NCFD8GP and NCFD16GP Sony CF cards are recommended.

*¹⁰ The recording time may change according to the CF card type and recording format.

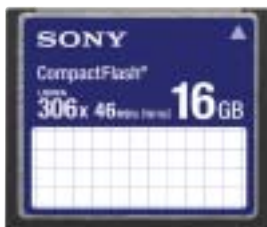

72 min.
16 GB



Integration Without Cabling

The Memory Recording Unit can be integrated to the HVR-Z7E or HVR-S270E without the need for cabling, simply by attaching it onto the special shoe connector*¹¹. This smart combination never interferes with shooting operations. The Memory Recording Unit automatically synchronises with the recording action of the camcorder – i.e., when the camcorder starts or stops recording, so does the unit.

*¹¹ The intelligent shoe connector inputs and outputs an HDV/DV stream and supplies power to the Memory Recording Unit. The i.LINK connector is not available when the unit is attached on the camcorder.



attached on the HVR-Z7E



attached on the HVR-S270E

Hybrid Operation Realises Archiving, IT Workflow and HD/SD Parallel Recording

The Memory Recording Unit provides a hybrid operation, where images are recorded to tape and a CF card simultaneously, in a similar fashion to the HVR-DR60 Hard Disk Recording Unit*¹².

*¹² HVR-DR60 does not accept a native progressive HDV stream.

This means you can immediately access a movie file for streamlined NLE work, while keeping the master source tape in a safe place.

The file format is M2T for HDV mode and AVI or RawDV for DVCAM/DV modes.

Mode	File Format
HDV	M2T
DVCAM/DV	DV-AVI(type 1) or Raw-DV

In the same fashion as HVR-DR60 operation, these files can be edited using popular NLE software.*¹³

*¹³ The Memory Recording Unit and HVR-DR60 adopt the FAT32 file system. Continuous recording is divided into 4-GB files (approximately 20 minutes of recording time). A utility software, available from the Sony website, can merge these divided files for seamless editing on NLEs. Some NLEs include this function. For details of NLE operation, please consult your nearest NLE software dealer.

In addition, when the built-in down-converter of the connected HDV camcorder is active, SD images can be recorded on a CF card while HD images are recorded to tape.

HD master tape is recorded and SD movie files are created at the same time.

HDV or DVCAM tape-based users can gradually move to IT workflow with this hybrid-operation. Tape-less recording is also available if desired.

Hybrid-Recording

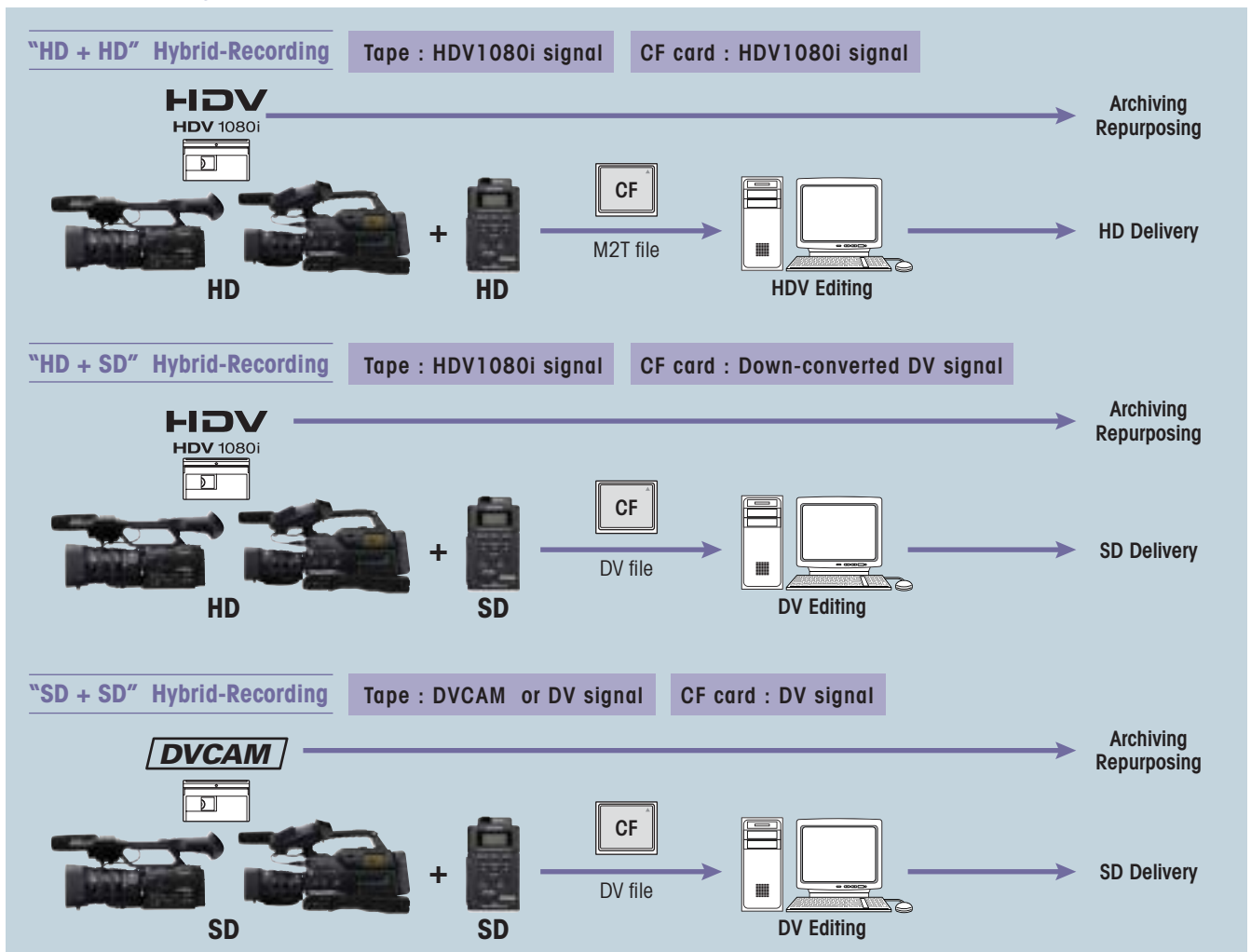

File Transfer

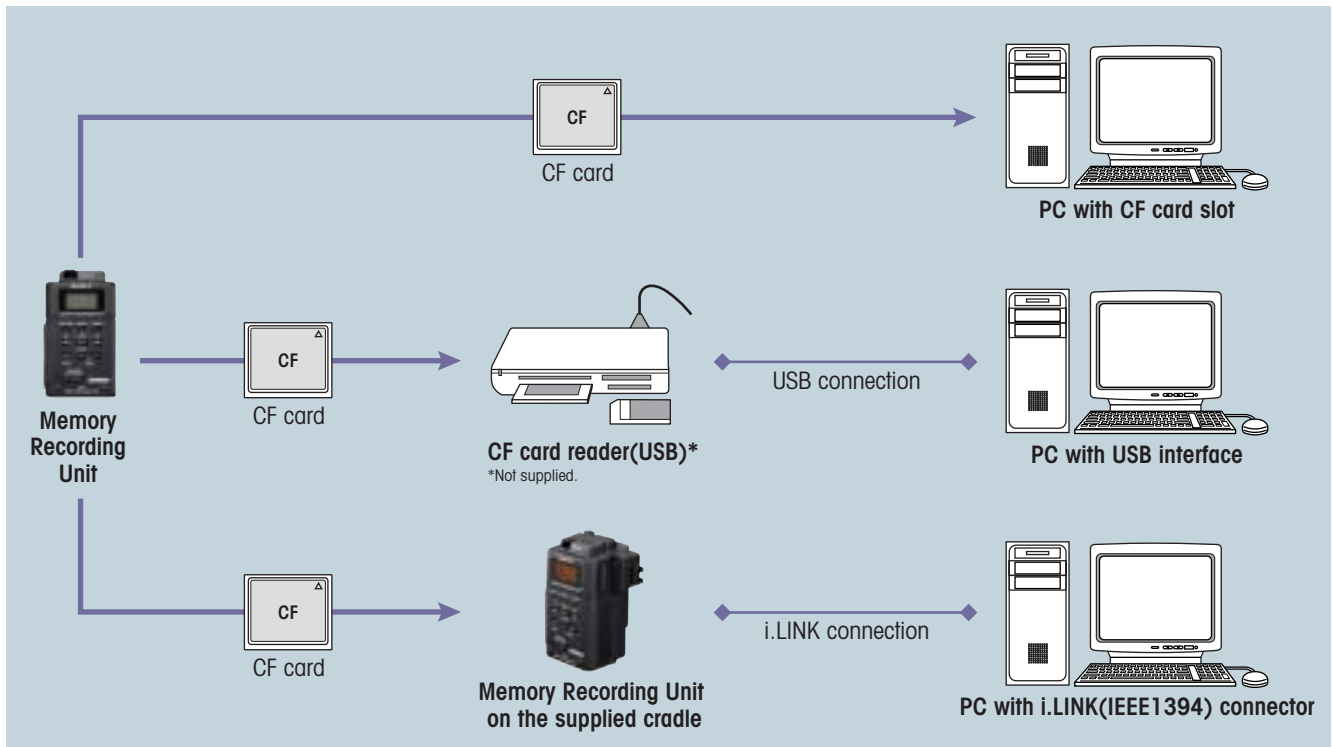

Playback from the Memory Recording Unit

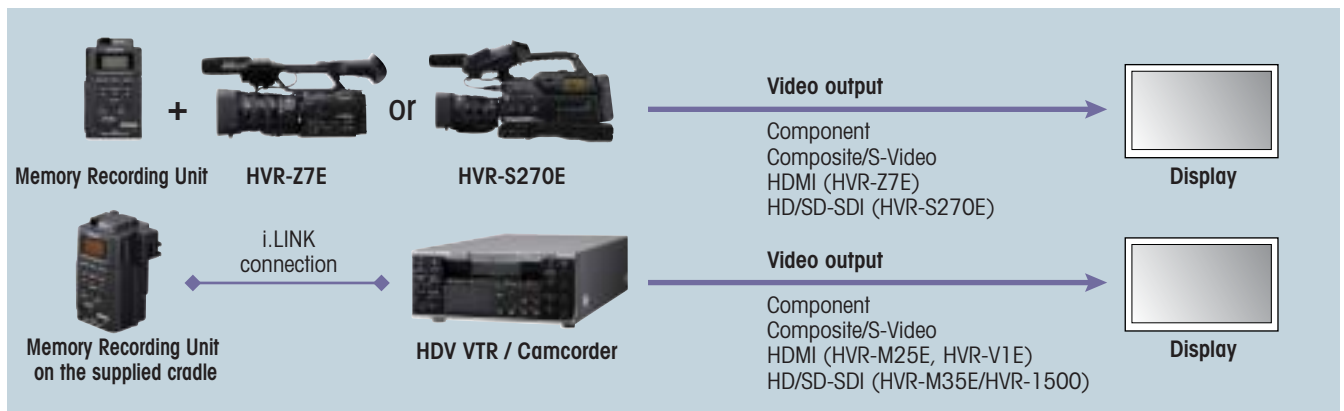

Independent Use With the Supplied Cradle

The Memory Recording Unit can be used as an external recording unit, just like the HVR-DR60, by attaching the supplied cradle that has an i.LINK connector, battery attachment and DC power input. When the Memory Recording Unit is connected to a PC via i.LINK, it is recognised as an external drive and can be used to access files. When connected to a video device (such as a VTR or NLE system) via i.LINK, it can be used to input/output a HDV/DVCAM/DV stream.



HVR-Z7E

Sony's new HVR-Z7E is the world's first professional handheld HDV camcorder with an interchangeable lens system. The compact design makes it easy to use and flexible when shooting applications requiring mobility and in space-constrained locations.



❖ HDV, DVCAM and DV Recording on a miniDV Cassette tape

The HVR-Z7E accepts miniDV cassette tapes, which provide over 60 minutes recording time for HDV and DV formats, over 40 minutes for DVCAM format.



❖ An Ideal Handheld Camcorder Design

Sony has responded to professional user feedback to create the ideal handheld camcorder with ergonomically designed body-weight balance and a well-planned layout of buttons and connectors to reduce camera operator fatigue.



Operational Versatility of HVR-Z7E

❖ New XtraFine LCD and EVF Offer High-resolution, High-contrast Images

XtraFine™ LCD

A 3.2-inch type XtraFine LCD is located on the HVR-Z7E in the same position as on the HVR-Z1E.

The high pixel number of approximately 921,000 dots is around four times greater than the LCD of the HVR-Z1E, and this higher resolution allows for easier focus adjustments.

XtraFine EVF

The 0.45 inch type XtraFine EVF (Electronic View Finder) has approximately 1,227,000 dots (852x480x3(RGB)). This device has three independent LEDs for R, G, and B colours. This technology allows users to check objects with remarkable colour reproduction and resolution*. The EVF has a selectable display mode between colour or black and white.

*When the camcorder is panned quickly or when an object in the screen moves quickly, the primary colours of R/G/B may be seen on the object in the EVF momentarily.

Common Features of the XtraFine LCD and EVF

- 100% full-scan display - helps you to check the entire recorded area.
- 6500k colour temperature - the standard for professional monitors.



XtraFine LCD and EVF

❖ infoLITHIUM L Series Battery Compatible

The HVR-Z7E uses the same batteries as the HVR-Z1E, HVR-V1E and DSR-PD170P, so you can fully utilise your existing battery and charger assets.

❖ HDMI output connector

Uncompressed digital HD video and audio signals are output from the HDMI connector. You can see stunning HD images on the HDMI-compatible monitor display. During shooting, the pre-compressed 1920x1080i/4:2:2 signal is output from the HDMI connector.



❖ Smooth Slow Rec

The Smooth Slow Rec function of the HVR-Z7E camcorder enables slow-motion playback by capturing images four times faster than the normal field rate (200 fields/s). In this mode, quad-speed images are captured for three seconds, stored in the built-in buffer memory, and then recorded to tape (in either HDV, DVCAM, or DV format) as slow-motion pictures lasting 12 seconds*¹⁵. This allows recorded images to be checked immediately in the field. Although the resolution of the picture quality is decreased, this function is effective for some applications that don't need full HD quality, such as Internet movies or the analysis of moving objects like a golf swing, for example.

■ Smooth Slow Rec

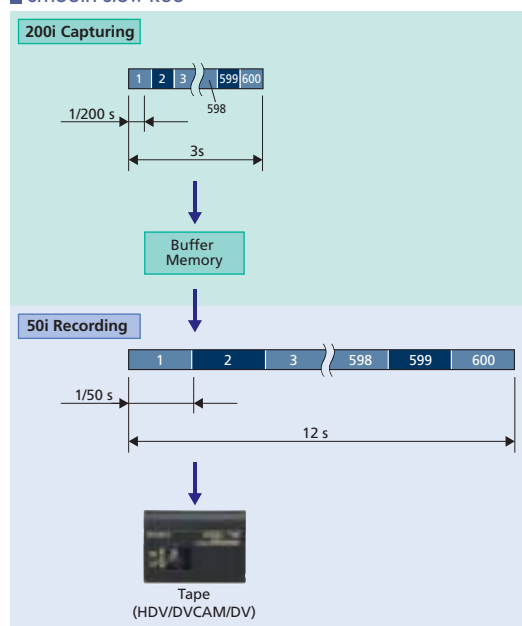

*¹⁵ Audio cannot be recorded while shooting in this mode.

❖ Two Accessory Shoes

The HVR-Z7E features two accessory shoes. There is a cold shoe on the front that can be removed to make room for a mattebox. While at the rear, there is a screw-hole type shoe located on the handle, which can be changed to a cold shoe, if required, using supplied parts.



A:Removable Front Shoe B:Screw Hole



Removable Front Shoe



Rear cold shoe parts

❖ Two Screw Holes for Secure Connection

To provide a more secure connection between the camcorder and tripod plate or other accessories, two screw holes have been incorporated.

❖ One-touch Clip-type Microphone Holder

A one-touch clip-type microphone holder makes it easy to remove the microphone for quick storage.

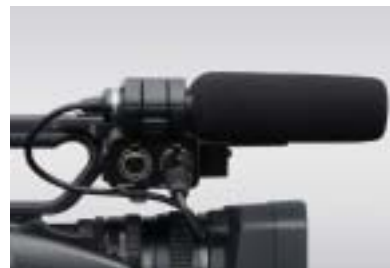

Clip-type microphone holder

HVR-S270E

The HVR-S270E offers videographers a traditional "on-the-shoulder" feel with the benefits of increased camera stability and longer recording time of up to 4.5 hours with standard size cassettes.



❖ Standard-size Cassette Compatibility

A standard-size cassette tape provides approximately 4.5 hours of HDV/DV recording or approximately 3 hours of DVCAM recording. Of course, recording on a miniDV tape is still an option.



❖ HD/SD-SDI & Other Output Connectors

An HD/SD-SDI output connector provides embedded audio and TC data and can, for example, be linked up to an XDCAM HD deck.

BNC connectors provide secure cabling connections.



Rear panel



Connectors



Side panel

❖ Four-channel Audio Input

Four-channel audio recording is realised in HDV and DVCAM thanks to four XLR audio input connectors – two at the front, and two at the back.

❖ "Dual Finder" New LCD Position on EVF Unit

The new LCD position on the EVF (Electric View Finder) unit is currently only available on Sony's professional HDV shoulder-mount camcorders.

The HVR-S270E camcorder features a new configuration of a 3.2-inch type XtraFine LCD monitor (approximately 921,000 dots) and an XtraFine EVF (approximately 1,227,000 dots, 852x480x3 (RGB))* . The LCD is located on the EVF unit. This unique layout enables the camera operator to perform both traditional EVF monitoring and LCD monitoring, while the camcorder is held on the shoulder. The 180-degree tilt mechanism allows for LCD monitoring when the camcorder is held in a high or low-angle position. The 270-degree swivel mechanism will allow LCD monitoring from the front, right, or even left of the camcorder so that a reporter or a director can monitor what is being captured by the camcorder.

*When the camcorder is panned quickly or when an object in the screen moves quickly, the primary colours of R/G/B may be seen on the object in the EVF momentarily.



❖ BP Series Battery Compatible

V-LOCK professional BP batteries are another great feature in common with broadcast camcorders.

❖ Smooth Slow Rec

As with the HVR-Z7E, the HVR-S270E camcorder enables slow-motion playback by capturing images four times faster than the normal field rate (200 fields/s).

HVR-M35E

The HVR-M35E is compatible with HDV native progressive recording modes and supports HD/SD-SDI output with embedded audio and TC data.



❖ HD/SD-SDI Output

The HD/SD-SDI output of HVR-M35E allows straight duplication to a deck with HD/SD-SDI input.

❖ Multi-format Playback/Recording Capability

The HVR-M35E supports HDV native progressive recording modes and has a 60i/50i switchable function, so it can playback/record:

- HDV1080i: 60i/50i/24p/30p/25p
- DVCAM/DV: 60i/50i
- The HDV720p(24/25/30p) tape playback is available for a simple viewing.*

*No i.LINK output for HDV720p

❖ Standard and Mini Size Cassette Tape Compatibility

Both standard and mini size cassette tapes are supported. It accepts standard cassettes shot on the HVR-S270E or other shoulder-mount DVCAM camcorders.



❖ Four Channel Audio Data Playback

The HVR-M35E can play back the four-channel audio data in HDV1080i format recorded by the HVR-S270E. It can also play back the four-channel audio data in DVCAM format. The four-channel audio data is embedded in the i.LINK and HD/SD-SDI output, or is output through the AES/EBU audio connectors.

❖ 2.7-inch Wide Clear Photo LCD plus Screen and Monaural Speaker

A built-in 2.7-inch type wide Clear Photo LCD plus™ screen and built-in monaural speaker allow quick and convenient checking of video and audio.

❖ Other Functions of the HVR-M35E

The HVR-M35E covers most functions of its lower-end model, the HVR-M25E.

Down-conversion Playback Capabilities

The HVR-M35E can convert material from HD down to SD, and output the SD video signal through its i.LINK, SD-SDI, analogue component, S-video, and composite connectors. This allows users to edit recorded material with a compatible nonlinear editing system using current DV editing software, as well as record SD signals to an external VTR.

When down-converting these signals, the aspect ratio displayed can be converted from 16:9 to 4:3. Display modes can be selected from Squeeze, Letterbox, and Edge Crop*16.

*16 Letterbox output is not available from the i.LINK connector. For the HDV recording with four channels audio data, the audio data in the down-converted DV signal is selectable from either 1/2ch or 3/4ch.

Edge Crop Adjust

When down-converting signals in Edge Crop mode, you can use the Edge Crop Adjust function to adjust the edge crop position. By displaying the edge crop marker on the LCD monitor, operators can conveniently check the edge crop position before outputting down-converted signals.

DUPLICATE PLUS

The DUPLICATE PLUS function makes it easy to copy video and audio from a VTR or camcorder onto the HVR-M35E – along with the original time code. Operators simply connect the two i.LINK devices together via their i.LINK interfaces and press the DUPLICATE PLUS and PLAY buttons on the front panel of the HVR-M35E. Copying will then begin.



Front



Rear

Accessories

New **Optional Wide Lens**
 VCL-308WBH (for HVR-Z7E)*
 VCL-308BWS (for HVR-S207E)*

New **α lens adaptor**
 LA-100W*

* For the detail on the release date, please ask your nearest Sony office or authorised dealer.

CompactFlash Card
 NCFD16GP 16GB 300x
 CompactFlash Card
 (available from April 2008)
 NCFD8GP 8GB 300x
 CompactFlash Card



New **VCT-SP1BP**
 Camcorder Support (HVR-Z7E)

- Weight support for stable/ comfortable shooting
- Support for several shooting styles (e.g., high-angle shooting)
- Quick-release function from harness for excellent mobility
- Perfect design for a camcorder Monopod
- Carbon shaft for light weight and rigid design
- RM-1BP Remote Controller supplied as standard



New **AC-VQL1BP**
 AC Adaptor Charger (HVR-Z7E)

- 4 slots battery charger (A pair of parallel charge)
- 2 charge mode selectable (Normal/Full)
- Charging information
 Remaining time to charge complete
 Current available time for shooting
- Battery Log information
 Total charge time
 Total charge cycle
 Last operation date



New **SH-L32WBP**
 LCD Hood (HVR-Z7E/S270E)

- LCD Hood for 3.2" LCD monitor
- Adjustable shade (360° shade)
- Folding structure - no need to remove from camcorder



HVR-DR60
 Hard Disk Recording Unit

An external Hard Disk Recording Unit with a 60GB capacity and 4.5 hours of recording time for HDV, DVCAM and DV. (battery is not supplied)



HVL-LBP
 LED Battery Video Light (HVR-Z7E/S270E)

- LED reliability and low power consumption of 16W
- Battery power from NP-F770/F970
- Wide compatibility for flexible installation (Cold shoe/Screw bolt/Screw hole)
- Ideal for Wide-angle shooting and interviews
 Spot (600lx@1m) or flood-lighting (300lx@1m) with attached condensing lens ON or Off
- Light diffuser attached to soften shadows and reduce contrast
- Long Operating time: approximately 3 hours with the NP-F970 (at maximum brightness)

2NP-F970/B
 InfoLITHIUM Rechargeable Battery Pack (2 pack) (HVR-Z7E)

NP-F970/F770/F570
 InfoLITHIUM Rechargeable Battery Pack (HVR-Z7E)

VCT-PG11RMB
 Tripod with RM-1BP Remote Controller (HVR-Z7E)

RM-1BP
 LANC remote controller (HVR-Z7E/S270E)

BP-GL95/GL65/L60S/L80S
 Lithium-ion Battery Pack (HVR-S270E)

BC-L70/M150/L500
 Battery Charger (HVR-S270E)

AC-DN10
 AC Adaptor (HVR-S270E)

Specifications (HVR-Z7E,HVR-S270E)

		HVR-Z7E	HVR-S270E
Camera section			
Supplied Lens		Carl Zeiss Vario-Sonnar T* zoom lens, 12x (optical), f = 4.4 to 52.8 mm, f = 32.0 to 384 mm* at 16:9 mode f = 39.5 to 474 mm* at 4:3 mode, filter diameter: 72 mm	
Built-in filter		Clear, 1/4, 1/16, 1/64	
Imaging system		1/3-inch, progressive 3 ClearVid CMOS Sensor system with Exmor technology	
Picture elements		Approx. 1,037,000 pixels (effective), approx. 1,120,000 pixels (total)	
Focus		Auto, manual (focus ring/one push auto/infinity/AF assist/ focus macro)	
White balance		Auto, one-push auto (A/B positions), indoor (3200 K), outdoor (selectable level -7 to +7, approx. 500K/step), manual WB Temp (selectable 2300K to 15000K, 100K/step)	
Manual shutter speed	Auto	1/50 - 1/1750	
	Manual	50/25p: 1/3 - 1/10000	
Gain		-6, -3, 0, 3, 6, 9, 12, 15, 18, 21 dB	
Minimum illumination		1.5 lux (auto gain, auto iris, 1/25 shutter)	
VTR section			
Recording format		HDV1080/50i, DVCAM, DV SP 576/50i (PAL)	
Play out/Down conversion format		HDV1080/50i, DVCAM, DV SP 576/50i (PAL)	
Playback/Recording time	HDV/DV SP	Max. 63 min with PHDVM-63DM cassette	Max. 276min with PHDV-276DM Max. 63 min with PHDVM-63DM cassette
	DVCAM	Max. 41 min with PHDVM-63DM cassette	Max. 184min with PHDV-276DM Max. 41 min with PHDVM-63DM cassette
Input/Output connectors			
Audio/Video output		10-pin connector A/V OUT jack (composite, unbalanced audio x2ch with the supplied cable)	Composite video (BNCx1) Unbalanced audio (pin x2ch)
Component video output		Component out jack (special connector) BNC x3	
HDV/DV input/output		i.LINK interface (IEEE 1394, 6-pin)	
XLR audio input		XLR 3-pin female x 2ch	XLR 3pin female x 4ch
Headphone		Stereo mini jack (ø3.5 mm)	
LANC		Stereo mini-mini jack (ø2.5 mm)	
Digital video output		HDMI connector	HD/SD-SDI BNC x1
Built-in output devices			
LCD view finder		0.45-inch type (Viewable area measured diagonally), approx. 1,226,880 dots (852x480x3(RGB)), 16:9 aspect ratio	
LCD monitor		3.2-inch type (Viewable area measured diagonally), XtraFine LCD, approx. 921,600 dots, hybrid type, 16:9 aspect ratio	
General			
Mass		Approx. 2.4 kg (5 lb 4 oz) (w/ the supplied lens, w/o tape, battery)	Approx. 6.3kg (13 lb 15 oz) (w/ the supplied lens, w/o tape, BP-GL95battery)
Power requirements		DC 7.2 V (battery pack), DC 8.4 V (AC adaptor)	
Power consumption	HDV	Approx. 7.0 W (with ECM-XM1 / LCD EVF ON)	
	DVCAM/DV	Approx. 6.8 W (with ECM-XM1 / LCD EVF ON)	
Operating temperature		0 to 40 °C (32 to 104 °F)	
Storage temperature		-20 to +60 °C (-4 to 140 °F)	
Supplied accessories		AC-VQ1050 AC adaptor/charger, NP-F570 infoLITHIUM rechargeable battery pack, A/V connecting cable, component video cable, lens hood with lens cover, lithium battery (CR2025), shoe adaptor, large size eye-cup, additional normal shoe kit, RMT-831 wireless Remote Commander, ECM-XM1 monaural electret condenser microphone Operating instructions (CD-ROM) Printed operating instructions, memory recording unit kit	lens hood with lens cover, lithium battery (CR2025), large size eye-cup, additional normal shoe kit, ECM-XM1 monaural electret condenser microphone, Shoulder Belt, Operating instructions (CD-ROM), Printed operating instructions, memory recording unit kit
Supplied memory recording unit			
Recording media		CompactFlash card (2GB or bigger, 133x or faster) (not supplied)	
File system		FAT32	
File format	HDV	.M2T	
	DVCAM/DV	.AVI (DV-AVI, type 1) or .DV (Raw-DV)	
Connectors		special hot shoe i.LINK-6pin (on the supplied cradle) DC power input (on the supplied cradle) infoLITHIUM L series battery slot (on the supplied cradle)	

Specifications (HVR-M35E)

Recording/playback performance		
Recording format	HDV	HDV1080/60i, 1080/50i, 1080/24p, 1080/25p, 1080/30p
	DVCAM / DV SP	DVCAM, DV SP 480/60i (NTSC), 576/50i (PAL)
Playout format	HDV	HDV1080/60i, 1080/50i, 1080/24p, 1080/25p, 1080/30p, HDV720/24p, 720/25p, 720/30p
	DVCAM / DV SP	DVCAM, DV SP 480/60i (NTSC), 576/50i (PAL)
Playout video signal		1080/60i, 1080/50i, 480/60i (NTSC), 576/50i (PAL), 480/60P, 576/50P 720/60P, 720/50P
Tape speed	HDV/DV SP	Max. 18.812 mm/s
	DVCAM	Max. 28.218 mm/s
Playback/recording time	HDV/DV SP	Max. 276 min with PHDV-276DM cassette Max. 63 min with PHDVM-63DM cassette
	DVCAM	Max. 184 min with PHDV-276DM cassette Max. 41 min with PHDVM-63DM cassette
Fast forward/rewind time		Approx. 2 min with PHDV-276DM cassette
Input/output connectors/devices		
Video input/output		BNCx1 / BNCx1
Monitor video out		RCA pin x1
S-video input/output		Mini-DIN 4-pin x1 / Mini-DIN 4-pin x1
Component video output		BNC x 3
i.LINK interface (HDV /DV)		6-pin (no power)

HD/SD-SDI output	BNC x1
Audio input	RCA pin x 4ch
Audio output	XLR 3pin x 4ch
Monitor audio out	RCA pin x 1
AES/EBU output	BNC x2
TC out	BNC x1
Phones	Stereo minijack (ø3.5 mm)
LANC	Stereo mini-minijack (ø2.5 mm)
Control S input	Stereo minijack (ø3.5 mm)
LCD monitor	2.7-inch type (Viewable area measured diagonally), approx. 211,200 dots (960 x 220), Clear Photo™ LCD Plus
General	
Weight	Approx. 9 lb 12 oz (4.4 kg)
Dimension (WxHxD)	Approx. 212 x 88 x 390.3mm (8 3/8 x 3 1/2 x 15 3/8 inch)
Power requirements	AC 120 V, 60 Hz
Power consumption	16 W (playback mode with LCD monitor on)
Operating temperature	41 to 104 °F (5 to 40 °C)
Storage temperature	-4 to 140 °F (-20 to +60 °C)
Supplied accessories	Remote Commander Unit (1), power cord (1), size AA batteries (2), cleaning cassette (1), operating instructions (1)

SONY

Specialist

Dealer

Sony Specialist Dealers receive extensive training on all our products and services. They combine this with an in-depth knowledge of the market, ensuring you get advice that meets your needs before and after purchase. To find your nearest Sony Specialist Dealer visit our "dealer locator" at: www.sonybiz.net/dealer

Services from Sony: working with you, working for you.

Recognising that every company and every challenge is unique, we offer a complete and comprehensive range of services all the way through consulting, planning, financing, implementation, training, servicing, maintenance and support. Choose exactly what's right for you, when and where you need it.

Sony Professional Services

Tailor-made design, installation and project management of audio-visual and IT (AV/IT) systems using skills developed over 25 years of systems integration.

Sony Financial Services

Innovative and flexible finance solutions designed to meet budgetary and financial requirements and constraints, enabling businesses to always have the most current technology.

Sony Training Services

A range of off-the-shelf or customised training services from basic operation through to high-level technical maintenance.

Sony Support Services

Fully integrated and customised support for products and systems throughout their operational life, combining proactive and reactive technical services.

Not all services are available in all countries. If you'd like to find out more about what we do, who we do it for and how we do it, visit www.sonybiz.net or contact your local Sony office.

© 2007 Sony Corporation. All rights reserved. Reproduction in whole or in part without permission is prohibited.
Features and specifications are subject to change without notice.
All non-metric weights and measurements are approximate. Images on monitors are simulated.
Sony, TRIMASTER, and Memory Stick are trademarks of Sony Corporation.
VESA is a trademark of the Video Electronics Standards Association.
All other trademarks are the property of their respective owners.

Free Manuals Download Website

<http://myh66.com>

<http://usermanuals.us>

<http://www.somanuals.com>

<http://www.4manuals.cc>

<http://www.manual-lib.com>

<http://www.404manual.com>

<http://www.luxmanual.com>

<http://aubethermostatmanual.com>

Golf course search by state

<http://golfingnear.com>

Email search by domain

<http://emailbydomain.com>

Auto manuals search

<http://auto.somanuals.com>

TV manuals search

<http://tv.somanuals.com>