

Glasstron

Operating Instructions

GB

Operating Instructions

CT

WARNING

YOUR FAILURE TO FOLLOW THESE OPERATING INSTRUCTIONS MAY RESULT IN EYE FATIGUE, EYE DAMAGE, OR OTHER INJURY.

CAREFULLY READ THIS INSTRUCTION MANUAL AND BECOME FAMILIAR WITH ALL SAFETY INSTRUCTIONS FOR THIS PRODUCT.

THIS PRODUCT SHOULD NOT BE USED BY CHILDREN AGE 15 OR YOUNGER. IF YOU HAVE BEEN DIAGNOSED WITH EYE DISEASE OR EYE INJURY, CONSULT YOUR DOCTOR BEFORE USE AND DO NOT USE WITHOUT YOUR DOCTOR'S APPROVAL.

WARNING

YOUR FAILURE TO FOLLOW THESE OPERATING INSTRUCTIONS MAY RESULT IN EYE FATIGUE, EYE DAMAGE, OR OTHER INJURY.

CAREFULLY READ THIS INSTRUCTION MANUAL AND BECOME FAMILIAR WITH ALL SAFETY INSTRUCTIONS FOR THIS PRODUCT.

THIS PRODUCT SHOULD NOT BE USED BY CHILDREN AGE 15 OR YOUNGER. IF YOU HAVE BEEN DIAGNOSED WITH EYE DISEASE OR EYE INJURY, CONSULT YOUR DOCTOR BEFORE USE AND DO NOT USE WITHOUT YOUR DOCTOR'S APPROVAL.

Personal LCD Monitor
Glasstron™

PLM-A35

Glasstron is a brand-new concept in visual display

Congratulations on your purchase of a Sony Glasstron Personal Viewer. The Glasstron, using current technology in small, lightweight visual displays, provides a television viewing experience similar to watching a 52-inch television from a distance of approximately 2 m (6.6 feet). (Viewing experience may differ according to individual perception.)

The Glasstron Personal Viewer creates an image through two separate liquid crystal displays, in close proximity to your eyes. To insure your safe use of the Glasstron, please become familiar with its basic operations, including proper fitting instructions, and be aware of any symptoms of eye fatigue or other discomfort you may experience.

WARNING

YOUR FAILURE TO FOLLOW THESE OPERATING INSTRUCTIONS MAY RESULT IN EYE FATIGUE, EYE IMPAIRMENT, OR OTHER EYE INJURY, PROPERTY DAMAGE OR DEATH.

WARNING

THIS PRODUCT SHOULD NOT BE USED BY CHILDREN AGE 15 OR YOUNGER. THE EYES OF CHILDREN ARE STILL DEVELOPING AND MAY BE ADVERSELY AFFECTED FROM USE OF THIS PRODUCT.

Note on the LCD (Liquid Crystal Display)

The LCD screen is made with high-precision technology. However, black points or bright points of light (red, blue, or green) may appear constantly on the LCD screen. This is not a malfunction. (Effective dots: more than 99.99%)

WARNING

To prevent fire or shock hazard, do not expose the unit to rain or moisture.

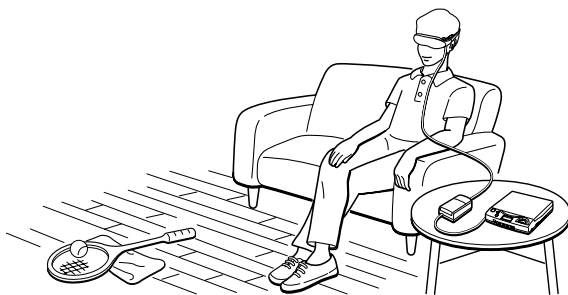

Table of Contents

SAFETY INSTRUCTIONS	4
----------------------------------	---

About the Glasstron	9
---------------------------	---

Getting Started

Checking the supplied accessories	10
Locating the parts and controls	11
Connecting the Glasstron	12
Connecting video equipment	12
Connecting other equipment	13
Connecting the power source	15
Wearing the Glasstron	16

Operations

Using the Glasstron	19
Setting the user lock	23
Using an optional battery pack	24

GB

Additional Information

Precautions	26
Troubleshooting	28
Specifications	29
Index	29

SAFETY INSTRUCTIONS

THE SONY GLASSTRON PERSONAL VIEWER SHOULD BE USED IN STRICT ACCORDANCE WITH ALL INSTRUCTIONS TO PREVENT EYE OR OTHER INJURY, LOSS OF VISUAL FUNCTIONS, PROPERTY DAMAGE, OR DEATH.

USE RESTRICTIONS

Warning: No Use by Children Age 15 or Younger.

This product is designed for adult use.

The eyes of children are still developing and may be adversely affected by use of this product, and it may cause eye fatigue, eye damage, or loss of visual functions.

In addition, this product may not be adjusted to fit a child's head.

User lock: To prevent use by children age 15 or younger, this product is equipped with a locking system. For instructions on the use of the user lock system, see page 23.

Warning: Eye Disease/Eye Injury/Glaucoma.

If you have been diagnosed with or are susceptible to eye disease, eye injury, or glaucoma, consult your doctor before use and do not use without your doctor's approval. Use of this product by individuals with conditions such as glaucoma may cause these conditions to worsen.

Caution: Heart Disease/High Blood Pressure.

If you have a history of heart disease or high blood pressure, consult your doctor before use and do not use without your doctor's approval. Use of this product allows the viewer to feel they are in the action, which may result in increased anxiety or heart injury. If during viewing any increased anxiety is experienced, stop using the product immediately and rest. If the symptoms persist after rest, consult your doctor.

Caution: Seizures.

If you have a history of temporary spasms, unconsciousness, or epileptic seizures from light stimulation, consult your doctor before use and do not use without your doctor's approval. Use of this product by such individuals may cause spasms, unconsciousness, or seizures. If you experience such symptoms during use, stop using the product immediately and consult your doctor.

ADDITIONAL SAFETY INFORMATION.

- A. Health Concerns. See pages 5 through 6.
- B. Instructions for Safe Fit. See page 7.
- C. Warnings for Electronic Products. See page 8.

Health Concerns

Warning: Eye Fatigue/Eye Damage/Loss of Visual Functions.

Misuse or overuse of this product may result in eye fatigue, eye damage, or loss of visual functions. Stop using if you feel tired or experience headaches or discomfort.

Warning: No Use by Children Age 15 or Younger.

This product is designed for adult use.

The eyes of children are still developing and may be adversely affected by use of this product, and it may cause eye fatigue, eye damage, or loss of visual functions.

In addition, this product may not be adjusted to fit a child's head.

Caution: Sickness/Headache/Nausea.

If during use you experience any of the following symptoms, stop using this product immediately and rest. These symptoms may indicate that you are misusing or overusing the product (see "Instructions for Safe Fit," page 7) or that you should not use the product for health reasons. If the following symptoms persist after rest, consult your doctor.

- sore eyes, eye fatigue, or double vision
- headache
- inability to focus on the screen
- nausea or motion sickness
- stiff or sore shoulders or neck

After three hours of continuous use the product automatically turns off to prevent eye fatigue or eye damage. For instructions on these functions, see page 22.

Caution: Motion Sickness from Viewing Programs.

Some viewers may experience motion sickness, headache, or nausea from viewing movies or video programs, especially those with intense action and movement. If you feel any of these symptoms, stop using the product immediately. To avoid personal injury or injury to others, do not drive a car or motorcycle, nor do anything that requires concentration until the symptoms disappear.

Health Concerns

Caution: Motion Sickness from External Motion.

Do not use this product while subject to external motion — for example, as a passenger in a car. Use of this product under these conditions may cause motion sickness.

Caution: Accidents.

Do not use this product while walking, skating, bicycling, operating a motor vehicle or other power equipment, or while engaged in any other similar activity.

Use of this product under these conditions may result in an accident, injury, or death to yourself or others.

Caution: Sound Volume.

Avoid using headphones at high volume. Hearing experts advise against continuous, loud, and extended play. If you experience a ringing in your ears, reduce volume or discontinue use.

Instructions for Safe Fit

Warning: Proper Fit.

Each time this product is used, adjustment screens will appear requiring the viewer to properly fit the product. Failure to properly fit the product each time may result in eye fatigue, eye damage, or loss of visual functions and may result in accident or injury. For instructions on how to properly fit this product, see pages 16 through 21.

Warning: No Use by Children Age 15 or Younger.

This product is designed for adult use.

The eyes of children are still developing and may be adversely affected by use of this product, and it may cause eye fatigue, eye damage, or loss of visual functions.

In addition, this product may not be adjusted to fit a child's head.

User lock: To prevent use by children age 15 or younger, this product is equipped with a locking system. For instructions on the use of the user lock system, see page 23.

Warnings for Electronic Products

Caution: Electric Shock.

Failure to observe all operating and maintenance instructions may cause damage to your product and may result in property damage or injury or death from electric shock, fire, or other cause.

Caution: Do Not Disassemble.

Any required service on this product should be performed by an authorized service technician. Failure to comply with this warning may result in property damage or personal injury or death from electric shock, fire, or other cause.

Caution: Avoid Wet, Humid, Dusty and Smoky Environments.

This product may be adversely affected by wet, humid, dusty, and smoky conditions which may result in property damage, personal injury or death. Do not use this product near or around water. Avoid using or storing this product under these conditions.

Caution: Avoid High Temperature and Direct Sunlight/Avoid Mechanical Shock.

This product may be deformed by high temperature or direct sunlight and also by dropping the product or other mechanical shock. Avoid these conditions, as the screens may lose proper alignment and it may cause eye fatigue or eye damage.

Caution: Unplug the Product When Not in Use.

Always unplug this product when it will not be in use for extended periods of time or during vacations.

Caution: Do not Swing the Product by the Side pieces.

The side piece may become disconnected and cause a malfunction. If the side piece becomes disconnected, reattach it (page 27).

About the Glasstron

Caution: The screen is always right in front of you.

The Glasstron is a face-mounted display. With this type of display, the screen is always in front of you, even if you move your head. Because of this feature, you can concentrate on the screen more easily compared with ordinary TVs, and you have a sense of being in the action.

- It is easy to adjust the Glasstron to your eyes. You can use the display unit even while wearing glasses.
- Every time you use the Glasstron, the adjustment screen appears to help you adjust the display unit properly. You can also check whether the left and right screen positions are properly aligned or not.
- If you keep using the Glasstron continuously for three hours, a warning appears on the screen and the power will turn off automatically.

The Glasstron consists of the following items:

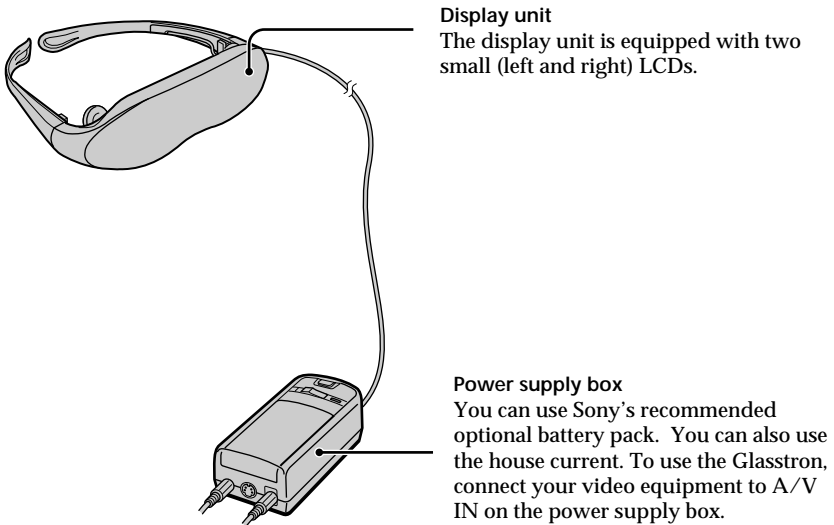

Features

- A powerful, big screen experience comparable to watching a 52-inch screen from approximately 2 m (6.6 feet) away.
- Handy portable folding display.
- The display unit weighs only 95 g (3.4 oz).
- Approximate continuous use for up to seven hours with Sony's recommended battery pack, NP-F550.

Checking the supplied accessories

Check that the following accessories are supplied with your Glasstron. If any item is not supplied, contact your Sony dealer or local authorized Sony service facility.

- Display unit/Power supply box (1)

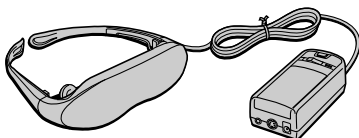

- Plug adaptors
(phono jack ↔ phono jack) (3)

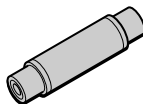

- AC power adaptor AC-PLM2 (1)

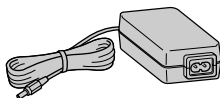

- Nose piece (gray) (1)



- AC power cord (1)

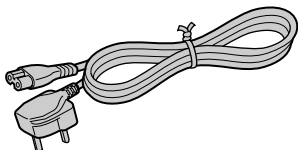

- Side piece pads (2)



- Audio/video cable
(special miniplug ↔ phono plug) (1)

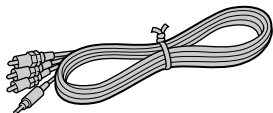

- Operating instructions manual (1)

- Audio/video cable (special miniplug ↔
stereo miniplug) (1)

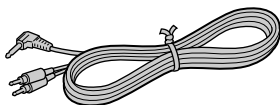

Locating the parts and controls

Refer to the pages indicated in parentheses () for details.

Display unit

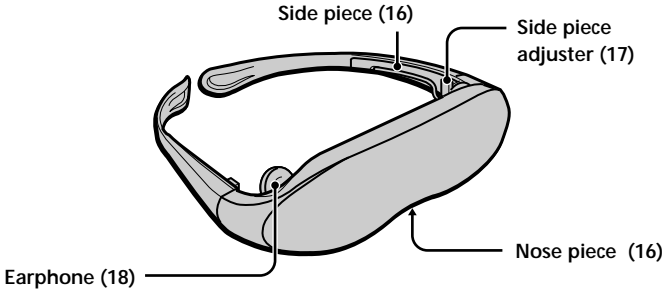

Power supply box

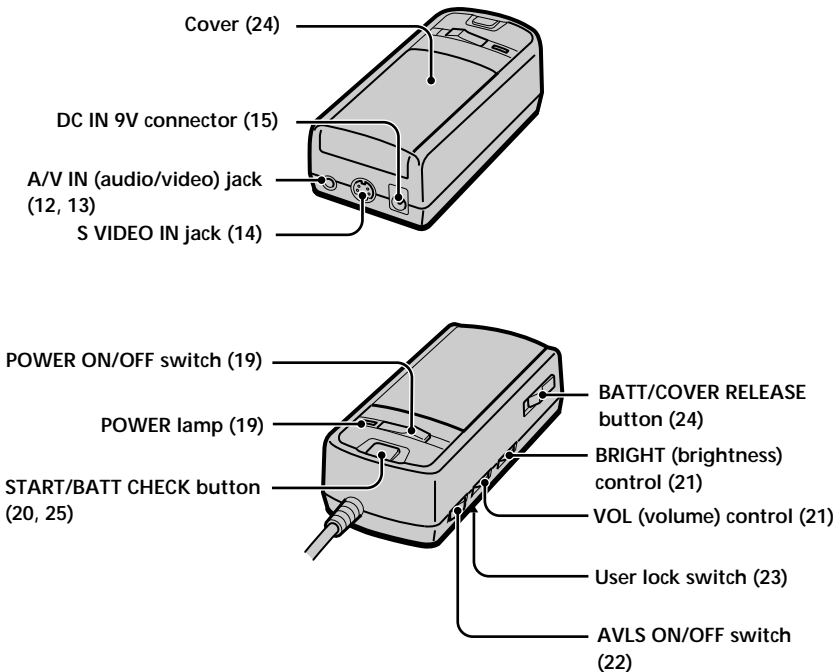

Connecting the Glasstron

Connecting video equipment

Connect a VCR, laser disc player, DVD player, or camcorder to the power supply box as shown below. Two AV cables are supplied. Select the correct AV cable according to the shape of the connectors on the unit to be connected.

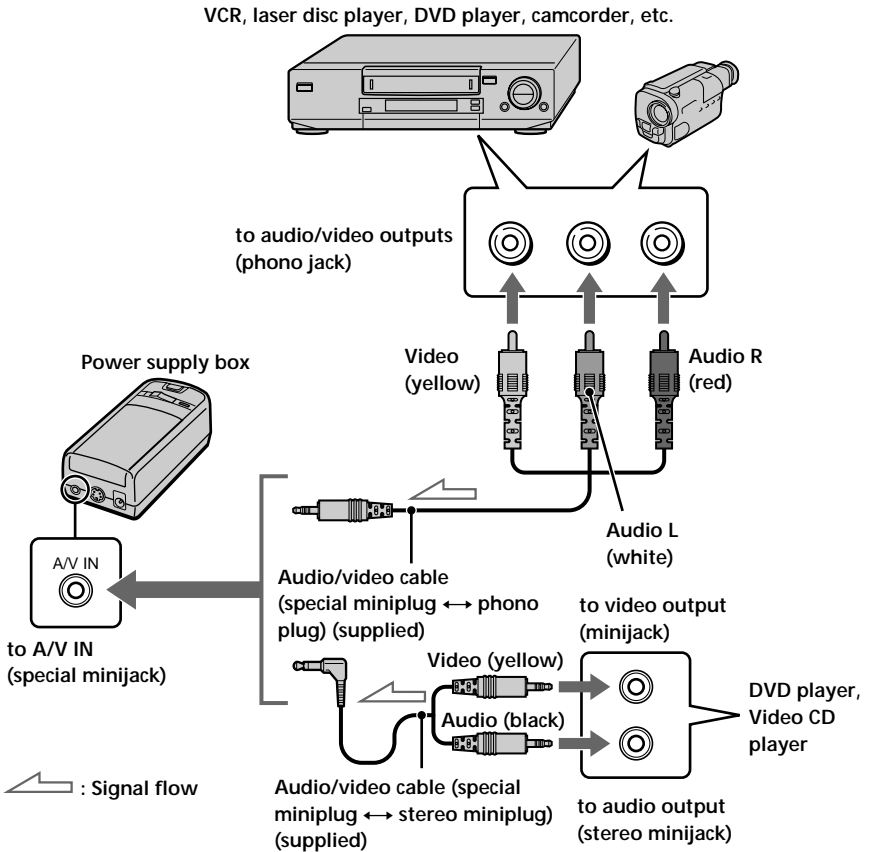

About the audio/video input jack

The audio/video input jack of the Glasstron is a special minijack, and the signal connections are aligned as shown on the right. This alignment may differ depending on the equipment.

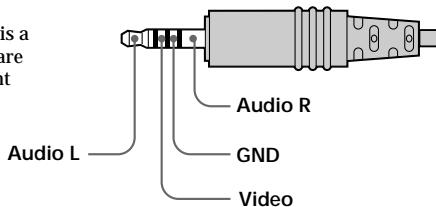

Connecting other equipment

The plug adaptor (phonojack ↔ phonojack) is supplied. Use the plug adaptor according to the equipment you want to connect.

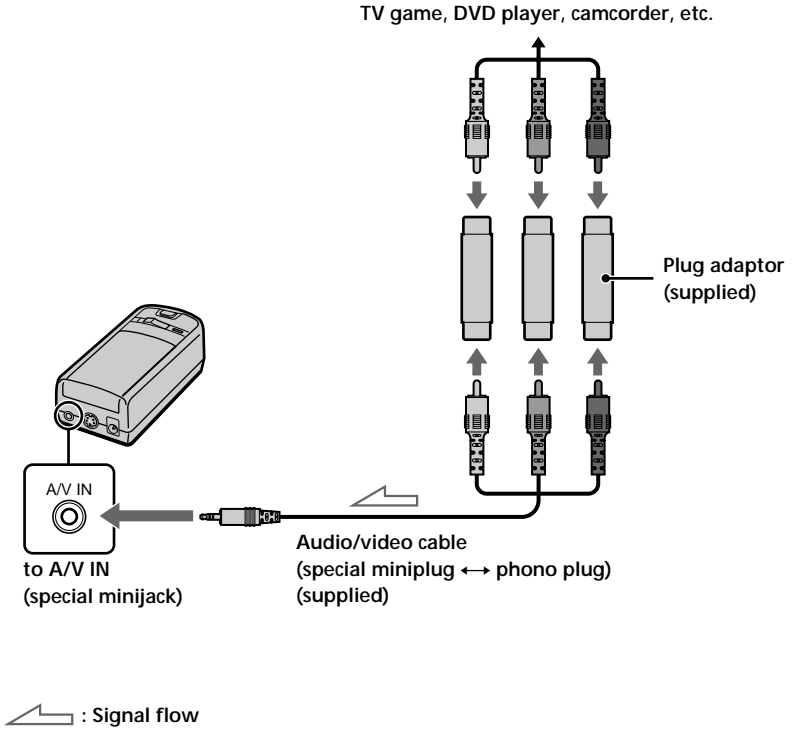

continued

Connecting the Glasstron (continued)

If your video equipment has an S video jack

We recommend connecting the Glasstron to your video equipment using an S video cable and the audio/video cable to enjoy the highest quality pictures. In this case, you do not need to connect the video (yellow) plug. If you connect both the S video and video plugs, the S video signal is automatically selected.

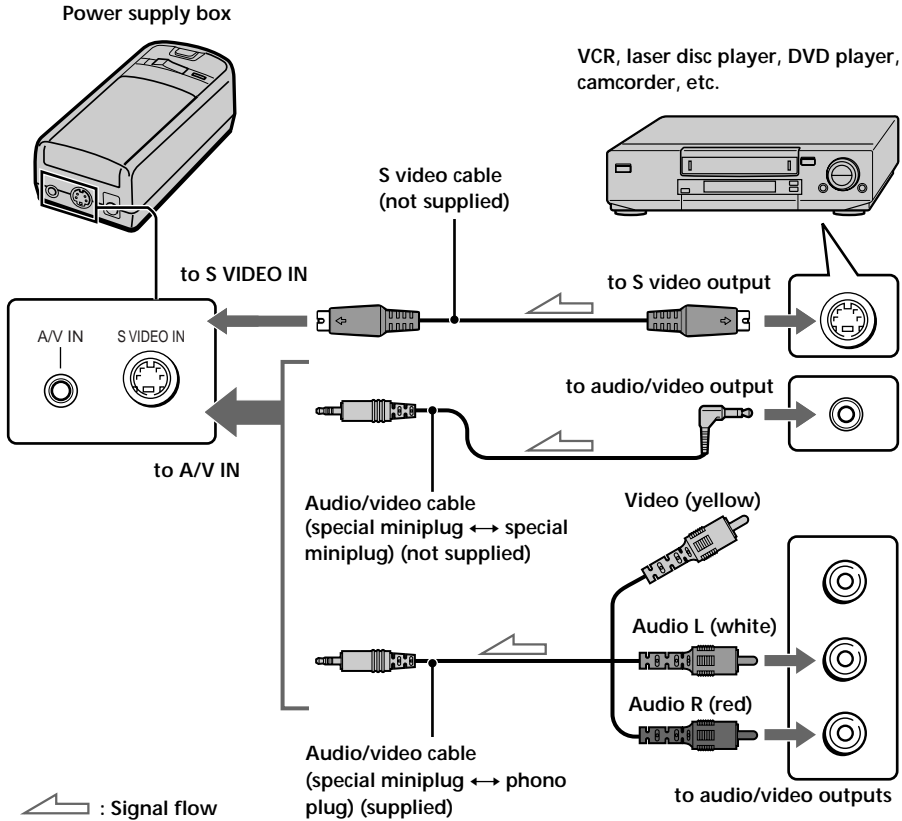

Notes

- Even if you use the supplied audio/video cable, the audio and video signals may not be carried to the Glasstron depending on the video source. In this case, contact your Sony dealer or local authorized Sony service facility.
- When you connect the Glasstron to the audio output jacks (phono jacks) of your video equipment, connect the Glasstron to both the right and left audio output jacks. If you connect the Glasstron to just one audio output jack, you will hear sound from only one of the stereo earphones.

Connecting the power source

Connect the AC power adaptor AC-PLM2 (supplied) to a wall outlet. Do not connect the power source until all other connections are complete.

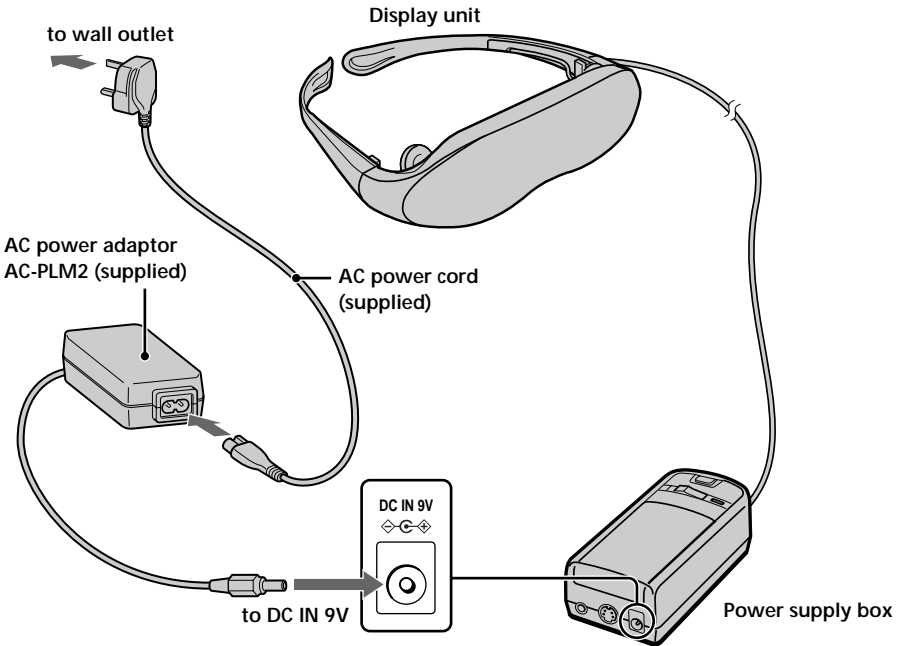

Wearing the Glasstron

WARNING

- Failure to properly fit the product (see “Proper Fit,” page 7) each time may result in eye fatigue, eye damage, or loss of visual functions and may result in accident or injury.
- This product should not be used by children age 15 or younger. The eyes of children are still developing and may be adversely affected by use of this product, and it may cause eye fatigue, eye damage, or loss of visual functions. In addition, this product may not be adjusted to fit a child’s head.

If you normally wear glasses while watching TV, you can use the Glasstron while wearing glasses. When you take the Glasstron off, be careful that your regular glasses not get caught on the Glasstron.

1 Adjust the nose piece and put on the Glasstron.

Pull out the nose piece if you wear glasses.
Open the side pieces by grasping the side piece tips and put on the Glasstron.
Caution:
Be careful not to poke your eyes with the side piece tips when putting the Glasstron on or off.

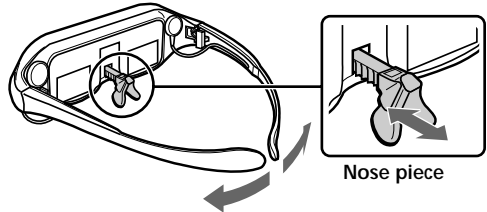

2 Adjust the angle of the display unit.

Adjust the angle of the side pieces by grasping the side piece tips to adjust the display unit to the most suitable viewing position.
You do not necessarily have to rest the side pieces on your ears.

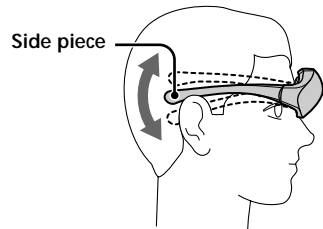

To use the supplied nose piece

If you are still unable to have a full view of the screen or clear picture color on the Glasstron after performing step 2 above, replace the nose piece with the supplied nose piece (gray).

- 1 Remove the nose piece in an upward direction while grasping the nose piece support.
- 2 Insert (B) of the supplied nose piece (gray) into the round notch (A).

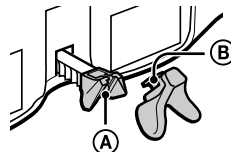
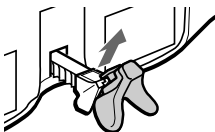

3 Adjust the width of the side pieces.

There are two settings for the side piece width adjustment.

If the fit seems loose, insert the side piece adjusters to the hinges of the left and right side pieces.

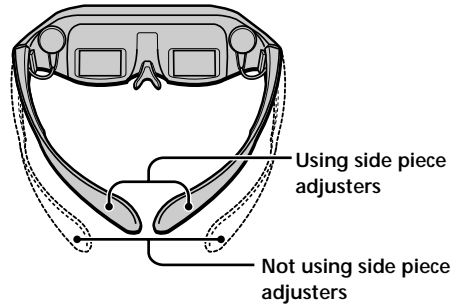

To use the side piece adjusters

- ❶ This is the original position. Normally keep adjusters here.
- ❷ Turn the side pieces inside slightly then gently squeeze the top and bottom of the side piece adjuster and pull out to release.
- ❸ Slide the side piece adjuster toward the display unit.
- ❹ Reinsert the side piece adjuster tines into the hinge area between the side piece and display unit. Repeat the procedure for the other side piece.

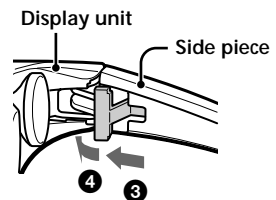
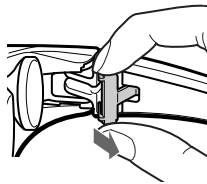
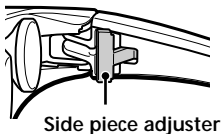

To reset the side piece adjusters, turn the side pieces inside slightly and reverse the above procedure.

To put the side piece adjuster back, press **A** to the illustrated direction until it “clicks” into place.

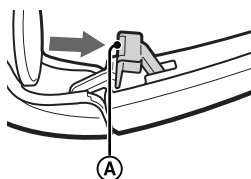

continued

Wearing the Glasstron (continued)

For increased comfort while wearing Glasstron

If the Glasstron fit is loose or uncomfortable, place the supplied side piece pads onto the tip of each side piece.

Note

Use the side piece pads pocket-side inward.

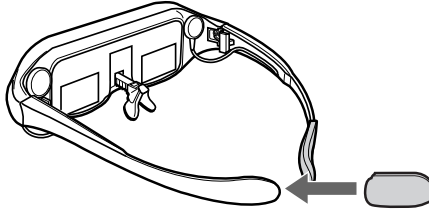

4

Wear the stereo earphones.

Detach the stereo earphones from the display unit and put them in your ears.

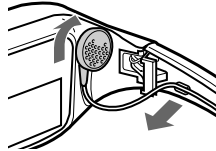

Notes

- If the stereo earphones are loose, we recommend using the spare ear-pads (not supplied).
- If your head is small, you may not be able to use the Glasstron.
- Depending on your eyesight, you may not be able to focus on the picture properly. In such a case, it is not a malfunction.

Using the Glasstron

If you set the user lock, unlock it (page 23).

Before you start...

Be sure to follow the procedures in "Connecting the Glasstron" (pages 12 - 15) and "Wearing the Glasstron" (pages 16 - 18).

WARNING

Each time this product is used, adjustment screens will appear, requiring the viewer to properly fit the product. To prevent eye damage, do not use this product if the vertical lines do not cross the horizontal line on the next screen.

The Glasstron includes two small (left and right) LCDs. You are watching a combined picture created from these two screens. Although the screen position is properly aligned at the factory, it may become misaligned if the Glasstron is deformed or damaged. Check the screen position alignment every time you turn on the Glasstron. If you cannot have correct screen alignment, stop using the Glasstron immediately.

1

Turn on the Glasstron using the POWER ON/OFF switch.

The POWER lamp lights up.

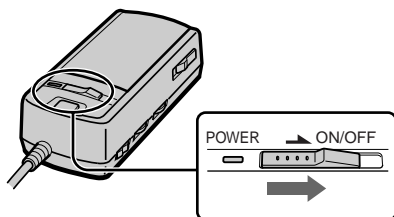

Screen

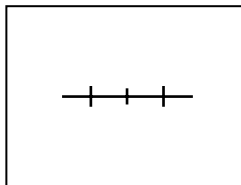

Using the Glasstron (continued)

2

If the screens are aligned, press the START/BATT CHECK button.

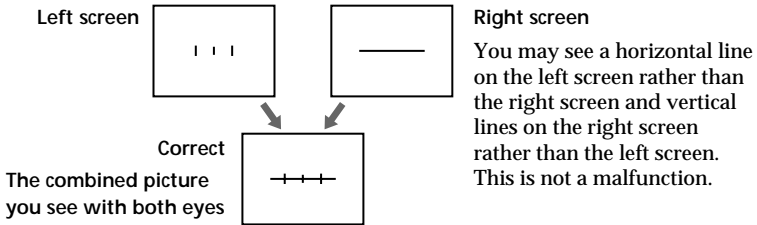

If the image you see matches one of the pictures below, you have correct screen alignment.

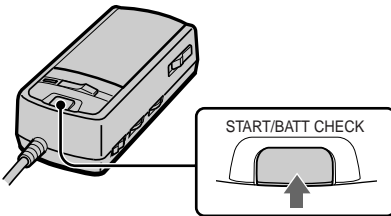
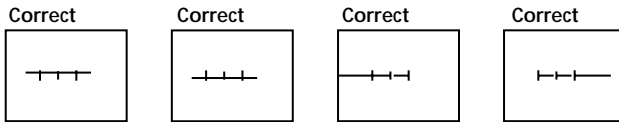

If the image you see matches one of the pictures below, stop using the Glasstron immediately. Use of the Glasstron under such conditions may cause eye fatigue or eye damage.

Incorrect

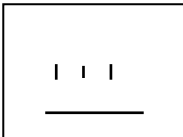

When no vertical lines cross the horizontal line.

Incorrect

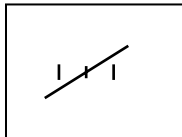

When the horizontal line appears as a diagonal line.

Incorrect

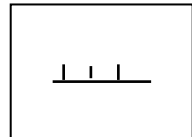

When the center vertical line does not cross the horizontal line.

If you cannot see a proper arrangement of these lines even after resting your eyes for a few hours, the Glasstron may not be operating correctly. Contact your Sony dealer or local authorized Sony service facility.

3 Start playback on the video equipment connected to the Glasstron.

4 Adjust the volume by turning the VOL control.

When you set the AVLS ON/OFF switch to ON, you cannot turn up the volume beyond the defined limit (see page 22).

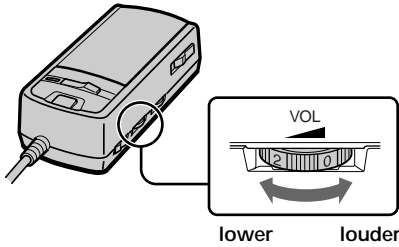

5 Check that the four corners of the screen are clear.

If the four corners of the screen are not clear, do the step 2 (page 20) to check the screen position alignment again.

6 Adjust the brightness by turning the BRIGHT control.

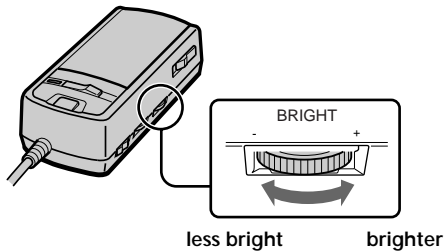

Using the Glasstron (continued)

After you finish using the Glasstron

Take off the Glasstron, and turn off the power.

Note on the LCDs

The LCD screen is made with high-precision technology. However, black points or bright points of light (red, blue, or green) may appear constantly on the LCD screen. This is not a malfunction. (Effective dots: more than 99.99%)

Preventing sound from escaping through the stereo headphones

-- AVLS (Auto Volume Limiter System):

Keeps down the maximum volume to protect your ear. You cannot turn up the volume beyond the defined limit even if you try to turn it up.

Set the AVLS ON/OFF switch to ON.

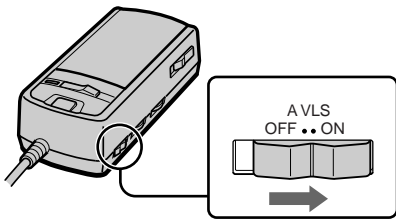

To turn the AVLS off

Set the AVLS ON/OFF switch to OFF.

Screen warnings against overuse of the Glasstron

To prevent eye fatigue or eye damage, after you use the Glasstron for three hours the following caution appears on the screen and the power turns off automatically.

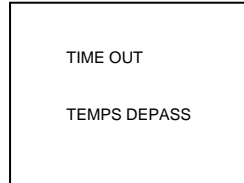

Caution: Motion sickness from viewing programs.

Some viewers may experience motion sickness, headache or nausea from viewing movies or video programs, especially those with intense action and movement. If you feel any of these symptoms, stop using the product immediately. To avoid personal injury or injury to others, do not drive a car or motorcycle, nor do anything that requires concentration until the symptoms disappear.

Caution: Motion sickness from external motion.

Do not use the product while subject to external motion -- for example, as a passenger in a car. Use of this product under these conditions may cause motion sickness.

Setting the user lock

WARNING

This product should not be used by children age 15 or younger. The eyes of children are still developing and may be adversely affected by use of this product. To prevent such use, this product is equipped with the user lock system.

When the user lock is on, audio and video signals are not input and all operations except power on/off are disabled.

To use the Glasstron, unlock the user lock.

1 Set the user lock switch as shown in the illustration.

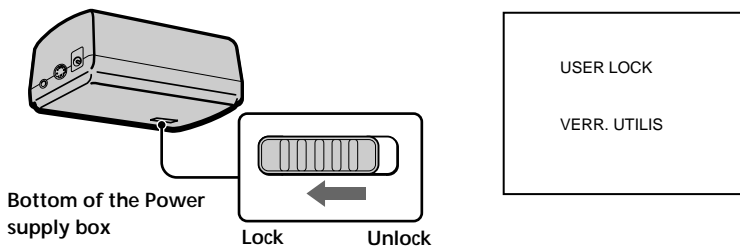

To unlock the user lock

Set the user lock switch to the opposite position.

Using an optional battery pack

If you use a battery pack such as the NP-F550/F750/F950, you can use the Glasstron without connecting to a wall outlet.

Charge the battery pack before use by using the optional battery charger, BC-V615. You cannot charge the battery pack while it is on the unit.

1 Slide the BATT/COVER RELEASE button to remove the cover.

When not using the unit, keep the cover on the power supply box.

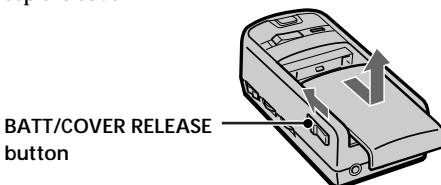

2 Attach the battery pack to the power supply box.

Install the battery pack properly making sure it is not crooked against the power supply box.

To remove the battery pack, slide and hold the BATT/COVER RELEASE button and pull the battery pack off.

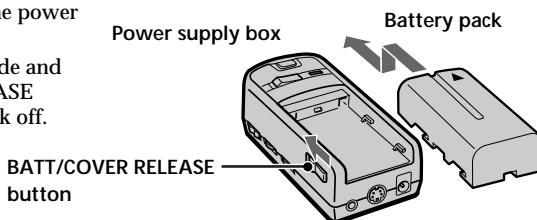

Battery pack	Battery life
NP-F550	Approx. 7 hours

- * The above indications are for fully charged batteries.
- * Actual battery life depends on conditions of use.
- * You can also use a battery pack such as the NP-F530/F730/F750/F930/F950 (not supplied) with the Glasstron.
- * You can use an "InfoLITHIUM™" battery pack with the Glasstron. When using such a battery pack, the estimated remaining battery life is displayed with the indicator instead of the time counter.

Notes

- While using the battery pack, if you connect or disconnect the AC power adaptor, the power turns off. To turn the power on, press the POWER ON/OFF switch again.
- If the POWER lamp flashes while using the battery pack, replace the battery pack with a fresh one.
- Battery life may be shorter in a cold environment. This is a typical battery characteristic.

"InfoLITHIUM" is a trademark of Sony Corporation.

Checking the remaining battery life

When no indication or caution appears on the screen, press the **START/BATT CHECK** button.

The remaining battery life appears and the picture disappears.

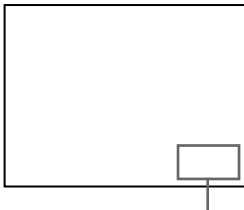
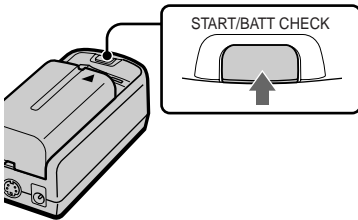

Remaining battery life

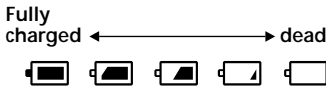

When the battery pack is weak, the following message appears on the screen. Replace the battery pack with a charged one.

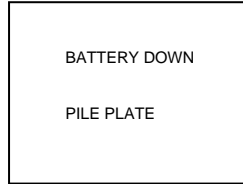

When using the AC power adaptor, the "  " mark appears on the screen.

Precautions

Use

- Operate the product only with the supplied AC power adaptor (AC-PLM2). If you use a different AC power adaptor, it may cause a malfunction.



Unified polarity plug

- Should any liquid or solid object fall into the cabinet, unplug the product and have it checked by qualified personnel before operating it further.
- Always turn the product off when you do not use it.
Unplug the product from the wall outlet if you are not going to use it for several days or more. To disconnect the cord, pull it out by the plug. Never pull the cord itself.
- Do not overload wall outlets, extension cords, or convenience receptacles beyond their capacity, since this can result in fire or electric shock.
- Do not use attachments not recommended by the manufacturer, as they may cause hazards.
- Avoid using earphones at high volume. Hearing experts advise against continuous, loud, and extended play. If you experience a ringing in your ears, reduce volume or discontinue use.
- Do not touch the AC power adaptor or power supply box with wet hands. If you fail to observe this, it may cause electric shock.
- Do not drop or give a mechanical shock to the product.

Installation

- To prevent internal heat buildup, do not block the ventilation openings.
- Avoid operating the product at temperatures below 5°C (41°F).
- Do not subject the product to high temperature or direct sunlight. If you do not observe the above instructions, the product may become deformed and the screens may become impossible to align. If you keep watching misaligned screens, you may develop eye fatigue. Follow the instructions in “Using the Glasstron” (pages 19 - 22), to be sure the screens are aligned. If you find the screens misaligned, have the product repaired at your Sony dealer or local authorized Sony service facility.
- Do not place the product in locations where it is wet, humid, dusty, smoky, or steamy. Do not use this product near or around water. It may cause fire or electric shock. Especially, do not use the product in the bathroom.
- If the product is transported directly from a cold to a warm location, or if the room temperature has changed suddenly, the picture may be blurred or show poor color. This is because moisture has condensed on the lenses inside. If this happens, let the moisture evaporate before using the product.
- Do not place the product on an unstable cart, stand, table, or shelf. The product may fall, causing serious injury to a child or an adult, and serious damage to the product.
- Do not allow anything to rest on or roll over the power cord, and do not place the product where the power cord is subject to wear or abuse.

Others

- Unplug the product from the wall outlet and refer servicing to qualified service personnel under the following conditions:
 - When the power cord or plug is damaged or frayed.
 - If liquid has been spilled into the product.

- If the product has been exposed to rain or water.
- If the product has been subject to excessive shock by being dropped, or the cabinet has been damaged.
- If the product does not operate normally when following the operating instructions. Adjust only those controls that are specified in the operating instructions. Improper adjustment of other controls may result in damage and will often require extensive work by a qualified technician to restore the product to normal operation.
- When the product exhibits a distinct change in performance -- this indicates a need for service.
- Do not disassemble or modify the product. It may cause fire or electric shock. Have the product checked and repaired at your Sony dealer or local authorized Sony service facility.
- Do not attempt to service the product yourself since opening the cabinet may expose you to dangerous voltage or other hazards. Refer all servicing to qualified service personnel.
- When replacement parts are required, be sure the service technician certifies in writing that he has used replacement parts specified by the manufacturer that have the same characteristics as the original parts. Unauthorized substitutions may result in fire, electric shock, or other hazards.
- Upon completion of any service or repairs to the product, ask the service technician to perform routine safety checks (as specified by the manufacturer) to determine that the product is in safe operating condition, and to so certify.
- Unplug the product from the wall outlet before cleaning. Clean the product gently with a dry, soft cloth, or a soft cloth slightly moistened with a mild detergent solution. Do not use any type of solvent, such as alcohol or benzene.

If the nose piece is disconnected

Reinsert the nose piece to its position.

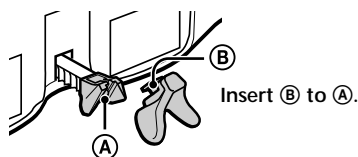

If the side pieces are disconnected

You can reattach the side piece.

Insert the side piece to the inner side of the display unit. Gently push until it clicks into position.

However, reattaching the side pieces may cause a malfunction. Be careful not to reattach them too often.

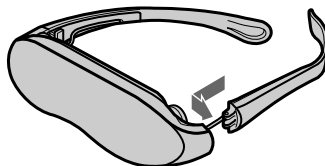

Window coating

To avoid reflection, the windows are coated. Do not place the product in locations subject to sudden temperature changes, or where it is excessively hot (above 60°C/96°F). For example, inside a car parked in direct sunlight.

The coating may develop cracks.

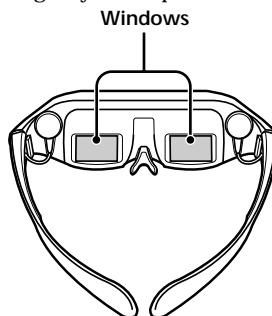

Troubleshooting

If you have any questions or problems not listed below, contact your Sony dealer or local authorized Sony service facility.

Symptom	Cause	Remedy
The playback picture does not appear.	Connections are incorrect.	Connect the equipment correctly (pages 12 - 15).
	The user lock is set.	Unlock the user lock (page 23).
The picture is dark or dim.	You are not wearing the Glasstron correctly.	Put on the Glasstron correctly (pages 16 - 18).
Horizontal stripes appear.	—	Adjust the brightness (page 21).
	The window (where the picture is displayed) is dirty.	Clean the display unit with a soft, dry cloth (page 27).
The picture suddenly disappears.	You continued using the Glasstron for three hours. (The Glasstron turns off automatically after three hours to prevent eye fatigue.)	—
	The battery pack is dead.	Replace the battery pack (page 24).
Picture and/or sound has noise.	The plugs of the audio/video cable are dirty.	Clean the plugs of the audio/video cable.
The picture has no sound.	—	Adjust the volume with the VOL control (page 21).
The sound is noisy.	—	—
The volume does not become louder.	The AVLS function is on.	Set the AVLS ON/OFF switch to OFF (page 22).
The battery pack discharges quickly.	The battery pack is not charged enough.	Charge the battery pack fully or use a new one (page 24).
	The battery pack is completely dead.	—
The black, red, and green dots do not disappear.	The LCD is made with high-precision technology. However, black points or bright points of light (red, blue, or green) may appear constantly on the LCD screen. This is not malfunction. (Effective dots: more than 99.99%)	—
The POWER ON/OFF switch does not function.	—	Disconnect the AC power cord from the wall outlet. After three minutes, reconnect the AC power cord.

Specifications

Power supply

AC power adaptor: AC-PLM2
100-240 V AC, 50/60 Hz, 16 W
Output voltage 9 V, 1.3 A

Battery pack: NP-F550/F730/F750/F930/
F950 (not supplied)

Power consumption

1.7 W Approx.

Operating temperature

5°C to 35°C (41°F to 95°F)

Storage temperature

-10°C to 60°C (14°F to 140°F)

Dimensions

Display unit:

Approx. 173 × 53 × 56 mm
(Approx. 6 ⁷/₈ × 2 ¹/₈ × 2 ¹/₄ inches)
(w/h/d, folded up)

Power supply box:

Approx. 53 × 39 × 104 mm
(Approx. 2 ¹/₈ × 1 ⁹/₁₆ × 4 ¹/₈ inches)
(w/h/d)
not including projecting parts and
controls

Mass

Display unit: Approx. 95 g (3.4 oz)
Power supply box: Approx. 90 g (3.2 oz)

Video signal

NTSC color, EIA standards

Audio/video input

Special minijack
1 Vp-p, 75 ohms, unbalanced, sync
negative

S video input

4-pin mini DIN
Y: 1 Vp-p, 75 ohms, unbalanced, sync
negative
C: 0.286 Vp-p, 75 ohms, unbalanced, sync
negative

Supplied accessories

AC power adaptor AC-PLM2 (1)
AC power cord (1)
Audio/video cable (special miniplug ↔
phono plug) (3 m) (1)
Audio/video cable (special miniplug ↔
stereo miniplug) (1)
Plug adaptors
(phono jack ↔ phono jack) (3)
Nose piece (gray)(1)
Side piece pads (2)
Operating instructions manual (1)

Design and specifications are subject to
change without notice.

Index

A

Accessories supplied 10
AC power adaptor 15
Adjusting
brightness 21
nose piece 16
side pieces' width 17
volume 21
AVLS 22

B

Battery pack 24

C, D, E, F, G,

Checking the screen position alignment 20
Connection
battery pack 24
power 15
video equipment 12 - 14

H

Health concerns 5, 6

I, J, K, L, M, N, O

Instructions for safe fit 7

P, Q

Precautions 26

R

Remaining battery life 25

S, T

Safety instructions 4 - 8
Screen alignment 20
Stereo earphones 18

U, V

User lock 23

W, X, Y, Z

Warnings for electronic products 8
Wearing the Glasstron 16 - 18

Sony  line <http://www.world.sony.com/>

Printed on recycled paper

Sony Corporation

Printed in Japan

Free Manuals Download Website

<http://myh66.com>

<http://usermanuals.us>

<http://www.somanuals.com>

<http://www.4manuals.cc>

<http://www.manual-lib.com>

<http://www.404manual.com>

<http://www.luxmanual.com>

<http://aubethermostatmanual.com>

Golf course search by state

<http://golfingnear.com>

Email search by domain

<http://emailbydomain.com>

Auto manuals search

<http://auto.somanuals.com>

TV manuals search

<http://tv.somanuals.com>