

Video Cassette Recorder

Operating Instructions

Owner's record

The model and serial numbers are located at the rear of the unit. Record these numbers in the spaces provided below. Refer to them whenever you call upon your Sony dealer regarding this product.

Model No. _____

Serial No. _____



SLV-469

WARNING

To prevent fire or shock hazard, do not expose the unit to rain or moisture.

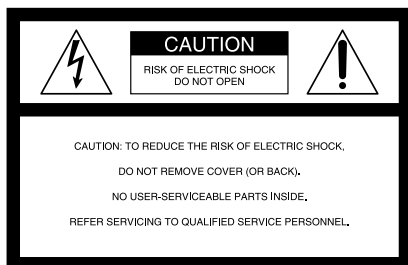

This symbol is intended to alert the user to the presence of uninsulated "dangerous voltage" within the product's enclosure that may be of sufficient magnitude to constitute a risk of electric shock to persons.



This symbol is intended to alert the user to the presence of important operating and maintenance (servicing) instructions in the literature accompanying the appliance.

WARNING

The power cord must be changed only at a qualified service shop.

CAUTION

To prevent electric shock, do not use this polarized AC plug with an extension cord, receptacle or other outlet unless the blades can be fully inserted to prevent blade exposure.

Precautions

Safety

- Operate the unit only on 120 V AC, 60 Hz.
- If anything falls into the cabinet, unplug the unit and have it checked by qualified personnel before operating it any further.
- This unit is not disconnected from the AC power source (mains) as long as it is connected to the wall outlet, even if the unit itself has been turned off.
- Unplug the unit from the wall outlet if you do not intend to use it for an extended period of time. To disconnect the cord, pull it out by the plug, never by the cord.
- One blade of the plug is wider than the other for the purpose of safety and will fit into the power outlet only one way. If you are unable to insert the plug fully into the outlet, contact your Sony dealer.

Installing

- Allow adequate air circulation to prevent internal heat buildup.
- Do not place the unit on surfaces (rugs, blankets, etc.) or near materials (curtains, draperies) that may block the ventilation slots.

- Do not install the unit near heat sources such as radiators or air ducts, or in a place subject to direct sunlight, excessive dust, mechanical vibration or shock.
- Do not install the unit in an inclined position. It is designed to be operated in a horizontal position only.
- Keep the unit and cassettes away from equipment with strong magnets, such as microwave ovens or large loudspeakers.
- Do not place heavy objects on the unit.
- If the unit is brought directly from a cold to a warm location, moisture may condense inside the VCR and cause damage to the video head and tape. When you first install the unit, or when you move it from a cold to a warm location, wait for about three hours before operating the unit.

Information

For customers in the USA

CAUTION

You are cautioned that any changes or modifications not expressly approved in this manual could void your authority to operate this equipment.

NOTE:

This equipment has been tested and found to comply with the limits for a Class B digital device, pursuant to Part 15 of the FCC Rules. These limits are designed to provide reasonable protection against harmful interference in a residential installation. This equipment generates, uses, and can radiate radio frequency energy and, if not installed and used in accordance with the instructions, may cause harmful interference to radio communications. However, there is no guarantee that interference will not occur in a particular installation. If this equipment does cause harmful interference to radio or television reception, which can be determined by turning the equipment off and on, the user is encouraged to try to correct the interference by one or more of the following measures:

- Reorient or relocate the receiving antenna.
- Increase the separation between the equipment and receiver.
- Connect the equipment into an outlet on a circuit different from that to which the receiver is connected.
- Consult the dealer or an experienced radio/TV technician for help.

Caution

Television programs, films, video tapes and other materials may be copyrighted. Unauthorized recording of such material may be contrary to the provisions of the copyright laws. Also, use of this recorder with cable television transmission may require authorization from the cable television transmission and/or program owner.

Table of contents

Getting Started

- 4 Step 1: Unpacking
- 5 Step 2: Setting up the remote commander
- 6 Step 3: Hookups
- 16 Step 4: Setting the clock
- 18 Selecting a language
- 19 Presetting channels

Basic Operations

- 25 Playing a tape
- 28 Recording TV programs
- 31 Recording TV programs using the timer

Additional Operations

- 34 Playing/searching at various speeds
- 35 Searching for a selected point on the tape
- 37 Skip-searching automatically
- 38 Recording TV programs using the quick timer
- 39 Checking/changing/cancelling timer settings
- 41 Adjusting the picture
- 42 Changing menu options
- 43 Editing with another VCR

Additional Information

- 45 General setup information
- 47 Troubleshooting
- 49 Specifications
- 50 Index to parts and controls
- 55 Index
- back cover
- Quick reference to using the VCR

Step 1

Unpacking

Check that you have received the following items with the VCR:

- Remote commander
- 75-ohm coaxial cable with F-type connectors

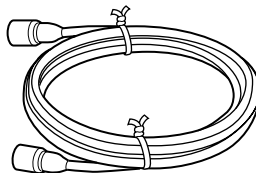
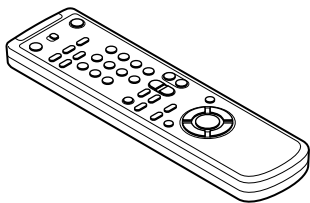

- Size AA (R6) batteries

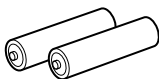

Step 2

Setting up the remote commander

Inserting the batteries

Insert two size AA (R6) batteries by matching the + and - on the batteries to the diagram inside the battery compartment.

Insert the negative (-) end first, then push in and down until the positive (+) end clicks into position.

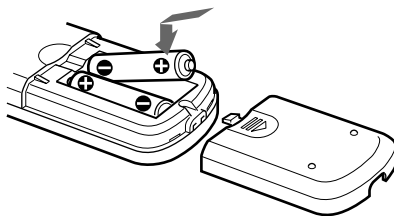

Using the remote commander

You can use this remote commander to operate this VCR and a Sony TV. Buttons on the remote commander marked with a dot (•) can be used to operate your Sony TV.

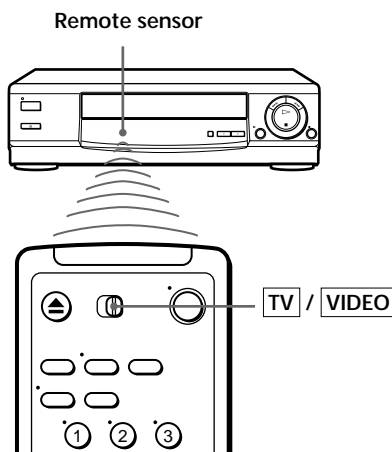

To operate	Set TV / VIDEO to
the VCR	VIDEO and point at the remote sensor on the VCR
a Sony TV	TV and point at the remote sensor on the TV

Notes

- With normal use, the batteries should last about three to six months.
- If you do not use the remote commander for an extended period of time, remove the batteries to avoid possible damage from battery leakage.
- Do not use a new battery with an old one.
- Do not use different types of batteries.

Step 3

Hookups

Selecting the best hookup option

There are many ways in which your VCR can be hooked up. To hook up your VCR so that it works best for you, first scan through the table below. Then use the accompanying diagrams and procedures on the following pages to set up your VCR.

If you have	Use	Refer to
TV that has audio/video input	Audio/video (A/V) hookup, then follow one of the hookups below.	Page 7
Antenna only, no cable TV	Hookup 1	Pages 8 and 9
Cable box with many scrambled channels	Hookup 2	Pages 10 and 11
No cable box or cable box with only a few scrambled channels	Hookup 3	Pages 12 and 13
Cable box with only a few scrambled channels, using an A/B switch	Hookup 4	Pages 14 and 15

After you've completed the connections, follow the instructions for setup. During setup, if you need more details on the procedure described, page numbers are provided where you can find complete, step-by-step instructions.

After you've completed the setup, you're ready to use your VCR. Procedures differ depending on the hookup you used. For an overview, refer to "Quick reference to using the VCR" on the back cover.

Before you get started

- Turn off the power to all equipment.
- Do not connect the AC power cords until all of the connections are completed.
- Be sure you make connections firmly. Loose connections may cause picture distortion.
- If your TV doesn't match any of the examples provided, see your nearest Sony dealer or qualified technician.

If your TV has audio/video (A/V) input jacks, you will get a better picture and sound when you hook up your VCR using these connections. If your TV doesn't have A/V inputs, see the following pages for antenna or cable hookups.

If you're not planning to use your VCR to record programs, you're finished setting up the VCR after you've made the connections shown on this page. If you want to record off-air or off your cable TV system, complete these connections first, and then go to the following pages for antenna or cable hookups.

A Use this hookup if your TV has stereo jacks

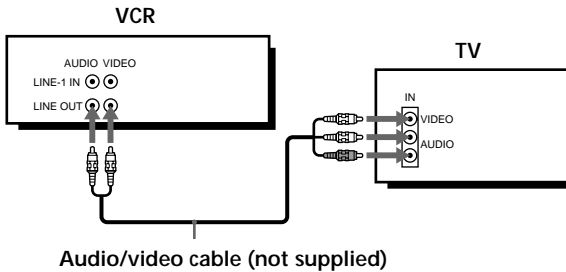

B Use this hookup if your TV doesn't have stereo jacks

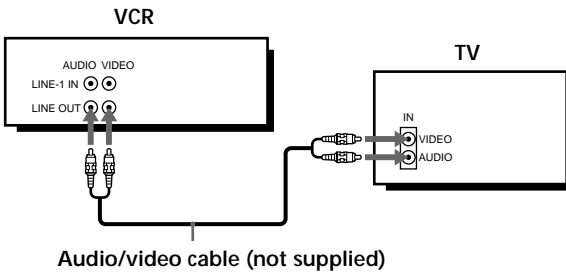

Note

- If you use the Trinitron TV Synchro Play function (see page 27), the A/V connection is necessary. (If your TV has two or more inputs, connect the audio/video cable to the VIDEO IN 1 jacks.)

Note to CATV system installer (in USA)

This reminder is provided to call the CATV system installer's attention to Article 820-40 of the NEC that provides guidelines for proper grounding and, in particular, specifies that the cable ground shall be connected to the grounding system of the building, as close to the point of cable entry as practical.

Antenna hookup

Make the following connections if you're using an antenna (if you don't have cable TV).

A Use this hookup if you're using:

- VHF/UHF antenna (you get channels 2–13 and channels 14 and higher)
- UHF-only antenna (you get channels 14 and higher)
- Separate VHF and UHF antennas

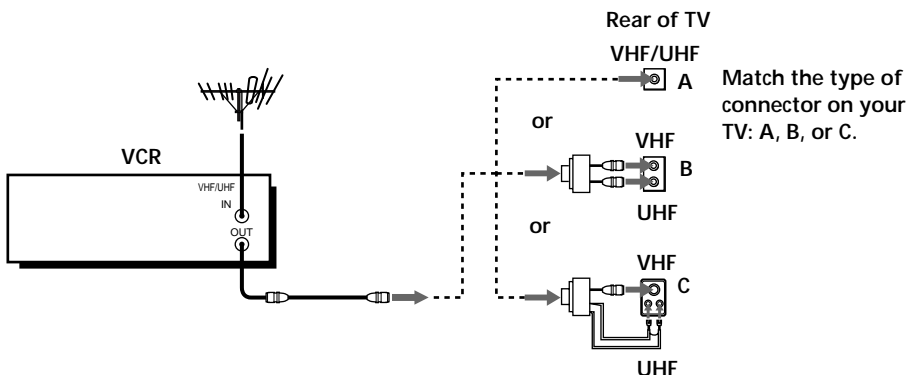

B Use this hookup if you're using a VHF-only antenna (you get channels 2–13 only)

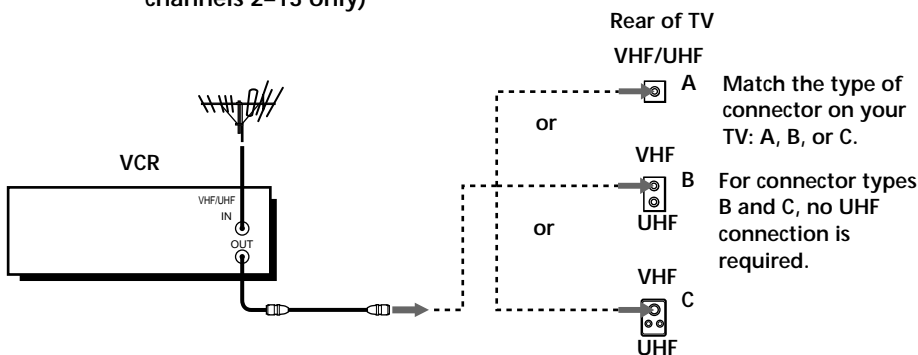

If you cannot connect your antenna cable to the VCR directly

If your antenna cable is a flat cable (300-ohm twin lead cable), attach an external antenna connector (not supplied) so you can connect the cable to the VHF/UHF IN connector. If you have separate cables for VHF and UHF antennas, you should use a U/V band mixer (not supplied). For details, see page 46.

Hookup 1: VCR setup

- 1 Set the RF UNIT switch to CH3 or CH4, whichever channel is not used in your area. If both are used, set the switch to either channel.

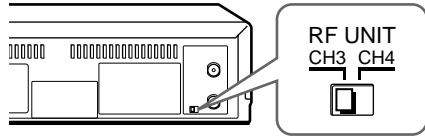

For details, see page 45. If you made A/V connections (page 7), you can skip this step.

- 2 Change the on-screen display language if desired. For details, see page 18.

① Press MENU and select LANGUAGE.

② Select the language, and press OK.

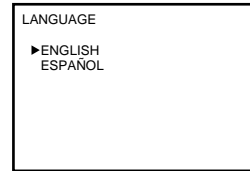

- 3 Press MENU and select TUNER PRESET. Set ANTENNA/CABLE to ANT. For details, see page 19.

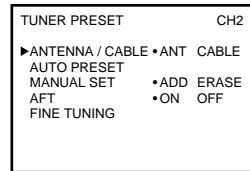

- 4 Preset the channels into the VCR. Select AUTO PRESET and press OK.

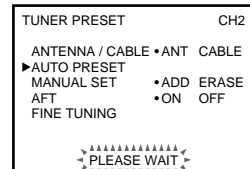

Hookup 2

Cable box with many scrambled channels

Recommended use

Use this hookup if your cable system scrambles all or most channels.

What you can do with this hookup

- Record any channel by selecting the channel on the cable box

What you can't do

- Record one channel while watching another channel

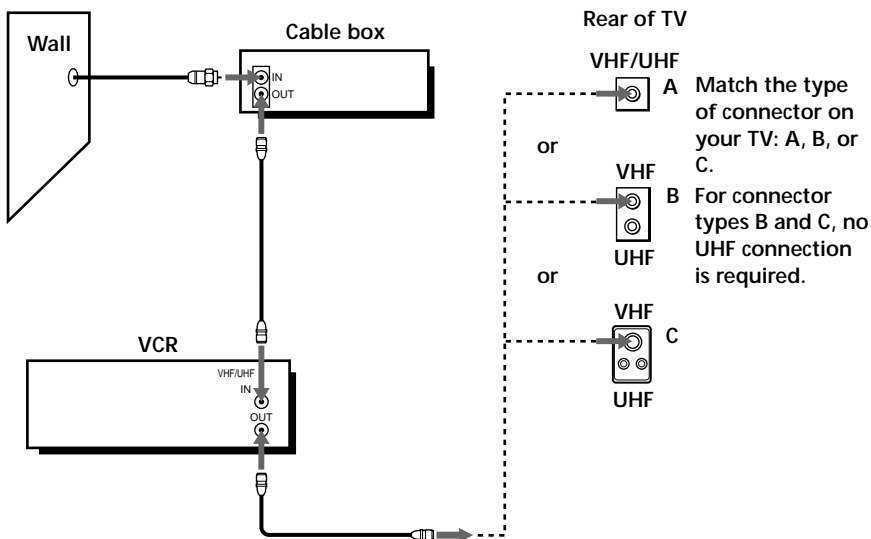

Hookup 2: VCR setup

- 1 Set the RF UNIT switch to CH3 or CH4, whichever channel is not used in your area. If both are used, set the switch to either channel.

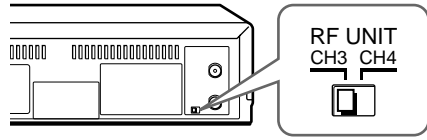

For details, see page 45. If you made A/V connections (page 7), you can skip this step.

- 2 Turn on your cable box.
- 3 Change the on-screen display language if desired. For details, see page 18.

- 1 Press MENU and select LANGUAGE.

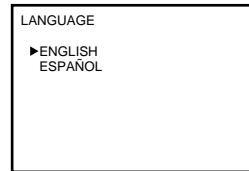

- 2 Select the language, and press OK.

- 4 Press MENU and select TUNER PRESET. Set ANTENNA/CABLE to ANT. For details, see page 19.

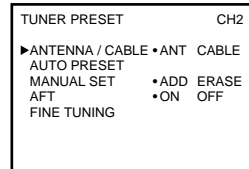

- 5 Preset the channels into the VCR. Select AUTO PRESET and press OK.

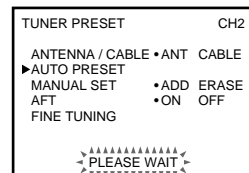

No cable box, or cable box with only a few scrambled channels

Recommended use

Use this hookup if you do not have a cable box. Also use this hookup if your cable system scrambles only a few channels.

What you can do with this hookup

- Record any unscrambled channel by selecting the channel on the VCR

What you can't do

- Record scrambled channels that require a cable box

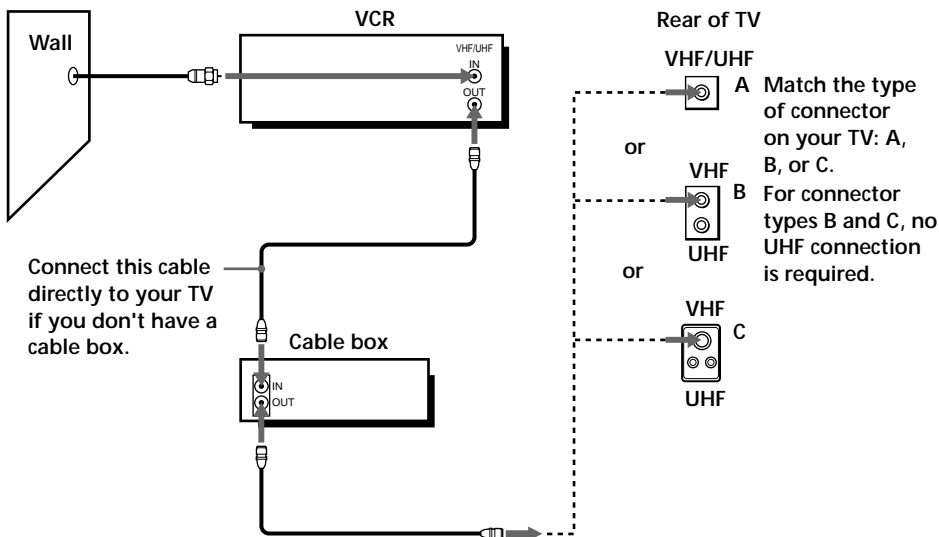

Hookup 3: VCR setup

- 1 Set the RF UNIT switch to CH3 or CH4, whichever channel is not used in your area. If both are used, set the switch to either channel.

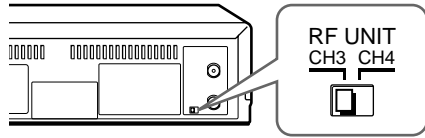

For details, see page 45. If you made A/V connections (page 7), you can skip this step.

- 2 Turn on your cable box.
- 3 Change the on-screen display language if desired. For details, see page 18.

- 1 Press MENU and select LANGUAGE.

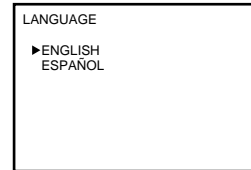

- 2 Select the language, and press OK.

- 4 Press MENU and select TUNER PRESET. Set ANTENNA/CABLE to CABLE. For details, see page 19.

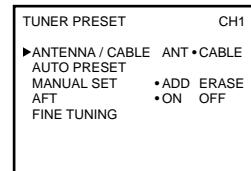

- 5 Preset the channels into the VCR. Select AUTO PRESET and press OK.

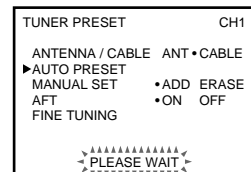

Hookup 4

Pages 14 and 15

Cable box with only a few scrambled channels, using an A/B switch

Recommended use

By using an A/B switch (not supplied), this hookup allows you to record both scrambled and unscrambled channels conveniently.

What you can do with this hookup

- Record any unscrambled channel by selecting the channel directly on the VCR (the A/B switch is set to A)
- Record any scrambled channel by selecting the channel on the cable box (the A/B switch is set to B)

What you can't do

- Record one scrambled channel while watching another channel (the A/B switch is set to B)

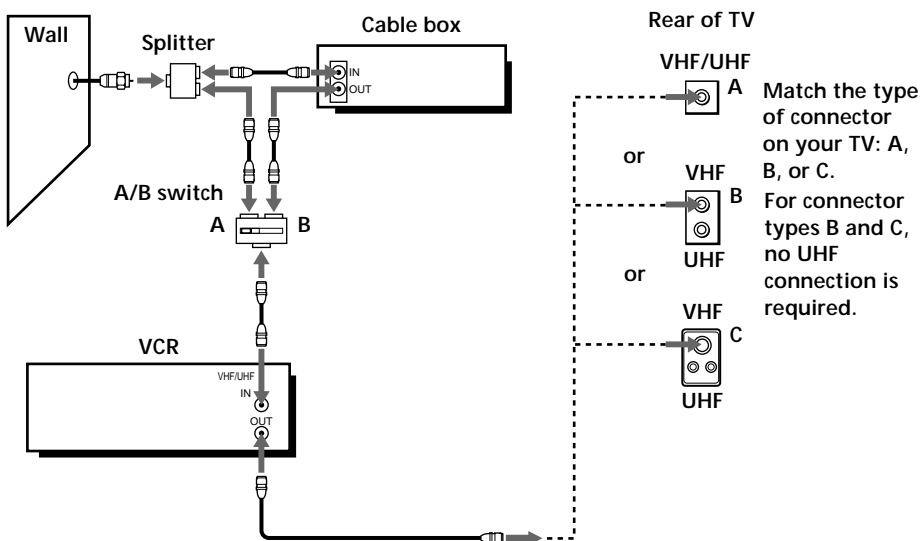

Hookup 4: VCR setup

- 1 Set the RF UNIT switch to CH3 or CH4, whichever channel is not used in your area. If both are used, set the switch to either channel.

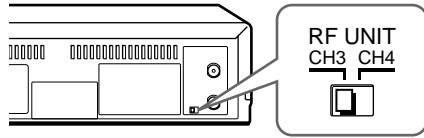

For details, see page 45. If you made A/V connections (page 7), you can skip this step.

- 2 Set the A/B switch to "A."
- 3 Change the on-screen display language if desired. For details, see page 18.

- 1 Press MENU and select LANGUAGE.

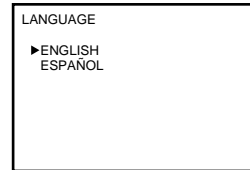

- 2 Select the language, and press OK.

- 4 Press MENU and select TUNER PRESET. Set ANTENNA/CABLE to CABLE. For details, see page 19.

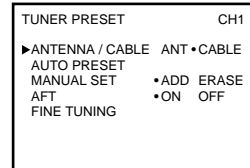

- 5 Preset the unscrambled channels into the VCR. Select AUTO PRESET and press OK.

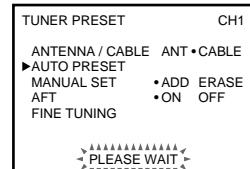

- 6 Preset the cable box output channel (usually 2, 3 or 4). For details, see page 21.

Cable box output channel

- 1 Press MENU and select TUNER PRESET.
- 2 Enter the cable box output channel.
- 3 Set MANUAL SET to ADD and press OK.

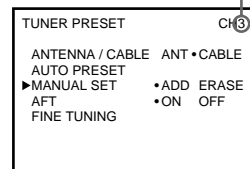

Step 4

Setting the clock

Set the time and date to use the timer feature for recording programs.

Before you start...

- Turn on the VCR and the TV.
- Set the TV to the VCR channel (channel 3 or 4). If your TV is connected to the VCR using A/V connections, set the TV to video input.
- Press TV/VIDEO to display the VIDEO indicator in the VCR's display window.

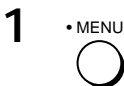
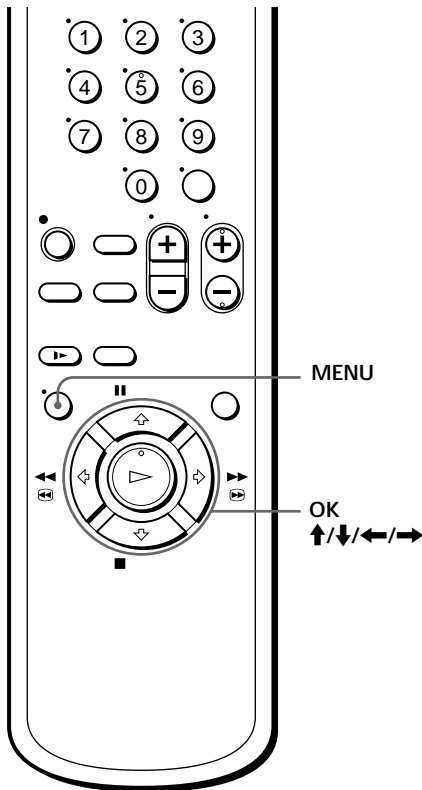

Press MENU, then press **↑/↓** to move the cursor (▶) to CLOCK SET and press OK.

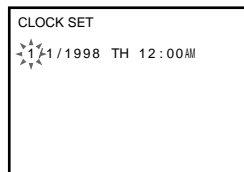

2

Press **↑/↓** to set the month.

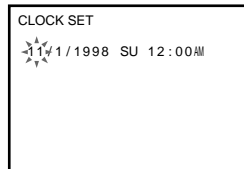



3



Press **→** to flash the day and press **↑/↓** to set the day.

The day of the week is set automatically.

CLOCK SET

11  6  1998 MO 12:00AM

4



Set the year, hour, and minutes in the same way as the day.

5



Press OK to start the clock.

Selecting a language

You can change the on-screen display language.

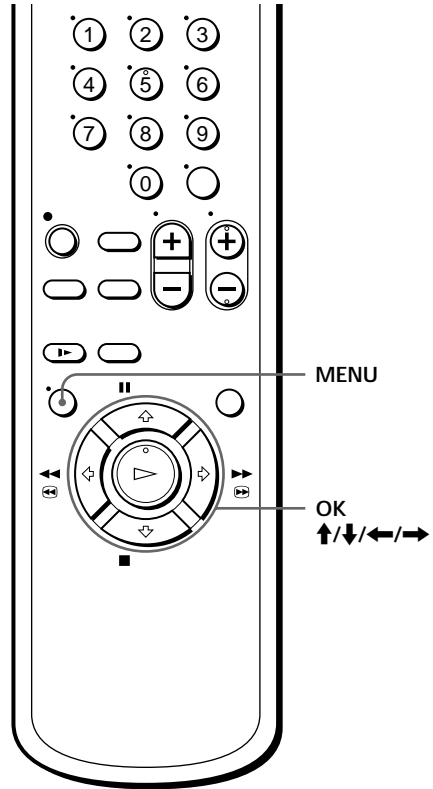

1

•MENU



Press MENU, then press **↑/↓** to move the cursor (▶) to LANGUAGE and press OK.



LANGUAGE

▶ENGLISH
ESPAÑOL

2



Press **↑/↓** to select ENGLISH or ESPAÑOL, then press OK.

Presetting channels



This VCR is capable of receiving VHF channels 2 to 13, UHF channels 14 to 69 and unscrambled CATV channels 1 to 125. First, we recommend that you preset the receivable channels in your area using automatic presetting. Then, if there are any unwanted channels, disable them manually. If you have decided which channels you wish to preset, set them directly using manual presetting.

Before you start...

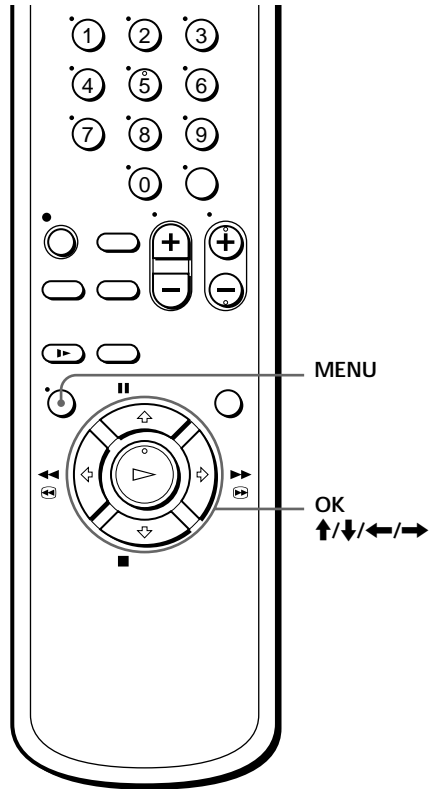
- Turn on the VCR and the TV.
- Set the TV to the VCR channel (channel 3 or 4). If your TV is connected to the VCR using A/V connections, set the TV to video input.
- Press TV/VIDEO to display the VIDEO indicator in the VCR's display window.





Presetting all receivable channels automatically

- 1**  Press MENU, then press  to move the cursor (▶) to TUNER PRESET and press OK.



TUNER PRESET	CH1
ANTENNA / CABLE	ANT • CABLE
AUTO PRESET	
▶ MANUAL SET	• ADD ERASE
AFT	• ON OFF
FINE TUNING	

- 2**  Press  to select ANTENNA/CABLE.



continued

Presetting channels (continued)

3



• To preset cable TV channels:

Press to set ANTENNA/CABLE to CABLE.

TUNER PRESET	CH1
▶ANTENNA / CABLE	ANT •CABLE
AUTO PRESET	
MANUAL SET	•ADD ERASE
AFT	•ON OFF
FINE TUNING	

• To preset VHF and UHF channels:

Press to set ANTENNA/CABLE to ANT.



TUNER PRESET	CH2
▶ANTENNA / CABLE	•ANT CABLE
AUTO PRESET	
MANUAL SET	•ADD ERASE
AFT	•ON OFF
FINE TUNING	

4



Press / to select AUTO PRESET, then press OK.

All receivable channels are preset in numerical sequence. When no more receivable channels can be found, presetting stops and the picture from the lowest numbered channel is displayed on the TV screen.

TUNER PRESET	CH2
▶ANTENNA / CABLE	•ANT CABLE
AUTO PRESET	
MANUAL SET	•ADD ERASE
AFT	•ON OFF
FINE TUNING	

Presetting/disabling channels manually

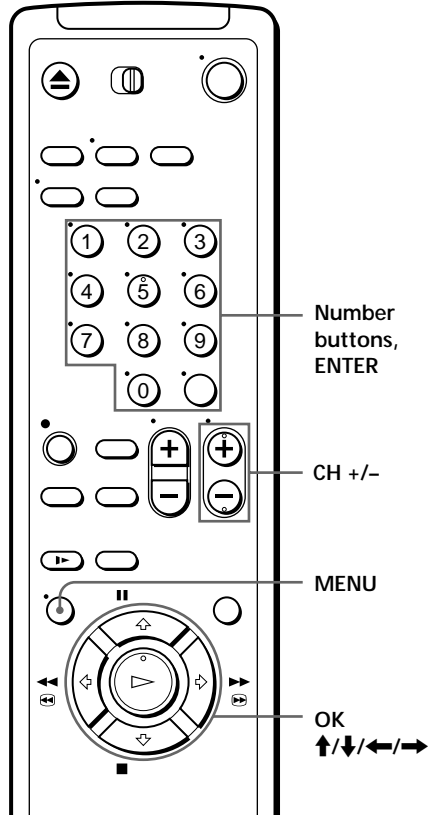

1

• MENU



Press MENU and select TUNER PRESET, then press OK.

TUNER PRESET	CH1
ANTENNA / CABLE	ANT • CABLE
AUTO PRESET	
▶MANUAL SET	•ADD ERASE
AFT	•ON OFF
FINE TUNING	

continued

Presetting channels (continued)

2

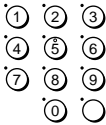

- To preset a channel:

- 1 Press the number buttons to enter the channel number, then press ENTER.
- 2 Press **←→** to set MANUAL SET to ADD.

Channel to be preset

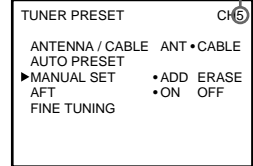

- To disable a channel:



- 1 Press CH +/- to select the channel number.
- 2 Press **←→** to set MANUAL SET to ERASE.

Channel to be disabled

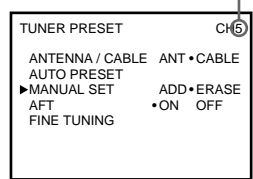

3



- Repeat step 2 to preset or disable channels as required, then press OK.

If the picture is not clear

Normally, the Auto Fine Tuning (AFT) function automatically tunes in channels clearly. If, however, the picture of a channel is not clear, you can also use the manual tuning function.

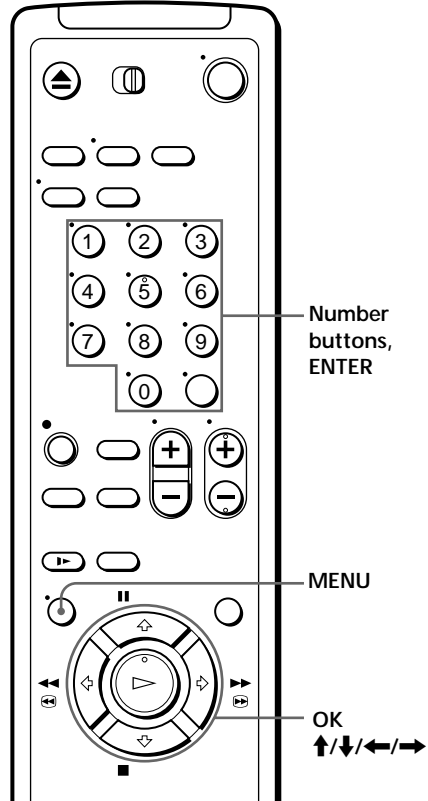

1

• MENU



Press MENU and select TUNER PRESET, then press OK.

TUNER PRESET	CH1
ANTENNA / CABLE	ANT • CABLE
AUTO PRESET	
▶ MANUAL SET	• ADD ERASE
AFT	• ON OFF
FINE TUNING	

2

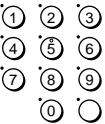

Press the number buttons to select the channel you want to fine-tune, then press ENTER.

Selected channel

TUNER PRESET	CH5
ANTENNA / CABLE	ANT • CABLE
AUTO PRESET	
▶ MANUAL SET	• ADD ERASE
AFT	• ON OFF
FINE TUNING	

continued

Presetting channels (continued)

3



Press **↑/↓** to select FINE TUNING.

The fine tuning meter appears.

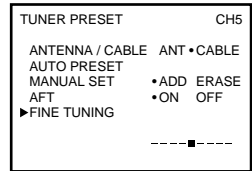

4



Press **←→** to adjust to a clearer picture,
then press OK.

Note that the AFT setting switches to OFF.

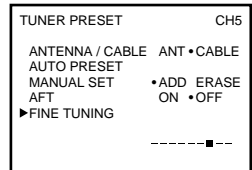

Tip

- To select the channel in step 2 above, you can also use the CH +/- buttons. In this case, you don't need to press ENTER.

Playing a tape

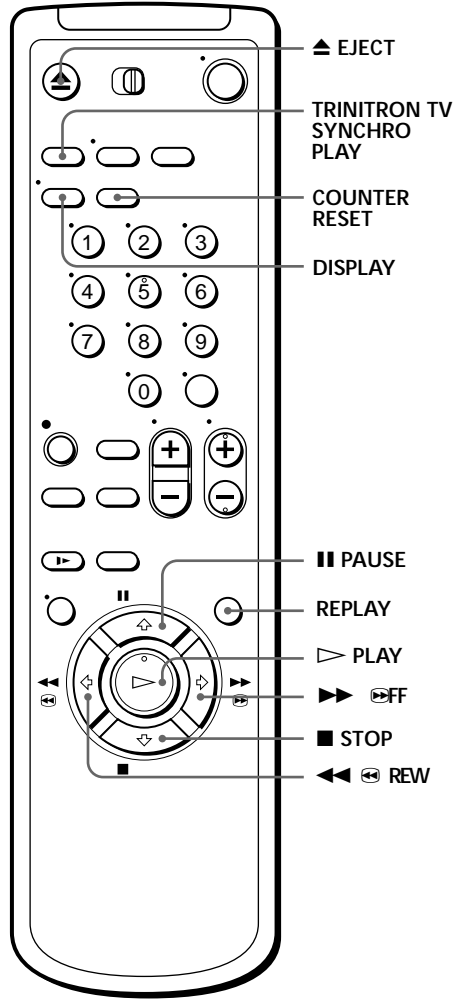

1 Turn on your TV and set it to the video channel.

2 Insert a tape.
The VCR turns on and starts playing automatically if you insert a tape with its safety tab removed.

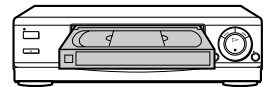

continued

Playing a tape (continued)

3



Press \triangleright PLAY.

When the tape reaches the end, it will rewind automatically.

Additional tasks

To	Press
Stop play	■ STOP
Pause play	PAUSE
Resume play after pause	PAUSE or \triangleright PLAY
Fast-forward the tape	▶▶ ⏩ FF during stop
Rewind the tape	◀◀ ⏪ REW during stop
Eject the tape	▲ EJECT

To play a recently watched scene

You can immediately rewind and playback the scene you want to watch again.

During playback, press REPLAY up to four times. The VCR rewinds the tape about 10 seconds on the counter for each press of the button, and restarts playback.

To use the time counter

At the point on the tape that you want to find later, press COUNTER RESET. The counter in the display window resets to "0:00:00." Search for the point afterwards by referring to the counter.



To display the counter on the TV screen, press DISPLAY repeatedly until the time counter appears. To turn off the display, press DISPLAY twice.

Notes

- Tapes recorded in the LP mode on other VCRs can be played back on this VCR but the picture quality cannot be guaranteed.
- While setting the menu on the TV screen, you cannot use the \triangleright PLAY, || PAUSE, ▶▶ ⏩ FF, ◀◀ ⏪ REW, or ■ STOP buttons.
- The counter resets to "0:00:00" whenever a tape is reinserted.
- The counter stops counting when it comes to a portion with no recording.

Turning on the VCR and TV, and starting playback automatically (Trinitron TV Synchro Play)

You can only use this function if your TV is made by Sony (Trinitron TV).

How to connect to use this function

Connect the VCR and TV with the audio/video cable (see “Audio/video (A/V) hookup” on page 7). Be sure to connect the audio/video cable to the VIDEO IN 1 jacks on the TV if the TV has two inputs or more. The TV must be placed where it will respond to the remote commander while you are pointing it at the VCR.

Operation

Make sure that the TV's power is in standby mode.

Press TRINITRON TV SYNCHRO PLAY and hold the remote commander in place for about two seconds.

The VCR and TV turn on, and the TV is set to the video channel. If there is a tape in the VCR, playback starts automatically.

Notes

- If the Trinitron TV Synchro Play function does not work properly:
 - Wait a few moments, and press the button again.
 - Replace both of the batteries with new ones, and press the button again.Note that this function may not operate some Sony TVs because of the remote commander's signal limitations.
- Do not press TRINITRON TV SYNCHRO PLAY during playback. If you do so, the TV's input source will momentarily switch to the TV's tuner.

Recording TV programs

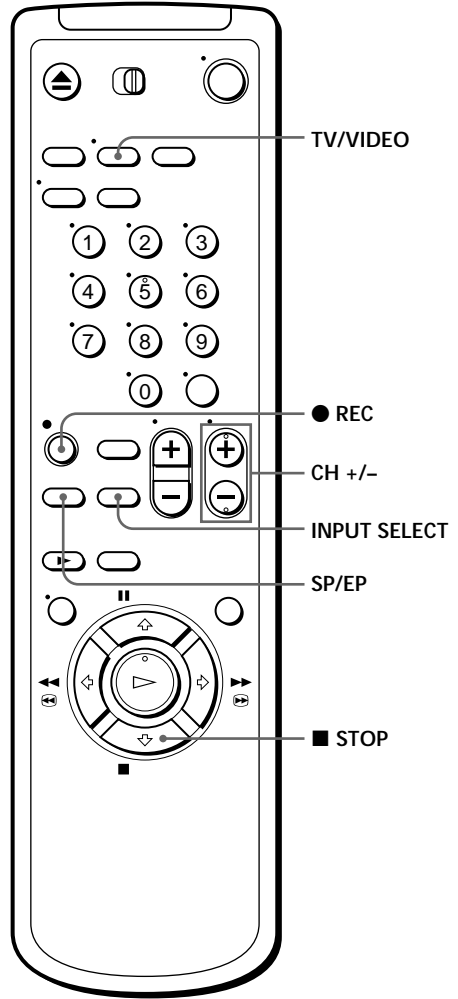

1 Turn on your TV and set it to the video channel.
To record from a cable box, turn it on.

2 Insert a tape with its safety tab in place.

3



Press INPUT SELECT until a channel number appears in the display window.

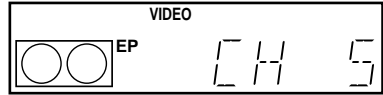

4



Press CH +/- to select the channel you want to record.



5



Press SP/EP to select the tape speed, SP or EP.

EP (Extra Play) provides recording time three times as long as SP (Standard Play), however, SP produces better picture and audio quality.

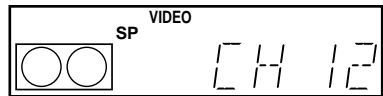

6



Press ● REC to start recording.

The recording indicator lights up red in the display window.

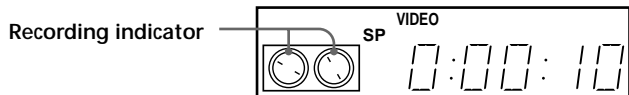

To stop recording

Press ■ STOP.

continued

Recording TV programs (continued)

To watch another TV program while recording

- 1** Press TV/VIDEO to turn off the VIDEO indicator in the display window.
- 2** If the TV is connected to the VCR's LINE OUT jacks, set the TV to TV input; if not, skip this step.
- 3** Select another channel on the TV.

To save a recording

To prevent accidental erasure, break off the safety tab as illustrated. To record on a tape again, cover the tab hole with adhesive tape.

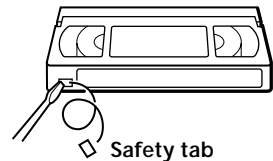

Tips

- To select a channel, you can use the number buttons on the remote commander. Enter the channel number, then press ENTER.
- You can select a video source from the LINE-1 IN jacks using the INPUT SELECT button.
- The display appears on the TV screen indicating information about the tape, but the information won't be recorded on the tape.
- If you don't want to watch TV while recording, you can turn off the TV. When using a cable box, make sure to leave it on.

Note

- The display does not appear during still (pause) mode, search mode or slow-motion playback.

Recording TV programs using the timer

You can preset up to eight programs at a time.

Before you start...

- Check that the VCR clock is set to the correct time.
- Turn on your TV and set it to the video channel. When using a cable box, turn it on.
- Insert a tape with its safety tab in place. Make sure the tape is longer than the total recording time.

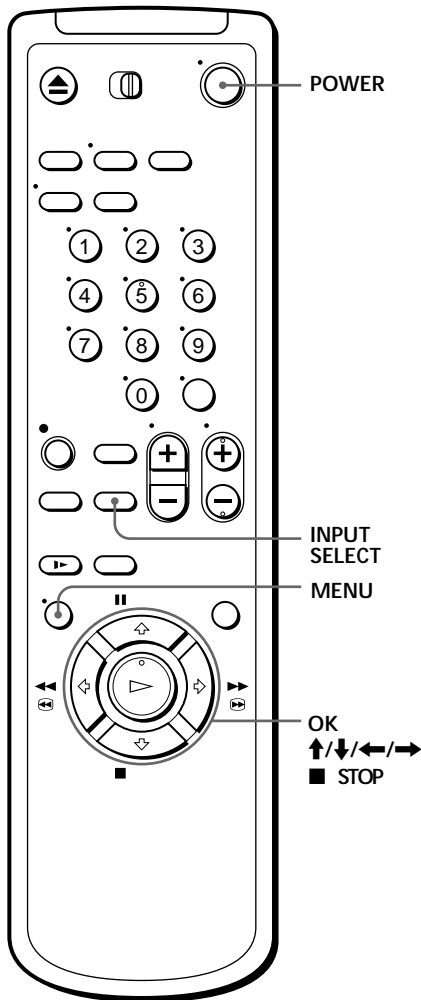

1

• MENU



Press MENU and select **TIMER SET/**
CHECK, then press OK.

TIMER SET /	CHECK	11 / 16	MO
DATE	START	STOP	CH
▶ / - / -	- : - : -	- : - : -	- -
- / - / -	- : - : -	- : - : -	- -
- / - / -	- : - : -	- : - : -	- -
- / - / -	- : - : -	- : - : -	- -
- / - / -	- : - : -	- : - : -	- -
- / - / -	- : - : -	- : - : -	- -
- / - / -	- : - : -	- : - : -	- -

continued

Recording TV programs using the timer (continued)

2



Set the date, start and stop times, channel number and tape speed:

1 Press **→** to flash each item in turn.

2 Press **↑/↓** to set each item.

To correct a setting, press **←** to return to that setting and reset.

TIMER SET / CHECK	11 / 16	MO			
DATE	START	STOP	CH		
11 / 16	MO	---	---	---	EP
---	---	---	---	---	---
---	---	---	---	---	---
---	---	---	---	---	---
---	---	---	---	---	---
---	---	---	---	---	---
---	---	---	---	---	---

To record the same program every day or the same day every week, press **↓** while the date is flashing. For details, see “Daily/weekly recording” on page 33.



To record from a source connected to the LINE-1 IN jacks, press INPUT SELECT to display “L” in the “CH” position.

3



Press **→** to confirm the setting.

The cursor (▶) appears at the beginning of the line. To enter another setting, move the cursor to the next line and repeat step 2.

4



Press OK.

5



Press POWER to turn off the VCR.

The  indicator appears in the display window and the VCR stands by for recording. When using a cable box, leave it on.

To stop recording

To stop the VCR while recording, press **■** STOP.

Daily/weekly recording

In step 2 above, press **↓** to select the recording pattern. Each time you press **↓**, the indication changes as shown below. Press **↑** to change the indication in reverse order.

the current date → SU-SA → MO-SA → MO-FR → EVERY SA →
 → EVERY MO → EVERY SU → 1 month later → (dates count down)
 → the current date



To use the VCR after setting the timer

To use the VCR before a timer recording begins, just press POWER. The ☺ indicator turns off and the VCR switches on. Remember to press POWER to reset the VCR in timer recording standby after using the VCR.

You can also do the following tasks while the VCR is recording:

- Reset the counter.
- Display tape information on the TV screen.
- Check the timer settings.
- Watch another TV program.

To lock the VCR after setting the timer (Child Lock)

While the VCR turns on, hold POWER down on the VCR until "LOC" and the  indicator appear in the display window. The VCR turns off and the  indicator remains lit. The VCR will not work except for timer recording.

To unlock the VCR, hold POWER down on the VCR until the  indicator disappears from the display window. The VCR is unlocked and turns on.

To stop timer recording while the VCR is locked, press **■ STOP**. The recording stops and the VCR is unlocked.

Tips

- To set the channel, you can also use the CH+/- or number buttons.
- To set the tape speed, you can also use the SP/EP button.

Playing/searching at various speeds

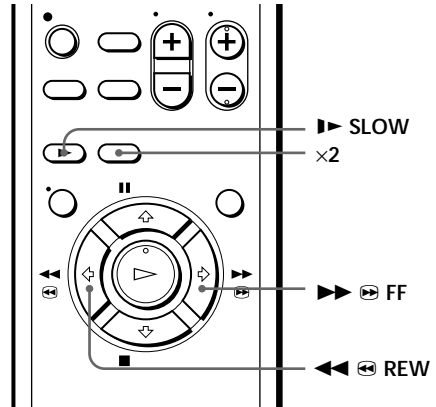
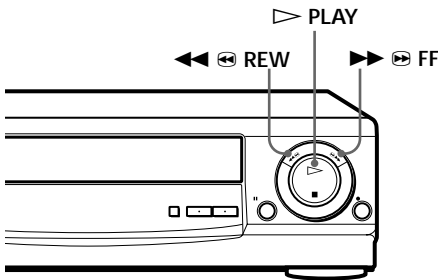

Playback options	Operation
View the picture during fast-forward or rewind	During fast-forward, hold ►► FF down. During rewind, hold ◀◀ REW down.
Play at high speed	<ul style="list-style-type: none"> • During playback, press ►► FF or ◀◀ REW. • During playback, hold ►► FF or ◀◀ REW down. When you release the button, normal playback resumes.
Play at twice the normal speed	During playback, press x2.
Play in slow motion	During playback or pause, press ► SLOW.
Play frame by frame	During pause, press ►► FF or ◀◀ REW. Hold the button down to play one frame each second.
Rewind and start play	During stop, press ► PLAY on the VCR while holding ◀◀ REW down on the VCR.

To resume normal playback

Press ► PLAY.

Tip

- Adjust the picture using the TRACKING +/- buttons on the VCR if:
 - Streaks appear while playing in slow motion.
 - The picture shakes while pausing.
 To set tracking to the center position, press both buttons (+/-) at the same time.
- When you hold ►► FF or ◀◀ REW down during stop, skip-search starts. For details, see page 37.

Notes

- The sound is muted during these operations.
- Tapes recorded in the LP mode on other VCRs can be played back on this VCR but the picture quality cannot be guaranteed.
- The picture may have snow when playing at high speed in reverse.

Searching for a selected point on the tape

You can easily find a selected point by moving the pointer on the TV screen. The VCR fast-forwards or rewinds to the point you indicate and starts playback automatically.

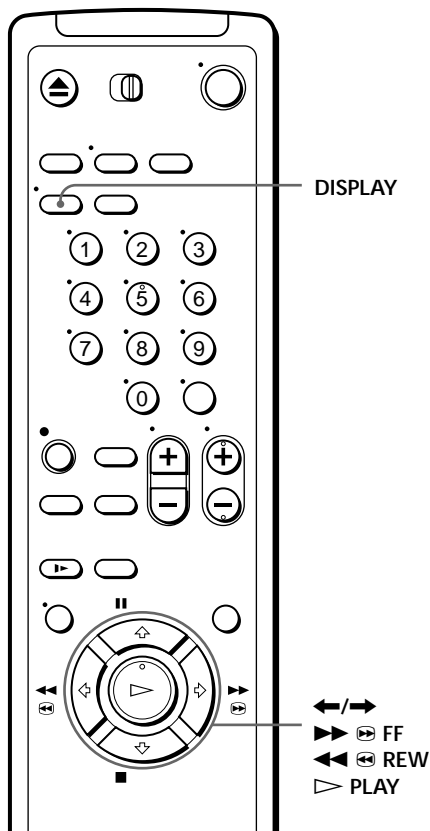

- 1 Press DISPLAY repeatedly until the bar indication appears on the TV screen.
A cursor (■) indicating the current position of the tape appears on the bar indication. If the cursor does not appear, play the tape a few moments (by pressing ▷ PLAY, ►► FF or ◀◀ REW) until the cursor appears.

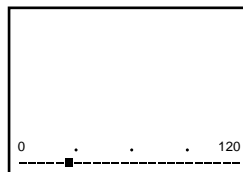

- 2 Press ◀➡ to move the pointer (+) to the point where you want to start playback.
The VCR starts searching and the cursor (■) moves toward the pointer. When the VCR locates the marked point, playback starts.

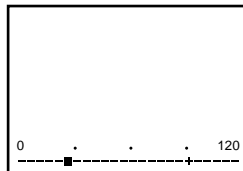

continued

Searching for a selected point on the tape (continued)

To cancel searching

Press ▷ PLAY or ■ STOP.

To turn off the bar indication

Press DISPLAY again.

Notes

- The figure on the bar indication represents the total time length of the inserted tape as shown below.

The total time length may not be displayed correctly for:

- tapes other than T-60, T-120, or T-160
- tapes recorded in more than one tape speed mode.

Tape type	Total time length		
	SP	LP	EP
T-60 or shorter	60	120	180
from T-80 to T-140	120	240	360
T-160 or longer	160	320	480

- If you move the pointer (+) on the bar indication during search, the VCR searches for the new reset point.
- While the cursor (■) is displayed on the bar indication, the ►► Ⓜ FF/➡ and ◀◀ Ⓜ REW/◀ buttons on the remote commander work only for moving the pointer (+), while the ►► Ⓜ FF and ◀◀ Ⓜ REW buttons on the VCR work for normal tape operation. Note, however, if you press these buttons on the VCR, searching is canceled.

Skip-searching automatically

You can spot check a whole tape quickly. At intervals, the VCR skips playback while searching forward or backward.

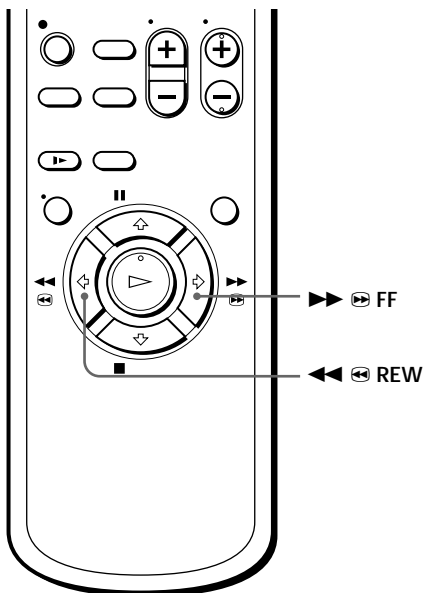

Hold ►►► FF (or ◀◀◀ REW) down more than two seconds during stop. “SKIP” appears on the TV screen.

The VCR searches forward (or backward) for about two minutes on the counter, then fast-forwards (or rewinds) for about ten minutes on the counter. The VCR repeats this operation until it stops at the end (or beginning) of the tape.

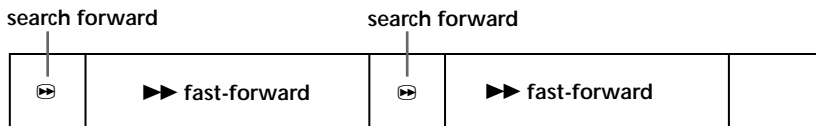
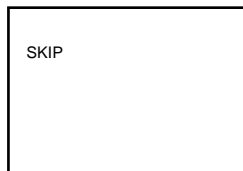

To cancel skip-search

Press ▷ PLAY or ■ STOP.

Note

- The VCR automatically fast-forwards (or rewinds) any portion with no recording.

Recording TV programs using the quick timer

After starting recording in the normal way, you can have the VCR stop recording automatically after a specified duration.

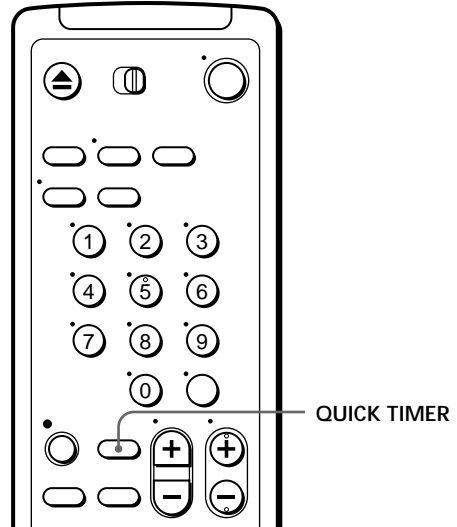

- 1 While recording, press QUICK TIMER once.

The ⏸ indicator appears in the display window.



- 2 Press QUICK TIMER repeatedly to set the duration.

Each press advances the time in increments of 30 minutes.

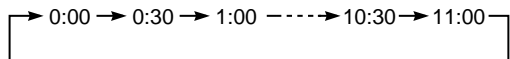

The duration decreases minute by minute to 0:00, then the VCR stops recording and turns off automatically.

To extend the duration

Press QUICK TIMER repeatedly to set to the new duration.

To stop the VCR while recording

Press ■ STOP.

Using the quick timer during stop mode

You can set the quick timer and start recording during stop mode by pressing QUICK TIMER. To set the channel, you can use the CH +/- or INPUT SELECT buttons. Press QUICK TIMER repeatedly to set the recording duration. The recording will start automatically.

Checking/ changing/ canceling timer settings

Before you start...

- Turn on your TV and set it to the video channel.

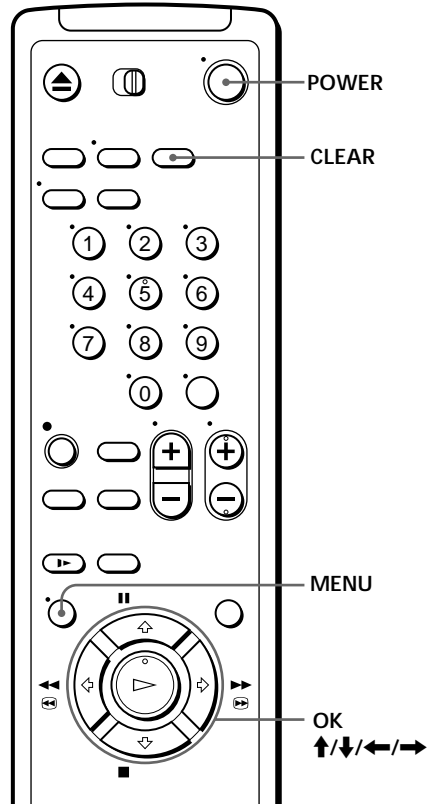

- 1 Press POWER to turn on the VCR.
- 2 Press MENU and select TIMER SET/CHECK:
 - If you want to change a setting, go on to the next step.
 - If you do not need to change the settings, press OK, then turn off the VCR to return to recording standby.
- 3 Press \uparrow/\downarrow to select the setting you want to change or cancel:
 - To change the setting, press \leftarrow/\rightarrow to flash the item you want to change, and press \uparrow/\downarrow to reset it. Then, press \rightarrow repeatedly until the cursor (\blacktriangleright) appears at the beginning of the line.
 - To cancel the setting, press CLEAR.
- 4 Press OK.

TIMER SET / CHECK	11 / 16	MO	
DATE	START	STOP	CH
\blacktriangleright 11 / 17	TU 7 : 00 AM	8 : 00 AM	6 SP
11 / 25	WE 10 : 30 PM	11 : 15 PM	50 EP
MO - SA	1 : 00 PM	3 : 00 PM	LEP
EVERYSU	11 : 55 AM	1 : 30 PM	42 SP
- / - / -	- : - -	- : - -	- -
- / - / -	- : - -	- : - -	- -
- / - / -	- : - -	- : - -	- -
- / - / -	- : - -	- : - -	- -

If any settings remain, turn off the VCR to return to recording standby.

continued

Checking/changing/canceling timer settings (continued)

When the timer settings overlap

The program that starts first has priority and the second program starts recording only after the first program has finished. If the programs start at the same time, the program listed first in the menu has priority.

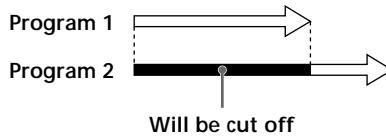

Adjusting the picture

Adjusting the tracking

Although the VCR automatically adjusts the tracking when playing a tape (the  indicator flashes in the display window, then goes off), distortion may occur if the tape was recorded in poor condition. In this case, manually adjust the tracking.

Press the TRACKING +/- buttons on the VCR to display the tracking meter. The distortion should disappear as you press one of the two buttons (the  indicator lights up). To resume automatic tracking adjustment, eject the tape and reinsert it.

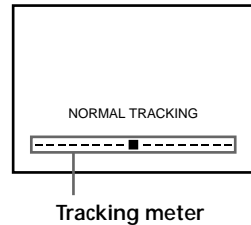

About Adaptive Picture Control (APC)

Adaptive Picture Control (APC) automatically improves recording and playback quality by adjusting the VCR to the condition of the video heads and tape. To maintain better picture quality, we recommend that you set APC to ON in the ADVANCED OPTIONS menu (with the APC indicator in the display window lit).



APC playback

The APC function automatically works on all types of tapes, including rental tapes and tapes that were not recorded with APC.

APC recording

Whenever you insert a tape and start recording at the first time, the VCR adjusts to the tape using the APC function (the APC indicator flashes rapidly). This adjustment is retained until the tape is ejected.

Notes

- The auto tracking adjustment cannot be guaranteed to work with tapes recorded in LP mode on other VCRs.
- With the Auto Tape Speed function on, the APC function does not work if the tape speed is automatically changed from the SP to EP mode during a timer recording, unless the tape has been recorded in the EP mode with the APC function. For details, see page 42.
- There is a delay of a few seconds before the VCR actually starts recording while the VCR analyzes the tape. To avoid the delay, first set the VCR to recording pause (the APC indicator flashes slowly) and press  REC to have the VCR analyze the tape. After the APC indicator stops flashing, press  PAUSE to start recording immediately. If you press  PAUSE before the APC indicator stops flashing, the APC function is canceled.

Changing menu options

- 1 Press MENU and select **ADVANCED OPTIONS**.

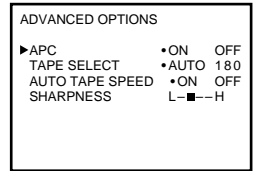

- 2 Press **↑/↓** to select the option to change, then press **←/→** to change the setting.
- 3 Press **OK** to return to the original screen.

Menu choices

Initial settings are indicated in bold print.

Menu option	Set this option to
APC	ON to switch on the APC (Adaptive Picture Control) function and improve picture quality, OFF to switch off APC.
TAPE SELECT	AUTO or 180 (when using a T-140 or T-180 tape) to operate AUTO TAPE SPEED correctly.
AUTO TAPE SPEED	ON to change the timer recording tape speed automatically to the EP mode when the remaining tape becomes shorter than the recording time, OFF to keep the set tape speed.
SHARPNESS	L (Low) through H (High) to adjust the sharpness of the picture. L to turn off the sharpness control.

Editing with another VCR

How to hook up to record on this VCR

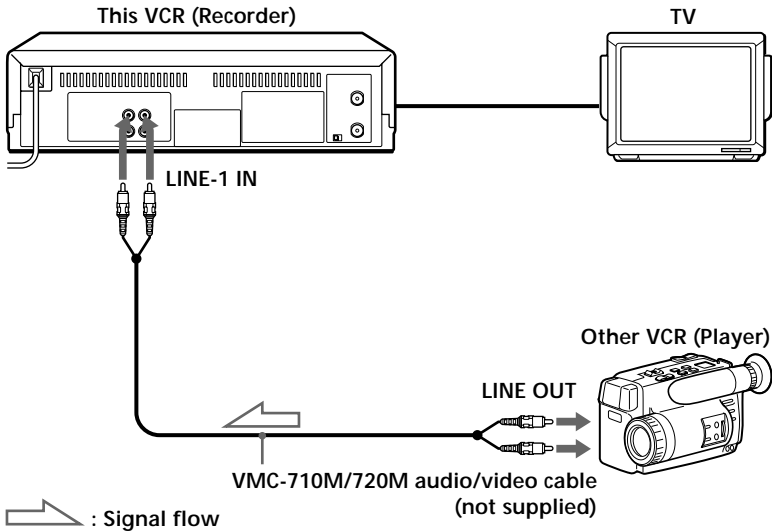

Notes

- Make sure you connect the plugs to jacks of the same color.
- If you connected this VCR to both the LINE IN and LINE OUT jacks of the other VCR, select the input correctly to prevent a humming noise.

continued

Editing with another VCR (continued)

Operation (when recording on this VCR)

Before you start editing

- Turn on your TV and set it to the video channel.
- Press INPUT SELECT on the remote commander to display “L” in the display window.
- Press SP/EP on the remote commander to select the tape speed, SP or EP.

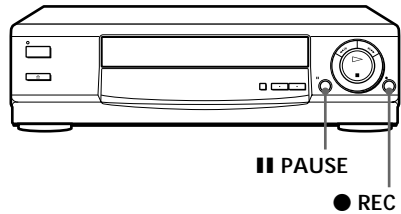

- 1** Insert a source tape with its safety tab removed into the other (playback) VCR. Search for the point to start playback and set it to playback pause.
- 2** Insert a tape with its safety tab in place into this (recording) VCR. Search for the point to start recording and press ■ PAUSE.
- 3** Press ● REC on this VCR and set it to recording pause.
- 4** To start editing, press the ■ PAUSE buttons on both VCRs at the same time.

To stop editing

Press the ■ STOP buttons on both VCRs.

Note

- If you start recording following the procedure above, the VCR won't start recording with the APC function. To record a tape with the APC function, press ● REC again during recording pause in step 3 so that the VCR analyzes the tape. Then when you start recording in step 4, press ■ PAUSE immediately after the APC indicator stops flashing. If you press ■ PAUSE before the APC indicator stops flashing, the APC function is canceled.

General setup information

Setting the RF unit

When connecting the VCR to the TV using only the antenna cable, you must set the RF UNIT switch on the rear of the VCR so that the TV can receive the correct signal from the VCR.

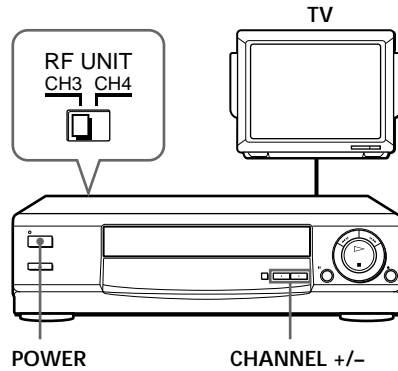

- 1 Set the RF UNIT switch on the rear of the VCR to CH3 or CH4, whichever channel is not used in your area. If both are used, set the switch to either channel.
- 2 Press POWER to turn on the VCR.
- 3 Press TV/VIDEO on the remote commander to turn on the VIDEO indicator in the VCR's display window.
- 4 Press CHANNEL +/- to display a channel number in the display window. Select an active channel number in your area.
- 5 Turn on your TV and set it to the channel you selected in step 1 (channel 3 or 4).

The selected TV channel broadcast appears on the TV screen. If the channels change when you press CHANNEL +/-, you have made the correct setting.

Whenever you use the VCR, set the TV to the channel selected in step 1.

continued

General setup information (continued)

Attaching the external antenna connector

When using a 300-ohm twin lead cable for a VHF/UHF antenna, use the EAC-32 antenna connector (not supplied) to connect the antenna to the VCR.

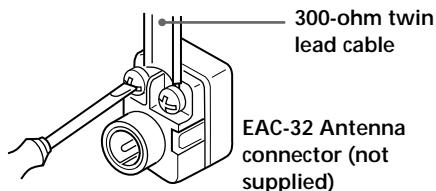

- 1 Loosen the screws on the antenna connector.
- 2 Wind the twin leads around the screws on the antenna connector.
- 3 Retighten the screws.

Attaching a UHF/VHF band mixer

When using both a 75-ohm coaxial cable and a 300-ohm twin lead cable for a VHF/UHF antenna, use the EAC-66 UHF/VHF band separator/mixer (not supplied) to connect the antenna to the VCR.

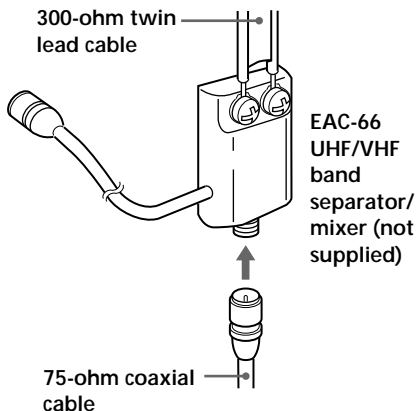

- 1 Loosen the screws on the mixer.
- 2 Wind the twin leads around the screws on the mixer.
- 3 Retighten the screws.
- 4 Connect the 75-ohm coaxial cable to the mixer.

Troubleshooting

If you have any questions or problems not covered below, please consult your nearest Sony dealer.

	Symptom	Remedy
Power	The POWER switch does not function.	<ul style="list-style-type: none"> • Connect the AC power cord securely. • Make sure the VCR is not locked. To unlock, hold down POWER on the VCR until the  indicator disappears.
	The power is turned on but the VCR does not operate.	<ul style="list-style-type: none"> • Moisture condensation occurs. Turn the power off, unplug the AC power cord and leave the VCR to dry for over an hour.
Clock	The clock has stopped and “-:-” lights in the display window.	<ul style="list-style-type: none"> • The clock stops if the VCR is disconnected from the wall outlet for more than one hour. Reset the clock (and timer).
	The playback picture does not appear on the TV screen.	<ul style="list-style-type: none"> • Make sure the TV is set to the channel for the VCR. If you are using a monitor, set it to video input.
Playback	The picture is not clear.	<ul style="list-style-type: none"> • Adjust the tracking with the TRACKING +/- buttons. • The video heads are dirty (see below). Clean the video heads using the Sony T-25CLD, T-25CLDR, or T-25CLW video head cleaning cassette. If these cleaning cassettes are not available in your area, have the heads cleaned at your nearest Sony service facility (a standard service charge will be required). Do not use a liquid-type cleaning cassette other than Sony's, as it may damage the video heads. • The video heads may have to be replaced. Consult your local Sony dealer for more information.
	The picture rolls vertically during picture search.	<ul style="list-style-type: none"> • Adjust the vertical hold control on the TV or monitor.
	The picture has no sound.	<ul style="list-style-type: none"> • The tape is defective. • If you made A/V connections, check the audio cable connection.

Symptoms caused by contaminated video heads

- Normal picture
- Rough picture
- Unclear picture
- No picture (or black & white screen appears)



initial
contamination



terminal

continued

Troubleshooting (continued)

	Symptom	Remedy
Recording	A TV program does not appear on the TV screen.	<ul style="list-style-type: none"> • Make sure the TV is set to the channel for the VCR. If you are using a monitor, set it to video input.
	TV reception is poor.	<ul style="list-style-type: none"> • Adjust the TV antenna.
	The tape starts playing as soon as it is inserted.	<ul style="list-style-type: none"> • The safety tab has been removed. To record on this tape, cover the tab hole.
	The tape ejects when you press ● REC.	<ul style="list-style-type: none"> • Check that the safety tab has not been removed.
Timer recording	Nothing happens when you press ● REC.	<ul style="list-style-type: none"> • Make sure the tape is not at its end. • Select the correct source. Select a channel number with the CH +/- buttons when recording TV programs; select "L" with the INPUT SELECT button when recording from other equipment.
	The timer does not operate.	<ul style="list-style-type: none"> • Check that the clock is set. • Make sure a tape has been inserted. • Check that the safety tab has not been removed. • Make sure the tape is not at its end. • Make sure a program has been set for timer recording. • Make sure your timer settings have not already passed the current time. • Check that the cable box is turned on. • The clock stops if the VCR is disconnected from the wall outlet for more than one hour. Reset the clock and timer.
Others	A tape cannot be inserted.	<ul style="list-style-type: none"> • Check that a tape isn't already in the tape timer compartment.
	The remote commander does not function.	<ul style="list-style-type: none"> • Make sure you are pointing the remote commander at the remote sensor on the VCR. • Replace all the batteries in the remote commander with new ones if they are weak. • Make sure the [TV] / [VIDEO] remote control switch is set correctly.
	The tracking meter does not appear on the screen.	<ul style="list-style-type: none"> • The recording condition of the tape is very poor and tracking cannot be adjusted.
	The VCR needs to be cleaned.	<ul style="list-style-type: none"> • Clean the cabinet, panel and controls with a dry, soft cloth, or a soft cloth slightly moistened with a mild detergent solution. Do not use any type of solvent, such as alcohol or benzene.

Specifications

System

Format

VHS NTSC standard

Video recording system

Rotary head helical scanning FM system

Video heads

Double azimuth four heads

Video signal

NTSC color, EIA standards

Tape speed

SP: 33.35 mm/s (1 ⁵/₁₆ inches/s)

EP: 11.11 mm/s (⁷/₁₆ inches/s)

LP: 16.67 mm/s (²¹/₃₂ inches/s),
playback only

Maximum recording/playback time

9 hrs. in EP mode (with T-180 tape)

Fast-forward and rewind time

Approx. 3 min. (with T-120 tape)

Tuner section

Channel coverage

VHF 2 to 13

UHF 14 to 69

CATV A-8 to A-1, A to W, W+1 to W+84

Antenna

75-ohm antenna terminal for VHF/UHF

Inputs and outputs

LINE-1 IN

VIDEO IN, phono jack (1)

Input signal: 1 Vp-p, 75 ohms, unbalanced,
sync negative

AUDIO IN, phono jack (1)

Input level: 327 mVrms

Input impedance: more than 47 kilohms

LINE OUT

VIDEO OUT, phono jack (1)

Output signal: 1 Vp-p, 75 ohms, unbalanced,
sync negative

AUDIO OUT, phono jack (1)

Standard output: 327 mVrms

Load impedance: 47 kilohms

Output impedance: less than 10 kilohms

Timer section

Clock

Quartz locked

Timer indication

12-hour cycle

Timer setting

8 programs per month (max.)

Power back-up

Built-in self-charging capacitor

Back-up duration: up to 1 hour at a time

General

Power requirements

120 V AC, 60 Hz

Power consumption

23 W

Operating temperature

5°C to 40°C (41°F to 104°F)

Storage temperature

-20°C to 60°C (-4°F to 140°F)

Dimensions

Approx. 355 × 96 × 285 mm

(14 × 3 ⁷/₈ × 11 ¹/₄ inches) (w/h/d)

including projecting parts and controls

Mass

Approx. 3.7 kg (8 lb 03 oz)

Supplied accessories

Remote commander (1)

Size AA (R6) batteries (2)

75-ohm coaxial cable with F-type connectors (1)

Design and specifications are subject to change
without notice.

Index to parts and controls

Refer to the pages indicated in parentheses () for details.

Front panel

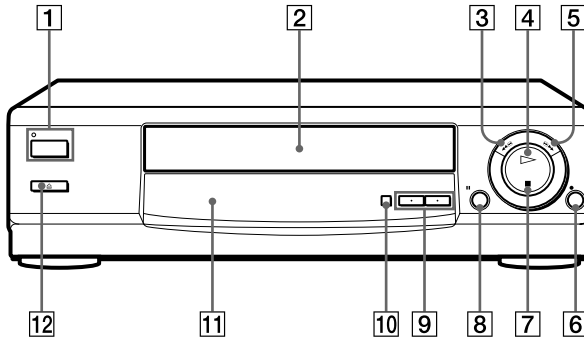

- | | |
|---|--|
| 1 POWER switch/indicator (32) | 7 ■ STOP button (26) |
| 2 Tape compartment | 8 PAUSE button (26) |
| 3 ◀◀ ⏪ REW (rewind) button (26, 34) | 9 CHANNEL/TRACKING +/- buttons (34, 41) |
| 4 ▷ PLAY button (26) | 10 REPLAY button (26) |
| 5 ▶▶ ⏩ FF (fast-forward) button (26, 34) | 11 Remote sensor (5) |
| 6 ● REC (record) button (29) | 12 ▲ EJECT button (26) |

Display window

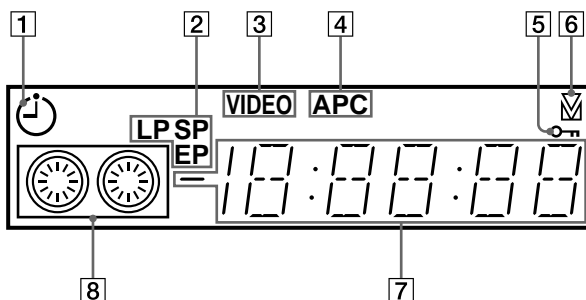

- | | | | |
|---|---|---|--|
| 1 | Timer indicator (32) | 5 | Child Lock indicator (33) |
| 2 | Tape speed indicator (29) | 6 | Tracking indicator (41) |
| 3 | VIDEO indicator (30, 45) | 7 | Time counter/clock/line/channel indicator (26, 29, 44) |
| 4 | APC (Adaptive Picture Control) indicator (41) | 8 | Tape/recording indicator (29) |

continued

Index to parts and controls (continued)

Rear panel

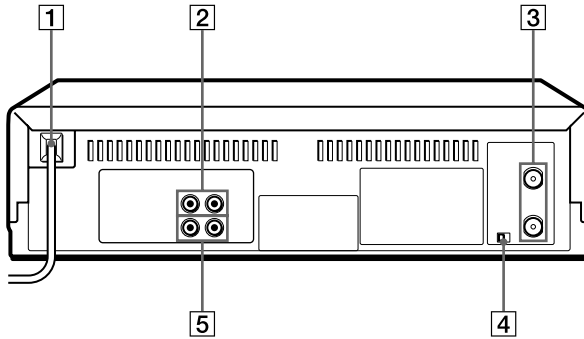

- | | |
|--|--|
| 1 AC power cord (6) | 4 RF (Radio Frequency) UNIT switch (45) |
| 2 LINE-1 IN AUDIO/VIDEO jacks (43) | 5 LINE OUT AUDIO/VIDEO jacks (7) |
| 3 VHF/UHF IN/OUT connectors (8, 10, 12, 14) | |

Remote commander

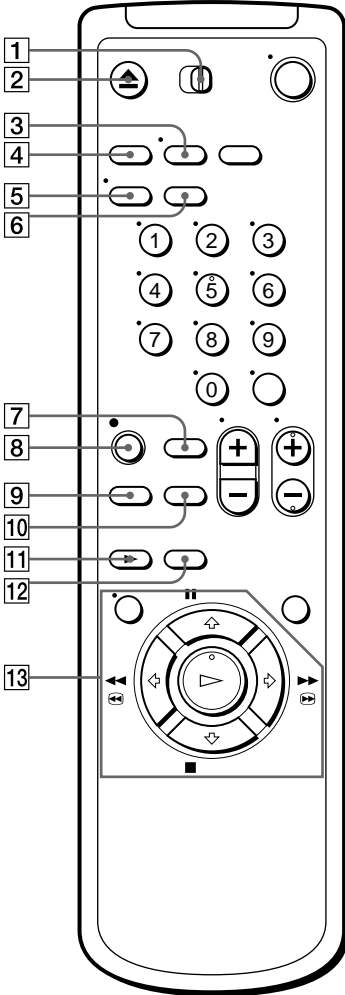

1 TV/ VIDEO remote control switch (5)

2 ▲ EJECT button (26)

3 TV/VIDEO button (30, 45)

4 TRINITRON TV SYNCHRO PLAY button (27)

5 DISPLAY button (26, 35)

6 COUNTER RESET button (26)

7 QUICK TIMER button (38)

8 ● REC (record) button (29)

9 SP (Standard Play)/EP (Extra Play) button (29)

10 INPUT SELECT button (29, 32)

11 ► SLOW button (34)

12 ×2 button (34)

13 Tape/menu operation buttons

MENU button (16, 42)

▬ PAUSE/▲ button (26)

■ STOP/▼ button (26)

◀◀ REW (rewind) ◻/◀ button (26, 34)

▶▶ FF (fast-forward) ◻/▶ button (26, 34)

▷ PLAY/OK button (26)

continued

Index to parts and controls (continued)

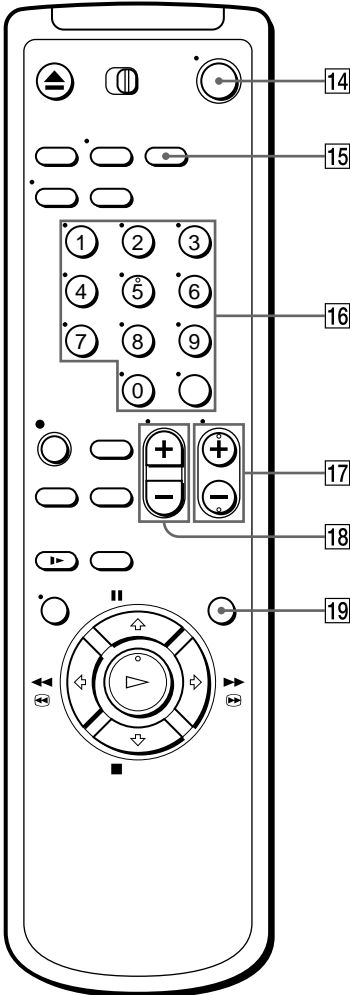

- 14 POWER switch (32)
- 15 CLEAR button (39)
- 16 Channel number buttons and ENTER button (30)
- 17 CH (channel) +/- buttons (29)
- 18 VOL (volume) +/- buttons
- 19 REPLAY button (26)

Index

A, B

AFT (Auto Fine Tuning) 23
Antenna hookup 8
APC (Adaptive Picture Control) 41
Audio/video (A/V) hookup 7

C

Cable hookup 10, 12, 14
Canceling timer settings 39
Changing timer settings 39
Checking timer settings 39
Child Lock 33
Cleaning the video heads 47
Clock setting 16
Connecting
 cable TV 10, 12, 14
 external antenna connector 46
 UHF/VHF band mixer 46
Counter 26

D

Disabling channels 21
Dubbing. *See* Editing.

E, F, G, H, I, J, K

Editing 43
EP mode 29

L, M, N, O

Language selecting 18
Locking the VCR 33
LP mode 26

P

Picture adjustment 23, 34, 41
Playback 25
 at various speeds 34
 frame-by-frame 34
 slow motion 34
Presetting channels 19

Q

Quick timer 38

R

Recording 28
 saving 30
 while watching another program 30

S

Safety tab 30
Searching
 at various speeds 34
 for a selected point 35
 skip-search 37
SP mode 29

T, U, V, W, X, Y, Z

Timer recording 31
 canceling timer settings 39
 changing timer settings 39
 checking timer settings 39
 daily/weekly recording 33
 overlapping timer recordings 40
Tracking adjustment 34, 41
Trinitron TV Synchro Play 27

Quick reference to using the VCR

Hookup 1

To play a tape

- 1 Set the TV to channel 3 or 4 (or to video input, if you made A/V connections.)
- 2 Insert a tape and press PLAY. If there's no picture on your TV, press the VCR's TV/VIDEO button until the VIDEO indicator comes on in the display window.

To record a program

- 1 Press MENU and select TIMER SET/CHECK.
- 2 Set the date, time, channel, and tape speed.
- 3 Press OK.
- 4 Insert a tape.
- 5 Press POWER to turn off the VCR.

To watch TV

- 1 Turn off the VCR, or press the VCR's TV/VIDEO button until the VIDEO indicator in the display window goes off.
- 2 Set the TV to the channel you want to watch.

Hookup 2

To play a tape

- 1 Set the TV to channel 3 or 4 (or to video input, if you made A/V connections.)
- 2 Insert a tape and press PLAY. If there's no picture on your TV, press the VCR's TV/VIDEO button until the VIDEO indicator comes on in the display window.

To record a program

- 1 Turn on the cable box.
- 2 Set the cable box to the channel you want to record.
- 3 Press MENU and select TIMER SET/CHECK.
- 4 Set the date, time, channel, and tape speed.
- 5 Press OK.
- 6 Insert a tape.
- 7 Press POWER to turn off the VCR.
Leave the cable box on.

To watch TV

- 1 Turn off your VCR, or press the VCR's TV/VIDEO button until the VIDEO indicator in the display window goes off.
- 2 Turn on your cable box.
- 3 Set the TV to the cable box output channel (usually 2, 3, or 4).
- 4 Set the cable box to the channel you want to watch.

Hookup 3

To play a tape

- 1 If you made A/V connections, set the TV to video input.
If you didn't use A/V hookup:
 - Turn on the cable box.
 - Set the cable box to channel 3 or 4.
 - Set the TV to the output channel of the cable box (usually 2, 3 or 4).
- 2 Insert a tape and press PLAY.

To record a program

- 1 Press MENU and select TIMER SET/CHECK.
- 2 Set the date, time, channel, and tape speed.
- 3 Press OK.
- 4 Insert a tape.
- 5 Press POWER to turn off the VCR.

To watch TV

- 1 Turn off your VCR, or press the VCR's TV/VIDEO button until the VIDEO indicator in the display window goes off.
- 2 Select the channel with your cable box (if you have one) or with your TV.

If you have any questions about this product, you may call: **Sony Customer Information Center** 1-800-222-SONY (7669) or write to: **Sony Customer Information Center** Sony Drive, Mail Drop #T1-11, Park Ridge, NJ 07656

Sony  line <http://www.world.sony.com/>

Free Manuals Download Website

<http://myh66.com>

<http://usermanuals.us>

<http://www.somanuals.com>

<http://www.4manuals.cc>

<http://www.manual-lib.com>

<http://www.404manual.com>

<http://www.luxmanual.com>

<http://aubethermostatmanual.com>

Golf course search by state

<http://golfingnear.com>

Email search by domain

<http://emailbydomain.com>

Auto manuals search

<http://auto.somanuals.com>

TV manuals search

<http://tv.somanuals.com>