

Video Cassette Recorder

Operating Instructions



PAL NTSC4.43

SLV-SE350K

SLV-SE500K

SLV-SE500R

SLV-SE600N

SLV-SE700N/K

SLV-SE700R

SLV-SE800N/K

SHOWVIEW®

SHOWVIEW®

Hi-Fi

Hi-Fi

Hi-Fi

Hi-Fi

SHOWVIEW®

SHOWVIEW®

WARNING

To prevent fire or shock hazard, do not expose the unit to rain or moisture.

To avoid electrical shock, do not open the cabinet. Refer servicing to qualified personnel only.

Mains lead must only be changed at a qualified service shop.

Precautions

Safety

- This unit operates on 220 – 240 V AC, 50 Hz. Check that the unit's operating voltage is identical with your local power supply.
- If anything falls into the cabinet, unplug the unit and have it checked by qualified personnel before operating it any further.
- The unit is not disconnected from the mains as long as it is connected to the mains, even if the unit itself has been turned off.
- Unplug the unit from the wall outlet if you do not intend to use it for an extended period of time. To disconnect the cord, pull it out by the plug, never by the cord.

Installing

- Allow adequate air circulation to prevent internal heat buildup.
- Do not place the unit on surfaces (rugs, blankets, etc.) or near materials (curtains, draperies) that may block the ventilation slots.
- Do not install the unit near heat sources such as radiators or air ducts, or in a place subject to direct sunlight, excessive dust, mechanical vibration or shock.
- Do not install the unit in an inclined position. It is designed to be operated in a horizontal position only.
- Keep the unit and cassettes away from equipment with strong magnets, such as microwave ovens or large loudspeakers.
- Do not place heavy objects on the unit.
- If the unit is brought directly from a cold to a warm location, moisture may condense inside the VCR and cause damage to the video head and tape. When you first install the unit, or when you move it from a cold to a warm location, wait for about three hours before operating the unit.

Caution

Television programmes, films, video tapes and other materials may be copyrighted. Unauthorized recording of such material may be contrary to the provisions of the copyright laws. Also, use of this recorder with cable television transmission may require authorization from the cable television transmitter and/or programme owner.

Compatible colour systems

This VCR is designed to record using the PAL (B/G or D/K) or MESECAM (B/G or D/K) colour system and play back using the PAL (B/G or D/K) or MESECAM (B/G or D/K) and NTSC 4.43 colour systems. Recording of video sources based on other colour systems cannot be guaranteed.

SHOWVIEW is a registered trademark of Gemstar Development Corporation. The SHOWVIEW system is manufactured under license from Gemstar Development Corporation.

Table of contents

Getting Started

- 4 Step 1 : Unpacking
- 5 Step 2 : Setting up the remote commander
- 9 Step 3 : Connecting the VCR
- 14 Step 4 : Tuning your TV to the VCR
- 17 Step 5 : Setting up the VCR with the Auto Set Up function
- 19 Step 6 : Setting the clock
- 24 Selecting a language
- 26 Presetting channels
- 30 Changing/disabling programme positions
- 36 Setting the Canal Plus decoder
(not available on SLV-SE350K, SE500R, SE600N and SE700R)

Basic Operations

- 41 Playing a tape
- 44 Recording TV programmes
- 48 Recording TV programmes using the Dial Timer
(SLV-SE800N/K only)
- 53 Recording TV programmes using the ShowView system
(not available on SLV-SE500R, SE600N and SE700R)
- 57 Recording TV programmes using the timer

Additional Operations

- 61 Playing/searching at various speeds
- 64 Setting the recording duration time
- 65 Synchronized Recording
(SLV-SE500K and SE800N/K only)
- 68 Checking/changing/cancelling timer settings
- 70 Recording stereo and bilingual programmes

(not available on SLV-SE350K, SE500K/R and SE700R)

- 72 Searching using the Smart Search function
- 75 Searching using the index function
- 76 Adjusting the picture
- 78 Changing menu options

Editing

- 81 Connecting to a VCR or stereo system
- 83 Basic editing
- 84 Audio dubbing
(SLV-SE500K/R and SE800N/K only)

Additional Information

- 86 Troubleshooting
- 91 Specifications
- 92 Index to parts and controls

Back Cover

Index

Step 1 : Unpacking

Check that you have received the following items with the VCR:

- Remote commander
- Aerial cable

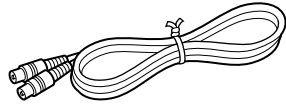
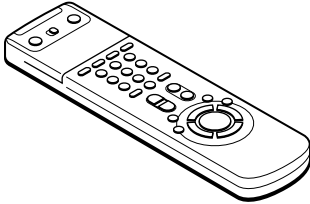

- R6 (size AA) batteries

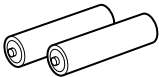

Check your model name

The instructions in this manual are for the 9 models: SLV-SE350K, SE500K, SE500R, SE600N, SE700N, SE700K, SE700R, SE800N, and SE800K. Check your model number by looking at the rear panel of your VCR.

SLV-SE800N is the model used for illustration purposes. Any difference in operation is clearly indicated in the text, for example, "SLV-SE500K only."

Step 2 : Setting up the remote commander

Inserting the batteries

Insert two R6 (size AA) batteries by matching the + and - on the batteries to the diagram inside the battery compartment.

Insert the negative (-) end first, then push in and down until the positive (+) end clicks into position.

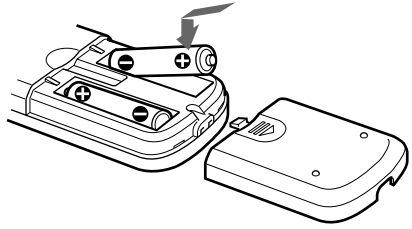

Using the remote commander

You can use this remote commander to operate this VCR and a Sony TV. Buttons on the remote commander marked with a dot (•) can be used to operate your Sony TV. If the TV does not have the  symbol near the remote sensor, this remote commander will not operate the TV.

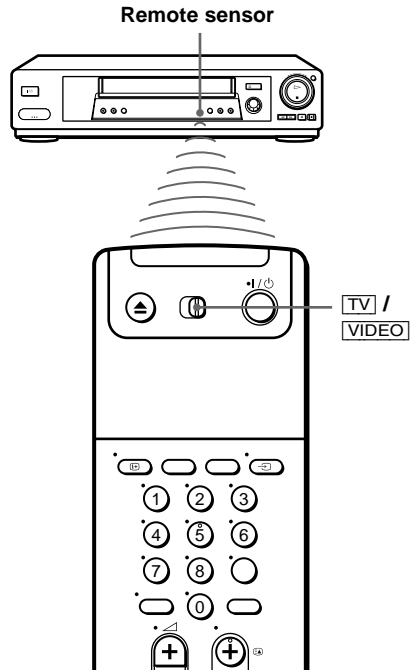

To operate	Set TV / VIDEO to
the VCR	VIDEO and point at the remote sensor at the VCR
a Sony TV	TV and point at the remote sensor at the TV

continued

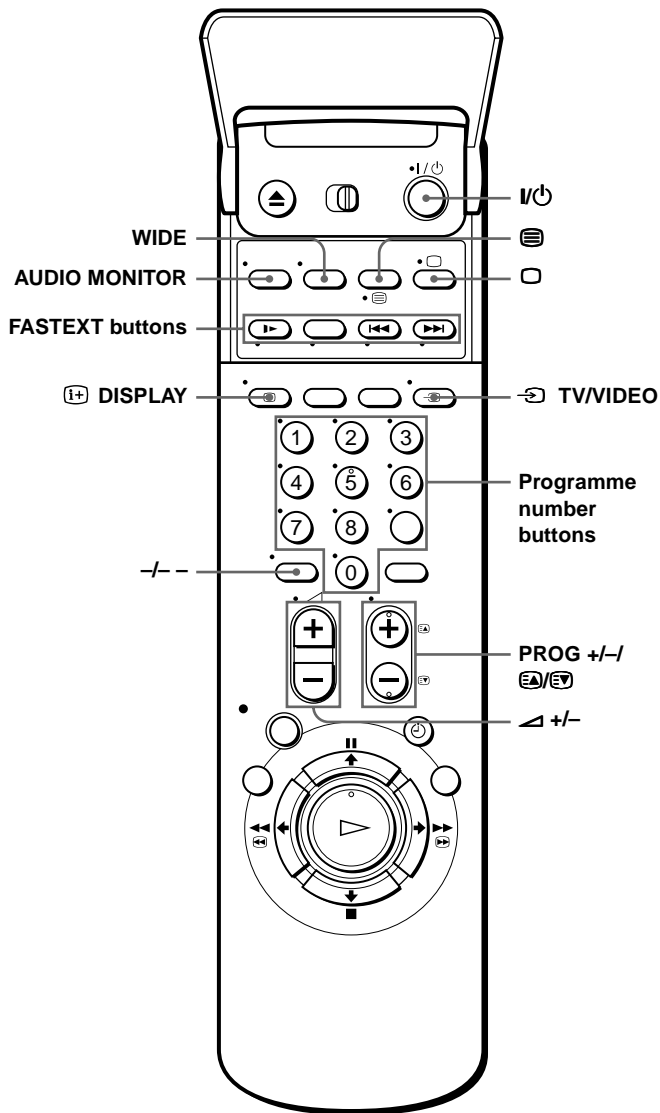

TV control buttons

To	Press
Set the TV to standby mode	I/Power
Select an input source: aerial in or line in	TV/VIDEO
Select the TV's programme position	Programme number buttons, +/-, PROG +/-

To	Press
Adjust the volume of the TV	+/-
Switch to TV (Teletext off)*	(TV)
Switch to Teletext*	(Teletext)
Select the sound	AUDIO MONITOR
Use FASTEXT*	FASTEXT buttons
Call up the on-screen display	DISPLAY
Change the Teletext page*	
Switch to/from wide mode of a Sony wide TV (For other manufactures' wide TVs, see "Controlling other TVs with the remote commander (not available on SLV-SE350K and SE600N)" below.)	WIDE

Notes

- With normal use, the batteries should last about three to six months.
- If you do not use the remote commander for an extended period of time, remove the batteries to avoid possible damage from battery leakage.
- Do not use a new battery together with an old one.
- Do not use different types of batteries together.
- Some buttons may not work with certain Sony TVs.

* not available on SLV-SE350K and SE600N

Controlling other TVs with the remote commander (not available on SLV-SE350K and SE600N)

The remote commander is preprogrammed to control non-Sony TVs. If your TV is listed in the following table, set the appropriate manufacturer's code number.

- 1 Set / at the top of the remote commander to .
- 2 Hold down , and enter your TV's code number using the programme number buttons. Then release .

Now you can use the following TV control buttons to control your TV:

, TV/VIDEO, programme number buttons, $-/-$ (ten's digit), PROG +/-, +/-, (TV), (Teletext), FASTEXT buttons, WIDE*, MENU*, $\uparrow/\downarrow/\leftarrow/\rightarrow$ *, and OK*.

* These buttons may not work with all TVs.

continued

Code numbers of controllable TVs

If more than one code number is listed, try entering them one at a time until you find the one that works with your TV.

To switch to wide mode, see the footnotes below this table for the applicable code numbers.

Manufacturer	Code number
Sony	01* ¹ , 02
Akai	68
Ferguson	52
Grundig	10* ¹ , 11* ¹
Hitachi	24
JVC	33
Loewe	45
Mivar	09, 70
NEC	66
Nokia	15, 16, 69* ³

Manufacturer	Code number
Panasonic	17* ¹ , 49
Philips	06* ¹ , 07* ¹ , 08* ¹
Saba	12, 13
Samsung	22, 23
Sanyo	25
Sharp	29
Telefunken	36
Thomson	43* ²
Toshiba	38

*¹ Press WIDE to switch the wide picture mode on or off.

*² Press WIDE, then press \triangleleft +/- to select the wide picture mode you want.

*³ Press WIDE. The menu appears on the TV screen. Then, press $\uparrow/\downarrow/\leftarrow/\rightarrow$ to select the wide picture you want and press OK.

Tip

- When you set your TV's code number correctly while the TV is turned on, the TV turns off automatically.

Notes

- If you enter a new code number, the code number previously entered will be erased.
- If the TV uses a different remote control system from the one programmed to work with the VCR, you cannot control your TV with the remote commander.
- When you replace the batteries of the remote commander, the code number may change. Set the appropriate code number every time you replace the batteries.

Step 3 : Connecting the VCR

If your TV has a Scart (EURO-AV) connector, see page 10.

If your TV does not have a Scart (EURO-AV) connector

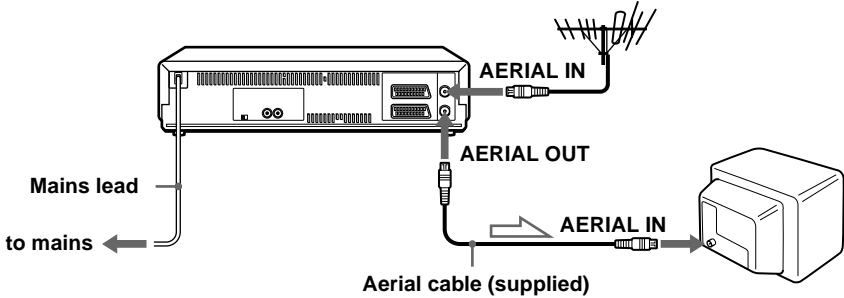

 : Signal flow

- 1 Disconnect the aerial cable from your TV and connect it to AERIAL IN on the rear panel of the VCR.

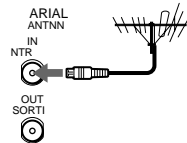

- 2 Connect AERIAL OUT of the VCR and the aerial input of your TV using the supplied aerial cable.

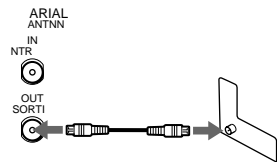

- 3 Connect the mains lead to the mains.

Note

- When you connect the VCR and your TV only with an aerial cable, you have to tune your TV to the VCR (see page 14).

continued

If your TV has a Scart (EURO-AV) connector

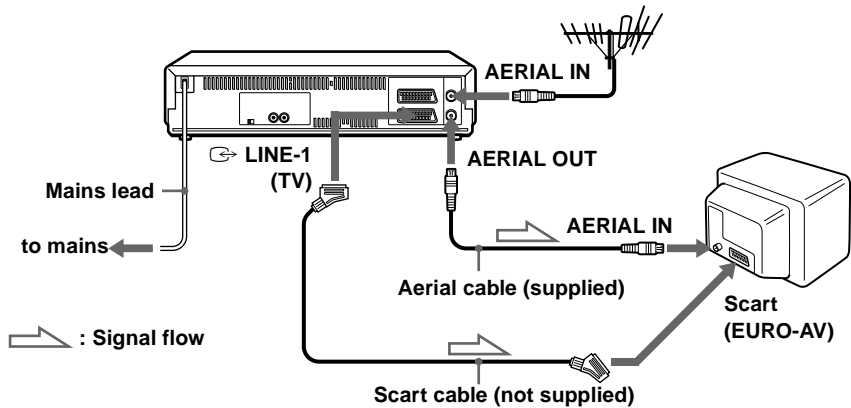

1

Disconnect the aerial cable from your TV and connect it to AERIAL IN on the rear panel of the VCR.

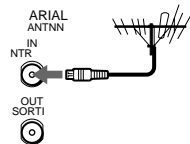

2

Connect AERIAL OUT of the VCR and the aerial input of your TV using the supplied aerial cable.

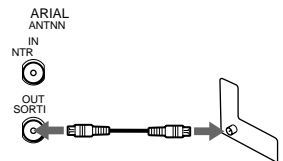

3

Connect LINE-1 (TV) on the VCR and the Scart (EURO-AV) connector on the TV with the optional Scart cable.

This connection improves picture and sound quality. Whenever you want to watch the VCR picture, press TV/VIDEO to display the VIDEO indicator in the display window.

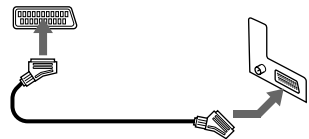

4

Connect the mains lead to the mains.

Note

- If the TV is connected to the LINE-1 (TV) connector, setting the RF channel to OFF is recommended. In the OFF position, only the signal from the aerial is output through the AERIAL OUT connector (see page 16).

About the SMARTLINK features (not available on SLV-SE600N and SE700R)

If the connected TV complies with SMARTLINK, MEGALOGIC*¹, EASYLINK*², Q-Link*³, EURO VIEW LINK*⁴, or T-V LINK*⁵, this VCR automatically runs the SMARTLINK function after you complete the steps on the previous page (the SMARTLINK indicator appears in the VCR's display window when you turn on the TV). You can enjoy the following SMARTLINK features.



- **Preset Download**
You can download your TV tuner preset data to this VCR and tune the VCR according to that data in Auto Set Up. This greatly simplifies the Auto Set Up procedure. Be careful not to disconnect the cables or exit the Auto Set Up function during the procedure.
See "Setting up the VCR with the Auto Set Up function" on page 17.
- **TV Direct Rec**
You can easily record what you are watching on the TV. For details, see "Recording what you are watching on the TV (TV Direct Rec) (not available on SLV-SE600N and SE700R)" on page 47.
- **One Touch Play**
With One Touch Play, you can start playback automatically without turning on the TV. For details, see "Starting playback automatically with one button (One Touch Play) (not available on SLV-SE600N and SE700R)" on page 43.
- **One Touch Menu**
You can turn on the VCR and TV, set the TV to the video channel, and display the VCR's on-screen display automatically by pressing MENU on the remote commander.
- **One Touch Timer**
You can turn on the VCR and TV, set the TV to the video channel, and display the timer recording menu (the TIMER METHOD menu, the TIMER menu, or the SHOWVIEW menu) automatically by pressing  TIMER on the remote commander.
You can set which timer recording menu is displayed using TIMER OPTIONS in the OPTIONS-2 menu (see page 79).
- **Automatic Power Off**
You can have the VCR turn off automatically, if the VCR is not used after you turn off the TV.

*¹ "MEGALOGIC" is a registered trademark of Grundig Corporation.

*² "EASYLINK" is a trademark of Philips Corporation.

*³ "Q-Link" is a trademark of Panasonic Corporation.

*⁴ "EURO VIEW LINK" is a trademark of Toshiba Corporation.

*⁵ "T-V LINK" is a trademark of JVC Corporation.

Note

- Not all TVs respond to the functions above.

continued

Additional connections

To a stereo system (SLV-SE700N/K and SE800N only)

You can improve sound quality by connecting a stereo system to the AUDIO OUT R/L jacks as shown on the right.

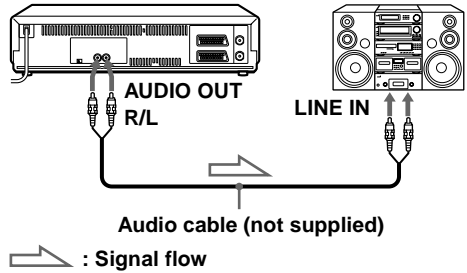

To a TV with audio and video jacks (SLV-SE500R, SE700R and SE800K only)

If your TV does not have a Scart (EURO-AV) connector, you can improve sound and picture quality by connecting your TV to the LINE-2 OUT jacks as shown on the right.

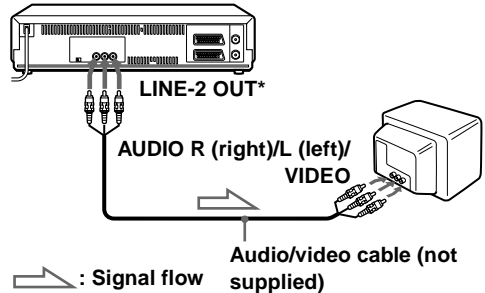

* SLV-SE500R has only AUDIO L (left) and VIDEO jacks.

To a satellite or digital tuner with Line Through (not available on SLV- SE350K, SE500R, SE600N and SE700R)

Using the Line Through function, you can watch programmes from a satellite or digital tuner connected to this VCR on the TV even when the VCR is turned off. When you turn on the satellite or digital tuner, this VCR automatically sends the signal from the satellite or digital tuner to the TV without turning itself on.

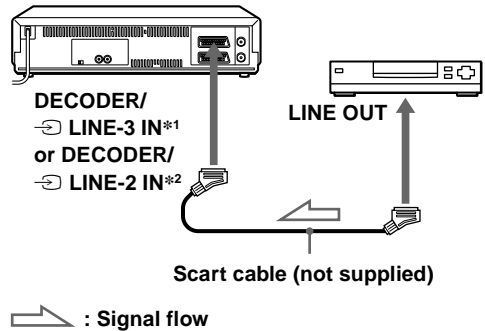

- 1 Connect the satellite or digital tuner to the DECODER/LINE-3 IN*1 (or DECODER/LINE-2 IN*2) connector as shown above.
- 2 Set DECODER/LINE3*1 (or DECODER/LINE2*2) to LINE3*1 (or LINE2*2) in the OPTIONS-2 menu.

3 Set POWER SAVE to OFF in the OPTIONS-2 menu.

4 Turn off the VCR.

To watch a programme, turn on the satellite or digital tuner and the TV.

Note

- You cannot watch programmes on the TV while recording unless you are recording a satellite or digital programme.

*1 SLV-SE500K and SE800N/K only

*2 SLV-SE700N/K only

Step 4 : Tuning your TV to the VCR

If your TV has a Scart (EURO-AV) connector, see page 16.

If your TV does not have a Scart (EURO-AV) connector

Follow the steps below so that your TV will properly receive the video signals from your VCR.

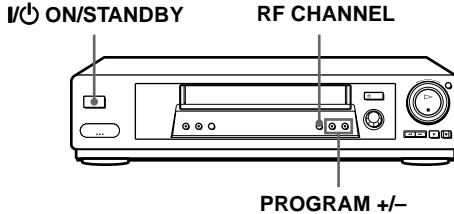

- 1** ONSTAN Press I/ON STANDBY to turn on the VCR.



- 2** AUTO ST UP Press RF CHANNEL on the VCR lightly.
The factory-preset RF channel appears in the display window.
The VCR signal is output through this channel to the TV.

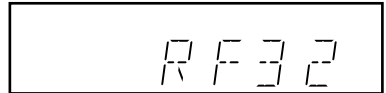

- 3** Turn on your TV and select a programme position for the VCR picture.
This programme position will now be referred to as the video channel.

- 4** AUTO ST UP Press RF CHANNEL.
The TV system appears in the display window.

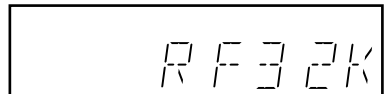

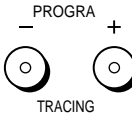
- 5**  Press PROGRAM +/- (repeatedly) to select the appropriate TV system for your area.
Select "G" for the B/G TV system, or "K" for the D/K TV system.

- 6** Tune the TV to the same channel shown in the VCR display window so that the picture on the right appears clearly on the TV screen.

Refer to your TV manual for TV tuning instructions.

If you select the wrong TV system in step 5, the picture on the right may not appear. Select the appropriate TV system and tune the TV again.

If the picture does not appear clearly, see "To obtain a clear picture from the VCR" below.



- 7**  Press RF CHANNEL.
You have now tuned your TV to the VCR. Whenever you want to play a tape, set the TV to the video channel.

To check to see if the TV tuning is correct

Set the TV to the video channel and press PROGRAM +/- on the VCR. If the TV screen changes to a different programme each time you press PROGRAM +/-, the TV tuning is correct.

To obtain a clear picture from the VCR

If the screen does not appear clearly in step 6 above, go to step 7 to finish this procedure once. Then start again from step 2. After pressing RF CHANNEL in step 2, press PROGRAM +/- while the RF channel is displayed, so that another RF channel appears. Then tune the TV to the new RF channel so that a clear picture appears.

Note

- If you set the wrong TV system, you may have no sound or sound may be distorted.

continued

If your TV has a Scart (EURO-AV) connector

Set the RF channel to OFF so that the VCR does not interfere with existing broadcasts.

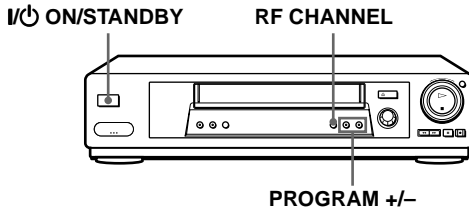

-
- 1** ONSTAN Press I/ON/STANDBY to turn on the VCR.



-
- 2** AUTO ST UP Press RF CHANNEL on the VCR lightly.
The factory-preset RF channel appears in the display window.
The VCR signal is output through this channel to the TV.

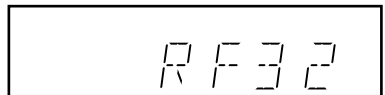

-
- 3** - PROGRA + Press PROGRAM +/- to set the RF channel to OFF, and press RF CHANNEL again.
Since SLV-SE500R/SE700R does not have OFF, select an unused channel with the least amount of interference.

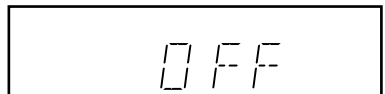

RF channel set up is complete.

Step 5 : Setting up the VCR with the Auto Set Up function

Before using the VCR for the first time, set up the VCR using the Auto Set Up function. With this function, you can set the language for the on-screen display, TV channels, guide channels for the ShowView system*, and VCR clock* automatically.

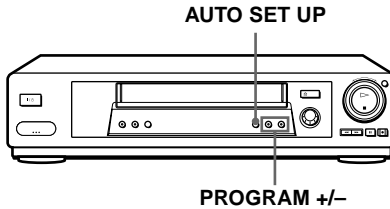

1



Hold down **AUTO SET UP** on the VCR for more than three seconds.

The VCR automatically turns on, and the country abbreviation appears in the display window.

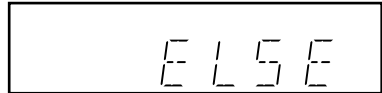

2

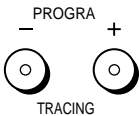

Press **PROGRAM +/-** to select the abbreviation of your country from the table on page 18.

For some countries, there is a selection of languages to choose from.

If your country does not appear, select **ELSE**.

continued

3



Press AUTO SET UP lightly.

The VCR starts searching for all of the receivable channels and presets them according to the TV system you selected in “Tuning your TV to the VCR” on page 14.

If you want to change the order of the channels or disable unwanted programme positions, see “Changing/disabling programme positions” on page 30.



If you use the SMARTLINK connection (not available on SLV-SE600N and SE700R), the Preset Download function starts and the SMARTLINK indicator flashes in the display window during download.

After the search or download is complete, the current time appears in the display window for any stations that transmit a time signal (not available on SLV-SE500R, SE600N and SE700R).

The abbreviations of the countries and languages are as follows:

Abbreviation	Country	Language
CZ	Checho	Czech
HUN	Hungary	Hungarian
PL	Poland	Polish
SK	Slovakia	Slovak
TR	Turkey	Turkish
RUS	Russia	Russian
ELSE	Other countries	English

To cancel the Auto Set Up function

Press AUTO SET UP.

Tip

- If you want to change the language for the on-screen display from the one preset in the Auto Set Up function, see page 24.

Notes

- If you stop the Auto Set Up function during step 3, you must repeat set up from step 1.
- Whenever you operate the Auto Set Up function, some of the settings (ShowView*, timer, etc.) will be reset. If this happens, you have to set them again.

* not available on SLV-SE500R, SE600N and SE700R

Step 6 : Setting the clock

You must set the time and date on the VCR to use the timer features properly.

The Auto Clock Set function (not available on SLV-SE500R, SE600N and SE700R) works only if a station in your area is broadcasting a time signal. If the Auto Set Up function did not set the clock correctly for your local area, try another station for the Auto Clock Set function (see page 22).

Setting the clock manually

Before you start...

- Turn on the VCR and the TV.
- Set the TV to the video channel.

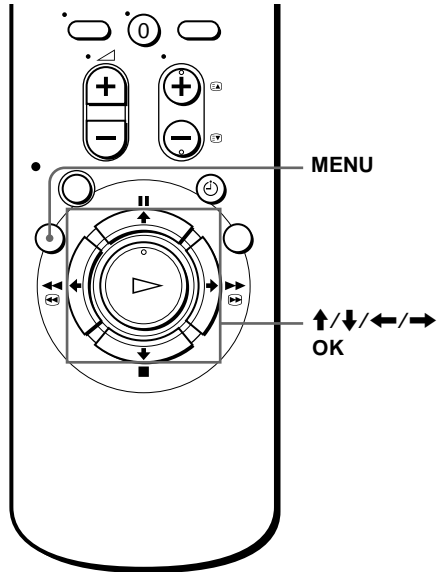

1

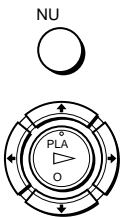

Press MENU, then press \uparrow/\downarrow to highlight SETTINGS and press OK.

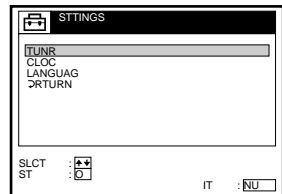

2



Press \uparrow/\downarrow to highlight CLOCK, then press OK.

For SLV-SE500R, SE600N and SE700R, only the clock setting menu appears. Skip the next step and go to step 4.

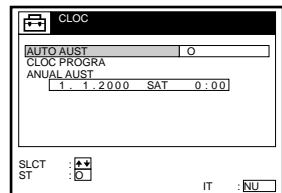

continued

3

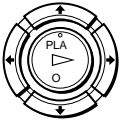

Press **↑/↓** to highlight MANUAL ADJUST, then press OK.

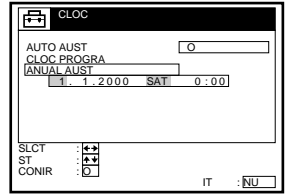

4



Press **↑/↓** to set the day.

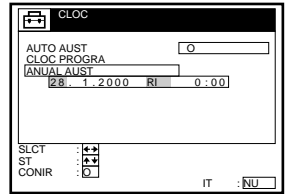

5



Press **→** to highlight the month and set the month pressing **↑/↓**.

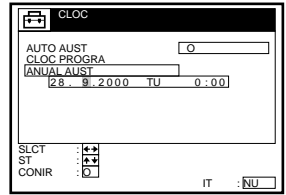

6

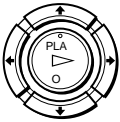

Set the year, hour, and minutes in sequence, pressing **→** to highlight the item to be set, and press **↑/↓** to select the digits.

The day of the week is set automatically.

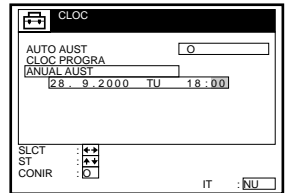

7

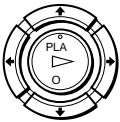

Press OK to start the clock.

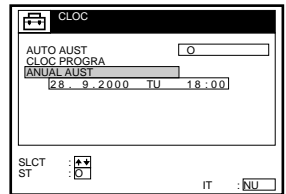

8

NU



Press MENU to exit the menu.

Tips

- To change the digits while setting, press ← to return to the item to be changed, and select the digits by pressing ↑/↓.
- If you want to return to the previous menu, highlight RETURN and press OK.

Note

- The menu disappears automatically if you don't proceed for more than a few minutes.

continued

Changing the station for the Auto Clock Set function (not available on SLV-SE500R, SE600N and SE700R)

Before you start...

- Turn on the VCR and the TV.
- Set the TV to the video channel.

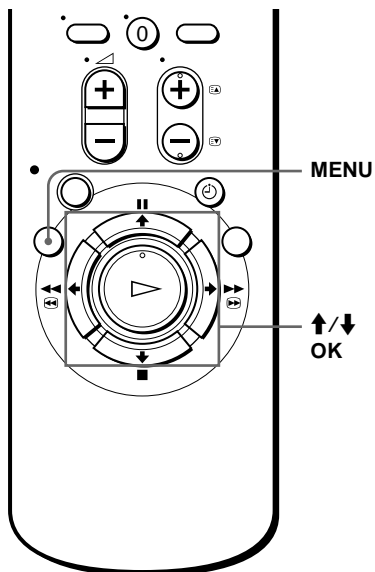

- 1** Press MENU, then press **↑/↓** to highlight SETTINGS and press OK.

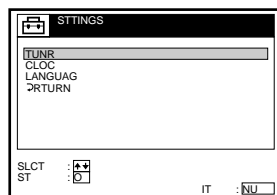
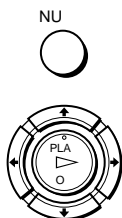

- 2** Press **↑/↓** to highlight CLOCK, then press OK.

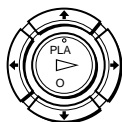

AUTO ADJUST is highlighted.

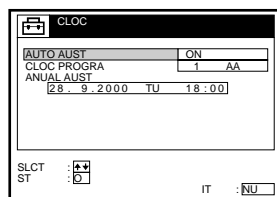

- 3** Press OK.

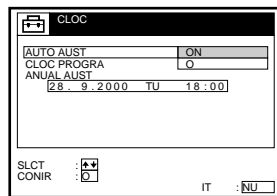
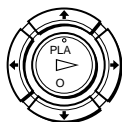

4

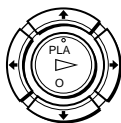

Press **↑/↓** to highlight ON, then press OK.

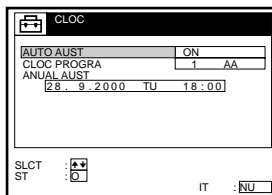

5

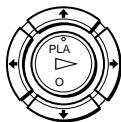

Press **↓** to highlight CLOCK PROGRAM, then press OK.

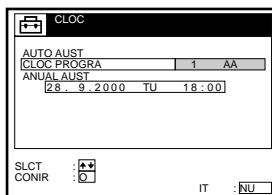

6

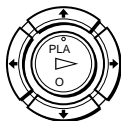

Press **↑/↓** repeatedly until the programme position of the station that carries a time signal appears.

If the VCR does not receive a time signal from any station, AUTO ADJUST returns to OFF automatically.

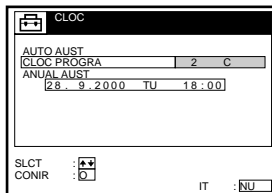

7

NU



Press MENU to exit the menu.

Tips

- If you set AUTO ADJUST to ON, the Auto Clock Set function is activated whenever the VCR is turned off. The time is adjusted automatically by making reference to the time signal from the station whose programme position is displayed in the "CLOCK PROGRAM" row. If you do not need the Auto Clock Set, select OFF.
- If you want to return to the previous menu, highlight RETURN and press OK.

Note

- The menu disappears automatically if you don't proceed for more than a few minutes.

Selecting a language

You can change the on-screen display language from the one you selected with the Auto Set Up function.

Before you start...

- Turn on the VCR and the TV.
- Set the TV to the video channel.

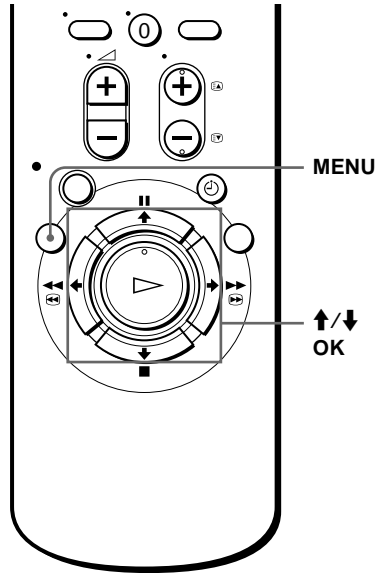

1

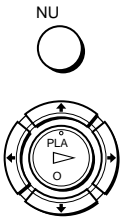

Press MENU, then press ↑/↓ to highlight SETTINGS and press OK.

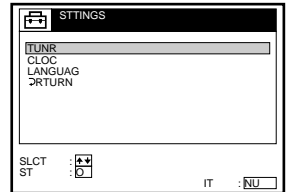

2



Press ↑/↓ to highlight LANGUAGE, then press OK.



3



Press **↑/↓** to highlight the desired language, then press OK.

4



Press MENU to exit the menu.

Tip

- If you want to return to the previous menu, highlight RETURN and press OK.

Note

- The menu disappears automatically if you don't proceed for more than a few minutes.

Presetting channels

If some channels could not be preset using the Auto Set Up function, you can preset them manually.

Before you start...

- Turn on the VCR and the TV.
- Set the TV to the video channel.

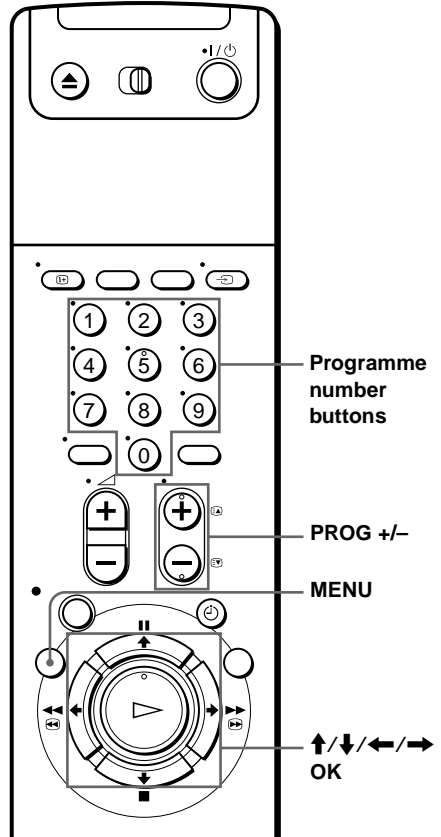

1

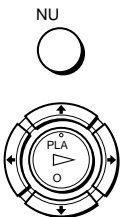

Press MENU, then press **↑/↓** to highlight SETTINGS and press OK.

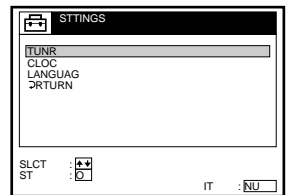

2



Press **↑/↓** to highlight TUNER, then press OK.

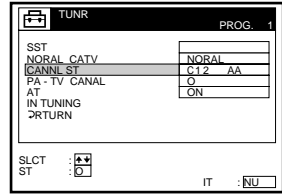

3



Press **↑/↓** to highlight NORMAL/CATV, then press OK.

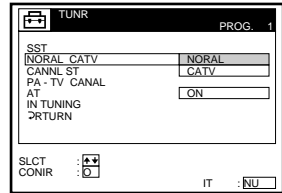

4



Press **↑/↓** to highlight NORMAL, then press OK.

To preset CATV (Cable Television) channels, select CATV.

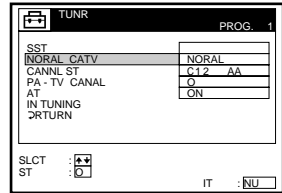

5

• PROG



Press **PROG +/-** to select the programme position.

Selected programme position

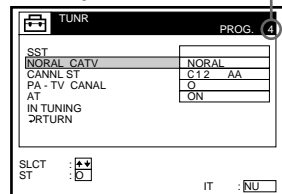

6



Press **↑/↓** to highlight CHANNEL SET, then press OK.

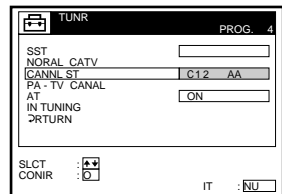

continued

7



Press **↑/↓** repeatedly until the channel you want is displayed.

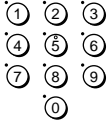
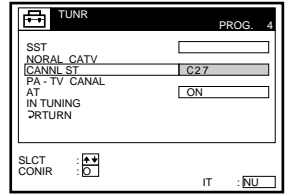

The channels appear in the following order:

B/G TV system		D/K TV system	
Channel number in the CHANNEL SET field	Receivable Channel	Channel number in the CHANNEL SET field	Receivable Channel
C02	E2	C02	R1
C03	E3	C05	R6
C04	E4	C06	R7
C05	E5	C12	R12
C06	E6	C13	R2
C07	E7	C14	R3
C08	E8	C15	R4
C09	E9	C16	R5
C10	E10	C17	R8
C11	E11	C18	R9
C12	E12	C19	R10
C21–C69	E21–E69	C20	R11
S01–S41	S1–S41	C21–C69	R21–R69
S42–S46	S01–S05		

If you know the number of the channel you want, press the programme number buttons. For example, for channel 5, first press “0” and then press “5.”

8



If the TV sound is distorted or noisy, press **↑/↓** to highlight SYSTEM and press OK. Then press **↑/↓** to select B/G or D/K so that you get better sound.

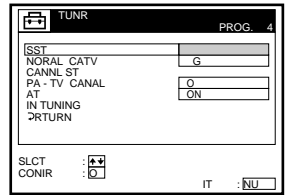

9

To preset another programme position, repeat steps 5 through 7.



If the picture is not clear

Normally, the Auto Fine Tuning (AFT) function automatically tunes in channels clearly. However, if the picture is not clear, you may also use the manual tuning function.

- 1 Press PROG +/- or the programme number buttons to select the programme position for which you cannot obtain a clear picture.
- 2 Press MENU, then select SETTINGS and press OK.
- 3 Select TUNER, then press OK.
- 4 Select FINE TUNING, then press OK.

The fine tuning meter appears.

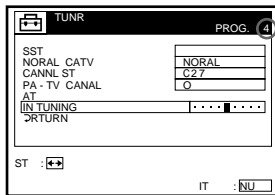

Selected programme position

- 5 Press ←/→ to get a clearer picture, then press MENU to exit the menu.
Note that the AFT (Auto Fine Tuning) setting switches to OFF.

Tip

- If you want to return to the previous menu, highlight RETURN and press OK.

Notes

- The menu disappears automatically if you don't proceed for more than a few minutes.
- When adjusting FINE TUNING, the menu may become difficult to read due to interference from the picture being received.

Changing/disabling programme positions

After setting the channels, you can change the programme positions as you like. If any programme positions are unused or contain unwanted channels, you can disable them.

You can also change the station names (not available on SLV-SE500R, SE600N and SE700R). If the station names are not displayed, you can enter them manually.

Changing programme positions

Before you start...

- Turn on the VCR and the TV.
- Set the TV to the video channel.

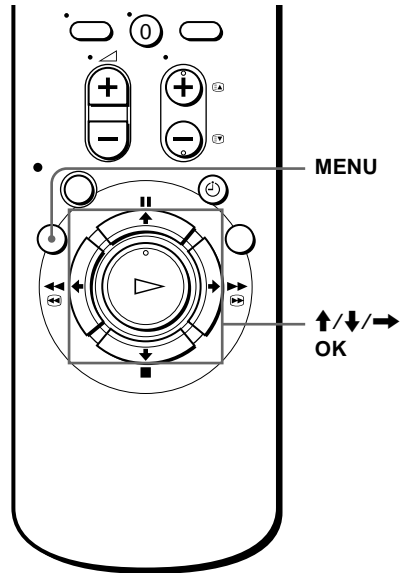

1 Press MENU, then press **↑/↓** to highlight LISTS and press OK.

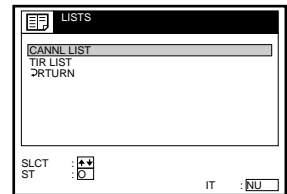
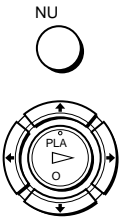

2 Press **↑/↓** to highlight CHANNEL LIST, then press OK.

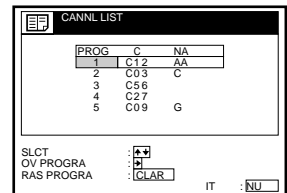

3



Press **↑/↓** to highlight the row which you want to change the programme position, then press **→**.

To display other pages for programme positions 6 to 60, press **↑/↓** repeatedly.

CANNL LIST		
PROG	C	NA
1	C12	AA
2	C03	C
3	C56	
4	C27	
5	C09	G

SLCT : **↑/↓**
 ST STATION NA : **←/→**
 CONIR : **←/→** IT : NU

4



Press **↑/↓** until the selected channel row moves to the desired programme position.

The selected channel is inserted at the new programme position and the intermediate channels are displaced to fill the gap.

CANNL LIST		
PROG	C	NA
1	C03	C
2	C56	
3	C12	AA
4	C27	
5	C09	G

SLCT : **↑/↓**
 ST STATION NA : **←/→**
 CONIR : **←/→** IT : NU

5



Press **OK** to confirm the setting.

6

To change the programme position of another station, repeat steps 3 through 5.

7



Press **MENU** to exit the menu.

Tip

- If you want to return to the previous menu, highlight **RETURN** and press **OK**.

Note

- The menu disappears automatically if you don't proceed for more than a few minutes.

continued

Disabling unwanted programme positions

After presetting channels, you can disable unused programme positions. The disabled positions will be skipped later when you press the PROG +/- buttons.

Before you start...

- Turn on the VCR and the TV.
- Set the TV to the video channel.

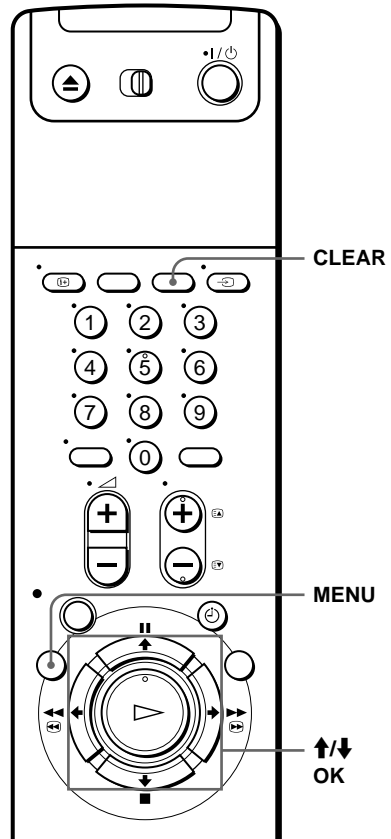

1

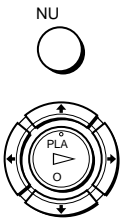

Press MENU, then press \uparrow/\downarrow to highlight LISTS, and press OK.

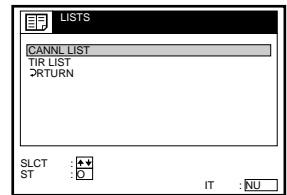

2



Press \uparrow/\downarrow to highlight CHANNEL LIST, then press OK.

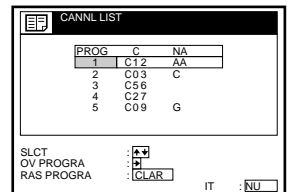

3

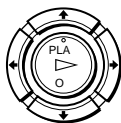

Press **↑/↓** to highlight the row which you want to disable.

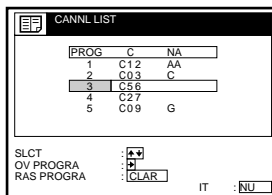

4



Press **CLEAR**.

The selected row will be cleared as shown on the right.

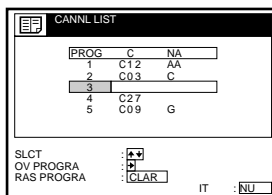

5

Repeat steps 3 and 4 for any other programme positions you want to disable.

6



Press **MENU** to exit the menu.

Tip

- If you want to return to the previous menu, highlight **RETURN** and press **OK**.

Notes

- The menu disappears automatically if you don't proceed for more than a few minutes.
- Be sure to select the programme position you want to disable correctly. If you disable a programme position by mistake, you need to reset that channel manually.

continued

Changing the station names (not available on SLV-SE500R, SE600N and SE700R)

You can change or enter the station names (up to 5 characters). The VCR must receive channel information (for instance, SMARTLINK information) for station names to appear automatically.

Before you start...

- Turn on the VCR and the TV.
- Set the TV to the video channel.

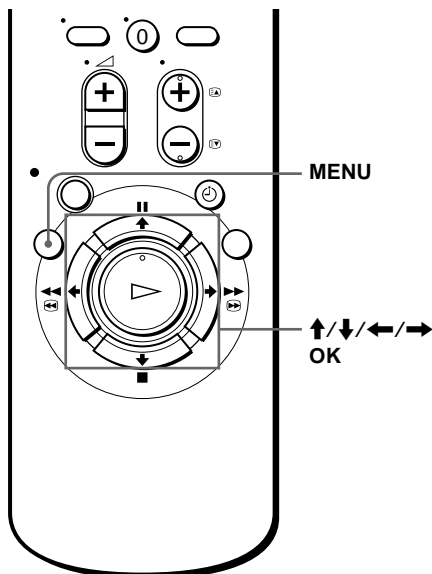

- 1** Press MENU, then press \uparrow/\downarrow to highlight LISTS and press OK.

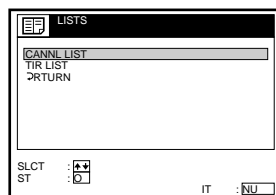
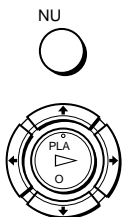

- 2** Press \uparrow/\downarrow to highlight CHANNEL LIST, then press OK.

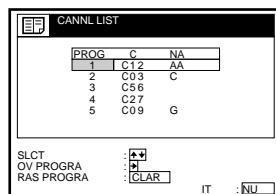

- 3** Press \uparrow/\downarrow to highlight the row which you want to change or enter the station name, then press \rightarrow .



To display other pages for programme positions 6 to 60, press \uparrow/\downarrow repeatedly.

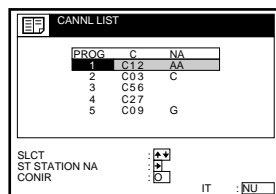

4 Press →.

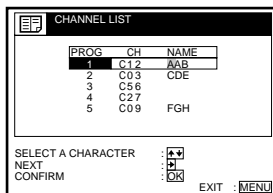

5 Enter the station name.



1 Press ↑/↓ to select a character.

Each time you press ↑, the character changes as shown below.

A → B → ... → Z → a → b → ... → z
 → 0 → 1 → ... → 9 → (symbols) →
 (blank space) → A

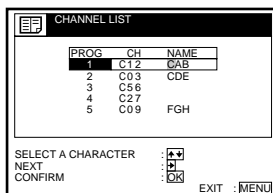

2 Press → to set the next character.

The next space is highlighted.

To correct a character, press ←/→ until the character you want to correct is highlighted, then reset it.

You can set up to 5 characters for the station name.

6 Press OK to confirm the new name.



7 Press MENU to exit the menu.

MENU



Tip

- If you want to return to the previous menu, highlight RETURN and press OK.

Notes

- The menu disappears automatically if you don't proceed for more than a few minutes.
- If you enter a symbol in step 5, it will appear as a blank space in the display window.

Setting the Canal Plus decoder

(not available on SLV-SE350K, SE500R, SE600N and SE700R)

You can watch or record Canal Plus programmes if you connect a decoder (not supplied) to the VCR.

Connecting a decoder

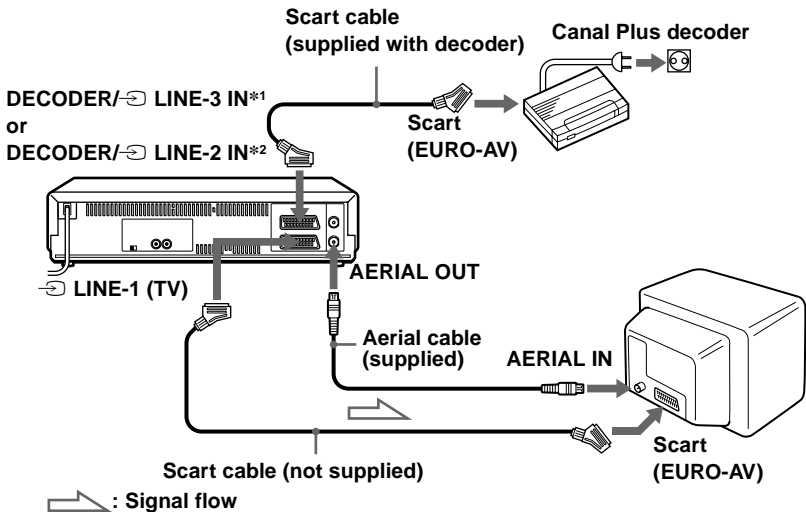

Setting Canal Plus channels

To watch or record Canal Plus programmes, set your VCR to receive the channels using the on-screen display.

In order to set the channels correctly, be sure to follow all of the steps below.

Before you start...

- Turn on the VCR, the TV, and the decoder.
- Set the TV to the video channel.

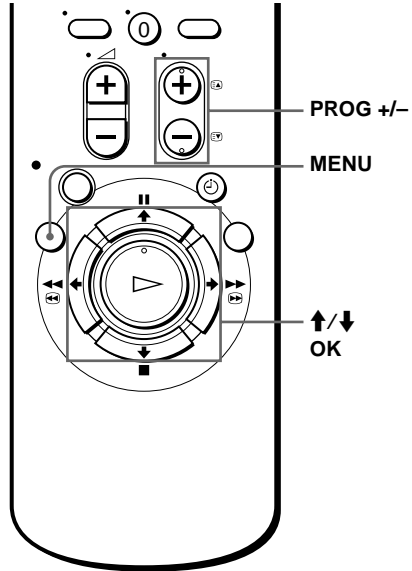

- 1** Press MENU, then press **↑/↓** to highlight **OPTIONS** and press OK.

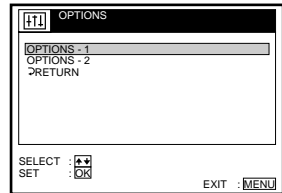
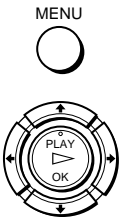

- 2** Press **↑/↓** to highlight **OPTIONS-2**, then press OK.

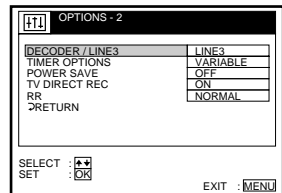

- 3** Press **↑/↓** to highlight **DECODER / LINE3*1** (or **DECODER / LINE2*2**), then press OK.

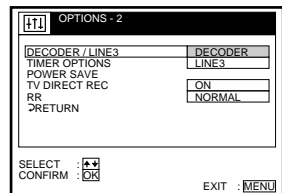

continued

4



Press **↑/↓** to highlight DECODER, then press OK.

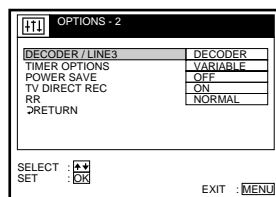

5



Press MENU to exit the menu.

The menu disappears from the TV screen.

6



Press MENU again. Then press **↑/↓** to highlight SETTINGS and press OK.

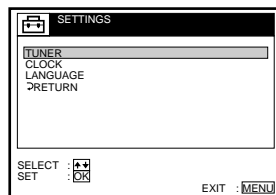

7



Press **↑/↓** to highlight TUNER, then press OK.

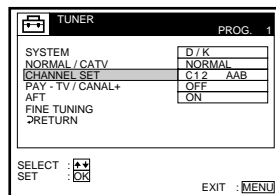

8



Press **↑/↓** to highlight NORMAL/CATV, then press OK.

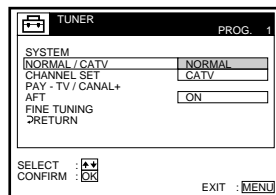

9



Press **↑/↓** to highlight **NORMAL**, then press **OK**.

To preset **CATV** (Cable Television) channels, select **CATV**.

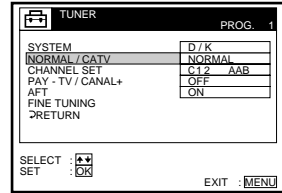

10

•PROG



Press **PROG +/-** to select the desired programme position.

Selected programme position

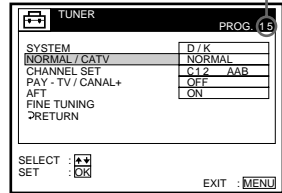

11



Press **↑/↓** to highlight **CHANNEL SET**, then press **OK**.

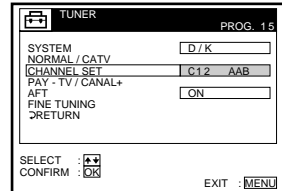

12



Press **↑/↓** to select the Canal Plus channels, then press **OK**.

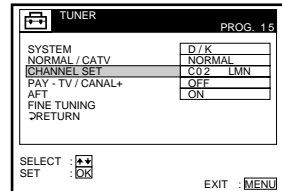

13



Press **↑/↓** to highlight **PAY-TV/CANAL+**, then press **OK**.

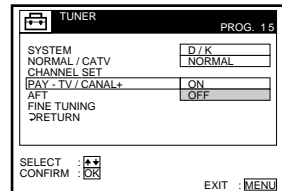

continued

14



Press **↑/↓** to highlight ON, then press OK.

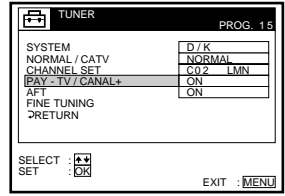

15



If the TV sound is distorted or noisy, press **↑/↓** to highlight SYSTEM and press OK. Then press **↑/↓** to select B/G or D/K so that you get better sound.

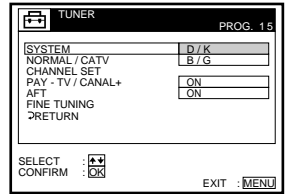

16



Press MENU to exit the menu.

Tip

- If you want to return to the previous menu, highlight RETURN and press OK.

Notes

- The menu disappears automatically if you don't proceed for more than a few minutes.
- To superimpose subtitles while watching Canal Plus programmes, make both decoder-VCR and VCR-TV connections using 21-pin Scart cables that are compatible with the RGB signals. You cannot record subtitles on the VCR.
- When you watch Canal Plus programmes through the RFU input of the TV, press **TV/VIDEO** so that the VIDEO indicator appears in the display window.

*1 SLV-SE500K and SE800N/K only

*2 SLV-SE700N/K only

Playing a tape

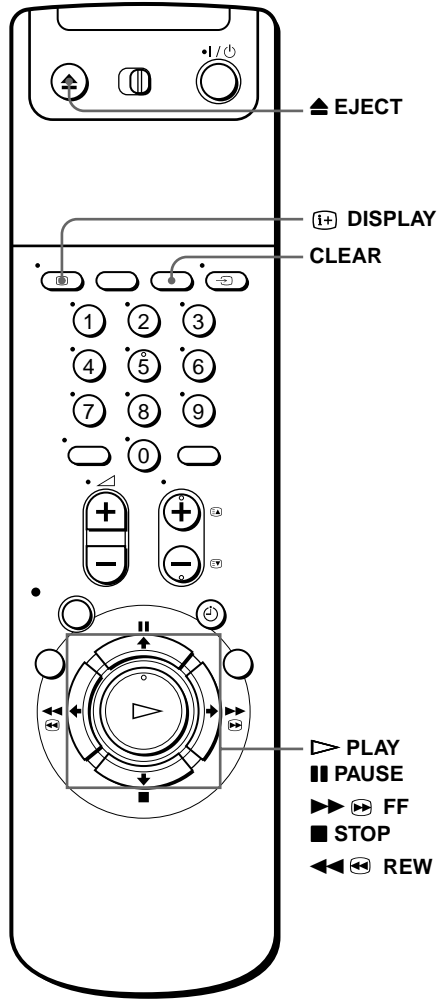
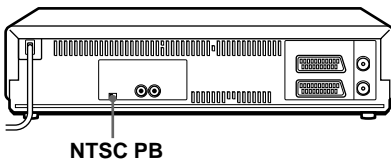

1 Turn on your TV and set it to the video channel.

2 Insert a tape.
The VCR turns on and starts playing automatically if you insert a tape with its safety tab removed.

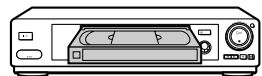

continued





3



Press  PLAY.

When the tape reaches the end, it will rewind automatically.

Additional tasks

To	Press
Stop play	■ STOP
Pause play	PAUSE
Resume play after pause	PAUSE or  PLAY
Fast-forward the tape	  FF during stop
Rewind the tape	  REW during stop
Eject the tape	▲ EJECT

To set the colour system

If the playback picture has no colour, or streaks appear during playback, set COLOUR SYSTEM in the OPTIONS-1 menu to conform to the system that the tape was recorded in (see page 79). (Normally set the option to AUTO.)

To play an NTSC-recorded tape

Set NTSC PB at the rear of the VCR according to the colour system of your TV.

When your TV is	Set NTSC PB to
PAL only	ON PAL TV
PAL and NTSC	NTSC 4.43

To use the time counter

Press CLEAR at the point on the tape that you want to find later. The counter in the display window resets to "0:00:00." Search for the point afterwards by referring to the counter.



To display the counter on the TV screen, press  DISPLAY.

Notes

- The counter resets to “0:00:00” whenever a tape is reinserted.
- The counter stops counting when it comes to a portion with no recording.
- The time counter does not appear on the TV screen when using an NTSC-recorded tape.
- Depending on your TV, the following may occur while playing an NTSC-recorded tape:
 - The picture becomes black and white.
 - The picture shakes.
 - No picture appears on the TV screen.
 - Black streaks appear horizontally on the TV screen.
 - The colour density increases or decreases.
- If you play back a tape in the LP or EP mode with the NTSC system, the sound becomes monaural.
- While setting the menu on the TV screen, buttons for playback on the remote commander do not function.
- The picture’s colour may be affected when playing a MESECAM-recorded tape in the LP mode.*

* SLV-SE350K only

Starting playback automatically with one button (One Touch Play) (not available on SLV-SE600N and SE700R)

If you use the SMARTLINK connection, you can turn on the VCR and the TV, set the TV to the video channel, and start playback automatically with one button.

1 Insert a tape.

The VCR automatically turns on.

If you insert a tape with its safety tab removed, the TV turns on and switches to the video channel. Playback starts automatically.

2 Press \triangleright PLAY.

The TV turns on and switches to the video channel automatically. Playback starts.

Tip

- When there already is a tape in the VCR, the VCR and the TV turn on, the TV is set to the video channel, and playback starts automatically in one sequence when you press \triangleright PLAY.

Note

- When you use the One Touch Play function, leave the TV on or in the standby mode.

Recording TV programmes

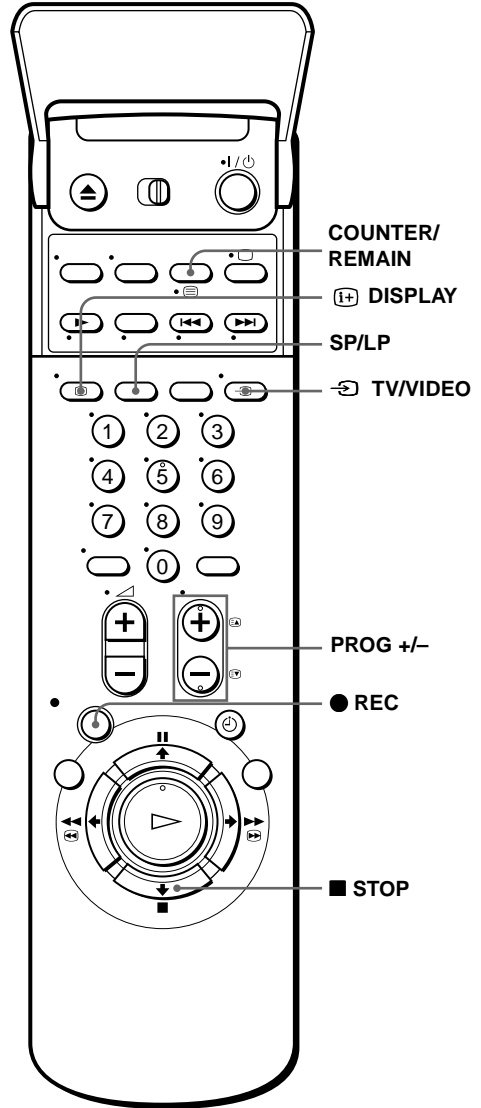



1 Turn on your TV and set it to the video channel.
To record from a decoder, turn it on.

2 Insert a tape with its safety tab in place.

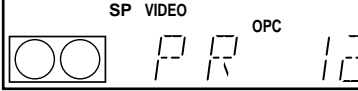
3 **•PROG** Press **PROG +/-** to select the programme position or station name*¹ you want to record.

4 **SP / LP** Press **SP/LP** to select the tape speed, SP or LP.
 LP (Long Play) provides recording time twice as long as SP. However, SP (Standard Play) produces better picture and audio quality.

5 **•REC** Press **•REC** to start recording.
 The recording indicator lights up red in the display window.



Recording indicator →



To stop recording

Press **■ STOP**.

To check the remaining time

Press **(i+) DISPLAY**. With the display on, press **COUNTER/REMAIN** to check the remaining time. Each time you press **COUNTER/REMAIN**, the time counter and the remaining time appear alternately. The  indicator indicates the remaining time.

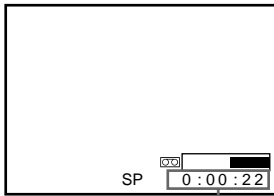

Time counter

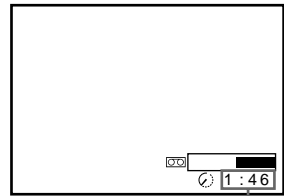

Remaining time

In order to get an accurate remaining time indication, be sure **TAPE LENGTH** in the **OPTIONS-1** menu is set according to the tape type you use (see page 79).

To watch another TV programme while recording

- 1** Press **↔ TV/VIDEO** to turn off the **VIDEO** indicator in the display window.
- 2** Select another programme position on the TV.

continued

To save a recording

To prevent accidental erasure, break off the safety tab as illustrated. To record on the same tape again, cover the tab hole with adhesive tape.

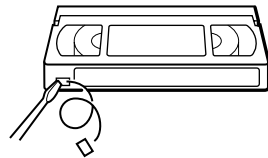

Safety tab

Tips

- To select a programme position, you can use the programme number buttons on the remote commander. For two-digit numbers, press the -- (ten's digit) button followed by the programme number buttons.
- If you connect additional equipment to a LINE connector or jack, you can select the input signal using the INPUT SELECT or PROG +/- buttons.
- The **[+]** DISPLAY information appears on the TV screen indicating information about the tape, but the information won't be recorded on the tape.
- If you don't want to watch TV while recording, you can turn off the TV. When using a decoder, make sure to leave it on.

Notes

- The **[+]** DISPLAY information does not appear during still (pause) mode or slow-motion playback.
- The **[+]** DISPLAY information will not appear while playing an NTSC-recorded tape.
- If a tape has portions recorded in both PAL (MESECAM) and NTSC systems, the time counter reading will not be correct. This discrepancy is due to the difference between the counting cycles of the two video systems.
- You cannot watch a Canal Plus programme while recording another Canal Plus programme.*2
- When you insert a non-standard commercially available tape, the remaining time may not be correct.
- The remaining time is intended for rough measurement only.
- About 30 seconds after the tape begins playback, the tape remaining time will be displayed.
- The station name*1 may not appear if the VCR does not receive station name information signals.

*1 not available on SLV-SE500R, SE600N and SE700R

*2 not available on SLV-SE350K, SE500R, SE600N and SE700R

Recording what you are watching on the TV (TV Direct Rec)

(not available on SLV-SE600N and SE700R)

If you use the SMARTLINK connection, you can easily record what you are watching on the TV (other than tapes being played on the VCR).

- 1** Insert a tape with its safety tab in place.
- 2** Press ● REC while you are watching a TV programme or external source.
The VCR automatically turns on, then the TV indicator lights up and the VCR starts recording what you are watching on the TV.

Tips

- The TV indicator appears in the display window after you press ● REC in some situations such as:
 - when you are watching a source connected to the TV's line input, or
 - when the TV tuner preset data for the programme position is different from the data in the VCR tuner preset.
- If there is a tape with its safety tab in place in the VCR, the VCR automatically turns on and starts recording what you are watching on the TV when you press ● REC.
- You can turn the TV Direct Rec function ON and OFF in the OPTIONS-2 menu (see page 79).

Notes

- You cannot record what you are watching using this method when the VCR is in the following modes; pause, timer standby, tuner preset, Auto Set Up, and recording.
- When the TV indicator is lit in the display window, do not turn off the TV nor change the TV programme position. When the TV indicator is not lit, the VCR continues recording the programme even if you change the TV programme position on the TV.

Recording TV programmes using the Dial Timer (SLV-SE800N/K only)

The Dial Timer function allows you to make timer recordings of programmes without turning on your TV. Set the recording timer to record up to eight programmes, including settings made with other timer methods, that will be broadcast within the next month. The recording start time and recording stop time can be set at one minute intervals.

Before you start...

- Insert a tape with its safety tab in place.
Make sure the tape is longer than the total recording time.
- To record from a decoder, turn it on.

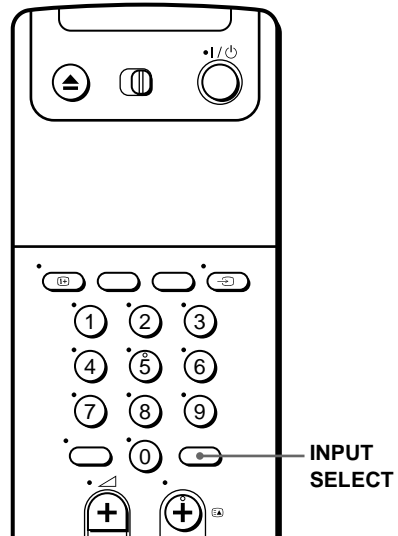
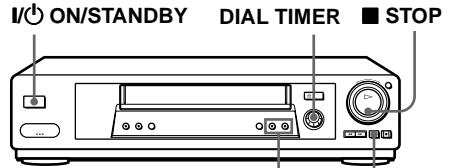

1 Press DIAL TIMER.



“DATE” and “TODAY” appear alternately in the display window.

If the date and time are not set, “DAY” will appear. See step 2 in the following section, “To set the clock” to set the date and time.

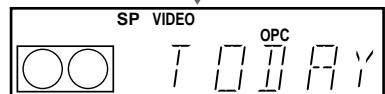
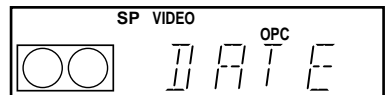

2



Turn DIAL TIMER to set the recording date.



3



Press DIAL TIMER.

“START” and the current time appear alternately in the display window.

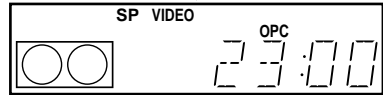

4



Turn DIAL TIMER to set the recording start time.

You can set the recording start time in 15 minute intervals or adjust the time in one minute intervals by pressing the PROGRAM +/- buttons.

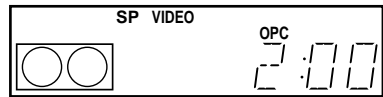

5



Press DIAL TIMER.

“STOP” and the recording stop time appear alternately in the display window.

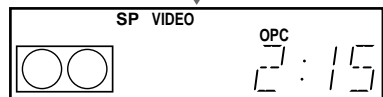
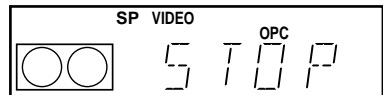

continued

6

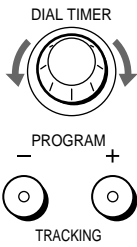

Turn DIAL TIMER to set the recording stop time.

You can set the recording stop time in 15 minute intervals or adjust the time in one minute intervals by pressing the PROGRAM +/- buttons.

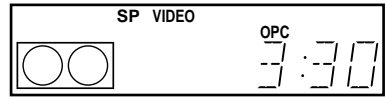

7



DIAL TIMER

Press DIAL TIMER.

The programme position or station name appears in the display window.

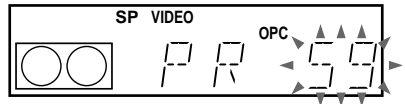

8

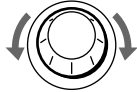

DIAL TIMER

Turn DIAL TIMER to set the programme position.

To record from a decoder or other source connected to one or more of the LINE inputs, turn DIAL TIMER or press INPUT SELECT to display the connected line in the display window.

INPUT SELECT

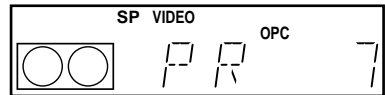

9



DIAL TIMER

Press DIAL TIMER to complete the setting.

“OK” appears in the display window for about five seconds.

The  indicator appears in the display window and the VCR stands by for recording.

To record from a decoder or other source, leave the connected equipment turned on.

To return to the previous step

To return to the previous step, press the PROGRAM + and – buttons on the VCR at the same time during any of the dial timer settings.

To stop recording

To stop the VCR while recording, press  STOP.

To use the VCR after setting the timer

To use the VCR before a recording begins, just press **I/⏻**. The **⏻** indicator turns off and the VCR turns on. Remember to press **I/⏻** to reset the VCR to recording standby after using the VCR.

You can also do the following tasks while the VCR is recording:

- Reset the counter (page 42).
- Display tape information on the TV screen (page 45).
- Check the timer settings (page 68).
- Watch another TV programme (page 45).

To set the clock

- 1** Turn DIAL TIMER so that “CLOCK” appears in the display window.
- 2** Press DIAL TIMER.
“DAY” appears in the display window.
- 3** Turn DIAL TIMER to set the day.
- 4** Press DIAL TIMER.
“MONTH” appears in the display window.
- 5** Turn and press DIAL TIMER to set the month, and then the year. After you set the year, “CLOCK” appears in the display window again.
- 6** Turn and press DIAL TIMER to set the hour and minute.
- 7** When you have finished setting the time, press DIAL TIMER to start the clock.

Tips

- To cancel a Dial Timer setting, press **■ STOP** on the VCR while you are making the setting.
- The programme is recorded in the current tape speed mode. To change the tape speed, press SP/LP before you complete the setting in step 9.
- When you are recording a programme in the SP mode and the remaining tape becomes shorter than the recording time, the tape speed is automatically changed to the LP mode. Note that some interference will appear on the picture at the point the tape speed is changed. If you want to keep the tape speed, set AUTO LONG PLAY to OFF in the OPTIONS-1 menu (page 79).
- To check, change, or cancel the programme setting, see “Checking/changing/cancelling timer settings” (page 68).

Notes

- If eight programmes have already been set using the ShowView system or the TIMER menu, “FULL” appears in the display window for about five seconds.
- The **⏻** indicator flashes in the display window when you complete the setting in step 9 with no tape inserted.
- If you set the clock using the Auto Clock Set function and AUTO ADJUST is set to ON, the clock will adjust itself to the incoming time signal regardless of adjustments made with the Dial Timer. Be sure you have set ACS correctly.
- The station name may not appear if the VCR does not receive station name information signals.

continued

About the Demonstration Mode

The DIAL TIMER function has a Demonstration Mode that allows the user, such as a salesperson, to enter more than eight examples of timer settings when demonstrating the use of the DIAL TIMER. It cancels the “FULL” notice which appears if eight programmes have already been set. Do not use the Demonstration Mode for making timer recordings. Doing so may cause the settings to be inaccurate.

To activate the Demonstration Mode

Press ■■ (pause) on the VCR while turning the DIAL TIMER. “DEMO” appears in the display window for a few seconds.

To cancel the Demonstration Mode

Turn the power off and unplug the mains lead. Although the Demonstration Mode is cancelled, the timer settings entered while using the Demonstration Mode will remain. Be sure to manually cancel the timer settings before you use the Dial Timer or any other timer method after reconnecting the mains lead (see page 68).

Recording TV programmes using the ShowView system

(not available on SLV-SE500R, SE600N and SE700R)

The ShowView system is the feature that simplifies programming the VCR to make timer recordings. Just enter the ShowView number listed in the TV programme guide. The date, times, and programme position of that programme are set automatically. You can preset a total of eight programmes, including settings made with other timer methods.

Before you start...

- Check that the VCR clock is set to the correct time and date.
- Insert a tape with its safety tab in place. Make sure the tape is longer than the total recording time.
- To record from a decoder, turn it on.
- Turn on your TV and set it to the video channel.
- Set **TIMER OPTIONS** to **SHOWVIEW** or **VARIABLE** in the **OPTIONS-2** menu (see page 79).

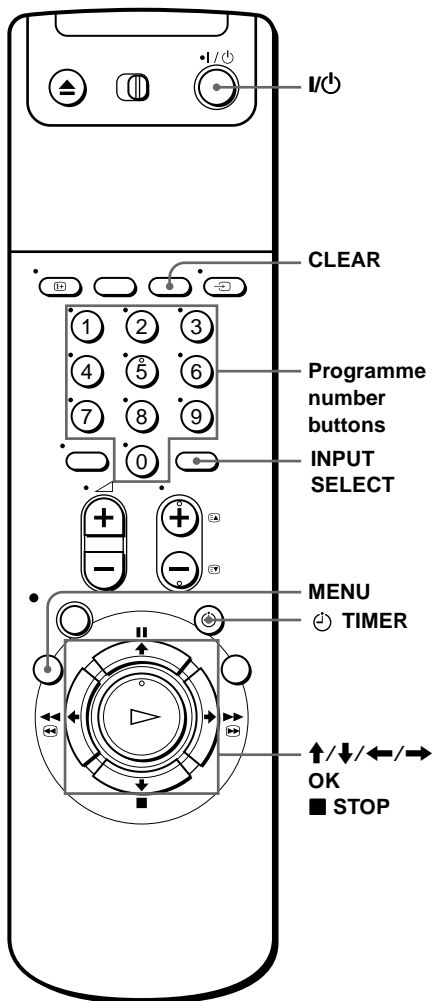

continued

1

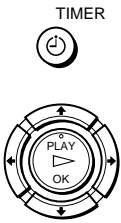

Press TIMER.

- When you set TIMER OPTIONS to VARIABLE:
The TIMER METHOD menu appears on the TV screen. Press to select SHOWVIEW, then press OK.
- When you set TIMER OPTIONS to SHOWVIEW:
The SHOWVIEW menu appears on the TV screen.

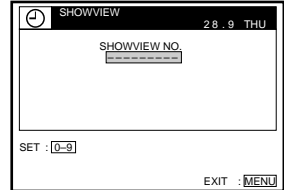
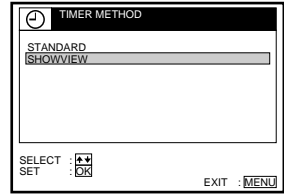

2

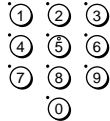

Press the programme number buttons to enter the ShowView number.



If you make a mistake, press CLEAR and re-enter the correct number.

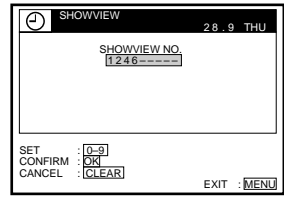

3



Press OK.

The date, start and stop times, programme position or station name, tape speed, and VPS/PDC setting appear on the TV screen.

- If “- -” appears in the “PROG.” (programme) column (this may happen for local broadcasts), you have to set the appropriate programme position manually.

Press to select the desired programme position.

To record from a decoder or other source connected to one or more of the LINE inputs, press INPUT SELECT to display the connected line in the “PROG.” position.

You will only have to do this operation once for the referred channel. The VCR will then store your setting.

If the information is incorrect, press CLEAR to cancel the setting.

INPUT SELECT



CLEAR

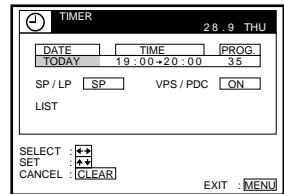

4



If you want to change the date, tape speed, and the VPS/PDC setting:

1 Press ←/→ to highlight the item you want to change.

2 Press ↑/↓ to reset it.

- To record the same programme every day or the same day every week, see “Daily/weekly recording” below.
- To use the VPS/PDC function, set VPS/PDC to ON. For details of the VPS/PDC function, see “Timer recording with VPS/PDC signals” below.

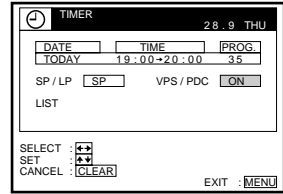

5



Press MENU to exit the menu.

6



Press I/⏻ to turn off the VCR.

The ⏻ indicator appears in the display window and the VCR stands by for recording.

To record from a decoder or other source, leave the connected equipment turned on.

To stop recording

To stop the VCR while recording, press ■ STOP.

Daily/weekly recording

In step 4 above, press ↓ to select the recording pattern. Each time you press ↓, the indication changes as shown below. Press ↑ to change the indication in reverse order. **TODAY** → **SUN-SAT (Sunday to Saturday)** → **MON-SAT (Monday to Saturday)** → **MON-FRI (Monday to Friday)** → **SAT (every Saturday)** → **MON (every Monday)** → **SUN (every Sunday)** → **1 month later** → **(dates count down)** → **TOMORROW** → **TODAY**

Timer recording with VPS/PDC signals

Some broadcast systems transmit VPS (Video Programme System) or PDC (Programme Delivery Control) signals with their TV programmes. These signals ensure that your timer recordings are made regardless of broadcast delays, early starts, or broadcast interruptions (when the VPS or PDC indicator in the display window is lit).

To use the VPS/PDC function, set VPS/PDC to ON in step 4 above. You can also use the VPS/PDC function for a source connected to one or more of the LINE inputs.

continued

To record satellite broadcasts

If you connect a satellite tuner and the VCR, you can record satellite programmes.

- 1 Turn on the satellite tuner.
- 2 On the satellite tuner, select the satellite programme for which you want to make a timer setting.
- 3 Follow steps 1 through 6 above.
- 4 Keep the satellite tuner turned on until the VCR finishes recording the satellite programme for which you have made a timer setting.

To use the VCR after setting the timer

To use the VCR before a recording begins, just press I/\odot . The \odot indicator turns off and the VCR switches on. Remember to press I/\odot to reset the VCR to recording standby after using the VCR.

You can also do the following tasks while the VCR is recording:

- Reset the counter (page 42).
- Display tape information on the TV screen (page 45).
- Check the timer settings (page 68).
- Watch another TV programme (page 45).

Tips

- To set the programme position, you can also use the PROG +/- or programme number buttons.
- To set the programme position with a two digit number, press -- (ten's digit) button followed by the programme number buttons.
- To set the line input video source, you can also use the PROG +/- buttons.
- To set the tape speed, you can also use the SP/LP button.
- When you are recording a programme in the SP mode and the remaining tape becomes shorter than the recording time, the tape speed is automatically changed to the LP mode. Note that some interference will appear on the picture at the point the tape speed is changed. If you want to keep the same tape speed, set AUTO LONG PLAY to OFF in the OPTIONS-1 menu (page 79).
- To check, change, or cancel the programme setting, press \leftarrow/\rightarrow to choose LIST, then press OK in step 4. For details, see step 3 in "Checking/changing/cancelling timer settings" (page 68).

Notes

- If the VPS/PDC signal is too weak or the broadcasting station failed to transmit VPS/PDC signals, the VCR will start recording at the set time without using the VPS/PDC function.
- The \odot indicator flashes in the display window when you press I/\odot with no tape inserted.
- When you set TIMER OPTIONS to STANDARD in the OPTIONS-2 menu, the SHOWVIEW menu does not appear on the TV screen. Select SHOWVIEW or VARIABLE.
- The VPS/PDC function is automatically set to OFF for the timer recording of a satellite programme.
- The station name may not appear if the VCR does not receive station name information signals.

Recording TV programmes using the timer

You can preset a total of eight programmes, including settings made with other timer methods.

Before you start...

- Check that the VCR clock is set to the correct time and date.
- Insert a tape with its safety tab in place. Make sure the tape is longer than the total recording time.
- To record from a decoder, turn it on.
- Turn on your TV and set it to the video channel.
- Set **TIMER OPTIONS*** to **STANDARD** or **VARIABLE** in the **OPTIONS-2** menu (see page 79).

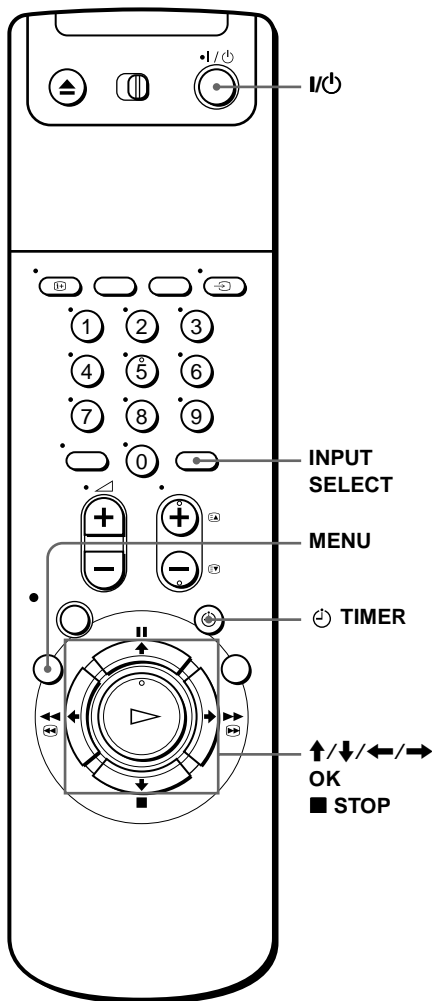

continued

1

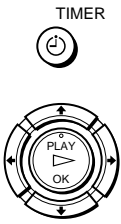

TIMER Press TIMER.

For SLV-SE500R, SE600N and SE700R:
The TIMER menu appears on the TV screen.

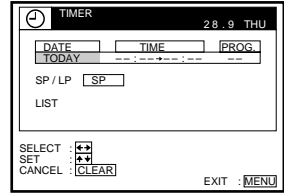

For SLV-SE350K, SE500K, SE700N/K and SE800N/K:

- When you set TIMER OPTIONS to VARIABLE:
The TIMER METHOD menu appears on the TV screen. Press to select STANDARD, then press OK.
- When you set TIMER OPTIONS to STANDARD:
The TIMER menu appears on the TV screen.

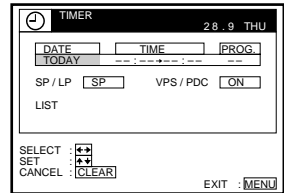
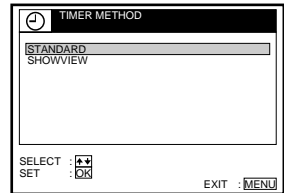

2



Set the date, start and stop times, programme position or station name*, tape speed, and VPS/PDC function*:

- 1 Press to highlight each item in turn.
- 2 Press to set each item.

To correct a setting, press to return to that setting and reset.

- To record the same programme every day or the same day every week, see “Daily/weekly recording” on page 59.
- To use the VPS/PDC function*, set VPS/PDC to ON. For details about the VPS/PDC function, see “Timer recording with VPS/PDC signals” on page 55.
- To record from a decoder or other source connected to one or more of the LINE inputs, press INPUT SELECT to display the connected line in the “PROG.” position.

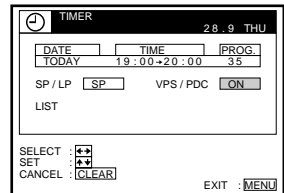

3



Press MENU to exit the menu.

4



Press **I/⏻** to turn off the VCR.

The **⏻** indicator appears in the display window and the VCR stands by for recording.

To record from a decoder or other source, leave the connected equipment turned on.

To stop recording

To stop the VCR while recording, press **■ STOP**.

Daily/weekly recording

In step 2 above, press **↓** to select the recording pattern. Each time you press **↓**, the indication changes as shown below. Press **↑** to change the indication in reverse order.
TODAY → **SUN-SAT (Sunday to Saturday)** → **MON-SAT (Monday to Saturday)** → **MON-FRI (Monday to Friday)** → **SAT (every Saturday)** → **MON (every Monday)** → **SUN (every Sunday)** → **1 month later** → **(dates count down)** → **TOMORROW** → **TODAY**

To record satellite broadcasts

If you connect a satellite tuner and the VCR, you can record satellite programmes.

- 1** Turn on the satellite tuner.
- 2** On the satellite tuner, select the satellite programme for which you want to make a timer setting.
- 3** Follow steps 1 through 4 above.
- 4** Keep the satellite tuner turned on until the VCR finishes recording the satellite programme for which you have made a timer setting.

To use the VCR after setting the timer

To use the VCR before a recording begins, just press **I/⏻**. The **⏻** indicator turns off and the VCR switches on. Remember to press **I/⏻** to reset the VCR to recording standby after using the VCR.

You can also do the following tasks while the VCR is recording:

- Reset the counter (page 42).
- Display tape information on the TV screen (page 45).
- Check the timer settings (page 68).
- Watch another TV programme (page 45).

continued

Tips

- To set the programme position, you can also use the PROG +/- or programme number buttons.
- To set the programme position with a two digit number, press -- (ten's digit) button followed by the programme number buttons.
- To set the line input video source, you can also use the PROG +/- buttons.
- To set the tape speed, you can also use the SP/LP button.
- When you are recording a programme in the SP mode and the remaining tape becomes shorter than the recording time, the tape speed is automatically changed to the LP mode. Note that some interference will appear on the picture at the point the tape speed is changed. If you want to keep the same tape speed, set AUTO LONG PLAY to OFF in the OPTIONS-1 menu (page 79).
- Even if you set TIMER OPTIONS to SHOWVIEW* in the OPTIONS-2 menu, you can set the timer manually. Press MENU to select TIMER, then go to step 2.
- To check, change, or cancel the programme setting, press ◀/▶ to choose LIST, then press OK in step 2. For details, see step 3 in "Checking/changing/cancelling timer settings" (page 68).

Notes

- When setting the timer with VPS/PDC signals, enter the start and stop times exactly as indicated in the TV programme guide. Otherwise, the VPS/PDC function* won't work.
- If the VPS/PDC signal is too weak or the broadcasting station failed to transmit VPS/PDC signals, the VCR will start recording at the set time without using the VPS/PDC function*.
- The Ⓢ indicator flashes in the display window when you press I/Ⓢ with no tape inserted.
- The VPS/PDC function* is automatically set to OFF for the timer recording of a satellite programme.
- The station name* may not appear if the VCR does not receive station name information signals.

* not available on SLV-SE500R, SE600N and SE700R

Playing/searching at various speeds

SLV-SE500K/R and SE800N/K

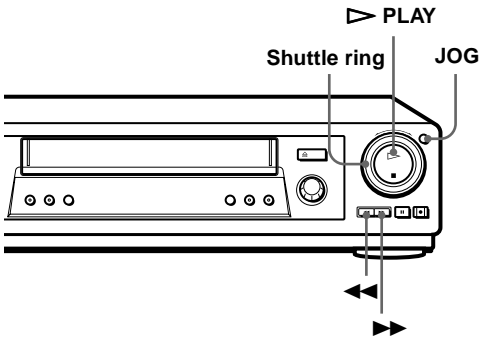

SLV-SE350K, SE600N and SE700N/K/R

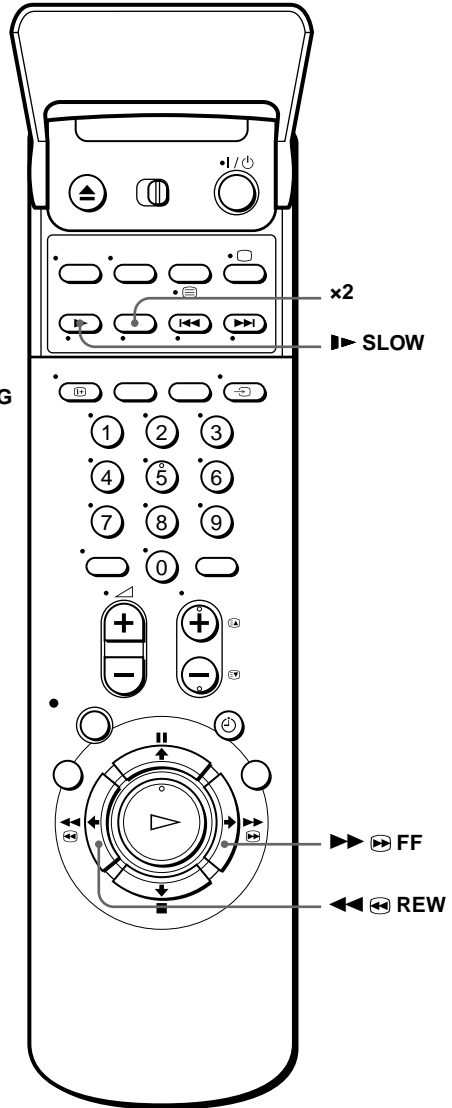
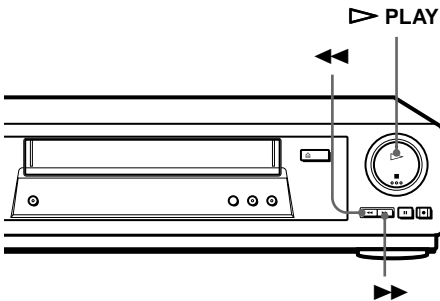

Playback options	Operation
View the picture during fast-forward or rewind	During fast-forward, hold down ▶▶ FF/▶▶ . During rewind, hold down ◀◀ REW/◀◀ .

continued

Playback options	Operation
Play at high speed	<ul style="list-style-type: none"> During playback, press ►► ⏩ FF or ◀◀ ⏪ REW <u>on the remote commander.</u> During playback, hold down ►► ⏩ FF/►► or ◀◀ ⏪ REW/◀◀. When you release the button, normal playback resumes.
Play at twice the normal speed	During playback, press ×2.
Play in slow motion	During playback, press ► SLOW.
Play frame by frame	During pause, press ►► ⏩ FF or ◀◀ ⏪ REW <u>on the remote commander.</u> Hold down ►► ⏩ FF or ◀◀ ⏪ REW to play one frame each second.
Rewind and start play	During stop, press ▷ PLAY <u>on the VCR</u> while holding down ◀◀ <u>on the VCR.</u>

To resume normal playback

Press ▷ PLAY.

Using the shuttle ring (SLV-SE500K/R and SE800N/K only)

With the shuttle ring, you can operate a variety of playback options. There are two ways for using the shuttle ring, normal mode and jog mode.

To use the shuttle ring in normal mode

During playback or pause, turn the shuttle ring clockwise or anticlockwise. Each change in the shuttle ring position changes the playback mode in the following way.

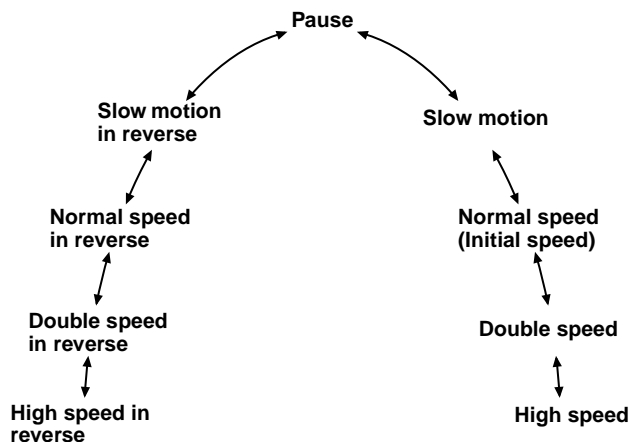

To use the shuttle ring in jog mode

Use this mode for frame-by-frame playback.

Press JOG to enter the jog mode. The JOG button lights up. If you change to the jog mode during any playback mode, playback pauses so you can see a still picture. Each change in the shuttle ring position shifts the picture one frame. To shift frames in reverse, turn the shuttle ring anticlockwise. The frame shift speed depends on the speed you turn the shuttle ring.

To resume normal mode, press JOG again. The JOG button turns off.

Tip

- Adjust the picture using the TRACKING +/- buttons if:
 - Streaks appear while playing in slow motion.
 - Bands appear at the top or bottom while pausing.
 - The picture shakes while pausing.To set tracking to the centre position, press both buttons (+/-) at the same time.

Notes

- The sound is muted during these operations.
- In the LP mode, noise may appear or there may be no colour.
- If the playback mode mark doesn't appear on the TV screen, press (I+) DISPLAY.
- The picture may show noise when playing at high speed in reverse.*

* SLV-SE350K only

Setting the recording duration time

After you have started recording in the normal way, you can have the VCR stop recording automatically after a specified duration.

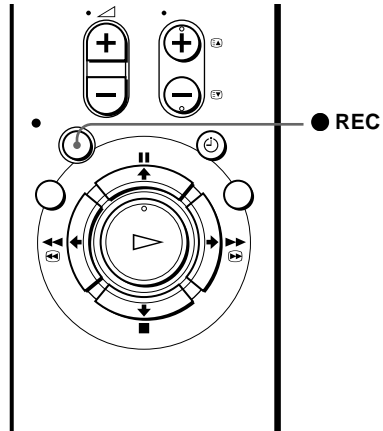

- 1 While recording, press ● REC.

The ⌚ indicator appears in the display window.

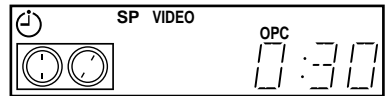

- 2 Press ● REC repeatedly to set the duration time.

Each press advances the time in increments of 30 minutes.

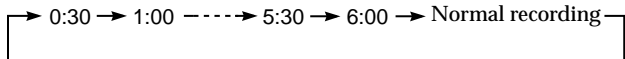

The tape counter decreases minute by minute to 0:00, then the VCR stops recording and turns off automatically.

To extend the duration

Press ● REC repeatedly to set a new duration time.

To cancel the duration

Press ● REC repeatedly until the ⌚ indicator disappears and the VCR returns to the normal recording mode.

To stop recording

To stop the VCR while recording, press ■ STOP.

Note

- You cannot display the current tape time in the display window when setting the recording duration time.

Synchronized Recording

(SLV-SE500K and SE800N/K only)

You can set the VCR to automatically record programmes from equipment such as a satellite tuner by connecting the equipment to the DECODER/LINE-3 IN connector. The connected equipment must have a timer function for this feature to work.

When the connected equipment turns on, the VCR also automatically turns on and starts recording a programme from DECODER/LINE-3 IN.

How to connect for Synchronized Recording

Connect the DECODER/LINE-3 IN connector of the VCR to the TV Scart connector of the satellite tuner. Then connect the LINE-1 (TV) connector to the TV.

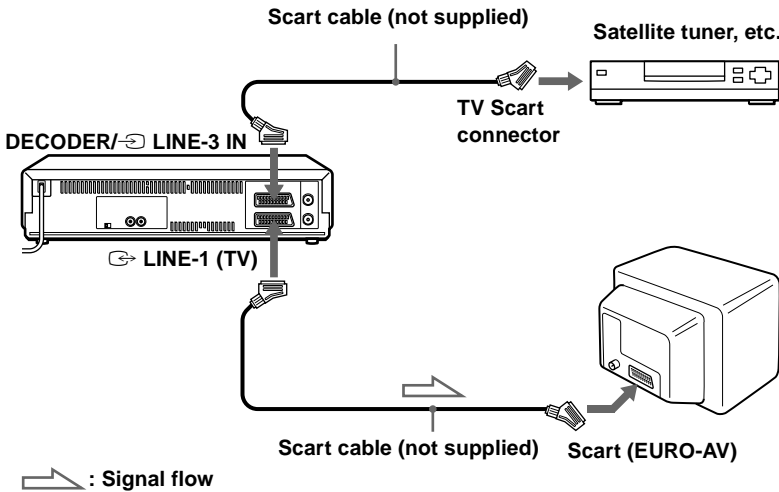

continued

Recording programmes using the Synchronized Recording function

Before you start...

- Insert a tape with its safety tab in place. Make sure the tape is longer than the total recording time.
- Set DECODER/LINE3 to LINE3 in the OPTIONS-2 menu (see page 79).

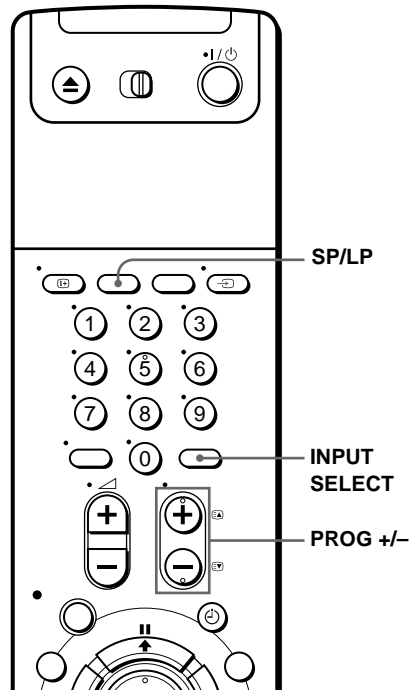
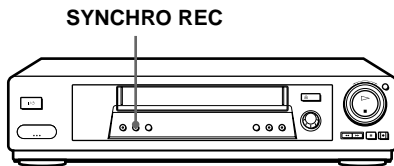

- 1** Press INPUT SELECT or PROG +/- to display "L3" in the display window.
- 2** Set the timer on the connected equipment to the time of the programme you want to record, then turn it off.
- 3** Press SP/LP to select the tape speed.
- 4** Hold down SYNCHRO REC for more than two seconds.

The SYNCHRO REC button lights up and the VCR stands by for recording.

The VCR automatically turns on and starts recording when it receives an input signal from the connected equipment.

The VCR automatically stops recording when the tape reaches the end or when the connected equipment stops transmitting an input signal.

To cancel the Synchronized Recording function

Press SYNCHRO REC. The SYNCHRO REC button turns off.

To stop recording

Press ■ STOP while recording.

Notes

- This function may not work with some types of satellite tuners.
- Some TVs or other equipment with timer functions will automatically turn off if no operation is performed within a certain amount of time. In this case, the Synchronized Recording also stops automatically.
- When the connected equipment turns on while the SYNCHRO REC button is lit, recording starts automatically.
- If the settings for timer recording and Synchronized Recording overlap, the programme that starts first has priority and the second programme starts recording only after the first programme has finished.
- The Auto Clock Set function does not work while the VCR stands by for Synchronized Recording.

Checking/changing/cancelling timer settings

Before you start...

- Turn on your TV and set it to the video channel.

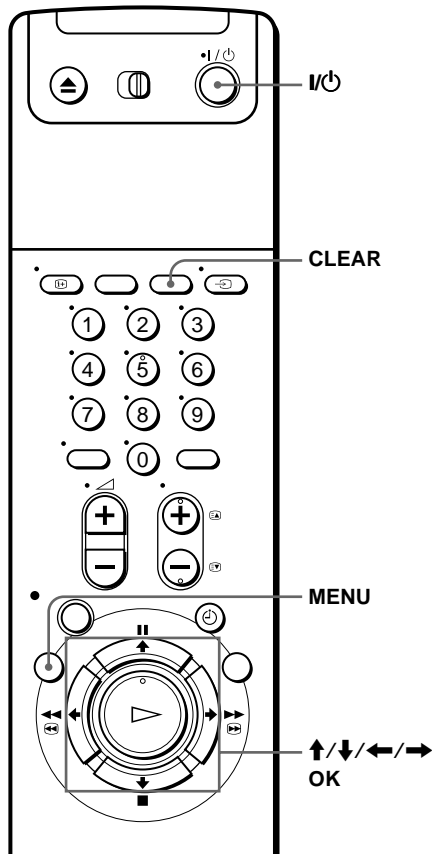

- 1 Press I/⏻ to turn on the VCR.
- 2 Press MENU, then press ⬆️/⬇️ to highlight LISTS and press OK.
- 3 Press ⬆️/⬇️ to highlight TIMER LIST, then press OK:

- If you want to change or cancel a setting, go on to the next step.
- If you do not need to change or cancel the settings, press MENU, then turn off the VCR to return to recording standby.

DATE	TIME	PROG.	SP.
TODAY	19:00+20:00	35	SP
30.9	20:00+21:00	AAB	LP
2.10	10:00+11:30	CDE	LP
MON-FRI	14:00+15:00	FGH	LP
SUN	6:30+7:00	IJK	SP
---	---	---	---

RETURN: []
SELECT: []
SET: []
CANCEL: [CLEAR]
EXIT: MENU

- 4 Press **↑/↓** to select the setting you want to change or cancel, then press OK.

The selected setting appears in the TIMER menu.

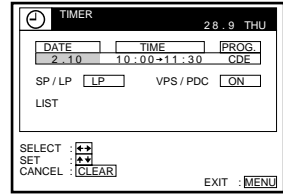

- 5 • To change the setting, press **←/→** to highlight the item you want to change, then press **↑/↓** to reset it.
- To cancel the setting, press CLEAR.

- 6 Press MENU to exit the menu.

If any settings remain, turn off the VCR to return to recording standby.

When the timer settings overlap

The programme that starts first has priority and the second programme starts recording only after the first programme has finished. If the programmes start at the same time, the programme listed first in the menu has priority.

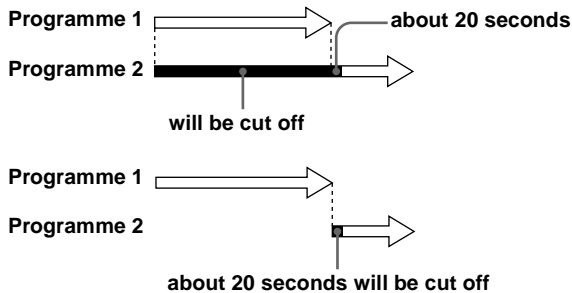

Tip

- In step 6 above, you can check the TIMER LIST by selecting LIST and pressing OK. Press MENU to exit the TIMER LIST.

Recording stereo and bilingual programmes

(not available on SLV-SE350K, SE500K/R and SE700R)

In ZWEITON (German stereo) system

This VCR automatically receives and records stereo and bilingual programmes based on the ZWEITON system. When a stereo or bilingual programme is received, the STEREO indicator appears in the display window.

To select bilingual sound while recording

Press AUDIO MONITOR to select the sound you want.

To listen to	On-screen display	Display window
Main	MAIN	STEREO
Sub	SUB	STEREO
Main and sub	MAIN/SUB	STEREO

In NICAM system (SLV-SE600N, SE700N, and SE800N only)

This VCR receives and records stereo and bilingual programmes based on the NICAM system (The NICAM indicator appears). When a stereo or bilingual programme is received, the STEREO indicator appears in the display window.

To record a NICAM programme, HIFI AUDIO in the OPTIONS-1 menu should be set to NICAM (initial setting). To check the menu setting, see page 78 for details.

To select the sound while recording

Press AUDIO MONITOR to select the sound you want.

Stereo programmes

To listen to	On-screen display	Display window
Stereo	STEREO	STEREO
Standard sound*	No indicator	No indicator

* Usually the mixed sound of left and right channels (monaural)

Bilingual programmes

To listen to	On-screen display	Display window
Main	MAIN	STEREO
Sub	SUB	STEREO
Main and sub	MAIN/SUB	STEREO
Standard sound*	No indicator	No indicator

* Usually the main sound (monaural)

Selecting the sound during playback

Press AUDIO MONITOR to select the sound you want.

To listen to	On-screen display	Display window
Stereo/main and sub (left and right channels)	STEREO	STEREO
Left channel/main	LCH	STEREO
Right channel/sub	RCH	STEREO
Standard sound	No indicator	No indicator

How sound is recorded on a video tape

The VCR records sound onto two separate tracks. Hi-fi audio is recorded onto the main track along with the picture. Monaural sound is recorded onto the normal audio track along the edge of the tape.

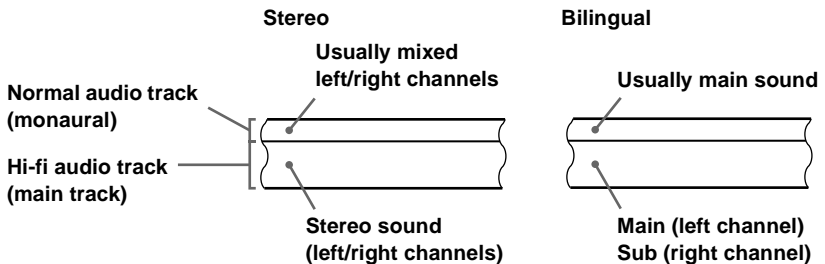

Notes

- To listen to playback sounds in stereo, you must use the Scart or AUDIO OUT connections.
- When you play a tape recorded in monaural, the sound is heard in monaural regardless of the AUDIO MONITOR setting.
- If the AUDIO MONITOR button does not function, check that AUDIO MIX in the OPTIONS-1 menu is set to OFF (see page 78).
- If HIFI AUDIO* is set to STANDARD, the standard sound will be recorded on both the hi-fi and normal audio tracks. Pressing AUDIO MONITOR will not change the sound.

* SLV-SE600N, SE700N, and SE800N only

Searching using the Smart Search function

If you record multiple programmes on a tape, use the Smart Search function to see what has been recorded on your tape. You can see information such as date, time, and programme position of programmes recorded on a tape. You can also start playback directly from the selected programme using the SMART SEARCH screen.

All programmes are listed on the screen, regardless of how the programme was recorded.

The data of the last tape inserted into the VCR is automatically stored in memory. If you want to recall the latest data screen, select LATEST DATA in the SMART SEARCH screen (see page 73).

Before you start...

- Turn on your TV and set it to the video channel.

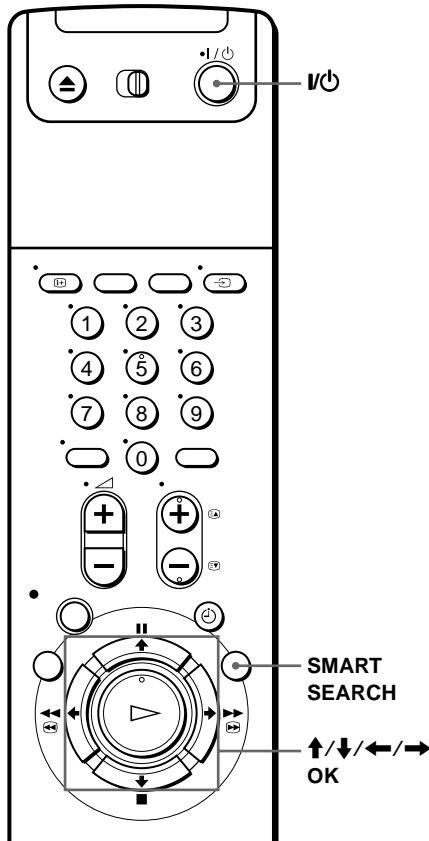

- 1 After recording, press I/O to turn on the VCR.
- 2 Press SMART SEARCH.
- 3 Press ↑/↓/←/→ to select the programme you want to start viewing.

SMART SEARCH			180 MIN.
DATE	TIME	PROG	
28.9	19:00-20:00	35	
29.9	14:00-15:00	FGH	
30.9	20:00-21:00	AAB	
1.10	6:30-7:00	IJK	

BLANK TIME 30 MIN.

SELECT SET: [OK]

EXIT: [SMART SEARCH]

4 Press OK.

The VCR starts searching, and playback starts automatically from the beginning of the selected programme.

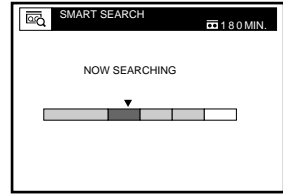

To stop searching

Press ■ STOP.

To exit the SMART SEARCH screen

Press SMART SEARCH.

To record in a blank space

Blank space on the tape will appear as a blank row in the SMART SEARCH screen. Select the last blank row in step 3, then press OK. The VCR rewinds/fast-forwards the tape to the beginning of the blank space, then stops. Start recording. Note that "BLANK TIME" and the remaining time indication only refers to the length of the last blank space.

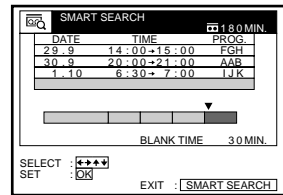

To recall the latest data screen after you remove the tape

You can display the data of the last tape used to record a programme, even after you have removed the tape.

If you reinsert the tape and record additional programmes, be sure to select LATEST DATA. Otherwise, all of the data for the tape is deleted.

1 Reinsert the last tape that you used to record a programme.

2 Press SMART SEARCH.

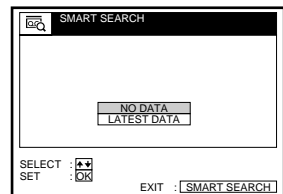

continued

3 Press **↑/↓** to highlight LATEST DATA.

If you want to reset the latest data screen, highlight NO DATA and press OK, then record a programme.

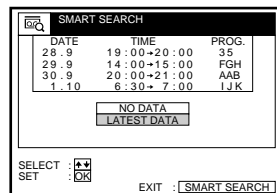

4 Press OK.

The latest data stored in the VCR's memory is displayed.

Tips

- You can store information for up to 24 programmes on a single list.
- While recording, you can display the SMART SEARCH screen using the SMART SEARCH button. If you decide to stop recording, press SMART SEARCH to make the SMART SEARCH screen disappear first. Then press **■** STOP.

Notes

- You cannot use this function unless the clock is set.
- Depending on the tape, the total or remaining time may not appear correctly.
- If many short programmes are recorded on a tape, multiple programmes may be included in a single block. In this case, only the latest programme information will appear in the SMART SEARCH screen.
- Blank time is measured from the end of the last recorded programme to the end of the tape. However, if you eject the tape and then make a new recording on the same tape, the original recorded programme(s) is displayed as a blank space.
- If no information is stored in the VCR's memory, LATEST DATA does not appear in the SMART SEARCH screen.
- The station name* may not appear if the VCR does not receive station name information signals.
- If you start recording a programme "D" from the middle of a previously recorded programme "A" and into another previously recorded programme "B," the Smart Search information for the second programme "B," which is recorded over, is deleted.

Originally recorded programmes

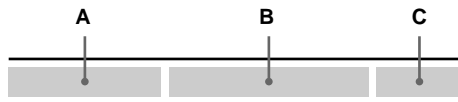

Recording the programme "D" over the programme "A" and "B"



* not available on SLV-SE500R, SE600N and SE700R

Searching using the index function

The VCR automatically marks the tape with an index signal at the point where each recording begins. Use these signals as references to find a specific recording.



1 Insert an indexed tape into the VCR.

2 Press **◀◀/▶▶** INDEX SEARCH.

- To search ahead, press **▶▶** INDEX SEARCH.
- To search backwards, press **◀◀** INDEX SEARCH.

The VCR starts searching, and playback starts automatically from that point.

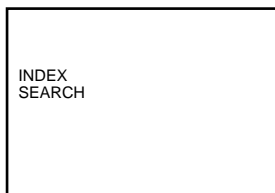

To stop searching

Press **■** STOP.

Notes

- No index signal will be added when recording starts from recording pause. However, an index signal will be marked if you change the programme position during recording pause.
- When you press **◀◀** INDEX SEARCH, if there is nothing recorded before the selected index signal, playback may not start exactly at the index signal.

Adjusting the picture

Adjusting the tracking

Although the VCR automatically adjusts the tracking when playing a tape (the  indicator flashes in the display window, then turns off), distortion may occur if the recording is in poor condition. In this case, manually adjust the tracking.

During playback, press TRACKING +/- to display the tracking meter. The distortion should disappear as you press one of the two buttons (the  indicator lights up). To resume automatic tracking adjustments, eject the tape and re-insert it.

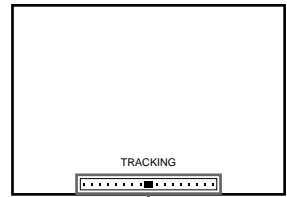

Tracking meter

About the Reality Regenerator (RR) function (not available on SLV-SE350K and SE600N)

The Reality Regenerator (RR) function automatically restores the picture to its original quality during playback.

To use the RR function, press RR. The RR button lights up. You can set RR to NORMAL or HIGH in the OPTIONS-2 menu (see page 79).

To turn it off, press RR. The RR button turns off.

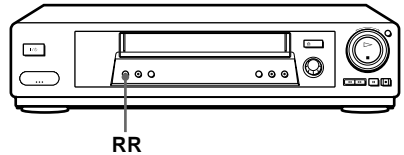

About the Optimum Picture Control (OPC) function

The Optimum Picture Control (OPC) function automatically improves recording and playback quality by adjusting the VCR to the condition of the video heads and tape. To maintain better picture quality, we recommend that you set OPC to ON in the OPTIONS-1 menu (the OPC indicator lights up in the display window). For details, see page 78.

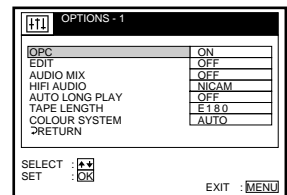

OPC playback

The OPC function automatically works on all types of tapes, including rental tapes and tapes that were not recorded with OPC.

OPC recording

Whenever you insert a tape and start recording for the first time, the VCR adjusts to the tape using the OPC function (the OPC indicator flashes rapidly). This adjustment is retained until the tape is ejected.

To deactivate the OPC function

Set OPC to OFF in the OPTIONS-1 menu. The OPC indicator in the display window turns off.

Tip

- To set tracking to the centre position, press the TRACKING + and – buttons at the same time.

Notes

- You can adjust the tracking for an NTSC-recorded tape but the tracking meter won't be displayed.
- With the Auto Long Play function on, the OPC function will work only in SP mode. If the tape speed automatically switches from SP to LP, the OPC function turns off. If, however, the entire programme is recorded in LP mode, the OPC function will work.
- There is a delay of about ten seconds before the VCR actually starts recording while the VCR analyses the tape. To avoid the delay, first set the VCR to recording pause (the OPC indicator flashes slowly) and press ● REC to have the VCR analyse the tape (the OPC indicator flashes rapidly) and return to recording pause. After the OPC indicator stops flashing, press ■ PAUSE to start recording immediately.
If you want to start recording quickly without using the OPC function, first set the VCR to recording pause (the OPC indicator flashes slowly) and press ■ PAUSE again to start recording.

Changing menu options

- 1 Press MENU, then select OPTIONS and press OK.

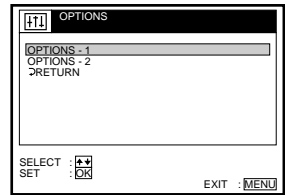

- 2 Press **↑/↓** to highlight OPTIONS-1 or OPTIONS-2, then press OK.

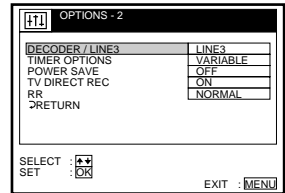
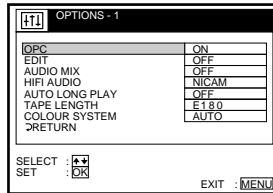

- 3 Press **↑/↓** to select the option, then press OK.

- 4 Press **↑/↓** to change the setting, then press OK.

- 5 Press MENU to return to the original screen.

Menu choices

Initial settings are indicated in bold print.

OPTIONS-1

Menu option	Set this option to
OPC	<ul style="list-style-type: none"> • ON to switch on the OPC (Optimum Picture Control) function and improve picture quality. • OFF to switch off OPC.
EDIT	<ul style="list-style-type: none"> • ON to minimize picture deterioration when editing. • OFF to turn off EDIT.
AUDIO MIX*1	<ul style="list-style-type: none"> • ON to listen to the hi-fi and normal audio tracks at the same time. The AUDIO MONITOR button will not function. • OFF to listen to the hi-fi and normal audio tracks separately. Select the sound using the AUDIO MONITOR button. <p>If you press ▲ EJECT or turn the VCR off, AUDIO MIX will be reset to OFF. For details, see page 71.</p>
HIFI AUDIO*2	<ul style="list-style-type: none"> • NICAM to record NICAM broadcasts on the hi-fi audio track. • STANDARD to record standard sound on the hi-fi audio track. <p>For details, see page 70.</p>

Menu option	Set this option to
AUTO LONG PLAY	<ul style="list-style-type: none"> ON to change the timer recording tape speed automatically to the LP mode when the remaining tape length becomes shorter than the recording time. Note that for AUTO LONG PLAY to work correctly, the TAPE LENGTH setting must be accurate. OFF to keep the set tape speed.
TAPE LENGTH	<ul style="list-style-type: none"> E180 to use an E-180 or shorter type tape. E195 to use an E-195 type tape. E240 to use an E-240 type tape. E300 to use an E-300 type tape.
COLOUR SYSTEM	<ul style="list-style-type: none"> AUTO to set the colour system automatically. PAL to play back a tape recorded in the PAL colour system. MESECAM to play back a tape recorded in the MESECAM colour system. <p>If you press ▲ EJECT or turn the VCR off, COLOUR SYSTEM will be reset to AUTO.</p>

OPTIONS-2

Menu option	Set this option to
DECODER/LINE2*3	<ul style="list-style-type: none"> DECODER to use the DECODER/LINE-2 IN*3 connector as the Canal Plus decoder connector. LINE2*3 to use the DECODER/LINE-2 IN*3 connector as the line input connector.
DECODER/LINE3*4	<ul style="list-style-type: none"> DECODER to use the DECODER/LINE-3 IN*4 connector as the Canal Plus decoder connector. LINE3*4 to use the DECODER/LINE-3 IN*4 connector as the line input connector.
TIMER OPTIONS*5	<ul style="list-style-type: none"> VARIABLE to display the TIMER METHOD menu for selecting STANDARD or SHOWVIEW when pressing the ⏸ TIMER button. STANDARD to display the TIMER menu when pressing the ⏸ TIMER button. SHOWVIEW to display the SHOWVIEW menu when pressing the ⏸ TIMER button. <p>For details, see page 53 and 57.</p>
POWER SAVE	<ul style="list-style-type: none"> ON to turn off the indicators in the display window to conserve the VCR's power. OFF to turn on the indicators in the display window while the VCR is standing by.
TV DIRECT REC*6	<ul style="list-style-type: none"> ON to activate the TV Direct Rec function. OFF to deactivate it.
RR*7	<ul style="list-style-type: none"> NORMAL for normal everyday use. HIGH for well-used video tapes such as rented tapes. Select this option when NORMAL does not improve the picture quality.

continued

Notes

- When you set a timer recording, the indicators in the display window remain on, even though POWER SAVE is set to ON.
- With the EDIT option ON, the OPC function does not work.

*¹ not available on SLV-SE350K and SE500K/R

*² SLV-SE600N, SE700N and SE800N only

*³ SLV-SE700N/K only

*⁴ SLV-SE500K and SE800N/K only

*⁵ not available on SLV-SE500R, SE600N and SE700R

*⁶ not available on SLV-SE600N and SE700R

*⁷ not available on SLV-SE350K and SE600N

Connecting to a VCR or stereo system

How to connect to record on this VCR

Connect the line outputs of the other VCR to the LINE IN connector or jacks of this VCR. Refer to the examples A through C and choose the connection that best suits your VCR.

Example A

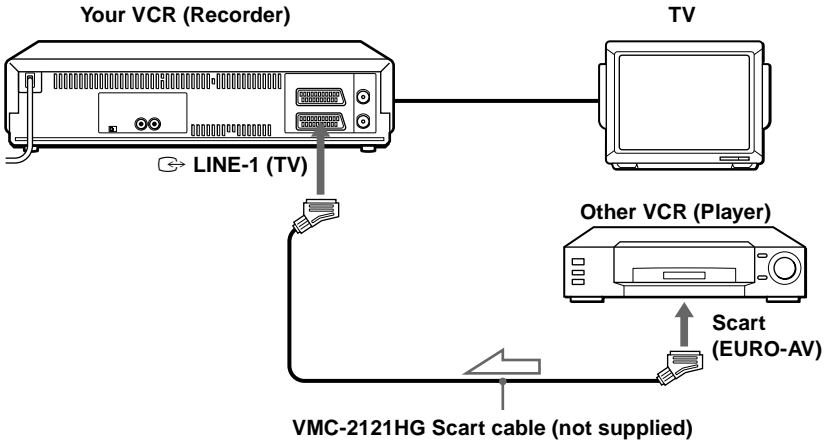

 : Signal flow

Example B

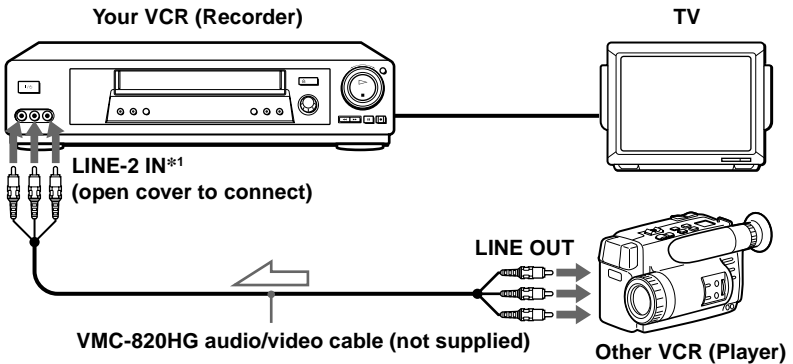

 : Signal flow

continued

Example C

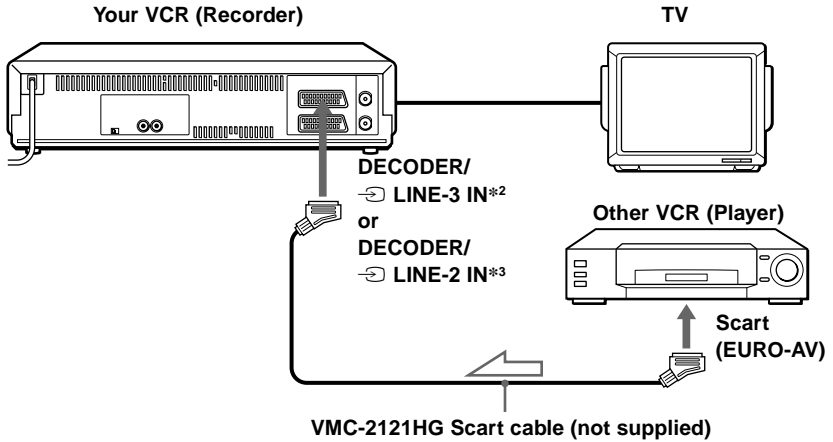

 : Signal flow

How to connect to a stereo system (SLV-SE500K/R and SE800N/K only)

Connect the LINE-2 IN AUDIO L/R jacks on this VCR to the audio output jacks on the stereo system, using the RK-C510HG audio cable (not supplied).

Notes

- Make sure you connect the plugs to jacks of the same colour.
- If the other VCR is a monaural type, leave the red plugs unconnected.
- If you connect this VCR to both the LINE IN and LINE OUT jacks of the other VCR, select the input correctly to prevent a humming noise.
- If the other VCR does not have a Scart (EURO-AV) connector, use the VMC-2106HG cable instead and connect the cable to the line out jacks of the other VCR.
- When you connect another VCR to the DECODER/LINE-3 IN*2 (or DECODER/LINE-2 IN*3) connector, set DECODER/LINE3*2 (or DECODER/LINE2*3) to LINE3*2 (or LINE2*3) in the OPTIONS-2 menu.

*1 SLV-SE500K/R and SE800N/K only (AUDIO R (right) jack is not available on SLV-SE500K/R.)

*2 SLV-SE500K and SE800N/K only

*3 SLV-SE700N/K only

Basic editing

(when recording on this VCR)

Before you start editing

- Turn on your TV and set it to the video channel.
- Press INPUT SELECT to display the connected line in the display window.
- Press SP/LP to select the tape speed, SP or LP.
- On this VCR, set EDIT to ON in the OPTIONS-1 menu. If the other VCR has a similar function, turn it on as well.

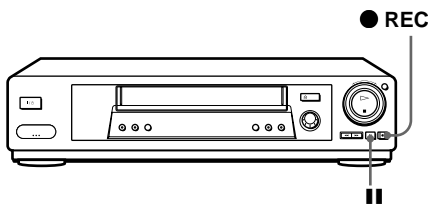

- 1** Insert a source tape with its safety tab removed into the other (playback) VCR. Search for the point to start playback and set it to playback pause.
- 2** Insert a tape with its safety tab in place into this (recording) VCR. Search for the point to start recording and press **||** (pause).
- 3** Press **● REC** on this VCR to set it to recording pause.
- 4** To start editing, press the **||** (pause) buttons on both VCRs at the same time.

To stop editing

Press the **■ STOP** buttons on both VCRs.

Tip

- To cut out unwanted scenes while editing, press **||** (pause) on this VCR when an unwanted scene begins. When it ends, press **||** (pause) again to resume recording.

Note

- If you start editing following the procedure above, the VCR won't start recording with the OPC function. To record a tape with the OPC function, press **● REC** again during recording pause in step 3 so the VCR analyses the tape. Then, press **||** (pause) after the OPC indicator stops flashing to start recording. If you press **||** (pause) before the OPC indicator stops flashing, the OPC function is cancelled.

Audio dubbing

(SLV-SE500K/R and SE800N/K only)

This feature lets you record over the normal audio track. The monaural sound previously recorded is replaced while the original hi-fi sound remains unchanged. Use this feature to add commentary to a tape that you have recorded with a camcorder.

Before you start...

- Open the LINE-2 IN AUDIO L/R jacks cover on the front panel and connect a playback source.*
- Turn on the TV and set it to the video channel.

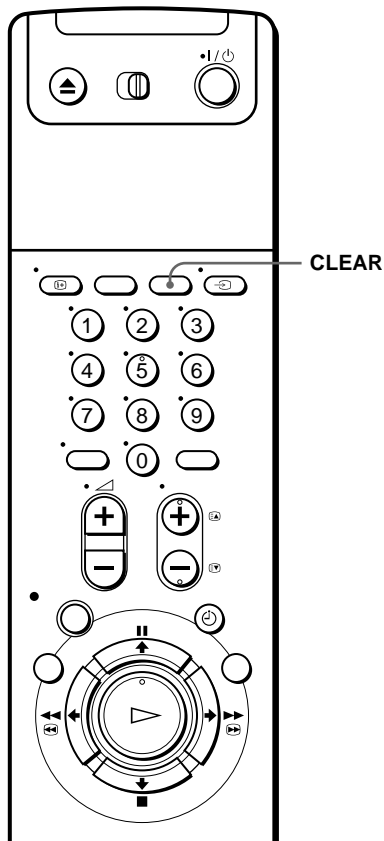
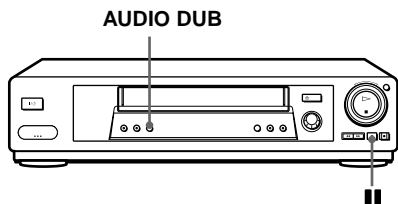

- 1** Insert a source tape into your stereo system (or the playback VCR). Search for the point to start playback and set it to playback pause.
- 2** Insert a prerecorded tape with its safety tab in place into this (recording) VCR. Search for the start of the section to be replaced and press **||** (pause).
The VCR enters pause mode.
- 3** Press AUDIO DUB.
The programme position changes to "L2," and the \ominus indicator appears in the display window.

- 4** To start editing, press the **||** (pause) buttons on this VCR and the stereo system (or other VCR) at the same time.

After you use this feature, the audio in playback mode is automatically set to monaural.

To stop editing

Press **■ STOP** on this VCR and the stereo system (or other VCR).

To listen to both the hi-fi and normal audio (not available on SLV-SE350K and SE500K/R)

Set AUDIO MIX to ON in the OPTIONS-1 menu (page 78). Use this feature to listen to dubbed audio over the original hi-fi audio. When AUDIO MIX is set to ON, the AUDIO MONITOR button does not function.

Remember to reset AUDIO MIX to OFF after playing the tape.

Note

- If you eject the tape or turn the VCR off, AUDIO MIX is automatically set to OFF.
- * SLV-SE500K/R does not have the AUDIO R (right) jack.

Troubleshooting

If you have any questions or problems not covered below, please consult your nearest Sony service facility.

	Symptom	Remedy
Power	The I/ON/STANDBY switch does not function.	<ul style="list-style-type: none">• Connect the mains lead to the mains securely.
	The power is turned on but the VCR does not operate.	<ul style="list-style-type: none">• Moisture condensation has occurred. Turn the power off, unplug the mains lead and leave the VCR to dry for over three hours.
	The VCR is plugged in but the display window remains dark.	<ul style="list-style-type: none">• Set POWER SAVE to OFF (see page 79).
Clock	The clock has stopped and “--:--” appears in the display window.	<ul style="list-style-type: none">• The clock stops if the VCR is disconnected from the mains for more than one hour. Reset the clock (and timer).

	Symptom	Remedy
Playback	The playback picture does not appear on the TV screen.	<ul style="list-style-type: none"> • Make sure the TV is set to the video channel. If you are using a monitor, set it to video input. • If the VCR is connected to the TV with the Scart cable, make sure the VIDEO indicator is lit in the display window. Use the TV/VIDEO button on the remote commander to light up the VIDEO indicator.
	The picture is not clear.	<ul style="list-style-type: none"> • If your TV is connected to the VCR with both Scart and aerial cables, make sure the RF channel is set to OFF (see page 16). • Existing broadcasts may interfere with the VCR. Reset the RF channel output of your VCR. • Adjust the tracking with the TRACKING +/- buttons. • The video heads are dirty (see the last page of Troubleshooting). Clean the video heads using the Sony T-25CLD, E-25CLDR, or T-25CLW video head cleaning cassette. If these cleaning cassettes are not available in your area, have the heads cleaned at your nearest Sony service facility (a standard service charge will be required). Do not use a commercially available liquid type cleaning cassette other than Sony's, as it may damage the video heads. • The video heads may have to be replaced. Consult your local Sony service facility for more information.
	The picture has no colour.	<ul style="list-style-type: none"> • The COLOUR SYSTEM option in the OPTIONS-1 menu is set to the wrong position. Set the option to conform to the system that the tape was recorded in.
	The picture rolls vertically during picture search.	<ul style="list-style-type: none"> • Adjust the vertical hold control on the TV or monitor.
	The picture has no sound.	<ul style="list-style-type: none"> • The tape is defective. • If you made A/V connections, check the audio cable connection.
	The sound is unstable or has an echo.	<ul style="list-style-type: none"> • When you play a tape with the same sound recorded on both the hi-fi and normal audio tracks, make sure AUDIO MIX in the OPTIONS-1 menu is set to OFF.
	The sound from a tape recorded with this VCR is not in stereo or the STEREO indicator in the display window is flashing.	<ul style="list-style-type: none"> • Adjust the tracking with the TRACKING +/- buttons. • The video heads are dirty. Clean the video heads using the Sony T-25CLD, E-25CLDR, or T-25CLW video head cleaning cassette.

continued

	Symptom	Remedy
Recording	No TV programme appears on the TV screen.	<ul style="list-style-type: none"> • Make sure the TV is set to the video channel. If you are using a monitor, set it to video input. • If your TV is connected to the VCR with both Scart and aerial cables, make sure the RF channel is set to OFF (see page 16). • Existing broadcasts may interfere with the VCR. Reset the RF channel output of your VCR. • Select the correct source with the INPUT SELECT button. Select a programme position when recording TV programmes; select a line input when recording from other equipment.
	TV reception is poor.	<ul style="list-style-type: none"> • Make sure the aerial cable is connected securely. • Adjust the TV aerial. • Make sure the TV system is correctly set for your TV. • Make sure SYSTEM (B/G or D/K) in the TUNER menu is set to the same system in your local area.
	The tape starts playing as soon as it is inserted.	<ul style="list-style-type: none"> • The safety tab has been removed. To record on this tape, cover the tab hole (see page 46).
	The tape is ejected when you press ● REC.	<ul style="list-style-type: none"> • The safety tab has been removed. To record on this tape, cover the tab hole (see page 46).
	Nothing happens when you press ● REC.	<ul style="list-style-type: none"> • Make sure the tape is not at its end.
Timer recording	The timer does not operate.	<ul style="list-style-type: none"> • Check that the clock is set. • Make sure a tape has been inserted. • Check that the safety tab has not been removed. • Make sure the tape is not at its end. • Make sure a programme has been set for timer recording. • Make sure your timer settings are past the current time. • Check that the decoder is turned on. • Check that the satellite tuner is turned on. • The clock stops if the VCR is disconnected from the mains for more than one hour. Reset the clock and timer. • Turn the power off and unplug the mains lead.
	The SHOWVIEW menu or the TIMER menu does not appear.	<ul style="list-style-type: none"> • Check that TIMER OPTIONS in the OPTIONS-2 menu is set correctly (see page 79).
	The VPS/PDC function does not operate properly.	<ul style="list-style-type: none"> • Check that the clock and the date are set correctly. • Check that the VPS/PDC time you set is the correct one (there might be a mistake in the TV programme guide). If the broadcast you wanted to record did not send the good VPS/PDC information, the VCR will not start recording. • If the reception is poor, the VPS/PDC signal might be altered and the VCR might not start recording.

	Symptom	Remedy
Synchronized Recording	The SYNCHRO REC button turns off while recording or does not go back to recording standby mode.	<ul style="list-style-type: none"> The tape has reached its end. Insert a new tape and press SYNCHRO REC again.
	The Synchronized Recording function does not work.	<ul style="list-style-type: none"> The connected equipment was not turned off. Turn off the connected equipment and press SYNCHRO REC again. There was a power failure. Press SYNCHRO REC again.
	The programme recorded with the Synchronized Recording function is incomplete.	<ul style="list-style-type: none"> If the settings for timer recordings and Synchronized Recording overlap, the programme that starts first has priority and the second programme starts recording only after the first programme has finished. There was a power failure. Press SYNCHRO REC again.
PAY-TV/Canal Plus	You cannot set channels as PAY-TV/Canal Plus in the TUNER menu.	<ul style="list-style-type: none"> Check that DECODER/LINE3 (or DECODER/LINE2) in the OPTIONS-2 menu is set to DECODER (see page 79).
	You cannot watch Canal Plus programmes when the VCR is in standby mode.	<ul style="list-style-type: none"> Check that DECODER/LINE3 (or DECODER/LINE2) in the OPTIONS-2 menu is set to DECODER (see page 79). Make sure the Canal Plus Scart cable is plugged securely.
	A Canal Plus programme is always recorded scrambled.	<ul style="list-style-type: none"> Make sure the Canal Plus Scart cable is plugged securely. Check that DECODER/LINE3 (or DECODER/LINE2) in the OPTIONS-2 menu is set to DECODER (see page 79). Check that this channel is set as PAY-TV/Canal Plus in the TUNER menu (see page 37).

continued

	Symptom	Remedy
Others	A tape cannot be inserted.	<ul style="list-style-type: none"> • Check that a tape isn't already in the tape compartment.
	The remote commander does not function.	<ul style="list-style-type: none"> • Make sure you are pointing the remote commander at the remote sensor on the VCR. • Replace all the batteries in the remote commander with new ones if they are weak. • Make sure the [TV] / [VIDEO] remote control switch is set correctly.
	The selected input line connector number does not appear in the display window.	<ul style="list-style-type: none"> • Check that DECODER/LINE3 (or DECODER/LINE2) in the OPTIONS-2 menu is set to LINE3 (or LINE2) (see page 79).
	The SMARTLINK function does not work.	<ul style="list-style-type: none"> • Check that your TV complies with SMARTLINK, MEGALOGIC, EASYLINK, Q-Link, EURO VIEW LINK, or T-V LINK. • Make sure you use the Scart cable to connect the VCR and your TV. • Make sure the Scart cable is connected securely.
	The tracking meter does not appear on the TV screen.	<ul style="list-style-type: none"> • The recording condition of the tape is very poor and tracking cannot be adjusted. • The tracking meter does not appear when playing back an NTSC-recorded tape.
	You cannot control other TVs.	<ul style="list-style-type: none"> • Set your TV's code number. The code number may change when you replace the batteries of the remote commander.
	The display window becomes dim.	<ul style="list-style-type: none"> • The display window automatically becomes dim when the VCR is in standby or timer recording mode.
	The VCR needs to be cleaned.	<ul style="list-style-type: none"> • Clean the cabinet, panel and controls with a dry, soft cloth, or a soft cloth slightly moistened with a mild detergent solution. Do not use any type of solvent, such as alcohol or benzene.

Symptoms caused by contaminated video heads

• **Normal picture**



• **Rough picture**



**initial
contamination**

• **Unclear picture**



• **No picture (or
black & white
screen appears)**

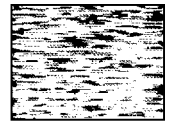

terminal



Specifications

System

Channel coverage

- PAL (B/G, D/K)
- VHF E2–E12, R1–R12
- UHF E21–E69, R21–R69
- CATV S1–S41, S01–S05

RF output signal

- UHF channels 21–69

Aerial out

- 75-ohm asymmetrical aerial socket

Tape speed

SP: PAL/MESECAM

- 23.39 mm/s (recording/playback)
- NTSC 33.35 mm/s (playback only)

LP: PAL/MESECAM

- 11.70 mm/s (recording/playback)
- NTSC 16.67 mm/s (playback only)

EP: NTSC 11.12 mm/s (playback only)

Maximum recording/playback time

- 10 hrs. in LP mode (with E300 tape)

Fast-forward and rewind time

- Approx. 1 min. (with E180 tape)

Inputs and outputs

LINE-1 (TV)

- 21-pin
- Video input: pin 20
- Audio input: pins 2 and 6
- Video output: pin 19
- Audio output: pins 1 and 3

DECODER/ LINE-2 IN (SLV-SE700N/K)

- 21-pin
- Video input: pin 20
- Audio input: pins 2 and 6

DECODER/ LINE-3 IN (SLV-SE500K, SE800N/K)

- 21-pin
- Video input: pin 20
- Audio input: pins 2 and 6

LINE-2 IN (SLV-SE500K/R, SE800N/K)

- VIDEO IN, phono jack (1)

Input signal: 1 V_{p-p}, 75 ohms, unbalanced, sync negative

AUDIO IN, phono jack (1)

Input level: 327 mV_{rms}

Input impedance: more than 47 kilohms

AUDIO OUT (SLV-SE700N/K/R, SE800N/K)

Phono jack (2)

Rated output level: 327 mV_{rms}

Load impedance: 47 kilohms

Output impedance: less than 10 kilohms

AUDIO OUT (SLV-SE500R)

Phono jack (1)

Rated output level: 327 mV_{rms}

Load impedance: 47 kilohms

Output impedance: less than 10 kilohms

General

Power requirements

- 220 – 240 V AC, 50 Hz

Power consumption

- 21 W

Operating temperature

- 5°C to 40°C

Storage temperature

- 20°C to 60°C

Dimensions including projecting parts and controls

- Approx. 430 × 100 × 283 mm (w/h/d) (SLV-SE350K, SE500K/R, SE600N, SE700N/K/R)

- Approx. 430 × 100 × 290 mm (w/h/d) (SLV-SE800N/K)

Mass

- Approx. 4.3 kg (SLV-SE350K, SE500K/R, SE600N, SE700N/K/R)

- Approx. 4.4 kg (SLV-SE800N/K)

Supplied accessories

Remote commander (1)

R6 (size AA) batteries (2)

Aerial cable (1)

Design and specifications are subject to change without notice.

Index to parts and controls

Refer to the pages indicated in parentheses () for details.

Front panel

SLV-SE500K/R and SE800N/K

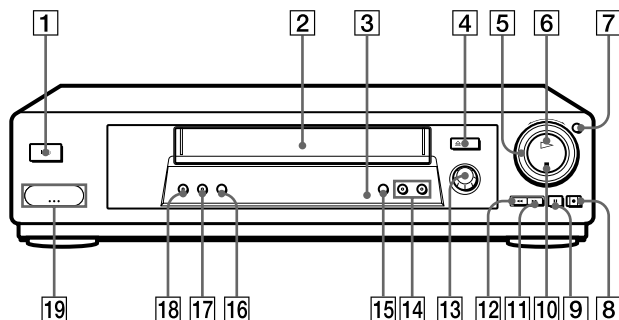

- | | |
|---|---|
| 1 I/⏻ ON/STANDBY switch (14) | 12 ◀ (rewind) button (42) (61) |
| 2 Tape compartment | 13 DIAL TIMER* ¹ (48) |
| 3 Remote sensor (5) | 14 PROGRAM/TRACKING +/- buttons (17) (63) (76) |
| 4 ≡ EJECT button (42) | 15 AUTO SET UP/
RF (Radio Frequency) CHANNEL
button (14) (17) |
| 5 Shuttle ring (62) | 16 AUDIO DUB button (84) |
| 6 ▷ PLAY button (42) (62) | 17 SYNCHRO REC button* ² (66) |
| 7 JOG button (63) | 18 RR (Reality Regenerator) button (76) |
| 8 ● REC (record) button (45) (64) (83) | 19 LINE-2 IN VIDEO/AUDIO L (left)/R
(right) jacks* ³ (covered) (81) (82) |
| 9 (pause) button (42) (83) | |
| 10 ■ STOP button (42) (83) | |
| 11 ▶▶ (fast-forward) button (42) (61) | |

*¹ not available on SLV-SE500K/R

*² not available on SLV-SE500R

*³ AUDIO R (right) jack is not available on SLV-SE500K/R.

SLV-SE350K, SE600N and SE700N/K/R

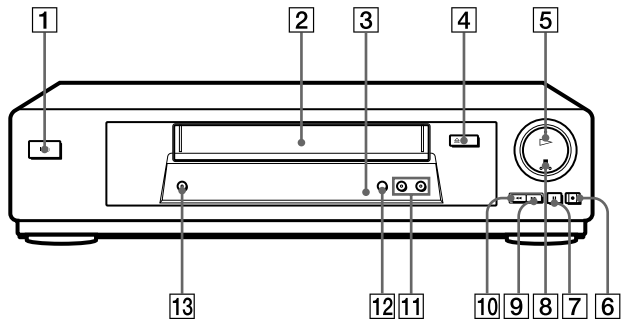

- | | |
|---|---|
| <ul style="list-style-type: none"> 1 I/⏻ ON/STANDBY switch/indicator (14) 2 Tape compartment 3 Remote sensor (5) 4 ≡ EJECT button (42) 5 ▷ PLAY button (42) (62) 6 ● REC (record) button (45) (64) (83) 7 (pause) button (42) (83) | <ul style="list-style-type: none"> 8 ■ STOP button (42) (83) 9 ►► (fast-forward) button (42) (61) 10 ◀◀ (rewind) button (42) (61) 11 PROGRAM/TRACKING +/- buttons (17) (63) (76) 12 AUTO SET UP/ RF (Radio Frequency) CHANNEL button (14) (17) 13 RR (Reality Regenerator) button* (76) |
|---|---|

*not available on SLV-SE350K and SE600N

Additional Information

continued

Display window

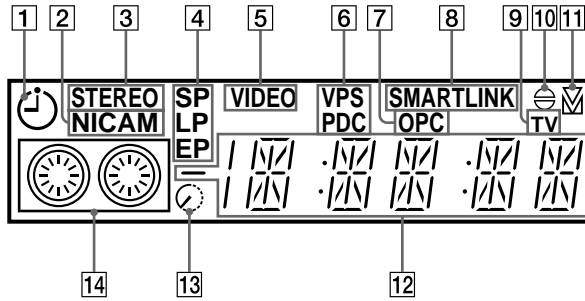

- | | |
|---|---|
| 1 Timer indicator (50) (55) (59) | 8 SMARTLINK indicator* ⁴ (11) |
| 2 NICAM indicator* ¹ (70) | 9 TV indicator* ⁴ (47) |
| 3 STEREO indicator* ² (70) | 10 Audio dubbing indicator* ⁵ (84) |
| 4 Tape speed indicators (45) | 11 Tracking indicator (76) |
| 5 VIDEO indicator (10) (45) | 12 Time counter/clock/line/programme position indicator (42) (45) (83) |
| 6 VPS (Video Programme System)/PDC (Programme Delivery Control) indicator* ³ (55) | 13 Remaining time indicator (45) |
| 7 OPC (Optimum Picture Control) indicator (76) | 14 Tape/recording indicator (45) |

*¹ SLV-SE600N, SE700N and SE800N only

*² not available on SLV-SE350K, and SE500K/R

*³ not available on SLV-SE500R, SE600N and SE700R

*⁴ not available on SLV-SE600N and SE700R

*⁵ SLV-SE500K/R and SE800N/K only

Rear panel

SLV-SE350K, SE500K, SE600N, SE700N/K, and SE800N

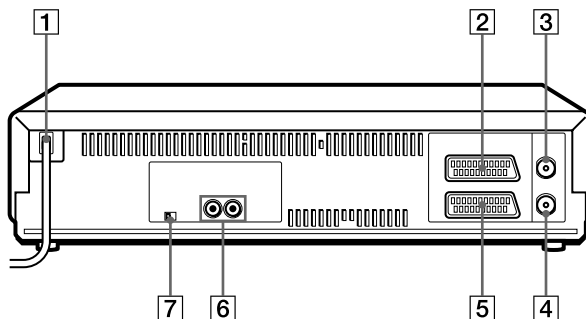

- | | |
|---|--|
| 1 Mains lead (9) (10) | 4 AERIAL OUT
ANTENNE SORTIE connector (9) (10) |
| 2 DECODER/↔ LINE-2 IN
DECODEUR/↔ ENTREE LIGNE-2
connector* ¹ (36) (82) | 5 ↔ LINE-1 (TV)
↔ LIGNE-1 (TV) connector (10) (36) |
| DECODER/↔ LINE-3 IN
DECODEUR/↔ ENTREE LIGNE-3
connector* ² (12) (36) (65) (82) | 6 AUDIO OUT R (right)/L (left)
SORTIE AUDIO D/G jacks* ³ (12) |
| 3 AERIAL IN
ANTENNE ENTREE connector (9) (10) | 7 NTSC PB (Play Back) switch (42) |

*¹ SLV-SE700N/K only

*² SLV-SE500K and SE800N only

*³ SLV-SE700N/K and SE800N only

continued

SLV-SE500R, SE700R and SE800K

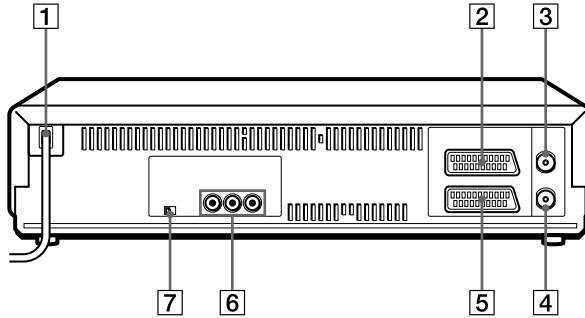

- | | |
|---|---|
| <p>1 Mains lead (9) (10)</p> <p>2 DECODER/↻ LINE-3 IN
 DECODEUR/↻ ENTREE LIGNE-3
 connector*¹ (12) (36) (65) (82)</p> <p>3 AERIAL IN
 ANTENNE ENTREE connector (9) (10)</p> | <p>4 AERIAL OUT
 ANTENNE SORTIE connector (9) (10)</p> <p>5 ↻ LINE-1 (TV)
 ↻ LIGNE-1 (TV) connector (10) (36)</p> <p>6 AUDIO OUT R (right)/L (left)/VIDEO
 jacks*² (12)</p> <p>7 NTSC PB (Play Back) switch (42)</p> |
|---|---|

*¹ SLV-SE800K only

*² AUDIO R (right) jack is not available on SLV-SE500R.

Remote commander

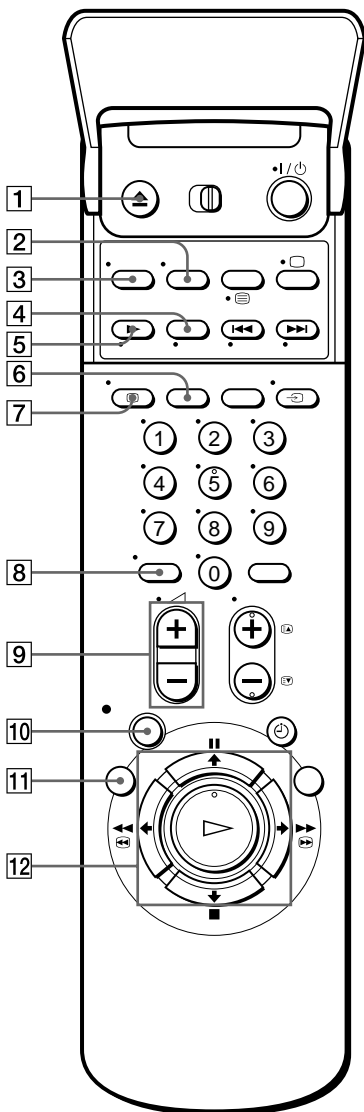

- 1 **EJECT** button (42)
- 2 **WIDE** button (*for TV*) (7)
- 3 **AUDIO MONITOR** button (70)
- 4 **x2** button*¹ (62)
- 5 **SLOW** button*¹ (62)
- 6 **SP (Standard Play)/LP (Long Play)** button (45)
- 7 **DISPLAY** button (45)
- 8 **--** (ten's digit) button (6) (46)
- 9 **∧** (volume) **+/-** buttons (*for TV*) (7)
- 10 **● REC** (record) button (45) (64)
- 11 **MENU** button (19) (68)
- 12 **|| PAUSE/↑** button (19) (42)
■ STOP/↓ button (19) (42)
◀◀ REW (rewind)/**←** button (42) (61)
▶▶ FF (fast-forward)/**→** button (42) (61)
▷ **PLAY/OK** button (19) (42)

*¹ FASTEXT buttons (*for TV*) (not available on SLV-SE350K and SE600N)

continued

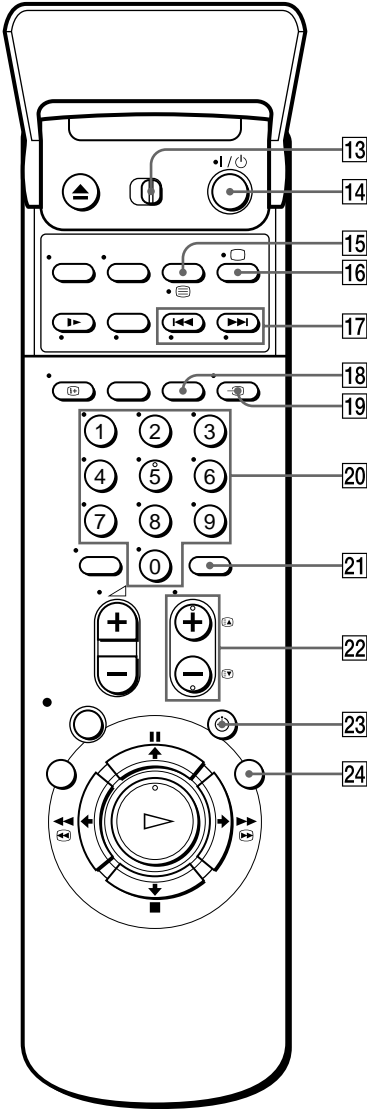

13 TV / VIDEO remote control switch (5)

14 I/O (on/standby) switch (6) (55)

15 COUNTER/REMAIN button (45)

☒ (Teletext) button*² (for TV) (7)

16 □ TV power on/TV mode select button*² (for TV) (6)

17 ◀▶ INDEX SEARCH buttons*¹ (75)

18 CLEAR button (42) (54) (69)

19 ⇌ TV/VIDEO button (6) (10) (45)

20 Programme number buttons (6) (46)

21 INPUT SELECT button (46) (58) (83)

22 PROG (programme) +/- buttons (6) (27) (45)

⬆/⬇ Teletext page access buttons*² (for TV) (7)

23 ⌚ TIMER button (54) (58)

24 SMART SEARCH button (72)

*¹ FASTTEXT buttons (for TV) (not available on SLV-SE350K and SE600N)

*² not available on SLV-SE350K and SE600N

Index

A

- Adjusting
 - picture 29, 76
 - tracking 76
- Aerial hookup 9
- AFT (Auto Fine Tuning) 29
- Audio dubbing 84
- Audio track 71
- Auto Clock Set 22
- Auto Long Play 79
- Auto Set Up 17

C

- Canal Plus 36
- Changing the programme position 30
- Changing the station name 34
- Cleaning the video heads 87
- Clock setting 19
- Colour system
 - compatible colour systems 2
 - setting 42
- Connecting
 - the VCR and your TV 9, 10
 - to a satellite tuner 12
 - to a stereo system 12
 - to a TV with a Scart (EURO-AV) connector 10
 - to a TV with audio/video cable 12
- Counter 42

D

- Demonstration 52
- Dial Timer 48
- Disabling the programme positions 32
- Dubbing. *see* Editing

E

- Editing 81
- EP mode 43

H

- Hi-fi audio track 71

I

Sony Corporation

Index search 75

L

- Language selecting 24
- LP mode 45

M

- Monaural 70
- Monitoring
 - during playback 71
 - during recording 70

N

- NICAM broadcasts 70
- Normal audio track 71

O

- OPC (Optimum Picture Control) 76
- Optional setting 78

P

- PAY-TV 36
- PDC (Programme Delivery Control) 55
- Picture adjustment. *See* Adjusting
- Playback 41
 - at various speeds 61
 - frame-by-frame 62
 - selecting the sound 71
 - slow motion 62
- Power save 79
- Presetting channels 26

R

- Reality Regenerator 76
- Recording 44
 - bilingual programmes 70
 - duration time 64
 - saving 46
 - stereo programmes 70
 - timer setting 57
 - using the Dial Timer 48
 - using the Show View system 53
 - what you are watching on the TV 47

- while watching another programme 45
- RF channel 14, 16

S

- Safety tab 46
- Scart connection 10
- Searching
 - at various speeds 61
 - using the index function 75
 - using the Smart Search function 72
- Show View
 - recording 53
- Smart Search 72
- SMARTLINK
 - Automatic Power Off 11
 - One Touch Menu 11
 - One Touch Play 11, 43
 - One Touch Timer 11
 - Preset Download 11
 - TV Direct Rec 11, 47
- SP mode 45
- Stereo 70
- Synchronised Recording 65

T

- Timer setting 57
 - cancelling 68
 - changing 68
 - checking 68
 - daily/weekly recording 55, 59
 - using the Dial Timer 48
 - using the Show View system 53
- Tracking adjustment. *See* Adjusting

V

- VPS (Video Programme System) 55

Z

- ZWEITON broadcasts 70

Sony  line

<http://www.world.sony.com/>

Free Manuals Download Website

<http://myh66.com>

<http://usermanuals.us>

<http://www.somanuals.com>

<http://www.4manuals.cc>

<http://www.manual-lib.com>

<http://www.404manual.com>

<http://www.luxmanual.com>

<http://aubethermostatmanual.com>

Golf course search by state

<http://golfingnear.com>

Email search by domain

<http://emailbydomain.com>

Auto manuals search

<http://auto.somanuals.com>

TV manuals search

<http://tv.somanuals.com>