

# *Video Cassette Recorder*

---

Operating Instructions



Hi-Fi

*SLV-SE610B*  
*SLV-SE710B*  
*SLV-SX710B*  
*SLV-SE810B*

**SHOWVIEW®**

**SHOWVIEW®**

**SHOWVIEW®**

© 2001 Sony Corporation

## WARNING

To prevent fire or shock hazard, do not expose the unit to rain or moisture.

To avoid electrical shock, do not open the cabinet. Refer servicing to qualified personnel only.

Mains lead must only be changed at a qualified service shop.

## Precautions

### Safety

- This unit operates on 220 – 240 V AC, 50 Hz. Check that the unit's operating voltage is identical with your local power supply.
- If anything falls into the cabinet, unplug the unit and have it checked by qualified personnel before operating it any further.
- The unit is not disconnected from the mains as long as it is connected to the mains, even if the unit itself has been turned off.
- Unplug the unit from the wall outlet if you do not intend to use it for an extended period of time. To disconnect the cord, pull it out by the plug, never by the cord.

### Installing

- Allow adequate air circulation to prevent internal heat buildup.
- Do not place the unit on surfaces (rugs, blankets, etc.) or near materials (curtains, draperies) that may block the ventilation slots.
- Do not install the unit near heat sources such as radiators or air ducts, or in a place subject to direct sunlight, excessive dust, mechanical vibration or shock.
- Do not install the unit in an inclined position. It is designed to be operated in a horizontal position only.
- Keep the unit and cassettes away from equipment with strong magnets, such as microwave ovens or large loudspeakers.
- Do not place heavy objects on the unit.
- If the unit is brought directly from a cold to a warm location, moisture may condense inside the VCR and cause damage to the video head and tape. When you first install the unit, or when you move it from a cold to a warm location, wait for about three hours before operating the unit.

### Caution

Television programmes, films, video tapes and other materials may be copyrighted. Unauthorized recording of such material may be contrary to the provisions of the copyright laws. Also, use of this recorder with cable television transmission may require authorization from the cable television transmitter and/or programme owner.

## Compatible colour systems

- This VCR is designed to record using the PAL (B/G) and SECAM colour systems and play back using the PAL (B/G) and SECAM colour systems. Recording of video sources based on other colour systems cannot be guaranteed.
- Tapes recorded with the MESECAM colour system can be played back on this VCR using a TV or a colour monitor supporting the SECAM colour system.

SHOWVIEW is a registered trademark of Gemstar Development Corporation. The SHOWVIEW system is manufactured under license from Gemstar Development Corporation.

# Table of contents

## Getting Started

- 4 Index to parts and controls
- 10 Step 1 : Unpacking
- 11 Step 2 : Setting up the remote commander
- 15 Step 3 : Connecting the VCR
- 19 Step 4 : Tuning your TV to the VCR
- 22 Step 5 : Setting up the VCR with the Auto Set Up function
- 24 Selecting a language
- 25 Presetting channels
- 30 Changing/disabling programme positions
- 35 Setting the clock
- 39 Setting the Canal Plus decoder

## Basic Operations

- 44 Playing a tape
- 46 Recording TV programmes
- 50 Recording TV programmes using the Dial Timer (SLV-SE810B only)
- 55 Recording TV programmes using the ShowView system (not available on SLV-SE610B)
- 59 Recording TV programmes using the timer

## Additional Operations

- 63 Playing/searching at various speeds
- 65 Setting the recording duration time
- 66 Synchronized Recording (not available on SLV-SE610B)
- 68 Checking/changing/cancelling timer settings
- 70 Recording stereo and bilingual programmes

- 72 Searching using the Acces Smart function
- 74 Storing, searching and deleting programme information (Acces Smart Plus)
- 79 Searching using the index function
- 80 Adjusting the picture
- 82 Reducing the VCR's power consumption
- 83 Changing menu options

## Editing

- 86 Connecting to a VCR or stereo system
- 88 Basic editing
- 89 Audio dubbing (SLV-SE810B only)

## Additional Information

- 90 Troubleshooting
- 95 Specifications
- 97 Index

## Back Cover

Quick Start Guide

# Index to parts and controls

Refer to the pages indicated in parentheses ( ) for details.

## SLV-SE810B

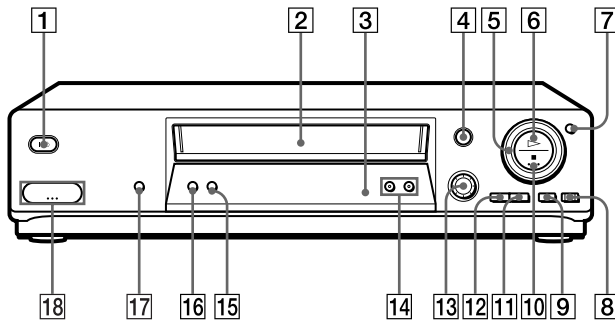

**1** I/⏻ (marche/veille) switch (19)

**2** Tape compartment

**3** Remote sensor (11)

**4** ≡ (eject) button (44)

**5** Shuttle ring (63)

**6** ▷ (play) button (44) (63)

**7** JOG button (64)

**8** ● ENR (record) button (46) (65) (88)

**9** || (pause) button (44) (88)

**10** ■ (stop) button (44) (88)

**11** ▶▶ (fast-forward) button (44) (63)

**12** ◀◀ (rewind) button (44) (63)

**13** ⌚ PROG (Dial Timer) control (50)

**14** CHAINE +/- buttons (64) (80)

**15** DOUBLAGE SON button (89)

**16** REGLAGE AUTO (Auto Set Up)/REGL CANAL button (19) (22)

**17** ENR SYNCHRO (Synchronized Recording) button (67)

**18** ↶ LIGNE-2 G (left) ↷ D (right) jacks (covered) (86) (87)

### How to open the jack cover

**1** Press the bottom of the cover.

**2** Hook your finger on the top edge of the cover and pull it open.

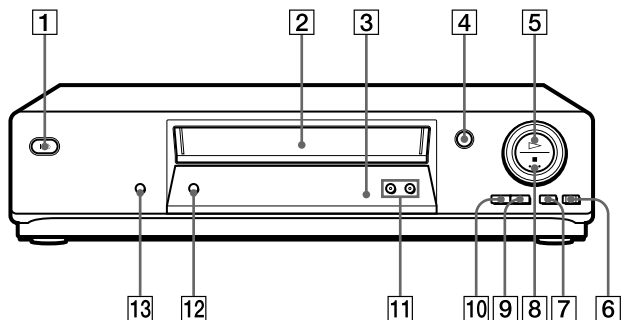

- |  |  |
|--|--|
| <b>1</b> I/⏻ (marche/veille) switch (19)         | <b>8</b> ■ (stop) button (44) (88)                                   |
| <b>2</b> Tape compartment                        | <b>9</b> ►► (fast-forward) button (44) (63)                          |
| <b>3</b> Remote sensor (11)                      | <b>10</b> ◀◀ (rewind) button (44) (63)                               |
| <b>4</b> ≡ (eject) button (44)                   | <b>11</b> CHAINE +/- buttons (64) (80)                               |
| <b>5</b> ▷ (play) button (44) (63)               | <b>12</b> REGLAGE AUTO (Auto Set Up)/<br>REGL CANAL button (19) (22) |
| <b>6</b> ● ENR (record) button (46) (65)<br>(88) | <b>13</b> ENR SYNCHRO (Synchronized<br>Recording) button* (67)       |
| <b>7</b>    (pause) button (44) (88)             |  |

\* not available on SLV-SE610B

## Display window

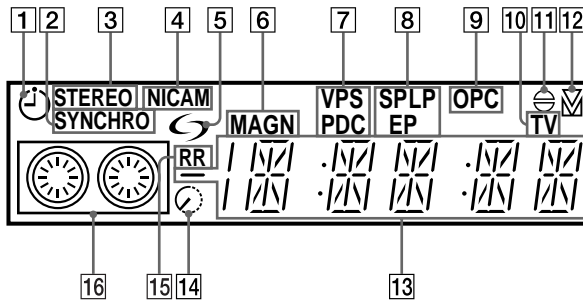

- |  |   |
|--|---|
| <b>1</b> Timer indicator (52) (57) (60)  | <b>10</b> TV indicator* <sup>1</sup> (48)                                     |
| <b>2</b> SYNCHRO indicator* <sup>1</sup> (67)  | <b>11</b> Audio dubbing indicator* <sup>2</sup> (89)                          |
| <b>3</b> STEREO indicator (70)   | <b>12</b> Tracking indicator (80)   |
| <b>4</b> NICAM indicator (70)  | <b>13</b> Time counter/clock/line/programme position indicator (44) (46) (88) |
| <b>5</b> ↻ (smartlink) indicator* <sup>1</sup> (17)  | <b>14</b> Remaining time indicator (47)                                       |
| <b>6</b> MAGN (video) indicator (16) (47)  | <b>15</b> RR (Reality Regenerator) indicator (80)                             |
| <b>7</b> VPS (Video Programme System)/ PDC (Programme Delivery Control) indicator* <sup>1</sup> (57) | <b>16</b> Tape/recording indicator (46)                                       |
| <b>8</b> Tape speed indicators (46)  |   |
| <b>9</b> OPC (Optimum Picture Control) indicator (81)  |   |

\*<sup>1</sup> not available on SLV-SE610B

\*<sup>2</sup> SLV-SE810B only

## Rear panel

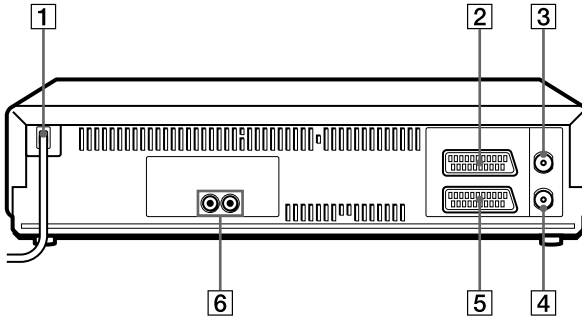

**1** Mains lead (15) (16)

**2** DECODER/↻ LINE-2 IN  
 DECODEUR/↻ ENTREE LIGNE-  
 2 connector\*<sup>1</sup> (18) (39) (66) (87)

DECODER/↻ LINE-3 IN  
 DECODEUR/↻ ENTREE LIGNE-  
 3 connector\*<sup>2</sup> (18) (39) (66) (87)

**3** AERIAL IN  
 ANTENNE ENTREE connector (15)  
 (16)

**4** AERIAL OUT  
 ANTENNE SORTIE connector (15)  
 (16)

**5** ↻ LINE-1 (TV)  
 ↻ LIGNE-1 (TV) connector (16)  
 (39)

**6** ↻ (audio out) R/D (right) L/G (left)  
 jacks\*<sup>3</sup>

\*<sup>1</sup> SLV-SE610B, SE710B, and SX710B only

\*<sup>2</sup> SLV-SE810B only

\*<sup>3</sup> not available on SLV-SE610B

*continued*

## Remote commander

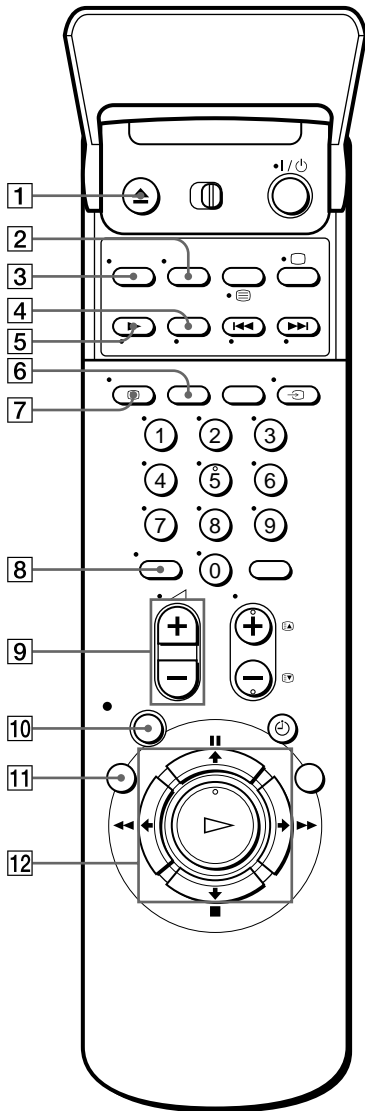

- 1 ▲ EJECT button (44)
- 2 WIDE button (*for TV*) (13)
- 3 CHOIX SON button (70)
- 4 ×2 button\* (63)
- 5 ►▶ RALENTI (slow) button\* (63)
- 6 SP (Standard Play)/LP (Long Play) button (46)
- 7 [i+] AFFICH (display) button (47)
- 8 -/- (ten's digit) button (12) (47)
- 9 ▲ (volume) +/- buttons (*for TV*) (13)
- 10 ● ENR (record) button (46) (65)
- 11 MENU button (35) (68)
- 12 || PAUSE/▲ button (35) (44)  
 ■ (stop)/▼ button (35) (44)  
 ◀◀ RET (rewind)/◀ button (44) (63)  
 ▶▶ AV (fast-forward)/▶ button (44) (63)  
 ▷ LECTURE/OK button (35) (44)

\* FASTEXT buttons (*for TV*) (not available on SLV-SE610B, SE710B, SX710B)



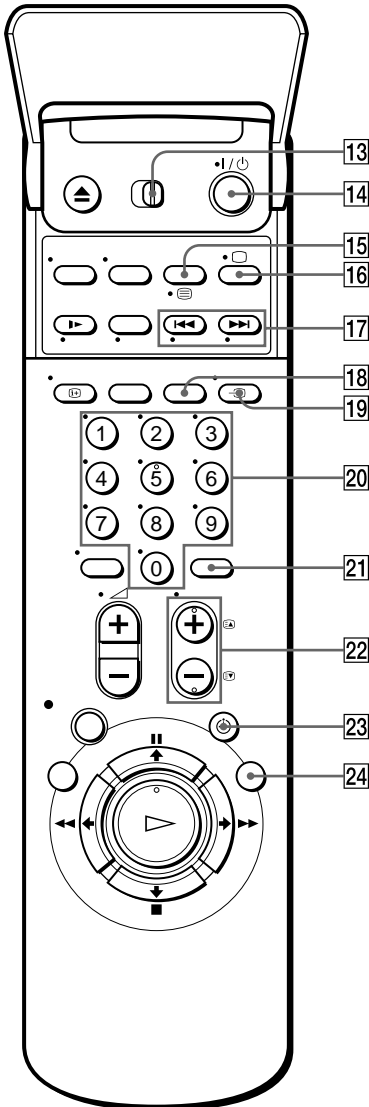

13 **TV / MAGN** (TV/video) remote control switch (11)

14 **I/⏻** (on/standby) switch (12) (57)

15 **COMPT/DUREE REST** (counter/remain) button (47)

**⏏** (Teletext) button\*<sup>2</sup> (for TV) (13)

16 **⏻** TV power on/TV mode select button\*<sup>2</sup> (for TV) (12)

17 **⏮/⏭** RECHER INDEX (index search) buttons\*<sup>1</sup> (79)

18 **ANNUL/0** button (44) (56) (68)

19 **↶** TV/MAGN (TV/video) button (12) (16) (47)

20 Programme number buttons (12) (47)

21 **CHOIX ENTREE** (input select) button (47) (60) (88)

22 **CHAINE** (programme) +/- buttons (12) (26) (46)

**⏏/⏏** Teletext page access buttons\*<sup>2</sup> (for TV) (13)

23 **⏻** MINUTERIE (timer) button (55) (59)

24 **ACCES SMART** button (72)

\*<sup>1</sup> FASTEXT buttons (for TV) (not available on SLV-SE610B, SE710B, SX710B)

\*<sup>2</sup> not available on SLV-SE610B, SE710B, SX710B

# Step 1 : Unpacking

Check that you have received the following items with the VCR:

- Remote commander
- Aerial cable

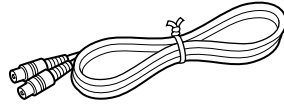
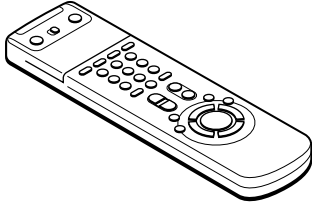

- R6 (size AA) batteries

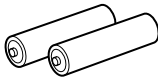

## Check your model name

The instructions in this manual are for the 4 models: SLV-SE610B, SE710B, SX710B, SE810B. Check your model number by looking at the rear panel of your VCR. SLV-SE810B is the model used for illustration purposes. Any difference in operation is clearly indicated in the text, for example, "SLV-SE710B only."

## Step 2 : Setting up the remote commander

### Inserting the batteries

Insert two R6 (size AA) batteries by matching the + and – on the batteries to the diagram inside the battery compartment.

Insert the negative (–) end first, then push in and down until the positive (+) end clicks into position.

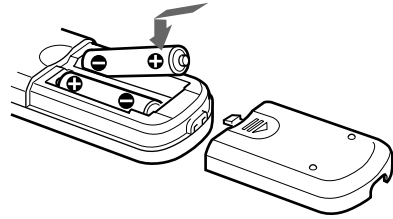

### Using the remote commander

You can use this remote commander to operate this VCR and a Sony TV. Buttons on the remote commander marked with a dot (•) can be used to operate your Sony TV. If the TV does not have the **R** symbol near the remote sensor, this remote commander will not operate the TV.

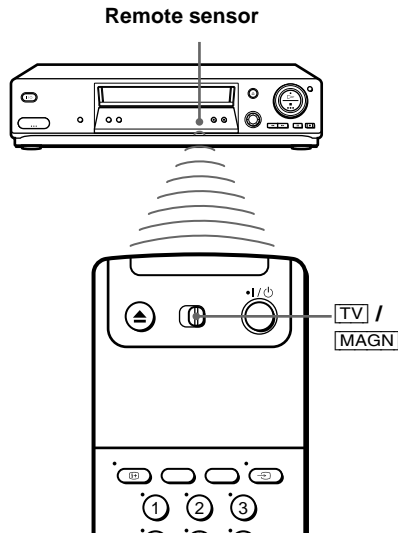

To operate	Set <b>TV</b> / <b>MAGN</b> to
the VCR	<b>MAGN</b> and point at the remote sensor at the VCR
a Sony TV	<b>TV</b> and point at the remote sensor at the TV

*continued*

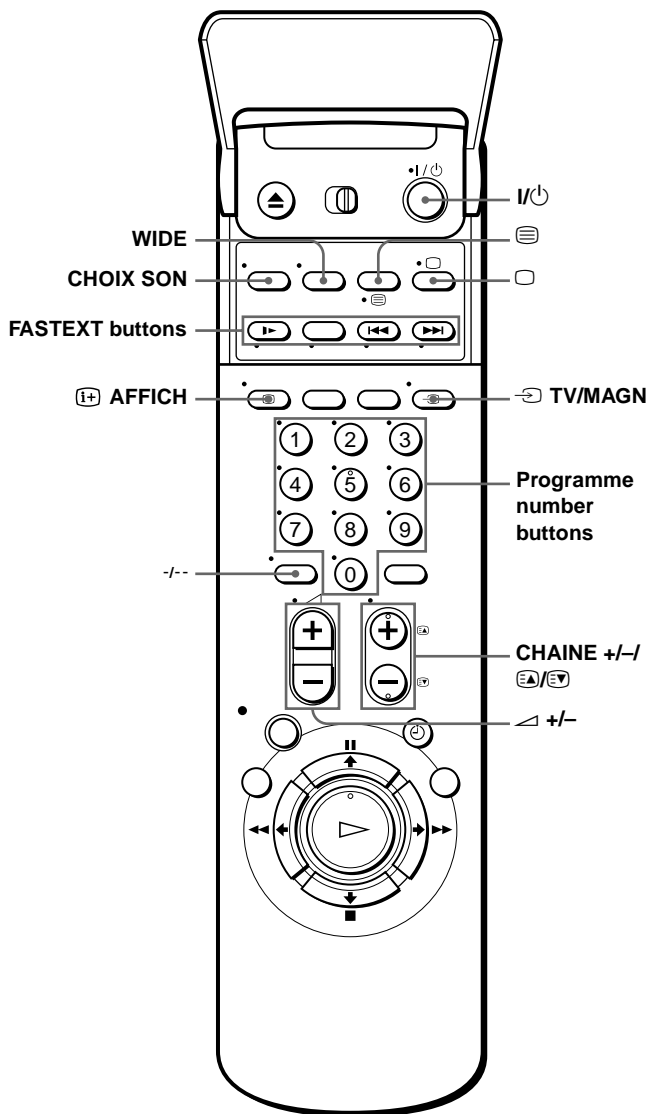

## TV control buttons

To	Press
Set the TV to standby mode	I/⏻
Select an input source: aerial in or line in	↺ TV/VIDEO
Select the TV's programme position	Programme number buttons, -/--, PROG +/-

To	Press
Adjust the volume of the TV	+/-
Switch to TV (Teletext off)*	(TV)
Switch to Teletext*	(Teletext)
Select the sound	CHOIX SON
Use FASTEXT*	FASTEXT buttons
Call up the on-screen display	AFFICH
Change the Teletext page*	
Switch to/from wide mode of a Sony wide TV (For other manufactures' wide TVs, see "Controlling other TVs with the remote commander (SLV-SE810B only)" below.)	WIDE

### Notes

- With normal use, the batteries should last about three to six months.
- If you do not use the remote commander for an extended period of time, remove the batteries to avoid possible damage from battery leakage.
- Do not use a new battery together with an old one.
- Do not use different types of batteries together.
- Some buttons may not work with certain Sony TVs.

\* not available on SLV-SE610B, SE710B, and SX710B

## Controlling other TVs with the remote commander (SLV-SE810B only)

The remote commander is preprogrammed to control non-Sony TVs. If your TV is listed in the following table, set the appropriate manufacturer's code number.

**1** Set / at the top of the remote commander to .

**2** Hold down , and enter your TV's code number using the programme number buttons. Then release .

Now you can use the following TV control buttons to control your TV:

, TV/VIDEO, programme number buttons, (ten's digit), PROG +/-, +/-, (TV), (Teletext), FASTEXT buttons, WIDE\*, MENU\*, \*, and OK\*.

\* These buttons may not work with all TVs.

*continued*

## Code numbers of controllable TVs

If more than one code number is listed, try entering them one at a time until you find the one that works with your TV.

To switch to wide mode, see the footnotes below this table for the applicable code numbers.

Manufacturer	Code number
Sony	01* <sup>1</sup> , 02
Akai	68
Ferguson	52
Grundig	10* <sup>1</sup> , 11* <sup>1</sup>
Hitachi	24
JVC	33
Loewe	45
Mivar	09, 70
NEC	66
Nokia	15, 16, 69* <sup>3</sup>

Manufacturer	Code number
Panasonic	17* <sup>1</sup> , 49
Philips	06* <sup>1</sup> , 07* <sup>1</sup> , 08* <sup>1</sup>
Saba	12, 13
Samsung	22, 23
Sanyo	25
Sharp	29
Telefunken	36
Thomson	43* <sup>2</sup>
Toshiba	38

\*<sup>1</sup> Press WIDE to switch the wide picture mode on or off.

\*<sup>2</sup> Press WIDE, then press  $\triangleleft$  +/- to select the wide picture mode you want.

\*<sup>3</sup> Press WIDE. The menu appears on the TV screen. Then, press  $\uparrow$ / $\downarrow$ / $\leftarrow$ / $\rightarrow$  to select the wide picture you want and press OK.

### Tip

- When you set your TV's code number correctly while the TV is turned on, the TV turns off automatically.

### Notes

- If you enter a new code number, the code number previously entered will be erased.
- If the TV uses a different remote control system from the one programmed to work with the VCR, you cannot control your TV with the remote commander.
- When you replace the batteries of the remote commander, the code number may change. Set the appropriate code number every time you replace the batteries.

## Step 3 : Connecting the VCR

If your TV has a PERITEL connector, see page 16.

### If your TV does not have a PERITEL connector

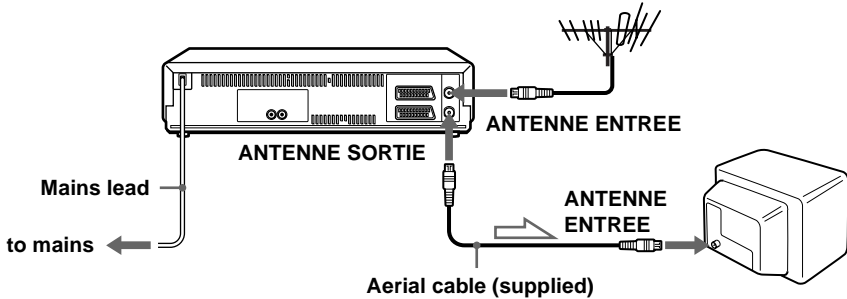

 : Signal flow

- 1 Disconnect the aerial cable from your TV and connect it to ANTENNE ENTREE on the rear panel of the VCR.

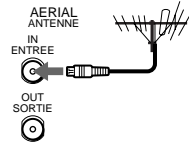

- 2 Connect ANTENNE SORTIE of the VCR and the aerial input of your TV using the supplied aerial cable.



- 3 Connect the mains lead to the mains.

#### Note

- When you connect the VCR and your TV only with an aerial cable, you have to tune your TV to the VCR (see page 19).

*continued*

## If your TV has a PERITEL connector

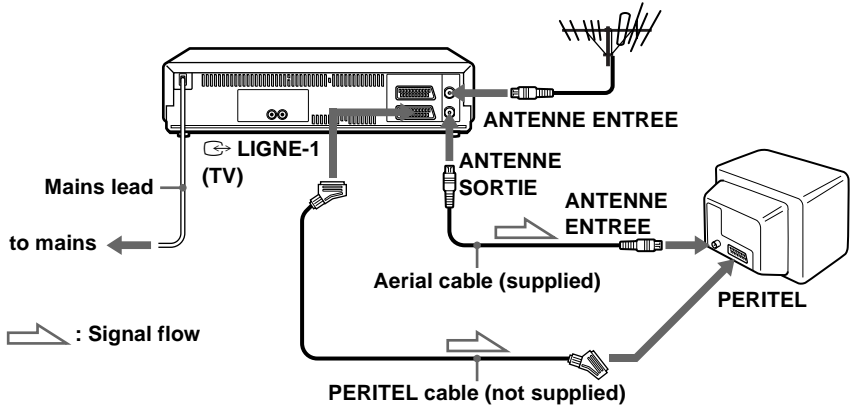

- 1 Disconnect the aerial cable from your TV and connect it to ANTENNE ENTREE on the rear panel of the VCR.

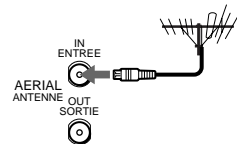

- 2 Connect ANTENNE SORTIE of the VCR and the aerial input of your TV using the supplied aerial cable.

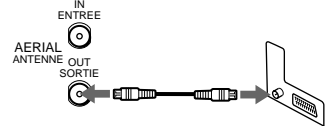

- 3 Connect LIGNE-1 (TV) on the VCR and the PERITEL connector on the TV with the optional PERITEL cable.

This connection improves picture and sound quality. Whenever you want to watch the VCR picture, press TV/MAGN to display the MAGN indicator in the display window.

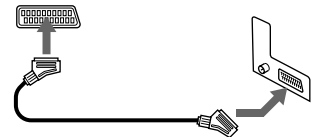

- 4 Connect the mains lead to the mains.

### Note

- If the TV is connected to the LIGNE-1 (TV) connector, setting the RF channel to OFF is recommended. In the OFF position, only the signal from the aerial is output through the ANTENNE SORTIE connector (see page 21).



## About the SMARTLINK features (not available on SLV-SE610B)

If the connected TV complies with SMARTLINK, MEGALOGIC\*<sup>1</sup>, EASYLINK\*<sup>2</sup>, Q-Link\*<sup>3</sup>, EURO VIEW LINK\*<sup>4</sup>, or T-V LINK\*<sup>5</sup>,



this VCR automatically runs the SMARTLINK function after you complete the steps on the previous page (the ↷ indicator appears in the VCR's display window when you turn on the TV). You can enjoy the following SMARTLINK features.

- **Preset Download**  
You can download your TV tuner preset data to this VCR and tune the VCR according to that data in Auto Set Up. This greatly simplifies the Auto Set Up procedure. Be careful not to disconnect the cables or exit the Auto Set Up function during the procedure. See "Setting up the VCR with the Auto Set Up function" on page 22.
- **TV Direct Rec**  
You can easily record what you are watching on the TV. For details, see "Recording what you are watching on the TV (TV Direct Rec) (not available on SLV-SE610B)" on page 48.
- **One Touch Play**  
With One Touch Play, you can start playback automatically without turning on the TV. For details, see "Starting playback automatically with one button (One Touch Play) (not available on SLV-SE610B)" on page 45.
- **One Touch Menu**  
You can turn on the VCR and TV, set the TV to the video channel, and display the VCR's on-screen display automatically by pressing MENU on the remote commander.
- **One Touch Timer**  
You can turn on the VCR and TV, set the TV to the video channel, and display the timer recording menu (the METHODE DE PROGRAMMATION menu, the MINUTERIE menu, or the SHOWVIEW menu) automatically by pressing ⊖ MINUTERIE on the remote commander.  
You can set which timer recording menu is displayed using OPTIONS PROGRAMM. in the OPTIONS-2 menu (see page 84).
- **Automatic Power Off**  
You can have the VCR turn off automatically, if the VCR is not used after you turn off the TV.

\*<sup>1</sup>"MEGALOGIC" is a registered trademark of Grundig Corporation.

\*<sup>2</sup>"EASYLINK" is a trademark of Philips Corporation.

\*<sup>3</sup>"Q-Link" is a trademark of Panasonic Corporation.

\*<sup>4</sup>"EURO VIEW LINK" is a trademark of Toshiba Corporation.

\*<sup>5</sup>"T-V LINK" is a trademark of JVC Corporation.

**continued**

### Note

- Not all TVs respond to the functions above.

## Additional connection

### To a stereo system (not available on SLV-SE610B)

You can improve sound quality by connecting a stereo system to the (audio out) R/D L/G jacks as shown on the right.

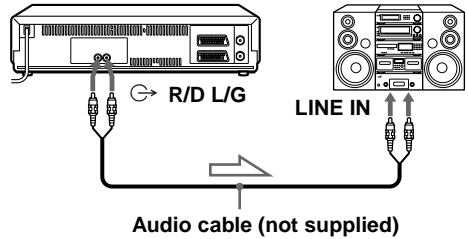

▬ : Signal flow

### To a satellite or digital tuner with Line Through

Using the Line Through function, you can watch programmes from a satellite or digital tuner connected to this VCR on the TV even when the VCR is turned off. When you turn on the satellite or digital tuner, this VCR automatically sends the signal from the satellite or digital tuner to the TV without turning itself on.

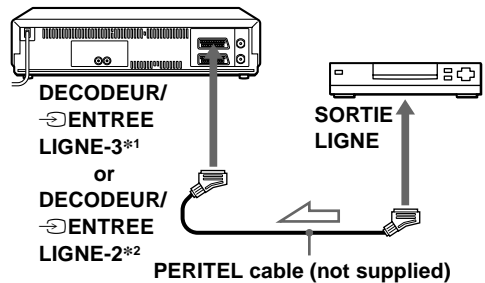

▬ : Signal flow

- 1 Connect the satellite or digital tuner to the DECODEUR/ENTREE LIGN-3\*<sup>1</sup> (or DECODEUR/ENTREE LIGNE-2\*<sup>1</sup>) connector as shown above.
- 2 Set DECODEUR/ENTREE LIGN-3\*<sup>1</sup> (or DECODEUR/ENTREE LIGNE-2\*<sup>1</sup>) to LIGNE3\*<sup>1</sup> (or LIGNE2\*<sup>2</sup>) in the OPTIONS-2 menu.
- 3 Set VEILLE ECO to NON or PARTIELLE in the OPTIONS-2 menu.
- 4 Turn off the VCR.  
To watch a programme, turn on the satellite or digital tuner and the TV.

### Note

- You cannot watch programmes on the TV while recording unless you are recording a satellite or digital programme.

\*<sup>1</sup> SLV-SE810B only

\*<sup>2</sup> SLV-SE610B, SE710B, and SX710B only

## Step 4 : Tuning your TV to the VCR

If your TV has a PERITEL connector, see page 21.

### If your TV does not have a PERITEL connector

Follow the steps below so that your TV will properly receive the video signals from your VCR.

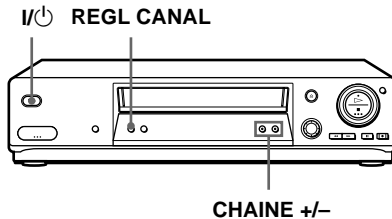

**1**



Press I/⏻ (marche/veille) to turn on the VCR.

**2**



Press REGL CANAL on the VCR lightly.

The factory-preset RF channel appears in the display window.

The VCR signal is output through this channel to the TV.

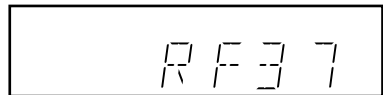

**3**

Turn on your TV and select a programme position for the VCR picture.

This programme position will now be referred to as the video channel.

**4**



Press REGL CANAL.

The TV system appears in the display window.

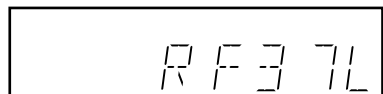

*continued*

Tuning your TV to the VCR | 19

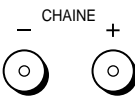
- 5**  Press CHAINE +/- (repeatedly) to select the appropriate TV system for your area.  
Select "L" for the L TV system (SECAM), or "G" for the B/G TV system (PAL).

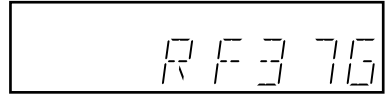



- 6** Tune the TV to the same channel shown in the VCR display window so that the picture on the right appears clearly on the TV screen.

Refer to your TV manual for TV tuning instructions.

If you select the wrong TV system in step 5, the picture on the right may not appear. Select the appropriate TV system and tune the TV again.

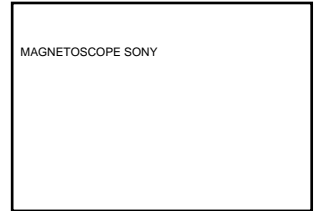
If the picture does not appear clearly, see "To obtain a clear picture from the VCR" below.



- 7**  Press REGL CANAL.  
You have now tuned your TV to the VCR. Whenever you want to play a tape, set the TV to the video channel.

### To check to see if the TV tuning is correct

Set the TV to the video channel and press CHAINE +/- on the VCR. If the TV screen changes to a different programme each time you press CHAINE +/-, the TV tuning is correct.

### To obtain a clear picture from the VCR

If the screen does not appear clearly in step 6 above, go to step 7 to finish this procedure once. Then start again from step 2. After pressing REGL CANAL in step 2, press CHAINE +/- while the RF channel is displayed, so that another RF channel appears. Then tune the TV to the new RF channel so that a clear picture appears.

## If your TV has a PERITEL connector

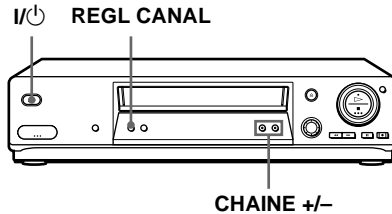

**1**



Press I/⏻ (marche/veille) to turn on the VCR.

**2**



Press REGL CANAL on the VCR lightly.

The factory-preset RF channel appears in the display window.  
The VCR signal is output through this channel to the TV.

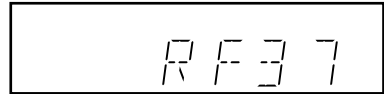

**3**

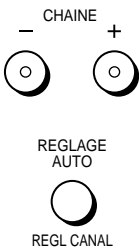

Press CHAINE +/- to set the RF channel to OFF, and press REGL CANAL again.



RF channel set up is complete.

## Step 5 : Setting up the VCR with the Auto Set Up function

Before using the VCR for the first time, set up the VCR using the Auto Set Up function. With this function, you can set the TV channels, guide channels for the ShowView system\*, and VCR clock automatically.

### REGLAGE AUTO

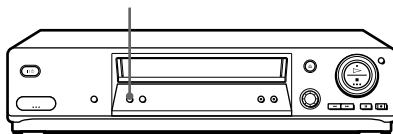

REGLAGE  
AUTO



REGL CANAL

Hold down REGLAGE AUTO on the VCR for more than three seconds.

The VCR automatically turns on, starts searching for all of the receivable channels, and presets them in the appropriate order for your local area (according to the TV system you selected in “Tuning your TV to the VCR”).

If you want to change the order of the channels or disable unwanted programme positions, see “Changing/disabling programme positions” on page 30.



If you use the SMARTLINK connection (not available on SLV-SE610B), the Preset Download function starts and the  indicator flashes in the display window during download.

After the search or download is complete, the current time appears in the display window for any stations that transmit a time signal (not available on SLV-SE610B). If the time does not appear, set the clock manually. See page 35.

### To cancel the Auto Set Up function

Press REGLAGE AUTO.

#### Tip

- If you want to change the language for the on-screen display from the one preset in the Auto Set up function, see page 24.

**Notes**

- Do not cancel the Auto Set Up function. If you do, repeat the steps above.
- The Auto Set Up function may require a long time to complete (approximately 15 to 18 minutes).
- Whenever you operate the Auto Set Up function, some of the settings (ShowView\*, timer, etc.) will be reset. If this happens, you have to set them again.

\* not available on SLV-SE610B

# Selecting a language

If you prefer an on-screen language other than French, use the on-screen display to select another language.

## Before you start...

- Turn on the VCR and the TV.
- Set the TV to the video channel.
- Refer to “Index to parts and controls” for button locations.

1

MENU



Press MENU, then press **↑/↓** to highlight REGLAGES and press OK.

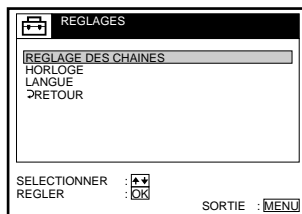

2



Press **↑/↓** to highlight LANGUE, then press OK.

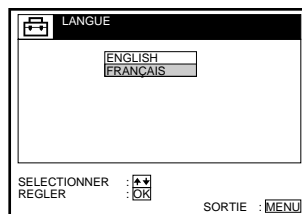

3



Press **↑/↓** to highlight the desired language, then press OK.

4

MENU



Press MENU to exit the menu.

### Tip

- If you want to return to the previous menu, highlight RETOUR and press OK.

### Note

- The menu disappears automatically if you don't proceed for more than a few minutes.



# Presetting channels

If some channels could not be preset using the Auto Set Up function, you can preset them manually.

## Before you start...

- Turn on the VCR and the TV.
- Set the TV to the video channel.
- Refer to “Index to parts and controls” for button locations.

1

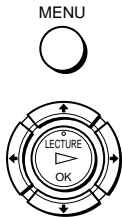

Press MENU, then press **↑/↓** to highlight REGLAGES and press OK.

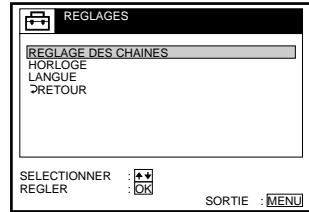

2



Press **↑/↓** to highlight REGLAGE DES CHAINES, then press OK.

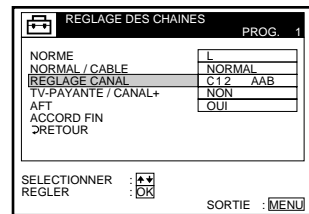

3



Press **↑/↓** to highlight NORME, then press OK.

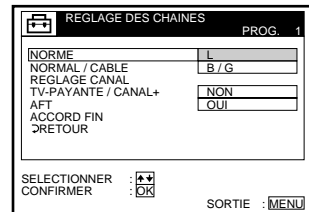

4



Press **↑/↓** to highlight L or B/G, then press OK.

- To receive broadcasts in France, highlight L.
- To receive broadcasts using the PAL system (for example, in Germany or Switzerland), highlight B/G.

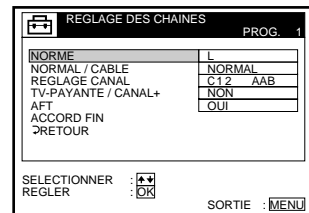

*continued*

5



Press **↑/↓** to highlight **NORMAL/**  
**CABLE**, then press **OK**.

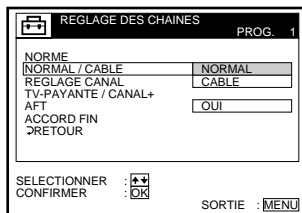

6



Press **↑/↓** to highlight **NORMAL**,  
then press **OK**.

To preset CATV (Cable Television)  
channels, select **CABLE**.

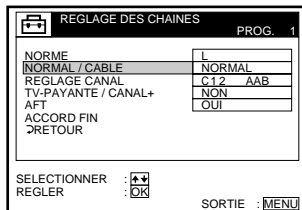

7

• CHAINE



Press **CHAINE +/-** to select the  
programme position.

Selected programme position

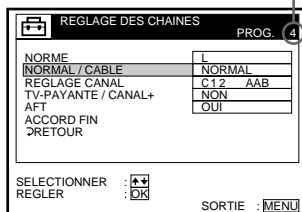

8



Press **↑/↓** to highlight **REGLAGE**  
**CANAL**, then press **OK**.

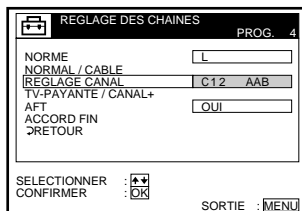

9



Press **↑/↓** repeatedly until the channel you want is displayed.

The channels appear in the following order:

- ①
- ②
- ③
- ④
- ⑤
- ⑥
- ⑦
- ⑧
- ⑨
- ⑩

Channel coverage	System L	System B/G
VHF	F2 - F10	E2 - E12 Italian channels A - H
UHF	F21 - F69	E21 - E69
CATV (TV distribution)	B - Q	S01 - S05, S1 - S20
HYPER	S21 - S41	S21 - S41

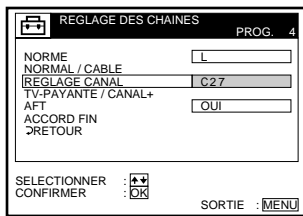

If you know the number of the channel you want, press the programme number buttons. For example, for channel 5, first press “0” and then press “5.”

10

To preset another programme position, repeat steps 7 through 9.

11



Press MENU to exit the menu.

*continued*

## If the picture is not clear

Normally, the Auto Fine Tuning (AFT) function automatically tunes in channels clearly. However, if the picture is not clear, you may also use the manual tuning function.

- 1 Press CHAINE +/- or the programme number buttons to select the programme position for which you cannot obtain a clear picture.
- 2 Press MENU, then select REGLAGES and press OK.
- 3 Select REGLAGE DES CHAINES, then press OK.
- 4 Select ACCORD FIN, then press OK.

The fine tuning meter appears.

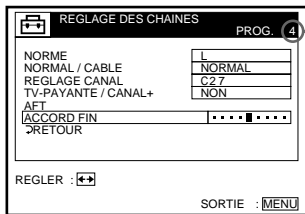

Selected programme position

- 5 Press ←/→ to get a clearer picture, then press MENU to exit the menu. Note that the AFT (Auto Fine Tuning) setting switches to NON.

## Tuning the French CATV channels

This VCR can scan the CATV channels B to Q and the HYPER frequency channels S21 to S41. On the REGLAGE DES CHAINES menu, the channels are indicated by S01 to S44 REGLAGE CANAL numbers respectively. For example, channel B is indicated by REGLAGE CANAL number S01 and channel Q by REGLAGE CANAL number S23. (See the table below.)

If the CATV channel you want to preset is indicated by its frequency (for example, 152.75 MHz), refer to the table below to find the corresponding channel number. Channel number S05 is for this example.

## Channel system for the French CATV network

Corresponding channel	REGLAGE CANAL number	Receivable frequency range (MHz)
B	S01	116.75–124.75
C	S02	124.75–132.75
D	S03	132.75–140.75
D	S04	140.75–148.75
E	S05	148.75–156.75
F	S06	156.75–164.75
F	S07	164.75–172.75
G	S08	172.75–180.75
H	S09	180.75–188.75
H	S10	188.75–196.75
I	S11	196.75–204.75
J	S12	204.75–212.75
J	S13	212.75–220.75
K	S14	220.75–228.75
L	S15	228.75–236.75
L	S16	236.75–244.75
M	S17	244.75–252.75
N	S18	252.75–260.75
N	S19	260.75–268.75
O	S20	268.75–276.75
P	S21	276.75–284.75
P	S22	284.75–292.75
Q	S23	292.75–300.75

Corresponding channel	REGLAGE CANAL number	Receivable frequency range (MHz)
S21	S24	299.25–307.25
S22	S25	307.25–315.25
S23	S26	315.25–323.25
S24	S27	323.25–331.25
S25	S28	331.25–339.25
S26	S29	339.25–347.25
S27	S30	347.25–355.25
S28	S31	355.25–363.25
S29	S32	363.25–371.25
S30	S33	371.25–379.25
S31	S34	379.25–387.25
S32	S35	387.25–395.25
S33	S36	395.25–403.25
S34	S37	403.25–411.25
S35	S38	411.25–419.25
S36	S39	419.25–427.25
S37	S40	427.25–435.25
S38	S41	435.25–443.25
S39	S42	443.25–451.25
S40	S43	451.25–459.25
S41	S44	459.25–467.25

### Tip

- If you want to return to the previous menu, highlight RETOUR and press OK.

### Notes

- The menu disappears automatically if you don't proceed for more than a few minutes.
- When adjusting ACCORD FIN, the menu may become difficult to read due to interference from the picture being received.

# Changing/disabling programme positions

After setting the channels, you can change the programme positions as you like. If any programme positions are unused or contain unwanted channels, you can disable them.

You can also change the station names (not available on SLV-SE610B). If the station names are not displayed, you can enter them manually.

## Changing programme positions

### Before you start...

- Turn on the VCR and the TV.
- Set the TV to the video channel.
- Refer to "Index to parts and controls" for button locations.

1 Press MENU, then press  $\uparrow/\downarrow$  to highlight LISTES and press OK.

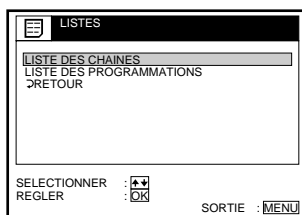
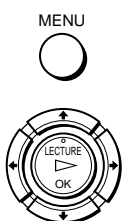

2 Press  $\uparrow/\downarrow$  to highlight LISTE DES CHAINES, then press OK.

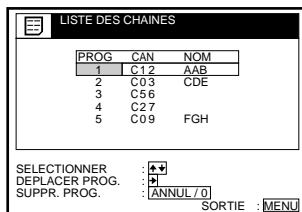

3 Press  $\uparrow/\downarrow$  to highlight the row which you want to change the programme position, then press  $\rightarrow$ .



To display other pages for programme positions 6 to 60, press  $\uparrow/\downarrow$  repeatedly.

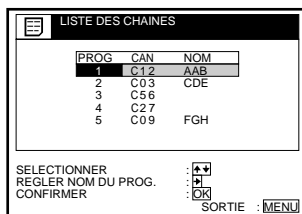

**4** Press **↑/↓** until the selected channel row moves to the desired programme position.  
The selected channel is inserted at the new programme position and the intermediate channels are displaced to fill the gap.

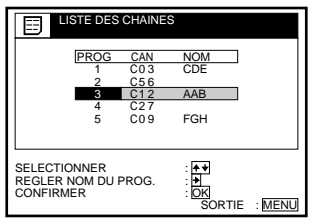

**5** Press **OK** to confirm the setting.



**6** To change the programme position of another station, repeat steps 3 through 5.

**7** Press **MENU** to exit the menu.



**Tip**

- If you want to return to the previous menu, highlight **RETOUR** and press **OK**.

**Note**

- The menu disappears automatically if you don't proceed for more than a few minutes.

**Disabling unwanted programme positions**

After presetting channels, you can disable unused programme positions. The disabled positions will be skipped later when you press the **CHAINE +/-** buttons.

**Before you start...**

- Turn on the VCR and the TV.
- Set the TV to the video channel.
- Refer to "Index to parts and controls" for button locations.

**1** Press **MENU**, then press **↑/↓** to highlight **LISTES**, and press **OK**.

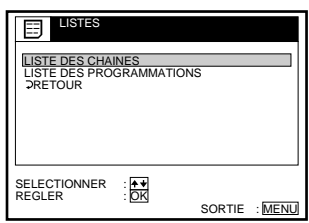
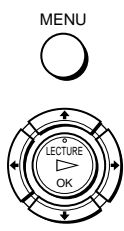

*continued*

2



Press **↑/↓** to highlight LISTE DES CHAINES, then press OK.

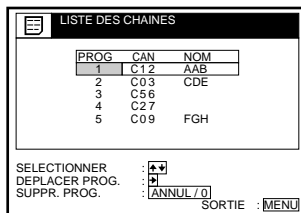

3



Press **↑/↓** to highlight the row which you want to disable.

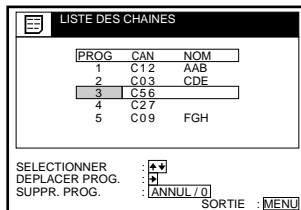

4



Press ANNUL/0.

The selected row will be cleared as shown on the right.

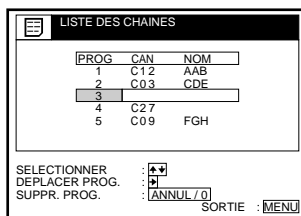

5

Repeat steps 3 and 4 for any other programme positions you want to disable.

6



Press MENU to exit the menu.

**Tip**

- If you want to return to the previous menu, highlight RETOUR and press OK.

**Notes**

- The menu disappears automatically if you don't proceed for more than a few minutes.
- Be sure to select the programme position you want to disable correctly. If you disable a programme position by mistake, you need to reset that channel manually.



## Changing the station names (not available on SLV-SE610B)

You can change or enter the station names (up to 5 characters). The VCR must receive channel information (for instance, SMARTLINK information) for station names to appear automatically.

### Before you start...

- Turn on the VCR and the TV.
- Set the TV to the video channel.
- Refer to "Index to parts and controls" for button locations.

1

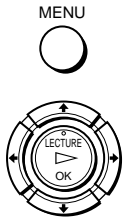

Press MENU, then press  $\uparrow/\downarrow$  to highlight LISTES and press OK.

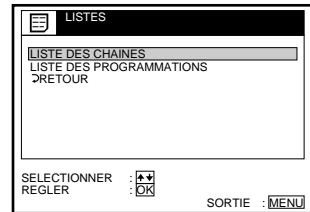

2



Press  $\uparrow/\downarrow$  to highlight LISTE DES CHAINES, then press OK.

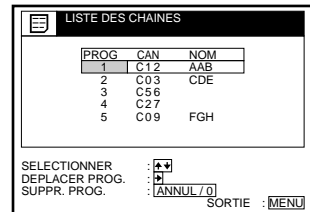

3



Press  $\uparrow/\downarrow$  to highlight the row which you want to change or enter the station name, then press  $\rightarrow$ .

To display other pages for programme positions 6 to 60, press  $\uparrow/\downarrow$  repeatedly.

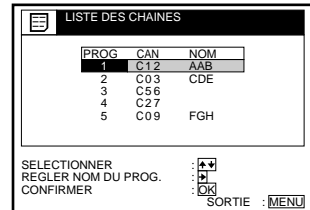

4



Press  $\rightarrow$ .

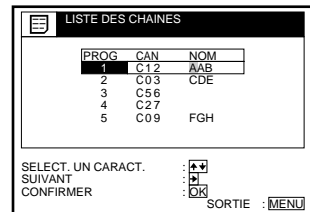

continued

5



Enter the station name.

1 Press  $\uparrow/\downarrow$  to select a character.

Each time you press  $\uparrow$ , the character changes as shown below.

A  $\rightarrow$  B  $\rightarrow$  ...  $\rightarrow$  Z  $\rightarrow$  a  $\rightarrow$  b  $\rightarrow$   
...  $\rightarrow$  z  $\rightarrow$  0  $\rightarrow$  1  $\rightarrow$  ...  $\rightarrow$  9  $\rightarrow$   
(symbols)  $\rightarrow$  (blank space)  
 $\rightarrow$  A

PROG	CAN	NOM
1	C12	CAB
2	C03	CDE
3	C56	
4	C27	
5	C09	FGH

SELECT. UN CARACT.  $\uparrow/\downarrow$   
SUIVANT  $\rightarrow$   
CONFIRMER  $\leftarrow/\rightarrow$   
SORTIE : MENU

2 Press  $\rightarrow$  to set the next character.

The next space is highlighted.

To correct a character, press  $\leftarrow/\rightarrow$  until the character you want to correct is highlighted, then reset it.

You can set up to 5 characters for the station name.

6



Press OK to confirm the new name.

7



Press MENU to exit the menu.

### Tip

- If you want to return to the previous menu, highlight RETOUR and press OK.

### Notes

- The menu disappears automatically if you don't proceed for more than a few minutes.
- If you enter a symbol in step 5, it will appear as a blank space in the display window.

# Setting the clock

You must set the time and date on the VCR to use the timer features properly.

The Auto Clock Set function (not available on SLV-SE610B) works only if a station in your area is broadcasting a time signal. If the Auto Set Up function did not set the clock correctly for your local area, try another station for the Auto Clock Set function.

## Setting the clock manually

### Before you start...

- Turn on the VCR and the TV.
- Set the TV to the video channel.
- Refer to "Index to parts and controls" for button locations.

1

MENU



Press MENU, then press **↑/↓** to highlight REGLAGES and press OK.

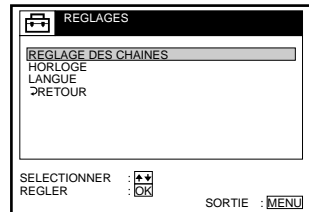

2



Press **↑/↓** to highlight HORLOGE, then press OK.

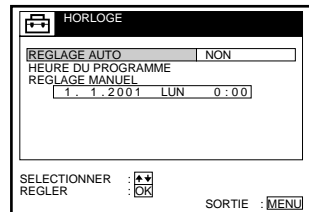

3



Press **↑/↓** to highlight REGLAGE MANUEL, then press OK.

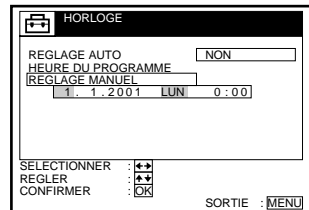

continued

4



Press  $\uparrow/\downarrow$  to set the day.

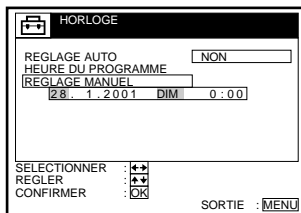

5



Press  $\rightarrow$  to highlight the month and set the month pressing  $\uparrow/\downarrow$ .

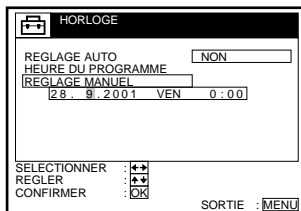

6



Set the year, hour, and minutes in sequence, pressing  $\rightarrow$  to highlight the item to be set, and press  $\uparrow/\downarrow$  to select the digits.

The day of the week is set automatically.

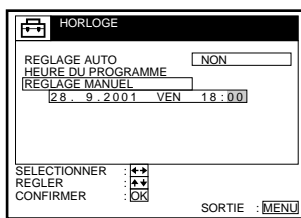

7



Press OK to start the clock.

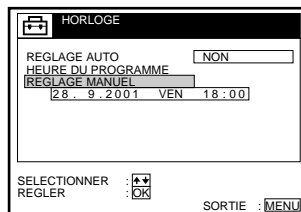

8

MENU



Press MENU to exit the menu.

### Tips

- To change the digits while setting, press  $\leftarrow$  to return to the item to be changed, and select the digits by pressing  $\uparrow/\downarrow$ .
- If you want to return to the previous menu, highlight RETOUR and press OK.

### Note

- The menu disappears automatically if you don't proceed for more than a few minutes.

## Changing the station for the Auto Clock Set function (not available on SLV-SE610B)

### Before you start...

- Turn on the VCR and the TV.
- Set the TV to the video channel.
- Refer to “Index to parts and controls” for button locations.

1

MENU



Press MENU, then press **↑/↓** to highlight REGLAGES and press OK.

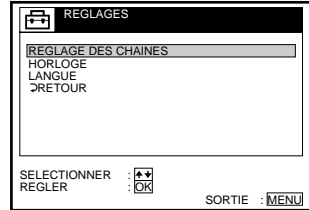

2



Press **↑/↓** to highlight HORLOGE, then press OK.  
REGLAGE AUTO is highlighted.

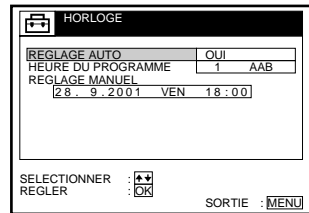

3



Press OK.

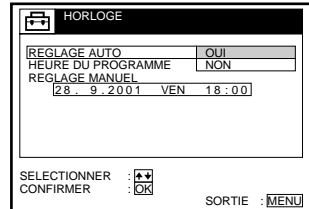

4



Press **↑/↓** to highlight OUI, then press OK.

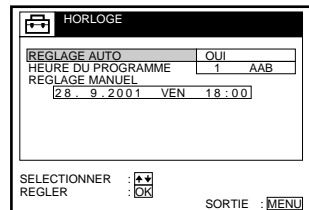

continued

5



Press **↓** to highlight HEURE DU PROGRAMME, then press OK.

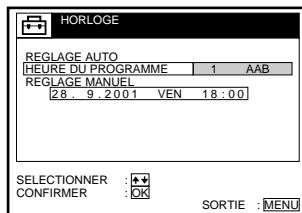

6



Press **↑/↓** repeatedly until the programme position of the station that carries a time signal appears.  
If the VCR does not receive a time signal from any station, REGLAGE AUTO returns to NON automatically.

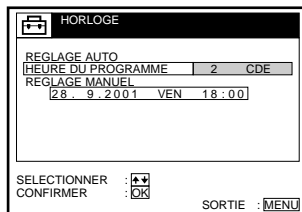

7

MENU



Press MENU to exit the menu.

### Tips

- If you set REGLAGE AUTO to OUI, the Auto Clock Set function is activated whenever the VCR is turned off. The time is adjusted automatically by making reference to the time signal from the station whose programme position is displayed in the “HEURE DU PROGRAMME” row.  
If you do not need the Auto Clock Set, select NON.
- If you want to return to the previous menu, highlight RETOUR and press OK.

### Note

- The menu disappears automatically if you don't proceed for more than a few minutes.

# Setting the Canal Plus decoder

You can watch or record the Canal Plus programme if you connect a decoder (not supplied) to the VCR.

## Connecting a decoder

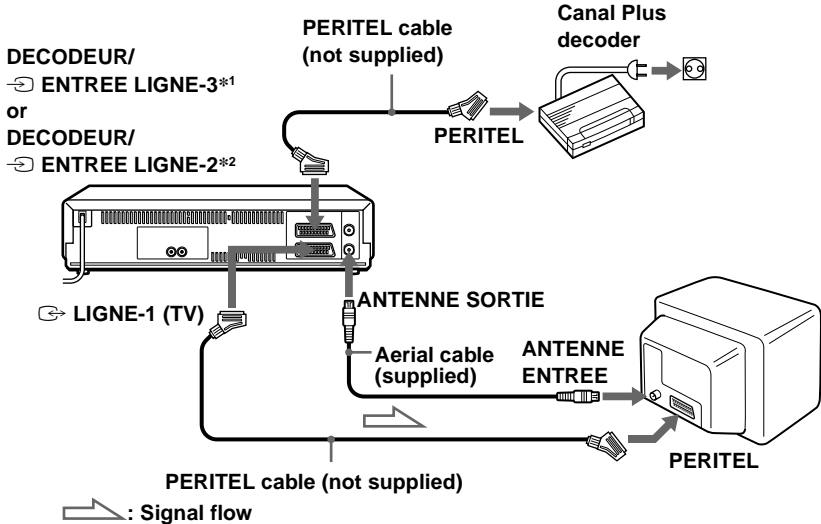

## Setting the Canal Plus channel

To watch or record the Canal Plus programme, set your VCR to receive the channel using the on-screen display.

In order to set the channel correctly, be sure to follow all of the steps below.

### Before you start...

- Turn on the VCR, the TV, and the decoder.
- Set the TV to the video channel.
- Refer to "Index to parts and controls" for button locations.

# 1

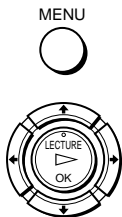

Press MENU, then press **↑/↓** to highlight OPTIONS and press OK.

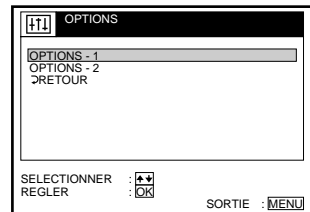

*continued*

2



Press **↑/↓** to highlight **OPTIONS-2**, then press **OK**.

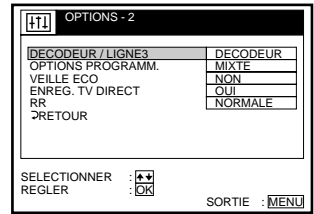

3



Press **↑/↓** to highlight **DECODEUR/LIGNE3\*1** (or **DECODEUR/LIGNE2\*2**), then press **OK**.

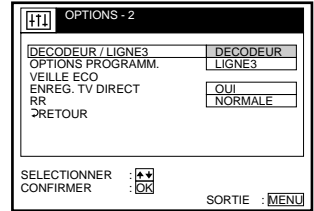

4



Press **↑/↓** to highlight **DECODEUR**, then press **OK**.

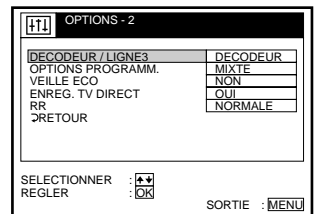

5



Press **MENU** to exit the menu.  
The menu disappears from the TV screen.

6



Press **MENU** again. Then press **↑/↓** to highlight **REGLAGES** and press **OK**.

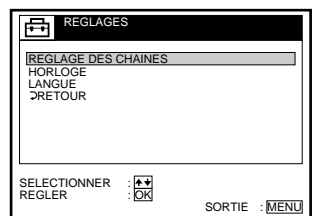

7



Press **↑/↓** to highlight **REGLAGE DES CHAINES**, then press **OK**.

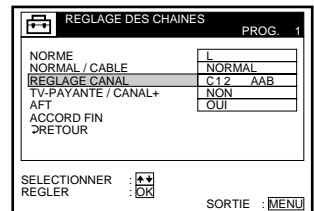



8



Press **↑/↓** to highlight **NORME**, then press **OK**.

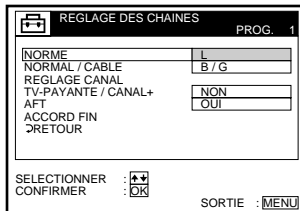

9



Press **↑/↓** to highlight **L** or **B/G**, then press **OK**.

- To receive broadcasts in France, highlight **L**.
- To receive broadcasts using the PAL system (for example, in Germany or Switzerland), highlight **B/G**.

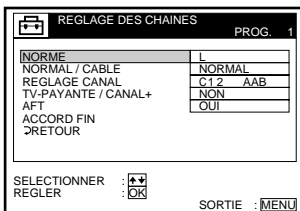

10



Press **↑/↓** to highlight **NORMAL / CABLE**, then press **OK**.

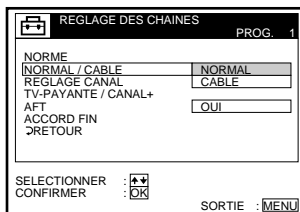

11



Press **↑/↓** to highlight **NORMAL**, then press **OK**.

To preset CATV (Cable Television) channels, select **CABLE**.

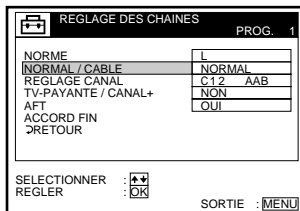

12

• CHAINE



Press **CHAINE +/-** to select the desired programme position.

**Selected programme position**

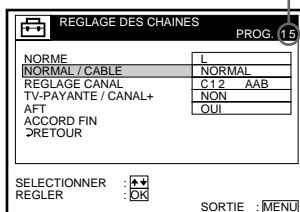

*continued*

13



Press **↑/↓** to highlight REGLAGE CANAL, then press OK.

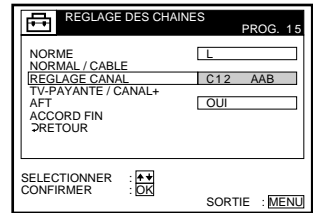

14



Press **↑/↓** to select the Canal Plus channel, then press OK.

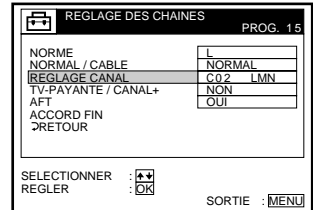

15



Press **↑/↓** to highlight TV-PAYANTE/CANAL+, then press OK.

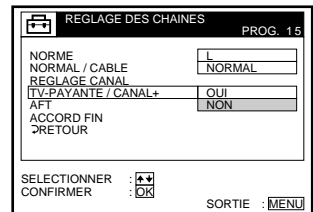

16



Press **↑/↓** to highlight OUI, then press OK.

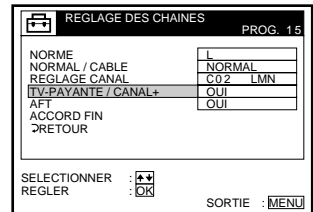

17

MENU



Press MENU to exit the menu.

### Tip

- If you want to return to the previous menu, highlight RETOUR and press OK.

**Notes**

- The menu disappears automatically if you don't proceed for more than a few minutes.
- To superimpose subtitles while watching the Canal Plus programme, make both decoder-VCR and VCR-TV connections using 21-pin PERITEL cables that are compatible with the RGB signals. You cannot record subtitles on the VCR.
- When you watch the Canal Plus programme through the RFU input of the TV, press  TV/MAGN so that the MAGN indicator appears in the display window.
- If VEILLE ECO is set to TOTAL, you cannot watch or record Canal Plus programmes during standby mode. Set VEILLE ECO in the OPTIONS-2 menu to NON or PARTIELLE.

\*1 SLV-SE810B only

\*2 SLV-SE610B, SE710B, and SX710B only

# Playing a tape

## Before you start...

- Refer to “Index to parts and controls” for button locations.

**1** Turn on your TV and set it to the video channel.

**2** Insert a tape.  
The VCR turns on and starts playing automatically if you insert a tape with its safety tab removed.

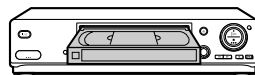

**3** Press  LECTURE.  
When the tape reaches the end, it will rewind automatically.



## Additional tasks

To	Press
Stop play	■ STOP
Pause play	PAUSE
Resume play after pause	PAUSE or  LECTURE
Fast-forward the tape	▶▶ AV during stop
Rewind the tape	◀◀ RET during stop
Eject the tape	▲ EJECT

## To set the colour system

If the playback picture has no colour, or streaks appear during playback, set the STANDARD COULEUR option in the OPTIONS-1 menu to conform to the system that the tape was recorded in (see page 84). (Normally set the option to AUTO).

## To use the time counter

Press ANNUL/0 at the point on the tape that you want to find later. The counter in the display window resets to “0:00:00.” Search for the point afterwards by referring to the counter.

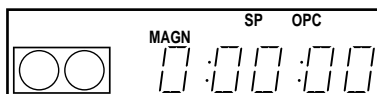

To display the counter on the TV screen, press  AFFICH.

## Notes

- The counter resets to “0:00:00” whenever a tape is reinserted.
- The counter stops counting when it comes to a portion with no recording.
- The time counter does not appear on the TV screen when using an NTSC-recorded tape.
- Depending on your TV, the following may occur while playing an NTSC-recorded tape:
  - The picture becomes black and white.
  - The picture shakes.
  - No picture appears on the TV screen.
  - Black streaks appear horizontally on the TV screen.
  - The colour density increases or decreases.
- If you play back a tape in LP or EP mode with the NTSC system, the sound becomes monaural.
- While setting the menu on the TV screen, buttons for playback on the remote commander do not function.

## Starting playback automatically with one button (One Touch Play) (not available on SLV-SE610B)

If you use the SMARTLINK connection, you can turn on the VCR and the TV, set the TV to the video channel, and start playback automatically with one button.

### 1 Insert a tape.

The VCR automatically turns on.

If you insert a tape with its safety tab removed, the TV turns on and switches to the video channel. Playback starts automatically.

### 2 Press $\triangleright$ LECTURE.

The TV turns on and switches to the video channel automatically. Playback starts.

## Tip

- When there already is a tape in the VCR, the VCR and the TV turn on, the TV is set to the video channel, and playback starts automatically in one sequence when you press  $\triangleright$  LECTURE.

## Note

- When you use the One Touch Play function, leave the TV on or in the standby mode.

# Recording TV programmes

## Before you start...

- Refer to "Index to parts and controls" for button locations.

**1** Turn on your TV and set it to the video channel.  
To record from a decoder, turn it on.

**2** Insert a tape with its safety tab in place.

**3** Press CHAINE +/- to select the programme position or station name you want to record.

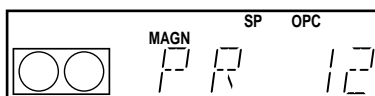

**4** Press SP/LP to select the tape speed, SP or LP.



LP (Long Play) provides recording time twice as long as SP. However, SP (Standard Play) produces better picture and audio quality.

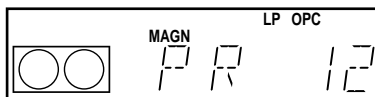

**5** Press ● ENR to start recording.



The recording indicator lights up red in the display window.

Recording indicator

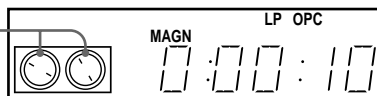

## To stop recording

Press ■ STOP.

## To check the remaining time

Press **(+)** AFFICH. With the display on, press COMPT/DUREE REST to check the remaining time. Each time you press COMPT/DUREE REST, the time counter and the remaining time appear alternately. The  indicator indicates the remaining time.



Time counter

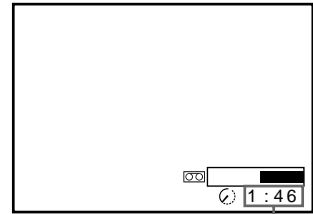

Remaining time

In order to get an accurate remaining time indication, be sure DUREE CASSETTE in the OPTIONS-1 menu is set according to the tape type you use (see page 84).

## To watch another TV programme while recording

- 1 Press **(TV)** TV/MAGN to turn off the MAGN indicator in the display window.
- 2 Select another programme position on the TV.

## To save a recording

To prevent accidental erasure, break off the safety tab as illustrated. To record on the same tape again, cover the tab hole with adhesive tape.

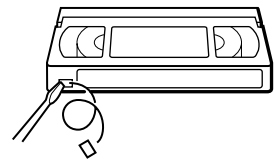

Safety tab

## Tips

- To select a programme position, you can use the programme number buttons on the remote commander. For two-digit numbers, press the **-/-** (ten's digit) button followed by the programme number buttons.
- If you connect additional equipment to the LIGNE-1 (TV) or ENTREE LIGNE-2 connector, you can select the input signal using the CHOIX ENTREE or CHAINE +/- buttons.
- The **(+)** AFFICH information appears on the TV screen indicating information about the tape, but the information won't be recorded on the tape.
- If you don't want to watch TV while recording, you can turn off the TV. When using a decoder, make sure to leave it on.

*continued*

## Notes

- The **[+]** AFFICH information does not appear during still (pause) mode or slow-motion playback.
- The **[+]** AFFICH information will not appear while playing an NTSC-recorded tape.
- If a tape has portions recorded in both PAL (SECAM, MESECAM) and NTSC systems, the time counter reading will not be correct. This discrepancy is due to the difference between the counting cycles of the two video systems.
- When you insert a non-standard commercially available tape, the remaining time may not be correct.
- The remaining time is intended for rough measurement only.
- About 30 seconds after the tape begins playback, the tape remaining time will be displayed.
- The station name\* may not appear if the VCR does not receive station name information signals.

\* not available on SLV-SE610B

## Recording what you are watching on the TV (TV Direct Rec) (not available on SLV-SE610B)

If you use the SMARTLINK connection, you can easily record what you are watching on the TV (other than tapes being played on the VCR).

- 1** Insert a tape with its safety tab in place.
- 2** Press ● ENR while you are watching a TV programme or external source.

The VCR automatically turns on, then the TV indicator lights up and the VCR starts recording what you are watching on the TV.

## Tips

- The TV indicator appears in the display window after you press ● ENR in some situations such as:
  - when you are watching a source connected to the TV's line input, or
  - when the TV tuner preset data for the programme position is different from the data in the VCR tuner preset.
- If there is a tape with its safety tab in place in the VCR, the VCR automatically turns on and starts recording what you are watching on the TV when you press ● ENR.
- You can turn the TV Direct Rec function OUI and NON in the OPTIONS-2 menu (see page 85).



**Notes**

- You cannot record what you are watching using this method when the VCR is in the following modes; pause, timer standby, tuner preset, Auto Set Up, and recording.
- When the TV indicator is lit in the display window, do not turn off the TV nor change the TV programme position. When the TV indicator is not lit, the VCR continues recording the programme even if you change the TV programme position on the TV.

# Recording TV programmes using the Dial Timer (SLV-SE810B only)

The Dial Timer function allows you to make timer recordings of programmes without turning on your TV. Set the recording timer to record up to eight programmes, including settings made with other timer methods, that will be broadcast within the next month. The recording start time and recording stop time can be set at one minute intervals.

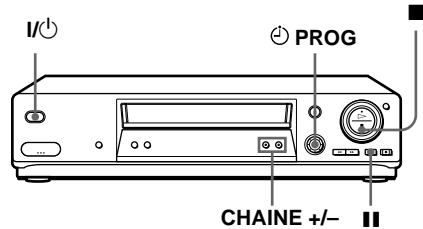

## Before you start...

- Insert a tape with its safety tab in place. Make sure the tape is longer than the total recording time.
- To record from a decoder, turn it on.
- Refer to “Index to parts and controls” for button locations.

1



Press PROG.

“DATE” and “TODAY” appear alternately in the display window.

If the date and time are not set, “DAY” will appear. See step 2 in the following section, “To set the clock” to set the date and time.

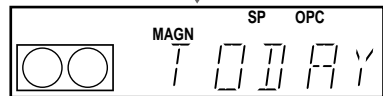
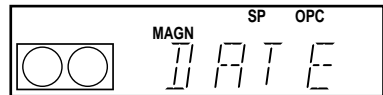

2

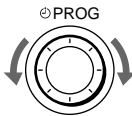

Turn PROG to set the recording date.

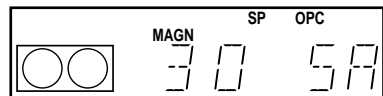

3



Press **PROG**.

“START” and the current time appear alternately in the display window.

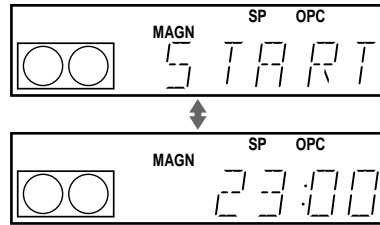

4

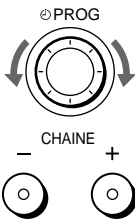

Turn **PROG** to set the recording start time.

You can set the recording start time in 15 minute intervals or adjust the time in one minute intervals by pressing the CHAINE +/- buttons.

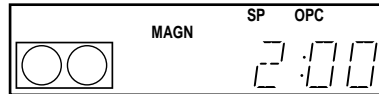

5



Press **PROG**.

“STOP” and the recording stop time appear alternately in the display window.

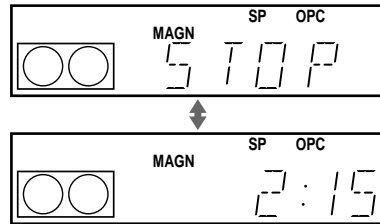

6

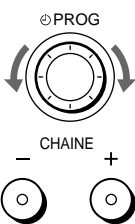

Turn **PROG** to set the recording stop time.

You can set the recording stop time in 15 minute intervals or adjust the time in one minute intervals by pressing the CHAINE +/- buttons.

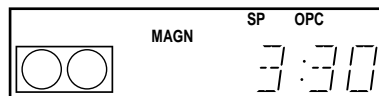

continued

---

**7**

Press  PROG.

The programme position or station name appears in the display window.

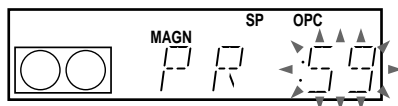

---

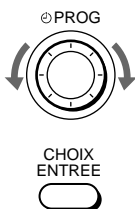
**8**

Turn  PROG to set the programme position.

To record from a decoder or other source connected to the LIGNE-1 (TV) or ENTREE LIGNE2 connector, turn  PROG or press CHOIX ENTREE to display “L1” or “L2” in the display window.

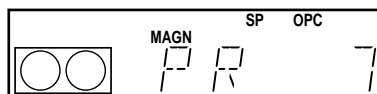

---

**9**

Press  PROG to complete the setting.

“OK” appears in the display window for about five seconds.

The  indicator appears in the display window and the VCR stands by for recording.

To record from a decoder or other source, leave the connected equipment switched on.

---



### To return to the previous step

To return to the previous step, press the CHAINE + and – buttons on the VCR at the same time during any of the Dial Timer settings.

### To stop recording

To stop the VCR while recording, press  STOP.

### To use the VCR after setting the timer

To use the VCR before a recording begins, just press . The  indicator turns off and the VCR switches on. Remember to press  to reset the VCR to recording standby after using the VCR.

You can also do the following tasks while the VCR is recording:

- Reset the counter (page 44).
- Display tape information on the TV screen (page 47).
- Check the timer settings (page 68).
- Watch another TV programme (page 47).

## To set the clock

- 1** Turn  $\ominus$  PROG so that “CLOCK” appears in the display window.
- 2** Press  $\ominus$  PROG.  
“DAY” appears in the display window.
- 3** Turn  $\ominus$  PROG to set the day.
- 4** Press  $\ominus$  PROG.  
“MONTH” appears in the display window.
- 5** Turn and press  $\ominus$  PROG to set the month, and then the year.  
After you set the year, “CLOCK” appears in the display window again.
- 6** Turn and press  $\ominus$  PROG to set the hour and minute.
- 7** When you have finished setting the time, press  $\ominus$  PROG to start the clock.

### Tips

- To cancel a Dial Timer setting, press  $\blacksquare$  (stop) on the VCR while you are making the setting.
- The programme is recorded in the current tape speed mode. To change the tape speed, press SP/LP before you complete the setting in step 9.
- When you are recording a programme in the SP mode and the remaining tape becomes shorter than the recording time, the tape speed is automatically changed to the LP mode. Note that some interference will appear on the picture at the point the tape speed is changed. If you want to keep the same tape speed, set VITESSE AUTO. to NON in the OPTIONS-1 menu (page 84).
- To check, change, or cancel the programme setting, see “Checking/changing/cancelling timer settings” (page 68).

### Notes

- If eight programmes have already been set using the ShowView system or the MINUTERIE menu, “FULL” appears in the display window for about five seconds.
- The  $\ominus$  indicator flashes in the display window when you complete the setting in step 9 with no tape inserted.
- If you set the clock using the Auto Clock Set function and REGLAGE AUTO is set to OUI, the clock will adjust itself to the incoming time signal regardless of adjustments made with the Dial Timer. Be sure you have set the Auto Clock Set correctly.
- The station name may not appear if the VCR does not receive station name information signals.

*continued*

## About the Demonstration Mode

The Dial Timer function has a Demonstration Mode that allows the user, such as a salesperson, to enter more than eight examples of timer settings when demonstrating the use of the Dial Timer. It cancels the FULL notice which appears if eight programmes have already been set. Do not use the Demonstration Mode for making timer recordings. Doing so may cause the settings to be inaccurate.

### To activate the Demonstration Mode

Press **||** (pause) on the VCR while turning the  $\ominus$  PROG. “DEMO” appears in the display window for a few seconds.

### To cancel the Demonstration Mode

Turn the power off and unplug the mains lead. Although the Demonstration Mode is cancelled, the timer settings entered while using the Demonstration Mode will remain. Be sure to manually cancel the timer settings before you use the Dial Timer or any other timer method after reconnecting the mains lead (see page 68).

# Recording TV programmes using the ShowView system (not available on SLV-SE610B)

The ShowView system is the feature that simplifies programming the VCR to make timer recordings. Just enter the ShowView number listed in the TV programme guide. The date, times, and programme position of that programme are set automatically. You can preset a total of eight programmes, including settings made with other timer methods.

## Before you start...

- Check that the VCR clock is set to the correct time and date.
- Insert a tape with its safety tab in place. Make sure the tape is longer than the total recording time.
- To record from a decoder, turn it on.
- Turn on your TV and set it to the video channel.
- Set OPTIONS PROGRAMM. to SHOWVIEW or MIXTE in the OPTIONS-2 menu (see page 84).
- Refer to “Index to parts and controls” for button locations.

1

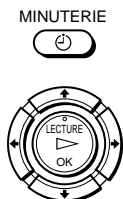

Press MINUTERIE.

- When you set OPTIONS PROGRAMM. to MIXTE: The METHODE DE PROGRAMMATION menu appears on the TV screen. Press / to select SHOWVIEW, then press OK.
- When you set OPTIONS PROGRAMM. to SHOWVIEW: The SHOWVIEW menu appears on the TV screen.

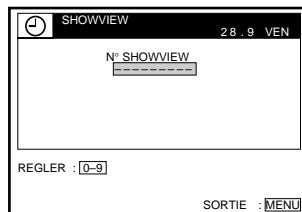
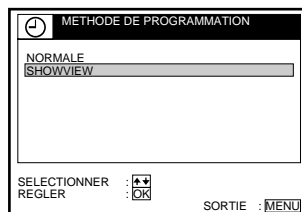

*continued*

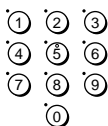
**2**

Press the programme number buttons to enter the ShowView number.

If you make a mistake, press ANNUL/0 and re-enter the correct number.

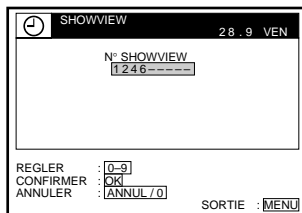
**3**

CHOIX  
ENTREE



ANNUL/0



Press OK.

The date, start and stop times, programme position or station name, tape speed, and VPS/PDC setting appear on the TV screen.

If “-” appears in the “PROG.” (programme) column (this may happen for local broadcasts), you have to set the appropriate programme position manually.

Press  $\uparrow/\downarrow$  to select the desired programme position.

To record from a decoder or other source connected to the LIGNE-1 (TV) or ENTREE LIGNE-2 connector, press CHOIX ENTREE to display “L1” or “L2” in the “PROG.” position.

You will only have to do this operation once for the referred channel. The VCR will then store your setting.

If the information is incorrect, press ANNUL/0 to cancel the setting.

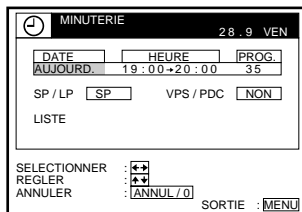
**4**

If you want to change the date, tape speed, and the VPS/PDC setting:

1 Press  $\leftarrow/\rightarrow$  to highlight the item you want to change.

2 Press  $\uparrow/\downarrow$  to reset it.

- To record the same programme every day or the same day every week, see “Daily/weekly recording” on page 57.
- To use the VPS/PDC function, set VPS/PDC to OUI. For details about the VPS/PDC function, see “Timer recording with VPS/PDC signals” on page 57.

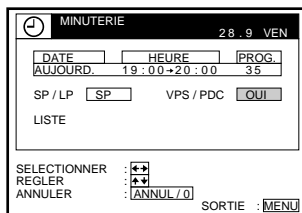
**5**

Press MENU to exit the menu.



## 6



Press **I/⏻** to turn off the VCR.

The **⏻** indicator appears in the display window and the VCR stands by for recording.

To record from a decoder or other source, leave the connected equipment switched on.

### To stop recording

To stop the VCR while recording, press **■ STOP**.

### Daily/weekly recording

In step 4 above, press **↓** to select the recording pattern. Each time you press **↓**, the indication changes as shown below. Press **↑** to change the indication in reverse order.

**AUJOURD.** → **DIM-SAM (Sunday to Saturday)** → **LUN-SAM (Monday to Saturday)** → **LUN-VEN (Monday to Friday)** → **SAM (every Saturday) .....**  
→ **LUN (every Monday)** → **DIM (every Sunday)** → **1 month later** →  
**(dates count down)** → **DEMAIN** → **AUJOURD.**

### Timer recording with VPS/PDC signals

Some broadcast systems transmit VPS (Video Programme System) or PDC (Programme Delivery Control) signals with their TV programmes. These signals ensure that your timer recordings are made regardless of broadcast delays, early starts, or broadcast interruptions (when the VPS or PDC indicator in the display window is lit).

To use the VPS/PDC function, set VPS/PDC to OUI in step 4 above. You can also use the VPS/PDC function for a source connected to the LIGNE-1 (TV) and ENTREE LIGNE-2 connectors.

### To record satellite broadcasts

If you connect a satellite tuner and the VCR, you can record satellite programmes.

- 1** Turn on the satellite tuner.
- 2** On the satellite tuner, select the satellite programme for which you want to make a timer setting.
- 3** Follow steps 1 through 6 above.
- 4** Keep the satellite tuner turned on until the VCR finishes recording the satellite programme for which you have made a timer setting.

*continued*

## To use the VCR after setting the timer

To use the VCR before a recording begins, just press I/⏻. The ⏻ indicator turns off and the VCR switches on. Remember to press I/⏻ to reset the VCR to recording standby after using the VCR.

You can also do the following tasks while the VCR is recording:

- Reset the counter (page 44).
- Display tape information on the TV screen (page 47).
- Check the timer settings (page 68).
- Watch another TV programme (page 47).

### Tips

- To set the programme position, you can also use the CHAINE +/- or programme number buttons.
- To set the programme position with a two digit number, press -/-- (ten's digit) button followed by the programme number buttons.
- To set the line input video source, you can also use the CHAINE +/- buttons.
- To set the tape speed, you can also use the SP/LP button.
- When you are recording a programme in the SP mode and the remaining tape becomes shorter than the recording time, the tape speed is automatically changed to the LP mode. Note that some interference will appear on the picture at the point the tape speed is changed. If you want to keep the same tape speed, set VITESSE AUTO. to NON in the OPTIONS-1 menu (page 84).
- To check, change, or cancel the programme setting, press ◀/▶ to choose LISTE, then press OK in step 4. For details, see step 3 in "Checking/changing/cancelling timer settings" (page 68).

### Notes

- If the VPS/PDC signal is too weak or the broadcasting station failed to transmit VPS/PDC signals, the VCR will start recording at the set time without using the VPS/PDC function.
- The ⏻ indicator flashes in the display window when you press I/⏻ with no tape inserted.
- When you set OPTIONS PROGRAMM. to NORMALE in the OPTIONS-2 menu, the SHOWVIEW menu does not appear on the TV screen. Select SHOWVIEW or MIXTE.
- The VPS/PDC function is automatically set to NON for the timer recording of a satellite programme.
- The station name may not appear if the VCR does not receive station name information signals.

# Recording TV programmes using the timer

You can preset a total of eight programmes, including settings made with other timer methods.

## Before you start...

- Check that the VCR clock is set to the correct time and date.
- Insert a tape with its safety tab in place. Make sure the tape is longer than the total recording time.
- To record from a decoder, turn it on.
- Turn on your TV and set it to the video channel.
- Set OPTIONS PROGRAMM. to NORMALE or MIXTE in the OPTIONS-2 menu (see page 84).\*
- Refer to "Index to parts and controls" for button locations.

### 1

MINUTERIE



Press MINUTERIE.

For SLV-SE610B:  
The MINUTERIE menu appears on the TV screen.

For SLV-SE710B, SX710B, and SE810B:

- When you set OPTIONS PROGRAMM. to MIXTE:  
The METHODE DE PROGRAMMATION menu appears on the TV screen. Press to select NORMALE, then press OK.
- When you set OPTIONS PROGRAMM. to NORMALE:  
The MINUTERIE menu appears on the TV screen.

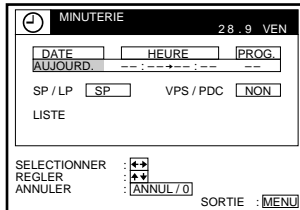
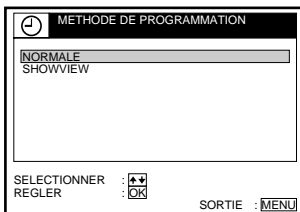
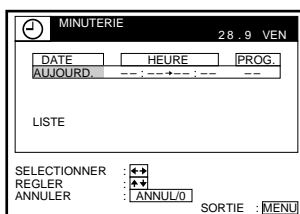

*continued*

2



CHOIX  
ENTREE



Set the date, start and stop times, programme position or station name\*, tape speed, and VPS/PDC function\*:

1 Press **→** to highlight each item in turn.

2 Press **↑/↓** to set each item.

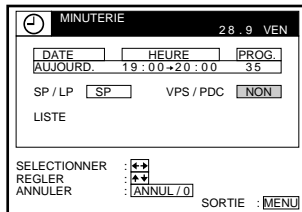

To correct a setting, press **←** to return to that setting and reset.

- To record the same programme every day or the same day every week, see “Daily/weekly recording” on page 60.
- To use the VPS/PDC function\*, set VPS/PDC to OUI. For details about the VPS/PDC function, see “Timer recording with VPS/PDC signals” on page 57.
- To record from a decoder or other source connected to the LIGNE-1 (TV) or ENTREE LIGNE-2 connector, press CHOIX ENTREE to display “L1” or “L2” in the “PROG.” position.

3

MENU



Press MENU to exit the menu.

4

• I / ⏻



Press **I/⏻** to turn off the VCR.

The **⏻** indicator appears in the display window and the VCR stands by for recording.

To record from a decoder or other source, leave the connected equipment switched on.

### To stop recording

To stop the VCR while recording, press **■ STOP**.

### Daily/weekly recording

In step 2 above, press **↓** to select the recording pattern. Each time you press **↓**, the indication changes as shown below. Press **↑** to change the indication in reverse order.

**AUJOURD.** → **DIM-SAM (Sunday to Saturday)** → **LUN-SAM (Monday to Saturday)** → **LUN-VEN (Monday to Friday)** → **SAM (every Saturday) .....**  
→ **LUN (every Monday)** → **DIM (every Sunday)** → **1 month later** →  
**(dates count down)** → **DEMAIN** → **AUJOURD.**

## To record satellite broadcasts

If you connect a satellite tuner and the VCR, you can record satellite programmes.

- 1** Turn on the satellite tuner.
- 2** On the satellite tuner, select the satellite programme for which you want to make a timer setting.
- 3** Follow steps 1 through 4 above.
- 4** Keep the satellite tuner turned on until the VCR finishes recording the satellite programme for which you have made a timer setting.

## To use the VCR after setting the timer

To use the VCR before a recording begins, just press I/⏻. The ⏻ indicator turns off and the VCR switches on. Remember to press I/⏻ to reset the VCR to recording standby after using the VCR.

You can also do the following tasks while the VCR is recording:

- Reset the counter (page 44).
- Display tape information on the TV screen (page 47).
- Check the timer settings (page 68).
- Watch another TV programme (page 47).

## Tips

- To set the programme position, you can also use the CHAINE +/- or programme number buttons.
- To set the programme position with a two digit number, press -/-- (ten's digit) button followed by the programme number buttons.
- To set the line input video source, you can also use the CHAINE +/- buttons.
- To set the tape speed, you can also use the SP/LP button.
- When you are recording a programme in the SP mode and the remaining tape becomes shorter than the recording time, the tape speed is automatically changed to the LP mode. Note that some interference will appear on the picture at the point the tape speed is changed. If you want to keep the same tape speed, set VITESSE AUTO. to NON in the OPTIONS-1 menu (page 84).
- Even if you set OPTIONS PROGRAMM.\* to SHOWVIEW in the OPTIONS-2 menu, you can set the timer manually. Press MENU to select MINUTERIE, then go to step 2.
- To check, change, or cancel the programme setting, press ←/→ to choose LISTE, then press OK in step 2. For details, see step 3 in “Checking/changing/cancelling timer settings” (page 68).

*continued*

## Notes

- When setting the timer with VPS/PDC\* signals, enter the start and stop times exactly as indicated in the TV programme guide. Otherwise, the VPS/PDC function won't work.
- If the VPS/PDC\* signal is too weak or the broadcasting station failed to transmit VPS/PDC signals, the VCR will start recording at the set time without using the VPS/PDC function.
- The ☹ indicator flashes in the display window when you press I/⏻ with no tape inserted.
- The VPS/PDC function\* is automatically set to NON for the timer recording of a satellite programme.
- The station name\* may not appear if the VCR does not receive station name information signals.

\* not available on SLV-SE610B

# Playing/searching at various speeds

## Before you start...

- Refer to “Index to parts and controls” for button locations.

Playback options	Operation
View the picture during fast-forward or rewind	During fast-forward, hold down ►► AV/►►. During rewind, hold down ◀◀ RET/◀◀.
Play at high speed	During playback, press ►► AV or ◀◀ RET <u>on the remote commander</u> . During playback, hold down ►► AV/►► or ◀◀ RET/◀◀. When you release the button, normal playback resumes.
Play at twice the normal speed	During playback, press ×2.
Play in slow motion	During playback, press ►► RALENTI.
Play frame by frame	During pause, press ►► AV or ◀◀ RET <u>on the remote commander</u> . Hold down ►► AV or ◀◀ RET to play one frame each second.
Rewind and start play	During stop, press ▷ (play) <u>on the VCR</u> while holding down ◀◀ <u>on the VCR</u> .

Additional Operations

### To resume normal playback

Press ▷ LECTURE.

### Using the shuttle ring (SLV-SE810B only)

With the shuttle ring, you can operate a variety of playback options. There are two ways for using the shuttle ring, normal mode and jog mode.

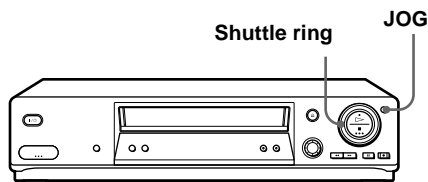

*continued*

## To use the shuttle ring in normal mode

During playback or pause, turn the shuttle ring clockwise or anticlockwise. Each change in the shuttle ring position changes the playback mode in the following way.

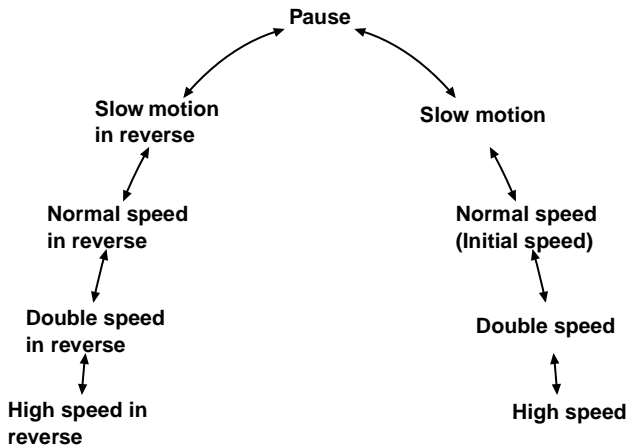

## To use the shuttle ring in jog mode

Use this mode for frame-by-frame playback.

Press JOG to enter the jog mode. The JOG button lights up. If you change to the jog mode during any playback mode, playback pauses so you can see a still picture. Each change in the shuttle ring position shifts the picture one frame. To shift frames in reverse, turn the shuttle ring anticlockwise. The frame shift speed depends on the speed you turn the shuttle ring.

To resume normal mode, press JOG again. The JOG button turns off.

### Tip

- Adjust the picture using the CHAINE +/- buttons on the VCR if:
    - Streaks appear while playing in slow motion.
    - Bands appear at the top or bottom while pausing.
    - The picture shakes while pausing.
- To set tracking to the centre position, press both buttons (+/-) at the same time.

### Notes

- The sound is muted during these operations.
- In the LP mode, noise may appear or there may be no colour.
- If the playback mode mark doesn't appear on the TV screen, press **[1+] AFFICH.**



# Setting the recording duration time

After you have started recording in the normal way, you can have the VCR stop recording automatically after a specified duration.

## Before you start...

- Refer to “Index to parts and controls” for button locations.

**1** While recording, press ● ENR.

The ⊖ indicator appears in the display window.

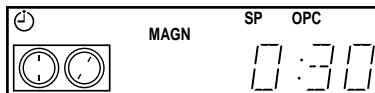

**2** Press ● ENR repeatedly to set the duration time.

Each press advances the time in increments of 30 minutes.

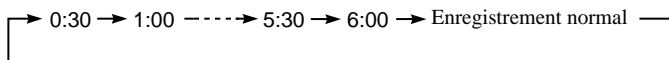

The tape counter decreases minute by minute to 0:00, then the VCR stops recording and turns off automatically.

## To extend the duration

Press ● ENR repeatedly to set a new duration time.

## To cancel the duration

Press ● ENR repeatedly until the ⊖ indicator disappears and the VCR returns to the normal recording mode.

## To stop recording

To stop the VCR while recording, press ■ STOP.

## Note

- You cannot display the current tape time in the display window when setting the recording duration time.

# Synchronized Recording (not available on SLV-SE610B)

You can set the VCR to automatically record programmes from equipment such as a satellite tuner by connecting the equipment to the **DECODEUR/ENTREE LIGNE-3 IN\*1** (or **DECODEUR/LIGNE2 IN\*2**) connector. The connected equipment must have a timer function for this feature to work.

When the connected equipment turns on, the VCR also automatically turns on and starts recording a programme from **DECODEUR/ENTREE LIGNE-3 IN\*1** (or **DECODEUR/ENTREE LIGNE-2 IN\*2**).

## How to connect for Synchronized Recording

Connect the **DECODEUR/ENTREE LIGNE-3 IN\*1** (or **DECODEUR/ENTREE LIGNE-2 IN\*2**) connector of the VCR to the **PERITEL** connector of the satellite tuner. Then connect the **LIGNE-1 (TV)** connector to the TV.

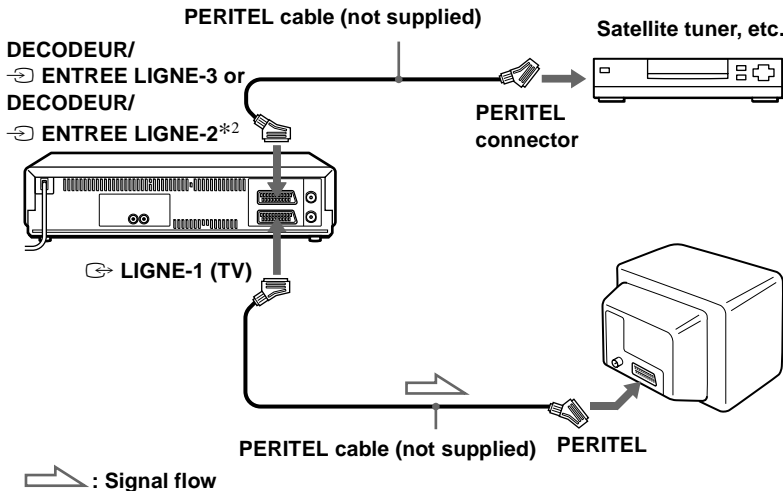

# Recording programmes using the Synchronized Recording function

## Before you start...

- Insert a tape with its safety tab in place. Make sure the tape is longer than the total recording time.
- Set DECODEUR/LIGNE3\*1 (or DECODEUR/LIGNE2\*2) to LIGNE3\*1 or (LIGNE2\*2) in the OPTIONS-2 menu (see page 84).
- Refer to “Index to parts and controls” for button locations.

ENR SYNCHRO

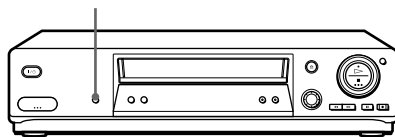

- 1** Press CHOIX ENTREE or CHAINE +/- to display “L3\*1 (or L2\*2)” in the display window.
- 2** Set the timer on the connected equipment to the time of the programme you want to record, then turn it off.
- 3** Press SP/LP to select the tape speed.
- 4** Hold down ENR SYNCHRO for more than two seconds.

The SYNCHRO indicator lights up and the VCR stands by for recording.

The VCR automatically turns on and starts recording when it receives an input signal from the connected equipment.

The VCR automatically stops recording when the tape reaches the end or when the connected equipment stops transmitting an input signal.

## To cancel the Synchronized Recording function

Press ENR SYNCHRO. The SYNCHRO indicator disappears.

## To stop recording

Press ■ STOP while recording.

## Notes

- This function may not work with some types of satellite tuners.
- Some TVs or other equipment with timer functions will automatically turn off if no operation is performed within a certain amount of time. In this case, the Synchronized Recording also stops automatically.
- When the connected equipment turns on while the SYNCHRO indicator is appeared, recording starts automatically.
- If the settings for timer recording and Synchronized Recording overlap, the programme that starts first has priority and the second programme starts recording only after the first programme has finished.
- The Auto Clock Set function does not work while the VCR stands by for Synchronized Recording.

\*1SLV-SE810B only

\*2SLV-SE710B, and SX710B only

# Checking/changing/cancelling timer settings

## Before you start...

- Turn on your TV and set it to the video channel.
- Refer to "Index to parts and controls" for button locations.

- 1 Press I/⏻ to turn on the VCR.
- 2 Press MENU, then press ↑/↓ to highlight LISTES and press OK.
- 3 Press ↑/↓ to highlight LISTE DES PROGRAMMATIONS, then press OK:

- If you want to change or cancel a setting, go on to the next step.
- If you do not need to change or cancel the settings, press MENU, then turn off the VCR to return to recording standby.

- 4 Press ↑/↓ to select the setting you want to change or cancel, then press OK.

The selected setting appears in the MINUTERIE menu.

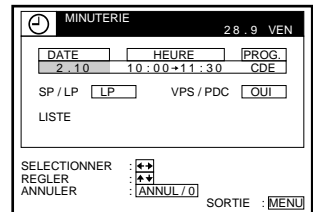
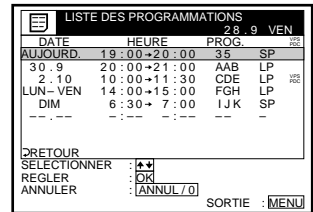

- 5 • To change the setting, press ←/→ to highlight the item you want to change, then press ↑/↓ to reset it.
  - To cancel the setting, press ANNUL/0.
- 6 Press MENU to exit the menu.

If any settings remain, turn off the VCR to return to recording standby.

## When the timer settings overlap

The programme that starts first has priority and the second programme starts recording only after the first programme has finished. If the programmes start at the same time, the programme listed first in the menu has priority.

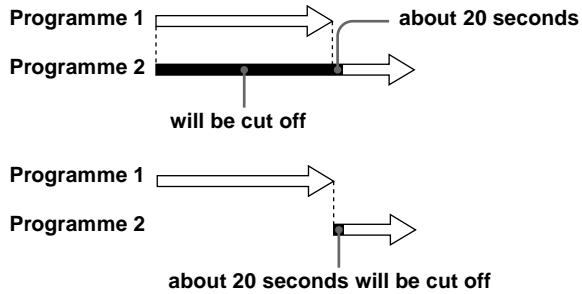

### Tip

- In step 6 above, you can check the LISTE DES PROGRAMMATIONS by selecting LISTE and pressing OK. Press MENU to exit the LISTE DES PROGRAMMATIONS.

# Recording stereo and bilingual programmes

## In ZWEITON (German stereo) system

This VCR automatically receives and records stereo and bilingual programmes based on the ZWEITON system. When a stereo or bilingual programme is received, the STEREO indicator appears in the display window.

### To select bilingual sound while recording

Press CHOIX SON to select the sound you want.

To listen to	On-screen display	Display window
Main	PRINCIPALE	STEREO
Sub	SECONDAIRE	STEREO
Main and sub	PRINCIP/SEC	STEREO

## In NICAM system

This VCR receives and records stereo and bilingual programmes based on the NICAM system (The NICAM indicator appears). When a stereo or bilingual programme is received, the STEREO indicator appears in the display window.

To record a NICAM programme, SON HIFI in the OPTIONS-1 menu should be set to NICAM (initial setting). To check the menu setting, see page 84 for details.

### To select the sound while recording

Press CHOIX SON to select the sound you want.

#### Stereo programmes

To listen to	On-screen display	Display window
Stereo	STEREO	STEREO
Standard sound*	No indicator	No indicator

\* Usually the mixed sound of left and right channels (monaural)

## Bilingual programmes

To listen to	On-screen display	Display window
Main	PRINCIPALE	STEREO
Sub	SECONDAIRE	STEREO
Main and sub	PRINCIP./SEC	STEREO
Standard sound*	No indicator	No indicator

\* Usually the main sound (monaural)

## Selecting the sound during playback

Press CHOIX SON to select the sound you want.

To listen to	On-screen display	Display window
Stereo/main and sub (left and right channels)	STEREO	STEREO
Left channel/main	CANAL G	STEREO
Right channel/sub	CANAL D	STEREO
Standard sound	No indicator	No indicator

## How sound is recorded on a video tape

The VCR records sound onto two separate tracks. Hi-fi audio is recorded onto the main track along with the picture. Monaural sound is recorded onto the normal audio track along the edge of the tape.

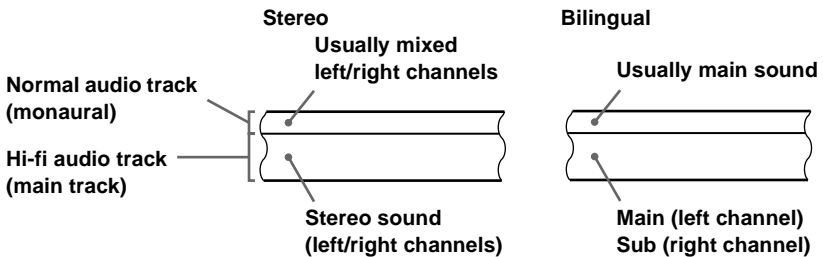

### Notes

- To listen to playback sounds in stereo, you must use the PERITEL or SORTIE AUDIO connections.
- When you play a tape recorded in monaural, the sound is heard in monaural regardless of the CHOIX SON setting.
- If the CHOIX SON does not function, check that MIX AUDIO in the OPTIONS-1 menu is set to OFF (see page 83).
- If SON HIFI is set to STANDARD, the standard sound will be recorded on both the hi-fi and normal audio tracks. Pressing CHOIX SON will not change the sound.

# Searching using the Acces Smart function

If you record multiple programmes on a tape, use the Acces Smart function to see what has been recorded on your tape. You can see information such as date, time, and programme position of programmes recorded. You can also start playback directly from the selected programme using the ACCES SMART screen.

All programmes are listed on the screen, regardless of how the programme was recorded.

To store programme information, see “Storing the programme information” on page 74. If you eject the tape before storing the information, the information will be cleared.

## Before you start...

- Turn on your TV and set it to the video channel.
- Refer to “Index to parts and controls” for button locations.

- 1 After recording, press I/⏻ to turn on the VCR.
- 2 Press ACCES SMART.
- 3 Press ↑/↓/←/→ to select the programme you want to start viewing.

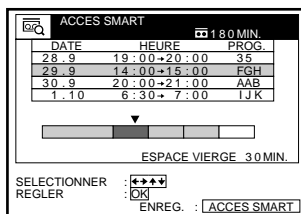

- 4 Press OK.  
The VCR starts searching, and playback starts automatically from the beginning of the selected programme.

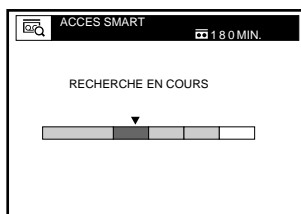

## To stop searching

Press ■ STOP.

## To exit the ACCES SMART screen

Press MENU.



## To record in a blank space

Blank space on the tape will appear as a blank row in the ACCES SMART screen. Select the last blank row in step 3, then press OK. The VCR rewinds/fast-forwards the tape to the beginning of the blank space, then stops. Start recording. Note that “ESPACE VIERGE” and the remaining time indication only refers to the length of the last blank space.

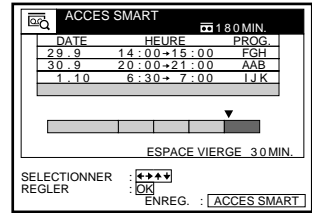

### Tips

- You can store information for up to 24 programmes on a single list.
- While recording, you can display the ACCES SMART screen using the ACCES SMART button. If you decide to stop recording, press MENU to make the ACCES SMART screen disappear first. Then press ■ STOP.
- You can have the player recall the data of the last cassette used to record programmes even after you eject the tape (see page 77).

### Notes

- You cannot use this function unless the clock is set.
- Depending on the tape, the total or remaining time may not appear correctly.
- If many short programmes are recorded on a tape, multiple programmes may be included in a single block. In this case, only the latest programme information will appear in the ACCES SMART screen.
- Blank time is measured from the end of the last recorded programme to the end of the tape. However, if you eject the tape and then make a new recording on the same tape, the original recorded programme(s) is displayed as a blank space.
- The station name\* may not appear if the VCR does not receive station name information signals.
- If you start recording a programme “D” from the middle of a previously recorded programme “A” and into another previously recorded programme “B,” the Acces Smart information for the second programme “B,” which is recorded over, is deleted.

#### Originally recorded programmes

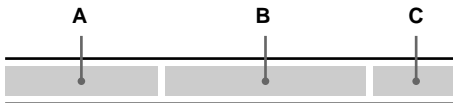

#### Recording the programme “D” over the programme “A” and “B”

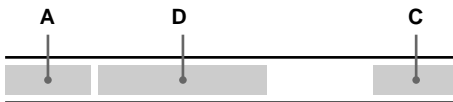

\* not available on SLV-SE610B

# Storing, searching and deleting programme information (Acces Smart Plus)

You can store programme information, such as the recording date and time, and programme position, for a maximum of four tapes. You can select a programme and start playback, by recalling the information directly from the Acces Smart Plus screen.

## Storing the programme information

You can store programme information for a maximum of four tapes. Before recording a programme, select a memory bank number from the list on the ACCES SMART screen.

The unit will not memorize the memory bank number for each cassette. Note the number you assigned to each cassette.

### Before you start...

- Turn on your TV and set it to the video channel.
- Refer to "Index to parts and controls" for button locations.

**1** Insert a cassette for recording.

The VCR automatically turns on.

**2** Press ACCES SMART.

The ACCES SMART -RAPPEL-screen appears.

RAPPEL is highlighted and the data for the last cassette used to record programmes appears.

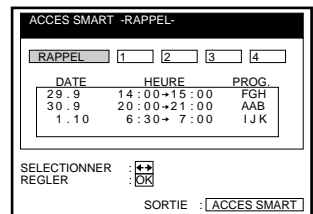

**3** Press ←/→ to select a memory bank number.

Note the memory bank number on the cassette.

To cancel the process, Press ACCES SMART.

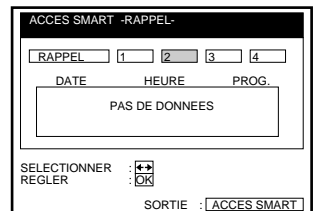

**4** Press OK.

**5** Start recording.

The information about the recorded programme will be stored on the selected memory number.

## To assign a memory number after recording

After recording a programme, you can store the programme information as a new memory before ejecting the cassette. However, you can not add the memory on the existed memory bank number. To store the memory as additional, select the memory bank number before.

**1** Press I/⏻ to turn on the VCR.

**2** Press ACCES SMART.

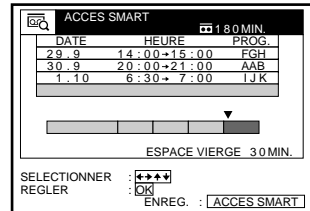

**3** Press ACCES SMART again.

The ACCES SMART -ENREG.- screen appears.

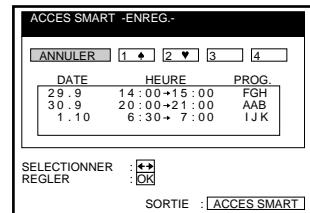

**4** Press ←/→ to select a memory bank number.

Select the memory bank number with no information or the memory bank number to be deleted.

To cancel the process, select ANNULER.

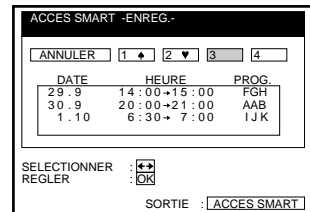

**5** Press OK.

## To exit the ACCES SMART screen

Press ACCES SMART.

### Note

- If you select a number that is already contains programmes, the old programme information is cleared and the new programme information is stored.

## Searching for programme information stored on the memory bank number

You can start playback of the recorded programme after calling the programme information from the four memory bank numbers.

*continued*

## Before you start...

- Turn on your TV and set it to the video channel.

- 1 Insert the cassette for which you want to use the memory bank number.  
The VCR automatically turns on.
- 2 Press ACCES SMART.  
The ACCES SMART -RAPPEL- screen appears.

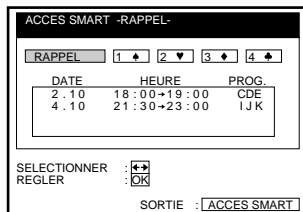

- 3 Press ←/→ to select the memory bank number for the inserted cassette.

The programme information contained in the selected memory bank number appears.

When you selected wrong memory bank number, eject the cassette and repeat steps from step 1.

- 4 Press OK.

The selected memory bank number appears on the ACCES SMART screen.

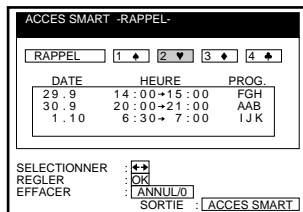

memory bank number

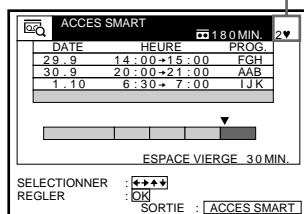

- 5 Press ↑/↓/←/→ to select the programme you want to start viewing.

- 6 Press OK.

The VCR starts searching, and playback starts automatically from the beginning of the selected programme.

### To stop searching

Press ■ STOP.

### To exit the ACCES SMART screen

Press ACCES SMART.

## Recalling the most recent programme information

Programme information that is not saved in one of the memory bank numbers is erased when the cassette is ejected. The RAPPEL memory bank will temporarily memorize the programme information of the last tape used for recording in case that it is accidentally ejected.

If you re-insert the cassette in Step 1 that you accidentally ejected and then select RAPPEL in Step 3, the data for the last tape used to record programmes appears. Press OK and the latest information will appear on the ACCES SMART screen. You can then add new information to this programme list. For an explanation about viewing programme information without using one of the memory banks, see page 72.

If you want to erase the latest information in the RAPPEL memory bank, press the ACCES SMART button instead of the OK button in Step 3 and then close the ACCES SMART screen. The new information will replace all of the current information in the RAPPEL memory bank.

### Note

- When you insert the cassette whose information does not exist on the memory bank number, you can not search the recorded programme.

## Deleting the programme information

You can delete the programme information stored in a memory number.

### Before you start...

- Turn on your TV and the VCR.
- Set the TV to the video channel.

### 1 Press ACCES SMART.

The ACCES SMART -RAPPEL- screen appears.

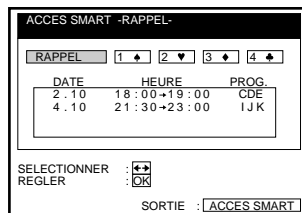

### 2 Press ←/→ to select the memory bank number to delete.

The programme information on the selected memory bank number appears. Check the information that you want to delete.

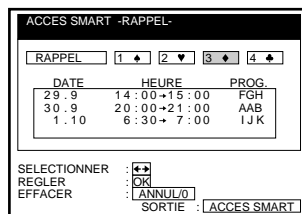

*continued*

- 3** Press ANNUL/0.  
The programme information is deleted.

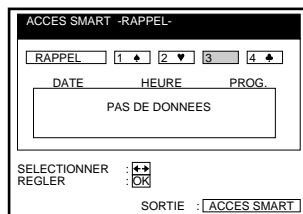

- 4** Press ACCES SMART.  
The ACCES SMART screen disappears.

#### Note

- You can not use or return the deleted information.

## About the Demonstration Mode

The Acces Smart Plus function has a Demonstration Mode that allows the user, such as a salesperson, to automatically display the Acces Smart Plus screens.

### To activate the Demonstration Mode

While the VCR is turned on, press and hold the both ■ (stop) and ≡ (eject) buttons on the VCR for a few seconds. The demonstration will start and the four kinds of Acces Smart Plus screens will be displayed repeatedly. If you operate the VCR, the Demonstration Mode temporarily stops. After about five minutes, the demonstration will restart.

### To cancel the Demonstration Mode

While the VCR is turned off, press and hold the both ■ (stop) and ≡ (eject) buttons on the VCR for a few seconds. You can also cancel the Demonstration Mode if you turn the power off and unplug the mains lead.

# Searching using the index function

The VCR automatically marks the tape with an index signal at the point where each recording begins. Use these signals as references to find a specific recording.

- 1 Insert an indexed tape into the VCR.
- 2 Press **⏮/⏭** RECHER INDEX.
  - To search ahead, press **⏭** RECHER INDEX.
  - To search backwards, press **⏮** RECHER INDEX.

The VCR starts searching, and playback starts automatically from that point.



## To stop searching

Press **■** STOP.

## Notes

- No index signal will be added when recording starts from recording pause. However, an index signal will be marked if you change the programme position during recording pause.
- When you press **⏮** RECHER INDEX, if there is nothing recorded before the selected index signal, playback may not start exactly at the index signal.

# Adjusting the picture

## Adjusting the tracking

Although the VCR automatically adjusts the tracking when playing a tape (the  indicator flashes in the display window, then turns off), distortion may occur if the recording is in poor condition. In this case, manually adjust the tracking.

During playback, press CHAINE +/- on the VCR to display the tracking meter. The distortion should disappear as you press one of the two buttons (the  indicator lights up).

To resume automatic tracking adjustments, eject the tape and re-insert it.

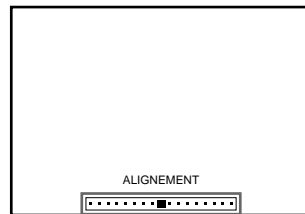



Tracking meter

## About the Reality Regenerator (Reality Regenerator) function

The Reality Regenerator function automatically restores the picture to its original quality during playback.

### To use the Reality Regenerator (RR) function

- 1 Press MENU, then select OPTIONS and press OK.
- 2 Press  to highlight OPTIONS-2 then press OK.
- 3 Press  to highlight RR, then press OK.

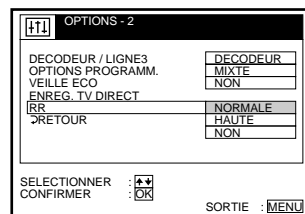

- 4 Press  to set RR to NORMALE or HAUTE, then press OK.  
The RR indicator lights up in the display window.
- 5 Press MENU to return to the original screen.

To turn it off, select NON in step 3. The RR indicator turns off in the display window.



## About the Optimum Picture Control (OPC) function

The Optimum Picture Control (OPC) function automatically improves recording and playback quality by adjusting the VCR to the condition of the video heads and tape. To maintain better picture quality, we recommend that you set OPC to OUI in the OPTIONS-1 menu (the OPC indicator lights up in the display window). For details, see page 83.

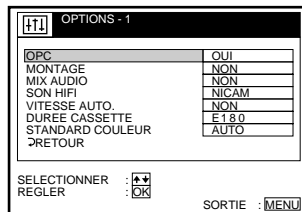

### OPC playback

The OPC function automatically works on all types of tapes, including rental tapes and tapes that were not recorded with OPC.

### OPC recording

Whenever you insert a tape and start recording for the first time, the VCR adjusts to the tape using the OPC function (the OPC indicator flashes rapidly). This adjustment is retained until the tape is ejected.

### To deactivate the OPC function

Set OPC to NON in the OPTIONS-1 menu. The OPC indicator in the display window turns off.

#### Tip

- To set tracking to the centre position, press the CHAINE + and – buttons on the VCR at the same time.

#### Notes

- You can adjust the tracking for an NTSC-recorded tape but the tracking meter won't be displayed.
- With the Auto Long Play function on, the OPC function will work only in SP mode. If the tape speed automatically switches from SP to LP, the OPC function turns off. If, however, the entire programme is recorded in LP mode, the OPC function will work.
- There is a delay of about ten seconds before the VCR actually starts recording while the VCR analyses the tape. To avoid the delay, first set the VCR to recording pause (the OPC indicator flashes slowly) and press ● ENR to have the VCR analyse the tape (the OPC indicator flashes rapidly) and return to recording pause. After the OPC indicator stops flashing, press ■ PAUSE to start recording immediately.

If you want to start recording quickly without using the OPC function, first set the VCR to recording pause (the OPC indicator flashes slowly) and press ■ PAUSE again to start recording.

# Reducing the VCR's power consumption

You can turn off the indicators in the display window when the VCR is off (standby mode) to reduce the VCR's power consumption.

- 1 Press MENU, then select OPTIONS, then press OK.
- 2 Press **↑/↓** to highlight OPTIONS-2, then press OK.
- 3 Press **↑/↓** to select VEILLE ECO, then press OK.

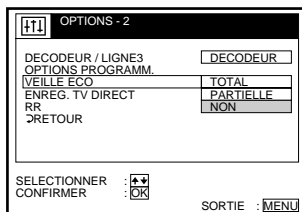

- 4 Press **↑/↓** to highlight TOTAL or PARTIELLE, then press OK.
  - TOTAL to reduce the power consumption to a minimum
  - PARTIELLE to reduce the power consumption
- 5 Press MENU to return to the original screen.

## To turn on the indicators in the display window

Set VEILLE ECO to NON in step 4.

### Notes

- When the VCR stands by for recording, the indicators in the display window remain lit even when VEILLE ECO is set to TOTAL or PARTIELLE.
- If VEILLE ECO is TOTAL, you cannot watch or record programmes from your Canal Plus decoder, satellite, or digital tuner during standby mode (page 85).

# Changing menu options

- 1 Press MENU, then select OPTIONS and press OK.

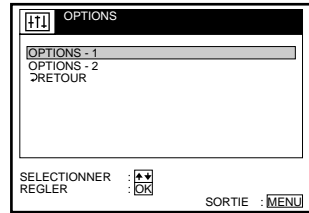

- 2 Press  $\uparrow/\downarrow$  to highlight OPTIONS-1 or OPTIONS-2, then press OK.

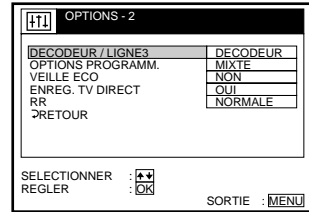
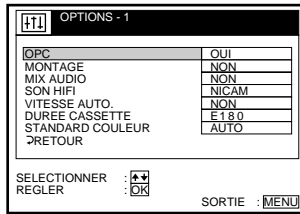

- 3 Press  $\uparrow/\downarrow$  to select the option, then press OK.

- 4 Press  $\uparrow/\downarrow$  to change the setting, then press OK.

- 5 Press MENU to return to the original screen.

## Menu choices

Initial settings are indicated in bold print.

### OPTIONS-1

Menu option	Set this option to
OPC	<ul style="list-style-type: none"> <li>• <b>OUI</b> to switch on the OPC (Optimum Picture Control) function and improve picture quality.</li> <li>• <b>NON</b> to switch off OPC.</li> </ul>
MONTAGE	<ul style="list-style-type: none"> <li>• OUI to minimize picture deterioration when editing.</li> <li>• <b>NON</b> to turn off MONTAGE.</li> </ul>
MIX AUDIO	<ul style="list-style-type: none"> <li>• OUI to listen to the hi-fi and normal audio tracks at the same time. The CHOIX SON button will not function.</li> <li>• <b>NON</b> to listen to the hi-fi and normal audio tracks separately. Select the sound using the CHOIX SON button.</li> </ul> <p>If you press <math>\blacktriangle</math> EJECT, MIX AUDIO will be reset to NON. For details, see page 71.</p>

*continued*

Menu option	Set this option to
SON HIFI	<ul style="list-style-type: none"> <li>• <b>NICAM</b> to record NICAM broadcasts on the hi-fi audio track.</li> <li>• <b>STANDARD</b> to record standard sound on the hi-fi audio track.</li> </ul> <p>For details, see page 70.</p>
VITESSE AUTO.	<ul style="list-style-type: none"> <li>• <b>OUI</b> to change the timer recording tape speed automatically to the LP mode when the remaining tape length becomes shorter than the recording time. Note that for VITESSE AUTO. to work correctly, the DUREE CASSETTE setting must be accurate.</li> <li>• <b>NON</b> to keep the set tape speed.</li> </ul>
DUREE CASSETTE	<ul style="list-style-type: none"> <li>• <b>E180</b> to use an E-180 or shorter type tape.</li> <li>• <b>E195</b> to use an E-195 type tape.</li> <li>• <b>E240</b> to use an E-240 type tape.</li> <li>• <b>E300</b> to use an E-300 type tape.</li> </ul>
STANDARD COULEUR	<ul style="list-style-type: none"> <li>• <b>AUTO</b> to set the colour system automatically.</li> <li>• <b>PAL</b> to play back a tape recorded in the PAL colour system.</li> <li>• <b>SECAM</b> to play back a tape recorded in the SECAM colour system.</li> <li>• <b>MESECAM</b> to play back a tape recorded in the MESECAM colour system.</li> </ul> <p>If you press ▲ EJECT or turn the VCR off, STANDARD COULEUR will be reset to AUTO. For details, see page 44.</p>

## OPTIONS-2

Menu option	Set this option to
DECODEUR/ LIGNE2* <sup>1</sup>	<ul style="list-style-type: none"> <li>• <b>DECODEUR</b> to use the DECODEUR/ENTREE LIGNE-2*<sup>1</sup> connector as the Canal Plus decoder connector.</li> <li>• <b>LIGNE2</b> to use the DECODEUR/ENTREE LIGNE-2*<sup>1</sup> connector as the line input connector.</li> </ul>
DECODEUR/ LIGNE3* <sup>2</sup>	<ul style="list-style-type: none"> <li>• <b>DECODEUR</b> to use the DECODEUR/ENTREE LIGNE-3*<sup>2</sup> connector as the Canal Plus decoder connector.</li> <li>• <b>LIGNE3</b> to use the DECODEUR/ENTREE LIGNE-3*<sup>2</sup> connector as the line input connector.</li> </ul>
OPTIONS PROGRAMM.* <sup>3</sup>	<ul style="list-style-type: none"> <li>• <b>MIXTE</b> to display the METHODO DE PROGRAMMATION menu for selecting NORMALE or SHOWVIEW when pressing the ⊖ MINUTERIE button.</li> <li>• <b>NORMALE</b> to display the MINUTERIE menu when pressing the ⊖ MINUTERIE button.</li> <li>• <b>SHOWVIEW</b> to display the SHOWVIEW menu when pressing the ⊖ MINUTERIE button.</li> </ul> <p>For details, see page 55 and 59.</p>

Menu option	Set this option to
VEILLE ECO	<ul style="list-style-type: none"> <li>• <b>TOTAL</b> to turn off the indicators in the display window during standby mode to reduce the VCR's power consumption to a minimum. For using the Line Through function (page 18) or the decoder (page 39), select <b>PARTIELLE</b> or <b>NON</b>.</li> <li>• <b>PARTIELLE</b> to turn off the indicators in the display window to conserve the VCR's power.</li> <li>• <b>NON</b> to turn on the indicators in the display window while the VCR is standing by.</li> </ul>
ENREG. TV DIRECT*3	<ul style="list-style-type: none"> <li>• <b>OUI</b> to activate the TV Direct Rec function.</li> <li>• <b>NON</b> to deactivate it.</li> </ul>
RR	<ul style="list-style-type: none"> <li>• <b>NORMALE</b> for normal everyday use.</li> <li>• <b>HAUTE</b> for well-used video tapes such as rented tapes. Select this option when <b>NORMALE</b> does not improve the picture quality.</li> <li>• <b>NON</b> to switch off the RR function.</li> </ul>

### Notes

- When the VCR stands by for recording, the indicators in the display window remain lit, even when **VEILLE ECO** is set to **TOTAL**, or **PARTIELLE**.
- With the **MONTAGE** option **OUI**, the **OPC** function does not work.

\*1 SLV-SE610B, SE710B, and SX710B only

\*2 SLV-SE810B only

\*3 not available on SLV-SE610B

# Connecting to a VCR or stereo system

## How to connect to record on this VCR

Connect the line outputs of the other VCR to the ENTREE LIGNE connector or jacks of this VCR. Refer to the examples A through C and choose the connection that best suits your VCR.

### Example A

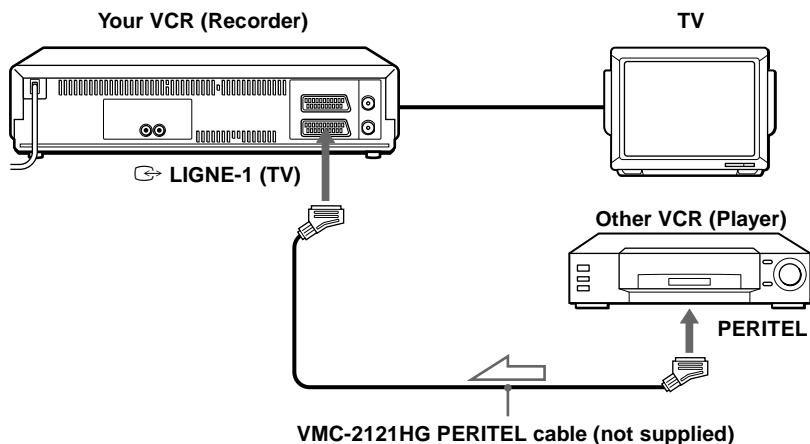

: Signal flow

### Example B

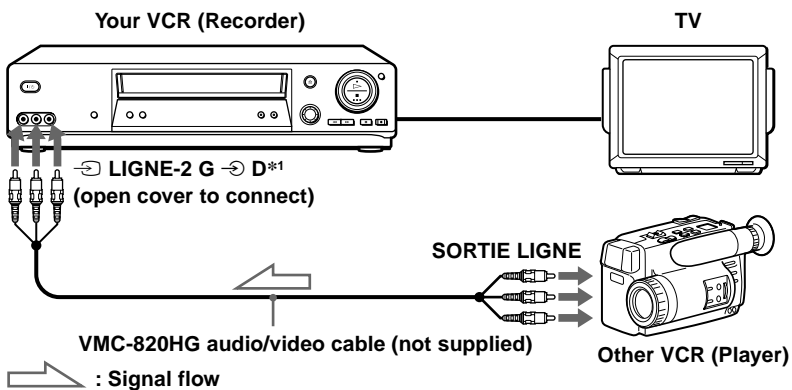

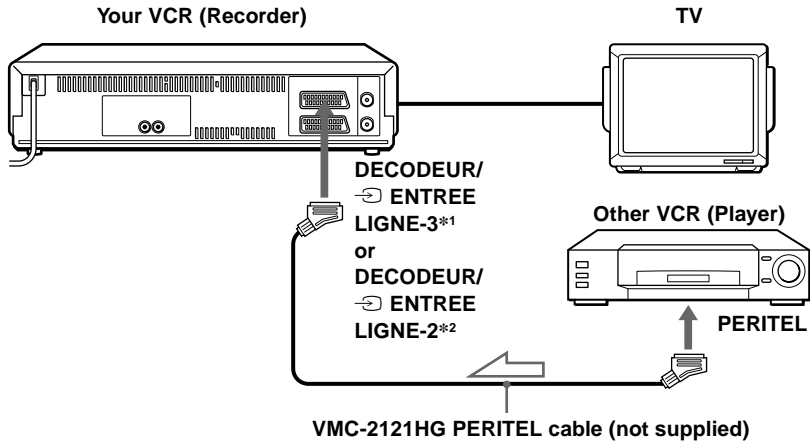

: Signal flow

## Example C



 : Signal flow

## How to connect to a stereo system (SLV-SE810B only)

Connect the  LIGNE-2 G  D jacks on this VCR to the audio output jacks on the stereo system, using the RK-C510HG audio cable. (not supplied).

### Notes

- Make sure you connect the plugs to jacks of the same colour.\*1
- If the other VCR is a monaural type, leave the red plugs unconnected.
- If you connect this VCR to both the ENTREE LIGNE and SORTIE LIGNE jacks of the other VCR, select the input correctly to prevent a humming noise.
- If the other VCR does not have a PERITEL connector, use the VMC-2106HG cable instead and connect the cable to the line out jacks of the other VCR.
- When you connect another VCR to the DECODEUR/ENTREE LIGNE-3 \*1 (or DECODEUR/ENTREE LIGNE-2\*2) connector, set DECODEUR/LIGNE3\*1 (or DECODEUR/LIGNE2\*2) to LIGNE3\*1 (or LIGNE2\*2) in the OPTIONS-2 menu.

\*1 SLV-SE810B only

\*2 SLV-SE610B, SE710B, and SX710B only

# Basic editing

## when recording on this VCR

### Before you start editing

- Turn on your TV and set it to the video channel.
- Press CHOIX ENTREE to display the connected line in the display window.
- Press SP/LP to select the tape speed, SP or LP.
- On this VCR, set MONTAGE to OUI in the OPTIONS-1 menu. If the other VCR has a similar function, turn it on as well.

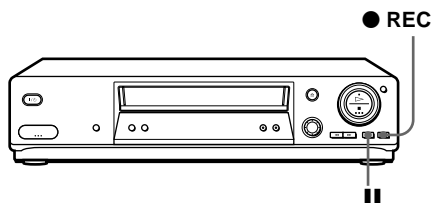

- 1** Insert a source tape with its safety tab removed into the other (playback) VCR. Search for the point to start playback and set it to playback pause.
- 2** Insert a tape with its safety tab in place into this (recording) VCR. Search for the point to start recording and press **||** (pause).
- 3** Press **● REC** on this VCR to set it to recording pause.
- 4** To start editing, press the **||** (pause) buttons on both VCRs at the same time.

### To stop editing

Press the **■ STOP** buttons on both VCRs.

### Tip

- To cut out unwanted scenes while editing, press **||** (pause) on this VCR when an unwanted scene begins. When it ends, press **||** (pause) again to resume recording.

### Note

- If you start editing following the procedure above, the VCR won't start recording with the OPC function. To record a tape with the OPC function, press **● REC** again during recording pause in step 3 so the VCR analyses the tape. Then, press **||** (pause) after the OPC indicator stops flashing to start recording. If you press **||** (pause) before the OPC indicator stops flashing, the OPC function is cancelled.



## Audio dubbing (SLV-SE810B only)

This feature lets you record over the normal audio track. The monaural sound previously recorded is replaced while the original hi-fi sound remains unchanged. Use this feature to add commentary to a tape that you have recorded with a camcorder.

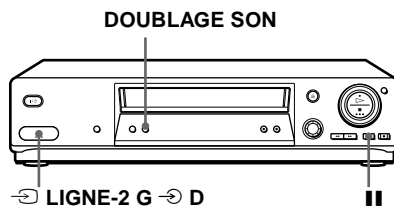

### Before you start...

- Open the  $\rightarrow$  LIGNE-2 G  $\rightarrow$  D jacks cover on the front panel and connect a playback source
- Turn on the TV and set it to the video channel.

- 1** Insert a source tape into your stereo system (or the playback VCR). Search for the point to start playback and set it to playback pause.
- 2** Insert a prerecorded tape with its safety tab in place into this (recording) VCR. Search for the start of the section to be replaced and press **||** (pause).  
The VCR enters pause mode.
- 3** Press DOUBLAGE SON.  
The programme position changes to “L2,” and the  $\ominus$  indicator appears in the display window.
- 4** To start editing, press the **||** (pause) buttons on this VCR and the stereo system (or other VCR) at the same time.  
After you use this feature, the audio in playback mode is automatically set to monaural.

### To stop editing

Press **■** (stop) on this VCR and the stereo system (or other VCR).

### To listen to both the hi-fi and normal audio

Set MIX AUDIO to OUI in the OPTIONS-1 menu (page 83). Use this feature to listen to dubbed audio over the original hi-fi audio. When MIX AUDIO is set to OUI, the CHOIX SON button does not function.

Remember to reset MIX AUDIO to NON after playing the tape.

### Note

- If you eject the tape or turn the VCR off, MIX AUDIO is automatically set to NON.

# Troubleshooting

If you have any questions or problems not covered below, please consult your nearest Sony service facility.

	Symptom	Remedy
Power	The I/☺ MARCHE/VEILLE switch does not function.	<ul style="list-style-type: none"> <li>Connect the mains lead to the mains securely.</li> </ul>
	The power is turned on but the VCR does not operate.	<ul style="list-style-type: none"> <li>Moisture condensation has occurred. Turn the power off, unplug the mains lead and leave the VCR to dry for over three hours.</li> </ul>
	The VCR is plugged in but the display window remains dark.	<ul style="list-style-type: none"> <li>Set VEILLE ECO in the OPTIONS-2 menu to NON (see page 85).</li> </ul>
Clock	The clock has stopped and “-:-” appears in the display window.	<ul style="list-style-type: none"> <li>The clock stops if the VCR is disconnected from the mains for more than one hour. Reset the clock (and timer).</li> </ul>
Playback	The playback picture does not appear on the TV screen.	<ul style="list-style-type: none"> <li>Make sure the TV is set to the video channel. If you are using a monitor, set it to video input.</li> <li>If the VCR is connected to the TV with the PERITEL cable, make sure the MAGN indicator is lit in the display window. Use the ☺ TV/MAGN button on the remote commander to light up the MAGN indicator.</li> </ul>
	The picture is not clear.	<ul style="list-style-type: none"> <li>If your TV is connected to the VCR with both PERITEL and aerial cables, make sure the RF channel is set to OFF (see page 21).</li> <li>Existing broadcasts may interfere with the VCR. Reset the RF channel output of your VCR.</li> <li>Adjust the tracking with the CHAINE +/- buttons <u>on the VCR</u>.</li> <li>The video heads are dirty (see the last page of Troubleshooting). Clean the video heads using the Sony T-25CLD, E-25CLDR, or T-25CLW video head cleaning cassette. If these cleaning cassettes are not available in your area, have the heads cleaned at your nearest Sony service facility (a standard service charge will be required). Do not use a commercially available liquid type cleaning cassette other than Sony's, as it may damage the video heads.</li> <li>The video heads may have to be replaced. Consult your local Sony service facility for more information.</li> </ul>
	The picture rolls vertically during picture search.	<ul style="list-style-type: none"> <li>Adjust the vertical hold control on the TV or monitor.</li> </ul>

	Symptom	Remedy
Playback	The picture has no sound.	<ul style="list-style-type: none"> <li>The tape is defective.</li> <li>If you made A/V connections, check the audio cable connection.</li> </ul>
	The sound is unstable or has an echo.	<ul style="list-style-type: none"> <li>When you play a tape with the same sound recorded on both the hi-fi and normal audio tracks, make sure MIX AUDIO in the OPTIONS-1 menu is set to NON.</li> </ul>
	The sound from a tape recorded with the VCR is not in stereo or the STEREO indicator in the display window is flashing.	<ul style="list-style-type: none"> <li>Adjust the tracking.</li> <li>The video heads are dirty. Clean the video heads using the Sony T-25CLD, E-25CLDR, or T-25CLW video head cleaning cassette as explained above.</li> </ul>
Recording	No TV programme appears on the TV screen.	<ul style="list-style-type: none"> <li>Make sure the TV is set to the video channel. If you are using a monitor, set it to video input.</li> <li>If your TV is connected to the VCR with both PERITEL and aerial cables, make sure the RF channel is set to OFF (see page 21).</li> <li>Existing broadcasts may interfere with the VCR. Reset the RF channel output of your VCR.</li> <li>Select the correct source with the CHOIX ENTREE button. Select a programme position when recording TV programmes; select a line input when recording from other equipment.</li> </ul>
	TV reception is poor.	<ul style="list-style-type: none"> <li>Make sure the aerial cable is connected securely.</li> <li>Adjust the TV aerial.</li> <li>Make sure NORME (L or B/G) in the REGLAGE DES CHAINES menu is set to the same system used in your local area.</li> </ul>
	The tape starts playing as soon as it is inserted.	<ul style="list-style-type: none"> <li>The safety tab has been removed. To record on this tape, cover the tab hole (see page 47).</li> </ul>
	The tape is ejected when you press ● ENR.	<ul style="list-style-type: none"> <li>The safety tab has been removed. To record on this tape, cover the tab hole (see page 47).</li> </ul>
	Nothing happens when you press ● ENR.	<ul style="list-style-type: none"> <li>Make sure the tape is not at its end.</li> </ul>

continued

	Symptom	Remedy
Timer recording	The timer does not operate.	<ul style="list-style-type: none"> <li>• Check that the clock is set.</li> <li>• Make sure a tape has been inserted.</li> <li>• Check that the safety tab has not been removed.</li> <li>• Make sure the tape is not at its end.</li> <li>• Make sure a programme has been set for timer recording.</li> <li>• Make sure your timer settings are past the current time.</li> <li>• Check that the decoder is turned on.</li> <li>• Check that the satellite tuner is turned on.</li> <li>• The clock stops if the VCR is disconnected from the mains for more than one hour. Reset the clock and timer.</li> <li>• Turn the power off and unplug the mains lead.</li> </ul>
	The SHOWVIEW menu or the MINUTERIE menu does not appear.	<ul style="list-style-type: none"> <li>• Check that OPTIONS PROGRAMM. in the OPTIONS-2 menu is set correctly (see page 84).</li> </ul>
	The VPS/PDC function does not operate properly.	<ul style="list-style-type: none"> <li>• Check that the clock and the date are set correctly.</li> <li>• Check that the VPS/PDC time you set is the correct one (there might be a mistake in the TV programme guide). If the broadcast you wanted to record did not send the good VPS/PDC information, the VCR will not start recording.</li> <li>• If the reception is poor, the VPS/PDC signal might be altered and the VCR might not start recording.</li> </ul>
Synchronized Recording	The ENR SYNCHRO button turns off while recording or does not go back to recording standby mode.	<ul style="list-style-type: none"> <li>• The tape has reached its end. Insert a new tape and press ENR SYNCHRO again.</li> </ul>
	The Synchronized Recording function does not work.	<ul style="list-style-type: none"> <li>• The connected equipment was not turned off. Turn off the connected equipment and press ENR SYNCHRO again.</li> <li>• There was a power failure. Press ENR SYNCHRO again.</li> </ul>
	The programme recorded with the Synchronized Recording function is incomplete.	<ul style="list-style-type: none"> <li>• If the settings for timer recordings and Synchronized Recording overlap, the programme that starts first has priority and the second programme starts recording only after the first programme has finished.</li> <li>• There was a power failure. Press ENR SYNCHRO again.</li> </ul>
Canal Plus	You cannot set the channel as the Canal Plus in the REGLAGE DES CHAINES menu.	<ul style="list-style-type: none"> <li>• Check that DECODEUR/LIGNE3 (or DECODEUR/LIGNE2) in the OPTIONS-2 menu is set to DECODEUR (see page 84).</li> </ul>

	Symptom	Remedy
Canal Plus	You cannot watch the Canal Plus programme when the VCR is in standby mode.	<ul style="list-style-type: none"> <li>• Check that DECODEUR/LIGNE3 (or DECODEUR/LIGNE2) in the OPTIONS-2 menu is set to DEOCEUR (see page 84).</li> <li>• Make sure the Canal Plus Scart cable is plugged securely.</li> <li>• Check that VEILLE ECO in the OPTIONS-2 menu is set to PARTIELLE or NON (see page 85).</li> </ul>
	The Canal Plus programme is always recorded scrambled.	<ul style="list-style-type: none"> <li>• Make sure the Canal Plus Scart cable is plugged securely.</li> <li>• Check that DECODEUR/LIGNE3 (or DECODEUR/LIGNE2) in the OPTIONS-2 menu is set to DECODEUR (see page 84).</li> <li>• Check that this channel is set as Canal Plus in the REGLAGE DES CHAINES menu (see page 39).</li> </ul>
Others	A tape cannot be inserted.	<ul style="list-style-type: none"> <li>• Check that a tape isn't already in the tape compartment.</li> </ul>
	The remote commander does not function.	<ul style="list-style-type: none"> <li>• Make sure you are pointing the remote commander at the remote sensor on the VCR.</li> <li>• Replace all the batteries in the remote commander with new ones if they are weak.</li> <li>• Make sure the [TV] / [MAGN] remote control switch is set correctly.</li> </ul>
	The selected input line connector number does not appear in the display window.	<ul style="list-style-type: none"> <li>• Check that DECODEUR/LIGNE3 (or DECODEUR/LIGNE2) in the OPTIONS-2 menu is set to LIGNE3 (or LIGNE2) (see page 84).</li> </ul>
	The SMARTLINK function does not work.	<ul style="list-style-type: none"> <li>• Check that your TV complies with SMARTLINK, MEGALOGIC, EASYLINK, Q-Link, EURO VIEW LINK, or T-V LINK.</li> <li>• Make sure you use the PERITEL cable to connect the VCR and your TV.</li> <li>• Make sure the PERITEL cable is connected securely.</li> </ul>
	The tracking meter does not appear on the TV screen.	<ul style="list-style-type: none"> <li>• The recording condition of the tape is very poor and tracking cannot be adjusted.</li> <li>• The tracking meter does not appear when playing back an NTSC-recorded tape.</li> </ul>
	You cannot control other TVs.	<ul style="list-style-type: none"> <li>• Set your TV's code number. The code number may change when you replace the batteries of the remote commander.</li> </ul>
	The display window becomes dim.	<ul style="list-style-type: none"> <li>• The display window automatically becomes dim when the VCR is in standby or timer recording mode.</li> </ul>
	The VCR needs to be cleaned.	<ul style="list-style-type: none"> <li>• Clean the cabinet, panel and controls with a dry, soft cloth, or a soft cloth slightly moistened with a mild detergent solution. Do not use any type of solvent, such as alcohol or benzene.</li> </ul>

continued

## Symptoms caused by contaminated video heads

• Normal picture



• Rough picture



initial  
contamination

• Unclear picture



• No picture (or  
black & white  
screen appears)



terminal



# Specifications

## System

Channel coverage

SECAM (L):

VHF F2 to F10

UHF F21 to F69

CATV B to Q

HYPER S21 to S41

PAL (B/G):

VHF E2 to E12

VHF Italian channel A to H

UHF E21 to E69

CATV S01 to S05, S1 to S20

HYPER S21 to S41

RF output signal

UHF channels 21 to 69

Aerial out

75-ohm asymmetrical aerial socket

Tape speed

SP: PAL 23.39 mm/s (recording/  
playback)

NTSC 33.35 mm/s (playback  
only)

SECAM 23.39 mm/s (recording/  
playback)

MESECAM  
23.39 mm/s (playback only)

LP: PAL 11.70 mm/s (recording/  
playback)

NTSC 16.67 mm/s (playback  
only)

SECAM 11.70 mm/s (recording/  
playback)

MESECAM  
1.70 mm/s (playback only)

EP: NTSC 11.12 mm/s (playback  
only)

Maximum recording/playback time

10 hrs. in LP mode (with E300 tape)

Fast-forward and rewind time

Approx. 1 min. (with E180 tape)

## Inputs and outputs

↻ LIGNE-1 (TV)

21-pin

Video input: pin 20

Audio input: pins 2 and 6

Video output: pin 19

Audio output: pins 1 and 3

DECODEUR/↻ ENTREE LIGNE-2  
(SLV-SE610B, SE710B, SX710B)

21-pin

Video input: pin 20

Audio input: pins 2 and 6

DECODEUR/↻ ENTREE LIGNE-3  
(SLV-SE810B)

21-pin

Video input: pin 20

Audio input: pins 2 and 6

↻ LIGNE-2 G ↻ D (SLV-SE810B)

ENTREE VIDEO, phono jack (1)

Input signal: 1 Vp-p, 75 ohms,  
unbalanced, sync negative

ENTREE AUDIO, phono jack (2)

Input level: 327 mVrms

Input impedance: more than 47 kilohms

↻ R/D L/G (SLV-SE710B, SX710B,  
SE810B)

Phono jack (2)

Rated output level: 327 mVrms

Load impedance: 47 kilohms

Output impedance: less than 10 kilohms

## General

Power requirements

220 – 240 V AC, 50 Hz

Power consumption

20 W

1.2 W (VEILLE ECO is set to TOTAL,  
minimum)

Operating temperature

5°C to 40°C

*continued*

Storage temperature

–20°C to 60°C

Dimensions including projecting parts and controls

Approx. 430 × 98 × 283 mm (w/h/d)

(SLV-SE610B, SE710B, SX710B)

Approx. 430 × 98 × 289 mm (w/h/d)

(SLV-SE810B)

Mass

Approx. 4.1 kg

### **Supplied accessories**

Remote commander (1)

R6 (size AA) batteries (2)

Aerial cable (1)

Design and specifications are subject to change without notice.



# Index

## A

- Acces Smart 72
- Adjusting
  - picture 28, 80
  - tracking 80
- Aerial hookup 15
- AFT (Auto Fine Tuning) 28
- Audio dubbing 89
- Audio track 71
- Auto Clock Set 35
- Auto Long Play 84
- Auto Set Up 22

## C

- Canal Plus 39
- Changing the programme position 30
- Changing the station name 33
- Cleaning the video heads 90
- Clock setting 35
- Colour system
  - compatible colour systems 2
  - setting 44
- Connecting
  - the VCR and your TV 15, 16
  - to a satellite tuner 18
  - to a stereo system 18
  - to a TV with a PERITEL connector 16
- Counter 44

## D

- Demonstration 54, 78
- Dial Timer 50
- Disabling the programme positions 31
- Dubbing. *see* Editing

## E

- Editing 86
- EP mode 45

## H

- Hi-fi audio track 71

## I

- Index search 79

## L

- Language selecting 24
- LP mode 46

## M

- Monaural 70
- Monitoring
  - during playback 71
  - during recording 70

## N

- NICAM broadcasts 70
- Normal audio track 71

## O

- OPC (Optimum Picture Control) 81
- Optional setting 83

## P

- PDC (Programme Delivery Control) 57
- PERITEL connection 16
- Picture adjustment. *See* Adjusting
- Playback 44
  - at various speeds 63
  - frame-by-frame 63
  - selecting the sound 71
  - slow motion 63
- Power save 82, 85
- Presetting channels 25

## R

- Reality Regenerator 80
- Recording 46, 59
  - bilingual programmes 70
  - duration time 65
  - saving 47
  - stereo programmes 70
  - timer setting 59
  - using the Dial Timer 50
  - using the ShowView system 55
  - what you are watching on the TV 48
  - while watching another programme 47
- RF channel 19, 21

## S

- Safety tab 47
- Searching
  - at various speeds 63
  - using the Acces Smart function 72
  - using the index function 79
- Searching using the Acces Smart function 72
- ShowView
  - recording 55
- SMARTLINK
  - Automatic Power Off 17
  - One Touch Menu 17
  - One Touch Play 17, 45
  - One Touch Timer 17
  - Preset Download 17
  - TV Direct Rec 17, 48
- SP mode 46
- Stereo 70
- Synchronized Recording 66

## T

- Timer setting
  - cancelling 68
  - changing 68
  - checking 68
  - daily/weekly recording 57, 60
  - using the Dial Timer 50
  - using the ShowView system 55
- Tracking adjustment. *See* Adjusting

## V

- VPS (Video Programme System) 57

## Z

- ZWEITON broadcasts 70





# Quick Start Guide

## 1 Connecting the VCR

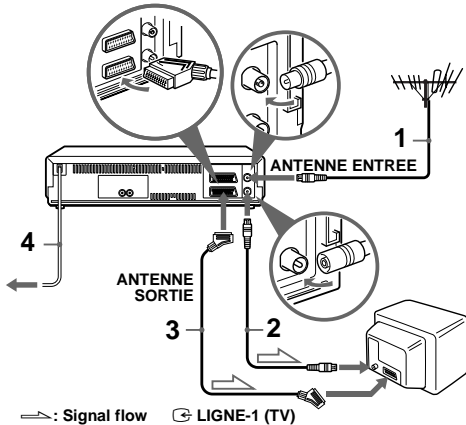

- 1 ... Connect the aerial to ANTENNE ENTREE of the VCR.
- 2 ... Connect ANTENNE SORTIE the aerial input of your TV using the supplied aerial cable.
- 3 ... For better picture and sound, connect LIGNE-1 (TV) to your TV using a PERITEL connector.
- 4 ... Connect the mains lead to the mains.

## 2 Tuning your TV to the VCR

I/⏻ REGL CANAL



CHAINE +/-

- A** If your TV does not have a PERITEL connector
- 1 ... Press I/⏻ (marche/veille) to turn on the VCR.
  - 2 ... Press REGL CANAL on the VCR lightly.

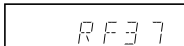

- 3 ... Turn on your TV and select a programme position for the VCR picture.

- 4 ... Press REGL CANAL.
- 5 ... Press CHAINE +/- to select the TV system ("G" for B/G, "L" for L).
- 6 ... Tune the TV to the same channel shown in the VCR display window so that MAGNETOSCOPE SONY appears clearly on the TV screen. Refer to your TV's instruction manual for tuning instructions.
- 7 ... Press REGL CANAL.

**B** If your TV has a PERITEL connector

- 1 ... Press I/⏻ (marche/veille) to turn on the VCR.
- 2 ... Press REGL CANAL on the VCR lightly.
- 3 ... Press CHAINE +/- to set the RF channel to OFF.



- 4 ... Press REGL CANAL.

## 3 Using the Auto Set Up function

REGLAGE AUTO



You can preset channels

Hold down REGLAGE AUTO for three seconds.

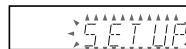

When all the receivable channels are preset, "SET UP" disappears from the display window. You can rearrange the programme position to your favourite order (see "Changing/disabling programme positions").

### Note

- The Auto Set Up function may require a long time to complete (approximately 15 to 18 minutes).

**Now you can operate your VCR.**

## Free Manuals Download Website

<http://myh66.com>

<http://usermanuals.us>

<http://www.somanuals.com>

<http://www.4manuals.cc>

<http://www.manual-lib.com>

<http://www.404manual.com>

<http://www.luxmanual.com>

<http://aubethermostatmanual.com>

Golf course search by state

<http://golfingnear.com>

Email search by domain

<http://emailbydomain.com>

Auto manuals search

<http://auto.somanuals.com>

TV manuals search

<http://tv.somanuals.com>