

# Video Cassette Recorder

---

Operating Instructions



Hi-Fi

**SHOWVIEW®**

**SLV-SF99EN**

## WARNING

To prevent fire or shock hazard, do not expose the unit to rain or moisture.

To avoid electrical shock, do not open the cabinet. Refer servicing to qualified personnel only.

Mains lead must only be changed at a qualified service shop.

## Precautions

### Safety

- This unit operates on 220 – 240 V AC, 50 Hz. Check that the unit's operating voltage is identical with your local power supply.
- If anything falls into the cabinet, unplug the unit and have it checked by qualified personnel before operating it any further.
- The unit is not disconnected from the mains as long as it is plugged in the wall outlet, even if the unit itself has been turned off.
- Unplug the unit from the wall outlet if you do not intend to use it for an extended period of time. To disconnect the cord, pull it out by the plug, never by the cord.

### Installing

- Allow adequate air circulation to prevent internal heat buildup.
- Do not place the unit on surfaces (rugs, blankets, etc.) or near materials (curtains, draperies) that may block the ventilation slots.
- Do not install the unit near heat sources such as radiators or air ducts, or in a place subject to direct sunlight, excessive dust, mechanical vibration or shock.
- Do not install the unit in an inclined position. It is designed to be operated in a horizontal position only.
- Keep the unit and cassettes away from equipment with strong magnets, such as microwave ovens or large loudspeakers.
- Do not place heavy objects on the unit.
- If the unit is brought directly from a cold to a warm location, moisture may condense inside the VCR and cause damage to the video head and tape. When you first install the unit, or when you move it from a cold to a warm location, wait for about three hours before operating the unit.

### Caution

Television programmes, films, video tapes and other materials may be copyrighted. Unauthorized recording of such material may be contrary to the provisions of the copyright laws. Also, use of this recorder with cable television transmission may require authorization from the cable television transmitter and/or programme owner.

### Compatible colour systems

This VCR is designed to record using the PAL (B/G or D/K) or MESECAM (B/G or D/K) colour system and play back using the PAL (B/G or D/K), MESECAM (B/G or D/K) and NTSC 4.43 colour systems. Recording of video sources based on other colour systems cannot be guaranteed.

# Table of contents

## Getting Started

- 4 Step 1: Unpacking
- 5 Step 2: Setting up the remote commander
- 11 Step 3: Connecting the VCR
- 17 Step 4: Tuning your TV to the VCR
- 19 Step 5: Setting up the VCR with the Auto Set Up function
- 21 Step 6: Setting the clock
- 26 Selecting a language
- 27 Presetting channels
- 31 Setting/changing the station names
- 33 Changing/disabling programme positions
- 37 Connecting the Satellite tuner
- 40 Setting the PAY-TV/Canal Plus decoder

## Basic Operations

- 45 Playing a tape
- 48 Recording TV programmes
- 52 Recording TV programmes using the ShowView system
- 57 Setting the timer manually

## Additional Operations

- 60 Playing/searching at various speeds
- 63 Setting the recording duration time
- 64 Checking/changing/cancelling timer settings
- 66 Recording stereo and bilingual programmes
- 68 Searching using the index function
- 69 Adjusting the picture
- 71 Changing menu options
- 74 Editing with another VCR or stereo system
- 76 Audio dubbing

## SmartFile function

- 78 About the SmartFile function
- 80 Recording using the SmartFile function
- 85 Selecting and playing a programme
- 86 Checking the contents of a tape
- 88 Labelling a recorded programme and tape
- 96 Registering the contents of a recorded tape in the SmartFile label
- 98 Protecting a recorded programme
- 100 Erasing the data of an unwanted programme

## Additional Information

- 102 Troubleshooting
- 108 Specifications
- 109 Index to parts and controls
- 114 Menu chart

## Back cover

Index

\* ShowView is a registered trademark of Gemstar Development Corporation. ShowView system is manufactured under license from Gemstar Development Corporation.

# Step 1

## Unpacking

Check that you have received the following items with the VCR:

- Remote commander
- EURO-AV cable

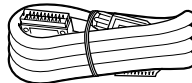
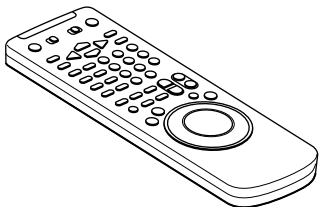

- R6 (size AA) batteries
- SmartFile labels

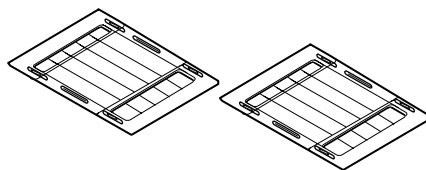
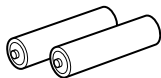

- Aerial cable

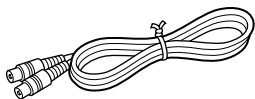

- Audio cable

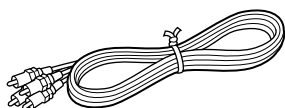

## Step 2

# Setting up the remote commander

### Inserting the batteries

Insert two R6 (size AA) batteries by matching the + and – on the batteries to the diagram inside the battery compartment.

Insert the negative (–) end first, then push in and down until the positive (+) end clicks into position.

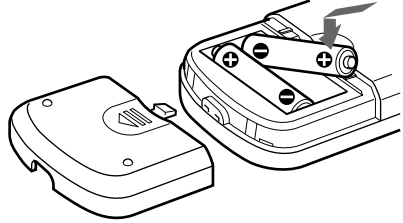

### Using the remote commander

You can use this remote commander to operate this VCR and a Sony TV. Buttons on the remote commander marked with a dot (•) can be used to operate your Sony TV. If the TV does not have the  symbol near the remote sensor, this remote commander will not operate the TV.

Remote sensor

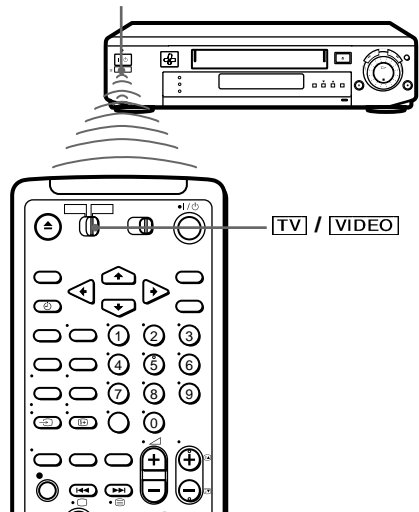

To operate	Set <b>TV</b> / <b>VIDEO</b> to
the VCR	<b>VIDEO</b> and point at the remote sensor on the VCR
a Sony TV	<b>TV</b> and point at the remote sensor on the TV

**continued**

Step 2 : Setting up the remote commander (continued)

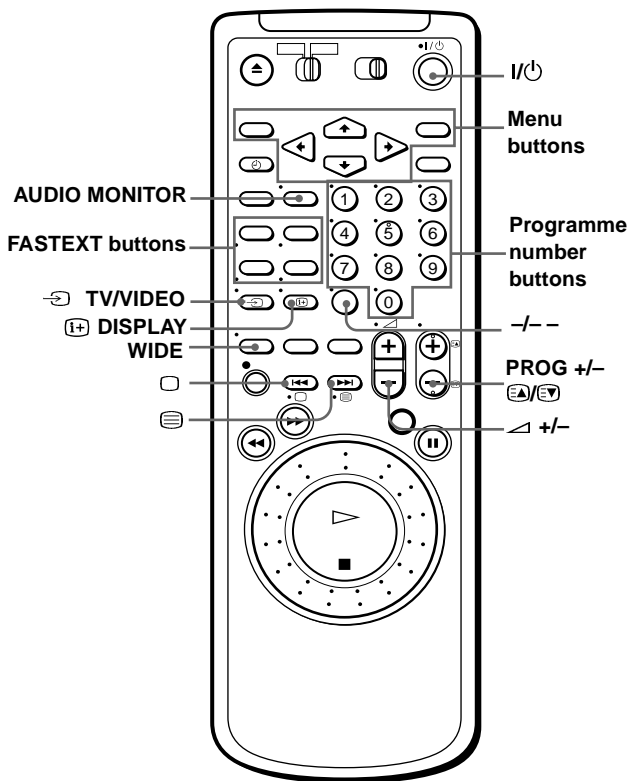

**TV control buttons**

To	Press
Turn the TV into standby	I/Power
Select an input source of the TV either from aerial in or from line in	TV/VIDEO
Select the programme position of the TV	Programme number buttons, --, PROG +/-
Adjust the volume of the TV	+/-

To	Press
Switch to TV (Teletext off)	□ (TV)
Switch to Teletext	☰ (Teletext)
Select the sound	AUDIO MONITOR
Use FASTTEXT	FASTTEXT buttons
Call up on-screen display	Ⓜ+ DISPLAY
Change the Teletext page	Ⓜ/Ⓜ
Operate TV menu	Menu buttons
Switch to/from wide mode of a Sony wide TV (For other manufacture's wide TV, see "Controlling other TVs with the remote commander" below.)	WIDE

### Notes

- In normal use, the batteries should last about three to six months.
- If you do not use the remote commander for an extended period of time, remove the batteries to avoid possible damage from battery leakage.
- Do not use a new battery with an old one together.
- Do not use different types of batteries together.
- Some buttons may not work with certain Sony TVs.

## Setting the COMMAND MODE switch

To remote control the Sony VCR with this remote commander, set COMMAND MODE on the remote commander to the same position as the one on the VCR. Usually, it is set to VTR3. Change the position as shown below to control other Sony VCRs :

- VTR1: For Sony Betamax format VCRs
- VTR2 : For Sony 8mm format VCRs
- VTR3 : For Sony VHS format VCRs

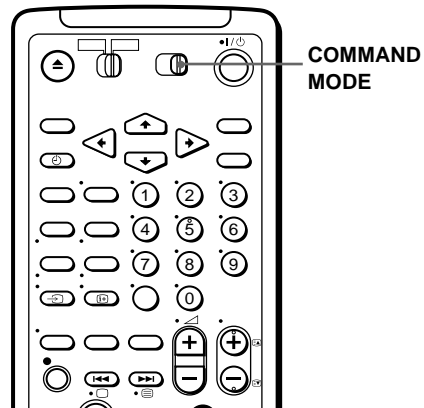

**continued**







## Step 2 : Setting up the remote commander (continued)

### Controlling other TVs with the remote commander

The remote commander is preprogrammed to control non-Sony TVs. If your TV is listed in the table below, set the appropriate manufacturer's code number.

- 1 Set TV/VIDEO at the top of the remote commander to TV.
- 2 Hold down I/⏻, and enter your TV's code number(s) using the programme number buttons. Then release I/⏻.

Now you can use the following TV control buttons to control your TV:

I/⏻, TV/VIDEO, programme number buttons, -- (ten's digit), PROG +/-,  +/-,  (TV),  (Teletext), FASTEXT buttons, WIDE\*, MENU\*, CURSOR \*/\*/\*/\*, and OK\*.

\*These buttons may not work with all TVs.

#### Tip

- When you set your TV's code number correctly while the TV is turned on, the TV turns off automatically.



## Code numbers of controllable TVs

If more than one code number is listed, try entering them one at a time until you find the one that works with your TV.

To make wide mode settings, see the footnotes below this table for the applicable code numbers.

Manufacturer	Code number
Sony	01 <sup>*1</sup> , 02, 03, 04, 05
Aiwa	32
Akai	68
Blaupunkt	10, 21
Brionvega	40
C.G.M	09
Colonad	03
Dual	44
Emerson	03, 04
Fenner	30, 31
Ferguson	52
Goldstar	03, 04, 17
Grundig	10 <sup>*1</sup> , 11 <sup>*1</sup>
Hitachi	24
Hyper	31
Inno-Hit	41
Irradio	20
ITT	15, 16, 69 <sup>*3</sup>
JVC	33
Loewe	45
Mitsubishi	27 <sup>*1</sup> , 28 <sup>*1</sup> , 50 <sup>*1</sup> , 51 <sup>*1</sup>
Mivar	09

Manufacturer	Code number
NEC	66
Nokia	15, 16, 69 <sup>*3</sup>
Nordmende	35, 42
Orion	47, 48
Panasonic	17 <sup>*1</sup> , 49
Philips	06 <sup>*1</sup> , 07 <sup>*1</sup> , 08 <sup>*1</sup>
Phonola	18, 19
Pioneer	26
Saba	12, 13
Samsung	22, 23
Sanyo	25
Schneider	46
Selecto	14
Sharp	29
Siemens	39
Sinudyne	37
TEAC	67
Telefunken	36
Thomson	43 <sup>*2</sup>
Toshiba	38
White Westinghouse	34

<sup>\*1</sup> Press WIDE to switch the wide picture modes.

<sup>\*2</sup> Press WIDE, then press  $\triangleleft$  +/- to select the wide picture mode you want.

<sup>\*3</sup> Press WIDE. The menu appears on the TV screen. Then, press CURSOR  $\uparrow/\downarrow/\leftarrow/\rightarrow$  to select the wide picture you want and press OK.

**continued**

## Step 2 : Setting up the remote commander (continued)

### Notes

- If the TV uses a different remote control system from the one programmed to work with the VCR, you cannot control your TV with the remote commander.
- If you enter a new code number, the code number previously entered will be erased.
- If you remove the batteries of the remote commander for more than a few minutes, the code number may be reset to 01 (Sony). In this case, reset the appropriate code number.

# Step 3

## Connecting the VCR

- If your TV has a EURO-AV connector, see below.
- If your TV does not have a EURO-AV connector, see page 14.

### If your TV has a EURO-AV (Scart) connector

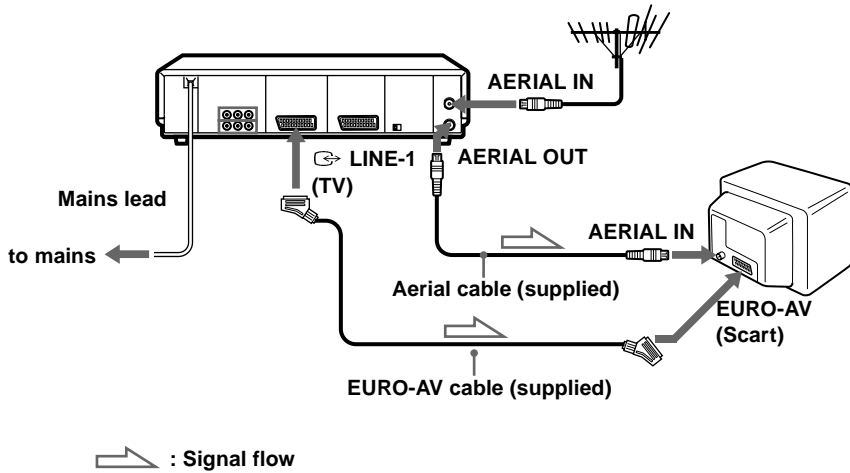

# 1

Disconnect the aerial cable from your TV and connect it to AERIAL IN on the rear panel of the VCR.

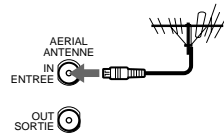

# 2

Connect AERIAL OUT of the VCR and the aerial input of your TV using the supplied aerial cable.

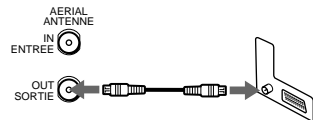

**continued**

### Step 3 : Connecting the VCR (continued)

3

Connect LINE-1 (TV) on the VCR and the EURO-AV (Scart) connector on the TV with the supplied EURO-AV cable.

This connection improves picture and sound quality. Whenever you want to watch the VCR picture, press  TV/VIDEO to display the VIDEO indicator in the display window. If your TV does not have a EURO-AV scart connector, see page 14.

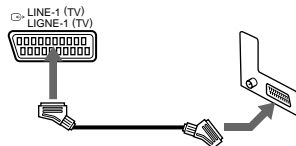

4

Connect the mains lead to the mains.

#### Notes

- If the TV is connected to the LINE-1 (TV) connector, setting the RF MODULATOR in the OTHER OPTIONS menu to OFF is recommended (initial setting). In the OFF position, only the signal from the aerial is output through the AERIAL OUT connector (see page 73). You do not have to tune your TV to the VCR. Skip "Tuning your TV to the VCR" on page 17.
- For correct connection of the SmartLink, please refer to your TV instruction manual.

## About the SMARTLINK features

If the connected TV complies with SMARTLINK, NexTVView Link, MEGALOGIC<sup>\*1</sup>, EASYLINK<sup>\*2</sup>, Q-Link<sup>\*3</sup>, EURO VIEW LINK<sup>\*4</sup> or T-V LINK<sup>\*5</sup>, you can use the



SMARTLINK function after you complete the steps on the previous page (the SMARTLINK indicator appears in the VCR's display window when you turn on the TV). You can enjoy the following SMARTLINK features.

- **Preset Download**

You can download your TV tuner preset data to this VCR and tune the VCR according to that data in Auto Set Up. This greatly simplifies the Auto Set Up procedure. Be careful, not to disconnect the cables or exit the Auto Set Up function during the procedure.

See "Setting up the VCR with the Auto Set Up function" on page 19.

- **TV Direct Rec**

You can easily record what you are watching on the TV (other than tapes being played on this VCR). For details, see "Recording what you are watching on the TV (TV Direct Rec)" on page 51.

- **One Touch Play**

With One Touch Play, you can start playback automatically without turning on the TV. For details, see "Starting playback automatically with one button (One Touch Play)" on page 47.

- **One Touch Menu**

You can turn on the VCR and TV, set the TV to the video channel, and display the VCR's on-screen display automatically by pressing MENU on the remote commander.

- **One Touch Timer**

You can turn on the VCR and TV, set the TV to the video channel, and display the timer recording menu (the TIMER METHOD menu, the TIMER menu, or the SHOWVIEW menu) automatically by pressing  TIMER on the remote commander. You can set which timer recording menu is displayed using TIMER OPTIONS in the OTHER OPTIONS menu (see page 73).

- **Automatic Power off**

You can have the VCR turn off automatically, if the VCR is not used for about 1 minute, after you turn off the TV.

- **NexTVView Download**

You can easily set the timer recording by using the NexTVView Download function of your TV. Please, refer to your TV's instruction manual.

\*1 "MEGALOGIC" is a registered trademark of Grundig Corporation.

\*2 "EASYLINK" is a trademark of Philips Corporation.

\*3 "Q-Link" is a trademark of Panasonic Corporation.

\*4 "EURO VIEW LINK" is a trademark of Toshiba Corporation.

\*5 "T-V LINK" is a trademark of JVC Corporation.

### Note

- Not all the TVs respond to the functions above.

**continued**

Step 3 : Connecting the VCR (continued)

If your TV does not have a EURO-AV (Scart) connector

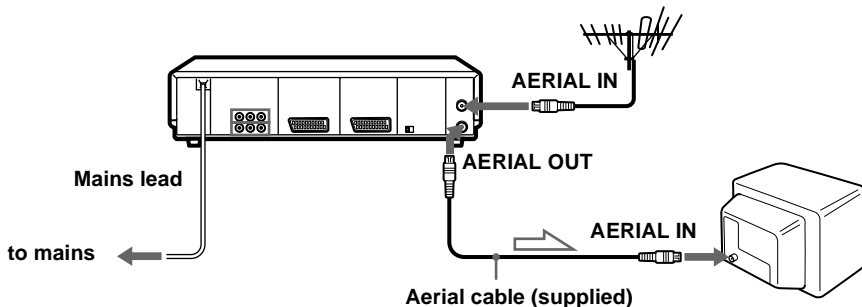

 : Signal flow

- 1 Disconnect the aerial cable from your TV and connect it to AERIAL IN on the rear panel of the VCR.

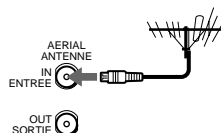

- 2 Connect AERIAL OUT of the VCR and the aerial input of your TV using the supplied aerial cable.

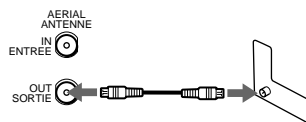

- 3 Connect the mains lead to the mains.

**Note**

- When you connect the VCR and your TV only with an aerial cable, you have to set RF MODULATOR in the OTHER OPTIONS menu to ON (see page 73).

## Additional connections

### To a stereo system

You can improve sound quality by connecting a stereo system to the AUDIO OUT R/L jacks as shown on the right.

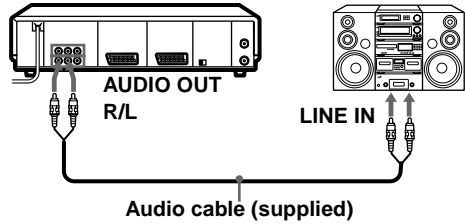

### To a TV that has phono type audio/video input jacks (only if you don't connect the VCR and your TV using a EURO-AV connector)

This additional connection improves picture and sound quality. Connect the TV as shown on the right using a commercially available connecting cable like the Sony VMC-810. If your TV has only one audio input jack, use a connecting cable like the Sony VMC-910MS.

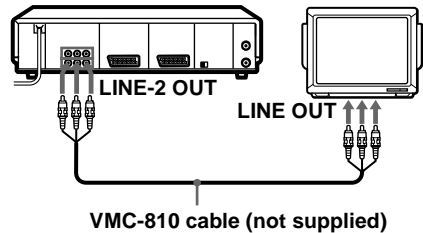

### To a satellite tuner

You can watch programmes from the satellite tuner connected to this VCR on the TV even when the VCR is turned off using the Line Through function. When you turn on the satellite tuner, this VCR automatically sends the signal from the satellite tuner to the TV without turning itself on.

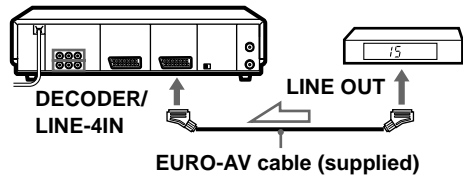

➤ : Signal flow

- 1** Connect the satellite tuner to the DECODER/LINE-4IN connector as shown above.
- 2** Set DECODER/LINE-4 to LINE-4 in the OTHER OPTIONS menu.
- 3** Set POWER SAVE to OFF in the OTHER OPTIONS menu.
- 4** Turn off the VCR.  
To watch a satellite programme, turn on the satellite tuner and the TV.  
For details, see page 37.

continued

### Step 3 : Connecting the VCR (continued)

**Note**

- You cannot watch satellite programmes on the TV while recording unless you record a satellite programme.



# Step 4

## Tuning your TV to the VCR

If you have connected the VCR to your TV using the EURO-AV cable, skip this step.

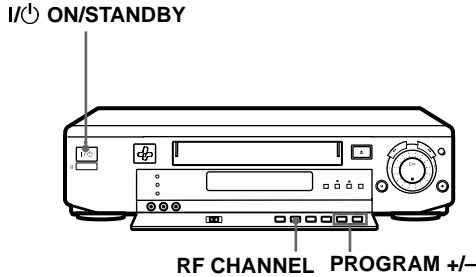

- 1**  Press I/ON/STANDBY to turn on the VCR.  
Pull down the drop down panel.

---

- 2**  Press briefly RF CHANNEL on the VCR.  
The factory-preset RF channel appears in the display window.  
The VCR signal is output through this channel to the TV.

RF 32

---

- 3** Turn on your TV and select a programme position for the VCR picture.  
This programme position will now be referred to as the video channel.

---

- 4**  Press RF CHANNEL.  
The TV system appears in the display window.

RF 32 K

**continued**

## Step 4 : Tuning your TV to the VCR (continued)

5

Press PROGRAM +/- (repeatedly) to select the correct TV system.  
If you watch the system B/G, select "G". If you watch the system D/K, select "K".

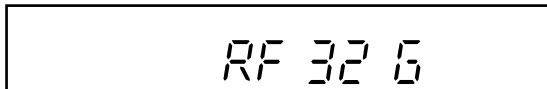

6

Tune the TV to the same channel as the one shown in the display window so that the picture on the right appears clearly on the TV screen.

Refer to your TV manual for tuning instructions.

If the picture does not appear clearly, see "To obtain a clear picture from the VCR" below.

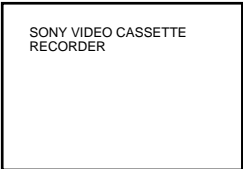

SONY VIDEO CASSETTE  
RECORDER

7

RF  
CHANNEL

Press RF CHANNEL.

You have now tuned your TV to the VCR. From now on, whenever you want to play a tape, set the TV to the video channel.

### To check if the TV tuning is correct

Set the TV to the video channel and press PROGRAM +/- on the VCR. If the TV screen changes to a different programme each time you press PROGRAM +/-, the TV tuning is correct.

### To obtain a clear picture from the VCR

If the picture does not appear clearly in step 6 above, go to step 7 to finish this procedure once. Then start from step 2. After pressing RF CHANNEL in step 2 to display the RF CHANNEL, press PROGRAM +/-, so that another RF channel appears. Then tune the TV to the new RF channel until a clear picture appears.

### Notes

- When you connect the VCR and your TV only with an aerial cable, you have to set RF MODULATOR in the OTHER OPTIONS menu to ON (see page 73).
- If you set the wrong TV system, you may have no sound or may be distorted.

## Step 5

# Setting up the VCR with the Auto Set Up function

Before using the VCR for the first time, set up the VCR using the Auto Set Up function. With this function, you can set the language for the on-screen display, TV channels, guide channels for the ShowView system, and VCR clock automatically.

### Before you start ...

- Turn on the satellite tuner if it is connected to the VCR only by the aerial cable and not to the EURO-AV cable.

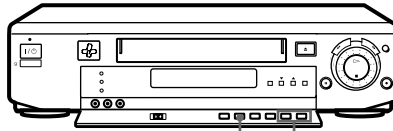

AUTO SET UP PROGRAM +/-

### 1



Hold down AUTO SET UP on the VCR for more than 3 seconds.

The VCR automatically turns on, and the country abbreviation appears in the display window.

ELSE

### 2



Press PROGRAM +/- to highlight the abbreviation of your country.

For some countries, there is a selection of languages to choose from.

The abbreviations of the countries and languages are as follows :

**continued**

## Step 5 : Setting up the VCR with the Auto Set Up function (continued)

Abbreviation	Country	Language
CZ	Czech	Czech
GR	Greece	Greek
HUN	Hungary	Hungarian
PL	Poland	Polish
RUS	Russia	Russian
ELSE	Other countries	English

If your country does not appear in the list , select ELSE.

**3**



Press AUTO SET UP.

The VCR starts searching for all of the receivable channels and presets them in the appropriate order for your local area.



If you use the SMARTLINK connection, the Preset Download function starts and the SMARTLINK indicator flashes in the display window during download.

After the search or download is complete, the current time appears in the display window for any stations that transmit a time signal.

### To cancel the Auto Set Up function

Press AUTO SET UP.

#### Tip

- If you want to change the language for the on-screen display from the one preset in the Auto Set Up function, see page 26.

#### Notes

- Do not cancel the Auto Set Up function during step 3. If you do, repeat Auto Set Up from the beginning.
- Sometimes, when you operate the Auto Set Up function, some of the settings (ShowView, timer etc...) will be reset. In this case, you have to set them again.

# Step 6

## Setting the clock

You must set the time and date on the VCR to use the timer recording features properly.

The Auto Clock Set function works only if a station in your area is broadcasting a time signal. If the Auto Set Up function did not set the clock correctly for your local area, try another station for the Auto Clock Set function.

### Setting the clock manually

#### Before you start...

- Turn on the VCR and the TV.
- Set the TV to the video channel.

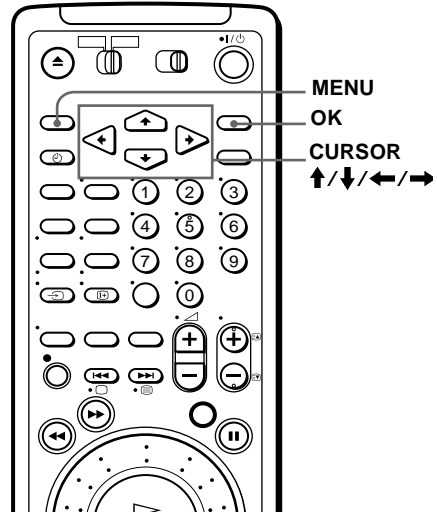

1

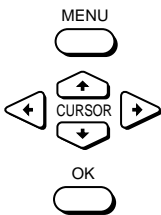

Press MENU, then press CURSOR  $\uparrow/\downarrow$  to highlight SETTINGS and press OK.

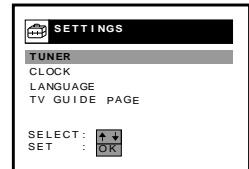

2

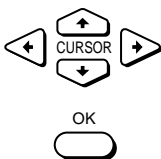

Press CURSOR  $\uparrow/\downarrow$  to highlight CLOCK, then press OK.

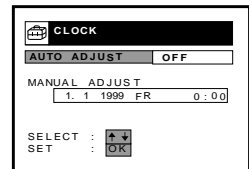

continued

## Step 6 : Setting the clock (continued)

3

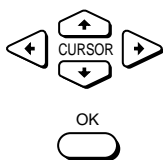

Press CURSOR  $\uparrow/\downarrow$  to highlight MANUAL ADJUST, then press OK.

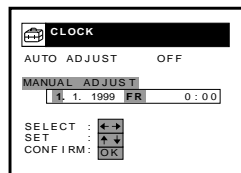

4

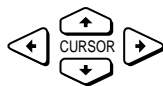

Press CURSOR  $\uparrow/\downarrow$  to set the date.

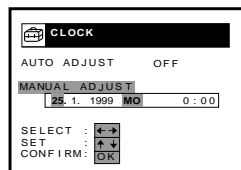

5

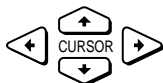

Press CURSOR  $\rightarrow$  to highlight the month and set the month pressing CURSOR  $\uparrow/\downarrow$ .

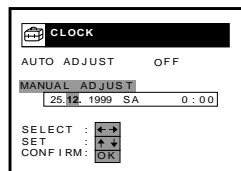

6

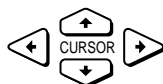

Set the year, hour, and minutes in sequence, pressing CURSOR  $\rightarrow$  to highlight the item to be set, and press CURSOR  $\uparrow/\downarrow$  to select the digits.  
The day of the week is set automatically.

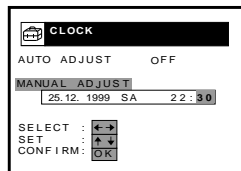

7



Press OK to confirm the setting and start the clock.

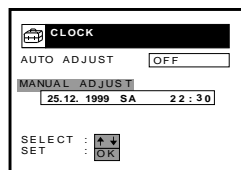

---

**8**

Press MENU to exit the menu.

---

**Tip**

- To change the digits during setting, press CURSOR ← to return to the item to be changed, and select the digits pressing CURSOR ↑/↓.

**Note**

- The menu disappears automatically if you don't proceed for more than a few minutes.

**continued**

---

## Step 6 : Setting the clock (continued)

### Changing the station for the Auto Clock Set function

#### Before you start...

- Turn on the VCR and the TV.
- Set the TV to the video channel.

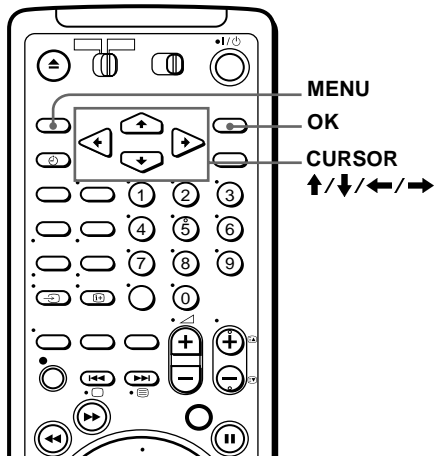

1

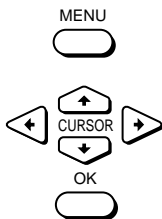

Press MENU, then press CURSOR  $\uparrow/\downarrow$  to highlight SETTINGS and press OK.

When using the Auto Set Up procedure, skip this step

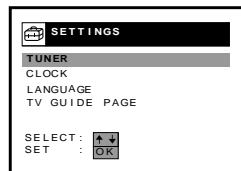

2

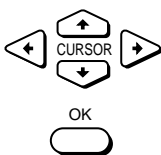

Press CURSOR  $\uparrow/\downarrow$  to highlight CLOCK, then press OK.

AUTO ADJUST is highlighted.

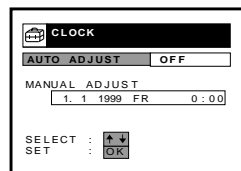

3



Press OK.

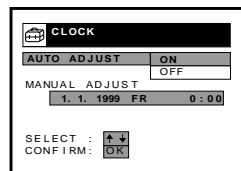



4

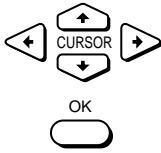

Press CURSOR  $\uparrow/\downarrow$  to highlight ON, then press OK.

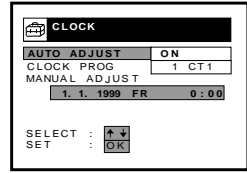

5

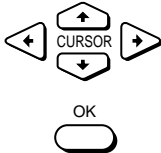

Press CURSOR  $\downarrow$  to highlight CLOCK PROG, then press OK.

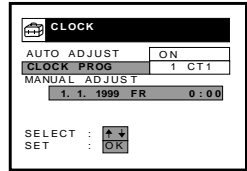

6

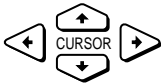

Press CURSOR  $\uparrow/\downarrow$  repeatedly until the programme position of the station that carries the time signal appears.

If the VCR does not receive the time signal from any station, AUTO ADJUST returns to OFF automatically.

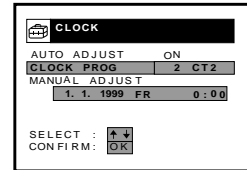

7



Press MENU to exit the menu.

### Tips

- To change the digits during setting, press CURSOR  $\leftarrow$  to return to the item to be changed, and select the digits using CURSOR  $\uparrow/\downarrow$ .
- If you set AUTO ADJUST to ON, the Auto Clock Set function is activated whenever the VCR is turned off. The time is adjusted automatically by making reference to the time signal from the station whose programme position is displayed in the "CLOCK PROG" row. If you do not need the Auto Clock Set, select OFF.

### Note

- The menu disappears automatically if you don't proceed for more than a few minutes.

# Selecting a language

You can change the on-screen display language from the one you selected with the Auto Set Up function.

## Before you start...

- Turn on the VCR and the TV.
- Set the TV to the video channel.

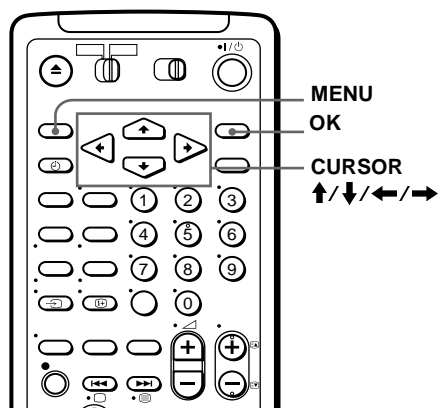

- 1** Press MENU, then press CURSOR  $\uparrow/\downarrow$  to highlight SETTINGS and press OK.

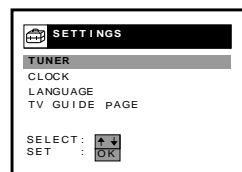
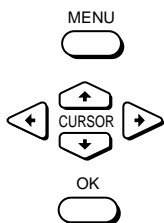

- 2** Press CURSOR  $\uparrow/\downarrow$  to highlight LANGUAGE, then press OK.

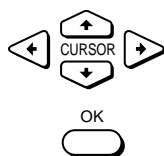

- 3** Press CURSOR  $\uparrow/\downarrow/\leftarrow/\rightarrow$  to highlight the desired language then press OK.

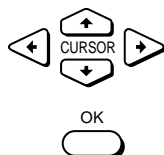

## Note

- The menu disappears automatically if you don't proceed for more than a few minutes.

# Presetting channels

If some channels could not be preset using the Auto Set Up function, you can preset them manually.

## Before you start...

- Turn on the VCR and the TV.
- Set the TV to the video channel.

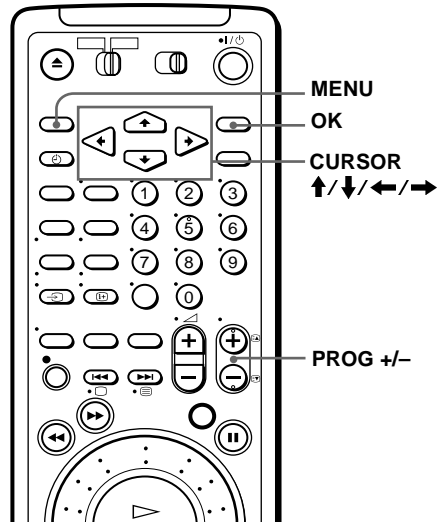

**1**

MENU

CURSOR

OK

Press MENU, then press CURSOR  $\uparrow/\downarrow$  to highlight SETTINGS and press OK.

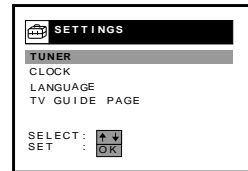

**2**

CURSOR

OK

Press CURSOR  $\uparrow/\downarrow$  to highlight TUNER, then press OK.

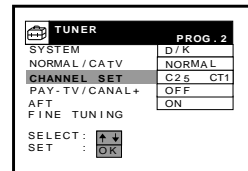

**3**

CURSOR

OK

Press CURSOR  $\uparrow/\downarrow$  to highlight NORMAL/CATV, then press OK.

Press CURSOR  $\uparrow/\downarrow$  to highlight NORMAL, then press OK

To preset CATV (Cable Television) channels, select CATV.

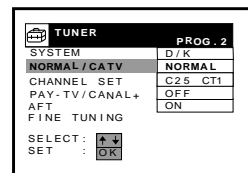

continued

## Presetting channels (continued)

4

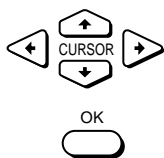

Press CURSOR  $\uparrow/\downarrow$  to highlight CHANNEL SET.

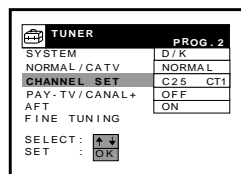

5



Press PROG +/- to select the programme position.

**Selected programme position**

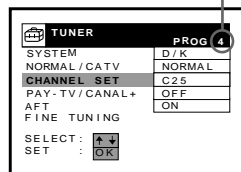

6

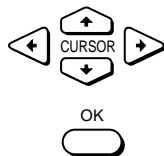

Press OK to highlight the channel number row, then press CURSOR  $\uparrow/\downarrow$  to start tuning.

The VCR starts searching for a channel and displays the first one it finds on the TV screen. Press CURSOR  $\uparrow/\downarrow$  repeatedly until the channel you want is displayed.

The channels are scanned in the following order :

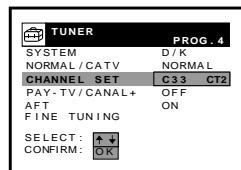

B/G TV system		D/K TV system	
Channel number in the CHANNEL SET field	Channel	Channel number in the CHANNEL SET field	Channel
C02	E2	C02	R1
C03	E3	C05	R6
C04	E4	C06	R7
C05	E5	C12	R12
C06	E6	C13	R2
C07	E7	C14	R3
C08	E8	C15	R4
C09	E9	C16	R5

B/G TV system		D/K TV system	
Channel number in the CHANNEL SET field	Channel	Channel number in the CHANNEL SET field	Channel
C10	E10	C17	R8
C11	E11	C18	R9
C12	E12	C19	R10
C21-C69	E21-E69	C20	R11
CATV S01-S41	S01-S41	C21-C69	R21-R69
CATV S42-S46	S01-S05		

If you know the number of the channel you want, press the programme number buttons. For example, for channel 05, first press "0" and then press "5."

7

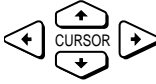

If the sound is distorted or noisy, press OK then CURSOR  $\uparrow/\downarrow/\leftarrow/\rightarrow$  to highlight SYSTEM, then select B/G or D/K so that you get the better sound.

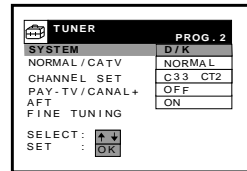

8



Press OK.

9

To allocate another channel to another programme position, repeat steps 4 to 8.

10



Press MENU to exit the menu.

**continued**

## Presetting channels (continued)

### Disabling unwanted programme positions

After tuning the TV channels, you can disable unused programme positions. The disabled positions will be skipped later when you press the PROG +/- buttons. You can also disable unwanted programme positions using the CHANNEL LIST menu (see page 33).

- 1 In step 6 above, press programme number button “0” twice to display the number “00” beside CHANNEL SET.
- 2 Press OK to confirm the setting, then MENU to exit the menu.

### If the picture is not clear

Normally, the Auto Fine Tuning (AFT) function automatically tunes in channels clearly. If, however the picture is not clear, you may also use the manual tuning function.

- 1 Press PROG +/- or the programme number buttons to select the programme position for which you cannot obtain a clear picture.
- 2 Press MENU, then select SETTINGS and press OK.
- 3 Select TUNER, then press OK.
- 4 Select FINE TUNING.

The fine tuning meter appears.

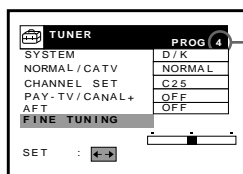

Selected programme position

- 5 Press CURSOR  $\leftarrow/\rightarrow$  to get a clearer picture, then press MENU to exit the menu.

Note that the AFT (Auto Fine Tuning) setting switches to OFF.

#### Note

- The menu disappears automatically if you don't proceed for more than a few minutes.

# Setting/changing the station names

You can also set and change station names as you like. The set station names are displayed on the TV screen when you change the programme position on the VCR. You can change the station names (up to 5 characters).

## Before you start...

- Turn on the VCR and the TV.
- Set the TV to the video channel.

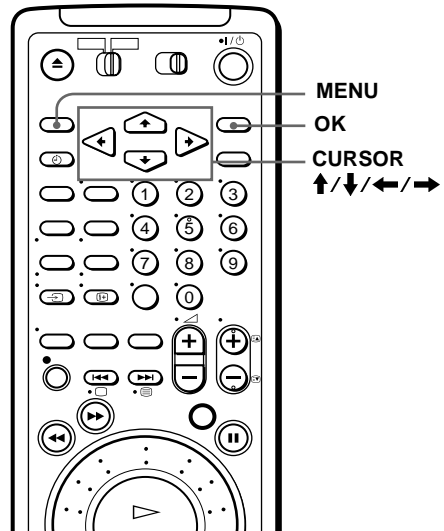

1

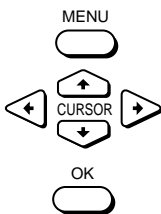

Press MENU, then press CURSOR  $\uparrow/\downarrow$  to highlight LISTS and press OK.

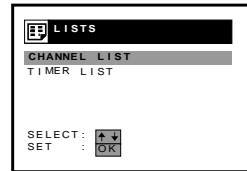

2

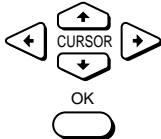

Press CURSOR  $\uparrow/\downarrow$  to highlight CHANNEL LIST, then press OK.

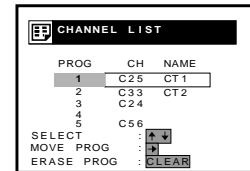

3

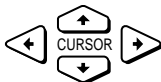

Press CURSOR  $\uparrow/\downarrow$  to highlight the row on which you want to set or change the station name.

To display other pages for programme positions 6 to 60, press CURSOR  $\uparrow/\downarrow$  repeatedly.

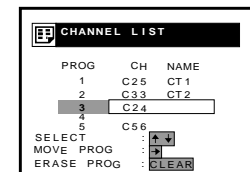

continued

## Setting/changing the station names (continued)

4

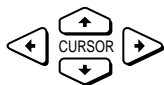

- If you want to set the station name, press CURSOR → twice to highlight the station name column only.
- If you don't want to set the station name, go to step 7.

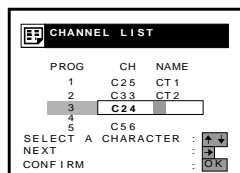

5

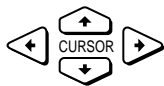

Enter the station name.

- 1 Press CURSOR ↑/↓ to select a character.

Each time you press CURSOR ↑, the character changes as shown below.

A → B → ... → Z → a → b → ...  
 → z → 0 → 1 → ... → 9 →  
 (symbols) → (blank space) → A

- 2 Press CURSOR → to set the next character. The next space is highlighted.

To correct a character, press CURSOR ← until the character you want to correct is highlighted, then reset it.

You can set up to 5 characters for the station name.

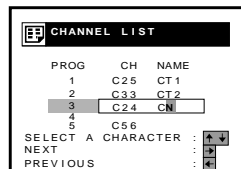

6

To change or to set the station name of another station, repeat steps 2 to 4.

7



Press OK to confirm the setting.

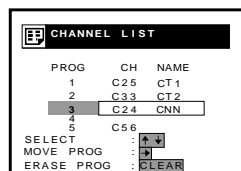

8



Press MENU to exit the menu.

**Note**

- The menu disappears automatically if you don't proceed for more than a few minutes.



# Changing/disabling programme positions

After setting the channels, you can change the programme positions as you like. If any programme positions are unused or contain unwanted channels, you can disable them.

## Before you start...

- Turn on the VCR and the TV.
- Set the TV to the video channel.

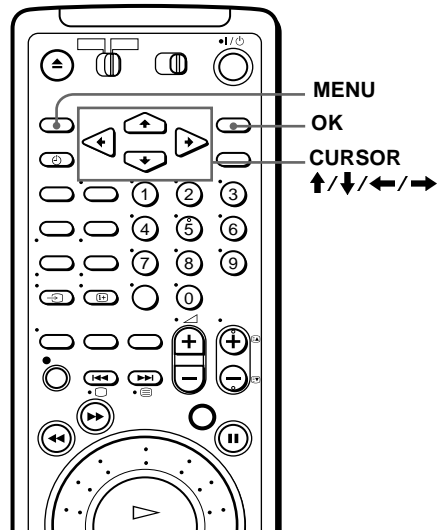

## Changing programme positions

- 1** Press MENU, then press CURSOR  $\uparrow/\downarrow$  to highlight LISTS and press OK.

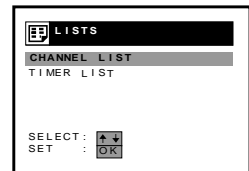
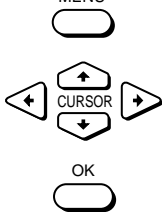

- 2** Press CURSOR  $\uparrow/\downarrow$  to highlight CHANNEL LIST, then press OK.

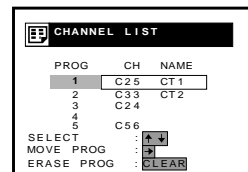
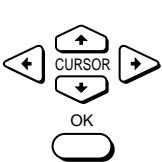

continued

## Changing/disabling programme positions (continued)

3

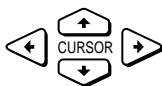

Press CURSOR  $\uparrow/\downarrow$  to highlight the row on which you want to change the programme position, then press CURSOR  $\rightarrow$ .

To display other pages for programme positions 6 to 60, press CURSOR  $\uparrow/\downarrow$  repeatedly.

CHANNEL LIST		
PROG	CH	NAME
1	C25	CT1
2	C33	CT2
3	C24	
4		
5	C56	

SELECT :  $\uparrow/\downarrow$   
 SET STATION NAME :  $\rightarrow$   
 CONFIRM : OK

4

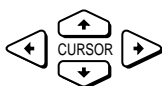

Press CURSOR  $\uparrow/\downarrow$  until the selected channel row moves to the desired programme position.

The selected channel is inserted at the new programme position and the intermediate channels are displaced to fill the gap.

CHANNEL LIST		
PROG	CH	NAME
1	C24	
2	C25	CT1
3	C33	CT2
4		
5	C56	

SELECT :  $\uparrow/\downarrow$   
 SET STATION NAME :  $\rightarrow$   
 CONFIRM : OK

5



Press OK to confirm the setting.

6

To change the programme position of another station, repeat steps 3 to 5.

7



Press MENU to exit the menu.

## Disabling unwanted programme positions

After presetting channels, you can disable unused programme positions. The disabled positions will be skipped later when you press the PROG +/- buttons.

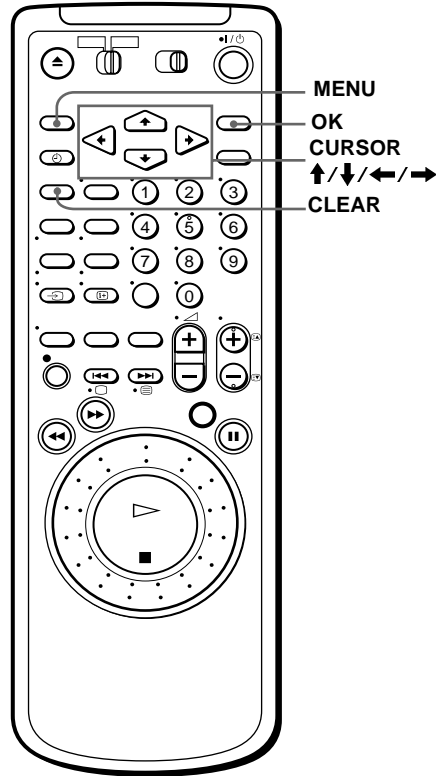

- 1** Press MENU, then press CURSOR  $\uparrow/\downarrow$  to highlight LISTS, and press OK.

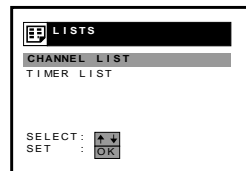
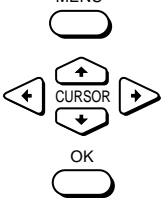

- 2** Press CURSOR  $\uparrow/\downarrow$  to highlight CHANNEL LIST, then press OK.

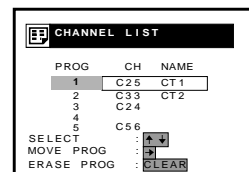
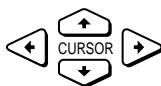

continued

## Changing/disabling programme positions (continued)

3

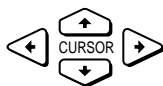

Press CURSOR  $\uparrow/\downarrow$  to highlight the row on which you want to disable.

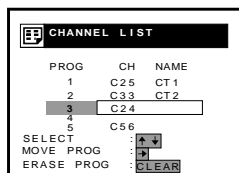

4



Press CLEAR.

The selected row will be cleared as shown on the right.

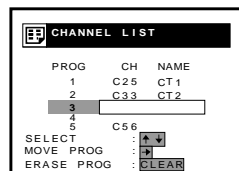

5

Repeat steps 3 and 4 for any other programme positions you want to disable.

6



Press MENU to exit the menu.

### Notes

- The menu disappears automatically if you don't proceed for more than a few minutes.
- Be sure to select the programme position you want to disable correctly. If you disable a programme position by mistake, you need to reset that channel manually.

# Connecting the Satellite tuner

You can connect a Satellite tuner into LINE-4IN connector.

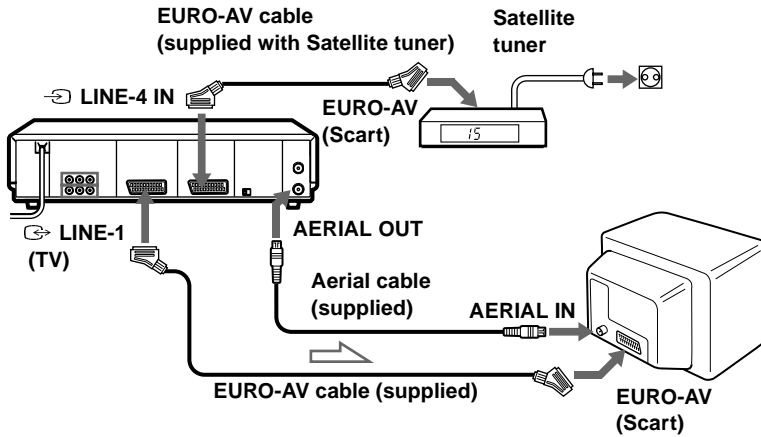

 :Signal flow

continued

## Connecting the Satellite tuner (continued)

### Setting the Satellite tuner

To watch or record from the Satellite tuner, set your VCR to receive the channels using the on-screen display.

#### Before you start...

- Turn on the VCR, the TV, and the decoder.
- Set the TV to the video channel.

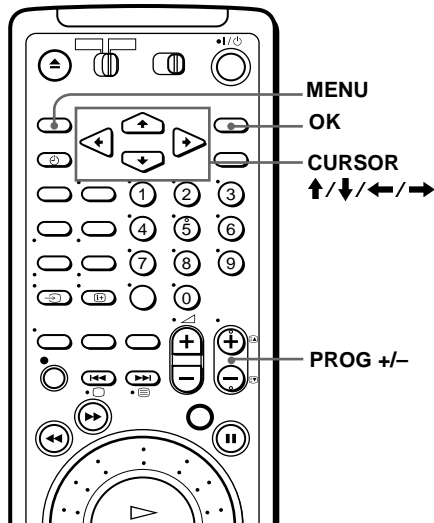

**1** Press MENU, then press **↑/↓** to highlight **OPTIONS** and press OK.

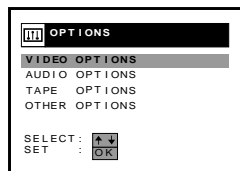
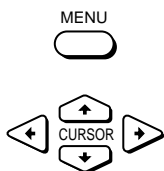

**2** Press **↑/↓** to highlight **OTHER OPTIONS**, then press OK.

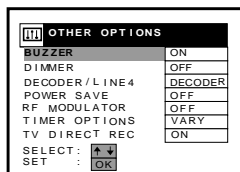
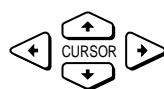

**3** Press **↑/↓** to highlight **DECODER / LINE4**, then press OK.

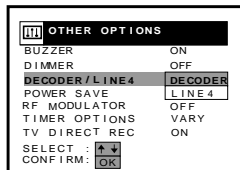
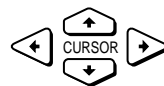

4

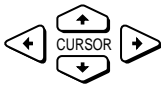

Press **↑/↓** to select LINE4 and press OK.

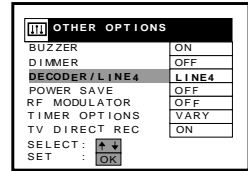

5



Press MENU to exit the menu.

6

Turn off the VCR to watch a satellite broadcast.

#### Note

- To record a satellite programme, press INPUT SELECT button to display "L4" in the display window.

# Setting the PAY-TV/Canal Plus decoder

You can watch or record PAY-TV/Canal Plus programmes if you connect a decoder (not supplied) to the VCR.

## Connecting a decoder

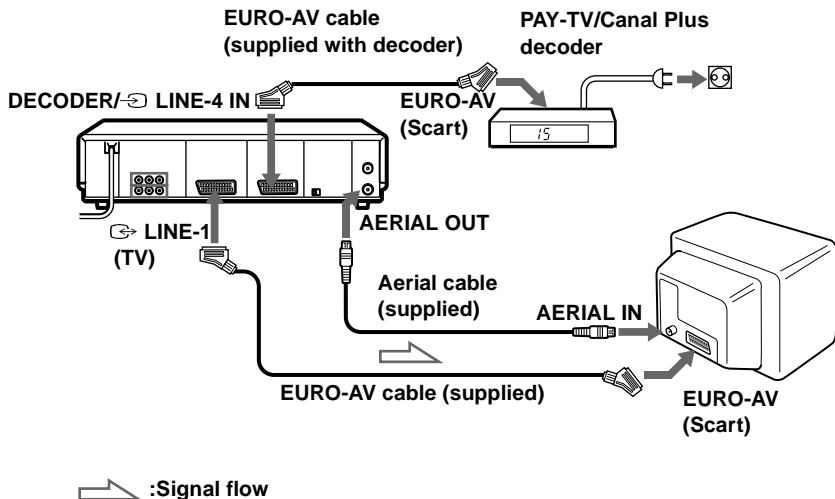



## Setting PAY-TV/Canal Plus channels

To watch or record PAY-TV/Canal Plus programmes, set your VCR to receive the channels using the on-screen display.

### Before you start...

- Turn on the VCR, the TV, and the decoder.
- Set the TV to the video channel.

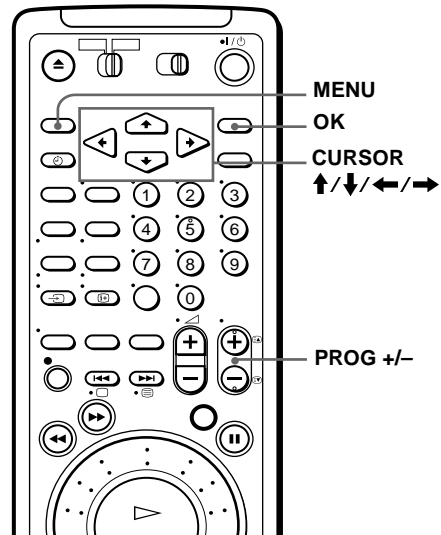

**1** Press MENU, then press CURSOR  $\uparrow/\downarrow$  to highlight OPTIONS and press OK.

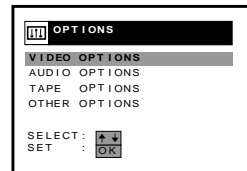

**2** Press CURSOR  $\uparrow/\downarrow$  to highlight OTHER OPTIONS, then press OK.

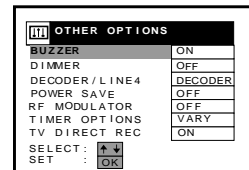

**3** Press CURSOR  $\uparrow/\downarrow$  to highlight DECODER/LINE4, then press OK.

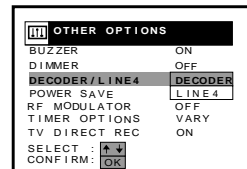

continued

Setting the PAY-TV/Canal Plus decoder (continued)

**4** Press CURSOR  $\uparrow/\downarrow$  to highlight DECODER, then press OK.

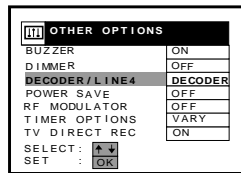
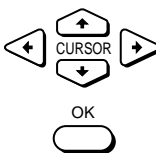

**5** Press MENU to exit the menu.



**6** Press MENU, then press CURSOR  $\uparrow/\downarrow$  to highlight SETTINGS and press OK.

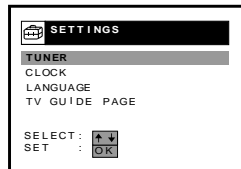
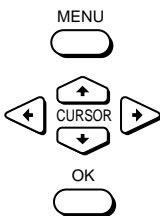

**7** Press CURSOR  $\uparrow/\downarrow$  to highlight TUNER, then press OK.

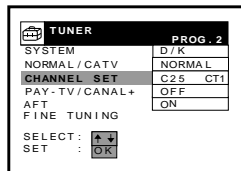
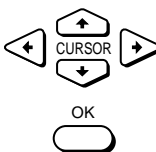

**8** Press CURSOR  $\uparrow/\downarrow$  to highlight NORMAL/CATV, then press OK.

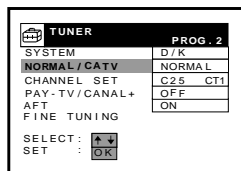
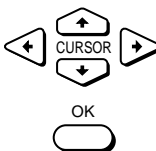

9

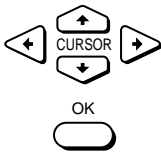

Press CURSOR  $\uparrow/\downarrow$  to highlight NORMAL, then press OK.

To preset CATV (Cable Television) channels, select CATV.

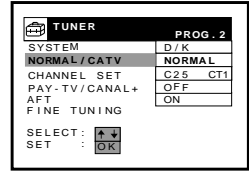

10



Press PROG +/- to select the desired programme position.

Selected programme position

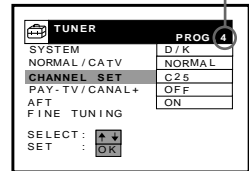

11

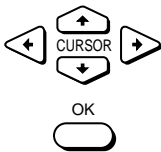

Press CURSOR  $\uparrow/\downarrow$  to highlight CHANNEL SET, then press OK.

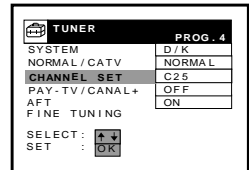

12

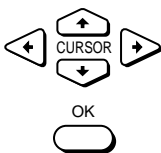

Press CURSOR  $\uparrow/\downarrow$  to select the PAY-TV/Canal Plus channels.

When the desired channel is tuned, press OK.

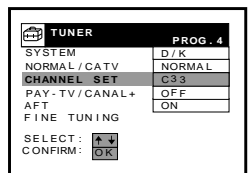

13

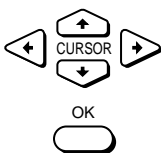

Press CURSOR  $\uparrow/\downarrow$  to highlight PAY-TV/CANAL+, then press OK.

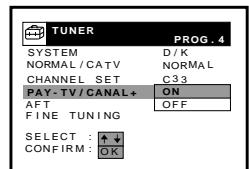

continued

## Setting the PAY-TV/Canal Plus decoder (continued)

14

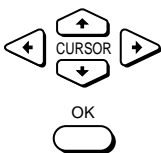

Press CURSOR  $\uparrow/\downarrow$  to highlight ON, then press OK.

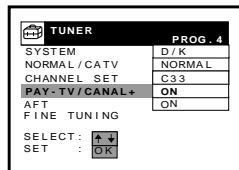

15

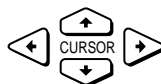

If the sound is distorted or noisy, press CURSOR  $\uparrow/\downarrow/\leftarrow/\rightarrow$  to highlight SYSTEM, then select B/G or D/K so that you get the better sound.

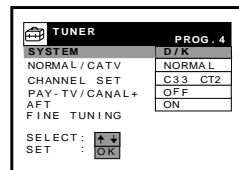

16



Press MENU to exit the menu.

### Notes

- The menu disappears automatically if you don't proceed for more than a few minutes.
- To superimpose subtitles while watching PAY-TV/Canal Plus programmes, make both decoder-VCR and VCR-TV connections using 21-pin EURO-AV cables that are compatible with the RGB signals. You cannot record subtitles on the VCR.
- When you watch PAY-TV/Canal Plus programmes using the aerial input of the TV, press  $\text{TV/VIDEO}$  so that the VIDEO indicator appears in the display window.
- Some PAY-TV/Canal Plus decoders may not work if you set the PAY-TV/CANAL + setting to ON. In this case, set it to OFF.

# Playing a tape

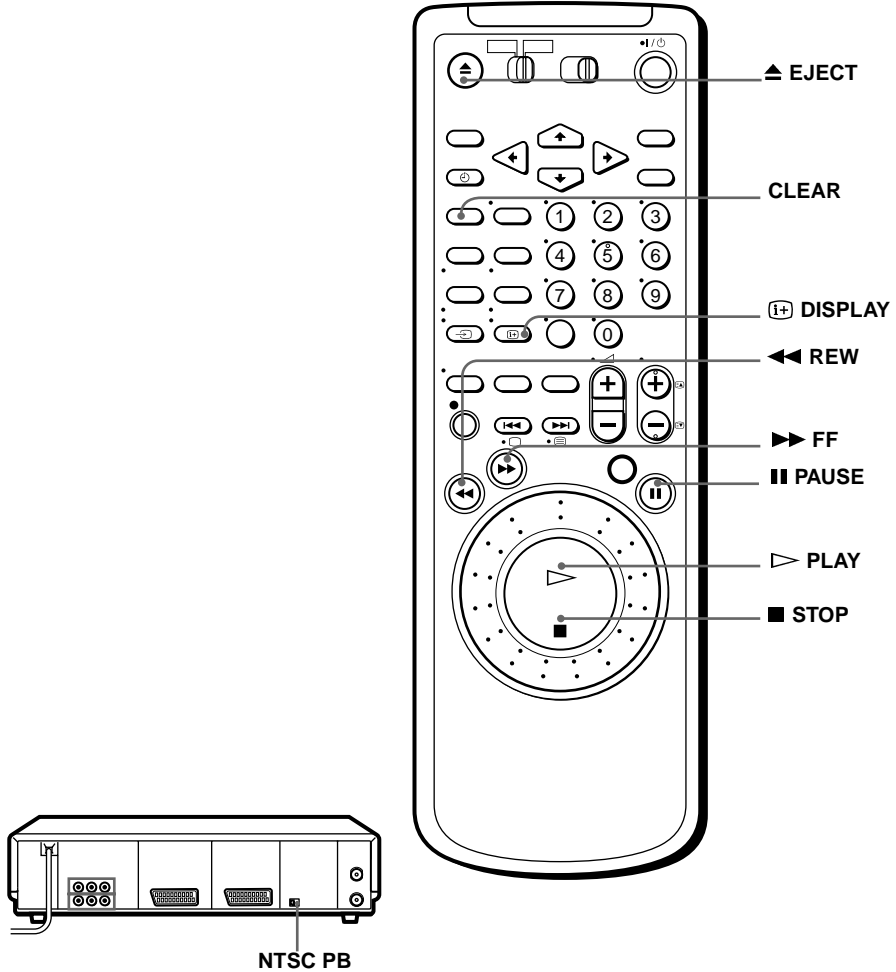

**1** Turn on your TV and set it to the video channel.

**2** Insert a tape.  
The VCR turns on and starts playing automatically if you insert a tape with its safety tab removed.

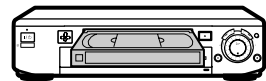

**continued**

### Playing a tape (continued)

3



Press ▷ PLAY.

When the tape reaches the end, it will rewind automatically.

#### Additional tasks

To	Press
Stop play	■ STOP
Pause play	PAUSE
Resume play after pause	PAUSE or ▷ PLAY
Fast-forward the tape	▶▶ FF during stop
Rewind the tape	◀◀ REW during stop
Eject the tape	▲ EJECT

#### To set the colour system

If the playback picture has no colour or streaks appear during playback, set the COLOUR SYSTEM option in the VIDEO OPTIONS menu to conform to the system that the tape was recorded (see page 71). (Normally set the option to AUTO).

#### To play an NTSC-recorded tape

Set NTSC PB at the rear of the VCR according to the colour system of your TV.

When your TV is	Set NTSC PB to
PAL only	ON PAL TV
PAL and NTSC	NTSC 4.43

#### To use the time counter

At the point on the tape that you want to find later, press CLEAR. The counter in the display window resets to "0:00:00." Search for the point afterwards by referring to the counter.

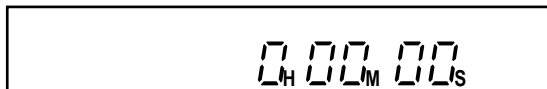

To display the counter on the TV screen, press (+) DISPLAY.

**Notes**

- The counter resets to "0:00:00" whenever a tape is reinserted.
- The counter stops counting when it comes to a portion with no recording.
- The time counter does not appear on the TV screen when using an NTSC-recorded tape.
- Depending on your TV, the following may occur while playing an NTSC-recorded tape:
  - The picture becomes black and white.
  - The picture shakes.
  - No picture appears on the TV screen.
  - Black streaks appear horizontally on the TV screen.
  - The colour density increases or decreases.
- If you playback a tape in LP or EP mode with NTSC system, the sound is heard in monaural.

**Starting playback automatically with one button (One Touch Play)**

If you use the SMARTLINK connection, you can turn on the VCR and the TV, set the TV to the video channel, and start playback automatically with one button.

**1** Insert a tape.

The VCR automatically turns on.

If you insert a tape with its safety tab removed, the TV turns on and switches to the video channel. Playback starts automatically.

**2** Press  $\triangleright$  PLAY.

The TV turns on and switches to the video channel automatically. Playback starts.

**Tip**

- When there already is a tape in the VCR, the VCR and the TV turn on, the TV is set to the video channel, and playback starts automatically in one sequence when you press  $\triangleright$  PLAY.

**Note**

- When you use the One Touch Play function, leave the TV on or in the standby mode.

# Recording TV programmes

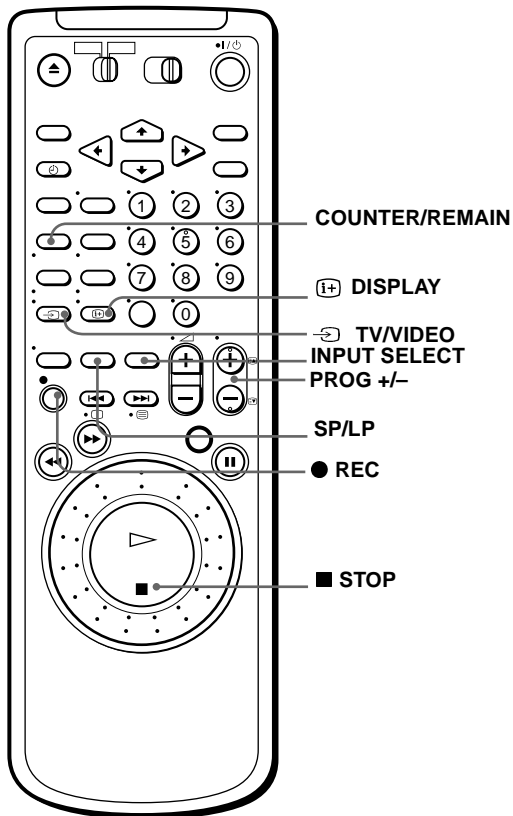

- 
- 1** Turn on your TV and set it to the video channel.  
To record from a decoder, turn it on.

---

  - 2** Insert a tape with its safety tab in place.

---



3



- To record a normal channel.  
Press **PROG +/-** until the programme position number you want appears in the display window.

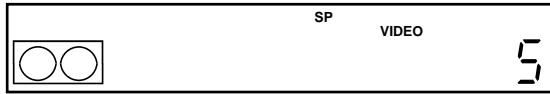

- To record a video source from the **LINE-1 (TV)** or **LINE-4 (Scart)** connector, or the **LINE-2IN** or **LINE-3 IN** jacks. Press **INPUT SELECT** until **L1, L2, L3** or **L4** appears in the display window.

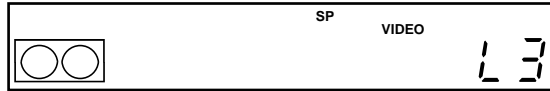

4



Press **SP/LP** to select the tape speed, **SP** or **LP**.

**LP (Long Play)** provides recording time twice as long as **SP**, however, **SP (Standard Play)** produces better picture and audio quality.



5



Press **REC** to start recording.

The recording indicator lights up red in the display window.

**Recording indicator**

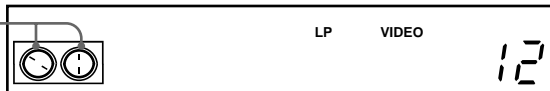

**To stop recording**

Press **STOP**.

continued

### Recording TV programmes (continued)

#### To check the remaining time

Press **(t+)** DISPLAY. With the display on, press COUNTER/REMAIN to check the remaining time. Each time you press COUNTER/REMAIN, the time counter and the remaining time appear alternately. The remaining time with the  indicator also appears in the display window.

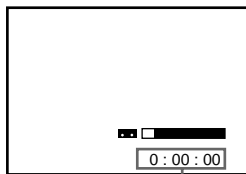

Time counter

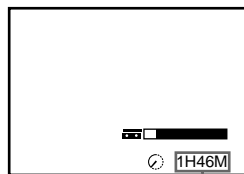

Remaining time

In order to get an accurate remaining time indication, be sure the TAPE LENGTH item in TAPE OPTIONS menu is set according to the tape type you use (see page 72).

#### To watch another TV programme while recording

- 1 Press **(TV)** TV/VIDEO on the remote commander to turn off the VIDEO indicator in the display window.
- 2 Select another programme position on the TV.

#### To protect a recording

To prevent accidental erasure, break off the safety tab as illustrated. To record on a tape again, cover the tab hole with adhesive tape.

You can also protect a recording by using the SmartFile function (see page 98).

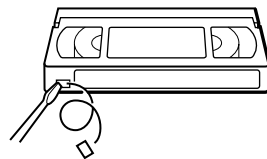

Safety tab

#### Tips

- To select a programme position, you can use the programme number buttons on the remote commander. For two-digit numbers, press the **--** (ten's digit) button followed by the programme number buttons.
- The display appears on the TV screen indicating information about the tape, but the information won't be recorded on the tape.
- If you don't want to watch TV while recording, you can turn off the TV. When using a decoder, make sure to leave it on.

**Notes**

- The display does not appear during still (pause) mode or slow-motion playback.
- The display will not appear while playing an NTSC-recorded tape.
- If a tape has portions recorded in both PAL and NTSC systems, the time counter reading will not be correct. This discrepancy is due to the difference between the counting cycles of the two video systems.
- You cannot watch a PAY-TV/Canal Plus programme while recording another PAY-TV/Canal Plus programme.
- The remaining time is intended for rough measurement only.
- The remaining time will be displayed only about 30 seconds after the tape is inserted.

**Recording what you are watching on the TV (TV Direct Rec)**

If you use the SMARTLINK connection, you can easily record what you are watching on the TV (other than tapes being played on the VCR).

- 1** Insert a tape with its safety tab in place.
- 2** Press ● REC while you are watching a TV programme or external source.  
The VCR automatically turns on, then the TV indicator lights up and the VCR starts recording what you are watching on the TV.

**Tips**

- The TV indicator appears in the display window after you press ● REC in some situations such as:
  - when you are watching a source connected to the TV's line input, or
  - when the TV tuner preset data for the programme position is different from the data in the VCR tuner preset.
- If there is a tape with its safety tab in place in the VCR, the VCR automatically turns on and starts recording what you are watching on the TV when you press ● REC.
- You can turn the TV Direct Rec function ON and OFF in the OTHER OPTIONS menu (see page 73).

**Notes**

- You cannot record what you are watching using this method when the VCR is in the following modes : pause, timer standby, tuner preset, Auto Set Up, and recording.
- When the TV indicator is lit in the display window, do not turn off the TV nor change the TV programme position. When the TV indicator is not lit, the VCR continues recording the programme even if you change the TV programme position on the TV.

# Recording TV programmes using the ShowView system

The ShowView system is the feature that simplifies programming the VCR to make timer recording. Just enter the ShowView number listed in the TV programme guide. The date, times, and programme position of that programme are set automatically. You can preset up to eight programmes at a time.

## Before you start...

- Check that the VCR clock is set to the correct time and date.
- Insert a tape with its safety tab in place. Make sure the tape is longer than the total recording time.
- Turn on your TV and set it to the video channel.
- If you insert a tape with the SmartFile function, make sure the total recording time doesn't overlap the protected programme. For details about the SmartFile function, see page 78.
- Set TIMER OPTIONS to SHOWVIEW or VARY in the OTHER OPTIONS menu (see page 73).

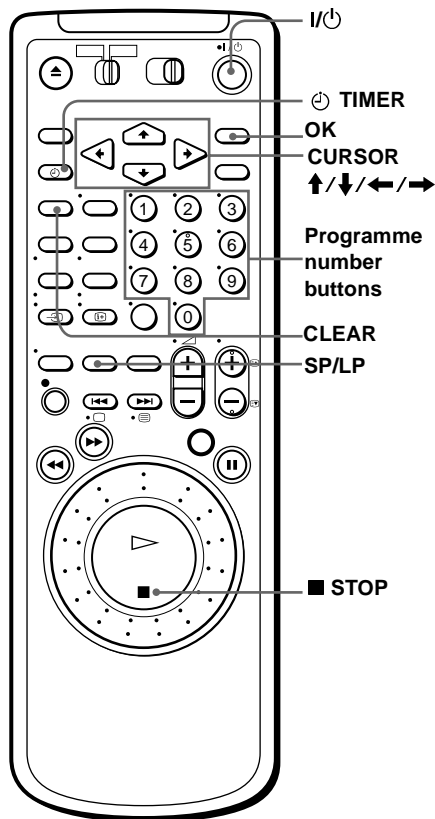

1

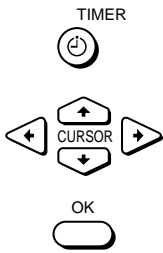

Press TIMER.

- When you set **TIMER OPTIONS** to **VARY**  
The **TIMER METHOD** menu appears on the TV screen. Press **CURSOR** to select **SHOWVIEW**, then press **OK**.

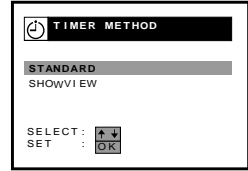

- When you set **TIMER OPTIONS** to **SHOWVIEW**  
The **SHOWVIEW** menu appears on the TV screen.

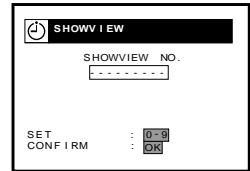

2

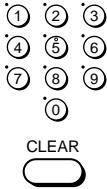

Press the programme number buttons to enter the ShowView number.

If you make a mistake, press **CLEAR** and re-enter the correct number.

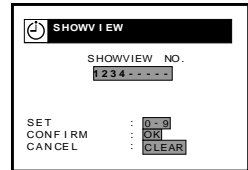

continued

## Recording TV programmes using the ShowView system (continued)

3

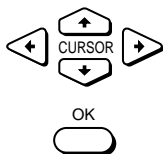

Press OK.

The date, start and stop times, programme position, tape speed, and VPS/PDC setting appear on the TV screen.

If “--” appears in the “PROG.” (programme) column (this may happen for local broadcasts), you have to set the appropriate programme position manually.

- To select a normal channel.  
Press CURSOR  $\uparrow/\downarrow$  to select the desired programme position.
- To select a video source from the LINE-1 (TV) or LINE-4 IN connector, or the LINE-2 IN or the LINE-3 jacks.  
Press INPUT SELECT to select the desired video source.

You will only have to do this operation once for the referred channel. The VCR will then store your setting.

For details of the VPS/PDC function, see “Timer recording with VPS/PDC signals” on page 55.



If the information is incorrect, press CLEAR to cancel the setting.

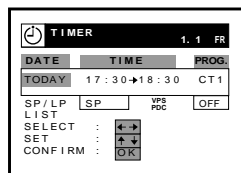

4

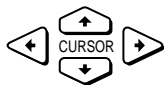

If you want to change the date, tape speed, and the VPS/PDC function setting:

1 Press CURSOR  $\leftarrow/\rightarrow$  to highlight the item you want to change.

2 Press CURSOR  $\uparrow/\downarrow$  to reset it.

- To record the same programme every day or the same day every week, see “Daily/weekly recording” on page 55.
- To use the VPS/PDC function, set VPS/PDC to ON. For details of the VPS/PDC function, see “Timer recording with VPS/PDC signals” on page 55.
- To change the setting, press MENU, and highlight LIST, then select TIMER LIST and press OK. To enter the timer setting and change it, press again OK.



If the informations are not correct, press CLEAR to cancel the settings.

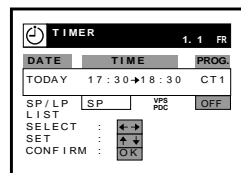

5



Press OK to confirm the setting.

6



Press I/⏻ to turn off the VCR.

The ⏻ indicator appears in the display window and the VCR stands by for recording.

### To stop recording

To stop the VCR while recording, press ■ STOP.

### Daily/weekly recording

In step 4 above, press CURSOR ↓ to select the recording pattern. Each time you press CURSOR ↓, the indication changes as shown below. Press CURSOR ↑ to change the indication in reverse order.

**TODAY** → **SU-SA (Sunday to Saturday)** → **MO-SA (Monday to Saturday)**  
 → **MO-FR (Monday to Friday)** → **SA (every Saturday) .....** → **MO (every Monday)** → **SU (every Sunday)** → **1 month later**  
 → **(dates count down)** → **TOMORROW** → **TODAY**

### Timer recording with VPS/PDC signals

Some broadcast systems transmit VPS (Video Programme System) or PDC (Programme Delivery Control) signals with their TV programmes. These signals ensure that your timer recordings are made regardless of broadcast delays, early starts, or broadcast interruptions (with the VPS or PDC indicator in the display window lit).

In step 4 above, press CURSOR ↑/↓ to turn on/off the VPS/PDC indication after you set the recording date. If you do not want to set the VPS/PDC function, turn off the VPS/PDC indication.

You can also use the VPS/PDC function for a source connected to the LINE-1 (TV) and LINE-4 IN (Scart) connectors, or the LINE-2 IN or LINE-3 IN jacks.

continued

### Recording TV programmes using the ShowView system (continued)

#### To use the VCR after setting the timer

To use the VCR before a timer recording begins, just press I/⏻. The ⏻ indicator turns off and the VCR switches on. Remember to press I/⏻ to reset the VCR after using the VCR.

You can also do the following tasks while the VCR is recording:

- Reset the counter.
- Display tape information on the TV screen.
- Check the timer settings see “Setting the timer manually” on page 57.
- Watch another TV programme.

#### Tips

- To set the programme position with a two digit number, press –/– (ten’s digit) button followed by the programme number button.
- To set the programme position, you can also use the PROG +/- or programme number buttons.
- To set the tape speed, you can also use the SP/LP button.
- When you are recording a programme in the SP mode and the remaining tape becomes shorter than the recording time, the tape speed is automatically changed to the LP mode. Note that some interference will appear on the picture at the point the tape speed is changed. If you want to keep the same tape speed, set AUTO LONG PLAY to OFF in the TAPE OPTIONS menu (see page 73).
- To check, change, or cancel the programme setting, press CURSOR ◀/▶ to choose LIST, then press OK after step 4. For details, see step 3 in “Checking/changing/cancelling timer settings” on page 64.

#### Notes

- When setting the timer with VPS/PDC signals, enter the start and stop times exactly as indicated in the TV programme guide, otherwise the VPS/PDC function won’t work and the recording won’t start.
- If the VPS/PDC signal is too weak or the broadcasting station failed to transmit VPS/PDC signals, the VCR will start recording at the set time without using the VPS/PDC function.
- The ⏻ indicator flashes in the display window when you press I/⏻ with no tape inserted.
- The VPS/PDC function is automatically set to OFF for the timer recording of a satellite programme.
- When you set TIMER OPTIONS to STANDARD in the OTHER OPTIONS menu, the SHOWVIEW menu does not appear on the TV screen. Select SHOWVIEW or VARY.



# Setting the timer manually

If the ShowView system is not available in your area, follow the instructions below to set the timer to record programmes.

## Before you start...

- Check that the VCR clock is set to the correct time and date.
- Insert a tape with its safety tab in place. Make sure the tape is longer than the total recording time.
- To record from a decoder, turn it on.
- Turn on your TV and set it to the video channel.
- If you insert a tape with the SmartFile function, make sure the total recording time doesn't overlap the protected programme. For details about the SmartFile function, see page 78.
- Set **TIMER OPTIONS** to **STANDARD** or **VARY** in the **OTHER OPTIONS** menu (see page 73).

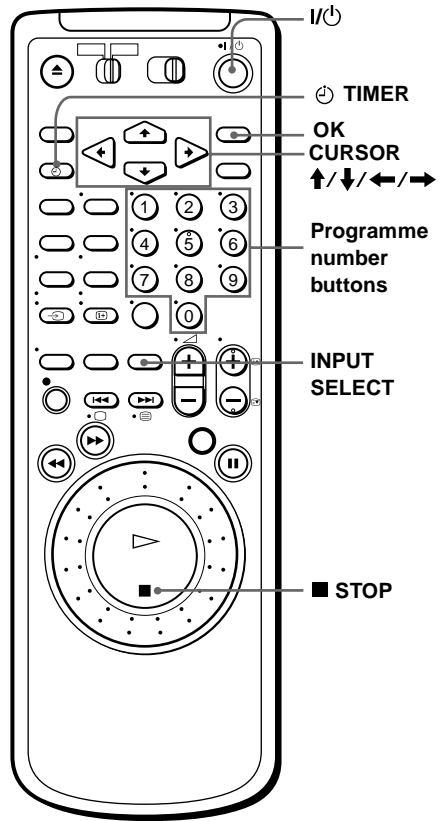

continued

## Setting the timer manually (continued)

1

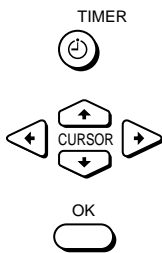

Press TIMER.

- When you set TIMER OPTIONS to VARY  
The TIMER METHOD menu appears on the TV screen. Press CURSOR /  
 to select STANDARD, then press OK.

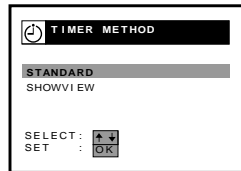

- When you set TIMER OPTIONS to STANDARD  
The TIMER menu appears on the TV screen.

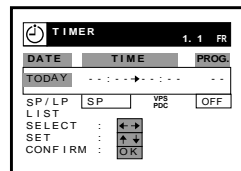

2

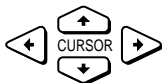

Set the date, start and stop times, programme position, tape speed, and VPS/PDC function:

- Press CURSOR to highlight each item in turn.
- Press CURSOR to set each item.

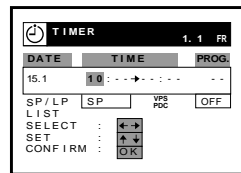

To correct a setting, press CURSOR to return to that setting and reset.

- To record the same programme every day or the same day every week, see “Daily/weekly recording” on page 59.
- To use the VPS/PDC function, set VPS/PDC to ON. For details of the VPS/PDC function, see “Timer recording with VPS/PDC signals” on page 55.
- To record from a decoder or other source connected to the LINE-1 (TV) or LINE-4 IN connectors, the LINE-2 IN or the LINE-3 IN jacks, press INPUT SELECT to display “L1,” “L2,” “L3” or “L4” in the “PROG.” position.



3



Press OK to confirm the setting.

## 4



Press I/⏏ to turn off the VCR.

The ⏏ indicator appears in the display window and the VCR stands by for recording.

To record from a decoder or other sources, leave the connected equipment switched on.

### To stop recording

To stop the VCR while recording, press ■ STOP.

### Daily/weekly recording

In step 2 above, press CURSOR ↓ to select the recording pattern. Each time you press CURSOR ↓, the indication changes as shown below. Press CURSOR ↑ to change the indication in reverse order.

**TODAY → SU-SA (Sunday to Saturday) → MO-SA (Monday to Saturday) → MO-FR (Monday to Friday) → SA (every Saturday) ..... → MO (every Monday) → SU (every Sunday) → 1 month later → (dates count down) → TOMORROW → TODAY**

### Tips

- To set the programme position, you can also use the PROG +/- or programme number buttons.
- To set the tape speed, you can also use the SP/LP button.
- When you are recording a programme in the SP mode and the remaining tape becomes shorter than the recording time, the tape speed is automatically changed to the LP mode. Note that some interference will appear on the picture at the point the tape speed is changed. If you want to keep the same tape speed, set AUTO LONG PLAY to OFF in the TAPE OPTIONS menu (see page 73).
- Even if you set TIMER OPTIONS to SHOWVIEW in the OTHER OPTIONS menu, you can set the timer manually. Press MENU to select TIMER, then go to step 2.

### Notes

- When setting the timer with VPS/PDC signals, enter the start and stop times exactly as indicated in the TV programme guide, otherwise the VPS/PDC function won't work and the recording won't start.
- If the VPS/PDC signal is too weak or the broadcasting station failed to transmit VPS/PDC signals, the VCR will start recording at the set time without using the VPS/PDC function.
- The ⏏ indicator flashes in the display window when you press I/⏏ with no tape inserted.

# Playing/searching at various speeds

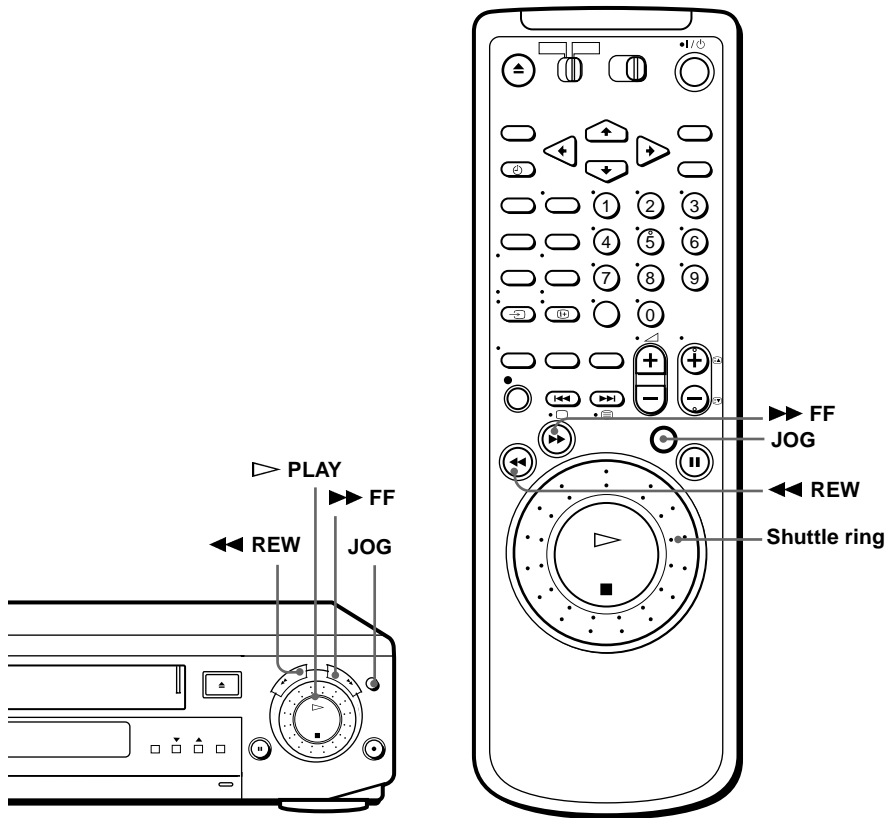

Playback options	Operation
Fast-forward or rewind	During stop, press ►►FF or ◀◀REW.
View the picture during fast-forward or rewind	During fast-forward, hold ►►FF down. During rewind, hold ◀◀REW down.
Rewind and start play	During stop, hold ◀◀REW down <u>on the VCR</u> and press ▷ PLAY <u>on the VCR</u> then release both.

### To resume normal playback

Press ▷ PLAY.

## Using the shuttle ring

With the shuttle ring, you can operate a variety of playback options. There are two ways for using the shuttle ring, normal mode and jog mode.

### To use the shuttle ring in normal mode

During playback or pause, turn the shuttle ring clockwise or anticlockwise. Each change in the shuttle ring position changes the playback mode, and the corresponding mark appears on the TV screen for a few seconds in the following way if the on-screen display function is on :

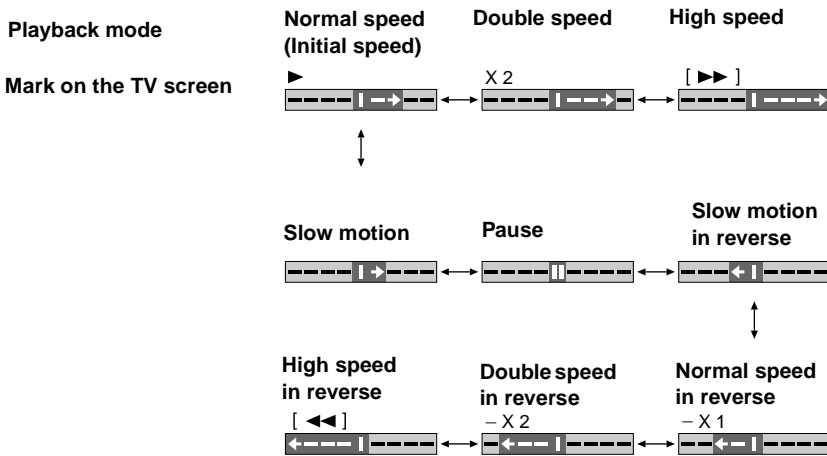

### To use the shuttle ring in jog mode

Use this mode for frame-by-frame playback.

Press JOG to enter the jog mode. The JOG button lights up. If you change to the jog mode during any playback mode, the playback pauses so you can see a still picture. Each change in the shuttle ring position shifts the picture one frame. To shift frames in reverse, turn the shuttle ring anticlockwise. The frame shift speed depends on the speed you turn the shuttle ring. To resume normal mode, press JOG again. The JOG button goes off.

continued

### Playing/searching at various speeds (continued)

#### Tip

- Adjust the picture using the TRACKING +/- buttons if:
  - Streaks appear while playing in slow motion.
  - Bands appear at the top or bottom while pausing.
  - The picture shakes while pausing.To set tracking to the centre position, press both buttons (+/-) at the same time.

#### Notes

- The playback sound is muted during the operations in the above table.
- In the LP mode, noise may appear or there may be no colour.
- If the playback mode mark doesn't appear on the TV screen, press  DISPLAY.

# Setting the recording duration time

After starting recording in the normal way, you can have the VCR stop recording automatically after a specified duration.

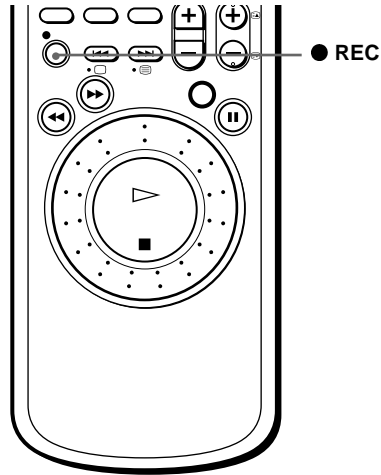

- 1 While recording, press ● REC.  
The ⌚ indicator appears in the display window.

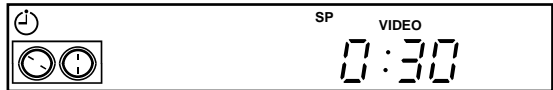

- 2 Press ● REC repeatedly to set the duration.  
Each press advances the time in increments of 30 minutes.

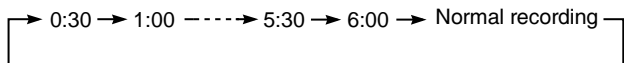

The tape counter decreases minute by minute to 0:00, then the VCR stops recording and turns off automatically.

## To extend the duration

Press ● REC repeatedly to set a new duration.

## To cancel the duration

Press ● REC repeatedly until the ⌚ indicator disappears and the VCR returns to normal recording mode.

## To stop recording

To stop the VCR while recording, press ■ STOP.

## Note

- You cannot display the current tape time in the display window when setting the recording duration.

# Checking/changing/cancelling timer settings

## Before you start...

- Turn on your TV and set it to the video channel.

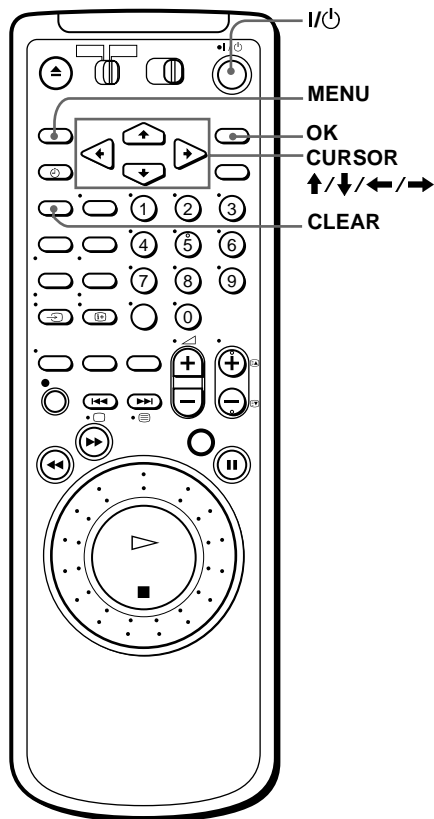

- 1 Press I/Power to turn on the VCR.
- 2 Press MENU, then press CURSOR ↑/↓ to highlight LISTS and press OK.
- 3 Press CURSOR ↑/↓ to highlight TIMER LIST, then press OK:

- If you want to change or cancel a setting, go on to the next step.
- If you do not need to change or cancel the settings, press MENU, then turn off the VCR to return to recording standby.

DATE	TIME	PROG.	SP.	W.D.
TH	19:00→20:00	12	SP	SU
TOMORROW	09:30→10:30	35	SP	
4. 1	00:00→01:30	44	LP	
MO - FR	23:00→00:00	L1	LP	
SU - SA	12:12→13:13	L2	SP	
- - -	- - -	- -	- -	- -
- - -	- - -	- -	- -	- -
- - -	- - -	- -	- -	- -



- 4** Press CURSOR  $\uparrow/\downarrow$  to select the setting you want to change or cancel, then press OK.

The selected setting appears in the TIMER menu.

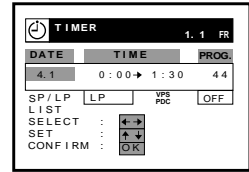

- 5**
- To change the setting, press CURSOR  $\leftarrow/\rightarrow$  to highlight the item you want to change, and press CURSOR  $\uparrow/\downarrow$  to reset it.
  - To cancel the setting, press CLEAR.

- 6** Press MENU.

If any settings remain, turn off the VCR to return to recording standby.

### When the timer settings overlap

The programme that starts first has priority and the second programme starts recording only after the first programme has finished. If the programmes start at the same time, the programme listed first in the menu has priority.

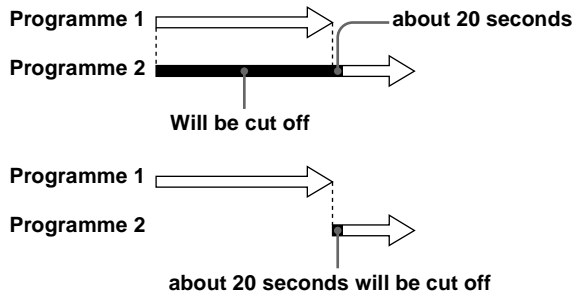

### Tip

- In step 5 above, you can check the TIMER LIST by selecting LIST and pressing OK. Press MENU to exit the TIMER LIST.

# Recording stereo and bilingual programmes

## In ZWEITON (German stereo) system

This VCR automatically receives and records stereo and bilingual programmes based on the ZWEITON system. When a stereo or bilingual programme is received, the STEREO indicator appears in the display window.

### To select bilingual sound while recording

Press AUDIO MONITOR to select the sound you want.

To listen to	On-screen display	Display window
Main	MAIN	STEREO
Sub	SUB	STEREO
Main and sub	MAIN/SUB	STEREO

## In NICAM system

This VCR receives and records stereo and bilingual programmes based on the NICAM system (the NICAM indicator appears). When a stereo or bilingual programme is received, the STEREO indicator appears in the display window.

To record a NICAM programme, HIFI AUDIO in the AUDIO OPTIONS menu should be set to NICAM (initial setting). To check the menu setting, see page 72 for details.

### To select the sound while recording

Press AUDIO MONITOR to select the sound you want.

### Stereo programme

To listen to	On-screen display	Display window
Stereo	STEREO	STEREO
Standard sound*	No indicator	No indicator

\* Usually the mixed sound of left and right channels (monaural)

## Bilingual programme

To listen to	On-screen display	Display window
Main	MAIN	STEREO
Sub	SUB	STEREO
Main and sub	MAIN/SUB	STEREO
Standard sound*	No indicator	No indicator

\* Usually the main sound (monaural)

## Selecting the sound during playback

Press AUDIO MONITOR to select the sound you want.

To listen to	On-screen display	Display window
Stereo/main and sub (left and right channels)	STEREO	STEREO
Left channel/main	LCH	STEREO
Right channel/sub	RCH	STEREO
Standard sound	No indicator	No indicator

## How sound is recorded on a video tape

The VCR records sound onto two separate tracks. Hi-fi audio is recorded onto the main track along with the picture. Monaural sound is recorded onto the normal audio track along the edge of the tape.

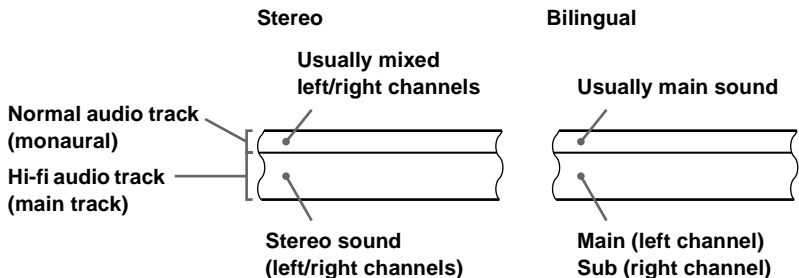

### Notes

- To listen to playback sounds in stereo, you must use the EURO-AV or AUDIO OUT connections.
- When you play a tape recorded in monaural, the sound is heard in monaural regardless of the AUDIO MONITOR setting.
- If the AUDIO MONITOR button does not function, check that AUDIO MIX in the AUDIO OPTIONS menu is set to OFF (see page 72).
- If HIFI AUDIO is set to STANDARD, the standard sound will be recorded on both the hi-fi and normal audio tracks. Pressing AUDIO MONITOR will not change the sound .

# Searching using the index function

The VCR marks the tape with an index signal at the point where each recording begins. Use these signals as references to find a specific recording. The VCR can search up to 99 index signals ahead or behind the current position.

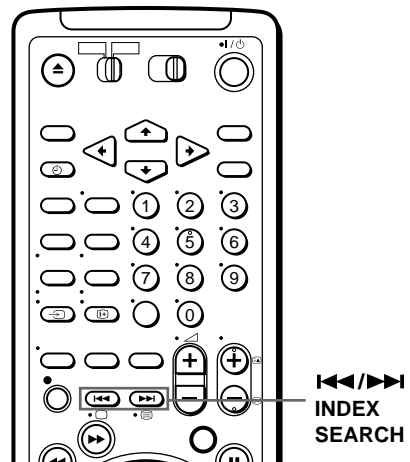

- 1 Insert an indexed tape into the VCR.
- 2 Press ◀◀/▶▶ INDEX SEARCH repeatedly to specify how many index signals ahead or behind you want to search :
  - To search ahead, press ▶▶ INDEX SEARCH.
  - To search backwards, press ◀◀ INDEX SEARCH.

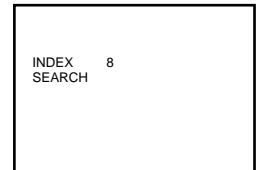

The VCR starts searching and the index number on the TV screen counts down to zero. Playback starts automatically from that point.

### To stop searching

Press ■ STOP.

### Note

- No index signal will be added when recording starts from recording pause. However, an index signal will be marked if you change the programme position during recording pause.

# Adjusting the picture

## Adjusting the tracking

Although the VCR automatically adjusts the tracking when playing a tape (the  indicator flashes in the display window, then goes off), distortion may occur if the tape was recorded in poor condition. In this case, manually adjust the tracking.

During playback, press TRACKING +/- to display the tracking meter. The distortion should disappear as you press one of the two buttons (the  indicator lights up). To resume automatic tracking adjustments, eject the tape and re-insert it.

To set the tracking to the centre position, press TRACKING + and - buttons at the same time.

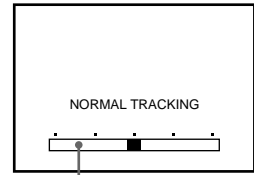

Tracking meter

## About the Reality Regenerator (RR) function

The Reality Regenerator (RR) function automatically restores the picture to its original quality during playback.

To use the RR function, press REALITY REGENERATOR. The REALITY REGENERATOR indicator lights up. You can set RR to HIGH or NORMAL in the VIDEO OPTIONS menu (see page 71).

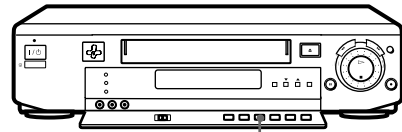

REALITY REGENERATOR

To turn it off, press REALITY REGENERATOR. The REALITY REGENERATOR indicator lights off.

## About the Optimum Picture Control (OPC) function

The Optimum Picture Control (OPC) function automatically improves recording and playback quality by adjusting the VCR to the condition of the video heads and tape. To maintain better picture quality, we recommend that you set OPC to ON in the VIDEO OPTIONS menu (with the OPC indicator in the display window lit). For details, see page 71.

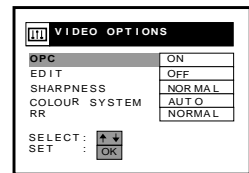

## OPC playback

The OPC function automatically works on all types of tapes, including rental tapes and tapes that were not recorded with OPC.

continued

### Adjusting the picture (continued)

#### OPC recording

Whenever you insert a tape and start recording for the first time, the VCR adjusts to the tape using the OPC function (the OPC indicator flashes rapidly). This adjustment is retained until the tape is ejected.

#### To deactivate the OPC function

Set OPC to OFF in the VIDEO OPTIONS menu. The OPC indicator in the display window goes off.

#### About the Digital Noise Reduction (DNR) function

Digital Noise Reduction (DNR) automatically improves playback quality by the digital signal process. To obtain better quality, we recommend you to activate the DNR function by pressing the DNR button on the VCR (the DNR indicator lights up on the VCR).

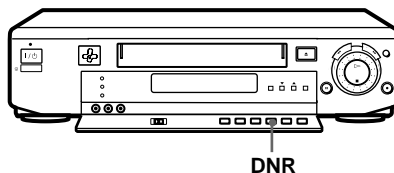

#### Notes

- You can adjust the tracking for the NTSC-recorded tape but the tracking meter won't be displayed.
- With the Auto Long Play function on, the OPC function will work only in SP mode. If the tape speed automatically switches from SP to LP, the OPC function turns off. However, if the entire programme is recorded in LP mode, the OPC function will work.
- There is a delay of about ten seconds before the VCR actually starts recording while the VCR analyses the tape. To avoid the delay, first set the VCR to recording pause (the OPC indicator flashes slowly) and press ● REC to have the VCR analyse the tape (the OPC indicator flashes rapidly). After the OPC indicator stops flashing, press ■ PAUSE to start recording immediately. If you want to start recording quickly without using the OPC function, first set the VCR to recording pause (the OPC indicator flashes slowly) and press ■ PAUSE to start recording.

# Changing menu options

- 1 Press MENU, then select OPTIONS and press OK.

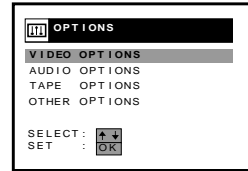

- 2 Press CURSOR  $\uparrow/\downarrow$  to highlight the kind of option to change, VIDEO OPTIONS, AUDIO OPTIONS, TAPE OPTIONS or OTHER OPTIONS then press OK.
- 3 Press CURSOR  $\uparrow/\downarrow$  to select the option, then press OK to enter the pop up menu.
- 4 Press CURSOR  $\uparrow/\downarrow$  to select the desired setting, then press OK.
- 5 Press MENU to exit the menu.

## VIDEO OPTIONS menu

Initial settings are indicated in bold print.

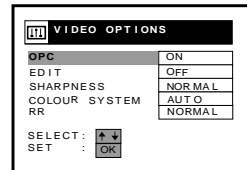

Menu option	Set this option to
OPC	<ul style="list-style-type: none"> <li>• <b>ON</b> to switch on the OPC (Optimum Picture Control) function and improve picture quality.</li> <li>• OFF to switch off OPC.</li> </ul>
EDIT	<ul style="list-style-type: none"> <li>• ON to minimize picture deterioration when editing.</li> <li>• <b>OFF</b> to turn off EDIT.</li> </ul>
SHARPNESS	<ul style="list-style-type: none"> <li>• LOW to playback a poor quality tape.</li> <li>• <b>NORMAL</b> to playback an average quality tape.</li> <li>• HIGH to playback a good quality tape.</li> </ul>
COLOUR SYSTEM	<ul style="list-style-type: none"> <li>• <b>AUTO</b> to detect automatically the colour system of a tape.</li> <li>• PAL to playback a tape recorded in the PAL system.</li> <li>• MESECAM to playback a tape recorded in the MESECAM system.</li> </ul>
RR	<ul style="list-style-type: none"> <li>• <b>NORMAL</b> for normal everyday use.</li> <li>• HIGH for well-used video tapes such as rented tapes. Select this option when NORMAL does not improve the picture quality.</li> </ul> <p>For details, see page 69.</p>

**continued**

## Changing menu options (continued)

### Note

- When you playback with the EDIT function ON, the OPC and the SHARPNESS functions don't work.

### AUDIO OPTIONS menu

Initial settings are indicated in bold print.

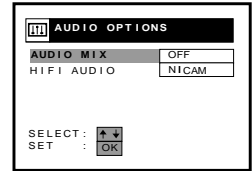

Menu option	Set this option to
AUDIO MIX	<ul style="list-style-type: none"> <li>• ON to listen to the hi-fi and normal audio tracks at the same time. The AUDIO MONITOR button will not function.</li> <li>• <b>OFF</b> to listen to the hi-fi and normal audio tracks separately. Select the sound using the AUDIO MONITOR button For details, see page 66.</li> </ul>
HIFI AUDIO	<ul style="list-style-type: none"> <li>• STD to record standard sound on the hi-fi audio track.</li> <li>• <b>NICAM</b> to record NICAM broadcasts on the hi-fi audio track. For details, see page 66.</li> </ul>

### TAPE OPTIONS menu

Initial settings are indicated in bold print.

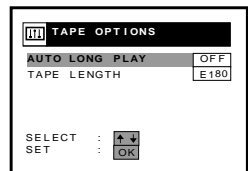





Menu option	Set this option to
AUTO LONG PLAY	<ul style="list-style-type: none"> <li>• ON to automatically record from SP (Standard Play) to LP (Long Play) when the tape length is not long enough.</li> <li>• <b>OFF</b> to normally record in SP (Standard Play).</li> </ul>
TAPE LENGTH	<ul style="list-style-type: none"> <li>• <b>E180</b> to use an E-180 or shorter tape type.</li> <li>• E195 to use an E-195.</li> <li>• E240 to use an E-240.</li> <li>• E300 to use an E-300.</li> </ul>

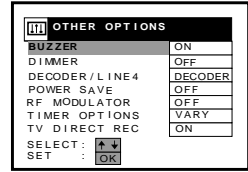

**OTHER OPTIONS menu**

Initial settings are indicated in bold print.



Menu option	Set this option to
BUZZER	<ul style="list-style-type: none"> <li>• <b>ON</b> to output a beep sound.</li> <li>• <b>OFF</b> to deactivate it.</li> </ul>
DIMMER	<ul style="list-style-type: none"> <li>• <b>ON</b> to make the display window dim.</li> <li>• <b>OFF</b> to make it brighter.</li> </ul>
DECODER/LINE4	<ul style="list-style-type: none"> <li>• <b>DECODER</b> to use the DECODER/LINE-4 IN connector as the PAY-TV/Canal Plus decoder connector.</li> <li>• <b>LINE4</b> to use the DECODER/LINE-4 IN connector as the line input connector.</li> </ul>
POWER SAVE	<ul style="list-style-type: none"> <li>• <b>ON</b> to turn off the indicators in the display window to save the VCR power.</li> <li>• <b>OFF</b> to turn on the indicators in the display window while the VCR is standing by.</li> </ul>
RF MODULATOR	<ul style="list-style-type: none"> <li>• <b>ON</b> if you connect the VCR to your TV using only the aerial cable.</li> <li>• <b>OFF</b> if you connect the VCR to your TV using the EURO-AV cable.</li> </ul>
TIMER OPTIONS	<ul style="list-style-type: none"> <li>• <b>VARY (variable)</b> to display the TIMER METHOD menu for selecting STANDARD or SHOWVIEW when pressing the  TIMER button.</li> <li>• <b>STANDARD</b> to display the TIMER menu when pressing the  TIMER button.</li> <li>• <b>SHOWVIEW</b> to display the SHOWVIEW menu when pressing the  TIMER button.</li> </ul> <p>For details, see page 52 and 57.</p>
TV DIRECT REC	<ul style="list-style-type: none"> <li>• <b>ON</b> to activate the TV Direct Rec function.</li> <li>• <b>OFF</b> to deactivate it.</li> </ul>

**Note**

- When you set a timer recording, the indicators in the display window remain on, even though POWER SAVE is set to ON.

# Editing with another VCR or stereo system

## How to connect to record on this VCR

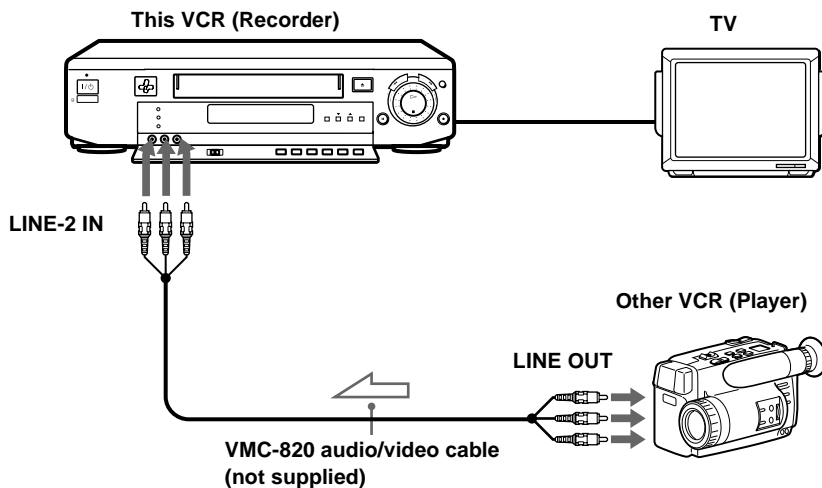

 : Signal flow

### Tip

- You can also use the LINE-4 IN connector or the LINE-3 IN jacks instead.

### Notes

- Make sure you connect the plugs to jacks of the same colour.
- If the other VCR is a monaural type, leave the red plugs unconnected.
- If you connect this VCR to both the LINE IN and LINE OUT jacks of the other VCR, select the input correctly to prevent a humming noise.

## How to connect to a stereo system

Connect the LINE-2 IN AUDIO L/R jacks on this VCR to the audio output jacks on the stereo system, using the RK-C510KS audio cable (not supplied).

## Operation (when recording on this VCR)

### Before you start editing

- Turn on your TV and set it to the video channel. Press INPUT SELECT to display “L2” (or “L3” or “L4”) in the display window.
- Press SP/LP to select the tape speed, SP or LP.
- On this VCR, set EDIT to ON in the VIDEO OPTIONS menu to display “EDIT” in the display window. If the other VCR has a similar feature, activate this one as well.

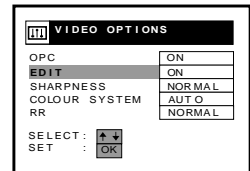
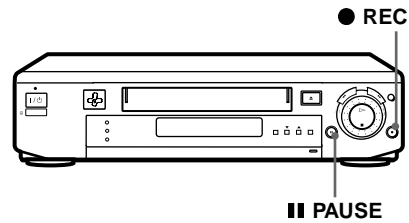

- 1 Insert a source tape with its safety tab removed into the other (playback) VCR. Search for the point to start playback and set it to playback pause.
- 2 Insert a tape with its safety tab in place into this (recording) VCR. Search for the point to start recording and press **|| PAUSE**.
- 3 Press **● REC** on this VCR to set it to recording pause.
- 4 To start editing, press the **|| PAUSE** buttons on both VCRs at the same time.

### To stop editing

Press the **■ STOP** buttons on both VCRs.

### Tip

- To cut out unwanted scenes while editing, press **|| PAUSE** on this VCR when an unwanted scene begins. When it ends, press **|| PAUSE** again to resume recording.

### Note

- If you start editing following the procedure above, the VCR won't start recording with the OPC function. To record a tape with the OPC function, press **● REC** again during recording pause in step 3 so the VCR analyses the tape. Then, when you start editing in step 4, press **|| PAUSE** after the OPC indicator stops flashing. If you press **|| PAUSE** before the OPC indicator stops flashing, the OPC function is cancelled.

# Audio dubbing

This feature lets you record over the normal audio track. The monaural sound previously recorded is replaced while the original hi-fi sound remains unchanged. Use this feature to add commentary to a tape that you have recorded with a camcorder.

## Before you start...

- Turn on the TV and set it to the video channel

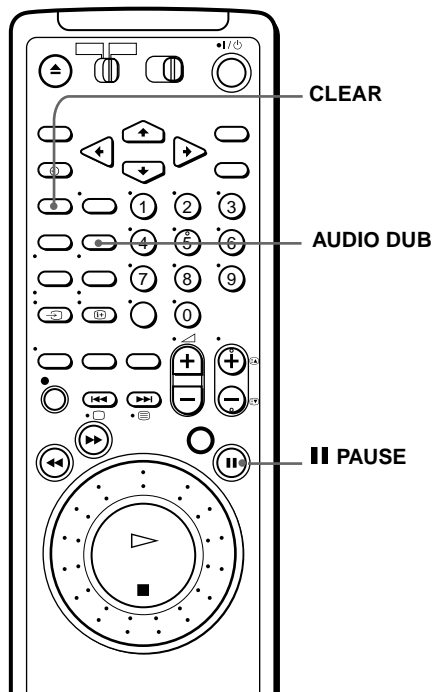

- 1 Insert a source tape into the stereo system (or the playback VCR). Search for the point to start playback and set it to playback pause.
- 2 Insert a prerecorded tape with its safety tab in place into this (recording) VCR. Search for the end of the section to be replaced and press **|| PAUSE**.
- 3 Press **CLEAR** to reset the counter to "0H00M00S."
- 4 Rewind the prerecorded tape to the beginning of the section to be replaced. The VCR enters pause mode.
- 5 Press **AUDIO DUB**. The  $\ominus$  indicator appears in the display window.
- 6 To start editing, press the **|| PAUSE** buttons on this VCR and the stereo system (or other VCR) at the same time. When the counter reaches "0H00M00S," audio dubbing stops automatically.

## To stop while editing

Press **■ STOP** on this VCR and the stereo system (or other VCR).

**Note**

- After you use this feature, the audio in playback mode is automatically set to monaural.

**To listen to both the hi-fi and normal audio**

Set AUDIO MIX to ON in the AUDIO OPTIONS menu (see page 72). Use this feature to listen to dubbed audio over the original hi-fi audio. When AUDIO MIX is set to ON, the AUDIO MONITOR button does not function. Note that by mixing both hi-fi and normal audio, some echo may appear.

# About the SmartFile function

SmartFile\* allows you to view a contents of your video tape (recording date, channel, name etc.) on the TV screen. It is no longer necessary to rewind, fast-forward, or playback a tape to find out what is recorded. You can also locate and start playback of a specific programme or find the position from which you want to start recording by using this list. Programme data is stored in the memory of the SmartFile label attached to the tape.

The following functions are possible using SmartFile :

## Recording using the SmartFile function (page 80)

To use the SmartFile function, attach the SmartFile label to the tape. If you record a programme on the tape with a SmartFile label, the contents will appear on the SmartFile search list. With the SmartFile list, you can also easily find the beginning of the available recording space.

### SmartFile search list

10.6.98-5.2.99	P.1
BLANK TIME	SP 1H30M
5.2.FR 0:00	PROG.16
	LP 0H30M
25.1.MO 16:30	PROG.30
	LP 2H00M
11.1.MO 17:00	CT1
	LP 0H30M
START	END
SELECT	↑ ↓
SEARCH	OK

## Selecting and playing a programme (page 85)

To playback a recorded programme, select the programme you want to watch using the SmartFile search list. The VCR locates the programme and playback starts automatically.

## Checking the contents of a tape (page 86)

When you bring the SmartFile label close to the SMARTFILE sensor on the VCR, a summary of the recorded programmes appears in the SmartFile check list. It is not necessary to insert the tape into the VCR and press ▷ PLAY to find out what is recorded on it. This feature allows you to easily find the programme you want to watch, or to quickly find a tape with enough recording space.

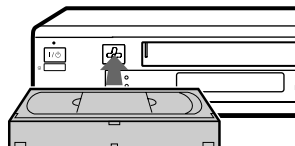

### SmartFile check list

10.6.98-5.2.99	P.1
BLANK TIME	SP 1H30M
5.2.FR 0:00	PROG.16
25.1.MO 16:30	PROG.30
11.1.MO 17:00	CT1
31.12	BEST OF THIS YEAR
10.12	TH 21:00 CT2
2.12	WE 5:00 L1
NEXT	↓
EXIT	OK

\*.SmartFile is a trademark of Sony Corporation.

## Labelling a recorded programme and tape (page 88)

You can attach an electronic "label" to the video tape and its programmes on the SmartFile list. Labelling the recorded programmes enables you to find a programme easily when you want to play it back. If TV guide pages are available in the Teletext, labelling recorded programmes is done automatically. Also, once you label a programme which you set to record regularly (i.e everyday, same day of the week, etc.), the VCR recognizes the label and will automatically label all future recordings of the same programme.

## Registering the contents of a recorded tape in the SmartFile label (page 96)

You can register programmes recorded on a tape in the memory of a new SmartFile label.

## Protecting a recorded programme (page 98)

You can protect a recorded programme from accidental over-recording or erasure.

## Erasing the data of an unwanted programme (page 100)

By erasing a programme from the SmartFile list, the VCR will record over the unwanted programme.

## Running a demonstration

This VCR can give a demonstration of the various SmartFile functions.

To run a demonstration, turn on the VCR and hold the SMARTFILE button for 3 seconds while no tape is inserted. The VCR outputs a beep and the message "No SmartFile" appears on the TV screen. The demonstration begins. To stop the demonstration, press any key.

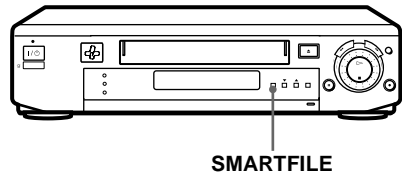

# Recording using the SmartFile function

To use the SmartFile function, attach the SmartFile label to the spine of the cassette. If you record a programme on a tape with a SmartFile label, for more than 20 minutes in LP mode and 11 minutes in SP mode, programme data, such as the name, date and channel, is automatically stored in the memory of the SmartFile label. Some stations may not offer this service.

## Attaching the SmartFile label to the cassette

To use the SmartFile function, attach the supplied SmartFile label to the cassette. Remove any stains or dirt from the surface of the spine of the tape. Then, holding both edges of the SmartFile label so that it doesn't bend, attach it along the guide line to the spine of the cassette. This tape is henceforth referred to as a SmartFile tape.

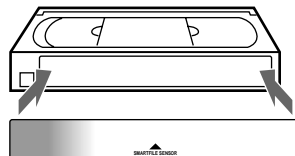

## Note on the purchase of SmartFile labels

- If you want to order additional SmartFile labels, contact your nearest Sony service facility.

## Notes

- The SmartFile label is equipped with a memory chip. The memory chip may be damaged and cannot be used when you:
  - twist or fold the SmartFile label.
  - remove the SmartFile label and re-attach it to a tape.
  - attach more than one SmartFile label to a tape.
  - attach some metal, or sticker which has metal, to the SmartFile label.
  - write too strongly on the SmartFile label using a ballpoint pen or similar sharp instrument.
  - disassemble or remodel a label.
- Do not leave the SmartFile label in a place subject to excessive dust or dirt, direct sunlight, humidity, mildew, strong magnetism or near heat sources.
- If you attach the SmartFile label to a shorter tape than an E-30, the SmartFile function may not work correctly.



## Recording a programme on the SmartFile tape

When recording a programme on the SmartFile tape, no matter what method you use to record the programme (normal recording, showview recording, etc.), programme data (date, name, channel, recording start time, etc.) is stored in the memory of the SmartFile label. The SmartFile label can contain up to 12 programmes' data. When the number of the stored programmes goes over 12, the oldest programme data is erased from the SmartFile list. However, a programme which lasts less than about 20 minutes in LP mode or about 11 minutes in SP mode cannot be stored in the memory. When you record a programme on the SmartFile tape which already contains programme data, see "Recording after locating the Blank Time space" on page 83.

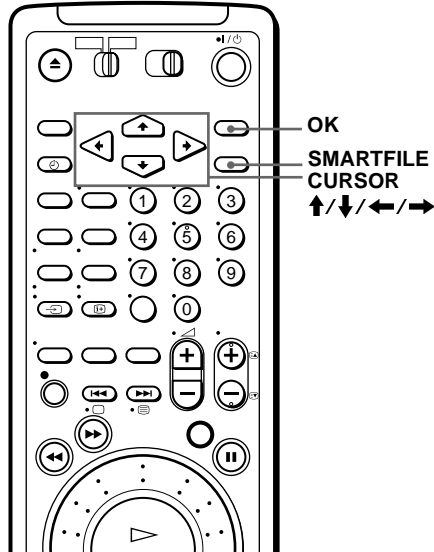

### Before you start...

- Turn on your TV and set it to the video channel
- Check that the VCR clock is set to the correct time and date.

**1** Insert a SmartFile tape with its safety tab in place.

**2** Press SMARTFILE.  
The SmartFile search list appears on the TV screen.

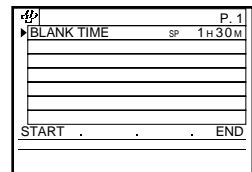

**3** Use CURSOR  $\uparrow/\downarrow$  to select BLANK TIME, press OK. The VCR starts searching for the longest blank part of the tape. The SmartFile searchlist disappears.

You can now start recording a programme.

### Tip

- You can protect a recorded programme from accidental over-recording or erasure (see page 98).

### Note

- If you press the PAUSE button one or more times during recording, thereby creating short lengths of recorded time between such pauses, programme data may not be stored in the SmartFile label.

**continued**

## Recording using the SmartFile function (continued)

### Checking the information of a recorded programme

Press SMARTFILE. The SmartFile search list appears. The recording day of the week, start time, programme position, date, name, recording time and tape speed appear on the list. The longest space which doesn't have any programme data (Blank Time space) appears as "BLANK TIME":

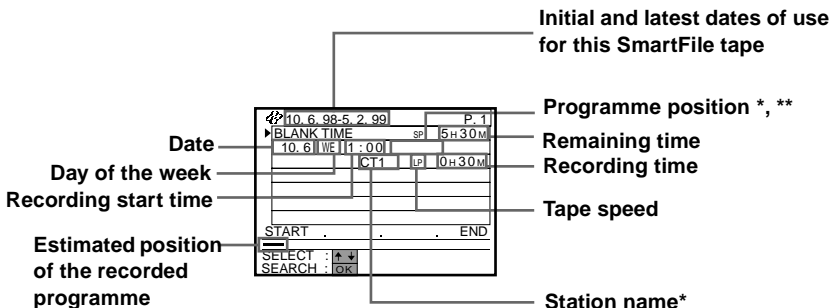

\* When the station name is not available, the programme position is displayed instead.

\*\* If you record a satellite programme using non-timer recording "L4" appears in the programme position without displaying any channel number.

### Tip

- You can manually name a recorded programme and select the category. You can also name the SmartFile tape.

### Notes

- If you don't set the clock or the clock isn't set to the correct time and date, the recording start time won't be stored correctly on the Smartfile list. Also the programme label won't be stored correctly if the TV guide page information of the Teletext is not set correctly (see page 80).
- When you set the AUTO LONG PLAY option to ON in the TAPE OPTIONS menu, and the tape speed automatically changes from SP to LP during recording, the VCR displays the entire recording time converted in SP mode to the SmartFile list.
- The recording time length in the SmartFile list is an estimation and may be slightly different from the actual recorded time length.

## Recording after locating the Blank Time space

The SmartFile function identifies not only the largest amount of available blank space, but also recorded material that doesn't have corresponding programme data stored in the SmartFile label. The longest available recording space (including programmes that are not stored on the SmartFile label) is referred to as "Blank Time space". You can locate the beginning of the Blank Time space for recording. If there is a recorded programme after the Blank Time space, the VCR will over-record on that programme unless you stop recording. If there is a programme you want to prevent from being recorded over or erased, protect that programme before you start recording another programme (see page 98).

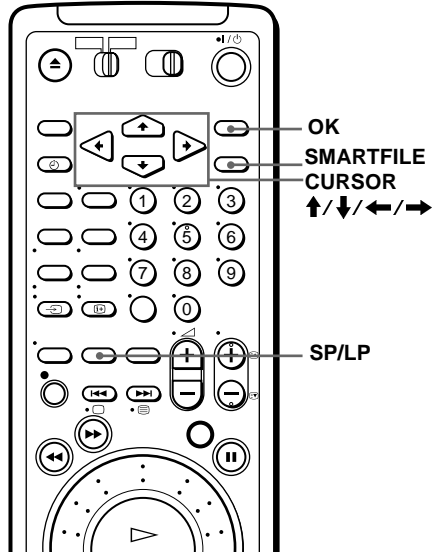

### Before you start...

- Turn on your TV and set it to the video channel.

**1** Insert a SmartFile tape with its safety tab in place.  
The SMARTFILE indicator lights up on the VCR.

**2** Press SMARTFILE.  
The SmartFile search list appears on the TV screen. The Blank Time space appears in the "BLANK TIME" row.

The Blank Time space also appears in the display window.

10. 6. 98-5. 2. 99	P. 1
▶ BLANK TIME	SP 1H30M
5. 2 FR 0: 00 PROG. 16	LP 0H30M
25. 1 MO 16: 30 PROG. 30	LP 2H00M
11. 1 MO 17: 00	LP 0H30M
CT1	LP 0H30M
START	END
SELECT : ↑ ↓	
SEARCH : OK	

**3** Press CURSOR ↑ repeatedly to select BLANK TIME.

**4** Press SP/LP to select the tape speed, SP or LP.

The BLANK TIME changes according to the selected tape speed. Select a tape speed that matches the length of the programme you want to record.

10. 6. 98-5. 2. 99	P. 1
▶ BLANK TIME	LP 3H00M
5. 2 FR 0: 00 PROG. 16	LP 0H30M
25. 1 MO 16: 30 PROG. 30	LP 2H00M
11. 1 MO 17: 00	LP 0H30M
CT1	LP 0H30M
START	END
SELECT : ↑ ↓	
SEARCH : OK	

**continued**

## Recording using the SmartFile function (continued)

- 5** Press OK.  
The VCR goes to the beginning of the Blank Time space and stops.



- 6** Press PROG +/- to select the programme position you want to record.
- 7** Press ● REC to start recording.

### Notes

- You may not be able to locate the beginning of the Blank Time space correctly in the above step 4 when :
  - the SmartFile tape contains one or more short length (less than about 20 minutes in the LP mode and about 11 minutes in the SP mode) recorded programmes of which programme data are not stored in the SmartFile label.
  - the SmartFile tape is damaged or dirty.
  - the SmartFile tape has a portion recorded in the NTSC system.
- If a newly recorded programme overlaps a stored programme, the stored programme information is erased from the SmartFile list as shown below when :
  - the remaining length of the stored programme becomes less than about 20 minutes in the LP mode and about 11 minutes in the SP mode.
  - the stored programme is over-recorded for more than 20 minutes in the LP mode and about 11 minutes in the SP mode.

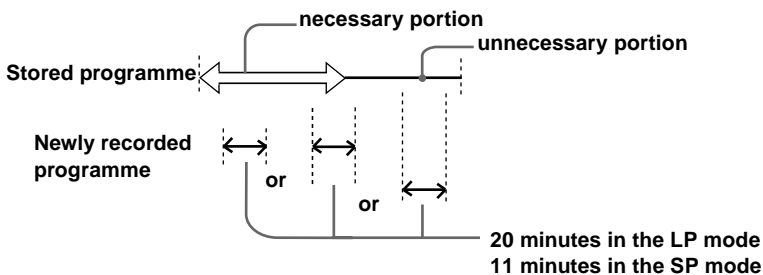

# Selecting and playing a programme

You can automatically locate and start playback of a programme recorded on the SmartFile tape. Select a programme in the SmartFile search list. The SmartFile search list can contain up to 12 programmes.

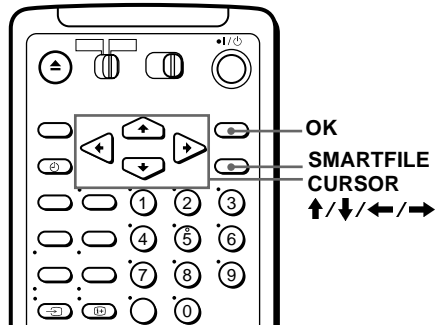

## Before you start...

- Turn on your TV and set it to the video channel.

**1** Insert a SmartFile tape.  
The SMARTFILE indicator lights up on the VCR.

**2** Press SMARTFILE.  
The SmartFile search list appears on the TV screen.

10.6.98-5.2.99	P.1
▶ BLANK TIME	SP 1H30M
5.2 FR 0:00	PROG 16
	LP 0H30M
25.1 MO 16:30	PROG 30
	LP 2H00M
11.1 MO 17:00	
	CT1 LP 0H30M
START . . .	END
SELECT :	
SEARCH :	

**3** Press CURSOR to select a programme.  
Press CURSOR repeatedly to turn the pages.

10.6.98-5.2.99	P.1
BLANK TIME	SP 1H30M
5.2 FR 0:00	PROG 16
	LP 0H30M
▶ 25.1 MO 16:30	PROG 30
	LP 2H00M
11.1 MO 17:00	
	CT1 LP 0H30M
START . . .	END
SELECT :	
SEARCH :	

**4** Press OK.  
The VCR starts searching for the beginning of the selected programme.  
Playback starts automatically from that point.

## To stop searching

Press STOP.

## Note

- You may not be able to locate the beginning of the selected programme correctly when :
  - the SmartFile tape contains one or more short length (less than about 20 minutes in the LP mode and about 11 minutes in SP mode) recorded programmes of which programme data are not stored in the SmartFile label.
  - the SmartFile tape is damaged or dirty.
  - the SmartFile tape has a portion recorded in the NTSC system.

# Checking the contents of a tape

You can display the programme data list of a SmartFile tape on the TV screen. It is not necessary to insert the tape into the VCR. This feature allows you to quickly find a specific programme or to find a tape with enough recording space. The SmartFile check list can contain up to 12 programmes.

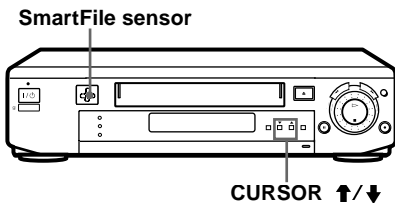

## Before you start...

- Turn on your TV and set it to the video channel.
- Turn on your VCR.

**1** Hold the label side of the SmartFile tape close to the SmartFile sensor.

Slowly bring the center of the label within 3 cm of the SmartFile sensor.

There is a short beep, the SMARTFILE indicator lights up on the VCR, and the SmartFile check list appears. The BLANK TIME space also appears in the display window.

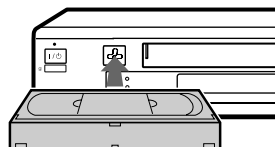

10.6	FR	98-5-2-99	P. 1
BLANK TIME SP 1H30M			
5.2	FR	0:00	PROG. 16
25.1	MO	16:30	PROG. 30
11.1	MO	17:00	CT1
31.12 BEST OF THIS YEAR			
10.12	TH	21:00	CT2
2.12	WE	5:00	L1
NEXT: [down arrow]			
EXIT: [OK]			

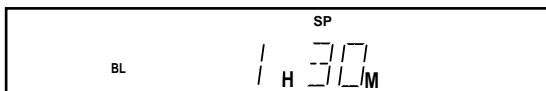

**2** Press CURSOR UP/DOWN to turn the pages.

10.6	FR	98-5-2-99	P. 2
BLANK TIME SP 1H30M			
15.11	SU	11:00	PROG. 8
5.11	TH	13:00	RTL
10.10	SA	19:00	SAT345
15.6	MO	15:30	PROG 7
10.6	WE	1:00	L4
BACK: [up arrow]			
EXIT: [OK]			

**3** Press OK to exit the SmartFile check list.

**Tip**

- If you press a button other than SP/LP or CURSOR ↑/↓, the SmartFile check list disappears.

**Notes**

- You cannot display the SmartFile check list while :
  - you display the SmartFile list of a different SmartFile tape inserted into the VCR.
  - you display any other menu.
- If the SmartFile check list doesn't appear on the TV screen, try again by drawing the SmartFile tape away from the SmartFile sensor at least 5 cm, then bring it back to within 3 cm of the sensor.
- The menu disappears automatically if you don't proceed for more than a few minutes.

# Labelling a recorded programme and tape

Some Broadcast systems ensure a Teletext service in which the complete programmes and their data (title, date, channel, recording start time etc.) are stored day by day. To each day of the week corresponds a TV guide page number. When recording a programme, the VCR automatically takes the label information from the Teletext pages and stores into the SmartFile label. Those TV guide page numbers depend entirely on the broadcast itself and may be subject to change. If so, you may have to set those TV guide page numbers manually in the TV GUIDE PAGE menu.

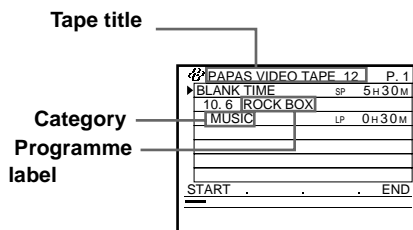

## Setting the TV guide page number

### Before you start . . .

Turn on your TV and set it to the video channel.

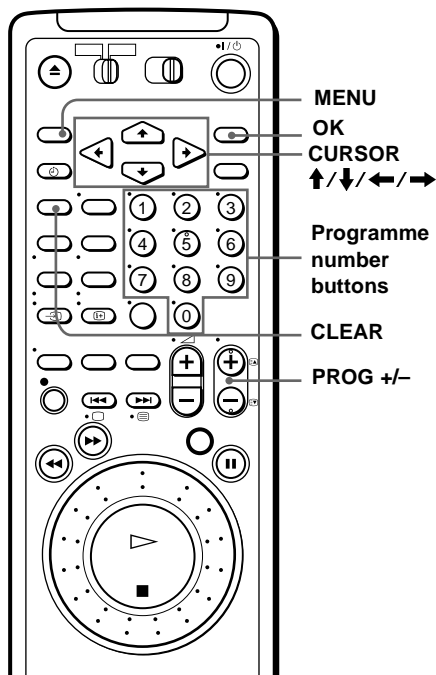



- 1 Select the programme position for which you want to set or change the TV guide page.
- 2 Press MENU, then press CURSOR  $\uparrow/\downarrow$  to highlight SETTINGS and press OK.
- 3 Press CURSOR  $\uparrow/\downarrow$  to highlight TV GUIDE PAGE and press OK.

The TV guide page numbers appear automatically when the VCR detects them.

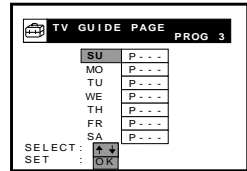
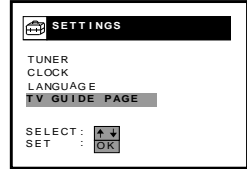

- 4 Press CURSOR  $\uparrow/\downarrow$  to select the TV guide page number you want to modify and press OK.

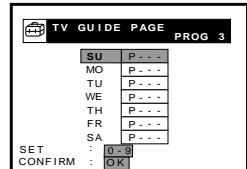

- 5 Press the programme number buttons to enter the TV guide page number and press OK to confirm the setting.

If you make a mistake, press CLEAR to re-enter the correct number.

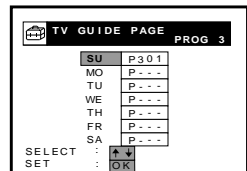

- 6 To set or change another TV guide page number, repeat steps 3 and 4 above.
- 7 Press MENU to exit the menu.

**continued**

## Labelling a recorded programme and tape (continued)

### Notes

- In step 4 above, enter "000" if you don't want to use the TV guide page number for automatic labelling. The VCR will then store default data (date, programme position, duration etc.) in the label.
- Refer to the Teletext information on your TV screen to get the TV guide page number with the programme titles and their start times.
- If the Teletext TV guide has a page which always shows the programmes for the current day, this page should be input for all days.
- If you start recording more than two minutes before the programme is scheduled to start, the correct label information may not be transferred. The VCR receives the label information two minutes after the recording starts. This is to assure that the programmes' information is correctly recorded even if you start recording before the programme actually begins.
- If you set a timer recording with VPS/PDC OFF, the title information will be transferred in the middle of the recording.
- Note that this function may not work correctly with programmes broadcast from some stations.
- When the recording starts and if at that moment the Broadcast system updates the Teletext information, the title on the label may not correspond to the one of the recorded programme. In this case, you may have to manually enter the correct title using the SMARTFILE EDIT menu.
- You cannot get the label information from the sources through the LINE input or the satellite channels.

## Labelling a recorded programme manually

If Teletext data is not available, label and select the appropriate category of the recorded programme manually. Labelling manually takes priority over labelling automatically. You can also label the tape. Up to 18 characters can be input for a programme and tape label.

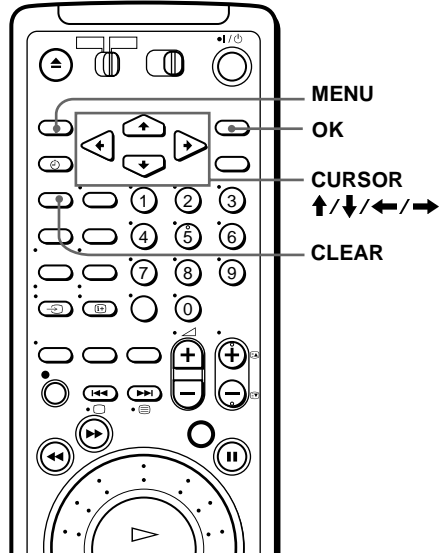

### Before you start...

- Turn on your TV and set it to the video channel.

- 1 Insert a SmartFile tape.  
The SMARTFILE indicator lights up on the VCR.
- 2 Press MENU and select SMARTFILE EDIT, then press OK.  
The SMARTFILE EDIT menu appears.

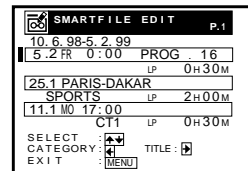

- 3 Press CURSOR  $\uparrow/\downarrow$  to select a programme.

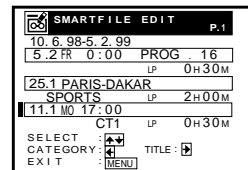

continued

## Labelling a recorded programme and tape (continued)

### 4 Press CURSOR →.

The cursor moves to the programme label input position.

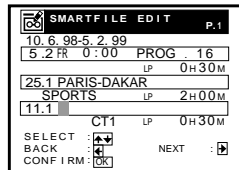

### 5 Label the programme.

#### 1 Press CURSOR ↑/↓ to select a character.

Each time you press CURSOR ↑, the character changes as shown below.

A → B → ... → Z → **special characters** →

! → & → , (comma) → - (hyphen) → .

(period) → 0 → 1 ... → 9 → (blank space)

You can also select a blank space by pressing CLEAR.

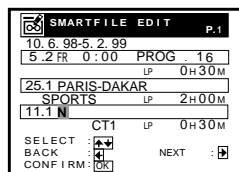

#### 2 To set the next character, press CURSOR →.

The cursor moves to the next position.

#### 3 Repeat steps 1 and 2 to label the programme.

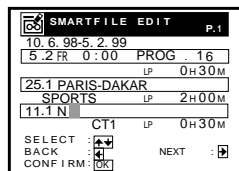

### 6 Press OK.

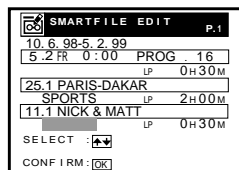

### 7 Press CURSOR ↑/↓ to select a category.

Each time you press CURSOR ↑, the category changes as shown below.

**SPECIAL** → **FILMS** → **NEWS** → **SHOW**

**SPORTS** → **CHILDRÉ (children)** →

**MUSIC** → **ARTS** → **SERIES** → **EDU.**

(education) → **LEISURE** → **SHOPPIN**

(shopping) → **VARIETY** → (blank)

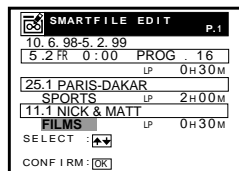

### 8 Press OK.

The programme label and a selected category are stored.

### 9 Press MENU to exit the menu.

**To erase the programme label**

Press CLEAR after step 3 above. The programme label is erased and the default recording data reappear.

**To erase the selected category**

Press CLEAR in step 7 above. The selected category is erased and the space becomes blank.

**To label a regularly scheduled timer-recorded programme**

Once you label a programme which is set to record regularly (i.e everyday, same day of the week, etc.) in the ShowView system or timer recording mode, the VCR recognizes the label and will automatically label all future recordings of the same programme. The set label is assigned even when an information signal containing the programme name, category name or other information is broadcast with the programme. However, if you change the programme label and the category several times, the VCR may automatically label only the last programme of which the programme label and category are changed.

**continued**

---

## Labelling a recorded programme and tape (continued)

### Labelling a tape

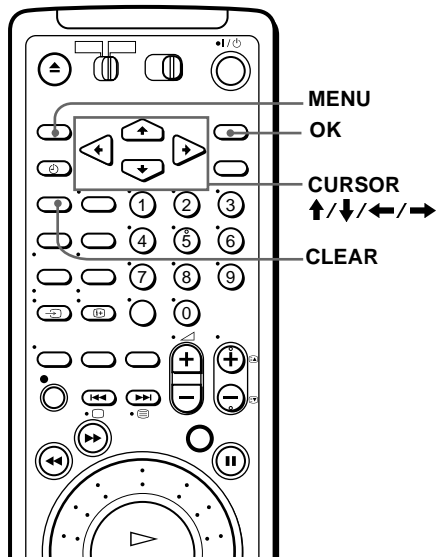

#### Before you start...

- Turn on your TV and set it to the video channel.

- 1 Insert a SmartFile tape.  
The SMARTFILE indicator lights up on the VCR.
- 2 Press MENU and select SMARTFILE EDIT, then press OK.  
The SMARTFILE EDIT menu appears.

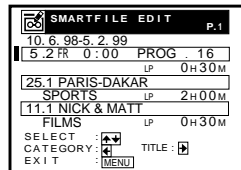

- 3 Press CURSOR ↑ to select the tape title.

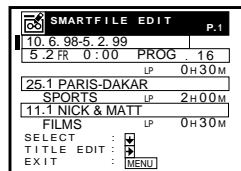

**4** Press CURSOR →.

The cursor moves to the title input position.

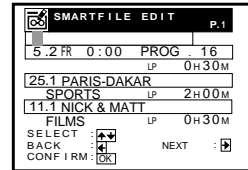
**5** Label the tape.

- 1 Press CURSOR ↑/↓ to select a character.

Each time you press CURSOR ↑, the character changes as shown below.

A → B → ... → Z → special characters →  
! → & → , (comma) → - (hyphen) → .  
(period) → 0 → 1 ... → 9 → (blank space)

You can also select a blank space by pressing CLEAR.

- 2 To set the next character, press CURSOR →.  
The cursor moves to the next position.
- 3 Repeat steps 1 and 2 to label the tape.

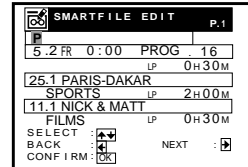
**6** Press OK.

The tape title is stored.

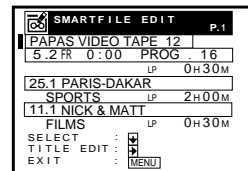
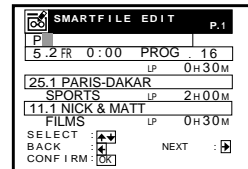
**7** Press MENU to exit the menu.**To erase the tape title**

Press CLEAR after step 3 above. The tape title is erased and the recording date reappears. When you want to erase the recording date from the tape title column, press CLEAR again.

# Registering the contents of a recorded tape in the SmartFile label

The VCR will register programmes recorded on a tape (even a non-SmartFile recorded tape) in the memory of a new SmartFile label by detecting the index signals indicating the start of recorded programmes. You can register up to the 12th programme from the start of the tape. The programmes appear from the bottom of the screen as PROGRAM NO. 1, PROGRAM NO.2, ... PROGRAM NO.12 in the order. The 13th and subsequent programmes are ignored. You can manually name the registered programme numbers and select the category (see page 88).

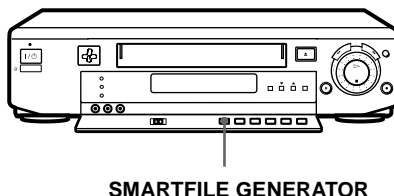

## Before you start...

- Turn on your TV and set it to the video channel.
- Turn on your VCR.

- 1** Attach the SmartFile label to the spine of the cassette as shown on the right and insert the tape.

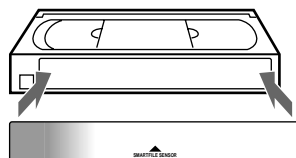

- 2** Press SMARTFILE GENERATOR on the VCR.

A message appears indicating that the recorded programmes are being registered. The index signals are detected from the start of the tape, and the registration stops if the end of the tape is reached. The message disappears when registration is complete.

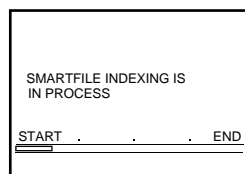

## To stop registration to the SmartFile label

Press SMARTFILE GENERATOR.

The data registered before the button is pressed remains in the SmartFile label. You can register the programmes again by pressing SMARTFILE GENERATOR.



## To check the information of a registered programme

Press SMARTFILE.

The SmartFile search list appears. The registered programme number, registration date and recording time appear in this list. Note that the registration date differs from the recorded date.

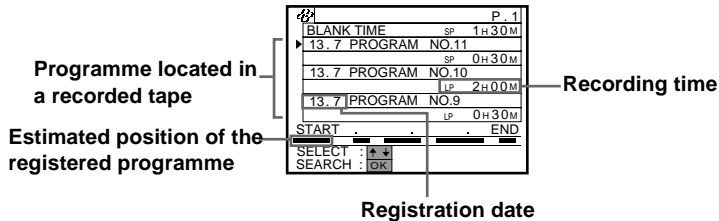

### Tips

- The programmes recorded on the tape can be registered again in a SmartFile label that already contains programme data. However, the recorded date and time, programme name and information input manually (such as the programme label and category) are replaced with "PROGRAM NO. XX".
- If the SmartFile label contains stored programme data that includes protected programmes, a message appears and the registration stops.

### Notes

- Programme data is not registered correctly in the SmartFile label when :
  - the programme length is about 20 minutes or less in LP mode or about 11 minutes in SP mode.
  - the programme does not have an index signal or the index signal has been recorded over and erased.
  - the tape is damaged or dirty.
- If you don't set the clock or the clock isn't set to the correct date, the registration date won't be stored correctly on the SmartFile list.
- After you press SMARTFILE GENERATOR and start registration, registration is interrupted if you press ■ STOP, ▷ PLAY, ►► FF, ◀◀ REW, I/O or ◀◀/►► INDEX SEARCH. In these cases as well, the data registered up to the point when registration was interrupted remains in the SmartFile label.
- When you set AUTO LONG PLAY to ON in the TAPE OPTIONS menu, and the tape speed automatically changes from SP to LP during recording, the VCR displays the entire recording time converted in SP mode to the SmartFile list.
- The estimated position of the registered programmes may not be correct in case of many short programmes recorded on long tapes.

# Protecting a recorded programme

You can protect a recorded programme using the SmartFile function from accidental over-recording or erasure. When you start recording from a position prior to the protected programme, the recording stops automatically before the protected programme.

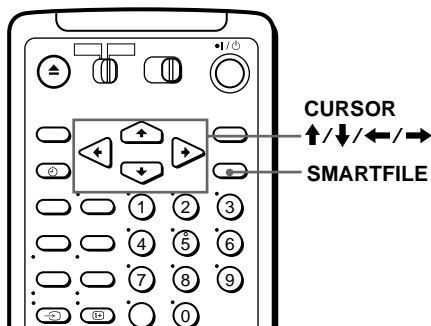

## Before you start...

- Turn on your TV and set it to the video channel.

**1** Insert a SmartFile tape.

The SMARTFILE indicator lights up on the VCR.

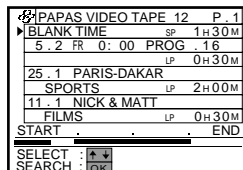

**2** Press SMARTFILE.

The SmartFile search list appears on the TV screen.

**3** Press CURSOR  $\uparrow/\downarrow$  to select the programme you want to protect.

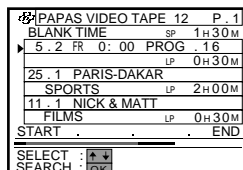

**4** Press CURSOR  $\rightarrow$ .

The indicator appears to the left of the selected programme and the programme is now protected.

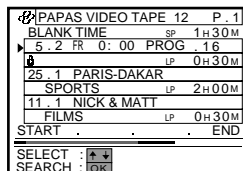

**5** Press SMARTFILE.

The SmartFile search list disappears.

## To unlock the protected programme

Press CURSOR ← in the step 4 above. The indicator disappears and you can record over this programme.

### Tips

- When you start recording from a position prior to the protected programme, the recording automatically stops no more than about four minutes in SP mode and about eight minutes in LP mode before the beginning of the protected programme. The BLANK TIME indicator flashes in the display window.
- If you protect a programme just after the Blank Time space, BLANK TIME becomes shortened by about four minutes in SP mode and about eight minutes in LP mode.
- If you try to record on a SmartFile tape containing a protected programme, a message indicating that there is a protected programme on this tape appears on the TV screen.

### Notes

- When you record another programme just after a protected programme, locate the beginning of the Blank Time space by following the instructions in “Recording after locating the Blank Time space” on page 83. Otherwise, if the recording start point overlaps the protected programme, the VCR may over-record the protected programme.
- If you insert a SmartFile tape which contains a protected programme or protect a programme for the first time on a new tape, the VCR will analyse the position of the protected programme for a few seconds. You cannot operate the VCR while the VCR is analysing the tape.
- If the SmartFile list contains 12 protected programmes, the next programme you record won't be stored in the SmartFile list.
- When you try to turn off the VCR after setting a ShowView timer recording on the protected programme, the VCR automatically ejects the cassette.
- The protecting function may not work with an NTSC-recorded tape.

# Erasing the data of an unwanted programme

You can erase an unwanted programme from the SmartFile list.

When you erase a programme from the list, that portion of tape is subject to Blank Time space priority.

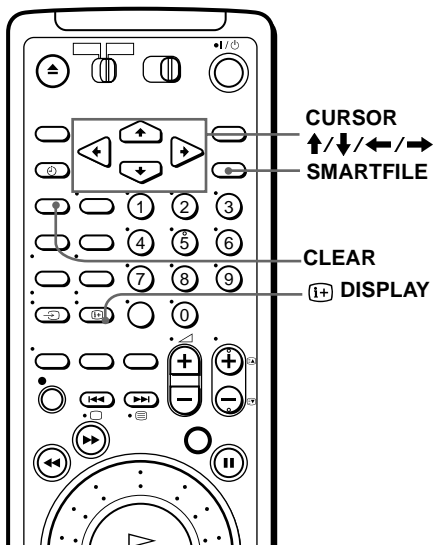

## Before you start...

- Turn on your TV and set it to the video channel.

- 1 Insert a SmartFile tape.  
The SMARTFILE indicator lights up on the VCR.

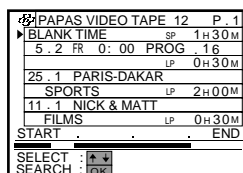

- 2 Press SMARTFILE.  
The SmartFile search list appears on the TV screen.
- 3 Press CURSOR **↑/↓** to select a programme you want to erase from the list.

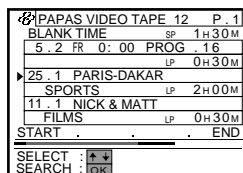

**4** Press CLEAR.

The selected programme is erased from the SmartFile list.

If you erase a programme by mistake, press **(L+)** DISPLAY to make the programme reappear.

PAPAS VIDEO TAPE 12 P. 1	
BLANK TIME	SP 1H30M
5.2 FR 0:00	PROG 16
	LP 0H30M
▶ 11.1	NICK & MATT
	FILMS LP 0H30M
START	. . . END
SELECT	: <b>(L+)</b>
SEARCH	: <b>(L+)</b>

**5** Press SMARTFILE.

The SmartFile search list disappears.

**Notes**

- You cannot erase a protected programme from the SmartFile list. You have to first unlock the protected programme by following the instructions in “To unlock the protected programme” on page 99, then erase that programme from the list.
- The erased programme disappears from the SmartFile list, but it still remains on the tape.
- If a programme is left about 11 minutes or less in SP mode or about 20 minutes or less in LP mode, you cannot make the programme reappear by using the **(L+)** DISPLAY button.

# Troubleshooting

If you have any questions or if your problems are not covered below, please consult your nearest Sony service facility.

## Problem summary

The following table summarizes the reference numbers for the problems you might face. In order to solve your problem, please refer to the corresponding reference (S1=symptom1, S2=symptom2 ...) in the right column below.

Category		Refer to
<b>Picture</b>	• while watching broadcast tuned by the TV.	<b>S2, S6</b>
	• while watching broadcast tuned by the VCR.	<b>S1, S6</b>
	• while playing a tape.	<b>S3, S4, S5</b>
<b>Sound</b>	• while playing a tape.	<b>S7, S8, S9</b>
<b>Functional</b>	• Playback	<b>S4, S9, S10</b>
	• Normal recording	<b>S11, S12</b>
	• SmartFile	<b>S13, S14</b>
	• Timer recording	<b>S15, S16</b>
	• Canal Plus	<b>S17, S18, S19</b>
	• Line selection	<b>S20</b>
	• Remote commander	<b>S21, S22</b>
	• Cleaning	<b>S23</b>
	• Clock	<b>S24</b>
	• Power	<b>S25, S26, S27, S28, S29</b>
	• Tape	<b>S30, S31</b>
	• SMARTLINK	<b>S32</b>
	• Satellite tuner	<b>S33</b>

Picture	
<b>S1</b>	<p>The VCR picture does not appear on the TV screen.</p> <ul style="list-style-type: none"> <li>→ Make sure the TV is set to the video channel. If you are using a monitor, set it to video input.</li> <li>→ If the VCR is connected to the TV with the EURO-AV cable, make sure the TV/VIDEO indicator is lit in the display window. Use the TV/VIDEO key on the remote commander to light the TV/VIDEO indicator.</li> <li>→ If the VCR is connected to the TV only with the aerial cable, make sure that RF MODULATOR is set to ON in the OTHER OPTIONS menu (see page 73).</li> </ul>
<b>S2</b>	<p>The TV programme is not clear or has some interference.</p> <ul style="list-style-type: none"> <li>→ If your TV is connected to the VCR with both EURO-AV and aerial cables, make sure the RF MODULATOR is set to OFF in the OTHER OPTIONS menu (see page 73).</li> <li>→ Existing broadcasts may interfere with the VCR. Reset the RF MODULATOR output of your VCR.</li> </ul>
<b>S3</b>	<p>The playback picture is not clear or has some interference.</p> <ul style="list-style-type: none"> <li>→ If your TV is connected to the VCR with both EURO-AV and aerial cables, make sure the RF MODULATOR is set to OFF in the OTHER OPTIONS menu (see page 73).</li> <li>→ Existing broadcasts may interfere with the VCR. Reset the RF MODULATOR output of your VCR.</li> <li>→ Adjust the tracking with the TRACKING +/- buttons (see page 69).</li> <li>→ The video heads are dirty (see below). Clean the video heads using the Sony T-25CLD, E-25CLDR, or T-25CLW video head cleaning cassette. If these cleaning cassettes are not available in your area, have the heads cleaned at your nearest Sony service facility (a standard service charge will be required). Do not use a commercially available liquid type cleaning cassette other than Sony's, as it may damage the video heads.</li> </ul> <p>The video heads may have to be replaced. Consult your local Sony service facility for more information.</p>

**Symptoms caused by contaminated video heads**

• Normal picture



• Rough picture



initial  
contamination

Unclear picture



• No picture (or black & white screen appears)



terminal



continued

**Troubleshooting (continued)**

**Picture**

- |           |  |   |  |
|-----------|--|---|--|
| <b>S4</b> | The tracking meter does not appear on the TV screen. | → | The recording condition of the tape is very poor and tracking can not be adjusted. |
|           |  | → | The display does not appear when the tape you are playing is recorded in NTSC.     |
| <b>S5</b> | The picture rolls vertically during picture search.  | → | Adjust the vertical hold control on the TV or monitor.                             |
| <b>S6</b> | TV reception is poor.                                | → | Make sure the aerial cables are connected securely.                                |
|           |  | → | Adjust the TV aerial.  |
|           |  | → | Make sure SYSTEM (B/G or D/K) in the TUNER menu is set to the system in your area. |

**Sound**

- |           |  |   |   |
|-----------|--|---|---|
| <b>S7</b> | The picture has no sound.  | → | The tape is defective. Please use a new tape.   |
|           |  | → | Make sure SYSTEM (B/G or D/K) in the TUNER menu is set to the system in your area.  |
| <b>S8</b> | The sound is unstable or has an echo.                                | → | When you play a tape with the same sound recorded on both the hi-fi and normal sound tracks, make sure AUDIO MIX in the AUDIO OPTIONS menu is set to OFF (see page 72). |
| <b>S9</b> | You cannot select the left or the right channel while playing a tape | → | Make sure AUDIO MIX is set to OFF in the AUDIO OPTIONS menu (see page 72).  |
|           |  | → | Make sure you are playing a hi-fi tape.   |

**Playback**

- |            |  |   |   |
|------------|--|---|---|
| <b>S10</b> | The tape starts playing as soon as it is inserted. | → | This is normal. When you insert a tape which its safety tab has been removed, the VCR starts playing automatically. |
|------------|--|---|---|

**Normal recording**

- |            |   |   |   |
|------------|---|---|---|
| <b>S11</b> | The tape is ejected when you press ● REC. | → | The safety tab has been removed. To record on this tape, cover the tab hole (see page 50).  |
| <b>S12</b> | Nothing happens when you press ● REC.     | → | Make sure the tape is not at its end.   |
|            |   | → | If the BL indicator is flashing in the display window, the tape contains a programme protected by the SmartFile function (see page 98). |

**SmartFile**

- |            |   |   |   |
|------------|---|---|---|
| <b>S13</b> | The programme label cannot be taken properly. | → | Make sure the clock and the date are set correctly.   |
|            |   | → | Check the setting of the TV guide pages. Some stations may not offer this service (see page 88).  |
|            |   | → | If you start recording more than two minutes before the beginning of the programme, the title on the label may not correspond to the one of the recorded programme. Enter manually the correct title using the SMARTFILE EDIT menu (see page 91). |
|            |   | → | If the TV reception is poor, the VCR will not be able to take the title correctly. Enter manually the correct title using the SMARTFILE EDIT menu (see page 91).  |



---

**SmartFile**

---

- S14** Recording stops halfway. → If the tape contains a programme protected by the SmartFile function, recording automatically stops before the protected programme. Use another tape which has enough recording space.
- 

**Timer recording**

---

- S15** The timer does not operate properly. → Check that the clock is set.  
 → The clock stops if the VCR is disconnected from the mains for more than an hour. Reset the clock and the timer.  
 → Check that the safety tab has not been removed.  
 → If the timer recording overlaps a programme protected by the SmartFile function, the recording stops halfway (see page 98).  
 → The recording start point overlaps the protected programme.  
 → Make sure the tape is not at its end.  
 → Make sure a tape has been inserted.  
 → Make sure the current time has not already passed your timer settings .  
 → If you are recording a programme from a satellite tuner, make sure the satellite tuner is turned on.
- 

- S16** The VPS/PDC function does not operate properly. → Check that the clock and the date are set correctly.  
 → Check that the VPS/PDC time you set is the correct one (there might be a mistake in the TV guide programme). If the Broadcast you wanted to record did not send the good VPS/PDC information, the VCR will not start recording.  
 → If the reception is poor, the VPS/PDC signal might be altered and the VCR might not start recording.
- 

**Canal Plus**

---

- S17** You cannot set channels as PAY-TV/CANAL+ in the TUNER menu. → Be sure that DECODER/LINE4 is set to DECODER in OTHER OPTIONS menu (see page 73).
- S18** You cannot watch Canal Plus when the VCR is in standby mode. → Be sure that DECODER/LINE4 is set to DECODER in OTHER OPTIONS menu (see page 73).  
 → Make sure the Canal Plus EURO-AV cable is plugged securely.
- S19** PAY-TV/Canal Plus is always recorded scrambled. → Make sure the Canal Plus EURO-AV cable is set securely.  
 → Be sure that DECODER/LINE4 is set to DECODER in OTHER OPTIONS menu (see page 73).  
 → Be sure that this channel is set as PAY-TV/CANAL+ in TUNER menu (see page 40).
- 

**Line selection**

---

- S20** You cannot select LINE4. → Be sure that DECODER/LINE4 is set to LINE4 in OTHER OPTIONS menu (see page 73).
- 

**continued**

---

**Troubleshooting (continued)**

**Remote commander**

- |            |  |   |  |
|------------|--|---|--|
| <b>S21</b> | The remote commander does not operate. | → | Make sure you are pointing the remote commander at the remote sensor on the VCR.   |
|            |  | → | Replace all the batteries in the remote commander by new ones if they are weak.  |
|            |  | → | Make sure the TV/VIDEO remote control switch is set correctly.   |
|            |  | → | Make sure the COMMAND MODE switch position of the VCR matches to the remote commander's one.                               |
| <b>S22</b> | You cannot control your TV.            | → | Set your TV's code number. The code number may change when you replace the batteries of the remote commander (see page 9). |

**Cleaning**

- |            |                              |   |  |
|------------|------------------------------|---|--|
| <b>S23</b> | The VCR needs to be cleaned. | → | Clean the cabinet, panel and controls with a dry, soft cloth, or a soft cloth slightly moistened with a mild detergent solution. Do not use any type of solvent, such as alcohol or benzene. |
|------------|------------------------------|---|--|

**Clock**

- |            |  |   |  |
|------------|--|---|--|
| <b>S24</b> | The clock has stopped and “-:--” lights in the display window. | → | The clock stops if the VCR is disconnected from the mains for more than one hour. Reset the clock and timer if needed (see page 21). |
|------------|--|---|--|

**Power**

- |            |  |   |  |
|------------|--|---|--|
| <b>S25</b> | The I/⏻ ON/STANDBY switch does not function.                         | → | Connect the mains lead to the mains securely.  |
| <b>S26</b> | The power is turned on but the VCR does not operate.                 | → | Moisture condensation occurs. Turn the power off, unplug the mains lead and leave the VCR to dry for over three hours.   |
| <b>S27</b> | The tape is ejected when you press I/⏻ ON/STANDBY.                   | → | You have set a timer recording, but the tape on which you want to record is protected (or contains protected recordings). Unlock the protection or use another tape or replace the safety tab (see page 99). |
| <b>S28</b> | The display is not lit when the VCR is in STANDBY mode.              | → | The VCR is in power save mode. Set the POWER SAVE option to OFF in the OTHER OPTIONS menu (see page 73).   |
| <b>S29</b> | POWER SAVE is set to ON but the display remains lit in STANDBY mode. | → | The display is always lit if the VCR is in timer standby mode. For more details regarding the energy saving, see page 73.  |

---

**Tape**

---

- |            |  |   |  |
|------------|--|---|--|
| <b>S30</b> | The tape is ejected when you press I/⏻ ON/STANDBY. | → | You have set a timer recording, but the tape on which you want to record is protected (or contains protected recordings). Unlock the protection or use another tape or replace the safety tab (see page 99). |
| <b>S31</b> | A tape cannot be inserted.                         | → | Check that a tape isn't already in the tape compartment.   |
- 

**SMARTLINK**

---

- |            |  |   |   |
|------------|--|---|---|
| <b>S32</b> | The SMARTLINK function does not work properly. | → | Check that your TV complies with SMARTLINK, NexTView Link, MEGALOGIC, EASYLINK, Q-Link or EURO VIEW LINK. |
|            |  | → | Make sure you use the EURO-AV cable, supplied with the VCR, to connect the VCR and your TV.               |
|            |  | → | Make sure the EURO-AV cable is connected securely. Refer to your TV manual for instructions.              |
- 

**Satellite tuner**

---

- |            |   |   |  |
|------------|---|---|--|
| <b>S33</b> | You cannot watch the satellite tuner picture when the VCR is in standby mode or ● REC standby mode. | → | Be sure that the DECODER/LINE-4 is set to LINE4- in OTHER OPTIONS menu (see page 73).  |
|            |   | → | Make sure the POWER SAVE option is set to OFF in the OTHER OPTIONS menu (see page 73). |
-

# Specifications

## System

Channel coverage

PAL (D/K, B/G)

VHF E2 to E12, R1-R12

UHF E21 to E69, R21-R69

CATV S01 to S05, S1 to S41

RF output signal

UHF channels 21 to 69

Aerial out

75-ohm asymmetrical aerial socket

## Inputs and outputs

LINE-1 (TV)

21-pin

Video input: pin 20

Audio input: pins 2 and 6

Video output: pin 19

Audio output: pins 1 and 3

DECODER/ LINE-4 IN

21-pin

Video input: pin 20

Audio input: pins 2 and 6

LINE-2 IN

VIDEO IN, phono jack (1)

Input signal: 1 Vp-p, 75 ohms, unbalanced, sync negative

AUDIO IN, phono jack (2)

Input level: 327 mVrms

Input impedance : more than 47 kilohms

LINE-3 IN

VIDEO IN, phono jack (1)

Input signal: 1 Vp-p, 75 ohms, unbalanced, sync negative

AUDIO IN, phono jack (2)

Input level: 327 mVrms

Input impedance : more than 47 kilohms

LINE-2 OUT

VIDEO OUT, phono jack (1)

Output signal: 1 Vp-p, 75 ohms, unbalanced, sync negative

AUDIO OUT, phono jack (2)

Rated output level: 327 mVrms

Load impedance: 47 kilohms

Output impedance: less than 10 kilohms

## General

Power requirements

220 – 240 V AC, 50 Hz

Power consumption

25 W (Normal)

3, 5 W (POWER SAVE is set to ON, no decoder)

Operating temperature

5°C to 40°C

Storage temperature

-20°C to 60°C

Dimensions

Approx. 430 × 100 × 335 mm (w/h/d)

including projecting parts and controls

Mass

Approx. 4.9 kg

## Supplied accessories

Remote commander (1)

R6 (size AA) batteries (2)

Aerial cable (1)

Audio cable (1)

EURO-AV cable (1)

SmartFile labels (10)

Design and specifications are subject to change without notice.

# Index to parts and controls

Refer to the pages indicated in parentheses ( ) for details.

## Front panel

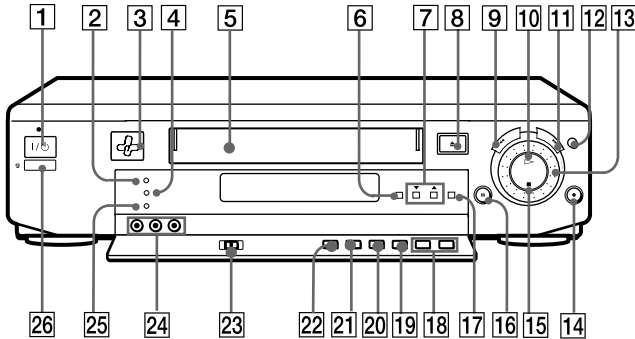

- |  |   |
|--|---|
| <b>1</b> I/⏻ ON/STANDBY button/indicator (6)     | <b>16</b> ■■ PAUSE button (46)                                      |
| <b>2</b> SMARTFILE indicator (86)                | <b>17</b> OK button   |
| <b>3</b> SMARTFILE sensor (86)                   | <b>18</b> PROGRAM/TRACKING +/- buttons (19), (69)                   |
| <b>4</b> REALITY REGENERATOR (RR) indicator (69) | <b>19</b> DIGITAL NOISE REDUCTION button (70)                       |
| <b>5</b> Tape compartment                        | <b>20</b> REALITY REGENERATOR button (69)                           |
| <b>6</b> SMARTFILE button (81)                   | <b>21</b> AUTO SET UP (19)/RF (Radio Frequency) CHANNEL button (17) |
| <b>7</b> CURSOR ↑/↓ buttons (86)                 | <b>22</b> SMARTFILE GENERATOR button                                |
| <b>8</b> ▲ EJECT button (46)                     | <b>23</b> COMMAND MODE Switch (7)                                   |
| <b>9</b> ◀◀ REW (rewind) button (46)             | <b>24</b> LINE-2 IN VIDEO/AUDIO L/R jacks (74)                      |
| <b>10</b> ▷ PLAY button (46)                     | <b>25</b> DIGITAL NOISE REDUCTION (DNR) indicator (70)              |
| <b>11</b> ▶▶ FF (fast-forward) button (46)       | <b>26</b> Remote sensor (5)   |
| <b>12</b> JOG button/indicator (60)              |   |
| <b>13</b> Shuttle ring (60)                      |   |
| <b>14</b> ● REC (record) button (48), (74)       |   |
| <b>15</b> ■ STOP button (46)                     |   |

**continued**

## Index to parts and controls (continued)

### Display window

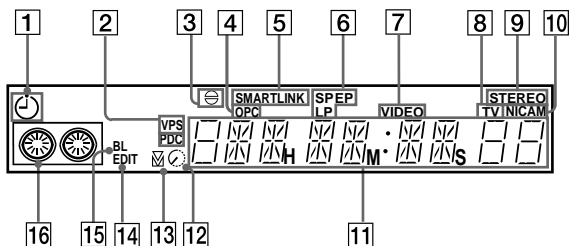

- |   |   |
|---|---|
| <b>1</b> Timer indicator (55), (57)   | <b>8</b> TV indicator (51)  |
| <b>2</b> VPS (Video Programme System)/PDC (Programme Delivery Control) indicator (55) | <b>9</b> STEREO indicator (66)  |
| <b>3</b> Audio Dubbing indicator (76)   | <b>10</b> NICAM indicator (66)  |
| <b>4</b> OPC (Optimum Picture Control) indicator (69)                                 | <b>11</b> Time counter/clock/line/programme position indicator (17), (46), (49) |
| <b>5</b> SMARTLINK indicator (13)   | <b>12</b> Remaining time indicator (50)   |
| <b>6</b> Tape speed indicators (49)   | <b>13</b> Tracking indicator (69)   |
| <b>7</b> VIDEO indicator (49)   | <b>14</b> EDIT indicator (75)   |
|   | <b>15</b> BL (Blank Time space) indicator (86)                                  |
|   | <b>16</b> Tape/recording indicator (49)   |

## Rear panel

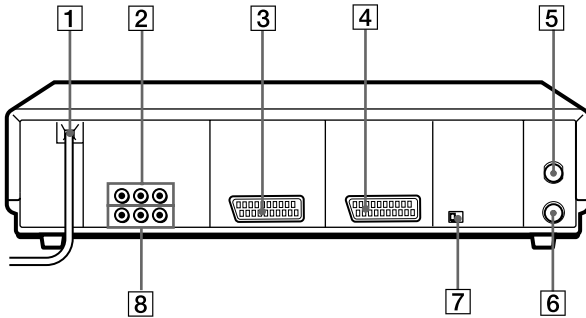

- |   |   |
|---|---|
| <p><b>1</b> Mains lead (11), (14)</p> <p><b>2</b> LINE-3 IN<br/>AUDIO L/R/VIDEO<br/>ENTREE LIGNE-3<br/>AUDIO G/D/VIDEO</p> <p><b>3</b> ↻ LINE-1 (TV)<br/>↻ LIGNE-1 (TV) connector (11), (40)</p> <p><b>4</b> DECODER/↻ LINE-4 IN<br/>DECODEUR/↻ ENTREE LIGNE-4<br/>connector (40)</p> | <p><b>5</b> AERIAL IN<br/>ANTENNE ENTREE connector (11),<br/>(14)</p> <p><b>6</b> AERIAL OUT<br/>ANTENNE SORTIE connector (11),<br/>(14)</p> <p><b>7</b> NTSC PB (Play Back) switch (45)</p> <p><b>8</b> LINE-2 OUT<br/>AUDIO L(left)/R (right)/VIDEO<br/>SORTIE LIGNE-2<br/>AUDIO G/D/VIDEO (15)</p> |
|---|---|

**continued**

---

## Remote commander

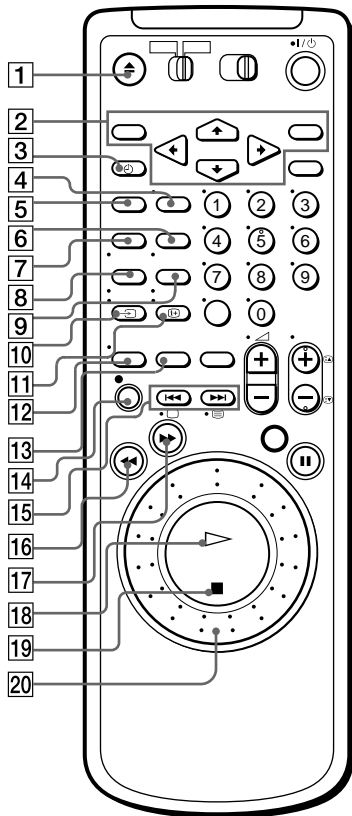



- 1 ▲ EJECT button (46)
- 2 Menu buttons (6)  
MENU button  
CURSOR ↑/↓/←/→ buttons  
OK button
- 3 ⏸ TIMER button (52), (57)
- 4 🔊 AUDIO MONITOR button (6), (66)
- 5 ✖ CLEAR button (45), (52), (64)
- 6 🗣️ AUDIO DUB button\* (76)
- 7 ⌚ COUNTER/REMAIN button\* (50)
- 8 ⚡ Fasttext button\*
- 9 ⚡ Fasttext button\*
- 10 📺 TV/VIDEO button (6)
- 11 📺 DISPLAY button (50)
- 12 📺 WIDE button (for TV) (7)
- 13 📺 SP (Standard Play)/LP (Long Play) button (48)
- 14 ● REC (record) button (48), (63), (75)
- 15 ⏮/⏭ INDEX SEARCH buttons (68)  
□ TV power on/TV mode select button (for TV) (7)  
☰ (Teletext) button (for TV) (7)
- 16 ⏮ REW (rewind) button (46), (60)
- 17 ⏭ FF (fast-forward) button (46), (60)
- 18 ▶ PLAY button (46), (60)
- 19 ■ STOP button (46), (63)
- 20 🔄 Shuttle ring (60)

\* FASTTEXT buttons (for TV)

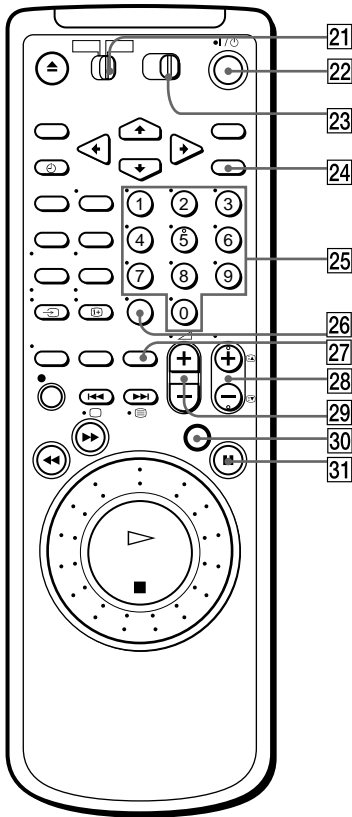



- 21 TV / VIDEO remote control switch (5)
- 22 I/⏻ (on/standby) button (6), (52)
- 23 COMMAND MODE Switch (7)
- 24 SMARTFILE button (81)
- 25 Programme number buttons (6)
- 26 -/- (ten's digit) button (6), (50)
- 27 INPUT SELECT button (49), (57)
- 28 PROG (programme) +/- buttons (6), (27)
- 29  Teletext page access buttons (*for TV*) (7)
- 29  (volume) +/- buttons (*for TV*) (6)
- 30 JOG button (60)
- 31 ■ PAUSE button (46), (61)

# Menu chart

This VCR is equipped with an on-screen indication system which allows you a visual, quick and easy selection of the different menus. For a total view of all the menus, please refer to the following chart.

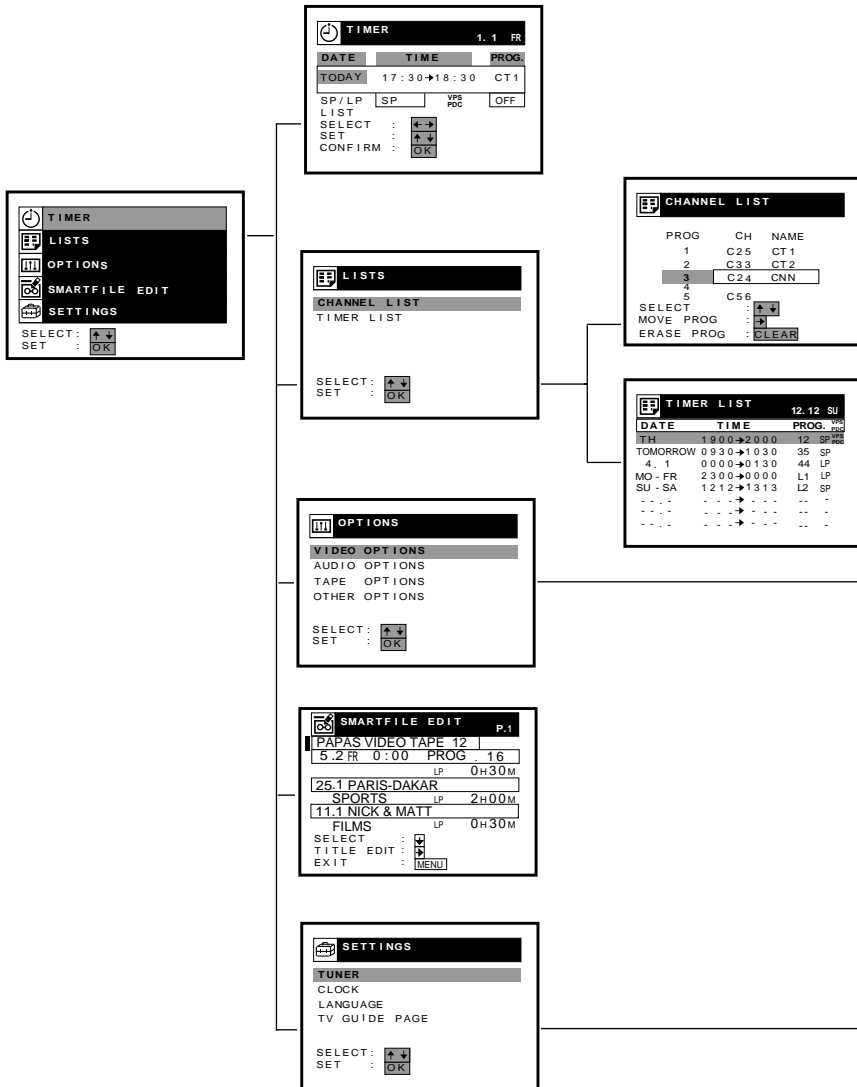

**VIDEO OPTIONS**

OPC	ON
EDIT	OFF
SHARPNESS	NORMAL
COLOUR SYSTEM	AUTO
RR	NORMAL

SELECT : SET :

**AUDIO OPTIONS**

AUDIO MIX	OFF
HIFI AUDIO	NICAM

SELECT : SET :

**TAPE OPTIONS**

AUTO LONG PLAY	OFF
TAPE LENGTH	E180

SELECT : SET :

**OTHER OPTIONS**

BUZZER	ON
DIMMER	OFF
DECODER/LINE4	DECODER
POWER SAVE	OFF
RF MODULATOR	OFF
TIMER OPTIONS	VARY
TV DIRECT REC	ON

SELECT : SET :

**TUNER** PROG. 2

SYSTEM	D/K
NORMAL/CATV	NORMAL
CHANNEL SET	C25 CT1
PAY-TV/CANAL+	OFF
AFT	ON
FINE TUNING	

SELECT : SET :

**CLOCK**

AUTO ADJUST	ON
CLOCK PROG	1 CT1
MANUAL ADJUST	
1. 1. 1999 FR 0:00	

SELECT : SET :

**LANGUAGE**

ENGLISH	MAGYAR
ČESKY	POLSKI
ΕΛΛΗΝΙΚΑ	РУССКИЙ

SELECT : END :

**TV GUIDE PAGE** PROG 3

SU	P301
MO	P--
TU	P--
WE	P--
TH	P--
FR	P--
SA	P--

SET :

# Index

## A

- Accessories supplied 4
- Adjusting
  - picture 30, 69
  - tracking 69
- Aerial hookup 11
- AFT (Auto Fine Tuning) 30
- Audio dubbing 76
- Audio track 67
- Auto Clock set 24
- Auto Set Up 19

## C

- Canal Plus 40
- Changing the programme position 33
- Clock setting 21
- Colour system
  - compatible colour systems 2
  - setting 46
- Connecting
  - the VCR and your TV 11, 14
  - to a satellite tuner 15
  - to a stereo system 15
  - to a TV with a EURO-AV connector 11
- Counter 46

## D

- Disabling the programme positions 35
- DNR (Digital Noise Reduction) 70
- Dubbing. *see* Editing

## E

- Editing 74
- EP mode 47
- EURO-AV connection 11

## H

- Hi-fi audio track 67

## I

- Index Search 68

## L

- Language selecting 26
- LP mode 49

## M

- Menu options 71
- Monitoring
  - during playback 67
  - during recording 67

## N

- NICAM broadcasts 66
- Normal audio track 67

## O

- OPC (Optimum Picture Control) 69

## P

- PAY-TV 37, 40
- PDC (Programme Delivery Control) 55
- Picture adjustment. *See* Adjusting
- Playback 45
  - at various speeds 46, 60
  - frame-by-frame 61
  - selecting the sound 67
  - slow motion 61
- Power save 73
- Presetting channels 27

## R

- Recording 48
  - bilingual programmes 66
  - saving 50
  - using the ShowView system 52
  - what you are watching on the TV 51
  - while watching another programme 50
- Remote commander 5
- RF channel 17
- RR (Reality Regenerator) 69

## S

- Safety tab 50
- Satellite tuner
  - connecting 37
  - line through 15
  - setting 38
- Searching
  - at various speeds 60
  - using the index function 68

## SMARTFILE 78

- checking the contents of a tape 86
- demonstration 79
- erasing the data of an unwanted programme 100
- labelling a recorded programme and tape 88
- protecting a recorded programme 98
- recording 80
  - registering the contents of a recorded tape in the SmartFile label 96
  - selecting 85
  - SmartFile label 4, 80
- SMARTLINK 13
  - Automatic Power Off 13
  - connection 11
  - NexTVView Download 13
  - One Touch Menu 13
  - One Touch Play 13, 47
  - One Touch Timer 13
  - Preset Download 13
  - TV Direct Rec 13, 51
- SP mode 49
- Station name
  - changing 31
  - setting 31

## T

- Timer recording 52, 57
  - overlapping timer recording 65
  - using the ShowView system 52
- Timer setting
  - cancelling 64
  - changing 64
  - checking 64
  - daily/weekly recording 55, 59
- Tracking adjustment. *See* Adjusting

## V

- VPS (Video Programme System) 55

## Z

- Zweiton broadcasts 66

---

Sony  line

<http://www.world.sony.com/>

---

## Free Manuals Download Website

<http://myh66.com>

<http://usermanuals.us>

<http://www.somanuals.com>

<http://www.4manuals.cc>

<http://www.manual-lib.com>

<http://www.404manual.com>

<http://www.luxmanual.com>

<http://aubethermostatmanual.com>

Golf course search by state

<http://golfingnear.com>

Email search by domain

<http://emailbydomain.com>

Auto manuals search

<http://auto.somanuals.com>

TV manuals search

<http://tv.somanuals.com>