

Video Cassette Recorder

Operating Instructions



SLV-SE210D **SHOWVIEW**[®]
SLV-SX110A

WARNING

To prevent fire or shock hazard, do not expose the unit to rain or moisture.

To avoid electrical shock, do not open the cabinet. Refer servicing to qualified personnel only.

Mains lead must only be changed at a qualified service shop.

Precautions

Safety

- This unit operates on 230 V AC, 50 Hz. Check that the unit's operating voltage is identical with your local power supply.
- If anything falls into the cabinet, unplug the unit and have it checked by qualified personnel before operating it any further.
- The unit is not disconnected from the mains as long as it is connected to the mains, even if the unit itself has been turned off.
- Unplug the unit from the wall outlet if you do not intend to use it for an extended period of time. To disconnect the cord, pull it out by the plug, never by the cord.

Installing

- Allow adequate air circulation to prevent internal heat buildup.
- Do not place the unit on surfaces (rugs, blankets, etc.) or near materials (curtains, draperies) that may block the ventilation slots.
- Do not install the unit near heat sources such as radiators or air ducts, or in a place subject to direct sunlight, excessive dust, mechanical vibration or shock.
- Do not install the unit in an inclined position. It is designed to be operated in a horizontal position only.
- Keep the unit and cassettes away from equipment with strong magnets, such as microwave ovens or large loudspeakers.
- Do not place heavy objects on the unit.
- If the unit is brought directly from a cold to a warm location, moisture may condense inside the VCR and cause damage to the video head and tape. When you first install the unit, or when you move it from a cold to a warm location, wait for about three hours before operating the unit.

Caution

Television programmes, films, video tapes and other materials may be copyrighted. Unauthorized recording of such material may be contrary to the provisions of the copyright laws. Also, use of this recorder with cable television transmission may require authorization from the cable television transmitter and/or programme owner.

Compatible colour systems

This VCR is designed to record and play back using the PAL (B/G) and MESECAM colour systems.

Recording of video sources based on other colour systems cannot be guaranteed.

SHOWVIEW is a registered trademark of Gemstar Development Corporation. The SHOWVIEW system is manufactured under license from Gemstar Development Corporation.

Table of contents

Getting Started

- 4 Index to parts and controls
- 9 Step 1 : Unpacking
- 10 Step 2 : Setting up the remote commander
- 12 Step 3 : Connecting the VCR
- 14 Step 4 : Setting up the VCR with the Auto Set Up function
- 17 Setting the clock
- 19 Selecting a language
- 20 Presetting channels
- 23 Changing/disabling programme positions
- 28 Setting the PAY-TV/Canal Plus decoder (SLV-SE210D only)

Basic Operations

- 31 Playing a tape
- 33 Recording TV programmes
- 36 Recording TV programmes using the ShowView system (SLV-SE210D only)
- 40 Recording TV programmes using the timer

Additional Operations

- 43 Playing/searching at various speeds
- 44 Setting the recording duration time
- 45 Checking/changing/cancelling timer settings
- 47 Adjusting the picture
- 48 Changing menu options
- 50 Editing with another VCR

Additional Information

- 52 Troubleshooting
- 55 Specifications
- 56 Index

Back Cover

Quick Start Guide

Index to parts and controls

Refer to the pages indicated in parentheses () for details.

Front panel

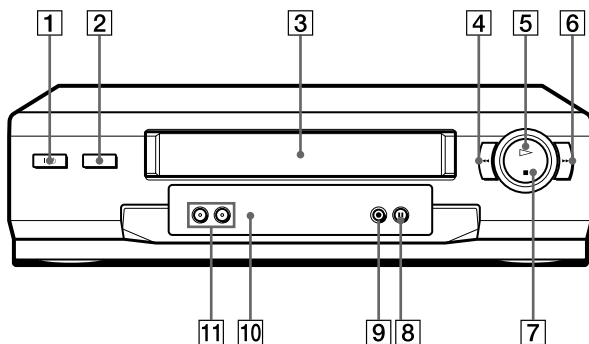

1 | (on/standby) switch (38)

2 | (eject) button (31)

3 | Tape compartment

4 | (rewind) button (31) (43)

5 | (play) button (31) (43)

6 | (fast-forward) button (31) (43)

7 | (stop) button (31) (51)

8 | (pause) button (31) (51)

9 | REC (record) button (33) (44) (51)

10 | Remote sensor (10)

11 | PROGRAM (programme) +/- buttons (43) (47)

Display window

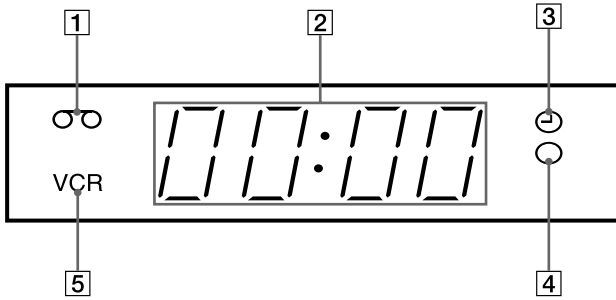

1 Tape indicator (39)

2 Time counter/clock/line/programme
position indicator (31) (33)

3 Timer indicator (38) (41)

4 Recording indicator (33)

5 VCR indicator (13) (34)

continued

Index to parts and controls

Rear panel

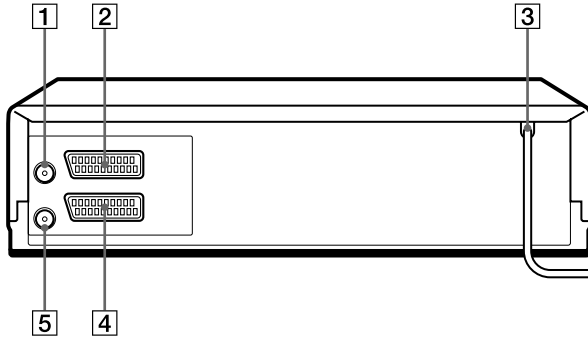

1  IN FRONT ANT. (in front antenna) connector (12) (13)

2 AV2 IN (DÉC./EXT.) connector* (28) (50)

3 Mains lead (14)

4 AV1 (EURO AV) (av1 (euro av)) connector (13) (28)

5  OUT TO TV (out to tv) connector (12) (13)

* SLV-SE210D only

Remote commander

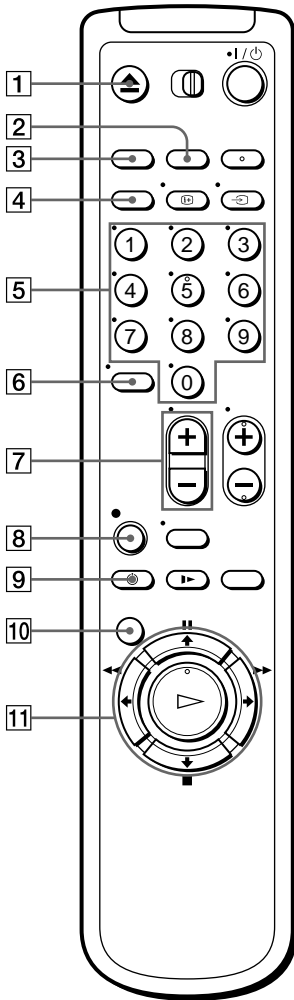

- 1 **EJECT** (eject) button (31)
- 2 **COUNTER/REMAIN** (counter/remain) button (34)
- 3 **CLEAR** (clear) button (31) (37) (45)
- 4 **SP (Standard Play)/LP (Long Play)** button (This button does not operate)
- 5 **Programme number buttons** (11) (34)
- 6 **-/-** (ten's digit) button (11) (34)
- 7 **∧** (volume) +/- buttons (*for TV*) (11)
- 8 **● REC** (record) button (33) (44)
- 9 **⌚** **TIMER** (timer) button (36) (40)
- 10 **MENU** (menu) button (17) (45)
- 11 **|| PAUSE** (pause)/**↑** button (17) (31)
■ STOP (stop)/**↓** button (17) (31)
◀◀ REW (rewind)/**←** button (31) (43)
▶▶ FF (fast-forward)/**→** button (31) (43)
▷ **PLAY** (play)/**OK** button (17) (31)

continued

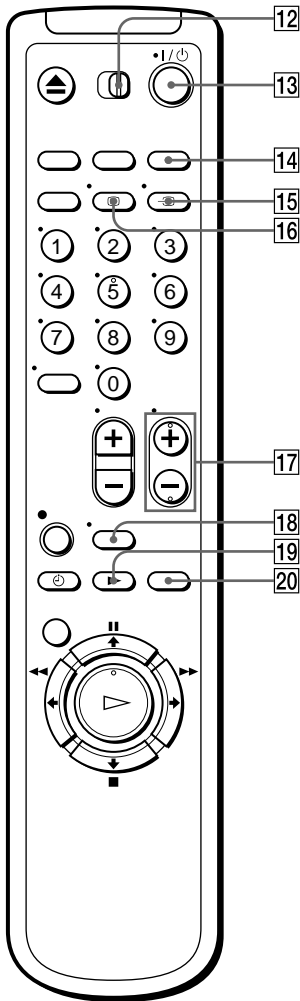

12 TV / VIDEO (TV/video) remote control switch (10)

13 I/⏻ (on/standby) switch (11) (38)

14 INPUT SELECT (input select) button (34) (41) (51)

15 TV/VIDEO (TV/video) button (11) (13) (34)

16 DISPLAY (display) button (34)

17 PROG (programme) +/- buttons (11) (33)

18 WIDE (wide) button (for TV) (11)

19 SLOW (slow) button (43)

20 x2 button (43)

Step 1 : Unpacking

Check that you have received the following items with the VCR:

- Remote commander
- Aerial cable

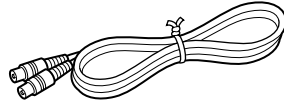
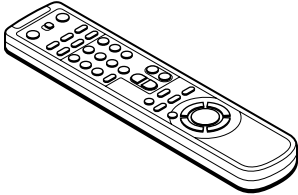

- R6 (size AA) batteries

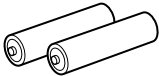

Check your model name

The instructions in this manual are for the 2 models: SLV-SE210D and SX110A. Check your model number by looking at the rear panel of your VCR. SLV-SE210D is the model used for illustration purposes. Any difference in operation is clearly indicated in the text, for example, “SLV-SX110A only.”

Step 2 : Setting up the remote commander

Inserting the batteries

Insert two R6 (size AA) batteries by matching the + and – on the batteries to the diagram inside the battery compartment.

Insert the negative (–) end first, then push in and down until the positive (+) end clicks into position.

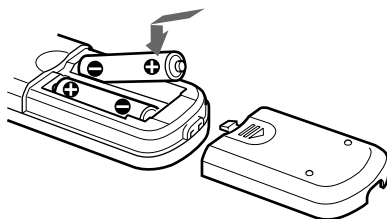

Using the remote commander

You can use this remote commander to operate this VCR and a Sony TV. Buttons on the remote commander marked with a dot (•) can be used to operate your Sony TV. If the TV does not have the  symbol near the remote sensor, this remote commander will not operate the TV.

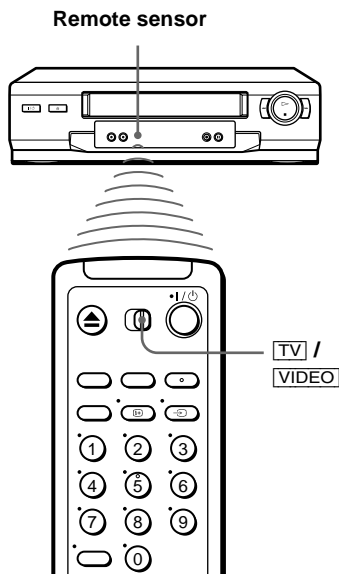

To operate	Set TV / VIDEO to
the VCR	VIDEO and point at the remote sensor at the VCR
a Sony TV	TV and point at the remote sensor at the TV

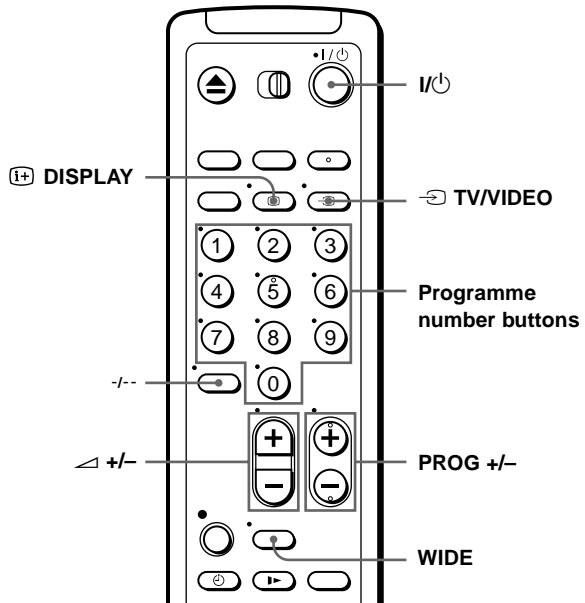

TV control buttons

To	Press
Set the TV to standby mode	I/Power
Select an input source: aerial in or line in	TV/VIDEO
Select the TV's programme position	Programme number buttons, -/--, PROG +/-
Adjust the volume of the TV	Volume +/-
Call up the on-screen display	DISPLAY
Switch to/from wide mode of a Sony wide TV	WIDE

Notes

- With normal use, the batteries should last about three to six months.
- If you do not use the remote commander for an extended period of time, remove the batteries to avoid possible damage from battery leakage.
- Do not use a new battery together with an old one.
- Do not use different types of batteries together.
- Some buttons may not work with certain Sony TVs.

Step 3 : Connecting the VCR

If your TV has a Scart (EURO-AV) connector, see page 13.

If your TV does not have a Scart (EURO-AV) connector

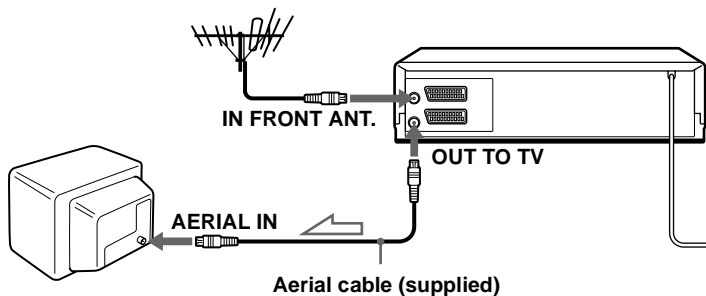

 : Signal flow

1

Disconnect the aerial cable from your TV and connect it to IN FRONT ANT. on the rear panel of the VCR.

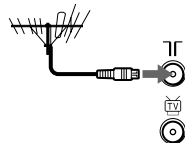

2

Connect OUT TO TV of the VCR and the aerial input of your TV using the supplied aerial cable.

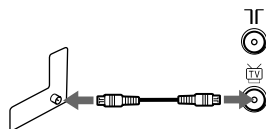

Note

- When you connect the VCR and your TV only with an aerial cable, you have to tune your TV to the VCR (see page 14).

If your TV has a Scart (EURO-AV) connector

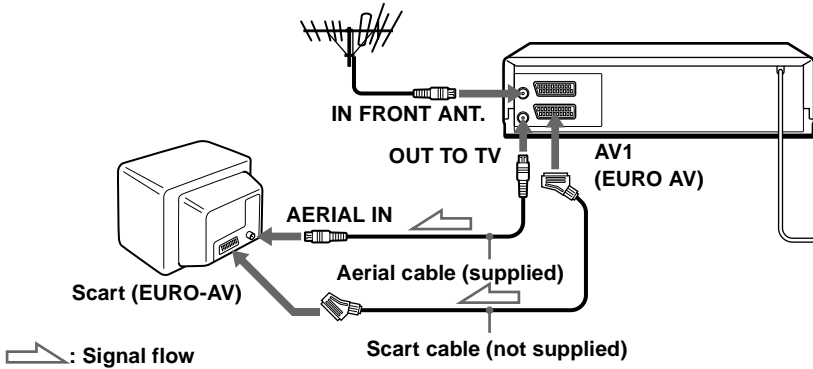

1

Disconnect the aerial cable from your TV and connect it to IN FRONT ANT. on the rear panel of the VCR.

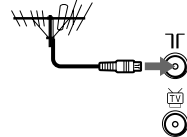

2

Connect OUT TO TV of the VCR and the aerial input of your TV using the supplied aerial cable.

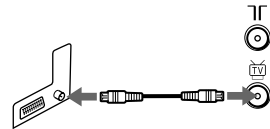

3

Connect AV1 (EURO AV) on the VCR and the Scart (EURO AV) connector on the TV with the optional Scart cable.

This connection improves picture and sound quality. Whenever you want to watch the VCR picture, press  TV/VIDEO to display the VCR indicator in the display window.

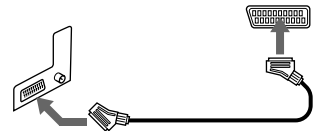



Step 4 : Setting up the VCR with the Auto Set Up function

Before using the VCR for the first time, set up the VCR using the Auto Set Up function. With this function, you can set the language for the on-screen display, TV channels, guide channels for the ShowView system*, and VCR clock* automatically.

- 1 Turn on your TV and set it to the video channel.
If your TV does not have a Scart (EURO-AV) connector, tune the TV to channel 32 (the initial RF channel for this VCR). Refer to your TV manual for TV tuning instructions. If the picture does not appear clearly, see "To change the RF channel."

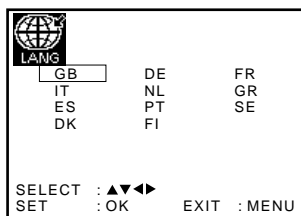
- 2 Connect the mains lead to the mains.
The VCR automatically turns on, and the language abbreviations appear on the TV screen.



- 3  Press **↑/↓/←/→** to select the abbreviation of the language from the table on page 15, then press OK.
The message for the Auto Set Up function appears.

- 4  Press OK.
The COUNTRY SELECTION menu appears.

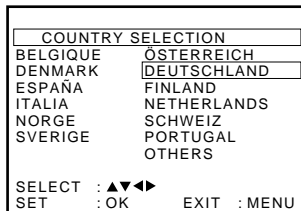

5



Press **↑/↓/←/→** to select your country, then press **OK**.

If your country does not appear, select **OTHERS**.

The VCR starts searching for all of the receivable channels and presets them (in the appropriate order for your local area).

If you want to change the order of the channels or disable unwanted programme positions, see “Changing/disabling programme positions” on page 23.

After the search or download is complete, the current time appears for any stations that transmit a time signal. If the time does not appear, set the clock manually. See “Setting the clock” on page 17.

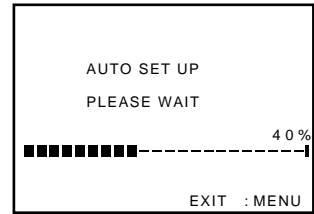

The abbreviations of the languages are as follows:

Abbreviation	Language
GB	English
DE	German
FR	French
IT	Italian
NL	Dutch
GR	Greek

Abbreviation	Language
ES	Spanish
PT	Portuguese
SE	Swedish
DK	Danish
FI	Finnish

To cancel the Auto Set Up function

Press **MENU**.

To change the RF channel

If the picture does not appear clearly on the TV, change the RF channel on the VCR and TV. Select **INSTALLATION** from the menu, then press **↑/↓** to highlight **VCR OUTPUT CH** and press **→**. Select the RF channel by pressing the **↑/↓** buttons. Then, tune the TV to the new RF channel so that a clear picture appears.

Tip

- If you want to change the language for the on-screen display from the one preset in the Auto Set Up function, see page 19.

continued

Notes

- Whenever you operate the Auto Set Up function, some of the settings (ShowView*, timer, etc.) will be reset. If this happens, you have to set them again.
- After using the Auto Set Up function, the language abbreviations do not appear automatically when you connect the mains lead again. If you want to use the Auto Set Up function again, press MENU, then press $\uparrow/\downarrow/\leftarrow/\rightarrow$ to highlight INSTALLATION and press OK. Press \uparrow/\downarrow to highlight AUTO SET UP, then repeat all procedures from step 4.

* SLV-SE210D only

Setting the clock

You must set the time and date on the VCR to use the timer features properly.

The Auto Clock Set function works only if a station in your area is broadcasting a time signal.

Before you start...

- Turn on the VCR and the TV.
- Set the TV to the video channel.
- Refer to “Index to parts and controls” for button locations.

1

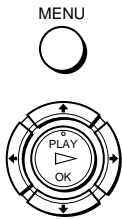

Press MENU, then press **↑/↓/←/→** to highlight CLOCK SET and press OK.

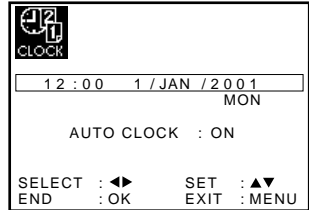

2



Press **↑/↓** to set the hour.

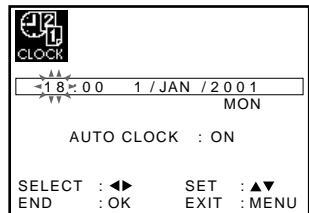

3



Press **→** to select the minutes and set the minutes by pressing **↑/↓**.

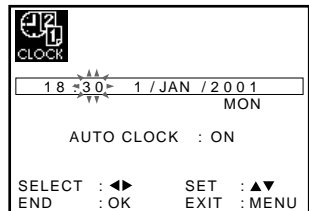

continued

4



Set the day, month, and year in sequence by pressing **→** to select the item to be set, and press **↑/↓** to select the digits, then press **→**.

The day of the week is set automatically.

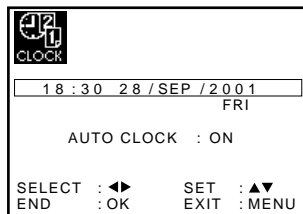

5

Press **↑/↓** to select ON for the setting the Auto Clock Set function.

The VCR automatically set the clock by the channel between PR01 to PR05 broadcasting the time signal.

If you do not need the Auto Clock Set function, select OFF.

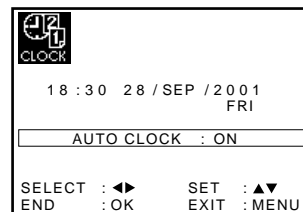

6



Press MENU to exit the menu.

Tips

- If you set AUTO CLOCK to ON, the Auto Clock Set function is activated whenever the VCR is turned off. The time is adjusted automatically by making reference to the time signal from the station.
- To change the digits while setting, press **←** to return to the item to be changed, and select the digits by pressing **↑/↓**.

Selecting a language

You can change the on-screen display language from the one you selected with the Auto Set Up function.

Before you start...

- Turn on the VCR and the TV.
- Set the TV to the video channel.
- Refer to “Index to parts and controls” for button locations.

1

MENU



Press MENU, then press **↑/↓/←/→** to highlight LANGUAGE SET and press OK.

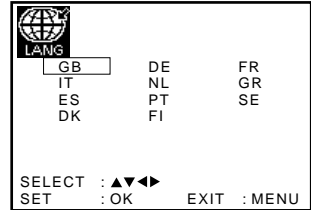

2



Press **↑/↓/←/→** to highlight the abbreviation of the desired language from the table on page 15, then press OK.

Presetting channels

If some channels could not be preset using the Auto Set Up function, you can preset them manually.

Before you start...

- Turn on the VCR and the TV.
- Set the TV to the video channel.
- Refer to "Index to parts and controls" for button locations.

1

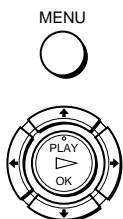

Press MENU, then press **↑/↓/←/→** to highlight INSTALLATION and press OK.

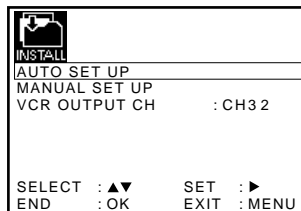

2



Press **↑/↓** to highlight MANUAL SET UP, then press **→**.

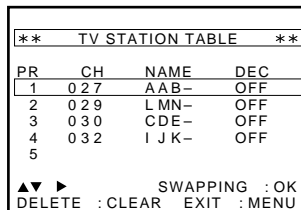

3



Press **↑/↓** to highlight the row which you want to preset, then press **→**.

To display other pages for programme positions 6 to 80, press **↑/↓** repeatedly.

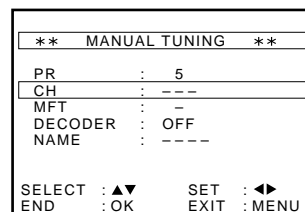

4



Press \leftarrow/\rightarrow repeatedly until the channel you want is displayed.

** MANUAL TUNING **	
PR	: 5
CH	: 033
MFT	: -
DECODER	: OFF
NAME	: ----
SELECT	: $\blacktriangle/\blacktriangledown$
END	: OK
SET	: $\blacktriangleleft/\blacktriangleright$
EXIT	: MENU

5



Press \uparrow/\downarrow to highlight NAME, then press \rightarrow .

** MANUAL TUNING **	
PR	: 5
CH	: 033
MFT	: -
DECODER	: OFF
NAME	: \uparrow \downarrow \leftarrow \rightarrow --
SELECT	: $\blacktriangle/\blacktriangledown$
END	: OK
SET	: $\blacktriangleleft/\blacktriangleright$
EXIT	: MENU

6



Enter the station name.

- 1 Press \uparrow/\downarrow to select a character.
Each time you press \uparrow , the character changes as shown below.
A \rightarrow **B** \rightarrow ... \rightarrow **Z** \rightarrow **0** \rightarrow **1** \rightarrow ... \rightarrow **9** \rightarrow **A**

- 2 Press \rightarrow to set the next character.
The next space is flashed.

The next space is flashed.

To correct a character, press \leftarrow/\rightarrow until the character you want to correct is flashed, then reset it.

You can set up to 4 characters for the station name.

** MANUAL TUNING **	
PR	: 5
CH	: 033
MFT	: -
DECODER	: OFF
NAME	: \uparrow \downarrow \leftarrow \rightarrow \leftarrow \rightarrow --
SELECT	: $\blacktriangle/\blacktriangledown$
END	: OK
SET	: $\blacktriangleleft/\blacktriangleright$
EXIT	: MENU

7



Press OK to confirm the station name.

8



Press MENU to exit the menu.

continued

If the picture is not clear

If the picture is not clear, you may use the Manual Fine Tuning (MFT) function. After step 4, press **↑/↓** to select MFT. Press **←/→** to get a clear picture, then press MENU to exit the menu.

Tip

- To set the programme position for the decoder, see “Setting PAY-TV/Canal Plus channels” on page 28.

Note

- When adjusting MFT, the menu may become difficult to read due to interference from the picture being received.

Changing/disabling programme positions

After setting the channels, you can change the programme positions as you like. If any programme positions are unused or contain unwanted channels, you can disable them.

You can also change the station names. If the station names are not displayed, you can enter them manually.

Changing programme positions

Before you start...

- Turn on the VCR and the TV.
- Set the TV to the video channel.
- Refer to "Index to parts and controls" for button locations.

1

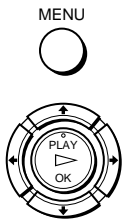

Press MENU, then press **↑/↓/←/→** to highlight INSTALLATION and press OK.

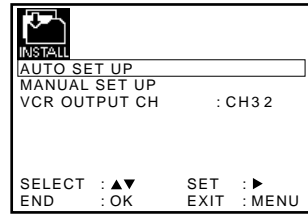

2



Press **↑/↓** to highlight MANUAL SET UP, then press **→**.

** TV STATION TABLE **			
PR	CH	NAME	DEC
1	0 2 7	A A B -	OFF
2	0 2 9	L M N -	OFF
3	0 3 0	C D E -	OFF
4	0 3 2	I J K -	OFF
5			

▲▼ ► SWAPPING : OK
DELETE : CLEAR EXIT : MENU

3



Press **↑/↓** to highlight the row which you want to change the programme position.

To display other pages for programme positions 6 to 80, press **↑/↓** repeatedly.

** TV STATION TABLE **			
PR	CH	NAME	DEC
1	0 2 7	A A B -	OFF
2	0 2 9	L M N -	OFF
3	0 3 0	C D E -	OFF
4	0 3 2	I J K -	OFF
5			

▲▼ ► SWAPPING : OK
DELETE : CLEAR EXIT : MENU

continued

4



Press OK, then press **↑/↓** to move to the desired programme position.

** TV STATION TABLE **			
PR	CH	NAME	DEC
1	0 2 7	AAB-	OFF
2			
3	0 3 0	CDE-	OFF
4	0 3 2		OFF
5	0 2 9	LMN-	OFF
▲▼			SWAPPING : OK
			EXIT : MENU

5



Press OK to confirm the setting.

6

To change the programme position of another station, repeat steps 3 through 5.

7



Press MENU to exit the menu.

Disabling unwanted programme positions

After presetting channels, you can disable unused programme positions. The disabled positions will be skipped later when you press the PROG +/- buttons.

Before you start...

- Turn on the VCR and the TV.
- Set the TV to the video channel.
- Refer to "Index to parts and controls" for button locations.

1



Press MENU, then press **↑/↓/←/→** to highlight INSTALLATION, and press OK.

	
AUTO SET UP	
MANUAL SET UP	
VCR OUTPUT CH	: CH 3 2
SELECT : ▲▼	SET : ►
END : OK	EXIT : MENU

2



Press **↑/↓** to highlight **MANUAL SET UP**, then press **→**.

** TV STATION TABLE **			
PR	CH	NAME	DEC
1	0 2 7	A A B-	OFF
2	0 2 9	L M N-	OFF
3	0 3 0	C D E-	OFF
4	0 3 2	I J K-	OFF
5			

▲▼▶ SWAPPING : OK
 DELETE : CLEAR EXIT : MENU

3



Press **↑/↓** to highlight the row which you want to disable.

To display other pages for programme positions 6 to 80, press **↑/↓** repeatedly.

** TV STATION TABLE **			
PR	CH	NAME	DEC
1	0 2 7	A A B-	OFF
2	0 2 9	L M N-	OFF
3	0 3 0	C D E-	OFF
4	0 3 2	I J K-	OFF
5			

▲▼▶ SWAPPING : OK
 DELETE : CLEAR EXIT : MENU

4



Press **CLEAR**.

The selected row will be cleared as shown on the right.

** TV STATION TABLE **			
PR	CH	NAME	DEC
1	0 2 7	A A B-	OFF
2			
3	0 3 0	C D E-	OFF
4	0 3 2	I J K-	OFF
5			

▲▼▶ SWAPPING : OK
 DELETE : CLEAR EXIT : MENU

5

Repeat steps 3 and 4 for any other programme positions you want to disable.

6



Press **MENU** to exit the menu.

Note

- Be sure to select the programme position you want to disable correctly. If you disable a programme position by mistake, you need to reset that channel manually.

continued

Changing the station names

You can change or enter the station names (up to 4 characters). The VCR must receive channel information for station names to appear automatically.

Before you start...

- Turn on the VCR and the TV.
- Set the TV to the video channel.
- Refer to "Index to parts and controls" for button locations.

1

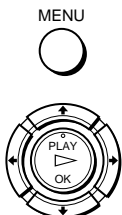

Press MENU, then press **↑/↓/←/→** to highlight INSTALL and press OK.

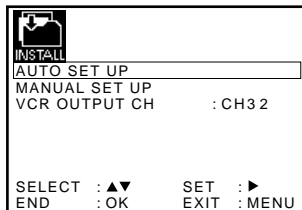

2



Press **↑/↓** to highlight MANUAL SET UP, then press **→**.

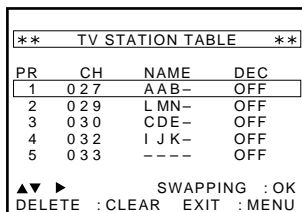

3



Press **↑/↓** to highlight the row which you want to change or enter the station name, then press **→**.

To display other pages for programme positions 6 to 80, press **↑/↓** repeatedly.

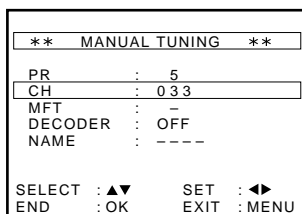

4



Press **↑/↓** to highlight NAME, then press **→**.

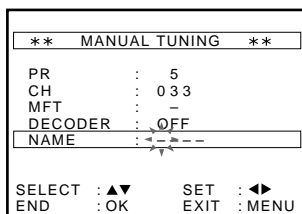

5



Enter the station name.

- 1 Press **↑/↓** to select a character.
Each time you press **↑**, the character changes as shown below.
A → B → ... → Z → 0 → 1 → ... → 9 → A

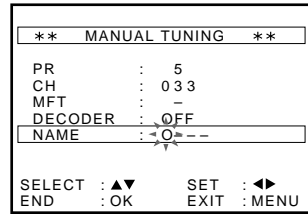

- 2 Press **→** to set the next character.

The next space is flashed.

To correct a character, press **←/→** until the character you want to correct is flashed, then reset it.

You can set up to 4 characters for the station name.

6



Press **OK** to confirm the new name.

7



Press **MENU** to exit the menu.

Setting the PAY-TV/Canal Plus decoder (SLV-SE210D only)

You can watch or record PAY-TV/Canal Plus programmes if you connect a decoder (not supplied) to the VCR.

Connecting a decoder

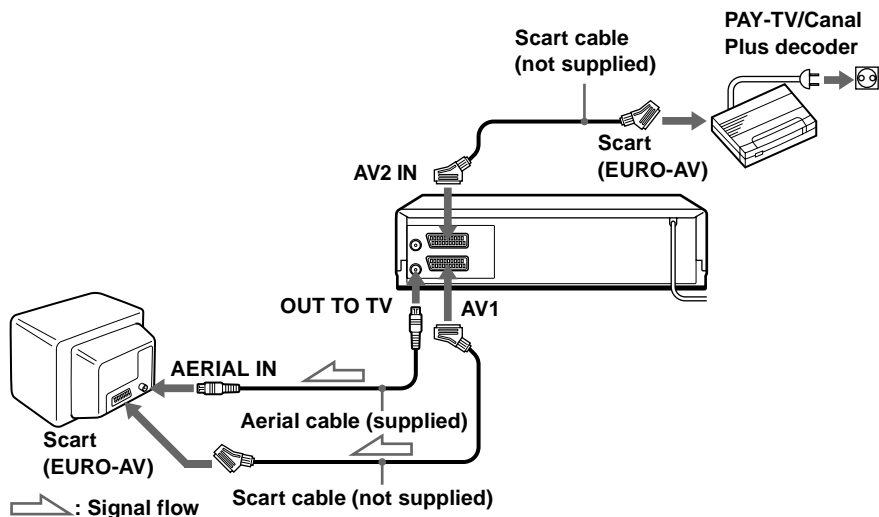

Setting PAY-TV/Canal Plus channels

To watch or record PAY-TV/Canal Plus programmes, set your VCR to receive the channels using the on-screen display.

In order to set the channels correctly, be sure to follow all of the steps below.

Before you start...

- Turn on the VCR, the TV, and the decoder.
- Set the TV to the video channel.
- Refer to "Index to parts and controls" for button locations.

1

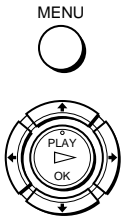

Press MENU, then press **↑/↓/←/→** to highlight INSTALLATION and press OK.

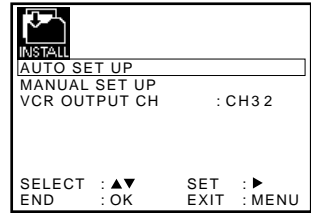

2



Press **↑/↓** to highlight MANUAL SET UP, then press **→**.

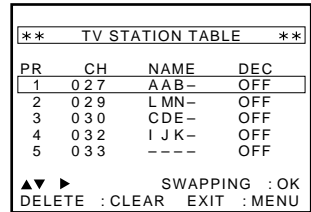

3



Press **↑/↓** to highlight the row which you want to set for the decoder, then press **→**.

To display positions 6 to 80, press **↑/↓** repeatedly.

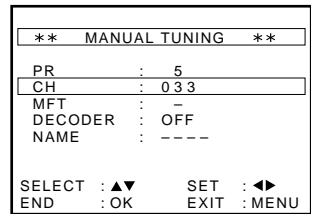

4



Press **↑/↓** to highlight DECODER.

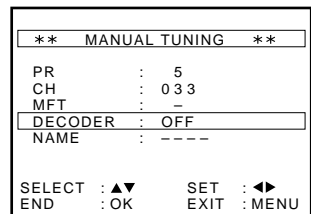

5



Press **→** to set DECODER to ON, then press OK.

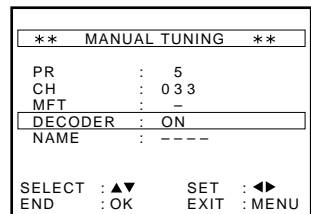

continued

6

MENU



Press MENU to exit the menu.

Notes

- To superimpose subtitles while watching PAY-TV/Canal Plus programmes, make both decoder-VCR and VCR-TV connections using 21-pin Scart cables that are compatible with the RGB signals. You cannot record subtitles on the VCR.
- When you watch PAY-TV/Canal Plus programmes through the RFU input of the TV, press  TV/VIDEO so that the VCR indicator appears in the display window.

Playing a tape

Before you start...

- Refer to “Index to parts and controls” for button locations.

1 Turn on your TV and set it to the video channel.

2 Insert a tape.
The VCR turns on and starts playing automatically if you insert a tape with its safety tab removed.

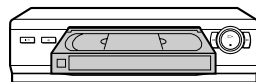

3 Press  PLAY.
When the tape reaches the end, it will rewind automatically.



Additional tasks

To	Press
Stop play	■ STOP
Pause play	▬ PAUSE
Resume play after pause	▬ PAUSE or ▷ PLAY
Fast-forward the tape	▶▶ FF during stop
Rewind the tape	◀◀ REW during stop
Eject the tape	▲ EJECT

To use the time counter

Press CLEAR at the point on the tape that you want to find later. The counter in the display window resets to “00:00.” Search for the point afterwards by referring to the counter.

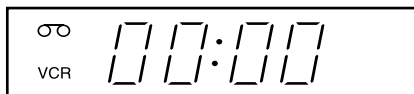

To display the counter on the TV screen, press  DISPLAY.

continued

Notes

- The counter resets to “00:00” whenever a tape is reinserted.
- The counter stops counting when it comes to a portion with no recording.
- Depending on your TV, the following may occur while playing an NTSC-recorded tape:
 - The picture becomes black and white.
 - The picture shakes.
 - No picture appears on the TV screen.
 - Black streaks appear horizontally on the TV screen.
 - The colour density increases or decreases.
- While setting the menu on the TV screen, buttons for playback on the remote commander do not function.

Recording TV programmes

Before you start...

- Refer to “Index to parts and controls” for button locations.

1 Turn on your TV and set it to the video channel.
To record from a decoder, turn it on.

2 Insert a tape with its safety tab in place.

3 Press PROG +/- to select the programme position you want to record.

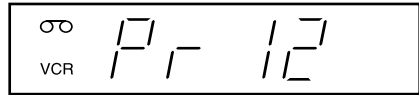

4 Press ● REC to start recording.
The recording indicator lights up red in the display window.

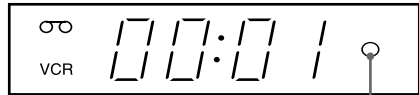

Recording indicator

To stop recording

Press ■ STOP.

To check the remaining time

Press **(i+)** DISPLAY. With the display on, press COUNTER/REMAIN to check the remaining time. Each time you press COUNTER/REMAIN, the time counter and the remaining time appear alternately.

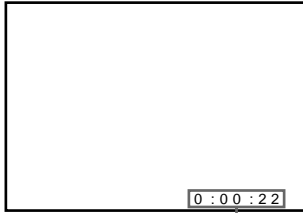

Time counter

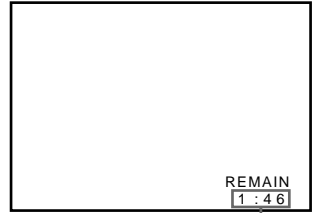

Remaining time

In order to get an accurate remaining time indication, be sure TAPE SELECT in the USER SET menu is set according to the tape type you use (see page 48).

To watch another TV programme while recording

- 1 Press **(TV/VIDEO)** to turn off the VCR indicator in the display window.
- 2 Select another programme position on the TV.

To save a recording

To prevent accidental erasure, break off the safety tab as illustrated. To record on the same tape again, cover the tab hole with adhesive tape.

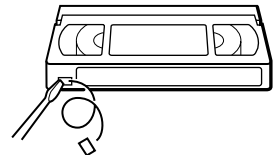

Safety tab

Tips

- To select a programme position, you can use the programme number buttons on the remote commander. For two-digit numbers, press the **-/-** (ten's digit) button followed by the programme number buttons.
- If you connect additional equipment to an input connector, you can select the input signal using the INPUT SELECT or PROG +/- buttons.
- The **(i+)** DISPLAY information appears on the TV screen indicating information about the tape, but the information won't be recorded on the tape.
- If you don't want to watch TV while recording, you can turn off the TV. When using a decoder, make sure to leave it on.

Notes

- The **(i+)** DISPLAY information does not appear during pause mode and the various speeds of playback mode. However, it will appear during normal playback.
- If a tape has portions recorded in both PAL and NTSC systems, the time counter reading will not be correct. This discrepancy is due to the difference between the counting cycles of the two video systems.
- You cannot watch a PAY-TV/Canal Plus programme while recording another PAY-TV/Canal Plus programme*.
- When you insert a non-standard commercially available tape, the remaining time may not be correct.
- The remaining time is intended for rough measurement only.
- About 30 seconds after the tape begins playback, the tape remaining time will be displayed.

* SLV-SE210D only

Recording TV programmes using the ShowView system (SLV-SE210D only)

The ShowView system is the feature that simplifies programming the VCR to make timer recordings. Just enter the ShowView number listed in the TV programme guide. The date, times, and programme position of that programme are set automatically. You can preset a total of six programmes, including settings made with other timer methods.

Before you start...

- Check that the VCR clock is set to the correct time and date.
- Insert a tape with its safety tab in place. Make sure the tape is longer than the total recording time.
- To record from a decoder, turn it on.
- Turn on your TV and set it to the video channel.
- Set TIMER METHOD to SHOWVIEW or VARIABLE in the USER SET menu (see page 49).
- Refer to “Index to parts and controls” for button locations.

1



Press TIMER.

- When you set TIMER METHOD to VARIABLE:

The TIMER METHOD menu appears on the TV screen. Press / to select SHOWVIEW, then press OK.

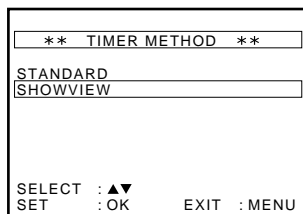

- When you set TIMER METHOD to SHOWVIEW:

The SHOWVIEW menu appears on the TV screen.

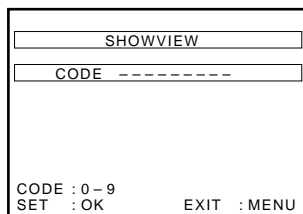

2

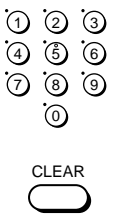

Press the programme number buttons to enter the ShowView number.

If you make a mistake, press CLEAR and re-enter the correct number.

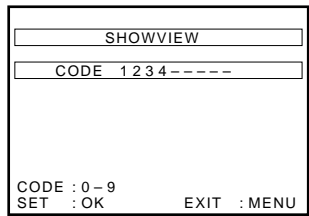

3

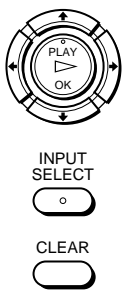

Press OK.

The date, start and stop times, programme position, and VPS/PDC setting appear on the TV screen.

- If “--” appears in the “PR” (programme) column (this may happen for local broadcasts), you have to set the appropriate programme position manually.

Press \uparrow/\downarrow to select the desired programme position.

To record from a decoder or other source connected to the input connector, press INPUT SELECT to display the connected line in the “PR” position.

You will only have to do this operation once for the referred channel. The VCR will then store your setting.

If the information is incorrect, press CLEAR to cancel the setting.

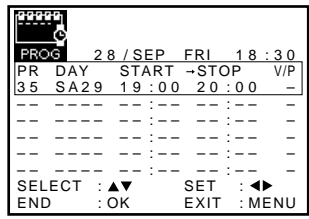

4



If you want to change the dated, and the VPS/PDC setting:

1 Press \leftarrow/\rightarrow to select the item you want to change.

2 Press \uparrow/\downarrow to reset it.

- To record the same programme every day or the same day every week, see “Daily/weekly recording” on page 38.
- To use the VPS/PDC function, set V/P to ON. For details about the VPS/PDC function, see “Timer recording with VPS/PDC signals” on page 38.

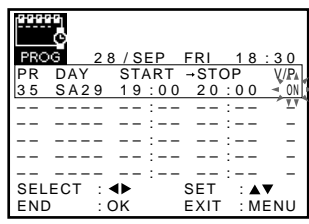

5



Press MENU to exit the menu.

continued

6



Press I/⏻ to turn off the VCR.

The ⏻ indicator appears in the display window and the VCR stands by for recording.

To record from a decoder or other source, leave the connected equipment switched on.

To stop recording

To stop the VCR while recording, press ■ STOP.

Daily/weekly recording

In step 4 above, press ↓ to select the recording pattern. Each time you press ↓, the indication changes as shown below. Press ↑ to change the indication in reverse order.

today → DLY (Monday to Sunday) → W-SA (every Saturday) → W-SU (every Sunday) → 1 month later → (dates count down) → today

Timer recording with VPS/PDC signals

Some broadcast systems transmit VPS (Video Programme System) or PDC (Programme Delivery Control) signals with their TV programmes. These signals ensure that your timer recordings are made regardless of broadcast delays, early starts, or broadcast interruptions.

To use the VPS/PDC function, set V/P to ON in step 4 above. You can also use the VPS/PDC function for a source connected to the input connector.

To use the VCR after setting the timer

To use the VCR before a recording begins, just press I/⏻. The ⏻ indicator turns off and the VCR switches on. Remember to press I/⏻ to reset the VCR to recording standby after using the VCR.



You can also do the following tasks while the VCR is recording:

- Reset the counter (page 31).
- Display tape information on the TV screen (page 34).
- Check the timer settings (page 45).
- Watch another TV programme (page 34).

Tips

- You can set the extended time for the ShowView setting by 10, 20, 30, or 60 minutes. Set SHOWVIEW EXTEND in the EASY OPERATION menu to the desired extended time (page 49).
- To check, change, or cancel the programme setting, see “Checking/changing/cancelling timer settings” (page 45).

Notes

- If the VPS/PDC signal is too weak or the broadcasting station failed to transmit VPS/PDC signals, the VCR will start recording at the set time without using the VPS/PDC function.
- The  and  indicators flash in the display window when you press I/⏻ with no tape inserted.
- When you set TIMER METHOD to STANDARD in the USER SET menu, the SHOWVIEW menu does not appear on the TV screen. Select SHOWVIEW or VARIABLE.
- The VPS/PDC function is automatically set to off for the timer recording of a satellite programme.

Recording TV programmes using the timer

You can preset a total of six programmes, including settings made with other timer methods.

Before you start...

- Check that the VCR clock is set to the correct time and date.
- Insert a tape with its safety tab in place. Make sure the tape is longer than the total recording time.
- To record from a decoder, turn it on.
- Turn on your TV and set it to the video channel.
- Set TIMER METHOD to STANDARD or VARIABLE in the USER SET menu (see page 49).
- Refer to "Index to parts and controls" for button locations.

1



Press  TIMER.

For SLV-SX110A only



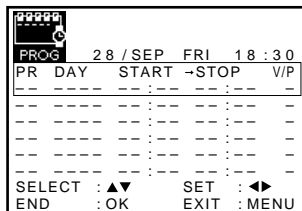

The TIMER PROGRAMMING menu appears on the TV screen.



For SLV-SE210D only

- When you set TIMER METHOD to VARIABLE:

The TIMER METHOD menu appears on the TV screen. Press / to select STANDARD, then press OK.

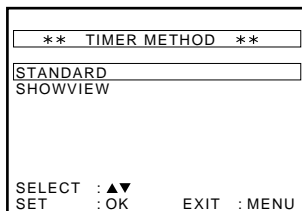

- When you set TIMER METHOD to STANDARD:

The TIMER PROGRAMMING menu appears on the TV screen.

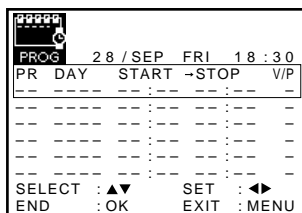

2



Set the date, start and stop times, programme position, and VPS/PDC function:

- 1 Press **→** to select each item in turn.
- 2 Press **↑/↓** to set each item. To correct a setting, press **←** to return to that setting and reset.

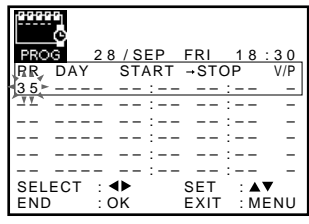

- To record the same programme every day or the same day every week, see “Daily/weekly recording” on page 41.
- To use the VPS/PDC function*, set V/P to ON. For details about the VPS/PDC function, see “Timer recording with VPS/PDC signals” on page 38.
- To record from a decoder or other source connected to the input connector, press INPUT SELECT to display the connected line in the “PR” position.

3



Press MENU to exit the menu.

4



Press **I/O** to turn off the VCR.

The **⌚** indicator appears in the display window and the VCR stands by for recording.

To record from a decoder or other source, leave the connected equipment switched on.

To stop recording

To stop the VCR while recording, press **■ STOP**.

Daily/weekly recording

In step 2 above, press **↓** to select the recording pattern. Each time you press **↓**, the indication changes as shown below. Press **↑** to change the indication in reverse order.

today → **DLY (Monday to Sunday)** → **W-SA (every Saturday)** → **W-SU (every Sunday)** → **1 month later** → **(dates count down)** → **today**

continued

To use the VCR after setting the timer

To use the VCR before a recording begins, just press I/⏻. The ⏻ indicator turns off and the VCR switches on. Remember to press I/⏻ to reset the VCR to recording standby after using the VCR.

You can also do the following tasks while the VCR is recording:

- Reset the counter (page 31).
- Display tape information on the TV screen (page 34).
- Check the timer settings (page 45).
- Watch another TV programme (page 34).

Tips

- Even if you set TIMER METHOD to SHOWVIEW in the USER SET menu, you can set the timer manually. Press MENU to select TIMER PROGRAMMING, then go to step 2.
- To check, change, or cancel the programme setting, see “Checking/changing/cancelling timer settings” (page 45).

Notes

- When setting the timer with VPS/PDC signals, enter the start and stop times exactly as indicated in the TV programme guide. Otherwise, the VPS/PDC function won't work*.
- If the VPS/PDC signal is too weak or the broadcasting station failed to transmit VPS/PDC signals, the VCR will start recording at the set time without using the VPS/PDC function*.
- The ⏻ and ⏻ indicators flash in the display window when you press I/⏻ with no tape inserted.
- The VPS/PDC function is automatically set to off for the timer recording of a satellite programme*.

* SLV-SE210D only

Playing/searching at various speeds

Before you start...

- Refer to “Index to parts and controls” for button locations.

Playback options	Operation
View the picture during fast-forward or rewind	During fast-forward, hold down ►► FF. During rewind, hold down ◀◀ REW.
Play at high speed	<ul style="list-style-type: none"> • During playback, press ►► FF or ◀◀ REW. • During playback, hold down ►► FF or ◀◀ REW. When you release the button, normal playback resumes.
Play at twice the normal speed	During playback, press ×2.
Play in slow motion	During playback, press ►► SLOW.
Play frame by frame	During pause, press ►► FF.

To resume normal playback

Press ▷ PLAY.

Tip

- Adjust the picture using the PROGRAM +/- buttons on the VCR if:
 - Streaks appear while playing in slow motion.
 - Bands appear at the top or bottom while pausing.
 - The picture shakes while pausing.

Notes

- The sound is muted during these operations.
- If the playback mode mark doesn't appear on the TV screen, press ⊕ DISPLAY.
- The picture may show noise when playing at high speed in reverse.

Setting the recording duration time

After you have started recording in the normal way, you can have the VCR stop recording automatically after a specified duration.

Before you start...

- Refer to “Index to parts and controls” for button locations.

1 While recording, press ● REC.

The ⊖ indicator appears in the display window.

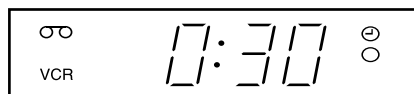

2 Press ● REC repeatedly to set the duration time.

Each press advances the time in increments of 30 minutes.

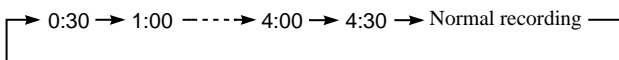

The tape counter decreases minute by minute to 0:00, then the VCR stops recording and turns off automatically.

To extend the duration

Press ● REC repeatedly to set a new duration time.

To cancel the duration

Press ● REC repeatedly until the ⊖ indicator disappears and the VCR returns to the normal recording mode.

To stop recording

To stop the VCR while recording, press ■ STOP.

Note

- You cannot display the current tape time in the display window when setting the recording duration time.

Checking/changing/cancelling timer settings

Before you start...

- Turn on your TV and set it to the video channel.
- Refer to “Index to parts and controls” for button locations.

- 1 Press **I/C** to turn on the VCR.
- 2 Press **MENU**, then press **↑/↓** to highlight **TIMER PROGRAMMING** and press **OK**.

- If you want to change or cancel a setting, go on to the next step.
- If you do not need to change or cancel the settings, press **MENU**, then turn off the VCR to return to recording standby.

PR	DAY	START	--STOP	V/P
28	SEP FRI	18:30		
35	SA29	19:00	20:00	--
29	SA29	21:00	21:30	--
30	SA 6	12:00	13:30	--
--	--	--	--	--
--	--	--	--	--
--	--	--	--	--
--	--	--	--	--
--	--	--	--	--
--	--	--	--	--

SELECT : ▲▼ SET : ◀▶
END : OK EXIT : MENU

- 3 Press **↑/↓** to select the setting you want to change or cancel, then press **→**.

The PR number on the selected row flashes.

PR	DAY	START	--STOP	V/P
28	SEP FRI	18:30		
35	SA29	19:00	20:00	--
29	SA29	21:00	21:30	--
30	SA 6	12:00	13:30	--
--	--	--	--	--
--	--	--	--	--
--	--	--	--	--
--	--	--	--	--
--	--	--	--	--
--	--	--	--	--

SELECT : ◀▶ SET : ▲▼
END : OK EXIT : MENU

- 4 • To change the setting, press **←/→** to select the item you want to change, then press **↑/↓** to reset it.
- To cancel the setting, press **CLEAR**.
- 5 Press **MENU** to exit the menu.

If any settings remain, turn off the VCR to return to recording standby.

When the timer settings overlap

The programme that starts first has priority and the second programme starts recording only after the first programme has finished. If the programmes start at the same time, the programme listed first in the menu has priority.

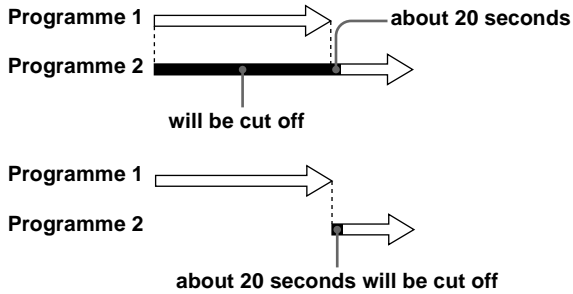

Adjusting the picture

Adjusting the tracking

Although the VCR automatically adjusts the tracking when playing a tape, distortion may occur if the recording is in poor condition. In this case, manually adjust the tracking.

During playback, press **PROGRAM +/-** on the VCR to display the tracking meter. The distortion should disappear as you press one of the two buttons. To resume automatic tracking adjustments, eject the tape and re-insert it.

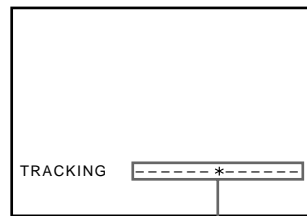

Tracking meter

Adjusting the picture sharpness

You can manually adjust the sharpness of the picture.

1 During playback, press **MENU**, then press **↑/↓/←/→** to highlight **USER SET** and press **OK**.

2 Press **↑/↓** to highlight **PICTURE**, then press **→**.

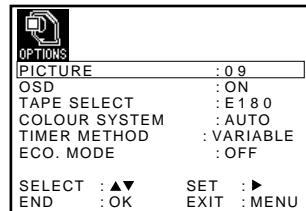

3 Press **←/→** to adjust the sharpness.

To soften the picture, press **←**.

To sharpen the picture, press **→**.

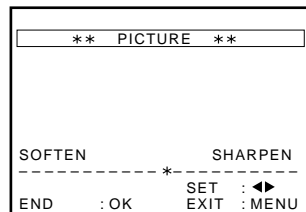

4 Press **MENU** to exit the menu.

Changing menu options

- 1 Press MENU, then select USER SET or EASY OPERATION and press OK.

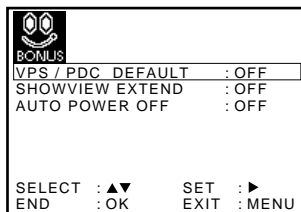
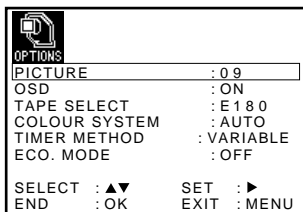

- 2 Press **↑/↓** to select the option.
- 3 Press **→** to change the setting, then press OK.
- 4 Press MENU to return to the original screen.

Menu choices

Initial settings are indicated in bold print.

USER SET

Menu option	Set this option to
PICTURE	Adjusting the sharpness of the picture by pressing ←/→ buttons. Press ← to adjust the picture getting softness. Press → to adjust the picture getting sharpness.
OSD	<ul style="list-style-type: none"> • ON to display the menu on the TV screen. • OFF to disappear the menu from the TV screen.
TAPE SELECT	<ul style="list-style-type: none"> • E180 to use an E-180 or shorter type tape. • E240 to use an E-240 type tape. • E260 to use an E-260 type tape. • E300 to use an E-300 type tape.
COLOUR SYSTEM	<ul style="list-style-type: none"> • AUTO to select the colour system automatically. • PAL to use the tape recorded in the PAL colour system. • MESECAM to use the tape recorded in the MESECAM colour system. • B/W to use the tape recorded in black and white.

Menu option	Set this option to
TIMER METHOD*	<ul style="list-style-type: none"> • VARIABLE to display the TIMER METHOD menu for selecting STANDARD or SHOWVIEW when pressing the ⏻ TIMER button. • STANDARD to display the PROG menu when pressing the ⏻ TIMER button. • SHOWVIEW to display the SHOWVIEW menu when pressing the ⏻ TIMER button. For details, see page 36 and 40.
ECO. MODE	<ul style="list-style-type: none"> • ON to turn off the indicators in the display window to conserve the VCR's power. • OFF to turn on the indicators in the display window while the VCR is standing by.

EASY OPERATION

Menu option	Set this option to
VPS/PDC DEFAULT*	<ul style="list-style-type: none"> • OFF to deactivate the VPS/PDC function. • ON to activate it.
SHOWVIEW EXTEND*	<ul style="list-style-type: none"> • OFF to deactivate the ShowView Extend function. • 10/20/30/60 (minutes) to extend the time of the ShowView setting by the selected amount of time.
AUTO POWER OFF	<ul style="list-style-type: none"> • OFF to deactivate the Auto Power Off function. • 2HOUR/3HOUR to turn the VCR off automatically if no signal is received and you do not press any of the buttons during this time.

* SLV-SE210D only

Editing with another VCR

How to connect to record on this VCR

Connect the line outputs of the other VCR to the input connector of this VCR. Refer to the examples A or B and choose the connection that best suits your VCR.

Example A

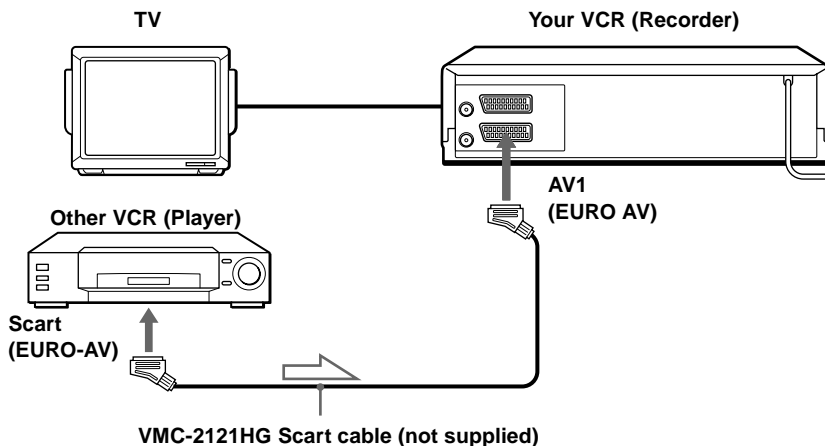

 : Signal flow

Example B (SLV-SE210D only)

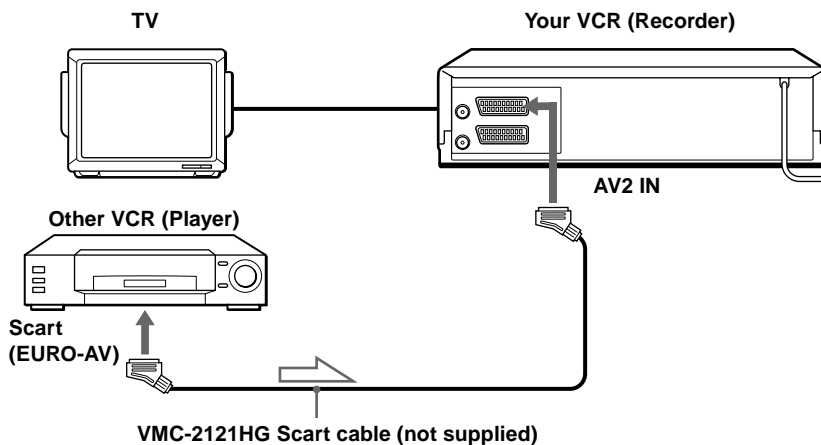

 : Signal flow

Note

- If the other VCR does not have a Scart (EURO-AV) connector, use the VMC-2106HG cable instead and connect the cable to the line out jacks of the other VCR.

Operation (when recording on this VCR)

Before you start editing

- Turn on your TV and set it to the video channel.
- Press INPUT SELECT to display the connected line in the display window.

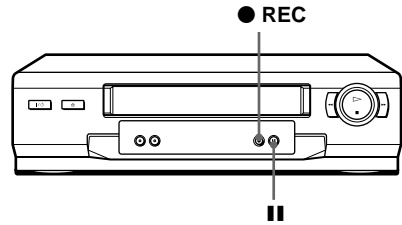

- 1** Insert a source tape with its safety tab removed into the other (playback) VCR. Search for the point to start playback and set it to playback pause.
- 2** Insert a tape with its safety tab in place into this (recording) VCR. Search for the point to start recording and press **||** (pause).
- 3** Press **● REC** on this VCR to set it to recording pause.
- 4** To start editing, press the **||** (pause) buttons on both VCRs at the same time.

To stop editing

Press the **■** (stop) buttons on both VCRs.

Tip

- To cut out unwanted scenes while editing, press **||** (pause) on this VCR when an unwanted scene begins. When it ends, press **||** (pause) again to resume recording.

Troubleshooting

If you have any questions or problems not covered below, please consult your nearest Sony service facility.

	Symptom	Remedy
Power	The I/⏻ (on/standby) switch does not function.	<ul style="list-style-type: none"> Connect the mains lead to the mains securely.
	The power is turned on but the VCR does not operate.	<ul style="list-style-type: none"> Moisture condensation has occurred. Turn the power off, unplug the mains lead and leave the VCR to dry for over three hours.
Clock	The clock has stopped and “--:--” appears in the display window.	<ul style="list-style-type: none"> The clock stops if the VCR is disconnected from the mains for more than one hour. Reset the clock (and timer).
Playback	The playback picture does not appear on the TV screen.	<ul style="list-style-type: none"> Make sure the TV is set to the video channel. If you are using a monitor, set it to video input. If the VCR is connected to the TV with the Scart cable, make sure the VCR indicator is lit in the display window. Use the TV/VIDEO button on the remote commander to light up the VCR indicator.
	The picture is not clear.	<ul style="list-style-type: none"> Existing broadcasts may interfere with the VCR. Reset the RF channel output of your VCR. Adjust the tracking with the PROGRAM +/- buttons <u>on the VCR</u>. The video heads are dirty (see the last page of Troubleshooting). Clean the video heads using the Sony T-25CLD, E-25CLDR, or T-25CLW video head cleaning cassette. If these cleaning cassettes are not available in your area, have the heads cleaned at your nearest Sony service facility (a standard service charge will be required). Do not use a commercially available liquid type cleaning cassette other than Sony's, as it may damage the video heads. The video heads may have to be replaced. Consult your local Sony service facility for more information.
	The picture rolls vertically during picture search.	<ul style="list-style-type: none"> Adjust the vertical hold control on the TV or monitor.
	The picture has no sound.	<ul style="list-style-type: none"> The tape is defective.

	Symptom	Remedy
Recording	No TV programme appears on the TV screen.	<ul style="list-style-type: none"> • Make sure the TV is set to the video channel. If you are using a monitor, set it to video input. • Existing broadcasts may interfere with the VCR. Reset the RF channel output of your VCR. • Select the correct source with the INPUT SELECT button. Select a programme position when recording TV programmes; select a line input when recording from other equipment.
	TV reception is poor.	<ul style="list-style-type: none"> • Make sure the aerial cable is connected securely. • Adjust the TV aerial.
	The tape starts playing as soon as it is inserted.	• The safety tab has been removed. To record on this tape, cover the tab hole (see page 34).
	The tape is ejected when you press ● REC.	• The safety tab has been removed. To record on this tape, cover the tab hole (see page 34).
	Nothing happens when you press ● REC.	• Make sure the tape is not at its end.
Timer recording	The timer does not operate.	<ul style="list-style-type: none"> • Check that the clock is set. • Make sure a tape has been inserted. • Check that the safety tab has not been removed. • Make sure the tape is not at its end. • Make sure a programme has been set for timer recording. • Make sure your timer settings are past the current time. • Check that the decoder is turned on. • Check that the satellite tuner is turned on. • The clock stops if the VCR is disconnected from the mains for more than one hour. Reset the clock and timer. • Turn the power off and unplug the mains lead.
	The SHOWVIEW menu or the PROG menu does not appear.	• Check that TIMER METHOD in the USER SET menu is set correctly (see page 49).
	The VPS/PDC function does not operate properly.	<ul style="list-style-type: none"> • Check that the clock and the date are set correctly. • Check that the VPS/PDC time you set is the correct one (there might be a mistake in the TV programme guide). If the broadcast you wanted to record did not send the good VPS/PDC information, the VCR will not start recording. • If the reception is poor, the VPS/PDC signal might be altered and the VCR might not start recording.

continued

	Symptom	Remedy
PAY-TV/Canal Plus	You cannot watch PAY-TV/Canal Plus programmes when the VCR is in standby mode.	<ul style="list-style-type: none"> Make sure the PAY-TV/Canal Plus Scart cable is plugged securely.
	A PAY-TV/Canal Plus programme is always recorded scrambled.	<ul style="list-style-type: none"> Make sure the PAY-TV/Canal Plus Scart cable is plugged securely. Check that DECODER is set to ON for this channel in the MANUAL TUNING menu (see page 28).
Others	A tape cannot be inserted.	<ul style="list-style-type: none"> Check that a tape isn't already in the tape compartment.
	The remote commander does not function.	<ul style="list-style-type: none"> Make sure you are pointing the remote commander at the remote sensor on the VCR. Replace all the batteries in the remote commander with new ones if they are weak. Make sure the TV / VIDEO remote control switch is set correctly.
	The tracking meter does not appear on the TV screen.	<ul style="list-style-type: none"> The recording condition of the tape is very poor and tracking cannot be adjusted.
	The display window becomes dim.	<ul style="list-style-type: none"> The display window automatically becomes dim when the VCR is in standby or timer recording mode.
	The VCR needs to be cleaned.	<ul style="list-style-type: none"> Clean the cabinet, panel and controls with a dry, soft cloth, or a soft cloth slightly moistened with a mild detergent solution. Do not use any type of solvent, such as alcohol or benzine.

Symptoms caused by contaminated video heads

• Normal picture



• Rough picture



initial
contamination

• Unclear picture



• No picture (or
black & white
screen appears)



terminal



Specifications

System

Channel coverage

PAL (B/G)

VHF E2 to E12

VHF Italian channel A to H

UHF E21 to E69

CATV S01 to S05, S1 to S20

HYPER S21 to S41

RF output signal

UHF channels 21 to 69

Aerial out

75-ohm asymmetrical aerial socket

Tape speed

SP: PAL 23.39 mm/s
(recording/playback)

MESECAM
23.39 mm/s
(recording/playback)

NTSC 33.35 mm/s
(playback only)

Maximum recording/playback time

5 hrs. in SP mode (with E300 tape)

Rewind time

Approx. 60 sec. (with E180 tape)

Inputs and outputs

AV1 (EURO AV)

21-pin

Video input: pin 20

Audio input: pins 2 and 6

Video output: pin 19

Audio output: pins 1 and 3

AV2 IN (SLV-SE210D only)

21-pin

Video input: pin 20

Audio input: pins 2 and 6

General

Power requirements

230 V AC, 50 Hz

Power consumption

15 W

3 W (ECO. MODE is set to ON, Standby mode)

Operating temperature

5°C to 40°C

Storage temperature

-20°C to 60°C

Dimensions

Approx. 360 × 94 × 255 mm (w/h/d)
including projecting parts and controls

Mass

Approx. 2.6 kg

Supplied accessories

Remote commander (1)

R6 (size AA) batteries (2)

Aerial cable (1)

Design and specifications are subject to change without notice.

Index

A

- Adjusting
 - picture 47
 - tracking 47
- Aerial hookup 12
- Auto Set Up 14

C

- Canal Plus 28
- Changing the programme position 23
- Changing the station name 26
- Cleaning the video heads 52
- Clock setting 17
- Colour system
 - compatible colour systems 2
- Connecting
 - the VCR and your TV 12, 13
 - to a TV with a Scart (EURO-AV) connector 13
- Counter 31

D

- Disabling the programme positions 24
- Dubbing. *see* Editing

E

- Editing 50

O

- Optional setting 48

P

- PAY-TV 28
- PDC (Programme Delivery Control) 38
- Playback 31
 - at various speeds 43
 - frame-by-frame 43
 - slow motion 43
- Presetting channels 20

R

- Recording 33
 - duration time 44
 - saving 34
 - timer setting 40
 - using the ShowView system 36
 - while watching another programme 34

S

- Safety tab 34
- Scart connection 13
- Searching
 - at various speeds 43
- ShowView
 - recording 36

T

- Timer setting 40
 - cancelling 45
 - changing 45
 - checking 45
 - daily/weekly recording 38, 41
 - using the ShowView system 36

V

- VPS (Video Programme System) 38

Quick Start Guide

1 Connecting the VCR

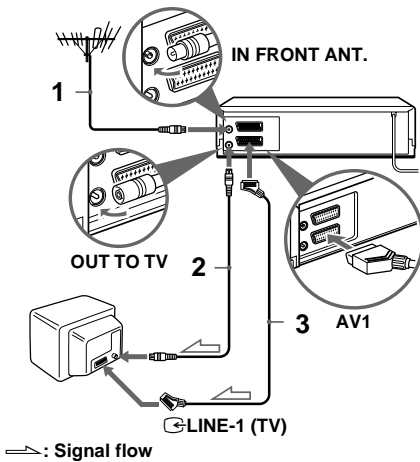

- 1... Connect the aerial to IN FRONT ANT. of the VCR.
- 2... Connect OUT TO TV and the aerial input of your TV using the supplied aerial cable.
- 3... For better picture and sound, connect AV1 (EURO AV) to your TV using a Scart cable if your TV has a Scart (EURO-AV) connector.

2 Using the Auto Set Up function

- 1 ...Turn on your TV and set it to the video channel.
If your TV does not have a Scart (EURO-AV) connector, tune the TV to channel 32 (the initial RF channel of this VCR). Refer to your TV's manual for TV tuning instructions. If the picture does not appear clearly, see "To change the RF channel."
- 2 ...Connect the mains lead to the mains.
- 3 ...Press **↑/↓/←/→** to select a language, then press OK.
- 4 ...Press OK again.
- 5 ...Press **↑/↓/←/→** to select your country, then press OK.

When all of the receivable channels are preset, the menu disappears from the TV screen. You can rearrange the programme position in any order (see "Changing/disabling programme positions").

After the search or download is complete, the current time appears automatically. If the time does not appear, set the clock manually. See "Setting the clock."

Now you can operate your VCR.

SONY®



Free Manuals Download Website

<http://myh66.com>

<http://usermanuals.us>

<http://www.somanuals.com>

<http://www.4manuals.cc>

<http://www.manual-lib.com>

<http://www.404manual.com>

<http://www.luxmanual.com>

<http://aubethermostatmanual.com>

Golf course search by state

<http://golfingnear.com>

Email search by domain

<http://emailbydomain.com>

Auto manuals search

<http://auto.somanuals.com>

TV manuals search

<http://tv.somanuals.com>