

Video Cassette Recorder

Operating Instructions



VHS

Power Trilogic

SLV-L49 MX

SLV-L52 PA/PC

SLV-L59 CL/CS/PR/VZ

SLV-X55 MX

SLV-L69HF MX

Hi-Fi

SLV-L72HF PA/PC

Hi-Fi

SLV-L79HF CL/CS/VZ

Hi-Fi

SLV-L89HF CL/CS/MX/VZ

Hi-Fi

SLV-X66HF MX

Hi-Fi

WARNING

To prevent fire or shock hazard, do not expose the unit to rain or moisture.

The power cord must be changed only at a qualified service shop.

Precautions

Safety

- For SLV-L59 CL/CS/PR, L79HF CL/CS and L89HF CL/CS, operate the unit on 110 to 240 V AC, 50/60 Hz. For SLV-L49 MX, L52 PA/PC, L59 VZ, X55 MX, L69HF MX, L72HF PA/PC, L79HF VZ, L89HF MX/VZ and X66HF MX, operate the unit only on 120 V AC, 60 Hz.
- If anything falls into the cabinet, unplug the unit and have it checked by qualified personnel before operating it any further.
- This unit is not disconnected from the AC power source (mains) as long as it is connected to the wall outlet, even if the unit itself has been turned off.
- Unplug the unit from the wall outlet if you do not intend to use it for an extended period of time. To disconnect the cord, pull it out by the plug, never by the cord.

Installing

- Allow adequate air circulation to prevent internal heat buildup.
- Do not place the unit on surfaces (rugs, blankets, etc.) or near materials (curtains, draperies) that may block the ventilation slots.
- Do not install the unit near heat sources such as radiators or air ducts, or in a place subject to direct sunlight, excessive dust, mechanical vibration or shock.
- Do not install the unit in an inclined position. It is designed to be operated in a horizontal position only.
- Keep the unit and cassettes away from equipment with strong magnets, such as microwave ovens or large loudspeakers.
- Do not place heavy objects on the unit.
- If the unit is brought directly from a cold to a warm location, moisture may condense inside the VCR and cause damage to the video head and tape. When you first install the unit, or when you move it from a cold to a warm location, wait for about three hours before operating the unit.

Caution

Television programs, films, video tapes and other materials may be copyrighted. Unauthorized recording of such material may be contrary to the provisions of the copyright laws. Also, use of this recorder with cable television transmission may require authorization from the cable television transmission and/or program owner.

Information

"Power Trilogic" is a trademark of Sony Corporation.

Table of contents

Getting Started

- 4 Step 1: Unpacking
- 5 Step 2: Setting up the remote commander
- 7 Step 3: Hookups
- 24 Selecting a language
- 25 Setting the clock
- 31 Presetting channels

Basic Operations

- 38 Playing a tape
- 41 Recording TV programs
- 44 Recording TV programs using the timer

Additional Operations

- 48 Playing/searching at various speeds
- 51 Searching for a selected point on the tape
- 53 Skip-searching automatically
- 54 Recording TV programs using the dial timer
- 57 Setting the recording duration time
- 58 Checking/changing/canceling timer settings
- 60 Recording stereo and bilingual programs (SLV-L69HF MX, L72HF PA/PC, L79HF CL/CS/VZ, L89HF CL/CS/MX/VZ and X66HF MX only)

- 62 Adjusting the picture
- 64 Changing menu options
- 65 Editing with another VCR

Additional Information

- 67 General setup information
- 69 Troubleshooting
- 71 Specifications
- 72 Index to parts and controls
- 79 Index
- back cover
 - Quick reference to using the VCR

Step 1

Unpacking

Check that you have received the following items with the VCR:

- Remote commander

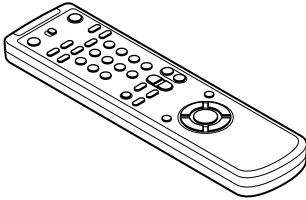

- 75-ohm coaxial cable with F-type connectors

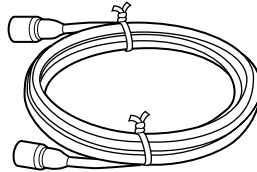

- Size AA (R6) batteries

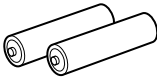

- Audio/video cable (3-phono to 3-phono) (SLV-L69HF MX, L72HF PA/PC, L79HF CL/CS/VZ, L89HF CL/CS/MX/VZ and X66HF MX only)

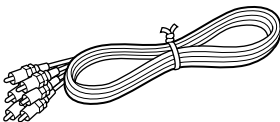

- Plug adaptor (SLV-L59 CL/CS/PR, L79HF CL/CS and L89HF CL/CS only)

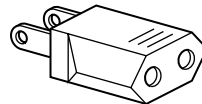

If the plug supplied with your VCR does not fit your power outlet, attach the supplied adaptor to the plug.

Checking your model name

The instructions in this manual are for the 19 models: SLV-L49 MX, L52 PA/PC, L59 CL/CS/PR/VZ, X55 MX, L69HF MX, L72HF PA/PC, L79HF CL/CS/VZ, L89HF CL/CS/MX/VZ and X66HF MX. Check your model number by looking at the rear panel of your VCR. The SLV-L89HF MX is the model used for illustration purposes. Any difference in operation is clearly indicated in the text, for example, "SLV-X66HF MX only".

Step 2

Setting up the remote commander

Inserting the batteries

Insert two size AA (R6) batteries by matching the + and - on the batteries to the diagram inside the battery compartment.

Insert the negative (-) end first, then push in and down until the positive (+) end clicks into position.

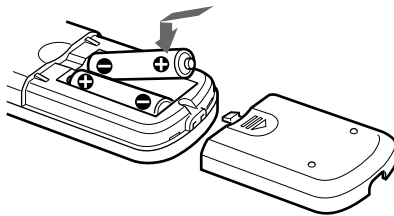

Using the remote commander

You can use this remote commander to operate this VCR and a Sony TV. Buttons on the remote commander marked with a dot (•) can be used to operate your Sony TV.

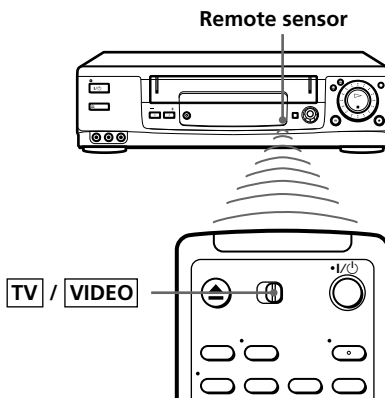

To operate	Set TV / VIDEO to
the VCR	VIDEO and point at the remote sensor on the VCR
a Sony TV	TV and point at the remote sensor on the TV

Notes

- With normal use, the batteries should last about three to six months.
- If you do not use the remote commander for an extended period of time, remove the batteries to avoid possible damage from battery leakage.
- Do not use a new battery with an old one.
- Do not use different types of batteries.

continued

Step 2: Setting up the remote commander (continued)

Controlling other TVs with the remote commander (SLV-L69HF MX, L72HF PA/PC, L79HF CL/CS/VZ, L89HF CL/CS/MX/VZ and X66HF MX only)

The remote commander is preprogrammed to control non-Sony TVs. If your TV is listed in the table below, set the appropriate manufacturer's code number.

- 1 Set **[TV]/[VIDEO]** at the top of the remote commander to **[TV]**.
- 2 Hold down **I/⏻**, and enter your TV's code number(s) using the number buttons. Then release **I/⏻**.

Now you can use the **I/⏻**, **VOL +/-**, **CH +/-** and **TV/VIDEO** buttons to control your TV. You can also use the buttons marked with a dot (●) to control a Sony TV. To control the VCR, reset **[TV]/[VIDEO]** to **[VIDEO]**.

Code numbers of controllable TVs

If more than one code number is listed, try entering them one at a time until you find the one that works with your TV.

Manufacturer	Code number	Manufacturer	Code number	Manufacturer	Code number
Sony	01	JVC	09	RCA	04, 10
Akai	04	KMC	03	Sampo	12
AOC	04	Magnavox	03, 08, 12	Sanyo	11
Centurion	12	Marantz	04, 13	Scott	12
Coronado	03	MGA/Mitsubishi	04, 12, 13, 17	Sears	07, 10, 11
Curis-Mathes	12	NEC	04, 12	Sharp	03, 05, 18
Daytron	12	Panasonic	06, 19	Sylvania	08, 12
Emerson	03, 04, 14	Philco	03, 04	Teknika	03, 08, 14
Fisher	11	Philips	08	Toshiba	07
General Electric	06, 10	Pioneer	16	Wards	03, 04, 12
Gold Star	03, 04, 17	Portland	03	Yorx	12
Hitachi	02, 03	Quasar	06, 18	Zenith	15
J.C.Penny	04, 12	Radio Shack	05, 14		

Notes

- If the TV uses a different remote control system from the one programmed to work with the VCR, you cannot control your TV with the remote commander.
- If you enter a new code number, the code number previously entered will be erased.
- When you replace the batteries of the remote commander, the code number may change. Set the appropriate code number every time you replace the batteries.
- When you press the AUDIO MONITOR button, your TV's menu may appear on the TV screen. To exit the TV menu, press the MENU button on the TV remote commander or wait until the menu disappears automatically.

Step 3

Hookups

Selecting the best hookup option

There are many ways in which your VCR can be hooked up. To hook up your VCR so that it works best for you, first scan through the table below. Then use the accompanying diagrams and procedures on the following pages to set up your VCR.

If you have	Use	Refer to
TV that has audio/video input	Audio/video (A/V) hookup , then follow one of the hookups below.	Pages 8 to 10
Antenna only, no cable TV	Hookup 1	Pages 11 to 13
No cable box, or cable box with only a few scrambled channels	Hookup 2	Pages 14 to 16
Cable box, with many scrambled channels	Hookup 3	Pages 17 to 19
Cable box with only a few scrambled channels, using an A/B switch	Hookup 4	Pages 20 to 23

After you've completed the connections, follow the instructions for setup. During setup, if you need more details on the procedure described, page numbers are provided where you can find complete, step-by-step instructions.

After you've completed the setup, you're ready to use your VCR. Procedures differ depending on the hookup you used. For an overview, refer to "Quick reference to using the VCR" on the back cover.

Before you get started

- Turn off the power to all equipment.
- Do not connect the AC power cords until all of the connections are completed.
- Be sure you make connections firmly. Loose connections may cause picture distortion.
- If your TV doesn't match any of the examples provided, see your nearest Sony dealer or qualified technician.

continued

Step 3: Hookups (continued)

Audio/video (A/V) hookup

Pages 8 to 10

If your TV has audio/video (A/V) input jacks, you will get a better picture and sound when you hook up your VCR using these connections. If your TV doesn't have A/V inputs, see the following pages for antenna or cable hookups.

If you're not planning to use your VCR to record programs, you're finished setting up the VCR after you've made the connections shown on pages 8 and 9.

If you want to record off-air or off your cable TV system, complete these connections first, and then go to the following pages for antenna or cable hookups.

For SLV-L49 MX, L52 PA/PC, L59 CL/CS/PR/VZ and X55 MX

A Use this hookup if your TV has stereo jacks

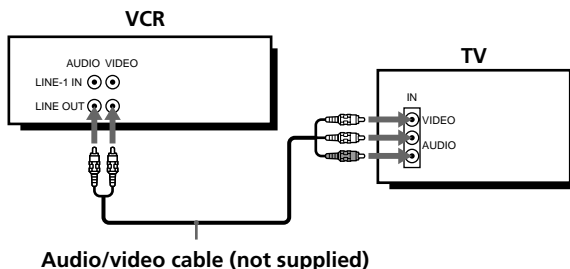

B Use this hookup if your TV doesn't have stereo jacks

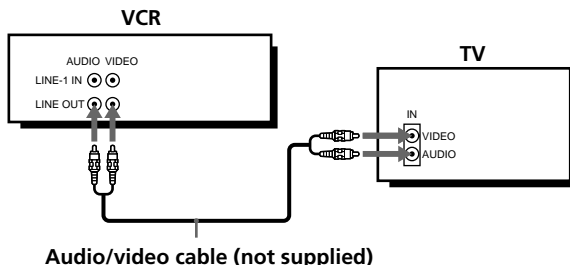

Note

- If you use the Trinitron TV Synchro Play function (see page 40), the A/V connection is necessary. (If your TV has two or more inputs, connect the audio/video cable to the VIDEO IN 1 jacks.)

For SLV-L69HF MX, L72HF PA/PC, L79HF CL/CS/VZ, L89HF CL/CS/MX/VZ and X66HF MX

For a true "home theater" experience, you should connect the audio outputs of your VCR or TV to your stereo system.

A Use this hookup if your TV has stereo jacks

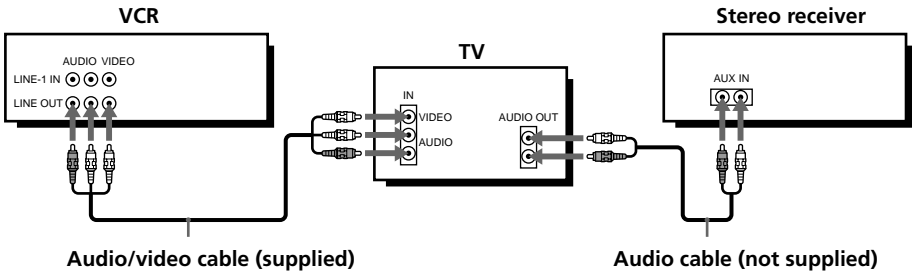

B Use this hookup if your TV doesn't have stereo jacks

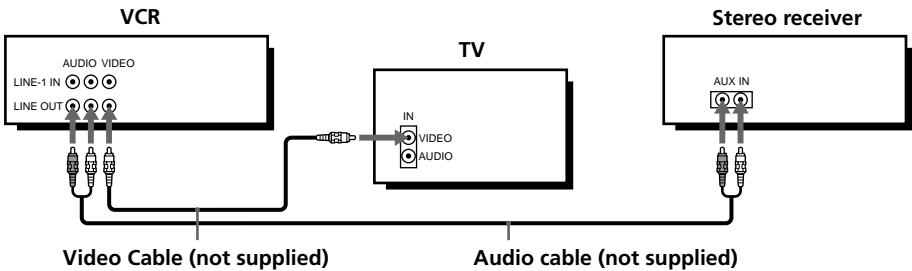

Notes

- To play a tape in stereo, you must use the A/V connection.
- If you use the Trinitron TV Synchro Play function (see page 40), the A/V connection is necessary. (If your TV has two or more inputs, connect the audio/video cable to the VIDEO IN 1 jacks.)

continued

Step 3: Hookups (continued)

A/V hookup: VCR setup

After you've connected your TV and completed antenna or cable hookup, use the following procedure to set up the VCR.

Press **MENU** and select **ADVANCED OPTIONS**.

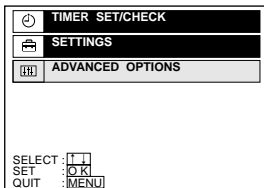

Set **AUTO ANT SELECT** to **OFF** and press **OK**.

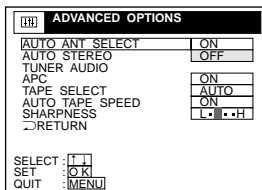

For details, see page 64.

Antenna hookup

Make the following connections if you're using an antenna (if you don't have cable TV).

A Use this hookup if you're using:

- VHF/UHF antenna (you get channels 2–13 and channels 14 and higher)
- UHF-only antenna (you get channels 14 and higher)
- Separate VHF and UHF antennas

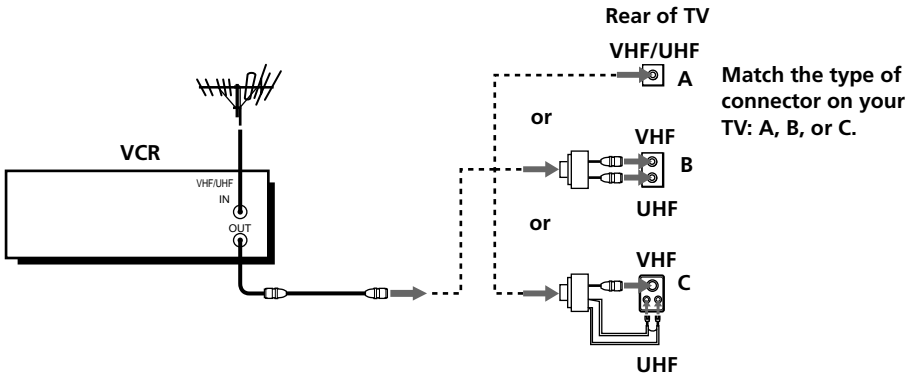

B Use this hookup if you're using a VHF-only antenna (you get channels 2–13 only)

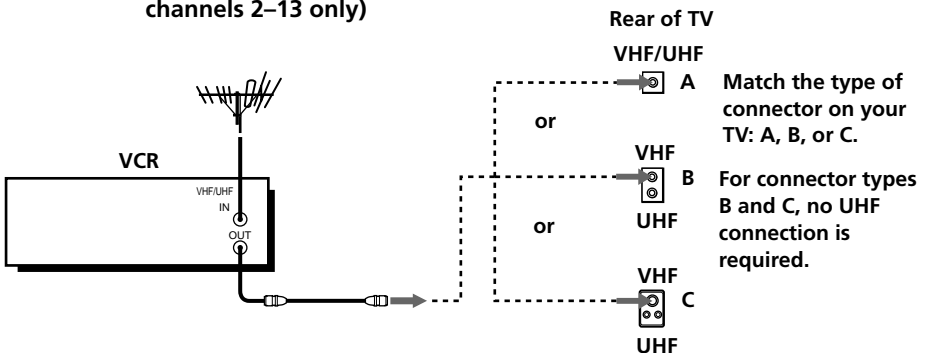

If you cannot connect your antenna cable to the VCR directly

If your antenna cable is a flat cable (300-ohm twin lead cable), attach an external antenna connector (not supplied) so you can connect the cable to the VHF/UHF IN connector. If you have separate cables for VHF and UHF antennas, you should use a U/V band mixer (not supplied). For details, see page 68.

continued

Step 3: Hookups (continued)

Hookup 1: VCR setup

- 1 Set the RF UNIT switch to CH3 or CH4, whichever channel is not used in your area. If both are used, set the switch to either channel. For details, see page 67. If you made A/V connections (from page 8), you can skip this step.
- 2 Press EASY SET UP on the VCR.

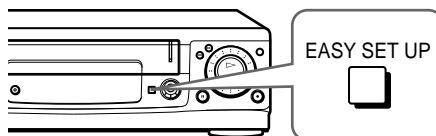
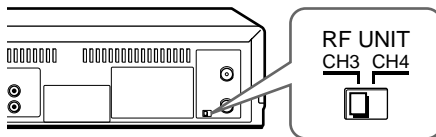

- 1 The IDIOMA menu appears. Change the on-screen display language to English (ENGLISH) if desired, and press OK. For details, see page 24.

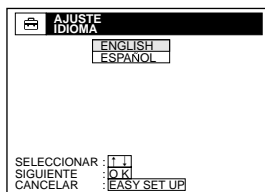

- 2 The CLOCK SET menu appears. Select MANUAL and press OK. Then set the clock. For details, see page 29.

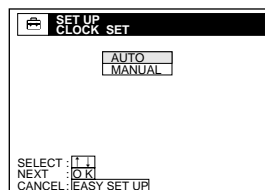

- ③ The TUNER PRESET menu appears. Set ANTENNA/CABLE to ANT and press OK. For details, see page 31.

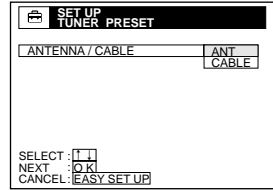

- ④ The AUTO PRESET starts.

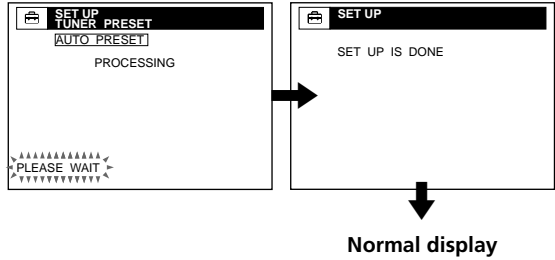

continued

No cable box, or cable box with only a few scrambled channels

Recommended use

Use this hookup if you do not have a cable box. Also use this hookup if your cable system scrambles only a few channels.

What you can do with this hookup

- Record any unscrambled channel by selecting the channel on the VCR

What you can't do

- Record scrambled channels that require a cable box

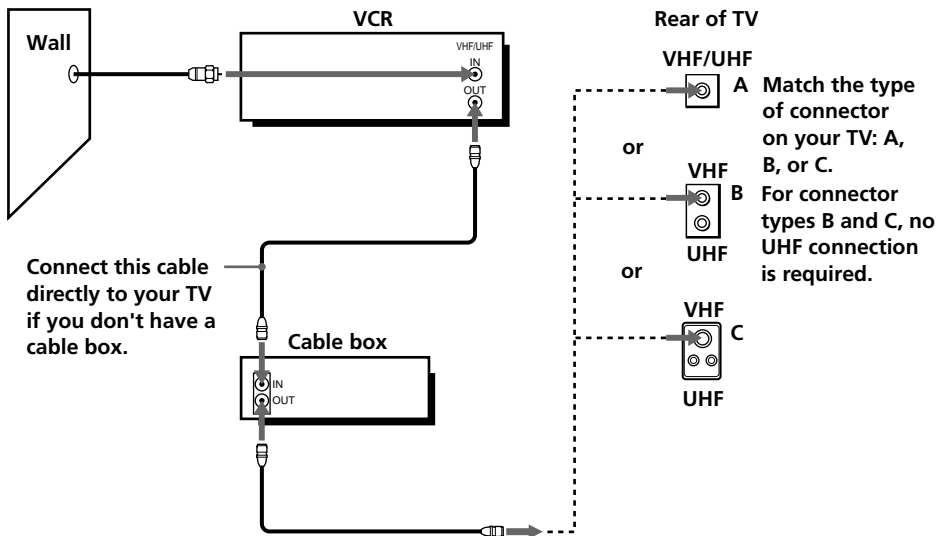

Hookup 2: VCR setup

- 1 Set the RF UNIT switch to CH3 or CH4, whichever channel is not used in your area. If both are used, set the switch to either channel. For details, see page 67. If you made A/V connections (from page 8), you can skip this step.

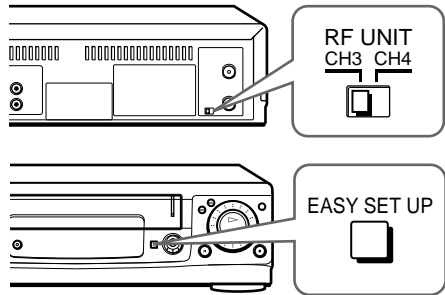

- 2 Press EASY SET UP on the VCR.

- 1 The IDIOMA menu appears. Change the on-screen display language to English (ENGLISH) if desired, and press OK. For details, see page 24.

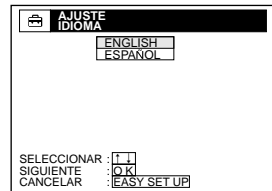

- 2 The CLOCK SET menu appears. Select AUTO and press OK. For details, see page 25.

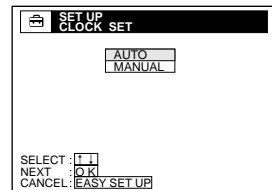

- 3 The COUNTRY/TIME ZONE menu appears. Select the country you want to set and press OK. You can select following countries:
 BELIZE ↔ BOLIVIA ↔ CHILE ↔
 COLOMBIA ↔ COSTA RICA ↔ CUBA ↔
 DOMIN. REP. ↔ ECUADOR ↔
 EL SALVADR ↔ GUATEMALA ↔
 GUYANA ↔ HONDURAS ↔ JAMAICA ↔
 MEX-CENT. ↔ MEX-MOUNT. ↔
 MEX-PACIF. ↔ MEX-S. EAST ↔
 NICARAGUA ↔ PANAMA ↔ PERU ↔
 SURINAME ↔ TRIN. & TOB. ↔
 VENEZUELA

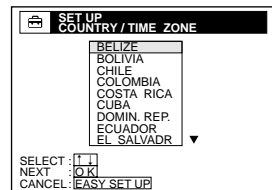

continued

Step 3: Hookups (continued)

- The TUNER PRESET menu appears. Set ANTENNA/CABLE to CABLE and press OK. For details, see page 31.

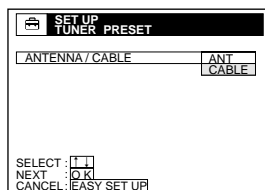

- The AUTO PRESET starts.

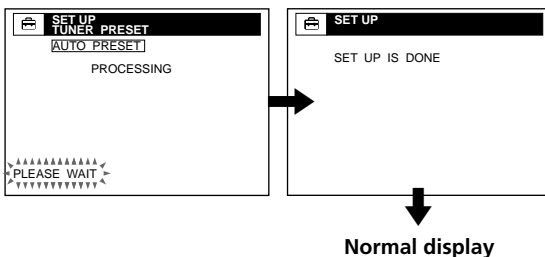

Automatic clock setting

Once you've set up the VCR, it automatically sets the clock the first time you turn off the VCR. After that, whenever you turn off the VCR, it checks the time and adjusts the clock, even for Daylight Saving Time. The VCR sets the clock by picking up time signals provided by Sony Entertainment Television (SETV).

If you want to use the timer to record right away, or if the cable TV station in your area does not broadcast SETV, or if SETV in your area does not carry time signals, set the clock manually. For details, see page 29.

Note

- The Daylight Saving Time start and end days may differ depending on the year. To ensure correct switching, select ON or OFF for the DAYLIGHT SAVING setting (page 28).

Cable box with many scrambled channels

Recommended use

Use this hookup if your cable system scrambles all or most channels.

What you can do with this hookup

- Record any channel by selecting the channel on the cable box

What you can't do

- Record with the cable box turned off
- Record one channel while watching another channel

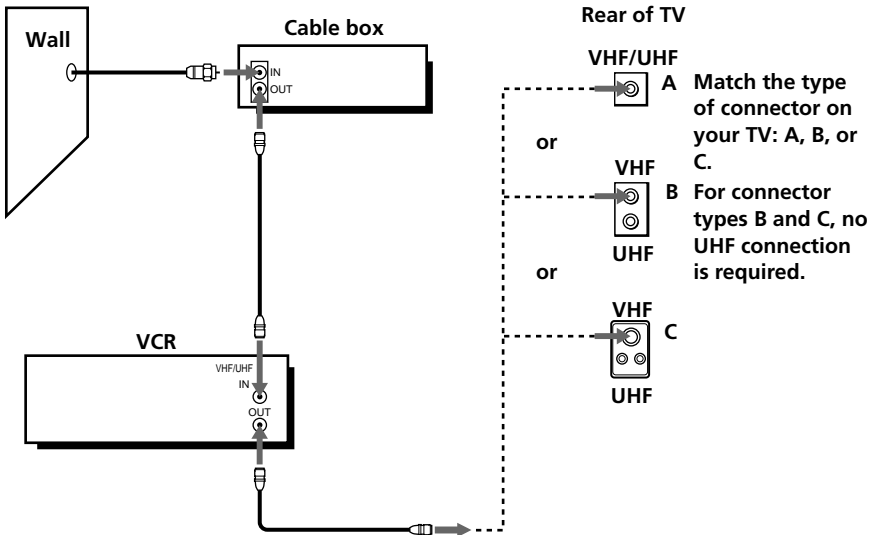

continued

Step 3: Hookups (continued)

Hookup 3: VCR setup

- 1 Set the RF UNIT switch to CH3 or CH4, whichever channel is not used in your area. If both are used, set the switch to either channel. For details, see page 67. If you made A/V connections (from page 8), you can skip this step.

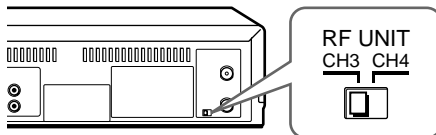

- 2 Turn on your cable box.
- 3 Press EASY SET UP on the VCR.

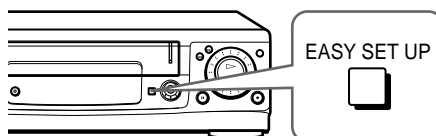

- 1 The IDIOMA menu appears. Change the on-screen display language to English (ENGLISH) if desired, and press OK. For details, see page 24.

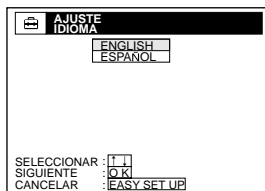

- 2 The CLOCK SET menu appears. Select AUTO and press OK. For details, see page 25.

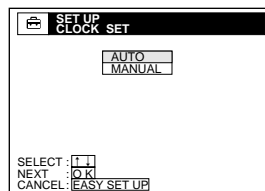

- 3 The COUNTRY/TIME ZONE menu appears. Select the country you want to set and press OK. You can select following countries:
BELIZE ↔ BOLIVIA ↔ CHILE ↔
COLOMBIA ↔ COSTA RICA ↔ CUBA ↔
DOMIN. REP. ↔ ECUADOR ↔
EL SALVADR ↔ GUATEMALA ↔
GUYANA ↔ HONDURAS ↔ JAMAICA ↔
MEX-CENT. ↔ MEX-MOUNT. ↔
MEX-PACIF. ↔ MEX-S. EAST ↔
NICARAGUA ↔ PANAMA ↔ PERU ↔
SURINAME ↔ TRIN. & TOB. ↔
VENEZUELA

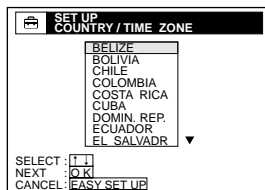

- 4 The TUNER PRESET menu appears. Set ANTENNA/CABLE to ANT and press OK. For details, see page 31.

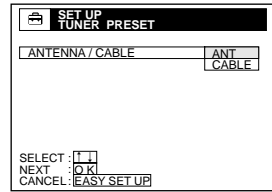

- 5 The AUTO PRESET starts.

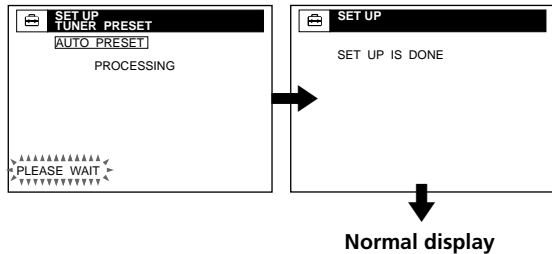

Automatic clock setting

To use the Auto Clock Set feature with this hookup, you need to manually select Sony Entertainment Television (SETV).

- 1 Tune the cable box to SETV.
- 2 Select AUTO in the CLOCK SET menu to turn on the Auto Clock Set feature.
- 3 Turn off the VCR. It automatically sets the clock and adjusts for Daylight Saving Time by picking up the time signal.

If you want to use the timer to record right away, or if the cable TV station in your area does not broadcast SETV, or if SETV in your area does not carry time signals, set the clock manually. For details, see page 29.

Notes

- To use the Auto Clock Set feature, leave the cable box on.
- The Daylight Saving Time start and end days may differ depending on the year. To ensure correct switching, select ON or OFF for the DAYLIGHT SAVING setting (page 28).

continued

Cable box with only a few scrambled channels, using an A/B switch

Recommended use

By using an A/B switch (not supplied), this hookup allows you to record both scrambled and unscrambled channels conveniently.

What you can do with this hookup

- Record any unscrambled channel by selecting the channel directly on the VCR (the A/B switch is set to "A")
- Record any scrambled channel by selecting the channel on the cable box (the A/B switch is set to "B")

What you can't do

- Record one scrambled channel while watching another channel (the A/B switch is set to "B")

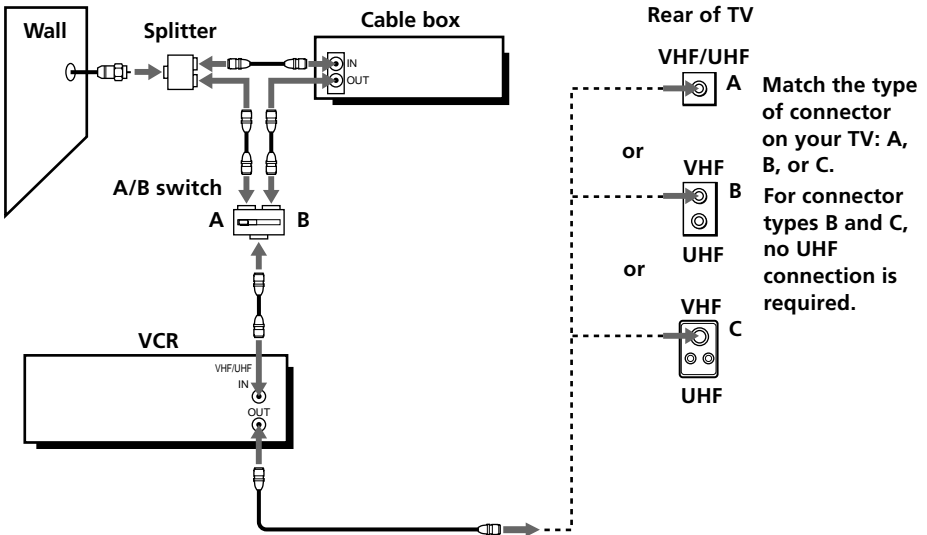

Hookup 4: VCR setup

- 1** Set the RF UNIT switch to CH3 or CH4, whichever channel is not used in your area. If both are used, set the switch to either channel.

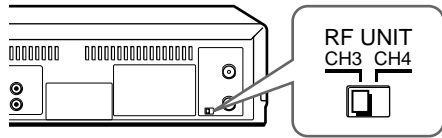

For details, see page 67. If you made A/V connections (from page 8), you can skip this step.

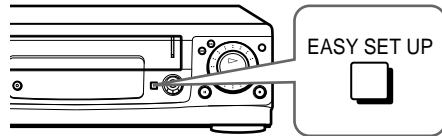

- 2** Set the A/B switch to "A."
3 Press EASY SET UP on the VCR.

- 1** The IDIOMA menu appears. Change the on-screen display language to English (ENGLISH) if desired, and press OK. For details, see page 24.

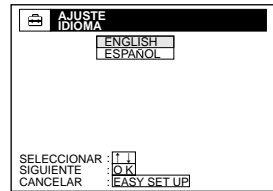

- 2** The CLOCK SET menu appears. Select AUTO and press OK. For details, see page 25.

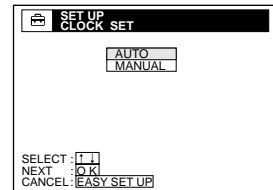

- 3** The COUNTRY/TIME ZONE menu appears. Select the country you want to set and press OK. You can select following countries:
 BELIZE ↔ BOLIVIA ↔ CHILE ↔
 COLOMBIA ↔ COSTA RICA ↔ CUBA ↔
 DOMIN. REP. ↔ ECUADOR ↔
 EL SALVADR ↔ GUATEMALA ↔
 GUYANA ↔ HONDURAS ↔ JAMAICA ↔
 MEX-CENT. ↔ MEX-MOUNT. ↔
 MEX-PACIF. ↔ MEX-S. EAST ↔
 NICARAGUA ↔ PANAMA ↔ PERU ↔
 SURINAME ↔ TRIN. & TOB. ↔
 VENEZUELA

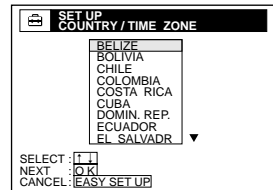

continued

Step 3: Hookups (continued)

- 4 The TUNER PRESET menu appears. Set ANTENNA/CABLE to CABLE and press OK. For details, see page 31.

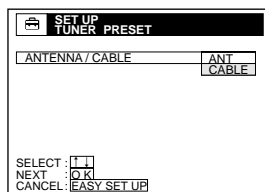

- 5 The AUTO PRESET starts.

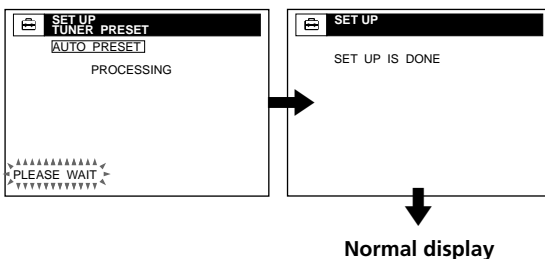

- 4 Preset the cable box output channel (usually 2, 3 or 4). For details, see page 34.

- 1 Press MENU, then select SETTINGS and press OK.

- 2 Select TUNER PRESET and press OK.

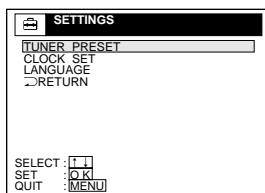

- 3 Enter the cable box output channel.

- 4 Set MANUAL SET to ADD and press OK.

Cable box output channel

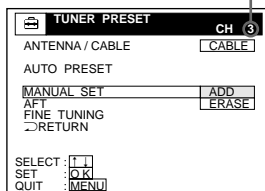

- 5 Press MENU to exit the menu.

Automatic clock setting

Once you've set up the VCR, it automatically sets the clock the first time you turn off the VCR. After that, whenever you turn off the VCR, it checks the time and adjusts the clock, even for Daylight Saving Time. The VCR sets the clock by picking up time signals provided by Sony Entertainment Television (SETV).

If you want to use the timer to record right away, or if the cable TV station in your area does not broadcast SETV, or if SETV in your area does not carry time signals, set the clock manually. For details, see page 29.

Notes

- To use the Auto Clock Set feature, set the A/B switch to "A".
- The Daylight Saving Time start and end days may differ depending on the year. To ensure correct switching, select ON or OFF for the DAYLIGHT SAVING setting (page 28).

Selecting a language

You can change the on-screen display language.

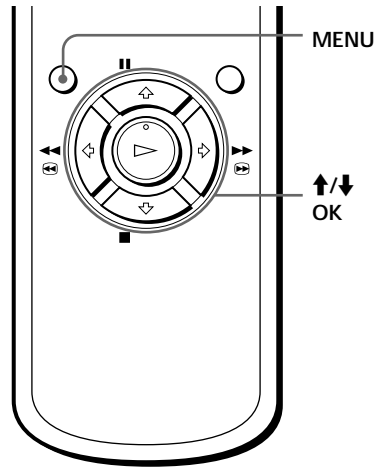

Press MENU, then press **↑/↓** to highlight AJUSTES and press OK.

When using the EASY SET UP procedure, skip steps 1 and 2.

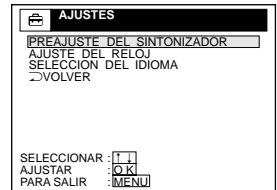

Press **↑/↓** to highlight SELECCION DEL IDIOMA, then press OK.



Press **↑/↓** to highlight ENGLISH or ESPAÑOL, then press OK.



Press MENU to exit the menu.

Tip

- If you want to return to the previous menu, highlight RETURN and press OK.

Setting the clock

Using the Auto Clock Set feature

Sony Entertainment Television (SETV) transmits time signals with its broadcasts. If the cable TV station in your area broadcasts SETV and transmits these time signals as is, your VCR can pick up these time signals to automatically set the clock.

The Auto Clock Set feature works only if SETV in your area broadcasts time signals. If SETV in your area does not broadcast time signals or if you select Hookup 1 on page 11, set the time manually (page 29).

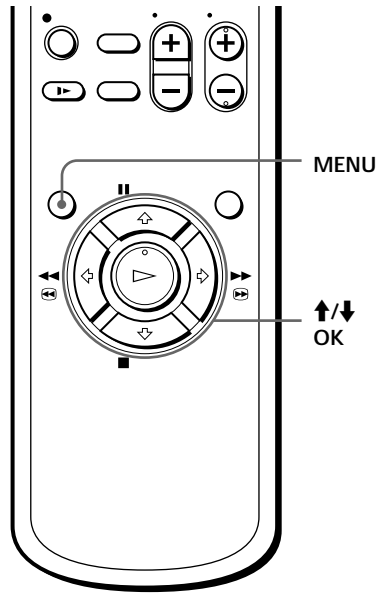

Before you start...

- Turn on the VCR and the TV.
- Set the TV to the VCR channel (channel 3 or 4). If your TV is connected to the VCR using A/V connections, set the TV to video input.
- Press TV/VIDEO to display the VIDEO indicator in the VCR's display window.
- Press INPUT SELECT so that a channel number appears in the VCR's display window.

1



Press MENU, then press **↑/↓** to highlight SETTINGS and press OK.

When using the EASY SET UP procedure, skip steps 1 and 2.

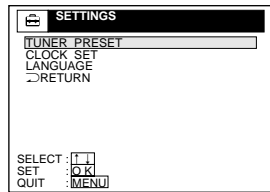

2



Press **↑/↓** to highlight CLOCK SET, then press OK.

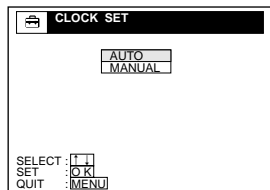

continued

Setting the clock (continued)

3



Press **↑/↓** to highlight AUTO, then press OK.

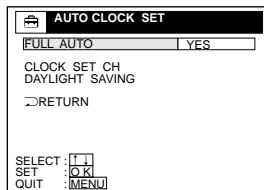

4



Press **↑/↓** to highlight FULL AUTO, then press OK.

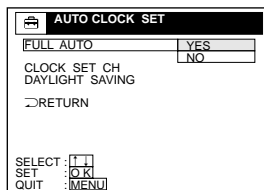

5



Press **↑/↓** to highlight YES, then press OK.

6



Press MENU to exit the menu.

7

To activate the Auto Clock Set function, turn off the VCR.

The VCR automatically sets the clock by searching for the SETV broadcast that carries time signals and sets Daylight Saving Time (if applicable).

If your clock is set to the wrong Daylight Saving Time, you can adjust these settings without turning off the Auto Clock Set feature (page 27).

Tip

- If you want to return to the previous menu, highlight RETURN and press OK.

Notes

- The clock cannot be set automatically if you do not receive SETV broadcast that carries time signals in your area. If so, set the clock manually (page 29).
- Depending on the channels allotted to SETV in your area, setting the clock automatically may take up to about 30 minutes. If nothing happens even after you wait about 30 minutes after turning off the VCR, turn the VCR on and then off again. If the clock is not set even after about another 30 minutes, set the clock manually (page 29).

If the clock is not activated

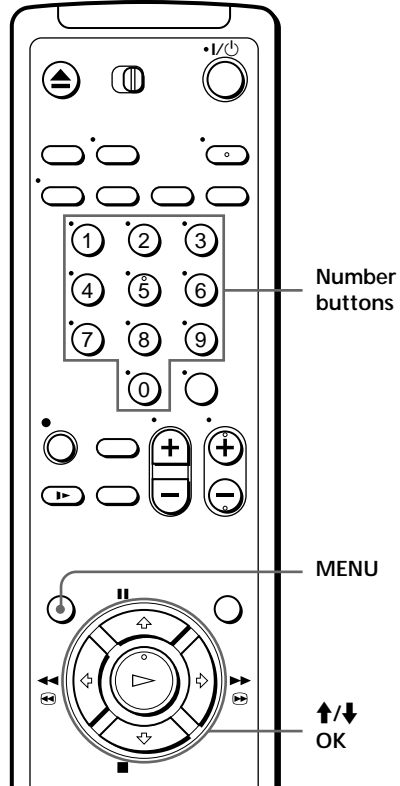

1

Follow steps 1 to 4 in “Using the Auto Clock Set feature.”

The AUTO CLOCK SET menu is displayed.

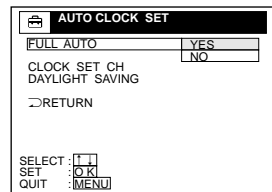

continued

Setting the clock (continued)

2



Press **↑/↓** to highlight NO for FULL AUTO and press OK.

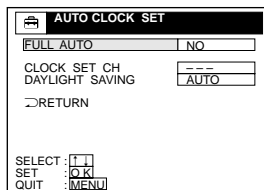

3



Press **↑/↓** to highlight the item you want to set and press OK. Then press **↑/↓** to make the setting and press OK.

- For **CLOCK SET CH**

Leave the setting to “---” to have the VCR automatically search for the SETV broadcast.

Or, press the number buttons to select the SETV channel if you know it.

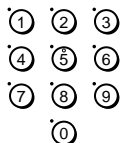

- For **DAYLIGHT SAVING**

Select ON or OFF (standard time), or AUTO to have the VCR automatically set the daylight saving time.

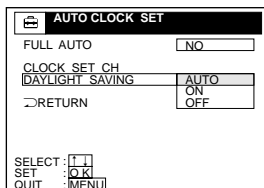
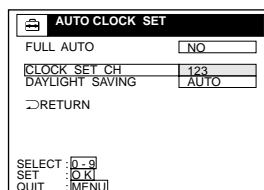

4



Press MENU to exit the menu.

5

To activate the Auto Clock Set function, turn off the VCR.

Tip

- If you want to return to the previous menu, highlight RETURN and press OK.

Notes

- The Daylight Saving Time start and end days may differ depending on the year. To ensure correct switching, select ON or OFF for the DAYLIGHT SAVING setting.
- If nothing happens even after you wait about 30 minutes after turning off the VCR, turn the VCR on and then off again. If the clock is not set even after another about 30 minutes, set the clock manually (page 29).
- Some cable TV stations broadcasting SETV do not transmit time signals. If so, set the clock manually (page 29).

Using Manual Clock Set

Before you start...

- Turn on the VCR and the TV.
- Set the TV to the VCR channel (channel 3 or 4). If your TV is connected to the VCR using A/V connections, set the TV to video input.
- Press TV/VIDEO to display the VIDEO indicator in the VCR's display window.

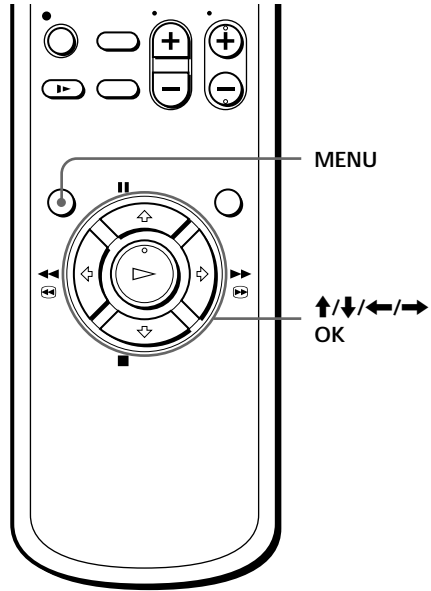

- 1** Press MENU, then press \uparrow/\downarrow to highlight SETTINGS and press OK.



When using the EASY SET UP procedure, skip steps 1 and 2.

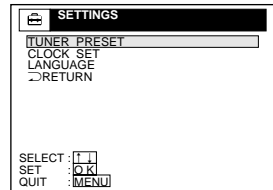

- 2** Press \uparrow/\downarrow to highlight CLOCK SET, then press OK.

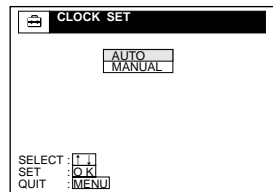

- 3** Press \uparrow/\downarrow to highlight MANUAL and press OK.

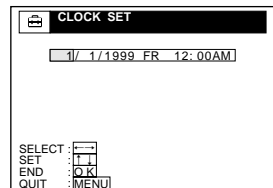

continued

Setting the clock (continued)

4



Press **↑/↓** to set the month.

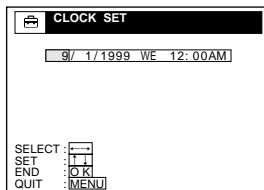

5



Press **→** to highlight the day and press **↑/↓** to set the day.

The day of the week is set automatically.

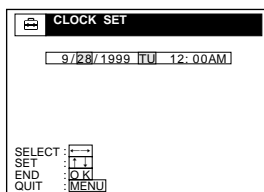

6

Set the year, hour, and minutes in the same way as the day.

7



Press **OK** to start the clock.

Tip

- If you want to return to the previous menu, highlight **RETURN** and press **OK**.

Presetting channels

This VCR is capable of receiving VHF channels 2 to 13, UHF channels 14 to 69 and unscrambled CATV channels 1 to 125. First, we recommend that you preset the receivable channels in your area using automatic presetting. Then, if there are any unwanted channels, disable them manually. If you have decided which channels you wish to preset, set them directly using manual presetting.

Before you start...

- Turn on the VCR and the TV.
- Set the TV to the VCR channel (channel 3 or 4). If your TV is connected to the VCR using A/V connections, set the TV to video input.
- Press TV/VIDEO to display the VIDEO indicator in the VCR's display window.

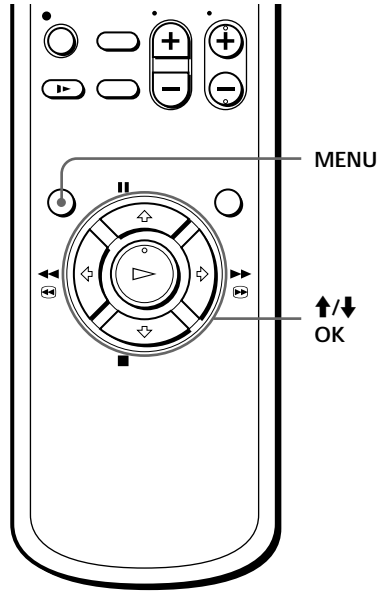

Presetting all receivable channels automatically

1

MENU



Press MENU, then press **↑/↓** to highlight SETTINGS and press OK.



When using EASY SET UP procedure, skip steps 1 and 2.

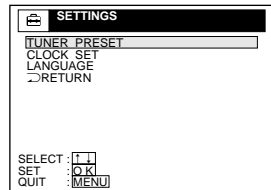

2



Press **↑/↓** to highlight TUNER PRESET, then press OK.

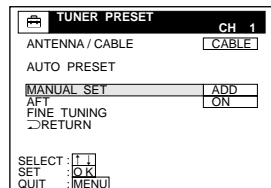

continued

Presetting channels (continued)

3



Press **↑/↓** to highlight ANTENNA/CABLE, then press OK.

4



• To preset cable TV channels:

Press **↑/↓** to set ANTENNA/CABLE to CABLE, then press OK.

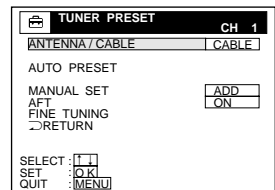

• To preset VHF and UHF channels:

Press **↑/↓** to set ANTENNA/CABLE to ANT, then press OK.

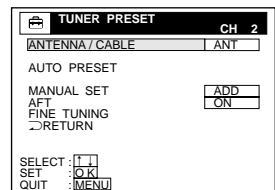

5



Press **↑/↓** to highlight AUTO PRESET, then press OK.

All receivable channels are preset in numerical sequence. When no more receivable channels can be found, presetting stops and the picture from the lowest numbered channel is displayed on the TV screen.

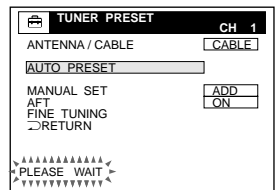

Tips

- When receiving a VHF, UHF, or CATV channel, the display changes as follows each time you press DISPLAY.

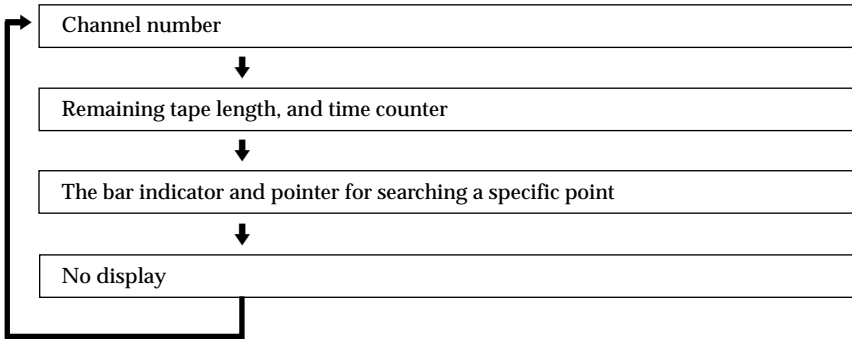

- If you want to return to the previous menu, highlight RETURN and press OK.

continued

Presetting channels (continued)

Presetting/disabling channels manually

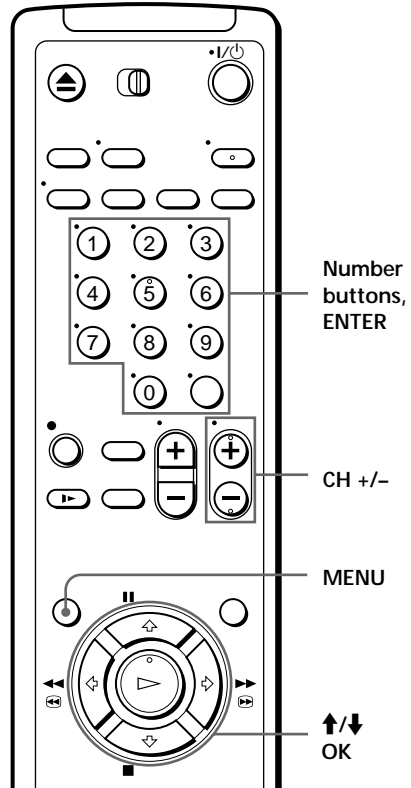

Press MENU, then press ↑/↓ to highlight SETTINGS and press OK.

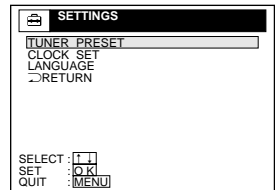

Press ↑/↓ to highlight TUNER PRESET, then press OK.

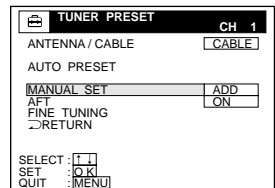

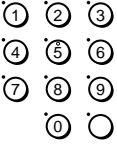
3

- To preset a channel:

- 1 Press the number buttons to enter the channel number, then press ENTER.
- 2 Press OK.
- 3 Press \uparrow/\downarrow to set MANUAL SET to ADD, then press OK.

Channel to be preset

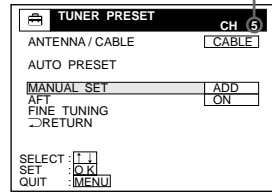

• CH



- To disable a channel:

- 1 Press CH +/- to select the channel number.
- 2 Press OK.
- 3 Press \uparrow/\downarrow to set MANUAL SET to ERASE, then press OK.

Channel to be disabled

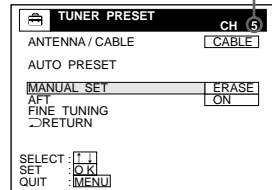
**4**

MENU



Repeat step 3 to preset or disable channels as required, then press MENU.

Tip

- If you want to return to the previous menu, highlight RETURN and press OK.

continued

Presetting channels (continued)

If the picture is not clear

Normally, the Auto Fine Tuning (AFT) function automatically tunes in channels clearly. If, however, the picture of a channel is not clear, you can also use the manual tuning function.

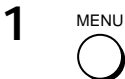
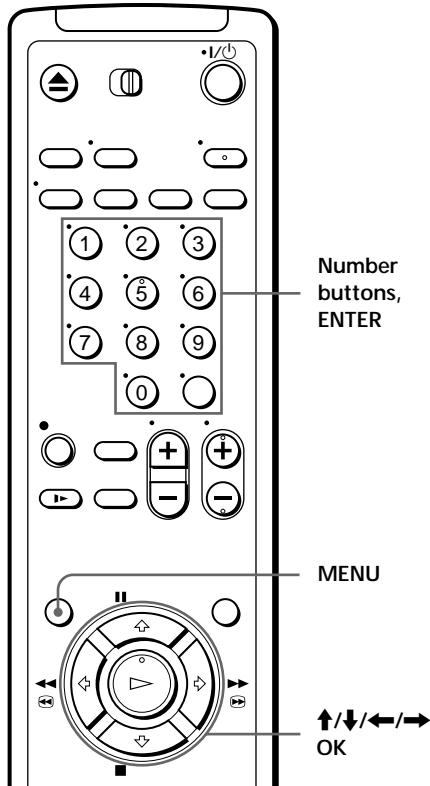

Press MENU, then press **↑/↓** to highlight SETTINGS and press OK.

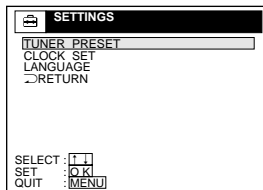

Press **↑/↓** to highlight TUNER PRESET, then press OK.

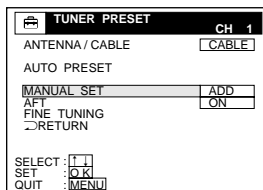

3

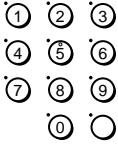

Press the number buttons to select the channel you want to fine-tune, then press ENTER.

Selected channel

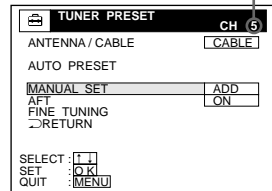

4



Press \uparrow/\downarrow to highlight FINE TUNING, then press OK.

The fine tuning meter appears.

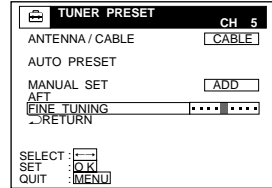

5



Press \leftarrow/\rightarrow to adjust to a clearer picture, then press OK.

Note that the AFT setting switches to OFF.

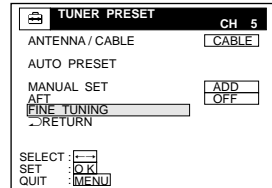

6



Press MENU to exit the menu.

Tips

- To select the channel in step 3 above, you can also use the CH +/- buttons. In this case, you don't need to press ENTER.
- If you want to return to the previous menu, highlight RETURN and press OK.

Note

- When adjusting FINE TUNING, the menu may become difficult to read due to interference from the picture being received.

Playing a tape

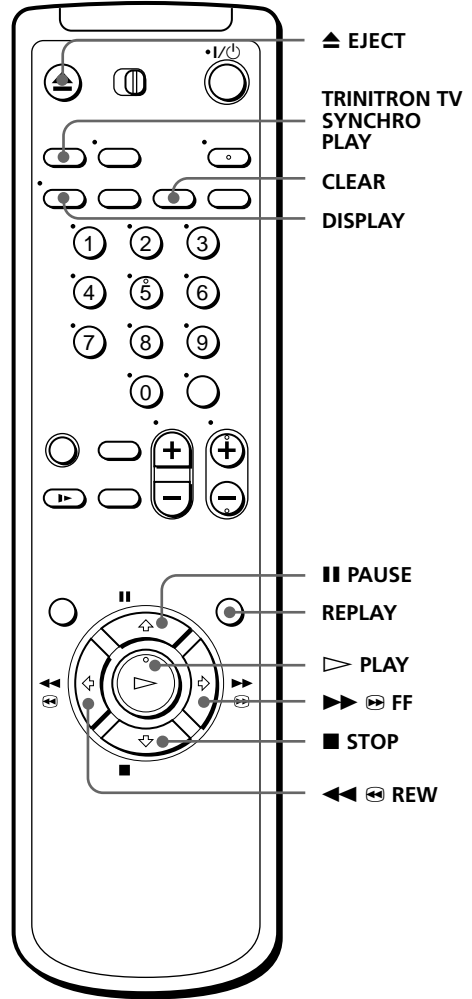

1 Turn on your TV and set it to the video channel.

2 Insert a tape.
The VCR turns on and starts playing automatically if you insert a tape with its safety tab removed.

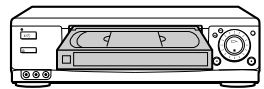









3



Press  PLAY.

When the tape reaches the end, it will rewind automatically.

Additional tasks

To	Press
Stop play	 STOP
Pause play	 PAUSE
Resume play after pause	 PAUSE or  PLAY
Fast-forward the tape	  FF during stop
Rewind the tape	  REW during stop
Eject the tape	 EJECT

To play a recently watched scene

You can immediately rewind and playback the scene you want to watch again.

During playback, press REPLAY up to four times. The VCR rewinds the tape about ten seconds on the counter for each press of the button, and restarts playback.





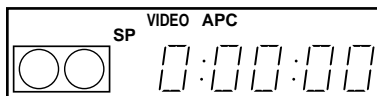

To use the time counter

At the point on the tape that you want to find later, press CLEAR. The counter in the display window resets to "0:00:00." Search for the point afterwards by referring to the counter.



To display the counter on the TV screen, press DISPLAY repeatedly until the time counter appears. To turn off the display, press DISPLAY twice.

Notes

- Tapes recorded in the LP mode on other VCRs can be played back on this VCR but the picture quality cannot be guaranteed.
- While setting the menu on the TV screen, you cannot use  PLAY,  PAUSE,   FF,   REW, or  STOP buttons.
- The counter resets to "0:00:00" whenever a tape is reinserted.
- The counter stops counting when it comes to a portion with no recording.

continued

Turning on the VCR and TV, and starting playback automatically (Trinitron TV Synchro Play)

You can only use this function if your TV is made by Sony (Trinitron TV).

How to connect to use this function

Connect the VCR and TV with the audio/video cable (see "Audio/video (A/V) hookup" on pages 8 and 9). Be sure to connect the audio/video cable to the VIDEO IN 1 jacks on the TV if the TV has two inputs or more. The TV must be placed where it will respond to the remote commander while you are pointing it at the VCR.

Operation

Make sure that the TV's power is in standby mode.

Press TRINITRON TV SYNCHRO PLAY and hold the remote commander in place for about two seconds.

The VCR and TV turn on, and the TV is set to the video channel. If there is a tape in the VCR, playback starts automatically.

Notes

- If the Trinitron TV Synchro Play function does not work properly:
 - Wait a few moments, and press the button again.
 - Replace both of the batteries with new ones, and press the button again.Note that this function may not operate some Sony TVs because of the remote commander's signal limitations.
- Do not press TRINITRON TV SYNCHRO PLAY during playback. If you do so, the TV's input source will momentarily switch to the TV's tuner.

Recording TV programs

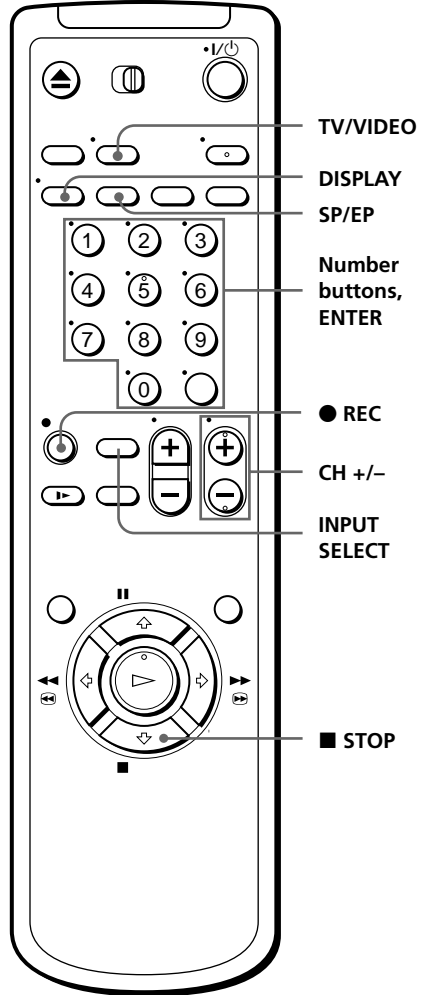

1 Turn on your TV and set it to the video channel.
To record from a cable box, turn it on.

2 Insert a tape with its safety tab in place.

continued

Recording TV programs (continued)

3



Press INPUT SELECT until a channel number appears in the display window.



4



Press CH +/- to select the channel you want to record.



5



Press SP/EP to select the tape speed, SP or EP.

EP (Extended Play) provides recording time three times as long as SP (Standard Play), however, SP produces better picture and audio quality.

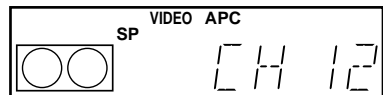

6



Press ● REC to start recording.

The recording indicator lights up red in the display window.

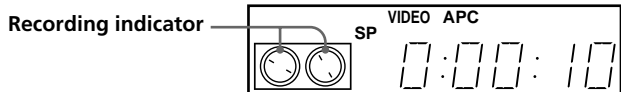

To stop recording

Press ■ STOP.

To check the remaining tape length

Press DISPLAY repeatedly until the display below appears. The white bar indicates the approximate length of tape remaining.

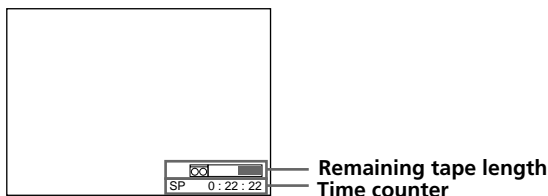

To watch another TV program while recording

- 1** Press TV/VIDEO to turn off the VIDEO indicator in the display window.
- 2** If the TV is connected to the VCR's LINE OUT jacks, set the TV to TV input; if not, skip this step.
- 3** Select another channel on the TV.

To select the channel using the shuttle ring (SLV-L89HF CL/CS/MX/VZ only)

To select a channel in step 4 above, you can also use the shuttle ring. During stop, turn the shuttle ring clockwise for higher channels or counterclockwise for lower channels. The VCR switches the channel in the preset order.

To save a recording

To prevent accidental erasure, break off the safety tab as illustrated. To record on a tape again, cover the tab hole with adhesive tape.

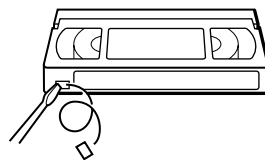

Safety tab

Tips

- To select a channel, you can use the number buttons on the remote commander. Enter the channel number, then press ENTER.
- You can select a video source from the LINE-1 IN or LINE-2 IN jacks using the INPUT SELECT button.
- The display appears on the TV screen indicating information about the tape, but the information won't be recorded on the tape.
- If you don't want to watch TV while recording, you can turn off the TV. When using a cable box, make sure to leave it on.

Notes

- The display does not appear during still (pause) mode or slow-motion playback.
- It may take up to one minute for the VCR to calculate and display the remaining tape length after you press DISPLAY.

Recording TV programs using the timer

You can preset up to eight programs at a time.

Before you start...

- Check that the VCR clock is set to the correct time.
- Turn on your TV and set it to the video channel. When using a cable box, turn it on.
- Insert a tape with its safety tab in place. Make sure the tape is longer than the total recording time.

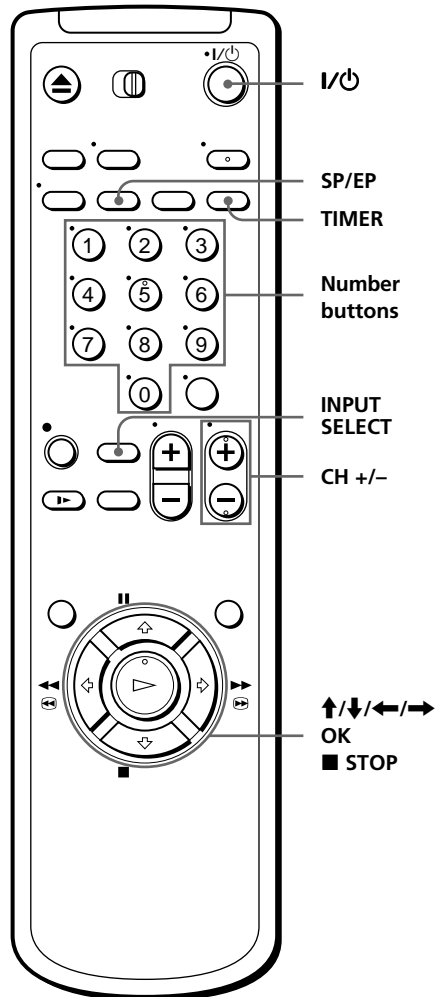

Press **TIMER** to display **TIMER SET / CHECK**.

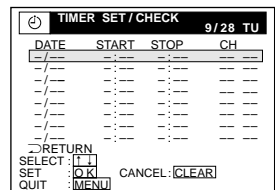

2



Press **↑/↓** to highlight the line that is to be set, then press OK.

3



Set the date, start and stop times, channel number and tape speed:

- 1 Press **↑/↓** to set each item.
- 2 Press **→** to highlight and set each item in turn.

To correct a setting, press **←** to return to that setting and reset.

To record the same program every day or the same day every week, press **↓** while the date is highlighted. For details, see "Daily/weekly recording" below.

TIMER SET / CHECK				9/28 TU
DATE	START	STOP	CH	
9/30 TH	8:00PM	9:00PM	35	[SP]
-/-	-:-	-:-	-:-	-:-
-/-	-:-	-:-	-:-	-:-
-/-	-:-	-:-	-:-	-:-
-/-	-:-	-:-	-:-	-:-
-/-	-:-	-:-	-:-	-:-
-/-	-:-	-:-	-:-	-:-
↵ RETURN SELECT: [] SET: [] END: [OK] QUIT: [MENU]				



To record from a source connected to the LINE-1 IN or LINE-2 IN jacks, press INPUT SELECT to display "L1" or "L2" in the "CH" position.

4



Press OK to confirm the setting.

To enter another setting, highlight the next line and repeat step 3.

5



Press TIMER.

6



Press **I/⏻** to turn off the VCR.

The **⏻** indicator appears in the display window and the VCR stands by for recording.
When using a cable box, leave it on.

continued

Recording TV programs using the timer (continued)

To stop recording

To stop the VCR while recording, press ■ STOP.

Daily/weekly recording

In step 3 above, press ↓ to select the recording pattern. Each time you press ↓, the indication changes as shown below. Press ↑ to change the indication in reverse order.

the current date → SU-SA → MO-SA → MO-FR → EVERY SA → →
EVERY MO → EVERY SU → 1 month later → (dates count down) →
the current date

To use the VCR after setting the timer

To use the VCR before a timer recording begins, just press I/⏻. The ⏻ indicator disappears from the display window and the VCR switches on. Remember to press I/⏻ to reset the VCR to the timer recording standby mode after using the VCR.

You can also do the following tasks while the VCR is recording:

- Reset the counter.
- Display tape information on the TV screen.
- Check the timer settings.
- Watch another TV program.

To lock the VCR after setting the timer (Child Lock)

While the VCR turns on, hold down I/⏻ POWER on the VCR until the 🔒 indicator appear in the display window. The VCR turns off and the 🔒 indicator remains lit. The VCR will not work except for timer recording.

To unlock the VCR, hold down I/⏻ POWER on the VCR until the 🔒 indicator disappears from the display window. The VCR is unlocked and turns on.

To stop timer recording while the VCR is locked, press ■ STOP. The recording stops and the VCR is unlocked.

Tips

- To set the channel, you can also use the CH+/- or number buttons.
- To show the TIMER SET/CHECK menu, you can also use the MENU button. Press MENU, then press **↑/↓** to highlight TIMER SET/CHECK and press OK.
- (SLV-L89HF CL/CS/MX/VZ only) You can set the channel with the shuttle ring during stop.
- To set the tape speed, you can also use the SP/EP button.
- When you are recording a program in the SP mode and the remaining tape becomes shorter than the recording time, the tape speed is automatically changed to the EP mode. Note that some noises will appear on the picture when the tape speed is changed. If you want to keep the tape speed, set AUTO TAPE SPEED to OFF in the ADVANCED OPTIONS menu (page 64).
- If you want to return to the previous menu and continue with other operations after setting the timer, press **↓** to highlight RETURN, then press OK.
The display returns to the MENU screen.
If you are finished using the VCR, turn off the power before the timer recording starts.

Playing/searching at various speeds

SLV-L49 MX, L52 PA/PC, L59 CL/CS/PR/VZ, X55 MX, L69HF MX, L72HF PA/PC, L79HF CL/CS/VZ and X66HF MX

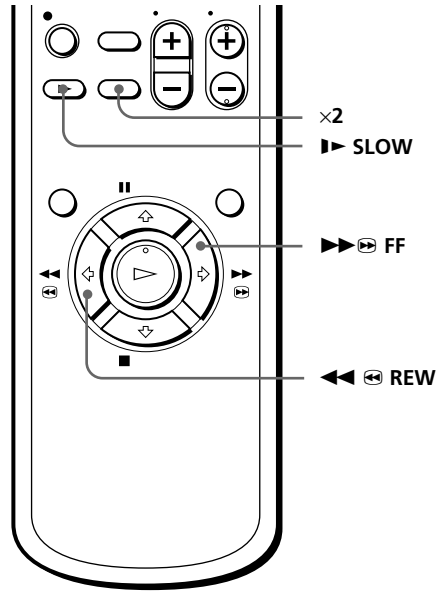
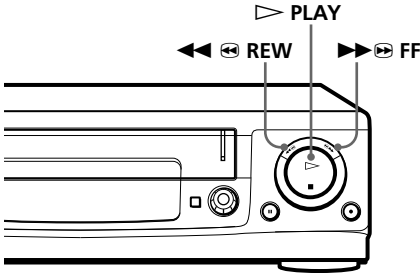

SLV-L89HF CL/CS/MX/VZ

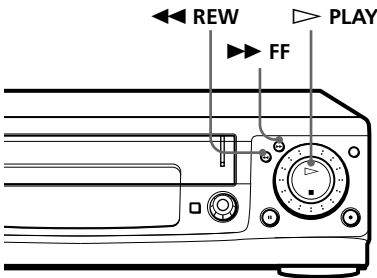

Playback options	Operation
View the picture during fast-forward or rewind	During fast-forward, hold down ►► FF/►► FF. During rewind, hold down ◀◀ REW/◀◀ REW.
Play at high speed	<ul style="list-style-type: none"> • During playback, press ►► FF or ◀◀ REW on the remote commander. • During playback, hold down ►► FF/►► FF or ◀◀ REW/◀◀ REW. When you release the button, normal playback resumes.
Play at twice the normal speed	During playback, press x2.
Play in slow motion	During playback or pause, press ► SLOW.
Play frame by frame	During pause, press ►► FF or ◀◀ REW on the remote commander. Hold down the button to play one frame each second.
Rewind and start play	During stop, press ▷ PLAY on the VCR while holding down ◀◀ REW/◀◀ REW on the VCR.

To resume normal playback

Press ▷ PLAY.

Using the shuttle ring (SLV-L89HF CL/CS/MX/VZ only)

With the shuttle ring, you can operate a variety of playback options.

There are two ways for using the shuttle ring, normal mode and jog mode.

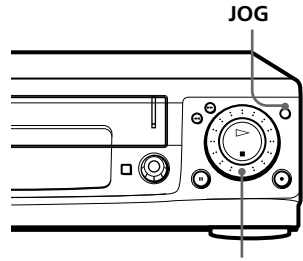

Shuttle ring

To use the shuttle ring in normal mode

During playback or pause, turn the shuttle ring clockwise or counterclockwise. Each change in the shuttle ring position changes the playback mode in the following way.

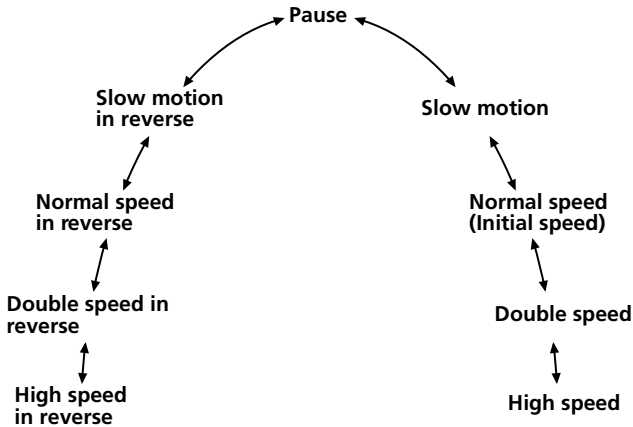

continued

Playing/searching at various speeds (continued)

To use the shuttle ring in jog mode

Use this mode for frame-by-frame playback.

Press JOG to enter the jog mode. The JOG button lights up. If you change to jog mode during any playback mode, playback pauses so you can see a still picture. Each change in the shuttle ring position shifts the picture one frame. To shift frames in reverse, turn the shuttle ring counterclockwise.

The frame shift speed depends on the speed you turn the shuttle ring.

To resume normal mode, press JOG again. The JOG button goes off.

Tip

- Adjust the picture using the TRACKING +/- buttons if:
 - Streaks appear while playing in slow motion.
 - The picture shakes while pausing.
- To set tracking to the center position, press both buttons (+/-) at the same time.

Notes

- The sound is muted during these operations.
- Tapes recorded in the LP mode on other VCRs can be played back on this VCR but the picture quality cannot be guaranteed.
- The picture may have snow:
 - when playing at high speed in reverse
 - when playing in reverse slow motion (SLV-L89HF CL/CS/MX/VZ only)
 - when playing in reverse (SLV-L89HF CL/CS/MX/VZ only)

Searching for a selected point on the tape

You can easily find a selected point by moving the pointer on the TV screen. The VCR fast-forwards or rewinds to the point you indicate and starts playback automatically.

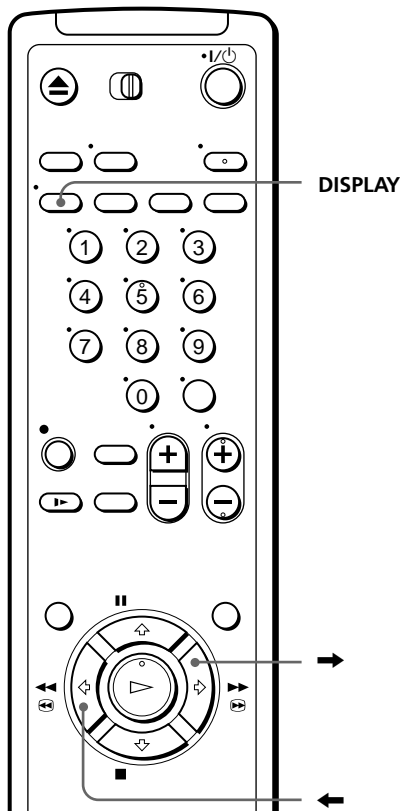

- 1 Press **DISPLAY** repeatedly until the bar indication appears on the TV screen.
A cursor (■) indicating the current position of the tape appears on the bar indication. If the cursor does not appear, play the tape a few moments (by pressing ▷ **PLAY**, ►►► **FF** or ◀◀◀ **REW**) until the cursor appears.

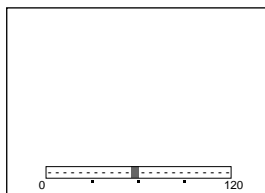

- 2 Press ◀/▶ to move the pointer (▽) to the point where you want to start playback.
The VCR starts searching and the cursor (■) moves toward the pointer. When the VCR locates the marked point, playback starts.

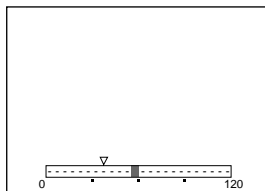

continued

Searching for a selected point on the tape (continued)

To cancel searching

Press ▷ PLAY or ■ STOP.

To turn off the bar indication

Press DISPLAY again.

Notes

- The figure on the bar indication represents the total time length of the inserted tape as shown below.
The total time length may not be displayed correctly for:
 - tapes other than T-60, T-120, or T-160
 - tapes recorded in more than one tape speed mode.

Tape type	Total time length		
	SP	LP	EP
T-60 or shorter	60	120	180
from T-80 to T-140	120	240	360
T-160 or longer	160	320	480

- If you move the pointer (▽) on the bar indication during search, the VCR searches for the new reset point.
- With the bar indication on, the ►► ⏪ FF/►► and ◀◀ ⏩ REW/◀◀ buttons on the remote commander work only for moving the pointer (▽), while the ►► ⏪ FF and ◀◀ ⏩ REW (or, ►► FF and ◀◀ REW) buttons on the VCR are used for normal tape operation. Note, however, if you press these buttons on the VCR, searching is canceled.

Skip-searching automatically

You can spot check a whole tape quickly. At intervals, the VCR skips playback while searching forward or backward.

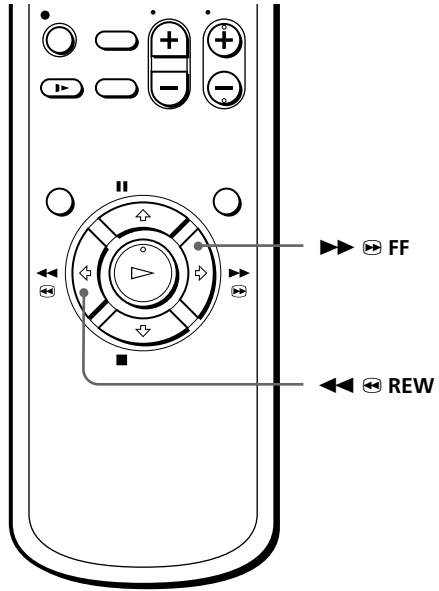

Hold down ►►► FF (or ◀◀◀ REW) more than two seconds during stop. "SKIP" indicator appears on the TV screen.

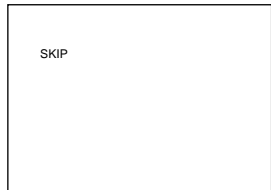

The VCR searches forward (or backward) for about two minutes on the counter, then fast-forwards (or rewinds) for about ten minutes on the counter. The VCR repeats this operation until it stops at the end (or beginning) of the tape.

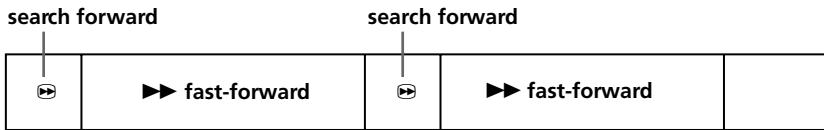

To cancel skip-search

Press ▷ PLAY or ■ STOP.

Note

- The VCR automatically fast-forwards (or rewinds) any portion with no recording.

Recording TV programs using the dial timer

The Dial Timer function allows you to make timer recordings of programs without turning on your TV. Set the recording timer to record up to eight programs that will be broadcast within the next 24 hours using the DIAL TIMER. The recording start time and stop time can be set at 15 minute intervals.

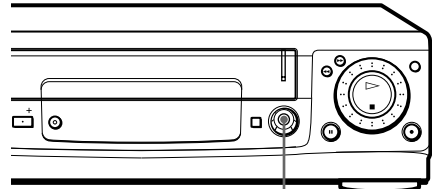

DIAL TIMER

Before you start...

- Check that the VCR clock is set to the correct time.
- When using a cable box, turn it on.
- Insert a tape with its safety tab in place. Make sure the tape is longer than the total recording time.

1 Press DIAL TIMER.

“START” and the recording start time appear alternately in the display window.

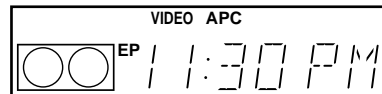
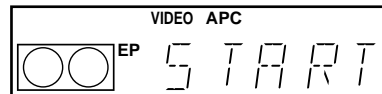

2 Turn DIAL TIMER to set the recording start time.

The time changes in 15 minute intervals.

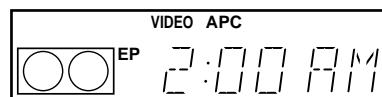

3 Press DIAL TIMER.

“STOP” and the recording stop time appear alternately in the display window.

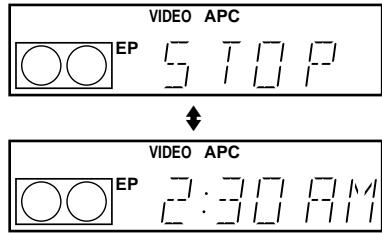

4 Turn DIAL TIMER to set the recording stop time.

The time changes in 15 minute intervals.

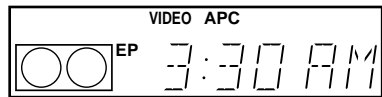

5 Press DIAL TIMER.

The channel appears in the display window.

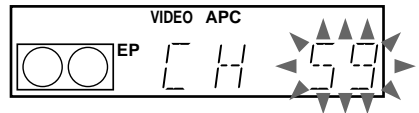

6 Turn DIAL TIMER to set the channel.

To record from a source connected to the LINE-1 IN or LINE-2 IN jacks, press INPUT SELECT to display “L1” or “L2”.

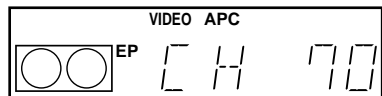

7 Press DIAL TIMER to complete the setting.

“OK” appears in the display window for about five seconds.

The  indicator appears in the display window and the VCR stands by for recording. When using a cable box, leave it on.

continued

Recording TV programs using the dial timer (continued)

To stop recording

To stop the VCR while recording, press ■ STOP.

To use the VCR after setting the timer

To use the VCR before a timer recording begins, just press I/⏻. The ⏻ indicator disappears from the display window and the VCR switches on. Remember to press I/⏻ to reset the VCR to the timer recording standby mode after using the VCR.

If "CLOCK" and "12: -- AM" appear alternately when you press DIAL TIMER

Set the clock by referring to "Setting the clock" (page 25). Alternatively, you can set the clock by following the steps below. As this method automatically sets the date to the factory setting (1/1/1999), you cannot make the correct timer settings using the menu. It is suitable only for the limited use of recording a program starting within the next 24 hours using the DIAL TIMER button.

- 1** Turn DIAL TIMER to set the hour.
- 2** Press DIAL TIMER.
- 3** Turn DIAL TIMER to set the minutes.
- 4** Press DIAL TIMER to start the clock.
- 5** Go to step 2 on page 54.

Tips

- The program is recorded in the current tape speed. To change the tape speed, press SP/EP before you complete the setting in step 7.
- To check, change, or cancel the program setting, see "Checking/changing/canceling timer settings" (page 58).

Notes

- If eight programs have already been set in step 1, "FULL" appears in the display window for about three seconds.
- The ⏻ indicator flashes in the display window when you complete the setting in step 7 with no tape inserted.

Setting the recording duration time

After starting recording in the normal way, you can have the VCR stop recording automatically after a specified duration.

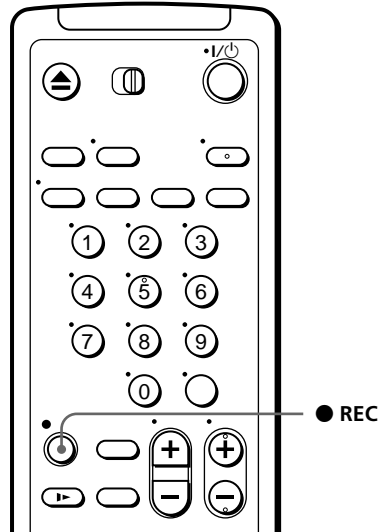

- 1 While recording, press ● REC once.

The ⊖ indicator appears in the display window.

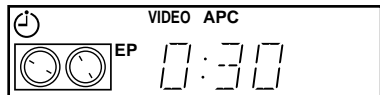

- 2 Press ● REC repeatedly to set the duration.

Each press advances the time in increments of 30 minutes.

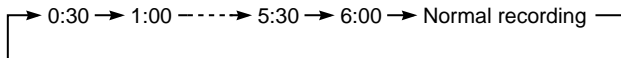

The tape counter decreases minute by minute to 0:00, then the VCR stops recording and turns off automatically.

To extend the duration

Press ● REC repeatedly to set a new duration.

To cancel the duration

Press ● REC repeatedly until ⊖ indicator disappears and the VCR returns to normal recording mode.

To stop while recording

Press ■ STOP.

Note

- You cannot display the current time counter in the display window when setting the recording duration.

Checking/ changing/ canceling timer settings

Before you start...

- Turn on your TV and set it to the video channel.

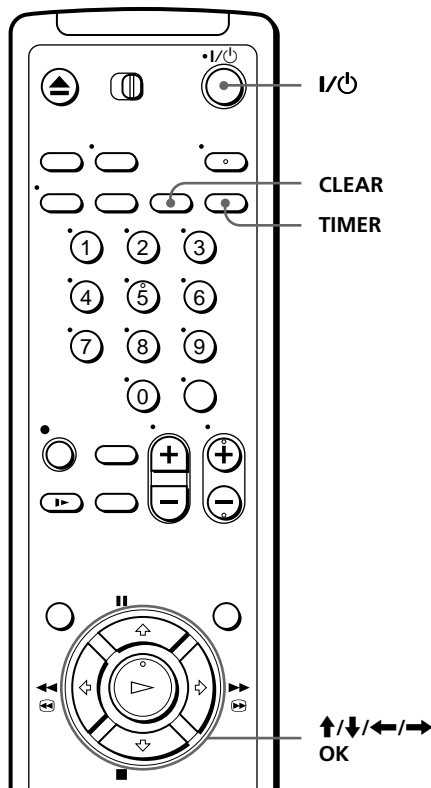

- 1** Press I/Power to turn on the VCR.
- 2** Press TIMER to display TIMER SET/CHECK.
 - If you want to change a setting, go on to the next step.
 - If you do not need to change the settings, press MENU, then turn off the VCR to return to recording standby.

3 Press **↑/↓** to highlight the setting you want to change or cancel.

- To change the setting, press **OK** and press **←/→** to highlight the item you want to change, then press **↑/↓** to reset it.
- To cancel the setting, press **CLEAR**.

TIMER SET/CHECK					9/28 TU
DATE	START	STOP	CH		
9/30 TH	8:00PM	9:00PM	35	SP	
(10/2) SA	10:00AM	11:30AM	20	EP	
MO - FR	2:00PM	3:00PM	60	EP	
EVERY SU	6:30AM	7:00AM	42	EP	
-/-	-:-	-:-	-:-	-:-	-:-
-/-	-:-	-:-	-:-	-:-	-:-
-/-	-:-	-:-	-:-	-:-	-:-
-/-	-:-	-:-	-:-	-:-	-:-
RETURN					
SELECT:	[T]				
SET	: [OK]			CANCEL:	[CLEAR]
QUIT	: [MENU]				

4 Press **OK**.

5 Press **MENU** to exit the menu.

If any timer settings remain, turn off the VCR to return to recording standby.

When the timer settings overlap

The program that starts first has priority and the second program starts recording only after the first program has finished. If the programs start at the same time, the program listed first in the menu has priority.

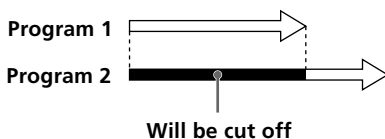

Tip

- To show the **TIMER SET/CHECK** menu, you can also use the **MENU** button. Press **MENU**, then press **↑/↓** to highlight **TIMER SET/CHECK** and press **OK**.

Recording stereo and bilingual programs (SLV-L69HF MX, L72HF PA/PC, L79HF CL/CS/VZ, L89HF CL/CS/MX/VZ and X66HF MX only)

Recording stereo programs

This VCR automatically receives and records stereo programs. When a stereo program is received, the STEREO indicator lights up. If there is noise in the stereo program, set AUTO STEREO in the ADVANCED OPTIONS menu to OFF. The sound will be recorded in monaural (on both hi-fi and normal audio tracks) but with less noise. For details, see page 64.

Recording bilingual programs

Normally, this VCR records only the main sound. When a SAP (Second Audio Program) is received, the SAP indicator lights up. To record only SAP sound, set TUNER AUDIO in the ADVANCED OPTIONS menu to SAP. For details, see page 64.

Selecting the sound during playback

Press AUDIO MONITOR to select the sound you want. (The sound being recorded will not change.)

To listen to	On-screen display	Display window
Stereo	STEREO	STEREO
Left channel	L	STEREO
Right channel	R	STEREO
Monaural sound on the normal audio track	No indicator	No indicator

How sound is recorded on a video tape

The VCR records sound onto two separate tracks. Hi-fi audio is recorded onto the main track along with the picture. Monaural sound is recorded onto the normal audio track along the edge of the tape.

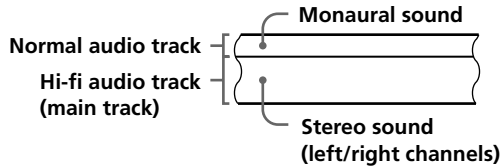



Notes

- To play a tape in stereo, you must use the A/V connections.
- When you play a tape recorded in monaural, the sound is heard in monaural regardless of the AUDIO MONITOR setting.

Adjusting the picture

Adjusting the tracking

Although the VCR automatically adjusts the tracking when playing a tape (the  indicator flashes in the display window, then goes off), distortion may occur if the tape was recorded in poor condition. In this case, manually adjust the tracking.

Press TRACKING +/- to display the tracking meter. The distortion should disappear as you press one of the two buttons (the  indicator lights up). To resume automatic tracking adjustment, eject the tape and reinsert it.

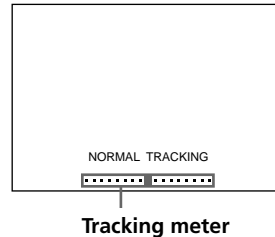

About the Adaptive Picture Control (APC) function

The Adaptive Picture Control (APC) function automatically improves recording and playback quality by adjusting the VCR to the condition of the video heads and tape. To maintain better picture quality, we recommend that you set APC to ON in the ADVANCED OPTIONS menu (with the APC indicator in the display window lit). For details, see page 64.

APC playback

The APC function automatically works on all types of tapes, including rental tapes and tapes that were not recorded with APC.

APC recording

Whenever you insert a tape and first start recording, the VCR adjusts to the tape using the APC function (the APC indicator flashes rapidly). This adjustment is retained until the tape is ejected.

Notes

- Auto tracking adjustment cannot be guaranteed to work with tapes recorded in LP mode on other VCRs.
- The APC function does not work if the tape speed is automatically changed from the SP to EP mode during a timer recording when AUTO TAPE SPEED to ON in the ADVANCED OPTIONS menu, unless the tape has been recorded in the EP mode with the APC function.
- There is a delay of about ten seconds before the VCR actually starts recording while the VCR analyzes the tape. To avoid the delay, first set the VCR to recording pause (the APC indicator flashes slowly) and press ● REC to have the VCR analyze the tape (the APC indicator flashes rapidly). After the APC indicator stops flashing, press ■ PAUSE to start recording immediately.

If you want to start recording quickly without using the APC function, first set the VCR to recording pause (the APC indicator flashes slowly) and press ■ PAUSE to start recording.

About the Reality Regenerator function (SLV-L52 PA/PC, L72HF PA/PC and L89HF CL/CS/MX/VZ only)

The Reality Regenerator function automatically restores the picture to its original quality during playback.

To use the Reality Regenerator function, press REALITY REGENERATOR. The REALITY REGENERATOR button lights up.

To turn it off, press REALITY REGENERATOR. The REALITY REGENERATOR button goes off.

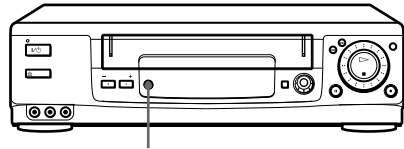

REALITY REGENERATOR

Changing menu options

- 1 Press MENU, then select ADVANCED OPTIONS and press OK.

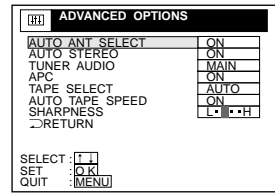

- 2 Press **↑/↓** to highlight the option to change, then press OK.
- 3 Press **↑/↓** to change the setting, then press OK.
To adjust SHARPNESS, press **←/→** and press OK.
- 4 Press MENU to return to the original screen.

Menu choices

Initial settings are indicated in bold print.

Menu option	Set this option to
AUTO ANT SELECT	<ul style="list-style-type: none"> • ON if your TV is connected only to VHF/UHF OUT on the VCR. To play a tape, set the TV to the VCR channel (channel 3 or 4). • OFF if your TV is connected to both VHF/UHF OUT and LINE OUT on the VCR. To play a tape, set the TV to the VCR input.
AUTO STEREO*	<ul style="list-style-type: none"> • ON to receive stereo programs. • OFF to reduce noise. The sound changes to monaural.
TUNER AUDIO*	<ul style="list-style-type: none"> • MAIN to record the main sound on both hi-fi and normal audio tracks. • SAP to record the SAP (Second Audio Program) sound on both hi-fi and normal audio tracks.
APC	<ul style="list-style-type: none"> • ON to switch on the APC (Adaptive Picture Control) function and improve picture quality. • OFF to switch off APC.
TAPE SELECT	<ul style="list-style-type: none"> • AUTO when using a T-160 length tape or any tape shorter than a T-140 length tape. • 180 when using a T-140 or T-180 length tape.
AUTO TAPE SPEED	<ul style="list-style-type: none"> • ON to change the timer recording tape speed automatically to the EP mode when the remaining tape length becomes shorter than the recording time. To operate AUTO TAPE SPEED, set TAPE SELECT correctly. • OFF to keep the tape speed.
SHARPNESS	L (Low) through H (High) to adjust the sharpness of the picture. L to turn off the sharpness control.

* SLV-L69HF MX, L72HF PA/PC, L79HF CL/CS/VZ, L89HF CL/CS/MX/VZ and X66HF MX only

Editing with another VCR

How to hook up to record on this VCR

SLV-L49 MX, L52 PA/PC, L59 CL/CS/PR/VZ and X55 MX

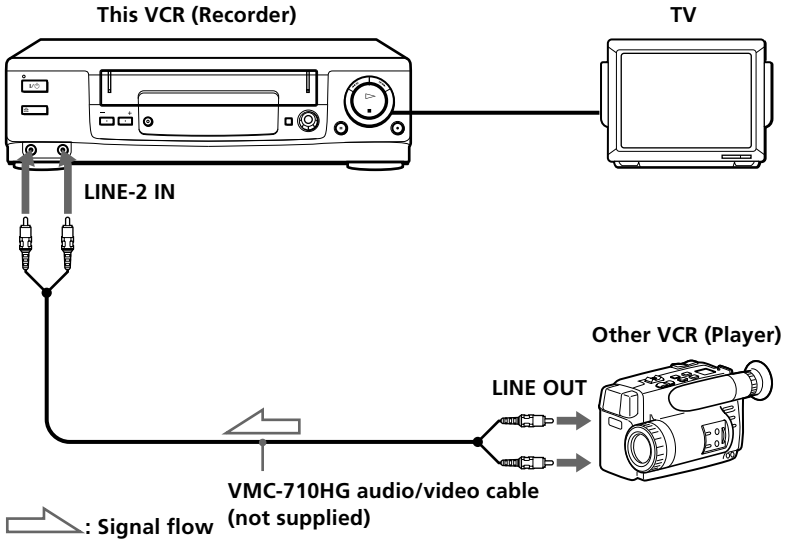

SLV-L69HF MX, L72HF PA/PC, L79HF CL/CS/VZ, L89HF CL/CS/MX/VZ and X66HF MX

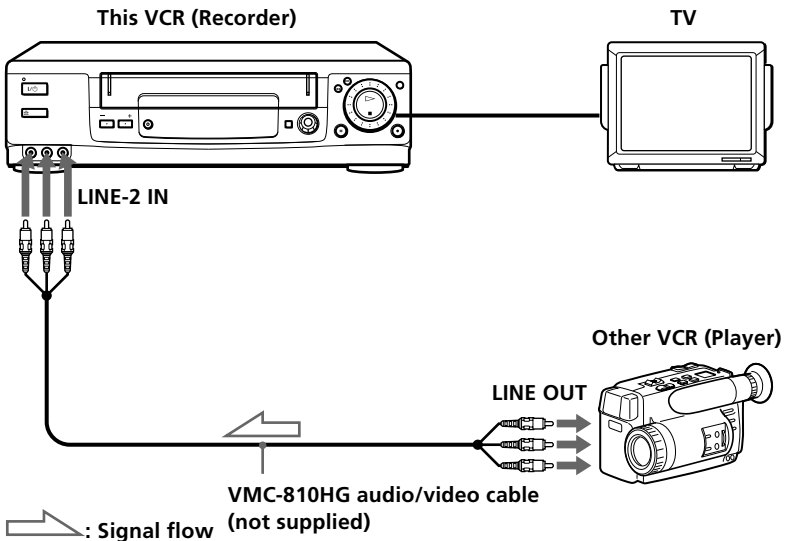

continued

Editing with another VCR (continued)

Notes

- Make sure you connect the plugs to jacks of the same color.
- If you connected this VCR to both the LINE IN and LINE OUT jacks of the other VCR, select the input correctly to prevent a humming noise.
- You can use the LINE-1 IN jacks for editing.
- If the other VCR is a monaural type and connected to this VCR's LINE-2 IN jacks, connect the audio plug to the AUDIO L (white) jack. The sound is recorded on both right and left channels. When connecting to the AUDIO R (red) jack, the sound is recorded only on the right channel (SLV-L69HF MX, L72HF PA/PC, L79HF CL/CS/VZ, L89HF CL/CS/MX/VZ and X66HF MX only).
- If the other VCR is a monaural type and connected to this VCR's LINE-1 IN jacks, the sound is recorded only on the channel whose jack is connected to the audio plug. To record on both right and left channels, connect the audio plugs to the AUDIO R/L jacks using a VMC-910HG audio/video cable (not supplied) (SLV-L69HF MX, L72HF PA/PC, L79HF CL/CS/VZ, L89HF CL/CS/MX/VZ and X66HF MX only).

Operation (when recording on this VCR)

Before you start editing

- Turn on your TV and set it to the video channel.
- Press INPUT SELECT to display "L2" (or "L1") in the display window.
- Press SP/EP to select the tape speed, SP or EP.

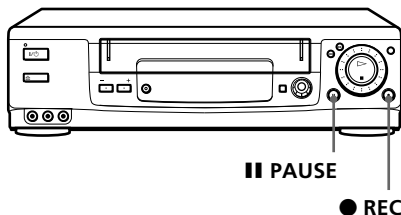

- 1** Insert a source tape with its safety tab removed into the other (playback) VCR. Search for the point to start playback and set it to playback pause.
- 2** Insert a tape into this (recording) VCR. Search for the point to start recording and press **|| PAUSE**.
- 3** Press **● REC** on this VCR and set it to recording pause.
- 4** To start editing, press the **|| PAUSE** buttons on both VCRs at the same time.

To stop editing

Press the **■ STOP** buttons on both VCRs.

Tip

- To cut out unwanted scenes while editing, press **|| PAUSE** on this VCR when an unwanted scene begins. When it ends, press **|| PAUSE** again to resume recording.

Note

- If you start recording following the procedure above, the VCR won't start recording with the APC function. To record a tape with the APC function, press **● REC** again during recording pause in step 3 so that the VCR analyzes the tape. Then when you start recording in step 4, press **|| PAUSE** immediately after the APC indicator stops flashing. If you press **|| PAUSE** before the APC indicator stops flashing, the APC function is canceled.

General setup information

Setting the RF unit

When connecting the VCR to the TV using only the antenna cable, you must set the RF UNIT switch on the rear of the VCR so that the TV can receive the correct signal from the VCR.

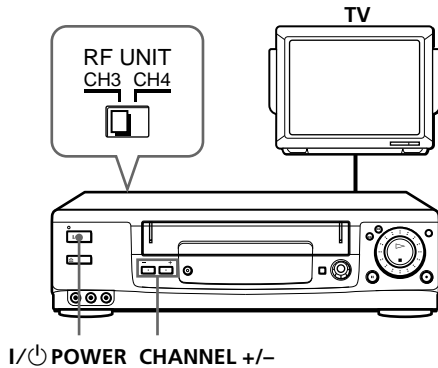

- 1** Set the RF UNIT switch on the rear of the VCR to CH3 or CH4, whichever channel is not used in your area. If both are used, set the switch to either channel.
- 2** Press I/⏻POWER to turn on the VCR.
- 3** Press TV/VIDEO to turn on the VIDEO indicator in the VCR's display window.
- 4** Press CHANNEL +/- to display a channel number in the display window. Select an active channel number in your area.
- 5** Turn on your TV and set it to the channel you selected in step 1 (channel 3 or 4).

The channel you selected in step 4 appears on the TV screen. If the channels change when you press CHANNEL +/-, you have made the correct setting.

Whenever you use the VCR, set the TV to the channel selected in step 1.

continued

General setup information (continued)

Attaching the external antenna connector

When using a 300-ohm twin lead cable for VHF/UHF antenna, use the EAC-32 antenna connector (not supplied) to connect the antenna to the VCR.

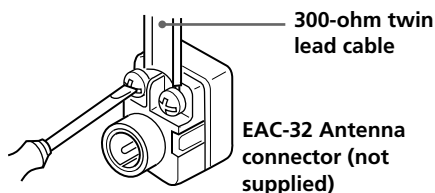

- 1** Loosen the screws on the antenna connector.
- 2** Wind the twin leads around the screws on the antenna connector.
- 3** Retighten the screws.

Attaching a UHF/VHF band mixer

When using both 75-ohm coaxial cable and 300-ohm twin lead cable for VHF/UHF antenna, use the EAC-66 UHF/VHF band separator/mixer (not supplied) to connect the antenna to the VCR.

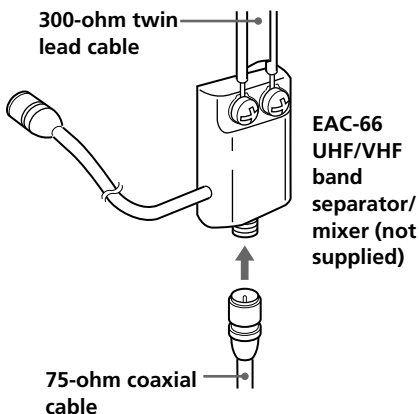

- 1** Loosen the screws on the mixer.
- 2** Wind the twin leads around the screws on the mixer.
- 3** Retighten the screws.
- 4** Connect the 75-ohm coaxial cable to the mixer.

Troubleshooting

If you have any questions or problems not covered below, please consult your nearest Sony dealer.

	Symptom	Remedy
Power	The I/⏻ switch does not function.	<ul style="list-style-type: none"> • Connect the AC power cord securely. • Make sure the VCR is not locked. To unlock, hold down I/⏻POWER on the VCR until the ⏻ indicator disappears.
	The power is turned on but the VCR does not operate.	<ul style="list-style-type: none"> • Moisture condensation occurs. Turn the power off, unplug the AC power cord and leave the VCR to dry for over three hours.
Clock	The clock has stopped and “--:--” lights in the display window.	<ul style="list-style-type: none"> • The clock stops if the VCR is disconnected from the wall outlet for more than eight hours. Reset the clock (and the timer).
Playback	The playback picture does not appear on the TV screen.	<ul style="list-style-type: none"> • Make sure the TV is set to the channel for the VCR. If you are using a monitor, set it to video input.
	The picture is not clear.	<ul style="list-style-type: none"> • Adjust the tracking with the TRACKING +/- buttons. • The video heads are dirty (see below). Clean the video heads using the Sony T-25CLD, T-25CLDR, or T-25CLW video head cleaning cassette. If these cleaning cassettes are not available in your area, have the heads cleaned at your nearest Sony service facility (a standard service fee will be charged). Do not use a commercially available liquid-type cleaning cassette other than Sony's, as it may damage the video heads. • The video heads may have to be replaced. Consult your local Sony dealer for more information.
	The picture rolls vertically during picture search.	<ul style="list-style-type: none"> • Adjust the vertical hold control on the TV or monitor.
	The picture has no sound.	<ul style="list-style-type: none"> • The tape is defective. • If you made A/V connections, check the audio cable connection.

Symptoms caused by contaminated video heads

- Normal picture
- Rough picture
- Unclear picture
- No picture (or black & white screen appears)

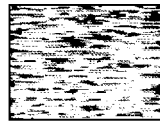

initial
contamination



terminal

continued

Troubleshooting (continued)

	Symptom	Remedy
Recording	A TV program does not appear on the TV screen.	<ul style="list-style-type: none"> • Make sure the TV is set to the channel for the VCR. If you are using a monitor, set it to video input. • Select the correct source with the INPUT SELECT button. Select a channel number when recording TV programs; select "L1" or "L2" when recording from other equipment.
	TV reception is poor.	<ul style="list-style-type: none"> • Adjust the TV antenna.
	The tape starts playing as soon as it is inserted.	<ul style="list-style-type: none"> • The safety tab has been removed. To record on this tape, cover the tab hole.
	The tape ejects when you press ●REC.	<ul style="list-style-type: none"> • Check that the safety tab has not been removed.
Timer recording	Nothing happens when you press ●REC.	<ul style="list-style-type: none"> • Make sure the tape is not at its end.
	The timer does not operate.	<ul style="list-style-type: none"> • Check that the clock is set. • Make sure a tape has been inserted. • Check that the safety tab has not been removed. • Make sure the tape is not at its end. • Make sure a program has been set for timer recording. • Make sure your timer settings have not already passed the current time. • Check that the cable box is turned on. • The clock stops if the VCR is disconnected from the wall outlet for more than eight hours. Reset the clock and timer.
Others	A tape cannot be inserted.	<ul style="list-style-type: none"> • Check that a tape is not already in the tape compartment.
	The remote commander does not function.	<ul style="list-style-type: none"> • Make sure you are pointing the remote commander at the remote sensor on the VCR. • Replace all the batteries in the remote commander with new ones if they are weak. • Make sure the [TV] / [VIDEO] switch is set correctly.
	The tracking meter does not appear on the screen.	<ul style="list-style-type: none"> • The recording condition of the tape is very poor and tracking cannot be adjusted.
	You cannot control other TVs.	<ul style="list-style-type: none"> • Set your TV's code number. The code number may change when you replace the batteries of the remote commander.
	The VCR needs to be cleaned.	<ul style="list-style-type: none"> • Clean the cabinet, panel and controls with a dry, soft cloth, or a soft cloth slightly moistened with a mild detergent solution. Do not use any type of solvent, such as alcohol or benzine.

Specifications

System

- Format
 - VHS NTSC standard
- Video recording system
 - Rotary head helical scanning FM system
- Video heads
 - Double azimuth four heads
- Video signal
 - NTSC color, EIA standards
- Tape speed
 - SP: 33.35 mm/s
 - EP: 11.11 mm/s
 - LP: 16.67 mm/s,
 - Playback only
- Maximum recording/playback time
 - 9 hrs. in EP mode (with T-180 tape)
- Fast-forward and rewind time
 - Approx. 3 min. (with T-120 tape)

Tuner section

- Channel coverage
 - VHF 2 to 13
 - UHF 14 to 69
 - CATV A-8 to A-1, A to W, W+1 to W+84
- Antenna
 - 75-ohm antenna terminal for VHF/UHF

Inputs and outputs

- LINE-1 IN/LINE-2 IN
 - VIDEO IN, phono jack (1 each)
Input signal: 1 V_{p-p}, 75 ohms, unbalanced, sync negative
 - AUDIO IN, phono jacks (1 each) (SLV-L49 MX, L52 PA/PC, L59 CL/CS/PR/VZ and X55 MX), (2 each) (SLV-L69HF MX, L72HF PA/PC, L79HF CL/CS/VZ, L89HF CL/CS/MX/VZ and X66HF MX)
Input level: 327 mVrms
Input impedance: more than 47 kilohms
- LINE OUT
 - VIDEO OUT, phono jack (1)
Output signal: 1 V_{p-p}, 75 ohms, unbalanced, sync negative
 - AUDIO OUT, phono jacks (1 each) (SLV-L49 MX, L52 PA/PC, L59 CL/CS/PR/VZ and X55 MX), (2 each) (SLV-L69HF MX, L72HF PA/PC, L79HF CL/CS/VZ, L89HF CL/CS/MX/VZ and X66HF MX)
Standard output: 327 mVrms
Load impedance: 47 kilohms
Output impedance: less than 10 kilohms

Timer section

- Clock
 - Quartz locked
- Timer indication
 - 12-hour cycle
- Timer setting
 - 8 programs per month (max.)
- Power back-up
 - Built-in self-charging capacitor
 - Back-up duration: up to 8 hours at a time

General

- Power requirements
 - 110 V AC to 240 V AC, 50/60 Hz (SLV-L59 CL/CS/PR, L79HF CL/CS and L89HF CL/CS)
 - 120 V AC, 60 Hz (SLV-L49 MX, L52 PA/PC, L59 VZ, X55 MX, L69HF MX, L72HF PA/PC, L79HF VZ, L89HF MX/VZ and X66HF MX)
- Power consumption
 - 18 W (SLV-L49 MX, L52 PA/PC, L59 CL/CS/PR/VZ and X55 MX)
 - 19 W (SLV-L69HF MX, L72HF PA/PC, L79HF CL/CS/VZ, L89HF CL/CS/MX/VZ and X66HF MX)
- Operating temperature
 - 5°C to 40°C (41°F to 104°F)
- Storage temperature
 - 20°C to 60°C (-4°F to 140°F)

- Dimensions
 - Approx. 355 × 96 × 289 mm (w/h/d)
including projecting parts and controls
- Mass
 - Approx. 3.7 kg

Supplied accessories

- Remote commander (1)
- Size AA (R6) batteries (2)
- 75-ohm coaxial cable with F-type connectors (1)
- Audio/video cable (3 phono to 3 phono) (1) (SLV-L69HF MX, L72HF PA/PC, L79HF CL/CS/VZ, L89HF CL/CS/MX/VZ and X66HF MX only)
- Plug adaptor (1) (SLV-L59 CL/CS/PR, L79HF CL/CS and L89HF CL/CS only)

Design and specifications are subject to change without notice.

Index to parts and controls

Refer to the pages indicated in parentheses () for details.

Front panel

SLV-L49 MX, L52 PA/PC, L59 CL/CS/PR/VZ, X55 MX

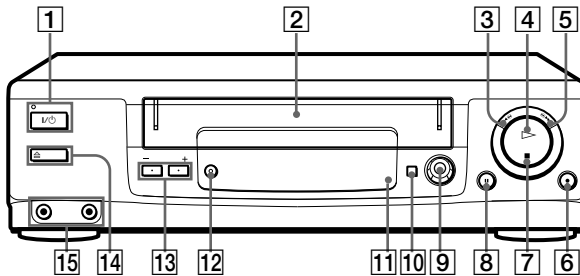

- | | |
|---|--|
| 1 I/⏻ POWER switch/indicator (45) | 9 DIAL TIMER button (54) |
| 2 Tape compartment | 10 EASY SET UP button (12, 15, 18, 21) |
| 3 ◀◀ ⏮ REW (rewind) button (39, 48) | 11 Remote sensor (5) |
| 4 ▷ PLAY button (39, 48) | 12 REALITY REGENERATOR button (63) (SLV-L52 PA/PC only) |
| 5 ▶▶ ⏭ FF (fast-forward) button (39, 48) | 13 CHANNEL/TRACKING +/- buttons (42, 62) |
| 6 ● REC (record) button (42, 57, 66) | 14 ▲ EJECT button (39) |
| 7 ■ STOP button (39) | 15 LINE-2 IN VIDEO/AUDIO jacks (65) |
| 8 PAUSE button (39) | |

SLV-L69HF MX, L72HF PA/PC, L79HF CL/CS/VZ, X66HF MX

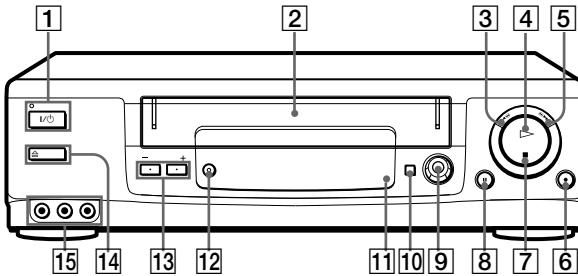

- | | |
|---|--|
| <p>1 I/⏻ POWER switch/indicator (45)</p> <p>2 Tape compartment</p> <p>3 ◀◀ ⏮ REW (rewind) button (39, 48)</p> <p>4 ▷ PLAY button (39, 48)</p> <p>5 ▶▶ ⏭ FF (fast-forward) button (39, 48)</p> <p>6 ● REC (record) button (42, 57, 66)</p> <p>7 ■ STOP button (39)</p> <p>8 PAUSE button (39)</p> | <p>9 DIAL TIMER button (54)</p> <p>10 EASY SET UP button (12, 15, 18, 21)</p> <p>11 Remote sensor (5)</p> <p>12 REALITY REGENERATOR button (63) (SLV-L72HF PA/PC only)</p> <p>13 CHANNEL/TRACKING +/- buttons (42, 62)</p> <p>14 ▲ EJECT button (39)</p> <p>15 LINE-2 IN VIDEO/AUDIO L/R jacks (65)</p> |
|---|--|

continued

Index to parts and controls (continued)

Front panel

SLV-L89HF CL/CS/MX/VZ

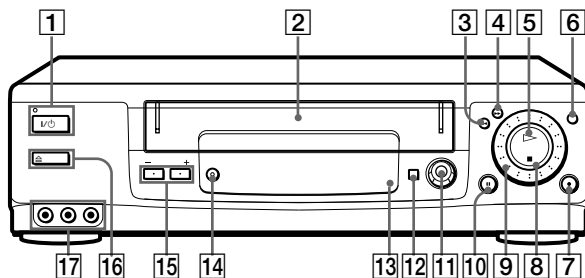

- | | |
|---|---|
| 1 I/⏻ POWER switch/indicator (45) | 10 PAUSE button (39) |
| 2 Tape compartment | 11 DIAL TIMER button (54) |
| 3 ◀◀ REW (rewind) button (39, 48) | 12 EASY SET UP button (12, 15, 18, 21) |
| 4 ▶▶ FF (fast-forward) button (39, 48) | 13 Remote sensor (5) |
| 5 ▷ PLAY button (39, 48) | 14 REALITY REGENERATOR button (63) |
| 6 JOG button (50) | 15 CHANNEL/TRACKING +/- buttons (42, 62) |
| 7 ● REC (record) button (42, 57, 66) | 16 ▲ EJECT button (39) |
| 8 ■ STOP button (39) | 17 LINE-2 IN VIDEO/AUDIO L/R jacks (65) |
| 9 Shuttle ring (43, 49) | |

Display window

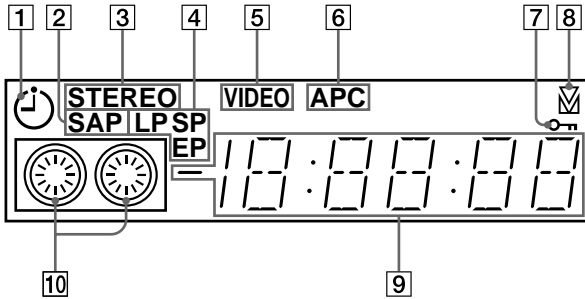

- 1 Timer indicator (45)
- 2 SAP (Second Audio Program) indicator (60) (SLV-L69HF MX, L72HF PA/PC, L79HF CL/CS/VZ, L89HF CL/CS/MX/VZ and X66HF MX only)
- 3 STEREO indicator (60) (SLV-L69HF MX, L72HF PA/PC, L79HF CL/CS/VZ, L89HF CL/CS/MX/VZ and X66HF MX only)
- 4 Tape speed indicator (42)
- 5 VIDEO indicator (43, 67)
- 6 APC (Adaptive Picture Control) indicator (62)
- 7 Child Lock indicator (46)
- 8 Tracking indicator (62)
- 9 Time counter/clock/line/channel indicator (39, 42, 66)
- 10 Tape/recording indicator (42)

continued

Index to parts and controls (continued)

Rear panel

SLV-L49 MX, L52 PA/PC, L59 CL/CS/PR/VZ, X55 MX

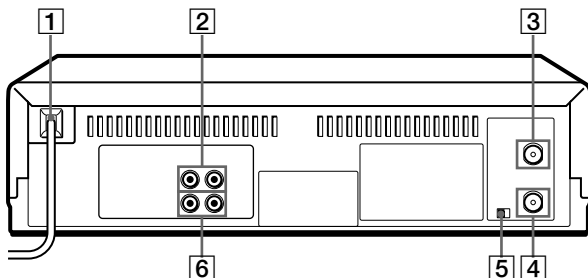

SLV-L69HF MX, L72HF PA/PC, L79HF CL/CS/VZ, L89HF CL/CS/MX/VZ, X66HF MX

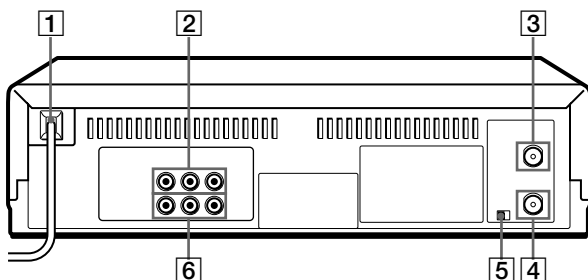

1 AC power cord (7)

2 LINE-1 IN AUDIO/VIDEO jacks (66) (SLV-L49 MX, L52 PA/PC, L59 CL/CS/PR/VZ and X55 MX only)

LINE-1 IN AUDIO R/L/VIDEO jacks (66) (SLV-L69HF MX, L72HF PA/PC, L79HF CL/CS/VZ, L89HF CL/CS/MX/VZ and X66HF MX only)

3 VHF/UHF IN connectors (11, 14, 17, 20)

4 VHF/UHF OUT connectors (11, 14, 17, 20)

5 RF (Radio Frequency) UNIT switch (67)

6 LINE OUT AUDIO/VIDEO jacks (8) (SLV-L49 MX, L52 PA/PC, L59 CL/CS/PR/VZ and X55 MX only)

LINE OUT AUDIO R/L/VIDEO jacks (9) (SLV-L69HF MX, L72HF PA/PC, L79HF CL/CS/VZ, L89HF CL/CS/MX/VZ and X66HF MX only)

Remote commander

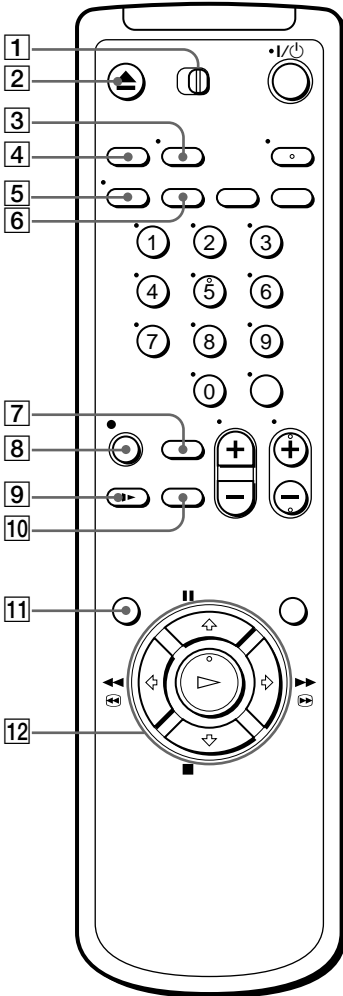

- 1 TV/ VIDEO switch (5)
- 2 ▲ EJECT button (39)
- 3 TV/VIDEO button (6, 43)
- 4 TRINITRON TV SYNCHRO PLAY button (40)
- 5 DISPLAY button (43, 51)
- 6 SP (Standard Play)/EP (Extended Play) button (42)
- 7 INPUT SELECT button (42, 43, 66)
- 8 ● REC (record) button (42, 57, 66)
- 9 ► SLOW button (48)
- 10 x2 button (48)
- 11 MENU button (24)
- 12
 - ▬▬ PAUSE/▲ button (24, 39)
 - STOP/▼ button (24, 39)
 - ◀◀ ◻ REW (rewind)/◀ button (39, 48)
 - ▶▶ ◻ FF (fast-forward)/▶▶ button (39, 48)
 - ▷ PLAY/OK button (24, 39)

continued

Index to parts and controls (continued)

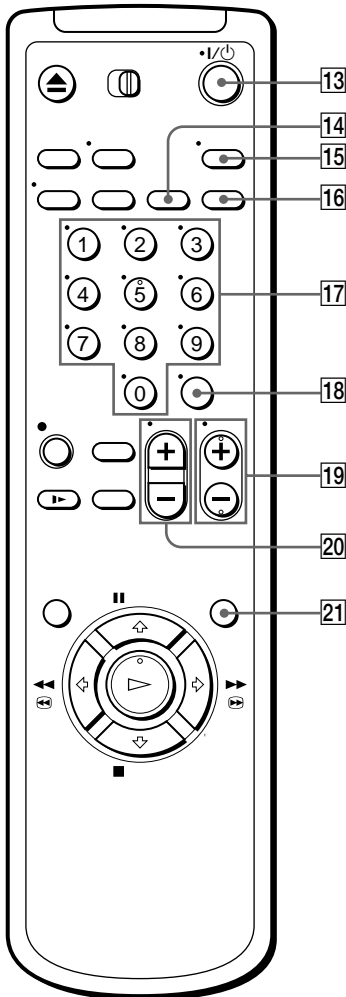

- 13 I/O (power) switch (6, 45)
- 14 CLEAR button (39, 59)
- 15 AUDIO MONITOR button (60)
(SLV-L69HF MX, L72HF PA/PC,
L79HF CL/CS/VZ, L89HF CL/CS/
MX/VZ and X66HF MX only)
- 16 TIMER button (44, 58)
- 17 Number buttons (43)
- 18 ENTER button (43)
- 19 CH (channel) +/- buttons (6, 42)
- 20 VOL (volume) +/- buttons (6)
- 21 REPLAY button (39)

Index

A, B

- Adjusting
 - picture 62
 - tracking 62
- Advanced option 64
- AFT (Auto Fine Tuning) 36
- Antenna hookup 11
- APC (Adaptive Picture Control) 62
- Audio track 61
- Audio/video (A/V) hookup 8
- Auto Clock Set 25
- Auto Tape Speed 64

C

- Cable hookup 7
- Child Lock 46
- Cleaning the video heads 69
- Clock setting 25
- Connecting
 - cable TV 7
 - external antenna connector 68
 - UHF/VHF band mixer 68
- Counter 39

D

- Dial timer 54
- Disabling channels 34
- Dubbing *See* Editing.

E, F, G

- Easy Set Up 12, 15, 18, 21
- Editing 65
- EP mode 42

H, I, J, K

- Hi-fi audio track 61

L

- Language selecting 24
- Locking the VCR 46
- LP mode 39

M

- Monaural 60
- Monitoring audio during playback 60

N, O

- Normal audio track 61

P

- Picture adjustment
 - See* Adjusting
- Playback 38
 - at various speeds 48
 - frame-by-frame 48
 - selecting the sound 60
 - slow motion 48
- Presetting channels 31

R

- Reality regenerator 63
- Recording 41
 - bilingual programs 60
 - SAP broadcasts 60
 - saving 43
 - stereo broadcasts 60
 - timer setting 44
 - while watching another program 43
- RF channel 67

S

- Safety tab 43
- SAP (Second Audio Program) 60
- Searching
 - at various speeds 48
 - for a selected point 51
 - skip-search 53
- SP mode 42
- Stereo 60

T, U, V, W, X, Y, Z

- Timer setting 44
 - canceling 58
 - changing 58
 - checking 58
 - daily/weekly recording 46
- Tracking adjustment
 - See* Adjusting
- Trinitron TV Synchro Play 40
- Tuner presetting 31

Quick reference to using the VCR

Hookup 1

To play a tape

- 1 Set the TV to channel 3 or 4 (or to video input, if you made A/V connections.)
- 2 Insert a tape and press \triangleright PLAY. If there's no picture on your TV, press the VCR's TV/VIDEO button until the VIDEO indicator comes on in the display window.

To record a program

- 1 Press TIMER.
- 2 Set the date, time, channel, and tape speed.
- 3 Press TIMER.
- 4 Insert a tape.
- 5 Press I/⏻ to turn off the VCR.

To watch TV

- 1 Turn off the VCR, or press the VCR's TV/VIDEO button until the VIDEO indicator in the display window goes off.
- 2 Set the TV to the channel you want to watch.

Hookup 2

To play a tape

- 1 If you made A/V connections, set the TV to video input.
If you didn't use A/V hookup:
 - Turn on the cable box.
 - Set the cable box to channel 3 or 4.
 - Set the TV to the output channel of the cable box (usually 2, 3 or 4).
- 2 Insert a tape and press \triangleright PLAY. If there's no picture on your TV, press the VCR's TV/VIDEO button until the VIDEO indicator comes on in the display window.

To record a program

- 1 Press TIMER.
- 2 Set the date, time, channel, and tape speed.
- 3 Press TIMER.
- 4 Insert a tape.
- 5 Press I/⏻ to turn off the VCR.

To watch TV

- 1 Turn off your VCR, or press the VCR's TV/VIDEO button until the VIDEO indicator in the display window goes off.
- 2 Select the channel with your cable box (if you have one) or with your TV.

Hookup 3

To play a tape

- 1 Set the TV to channel 3 or 4 (or to video input, if you made A/V connections.)
- 2 Insert a tape and press \triangleright PLAY. If there's no picture on your TV, press the VCR's TV/VIDEO button until the VIDEO indicator comes on in the display window.

To record a program

- 1 Turn on the cable box.
- 2 Set the cable box to the channel you want to record.
- 3 Press TIMER.
- 4 Set the date, time, channel, and tape speed.
- 5 Press TIMER.
- 6 Insert a tape.
- 7 Press I/⏻ to turn off the VCR.
- 8 Leave the cable box on.

To watch TV

- 1 Turn off your VCR, or press the VCR's TV/VIDEO button until the VIDEO indicator in the display window goes off.
- 2 Turn on your cable box.
- 3 Set the TV to the cable box output channel (usually 2, 3, or 4).
- 4 Set the cable box to the channel you want to watch.

Free Manuals Download Website

<http://myh66.com>

<http://usermanuals.us>

<http://www.somanuals.com>

<http://www.4manuals.cc>

<http://www.manual-lib.com>

<http://www.404manual.com>

<http://www.luxmanual.com>

<http://aubethermostatmanual.com>

Golf course search by state

<http://golfingnear.com>

Email search by domain

<http://emailbydomain.com>

Auto manuals search

<http://auto.somanuals.com>

TV manuals search

<http://tv.somanuals.com>