

MODEL 1601E  
MUSIC MIXER

# USER GUIDE





**IMPORTANT**  
Please read this manual carefully before using  
your mixer for the first time.



This equipment complies  
with the EMC directive  
89/336/EEC  
Modified by  
92/31/EEC  
93/68/EEC  
91/263/EEC  
and LVD 73/23/EEC  
modified by 93/68/EEC

This product is approved to  
safety standards:

IEC 60065: 2001  
EN60065:2002  
UL6500 7th Edition: 2003  
CAN/CSA-E60065-03

And EMC standards  
EN55103-1: 1996 (E2)  
EN55103-2: 1996 (E2)

**For further details contact:**

Harman International Industries Ltd.  
Cranborne House, Cranborne Road  
Potters Bar, Hertfordshire, EN6 3JN, UK

Tel: +44 (0) 1707 665000  
Fax: +44 (0) 1707 660742  
e-mail: [info@soundcraft.com](mailto:info@soundcraft.com)

© Harman International Industries Ltd. 2005

All rights reserved

Parts of the design of this product may be protected by worldwide patents.

Part No. ZM0330-01

Soundcraft is a trading division of Harman International Industries Ltd. Information in this manual is subject to change without notice and does not represent a commitment on the part of the vendor. Soundcraft shall not be liable for any loss or damage whatsoever arising from the use of information or any error contained in this manual.

No part of this manual may be reproduced, stored in a retrieval system, or transmitted, in any form or by any means, electronic, electrical, mechanical, optical, chemical, including photocopying and recording, for any purpose without the express written permission of Soundcraft.



Soundcraft

Harman International Industries Limited  
Cranborne House  
Cranborne Road  
POTTERS BAR  
Hertfordshire  
EN6 3JN  
UK

Tel: +44 (0)1707 665000  
Fax: +44 (0)1707 660742  
<http://www.ureidj.com>

# Contents

IMPORTANT SAFETY INSTRUCTIONS	4
SAFETY SYMBOL GUIDE	6
<b>INTRODUCTION</b>	<b>7</b>
BPM EFFECTS	7
<b>INSTALLATION</b>	<b>9</b>
GENERAL PRECAUTIONS	9
MAINS INSTALLATION	9
INITIAL WIRING CONSIDERATIONS	10
AUDIO WIRING	10
SHIELDING	10
WORKING SAFELY WITH SOUND	10
POINTS TO REMEMBER	11
INSPECTION AND INSTALLATION	12
CONNECTING TO A TYPICAL SOUND SYSTEM	13
MAKING ADJUSTMENTS AND FITTING SPARES	14
<b>DESCRIPTION</b>	<b>16</b>
TOP PANEL	16
REAR CONNECTOR PANEL	18
FRONT PANEL	19
<b>OPERATION</b>	<b>20</b>
GETTING STARTED	20
MIC / LINE INPUT	20
CHANNELS 1 & 2	22
FX SEND & RETURN / AUX	24
MASTER / BOOTH OUTPUT	26
X-FADER	27
HEADPHONE MONITOR	28
<b>THE BPM FX MODULE</b>	<b>30</b>
OPERATING CRITERIA	30
TOP PANEL CONTROLS	30
QUICK START	33
OPERATION	34
EFFECT CONTROLS	36
SINGLE/MULTI MODE OPERATION	38
THE EFFECTS	40
PRE-SET VOICE LIST	46
HINTS & TIPS	46
<b>BLOCK DIAGRAM</b>	<b>47</b>
<b>CONNECTING LEADS</b>	<b>48</b>
<b>TROUBLESHOOTING</b>	<b>49</b>
<b>SPECIFICATIONS</b>	<b>50</b>
<b>WARRANTY</b>	<b>51</b>
<b>GLOSSARY</b>	<b>52</b>

# IMPORTANT SAFETY INSTRUCTIONS

Read these instructions.

Keep these instructions.

Heed all warnings.

Follow all instructions.

Do not use this apparatus near water.

Clean only with a dry cloth.

Do not block any ventilation openings. Install in accordance with the manufacturer's instructions.

Do not install near any heat sources such as radiators, heat registers, stoves, or other apparatus (including amplifiers) that produce heat.

Do not defeat the safety purpose of a polarised or grounding type plug. A polarised plug has two blades with one wider than the other. A grounding type plug has two blades and a third grounding prong. The wide blade or the third prong are provided for your safety. If the provided plug does not fit into your outlet, consult an electrician for replacement of the obsolete outlet

Protect the power cord from being walked on or pinched particularly at plugs, convenience receptacles and the point where they exit from the apparatus.

Only use attachments/accessories specified by the manufacturer.



Use only with the cart, stand, tripod, bracket or table specified by the manufacturer, or sold with the apparatus. When a cart is used, use caution when moving the cart/apparatus combination to avoid injury from tip-over.

Unplug this apparatus during lightning storms or when unused for long periods of time.

Refer all servicing to qualified service personnel. Servicing is required when the apparatus has been damaged in any way, such as power-supply cord or plug is damaged, liquid has been spilled or objects fallen into the apparatus, the apparatus has been exposed to rain or moisture, does not operate normally, or has been dropped.

Note: It is recommended that all maintenance and service on the product should be carried out by Soundcraft or its authorised agents. Soundcraft cannot accept any liability whatsoever for any loss or damage caused by service, maintenance or repair by unauthorised personnel.

**WARNING:** To reduce the risk of fire or electric shock, do not expose this apparatus to rain or moisture.

Do not expose the apparatus to dripping or splashing and do not place objects filled with liquids, such as vases, on the apparatus.

No naked flame sources, such as lighted candles, should be placed on the apparatus.

Ventilation should not be impeded by covering the ventilation openings with items such as newspapers, table cloths, curtains etc.

**THIS APPARATUS MUST BE EARTHED.** Under no circumstances should the safety earth be disconnected from the mains lead.

The mains supply disconnect device is the mains plug. It must remain accessible so as to be readily operable when the apparatus is in use.

If any part of the mains cord set is damaged, the complete cord set should be replaced. The following information is for reference only.

The wires in the mains lead are coloured in accordance with the following code:

Earth (Ground):	Green and Yellow (US - Green/Yellow)
Neutral:	Blue (US - White)
Live (Hot):	Brown (US - Black)

As the colours of the wires in the mains lead may not correspond with the coloured markings identifying the terminals in your plug, proceed as follows:

The wire which is coloured Green and Yellow must be connected to the terminal in the plug which is marked with the letter E or by the earth symbol. 

The wire which is coloured Blue must be connected to the terminal in the plug which is marked with the letter N

The wire which is coloured Brown must be connected to the terminal in the plug which is marked with the letter L

Ensure that these colour codes are followed carefully in the event of the plug being changed

This unit is capable of operating over a range of mains voltages as marked on the rear panel.

**NOTE:** This equipment has been tested and found to comply with the limits for a Class A digital device, pursuant to Part 15 of the FCC Rules. These limits are designed to provide reasonable protection against harmful interference when the equipment is operated in a commercial environment. This equipment generates, uses and can radiate radio frequency energy and, if not installed and used in accordance with the instruction manual, may cause harmful interference to radio communications. Operation of this equipment in a residential area is likely to cause harmful interference in which case the user will be required to correct the interference at his own expense.

This Class A digital apparatus meets the requirements of the Canadian Interference-Causing Equipment Regulations.

Cet appareil numérique de la Classe A respecte toutes les exigences du Règlement sur le matériel brouilleur du Canada.

**For your own safety and to avoid invalidation of the warranty please read this section carefully.**

## **SAFETY SYMBOL GUIDE**

For your own safety and to avoid invalidation of the warranty all text marked with these symbols should be read carefully.



### **WARNINGS**

The lightning flash with arrowhead symbol, is intended to alert the user to the presence of un-insulated “dangerous voltage” within the product’s enclosure that may be of sufficient magnitude to constitute a risk of electric shock to persons.



### **CAUTIONS**

The exclamation point within an equilateral triangle is intended to alert the user to the presence of important operating and maintenance (servicing) instructions in the literature accompanying the appliance.



### **NOTES**

Contain important information and useful tips on the operation of your equipment.



### **HEADPHONES SAFETY WARNING**

Contain important information and useful tips on headphone outputs and monitoring levels.

Recommended Headphone Impedance  $\geq$  200 Ohms.

### **TIP**



Contains a useful “tip” on how to get the best out of your equipment.

# INTRODUCTION

## BPM EFFECTS

Congratulations! By purchasing a 1601E you have joined an exclusive club of musicians, re-mixers and Djs who have discovered a new level of power and control over the effects in their music. Previously, to make effects happen in time with music was a matter of painstaking analysis of the source signal and time consuming tweaking of parameters on effects units to make sure that the tempo inherent in the effects did not clash with or break up the tempo of the music.

In one fell swoop 1601E does away with all that tedious messing about (matching milliseconds to BPMs and hooking multiple effects units together) by assembling everything you need in one unit to filter, flange, gate, delay and pan in perfect synchronisation with your music. At the heart of the 1601E is UREI's BPM Analysis Engine, which shoulders the responsibility of calculating the tempo of the music. This leaves you free to concentrate on the real-time controls of the simultaneous effects 1601E offers. Four of these effects have been available in various forms before, but never in such an easy-to-use and innovative form. By triggering the filter in time with the music, you can seriously alter the harmonic shape of the sound without destroying the beat, or perhaps choose the radical flange, for a classic sweep that's right out there. The gate makes gating and shaping the overall volume of the music in time a breeze but perhaps the greatest timesaving is in the automatic synchronization of delays to the tempo of the music. No more look-up tables for BPM equivalents in milliseconds, or complicated formulas that need a calculator. You just decide which beats you want to hear the delays coincide with and then you can move on to more creative decisions such as whether the delays should sound like a clinical 90's digital delay, a warm 60's tape delay or a more extreme 'vintage'.

But even the unique combination of these facilities is dwarfed by 1601E's ability to split the audio input into three bands (Low, Mid and High) which can then be panned around independently in the stereo field. Spacial Panning System (SPS) will enable entirely new effect textures and beat-related movements in the music of the future. In addition, the 3-band isolator lets you choose which elements of the music pass through the effects.

This manual is designed to get you using the effects and sync'ing them to the music as quickly as possible. The simple real-time operation of the effects parameters and beat assignment is described in detail, but at no time does it try and define how these effects should be used. We tell you how 1601E works but never how to use it.

From the really subtle to the most excessive effects imaginable, it's down to you!

## Registering Your Mixer

Please take this opportunity to register the purchase of your mixer with Urei By Soundcraft. You can do this by filling in the pre-paid postcard included in the packaging, or by going online to [www.ureidj.com/registration](http://www.ureidj.com/registration).



Urei by Soundcraft recommends AKG Professional Dj Headphones.

Please visit [www.ake.com/dj](http://www.ake.com/dj) for more information.







# INSTALLATION

The 1601E is ruggedly constructed with the highest quality components. As such, it should provide years of trouble free use with normal care. All parts used are conservatively rated for their application, and workmanship meets UREI by Soundcraft's rigid standard.

**NO SPECIAL PREVENTIVE MAINTENANCE IS REQUIRED, AND (WITH THE EXCEPTION OF THE PRE-TRIM ATTENUATORS) THERE ARE NO INTERNAL SERVICE ADJUSTMENTS.**

## GENERAL PRECAUTIONS

Avoid storing or using the mixing console in conditions of excessive heat or cold, or in positions where it is likely to be subject to vibration, dust or moisture. Do not use any liquids to clean the fascia of the unit: a soft dry cloth is ideal.

Avoid using the console close to strong sources of electromagnetic radiation (e.g. video monitors, high-power electric cabling): this may cause degradation of the audio quality due to induced voltages in connecting leads and chassis.

**Caution! In all cases, refer servicing to qualified personnel.**

### Handling and Transport

The console is supplied in a strong carton. If it is necessary to move it any distance after installation it is recommended that this packing is used to protect it. Be sure to disconnect all cabling before moving. If the console is to be regularly moved we recommend that it is installed in a foam lined flightcase. At all times avoid applying excessive force to any knobs, switches or connectors.

### Power Cable

Always use the power supply cable supplied with the mixer: the use of alternative cables may cause damage and voids the warranty.

**Warning ! In the event of an electrical storm, or large mains voltage fluctuations, immediately unplug from the mains.**

### Signal Levels

It is important to supply the correct input levels to the console, otherwise signal to noise ratio or distortion performance may be degraded; and in extreme cases, damage to the internal circuitry may result. Likewise, on all balanced inputs avoid sources with large common mode DC, AC or RF voltages, as these will reduce the available signal range on the inputs. Note that  $OdBu = 0.775V$  RMS.

Refer to the Specifications section for details of input and output levels.

## MAINS INSTALLATION

### General Wiring Procedures

To take full advantage of the excellent signal to noise ratio and low distortion of Soundcraft consoles, care must be taken to ensure that incorrect installation and wiring does not degrade the performance of the desk. Hum, buzz, instability and Radio Frequency interference can usually be traced to earth loops and inferior earthing systems. In some areas, especially heavily industrial areas, the incoming mains earth will not be adequate and a separate technical earth for all the audio equipment must be supplied. However, check with your local electricity supply company to ensure that safety regulations are not infringed or negated.

The successful, hum free, installation of a system requires forethought, and the establishment of a set of ground rules, which must be consistently adhered to at all stages of installation.

## INITIAL WIRING CONSIDERATIONS

For optimum performance, it is essential for the earthing system to be clean and noise free, as all signals are referenced to this earth. A central point should be decided on for the main earth point system, and all earths should be 'star fed' from this point. It is common electrical practice to 'daisy chain' the earths to all electrical outlets but this method is unsuitable for audio installations. The preferred method is to run an individual earth wire from each outlet, back to the system star point to provide a safety earth screen reference for each piece of equipment. A separate earth wire should also be run from each equipment rack and area, to the star point. This may or may not be used depending on circumstances, but it is easier to install in the first place, than later when problems arise. The location of the star point should be a convenient, easily accessible place, preferably at the rear of the console or in the main equipment rack.

Install separate 'clean' and 'dirty' mains outlets, wired individually back to the incoming mains distribution box. Use the 'clean' supply for all audio equipment and the 'dirty' supply for all lighting, etc. Never mix the two systems.

If necessary, to provide sufficient isolation from mains borne interference on the booth output, install an isolating transformer. This should be provided with a Faraday Shield which must be connected with earth.

Never locate the incoming mains distribution box near audio equipment, especially tape recorders, which are very sensitive to electromagnetic fields.

Ensure that all equipment racks are connected to earth, via a separate wire back to the star point.

Equipment which has unbalanced inputs and outputs may need to be isolated from the rack to prevent earth loops.

## AUDIO WIRING

Having provided all equipment with power and earthing connections, consideration must be given to the method of providing audio interconnection and adequate screening of those interconnections. This must be done in a logical sequence to avoid problems and assist in the localisation of problem equipment.

Connect the Main or Booth system to the console and check for any hum, buzz, or RFI. Only when you are satisfied with the quietness of the console and the PA system should you proceed with the next step.

Connect decks or CD players, FX and sends one at a time, checking and isolating any connection which degrades performance.

Connect all other peripheral devices.

Connect all microphone lines.

By following this sequence much time and future trouble will be saved, and the result will be a quiet, stable system.

## SHIELDING

Audio equipment is supplied with a variety of input and output configurations, which must be taken into consideration when deciding where the screen connections should be made. There are three sources of unwanted signal being impressed on the screen, which are as follows:

Extraneous electrostatic or electromagnetic fields.

Noise and interference on the earth line.

Capacitive coupling between the screen and signal wires.

To minimise the adverse affects of the unwanted coupling to the signal wires, it is important that the screen is connected at one end only, i.e. the screen must not carry any signal current. Any signal on the wires within the screen will be capacitively coupled to the screen. This current will ultimately be returned to the source of the signal, either directly, if the screen is connected at the signal source end, or indirectly via the earthing system, if the signal is connected at the signal destination end. The indirect connection will cause an increase in high frequency cross-talk, and should be avoided wherever possible.

Therefore, in general, always connect the shield only at the signal source end. In high RF areas, the screen can also be connected to earth via a 0.01 mF capacitor. This will present a short circuit at RF frequencies, thus lowering the effective shield impedance to ground. However, at low audio frequencies the capacitor will effectively be an open circuit and thus not cause an earth loop problem.

## POINTS TO REMEMBER

In all cases, use good quality twin screened audio cable. Check for instability at the output.

Always connect both conductors at both ends, and ensure that the screen is only connected at one end.

Do not disconnect the mains earth from each piece of equipment. This is needed to provide both safety and screen returns to the system star point.

Equipment which has balanced inputs and outputs may need to be electrically isolated from the equipment rack and/or other equipment, to avoid earth loops.

It is important to remember that all equipment which is connected to the mains is a potential source of hum and interference and may radiate both electrostatic or electromagnetic radiation. In addition, the mains will also act as a carrier for many forms of RF interference generated by electric motors, air-conditioning units, thyristor light dimmers etc. Unless the earth system is clean, all attempts to improve hum noise levels will be futile. In extreme cases there will be no alternative but to provide a completely separate and independent 'technical earth' to replace the incoming 'noisy earth'. However, always consult your local electricity supply authority to ensure that safety regulations are not being infringed.

## WORKING SAFELY WITH SOUND



Although your new console will not make any noise until you feed it signals, it has the capability to produce sounds which when monitored through an amplifier or headphones can damage hearing. Always turn amplifiers down when turning your console on or off.

The table below is taken from the Occupational Safety & Health Administration directive on Occupational noise exposure (1926.52):

### PERMISSIBLE NOISE EXPOSURE

DURATION PER DAY, HOURS	SOUND LEVEL dBA SLOW RESPONSE
8	90
6	92
4	95
3	97
2	100
1.5	102
1	105
0.5	110
<0.25	115

Conforming to this directive will minimise the risk of hearing damage caused by long listening periods. A simple rule to follow is the longer you listen the lower the average volume should be.

Please take care when working with your audio - if you are manipulating controls which you don't understand (which we all do when we are learning), make sure your monitors are turned down. Remember that your ears are the most important tool of your trade, look after them, and they will look after you.

Most importantly - don't be afraid to experiment to find out how each parameter affects the sound - this will extend your creativity and help you to get the best results.

# INSPECTION AND INSTALLATION

## UNPACKING AND INSPECTION

Your 1601E was carefully packed at the factory, and the container was designed to protect the unit from rough handling. Nevertheless, we recommend careful examination of the shipping carton and its contents for any sign of physical damage which could have occurred in transit.

If damage is evident, do not destroy any of the packing material or the carton, and immediately notify the carrier of a possible claim for damage. Shipping claims must be made by the consignee.

The carton should contain:

Model 1601E Music Mixer.

Mains Cable

UREI Instruction Manual (this book).

Warranty Card (the serial number tag is on the base panel of the Mixer).

2mm Allen key

## ENVIRONMENTAL CONSIDERATIONS

The 1601E Mixer will operate satisfactorily over a range of ambient temperatures from 0 C to +50C (+32F to +122F), and up to 80% non-condensing relative humidity.

If the system is installed in an equipment rack, console or desk with high heat producing equipment (such as power amplifiers), adequate ventilation should be provided in order to assure longest component life. Also, while circuitry susceptible to hum pick-up is sufficiently shielded from moderate electromagnetic fields, installation should be planned to avoid mounting the system immediately adjacent to large power transformers, motors, etc.

## POWERING

The 1601E may be operated from 100-250V AC mains (50-60 Hz, single phase). **BE SURE TO VERIFY LINE VOLTAGE BEFORE CONNECTING THE 1601E TO THE MAINS.**



Please Note. The IEC mains connector is fitted with a retaining clip to prevent the mains lead from accidentally being pulled out during operation. To ensure that this clip will fit correctly, the lead supplied with the mixer must be used.

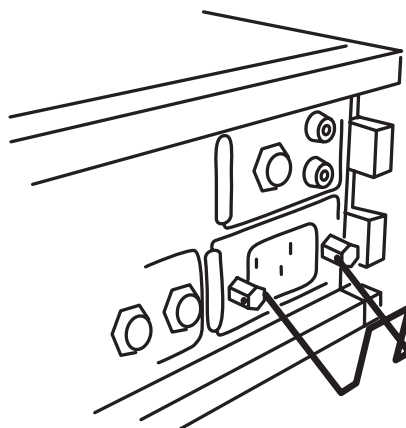

# CONNECTING TO A TYPICAL SOUND SYSTEM

The diagram below shows how to connect the different parts of a typical sound system.

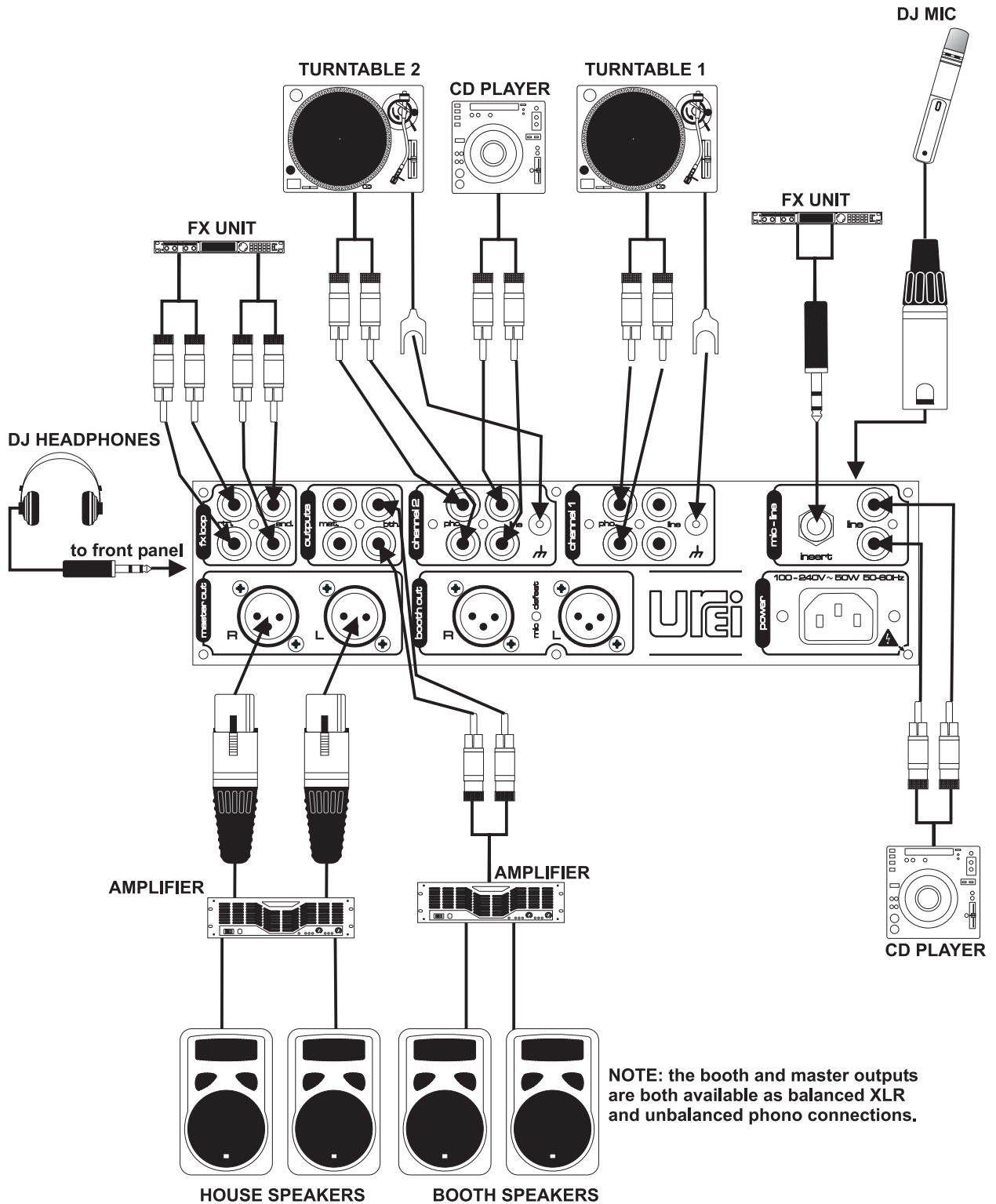

## MAKING ADJUSTMENTS AND FITTING SPARES



**CAUTION: THE FOLLOWING SECTION IS FOR USE BY QUALIFIED SERVICE PERSONNEL ONLY. TO REDUCE THE RISK OF ELECTRIC SHOCK, DO NOT REMOVE THE TOP FASCIA TO PERFORM ANY SERVICING OR OTHER TASKS, UNLESS YOU ARE QUALIFIED TO DO SO.**



**BEFORE REMOVING THE TOP FASCIA ENSURE THE UNIT IS DISCONNECTED FROM THE MAINS SUPPLY.**

**ONLY REMOVE THE ALLEN SCREWS INDICATED ON THE DIAGRAM OPPOSITE. WARNING: DO NOT OVER-TIGHTEN THE SCREWS AFTERWARDS.**

It is necessary to remove the top panel fascia in order to carry out one or more of the following tasks:

- Setting the pre-trim pads on channels 1 & 2 during installation.
- Changing the orientation of the Phono/Line switches.
- Replacing any of the four linear faders.
- Removing the Sampler section

To remove the top panel fascia proceed as follows:

Pull off all the fader and pot knobs.

Undo the 6 retaining Allen screws using a 2mm Allen key. These are located down the left and right hand edges of the fascia. The fascia can now be lifted clear of the subframe underneath. Take care not to bend the panel.

The diagram opposite shows a view of the mixer (1601S) without the top fascia fitted.

### Setting The Pre-trim Pads

These pads are used to reduce the input level to channels 1 & 2, or to reduce the input when using a piece of equipment with a high output level.

There are 2 pads on each of the 2 input channels. The -20dB pads are on either side of the FX paddle switch, and the -10dB pads are below them. The switches are push-on push-off types. The pads are in-circuit when the switches are depressed. Depress the -10dB switches to select the -10dB pads. To select the -20dB pads both sets of switches (-10 and -20) must be depressed (depressing only the -20 switches will have no effect).

### Changing The Orientation Of The Phono/Line Switches

The orientation of these switches can be changed to suit personal preference, e.g. left or right handed.

Using a 2mm Allen key undo and remove the 3 Allen screws around the edge of the circular switch mounting plate. The switch plate can now be rotated in 15-degree steps. The plate can be re-attached to the subframe with the Allen screws when a convenient angle has been chosen.

### Replacing The Faders

Using a 2mm Allen key undo and remove the 3 Allen screws (the X-F Monitor fader has only 2 screws) which secure the fader mounting plate to the subframe. Carefully withdraw the fader, taking care not to damage the wiring harness that is attached to it. Unplug the 3-pin connector, **wiggle the plug from side to side as you pull the plug from the socket**. Plug the connector into the new fader. The connector is keyed so that it cannot be inserted the wrong way round. Carefully place the new fader back into the subframe and secure with the Allen screws removed earlier, **DO NOT OVER-TIGHTEN THE SCREWS**.

### Replaceable Spares Part Numbers

RS2332 - Urei 1601E Fader Spares Assembly

RS2333 - Urei 1601E Phono/ Line Switch Spares Assembly

RS2334 - Urei 1601E X-Fader Mon Spares Assembly or BPM FX Mix Fader Assembly

RS2389 - Urei 1601E Effects Panel



# DESCRIPTION

## TOP PANEL

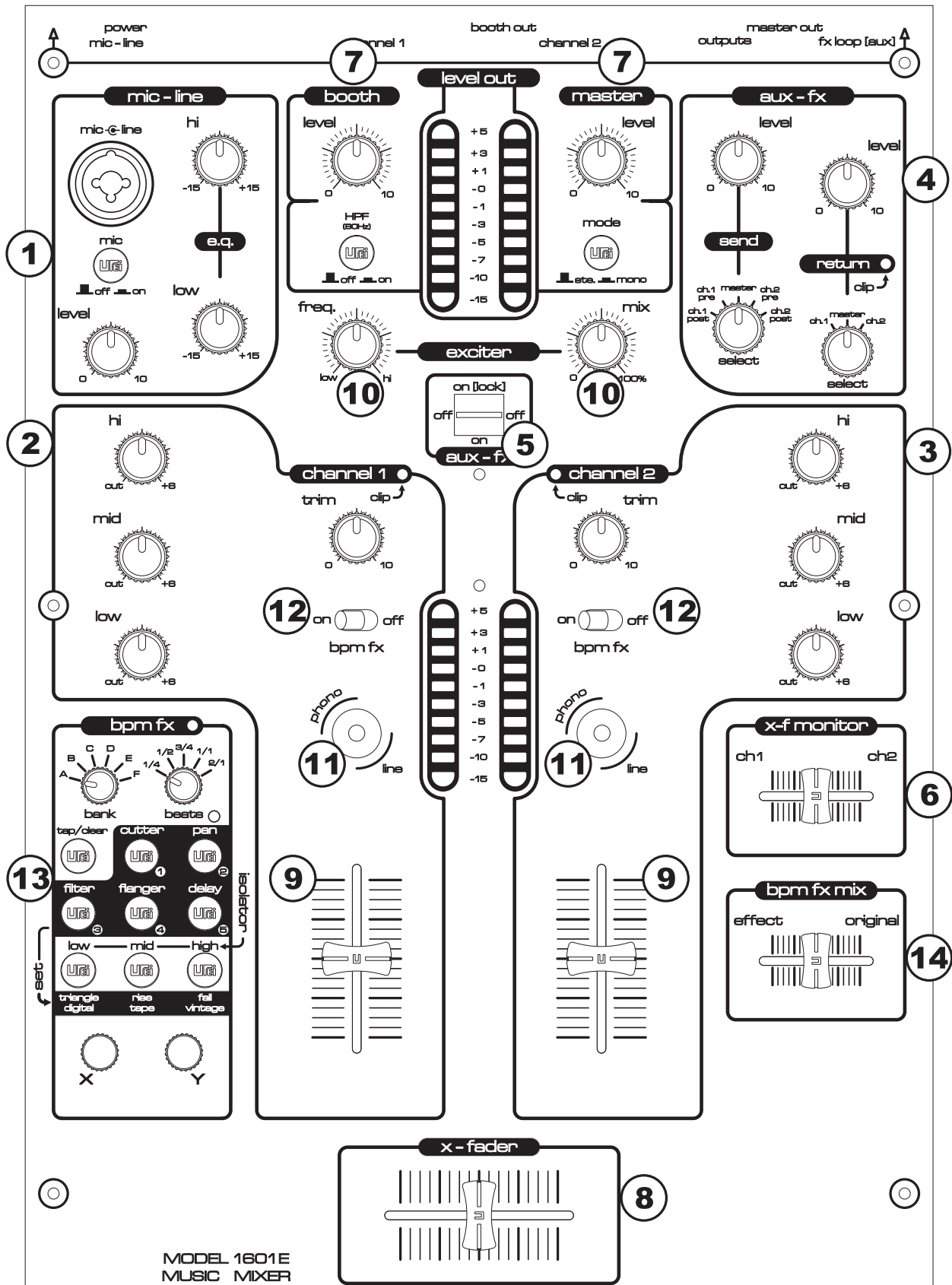



**1. MIC/LINE INPUT** (see page 20): This section features [LEVEL], [EQ-HI] and [EQ-LOW] controls for the microphone/line level input stage. The combi-XLR connector accepts XLR connectors for microphone use and 1/4" Jack plugs for mono line level devices (CD/tape players, drum machines, synthesizers etc.) The [MIC] push-button switch selects the alternative rear panel RCA phono socket inputs when it is released (up). This pair is mono summed and fed to the mix bus directly, bypassing the X-fader..

**2. CHANNEL 1 INPUT** (see page 22): This section features [TRIM], [PHONO/LINE select], [EQ-LOW], [EQ-MID], [EQ-HI] and [FADER] controls for the channel 1 input stage. There is also a 20dB pad and a 10dB pad, which can be set via holes under the top panel fascia; these are intended to be set at installation. The [CLIP] indicator shows the pre-A-to-D converter level status. The 10-way indicator shows channel level. This channel can be used with any CD/line or Phono level input device.

**3. CHANNEL 2 INPUT** (see page 22): This section is functionally identical to Channel 1.

**4. FX SEND/RETURN -AUXILIARY INPUT** (see page 24): This section features [SEND LEVEL], [SEND SELECT], [RETURN /AUX LEVEL] and [RETURN/AUX SELECT] controls for the effects loop/auxiliary input stage. The [CLIP] indicator shows the pre-A/D converter level status for the effects return/auxiliary input. The RETURN/AUX channel can be used with any CD/line level input device, as an additional stereo input.

**5. FX ON/OFF SWITCH** (see page 25): This 3-way "paddle" switch controls the effect send/return loop.

**6. X-FADER MONITOR** (see page 29): This control allows you to monitor channel 1, channel 2 or a mix of both.

**7. MASTER/BOOTH OUTPUT** (see page 26): This section features the [MASTER LEVEL] and [BOOTH LEVEL] controls. The 10-way VU indicator shows the MASTER output level.

**8. X-FADER** (see page 27): Note the adjustments on the front panel (see page 19).

**9. INPUT FADERS** (see page 22): Note the Ch1 and Ch2 adjustments on the front panel (see page 19).

**10. EXCITER** (see page 27): Frequency and Mix controls.

**11. PHONO/LINE INPUT SWITCH** (see page 22): 2-position switches select between each channel's phono and line switches.

**12. PBM FX ASSIGN** (see page 33): Assigns BPM FX to the input channel (post fader).

**13. BPM FX SECTION** (see page 30):

**14 BPM FX MIX FADER**

# REAR CONNECTOR PANEL

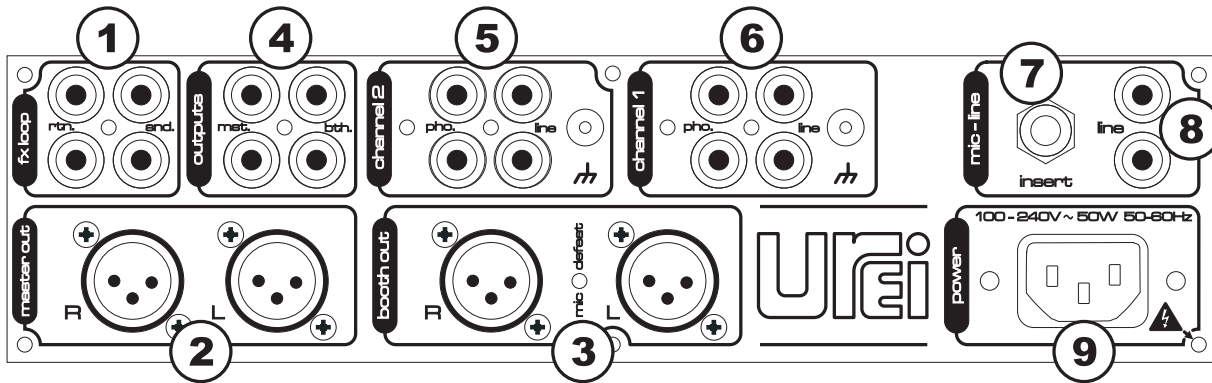

## 1. FX LOOP [AUX] -RCA Phono Connectors

Use these sockets to connect any external effects processor. Alternatively, you can use the [FX RETURN] sockets to connect an additional stereo CD/line level sound source to the mixer for multi-channel operation whilst using the [SEND] connectors as a RECORD out (see FX SEND/RETURN RE-CONFIGURATION). The FX RETURN and SEND connectors can be also used for DAISY-CHAINING of mixers .

## 2. BALANCED MASTER OUTPUTS -XLR Connectors

Use these sockets to connect the outputs to amplification systems supporting balanced inputs.

## 3. BALANCED BOOTH OUTPUTS -XLR Connectors

Use these sockets to connect the outputs to amplification systems supporting balanced inputs. The Booth output is fitted with a MIC DEFEAT push-on push-off switch fitted behind the rear connector panel; access is via a hole located between the XLR connectors. The MIC DEFEAT will prevent the mic signal from reaching the booth outputs.

## 4. OUTPUTS -RCA Phono Connectors

Use the sockets marked [MASTER] to connect to amplification systems supporting unbalanced inputs. Use the sockets marked [BOOTH] to connect to the monitor amplification system.

## 5. CHANNEL 2 -RCA Phono Connectors/Earth Terminal

Use the sockets marked [PHONO] and Ground Terminal to connect an analog turntable to channel 2. Use the sockets marked [LINE] to connect a CD or line level audio player to channel 2.

The PHONO input can be changed to line level via a push-on push-off switch fitted behind the rear connector panel. Access is via a hole next to the phono connectors: line = switch in, phono = switch out. Use a plastic or non-conductive pointer to push the switch.



Warning: Set the trim to 0 and put the input fader to its minimum setting before you change from line level to phono level on the rear connector panel.

## 6. CHANNEL 1 -RCA Phono Connectors/Earth Terminal

See Channel 2 above. Channel 1 and 2 are functionally identical.

## 7. MIC INSERT 1/4" Jack Connector

Use this socket to send/return the MIC/LINE channel signal to an external sound processor. Tip =send, ring = return (see page 48).

## 8. LINE INPUT RCA Phono Connectors

These inputs are enabled when the MIC switch on the front panel is released. This pair of inputs is mono summed. These can also be used as inputs if you want to daisy-chain mixers.

## 9. AC POWER IN IEC Connector

IMPORTANT: this unit requires a supply of 100 - 240V 50-60Hz AC.

## FRONT PANEL

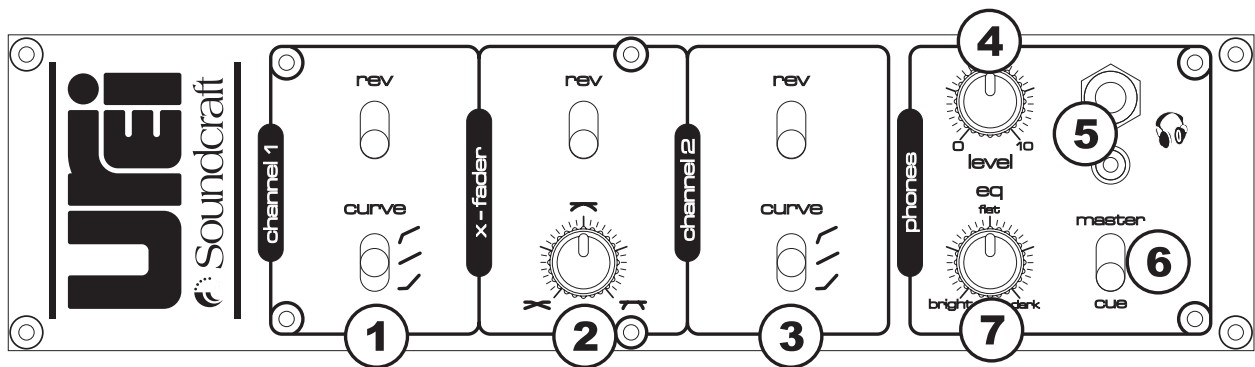

### 1. CH1: 3 Position curve control and Reverse

These controls allow you to change the curve of the input fader and reverse the fader action. See also page 23.

### 2. X-FADER: Rotary position curve control and Reverse

These controls allow you to change the curve of the x-fader and reverse the fader action. See also page 27.

### 3. CH2: 3 Position curve control and Reverse

These controls allow you to change the curve of the input fader and reverse the fader action. See also page 23.

### 4. LEVEL -Rotary control

This control sets the audio level to the connected headphones. See also page 28.

### 5. HEADPHONE OUT -Jack connectors

Connect the 1/4" or mini jack plug from your headphones to the appropriate connector.

### 6. SELECT Toggle switch

This switch allows you to select MASTER or CUE monitoring. See also page 28.

### 7. EQ CUT -Rotary

This control can be used to change the CUE monitor EQ. To the right, high frequencies are cut and to the left, low frequencies are cut. See also page 28.

# OPERATION

## GETTING STARTED

Before use, please observe the following guidelines:

**CONNECTIONS:** Before making any connections, make sure that the power on all your equipment is turned OFF. Connect the audio cables for a typical system setup as shown on page 13. Connect the power cord to the mains power socket on the rear panel of the mixer and plug it into a suitable AC outlet.

**TURNING ON THE POWER:** Make sure all connections have been made correctly and the volume controls on the 1601S/1601 mixer and the amplifier system are turned completely down. Turn ON the power at the wall. Turn ON the power to the connected CD/ analog players and amplifier system.

**POWER ON INDICATION:** When the 1601S/1601 mixer is powered up the front panel input meter LEDs will light in sequence. If this does not happen, check the mains supply is correct, correctly connected, and powered on.

Your Urei mixer is now ready for use.

## MIC / LINE INPUT

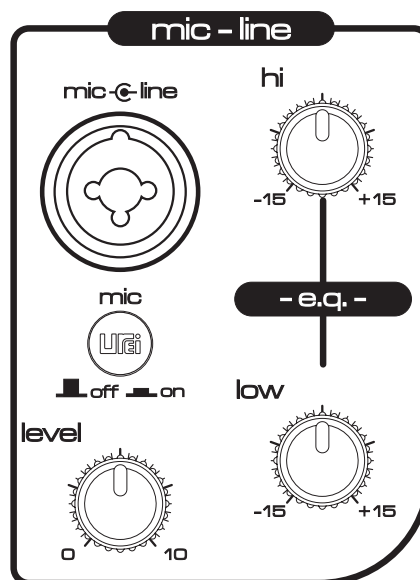

This section of 1601S/1601 mixer features controls and connectors for the DJ microphone. The circuitry is totally analog and is fed directly to the master output bus (also analog). The associated RCA phono plugs on the rear conn. panel allow you to use this input as a 3rd line-level input, ideal for introducing a further CD/tape player or other sound source such as MIDI synthesizer/sequencer.

## COMBI -XLR CONNECTOR

This connector accepts the standard XLR plug fitted to BALANCED microphone cables. Before attempting to connect the microphone, first ensure the [LEVEL] control is set to minimum and the [MIC] switch is set to the MIC position (down). Align the three pins on the plug with those on the socket and then push home fully until the retaining latch clicks into place. To disconnect the microphone, first press down the retaining tab labelled [PUSH] and then gently pull out the XLR microphone plug.

The centre area of this connector also accepts a standard 1/4" jack plug for connecting line-level devices. Only mono signals can be routed through this section. Before attempting to connect the line-level device, first ensure the [LEVEL] control is set to minimum. If you want to route a stereo pair signal use the RCA phono plugs on the rear conn. panel instead, and ensure the [MIC] switch is set to the LINE position (up). Note that the stereo signal is mono summed inside the mixer.



**Important Note:** when the [MIC] switch is in the MIC position (down) the signal from the combi-xlr will not be routed to the Booth Outputs if the [MIC DEFEAT] switch on the rearconn is pressed in. The [MIC DEFEAT] switch is accessed via a hole located between the booth XLRs on the rearconn.

## LEVEL CONTROL

This control sets the input level for the microphone or line-level device. At the fully anti-clockwise position there will be no sound. As the control is moved in a clockwise direction the level will be gradually increased until, at the fully clockwise position, the level will be at its maximum.



**CARE!** This signal is routed to the master outputs POST [MASTER] level control -e.g. the output level of the microphone or line-level device will be un-affected by the [MASTER] level control. It is similarly routed to the booth outputs (unless the mic defeat feature described above is engaged).

## EQ -LOW CONTROL

This control adjusts the bass equalisation of the microphone/line-level sound. At the 12 o'clock, centre position the low EQ will be flat (no cut or boost). As the control is moved anti-clockwise the low frequencies will be progressively cut until, at the fully anti-clockwise position the maximum low frequency cut will be applied (-15dB). As the control is moved clockwise from the centre position the low frequencies will be progressively boosted until, at the fully clockwise position the maximum low frequency boost will be applied (+15dB@100Hz).

## EQ -HIGH CONTROL

This control adjusts the treble equalisation of the microphone or line-level sound. At the 12 o'clock, centre position the high EQ will be flat (no cut or boost). As the control is moved anti-clockwise the high frequencies will be progressively cut until, at the fully anti-clockwise position the maximum high frequency cut will be applied (-15dB). As the control is moved clockwise from the centre position the high frequencies will be progressively boosted until, at the fully clockwise position the maximum high frequency boost will be applied (+15dB@10kHz).

## MIC INSERT SOCKET (rearcon)

This 1/4" jack on the rearcon can be used to route the post-EQ signal through an external effects or dynamic processor. See the mic/line insert lead on page 48 for connection details.

## CHANNELS 1 & 2 (Channel 1 Shown)

This section of the mixer features all the main controls for input channels 1 & 2, most of which come under the control of the digital signal processor (DSP). The EQ section in both channels are created within the DSP which enables the mixer to deliver an amazing -85dB of cut whilst, for professional considerations, limiting the boost to just +6dB. The level faders are also digitally controlled which assures extra-long life for these hard-working components.

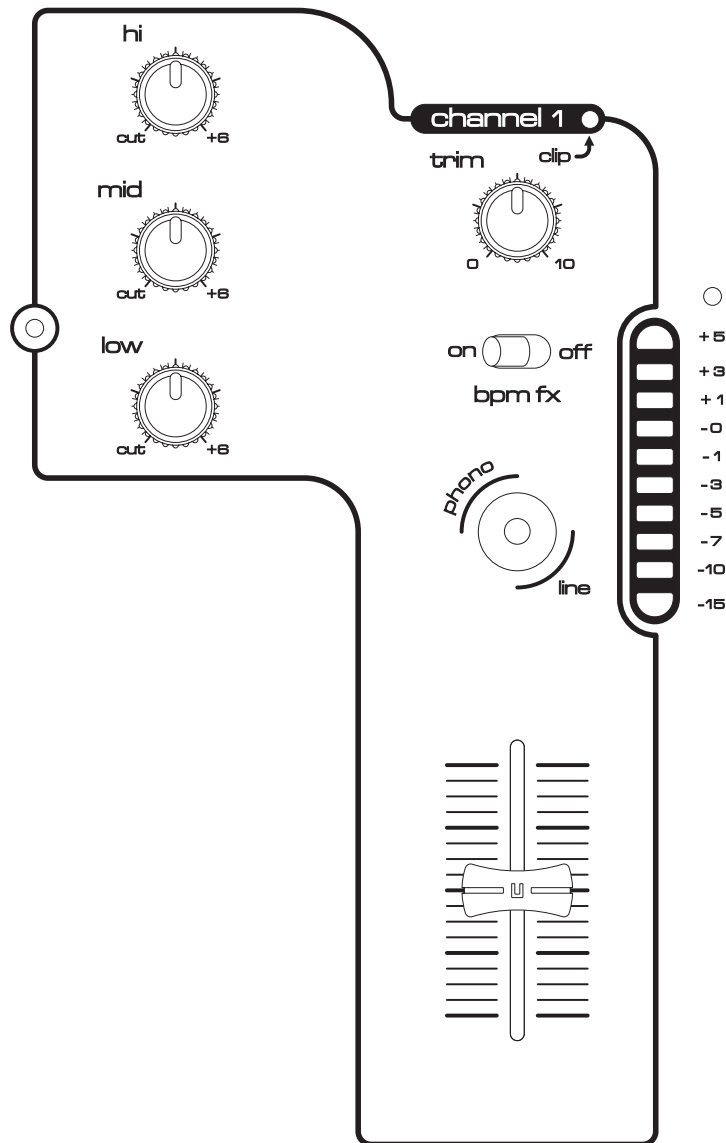

### INPUT SELECTOR SWITCHES

These 2-way selector switches select the connected playback device for each channel. They allow you to select between the CD/ LINE inputs and the PHONO inputs.

### CLIP INDICATORS

The [CLIP] indicators are used to detect overload conditions in the gain section before the A/D converters. When the signal level becomes too high for the A/D convertor the indicator will illuminate and the audio sound will become distorted.

**TIP** If this occurs, back-off the [TRIM] control until the [CLIP] indicator is not illuminated.

### PRE-TRIM PADS

These attenuator controls are situated under the top panel fascia (channel 1 on the left side / channel 2 on the right side). They can be used to attenuate the input signal level prior to the main [TRIM] control to avoid overload conditions. These controls are factory set to maximum gain for professional use.

When using high output playback devices it may be necessary to select the -10dB pad or the -20dB pad (or both) to stop the input channel from overloading.

The locations of these pads are shown on page 15.

## TRIM

The trim controls allow a +/-15dB trim range to be applied to each channel's signal.

**TIP** The optimum setting is at zero on the input LED level meter.

## HI EQ

These controls adjust the high tone characteristics of the CH1 / CH2 inputs. At the 12 o'clock, centre position the high EQ will be flat (no cut or boost). As the control is moved anti-clockwise the high frequencies will be progressively cut until, at the fully anti-clockwise position the maximum high frequency cut will be applied (-85dB). As the control is moved clockwise from the centre position the high frequencies will be progressively boosted until, at the fully clockwise position, the maximum high frequency boost will be applied (+6dB@10kHz).

## MID EQ

These controls adjust the mid tone characteristics of the CH1 / CH2 inputs. At the 12 o'clock, centre position the mid EQ will be flat (no cut or boost). As the control is moved anti-clockwise the mid frequencies will be progressively cut until, at the fully anti-clockwise position the maximum mid frequency cut will be applied (-85dB). As the control is moved clockwise from the centre position the mid frequencies will be progressively boosted until, at the fully clockwise position, the maximum mid frequency boost will be applied (+6dB@1kHz).

## LOW EQ

These controls adjust the low tone characteristics of the CH1 / CH2 inputs. At the 12 o'clock, centre position the low EQ will be flat (no cut or boost). As the control is moved anti-clockwise the low frequencies will be progressively cut until, at the fully anti-clockwise position the maximum low frequency cut will be applied (-85dB). As the control is moved clockwise from the centre position the low frequencies will be progressively boosted until, at the fully clockwise position, the maximum low frequency boost will be applied (+6dB@100Hz).

## CHANNEL VOLUME FADERS

These 60mm travel faders are digitally controlled by the DSP and are used to adjust the volume of CH1 and CH2.

## PEAK LEVEL METER

These indicators show the signal level pre-channel faders and cover a range of -15 to +5. The indicators from -15 to -3 are coloured blue. Indicators -1 to +3 are white, whilst the +5 indicator is coloured red.

## CHANNEL FADER CURVE CONTROL

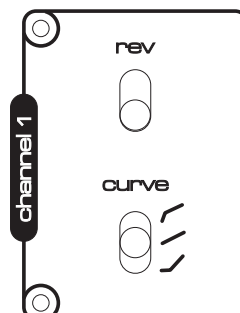

The channel fader curve control is located on the front panel. The 3 switched fader characteristics are created and controlled by the DSP. The fader action may also be reversed via the [REV] switch.

## FX SEND & RETURN / AUX

This section features controls for the effects send/return loop, which can also be used as an auxiliary input/record output. The routing switches are controlled by the DSP for comprehensive send and return patching. For example, you can take the CH1 input signal (before or after the cross-faders) and route it through an external effects device before bringing it back via CH1, CH2 or Master bus. If effects are not required you can connect a line-level playback device to the return side for expanded input channel capability whilst recording a performance from the send output.

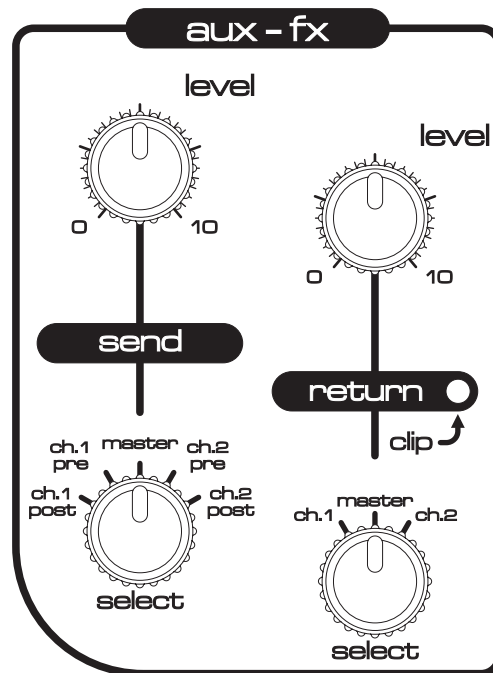

### SEND -LEVEL

This control sets the output level to the connected effects unit. At the fully anti-clockwise position there will be no output signal. As the control is moved in a clockwise direction the output level will be gradually increased until, at the fully clockwise position, the output level will be at its maximum. Use the input level indicator on your effects unit to monitor and set the correct input level.

### RECORD OUT

If effects are not required, the SEND output can be used as a RECORD output. Simply connect your audio tape/CD recorder's input to the rear panel [SEND] sockets and adjust the output [LEVEL] / source [SELECT] accordingly.

### SEND -SELECT

This control selects the signal source that will be sent to the external effects unit. There are five "tap-off" points to choose from, as detailed below:

1. CHANNEL 1 POST -Only the CH1 signal will be transmitted, post-cross-fader (AFTER the cross-fader).
2. CHANNEL 1 PRE -Only the CH1 signal will be transmitted, pre-cross-fader (BEFORE the cross-fader).
3. MASTER -The master output signal will be transmitted (only MASTER RETURN can be selected for this setting).
4. CHANNEL 2 PRE -Only the CH2 signal will be transmitted, pre-cross-fader (BEFORE the cross-fader).
5. CHANNEL 2 POST -Only the CH2 signal will be transmitted, post-cross-fader (AFTER the cross-fader).



## RETURN / AUX -LEVEL

This control sets the amount of signal coming back from the connected effects unit. At the fully anti-clockwise position there will be no sound. As the control is moved in a clockwise direction the input level will be gradually increased until, at the fully clockwise position, the input level will be at its maximum.

## CLIP INDICATOR

The [CLIP] indicator is used to detect overload conditions in the gain section before the A/D convertor. When a good signal level is detected, the indicator will not light. When the level becomes too high for the A/D convertor, the indicator will illuminate and the audio sound will become distorted. If this occurs, back-off the [LEVEL] control until the [CLIP] indicator is not illuminated.

## RETURN -SELECT

This control selects the point at which the returning effects are re-introduced. There are three “patch” points to choose from, as detailed below:

1. CHANNEL 1 -The return signal will be routed directly to the CH1 bus (pre-channel volume fader).
2. MASTER -The return signal will be routed directly to the Master bus (pre-master volume fader).
3. CHANNEL 2 -The return signal will be routed directly to the CH2 bus (pre-channel volume fader).



NOTE: When SEND [SELECT] is set to [MASTER], all three return settings will automatically be set to MASTER to prevent feedback loops occurring.

NOTE: the [FX] switch must be turned ON to input the signal.

## FX ON/OFF SWITCH

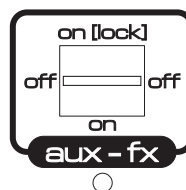

The performance “paddle” type FX switch controls the ON/OFF status of the external effects. You can use the spring-loaded momentary ON position to flick-in effects “on-the-fly” or use the locked-ON position for more sustained periods of externally processed sound.

When the [FX] switch is in the centre “OFF” position there will be no return from the connected effects device.

When the [FX] switch is in the forward LOCK-ON position, the sound, as set by the RETURN [SELECT] control, will be returned from the connected effects device. The indicator stays on in this mode to show that FX return is activated. When the [FX] switch is pulled and held back to the “ON” position the sound, as set by the RETURN [SELECT] control, will be returned from the connected effects device. The indicator stays on in this mode to show that the FX return is activated. When the switch is released, it will automatically return to the centre “OFF” position.

## FX SEND/RETURN RE-CONFIGURATION



If you want to use the return as a 4th line level input, the configuration must be changed each time power is switched on. With power turned OFF, pull and hold back the [FX] paddle switch (momentary ON position). Turn the power ON at the mains plug and then after a few seconds release the [FX] paddle switch. The return input is now constantly active whilst the [FX] paddle switch controls the send signal.

NOTE: This special configuration setting is lost when power is turned off. If you want to use the return as a 4th line level input, always remember to hold the [FX] switch to ON before turning on the power.

## MASTER / BOOTH OUTPUT

This section of the mixer features controls and indications for the master and booth outputs.

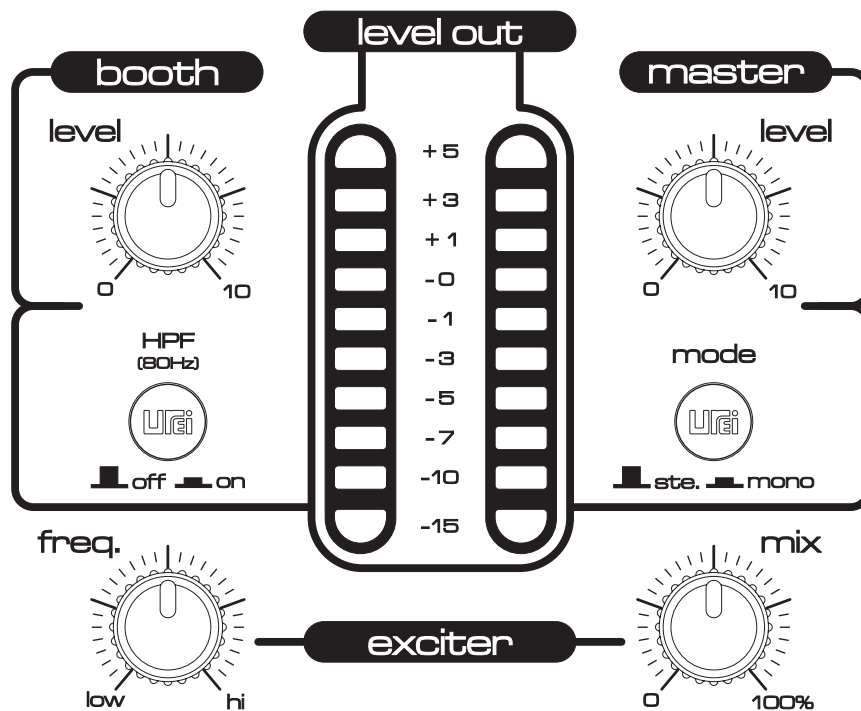

### MASTER LEVEL

This control adjusts the level of the master output volume on both the balanced and unbalanced outputs. At the fully anti-clockwise position there will be no sound. As the control is moved in a clockwise direction the output level will be gradually increased until, at the fully clockwise position, the output level will be at its maximum.

### OUTPUT PROTECTION LIMITER

The output protection limiter protects the main outputs from clipping. As the signal level approaches the clip point of the DACs, the limiter reduces the output gain, until the audio level decreases back to below the limiter threshold, at which point the gain returns to normal. If the red LEDs are active, then the limiter will be working to maintain the signal quality. It is good practice never to clip the mixer.

### LEVEL OUT METER

These indicators show the left and right master output volume from -15 to +5. The indicators from -15 to -3 are coloured blue, the indicators from -1 to +3 are coloured white, and the peak indicators +5 are coloured red to identify output overload conditions.

### BOOTH LEVEL

This control adjusts the level of the booth output volume on both the balanced and unbalanced outputs. At the fully anti-clockwise position there will be no sound. As the control is moved in a clockwise direction the output level will be gradually increased until, at the fully clockwise position, the output level will be at its maximum. There is no level indicator for the booth output.

### MONO/STEREO SWITCH

This switch is to sum the Stereo signal to a Mono signal. It acts on the master outputs and booth outputs.

### HPF 80Hz SWITCH

Apply this switch when you are suffering from Bass Rumble from the deck/phono input.

## THE EXCITER

At the fully anti-clockwise position of the [MIX] control 0%, no EXCITER will be applied to the main mix. As the control is rotated clockwise the EXCITER is gradually added to the mix. At the fully clockwise position of the [MIX] control 100%, the amount of the EXCITER added to the mix will be 100%.

At the fully anti-clockwise position of the [FREQ] control (LOW 40Hz), only Low frequencies will be excited and added to the mix. As the control is rotated clockwise the frequencies to be excited will change from low to high (bass to treble).

At the fully clockwise position of the [FREQ] control (HIGH 20KHz), high frequencies will be excited and added to the mix.

**TIP** By manipulating both the [FREQ] and [MIX] controls simultaneously you can create a “filtering/phasing” effect.



You may have to reduce the trim when using the exciter: the resonance of the selected frequencies may boost the output signal levels high enough to overload the system. The red LEDs on the meter will show that the levels are going too high.

## X-FADER

The inputs to the cross-fader are provided by the outputs of the channel 1 and 2 output faders. The X-fader then outputs a mix of these two signals which is dependent on the position of the X-fader and the setting of the X-fader curve control.

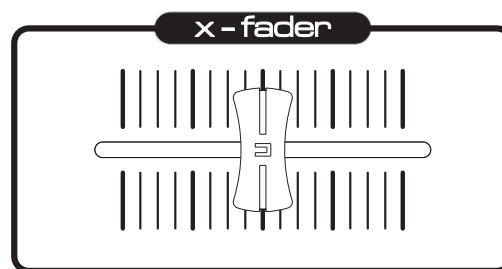

## X-FADER CURVE

The x-fader curve control is located on the front panel. The continuously variable cross-fade characteristics are created and controlled by the DSP, which ensures the precision of the cross-fader.

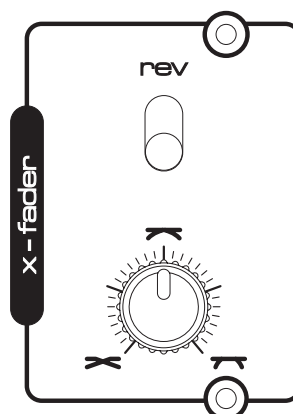

At the fully anti-clockwise position the channel level will start to reduce at a linear rate near the cross-fader's centre position. As the curve control is moved in a clockwise direction the channel level will start to reduce more rapidly nearer the opposite channel end-stop until, at the fully clockwise position, the channel level will start to reduce dramatically just before the opposite channel end-stop.

**TIP** Fully clockwise - scratch/cut mode.

Centre - smooth fade mix mode.

The X-fader action may also be reversed via the [REV] switch.

# HEADPHONE MONITOR

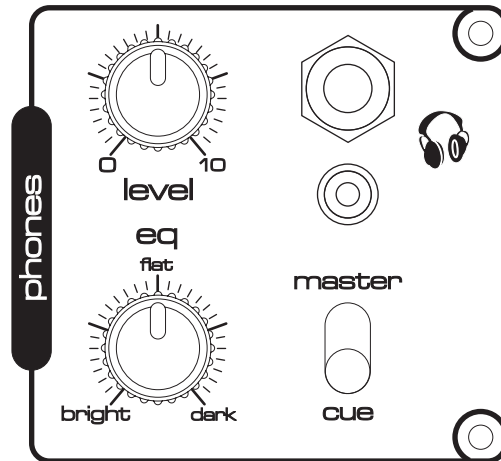

This section of the mixer features all the headphone monitoring controls which, again, come under the control of the DSP. This allows the inclusion of a special cue EQ control which filters-out unwanted frequencies, letting you tune-in to defined elements within the sound and create a perfect mix.

## LEVEL

This control adjusts the output level to the connected headphones. At the fully anti-clockwise position there will be no sound. As the control is moved in a clockwise direction the output level will be gradually increased until, at the fully clockwise position, the output level will be at its maximum.

## MASTER/CUE SELECT

This switch selects the monitor signal source. When the switch is at [MASTER], the monitor output sound will be derived from the master output bus. When the switch is at [CUE], the monitored sound will be derived from the [XF MONITOR].

Note: when this switch is set to [MASTER], the headphones will be post-eq; when it is set to [CUE], the headphones will be post-eq.

## EQ

This control adjusts the tone of the monitored sound, cutting the highs or lows about the centre off position. At the 12 o'clock centre position the EQ will be flat (no cut). As the control is moved clockwise the HIGHER frequencies will be progressively cut until, at the fully clockwise position the maximum high frequency cut will be applied (-85dB). As the control is moved anti-clockwise from the centre position the LOWER frequencies will be progressively cut until, at the fully anti-clockwise position the maximum low frequency cut will be applied (-85dB). NOTE: fully clockwise=dark, fully anti-clockwise=bright.

## HEADPHONE SOCKETS

Outputs are provided on 1/4" and 3.5mm jacks. This is to maximise compatibility with headphones, not to allow two sets of headphones to be used. If two sets of headphones are used the volume of signal in the headphones will be reduced.

## X-F MONITOR

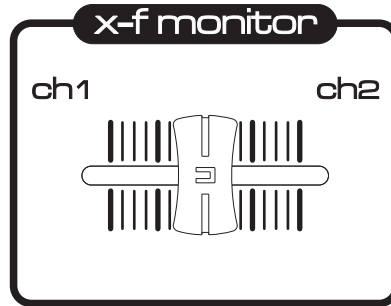

When the [MASTER/CUE SELECT] is set to CUE the [X-F MONITOR] control adjusts the relative mix balance between CH1 and CH2. When fully over to the LEFT position only CH1 sound will be audible. As the control is moved to the RIGHT CH2 sound will be gradually introduced until, at half-way, CH1 and CH2 sound will be equal. As the control is moved to the RIGHT from the centre position the CH1 sound will gradually reduce until at full RIGHT only CH2 sound will be audible.

When the [MASTER/CUE SELECT] is set to MASTER the [X-F MONITOR] control has no function. The signal from main mix will be routed to the headphones.

# THE BPM FX MODULE

## OPERATING CRITERIA

This product has been designed to operate most effectively with dance music, i.e. music based on strong regular beats and patterns. However, as the range of pre-recorded dance material is virtually limitless (and the audio mix of individual tracks unknown) we cannot guarantee the performance of 1601E with every style of dance music.

1601E's synchronisation performance may be affected if the beat information is either unavailable or indefinable within the audio track. Please consider this when selecting your audio material.

## TOP PANEL CONTROLS

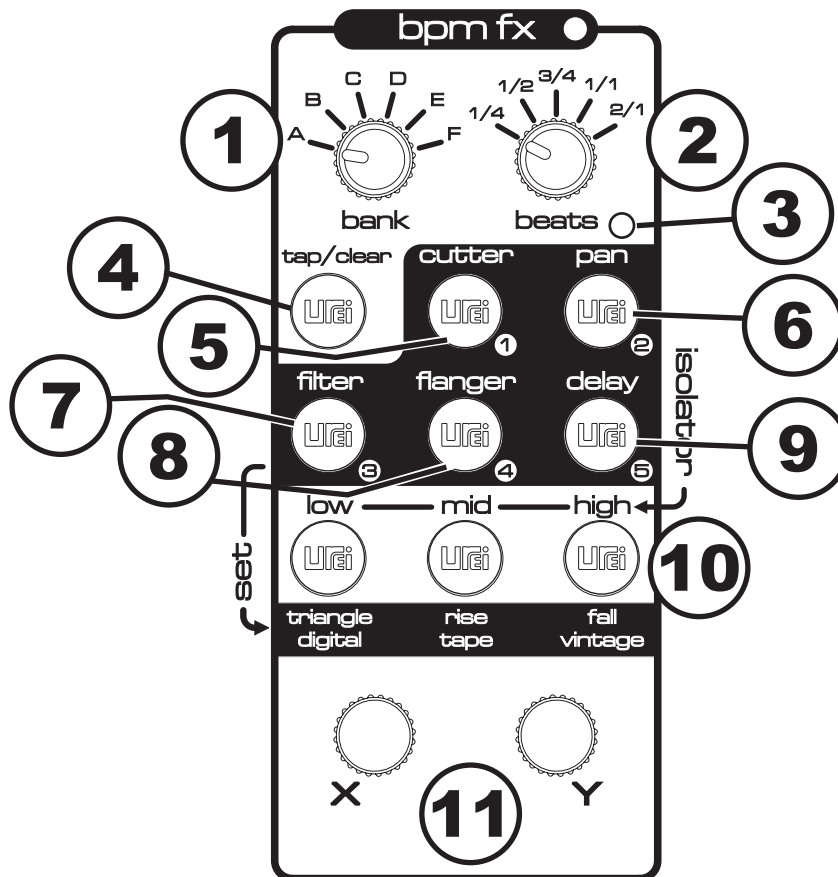

### 1) BANK: (MODE)

This rotary switch selects the operating modes. In [A] mode only one effect at a time can be activated. In [B]-[F] modes the factory presets, which feature a wide spectrum of multiple effect combinations, can be accessed.

### 2) BEATS: (FX SPEED) 1/4 1/2 3/4 1/1 2/1

This rotary switch sets the effect speed. There are additional speed settings for FILTER/FLANGER/PANNER: 1 bar, 2 bar, 4 bar, 8 bar & 16 bar.

### 3) BEATS INDICATOR

The [BEATS] indicator lights when the BPM engine is locked on to the beat.

## 4) TAP/CLEAR

[TAP/CLEAR] button is used to manually 'tap in' a tempo. This function also acts as the BPM range selector.

## 5) CUTTER (1)

This button selects the GATE effect. The [X] encoder controls the [DEPTH](MARK:SPACE RATIO) of the waveform.

The [Y] encoder controls the cutter [SLOPE] parameters.

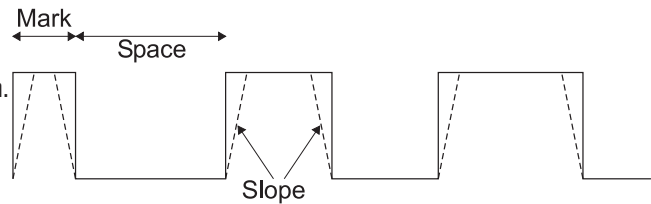

## 6) PAN (2)

This button selects the PANNING effect.

The [X] encoder function controls the [SPS] depth.

The [Y] encoder control the panning [2-WAY SPLIT] parameters.

## 7) FILTER (3)

This button selects the FILTER effect.

The [X] encoder controls the filter [FREQUENCY]

The [Y] encoder controls the filter [RESONANCE] parameters in multi-mode [B~F] only.

The [Y] encoder controls the filter [LFO DEPTH] in single mode [A/3] only.

Press and hold this button to set the filter LFO [SHAPE]. See page 41 (sub menu).

## 8) FLANGER (4)

This button selects the FLANGE effect.

The [X] encoder controls the [FREQUENCY].

The [Y] encoder controls the flange [DEPTH] parameter.

Press and hold this button to set the flange LFO [SHAPE]. See page 45 (sub menu).

## 9) DELAY (5)

This button selects the DELAY or 'echo' effect.

The [X] encoder controls the analog tape modeler [SPEED] parameter.

The [Y] encoder controls the [REPEAT] depth.

Press and hold this button to set the [REPRO], reproduction quality of the repeats. See page 42 (sub menu).

## 10) ISOLATOR

The 3-band isolator allows you to choose which band of frequencies is passed through the effects.

This function also operates as the "BPM Range Selector" & the "Pattern Select" of the Filter, Flange & Cutter.

In single mode [A/3] the isolator is used to select low pass/band pass/high pass filter mode.

## 11) X-Y CONTROLS

These two rotary encoders adjust the two fixed parameters for each selected effect in [SINGLE] mode or any two factory assigned parameters in [MULTI] mode.

**The encoders are geared, so the faster you turn the encoder the faster the response, the slower you turn the encoder the slower the response.**

## BPM FX MIX

This fader adjusts the balance between the un-processed sound (original) and processed sound (effect).

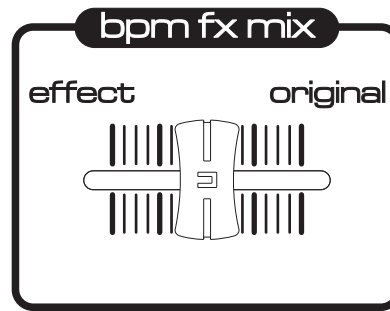

## ON-OFF switches

These two switches apply the bpm-fx to either of the input channels or the master output. There is a switch in each of the input channels' areas.





## QUICK START

If you want to quickly try out the performance of 1601E Effects, please read the following points carefully:

### CONNECTIONS

Make sure all connections have been made correctly and the volume controls on mixer and amplifier system are all turned completely down.

Connect the IEC power cord to the rear panel of the mixer and plug it into a suitable AC outlet.

Turn on the power to the mixing desk and then turn on the power of the amplifier system.

### SETTING UP

Select a suitable audio track (dance orientated music with defined beat information), start the playback on the connected sound source.

Adjust the channel trim so that the input signal is peaking at or above zero (0) on the input meters.

Select where you want to apply the EFFECTS, channel 1, channel 2 or master. The [BEAT] indicator should be "on" indicating the BPM is locked.

### ACTIVATING THE EFFECTS

Select [A](single mode) on [BANK] . Press the [FILTER] button.

Move the [MIX] fader to the mid position to hear the filter effect. Try adjusting the X and Y encoders to change the sound.

To change the [BEATS] FX Speed setting, simply switch from [1/4] ~ [2/1]. The timing of the effect triggering will change instantly to the new setting. Try the whole range of preset timings to hear the way they change the feel or 'groove' of the music.

To select [MULTI] mode, rotate the [BANK] switch through [B] to [F]. In multi programs the active effects are indicated by the indicators in the main effect select buttons when you hold down the multi-effect bank buttons 1-5.

Please read the following "OPERATION" section fully to appreciate the range of features and facilities 1601E has to offer.

# OPERATION

This section features the BPM and its associated controls. You can set the BPM range, manually override the BPM engine with these controls and reset the synchronization.

## BPM RANGE

This is where you set the working range of the BPM engine. There are three operating bands specifically designed to complement styles of music from slow ballads to the fastest House.

The range setting can only be accessed when the BPM engine is in the 'Idle' condition (BEATS LED blinking). To check the current range setting, whilst in idle mode, press and hold down the [Tap/Clear] button, one of the ISOLATOR switches will illuminate, indicating Low, Med or High range.

The ranges are: LOW (60 to 120BPM), MID (default, 90 to 180BPM), HIGH (115 to 230BPM)

To adjust the BPM range, press and hold the [Tap/Clear] button: while holding the [Tap/Clear] button select the BPM range by pressing & holding the Low, Mid or High switches.

NOTE 1: BPM's outside of the selected range limit cannot be analysed. Always check the general tempo of the music you are playing falls well within the selected BPM range. For most applications we recommend the MID BPM range of 90-180BPM.

NOTE 2: This setting is not memorised. Each time 1601E power is turned on; the default setting of 90-180 BPM will be restored.

The [BEAT] indicator will now flash at the detected BPM rate and stay on after 5 seconds once the BPM engine has locked onto the Beat.

Any major shift in tempo (changing the audio playback speed using a CD/vinyl deck's pitch control) will be tracked by the 1601E BPM engine.



**IMPORTANT NOTE:** The BPM engine will continue triggering the effects indefinitely at the last detected BPM rate if the strong regular beats in the audio track become unavailable. This feature allows the effects to continue operating through quite passages in the audio track.

If the strong regular beats in the audio track become unavailable, the [BEAT] indicator will blink. This will occur approximately 5 seconds after the last valid BPM reading was detected to warn you that 1601E is now 'free-wheeling' and the BPM display is no longer being updated from the audio track. When the strong regular beats in the audio track return, the BPM engine will automatically detect the beat and make any necessary adjustments, at which time the flashing [BEAT] indicator will stay on once again to indicate a 'locked-in' condition.

## TAP/CLEAR BUTTON

This multi-function button allows you to manually enter a tempo by hand or erase the current BPM reading. It can also be used when there is no audio signal present or when the beat information becomes unavailable during a quiet passage of an audio track (intro, middle eight etc). The CLEAR feature can be used to cancel the current BPM reading.

### TAP -Tempo Edit

To enter a BPM rate from an 'IDLE' condition (no audio beat detected) use your finger to tap in a tempo on the TAP button (within the current BPM range).

The TAP feature can be used to override the BPM engine if it is in 'free-wheeling' mode only. Use a finger to tap in the new tempo. After 3-4 taps the BPM engine will update the tempo. The TAP function can also be used to assist the BPM engine as it analyses more complex rhythm tracks. Tapping along with the tempo of the track can help the software recognise patterns within the music and so lock-in and adjust the BPM and/or synchronisation itself.

**NOTE:** Subsequent valid beat information detected by the BPM engine may override manual changes made with the TAP function.

## CLEAR BPM

To clear a BPM reading and reset 1601E to 'IDLE' mode, press and hold down this button until the indicator flashes.

**Note:** The BPM engine will freewheel (continue at the last detected BPM) until a new tempo is detected.

## EFFECT START SYNC

The effect sync (LFO waveform) will re-trigger every time any of the following occurs:

- the BPM FX Mix fader is moved away from the [original] position,
- either of the BPM FX switches is moved to its [on] position,
- or
- the selected effect button (1-5) is pressed.

## Applying the BPM-FX

If the **BPM-FX switch** on **either** of the input channels is set to the **ON** position, the effects will be applied to that **input channel**.

If **both switches** are set to **ON**, the bpm-fx effects will be applied to the **master output**.

## EFFECT CONTROLS

This section deals with the controls dedicated to adjusting and controlling the effect parameters. Elements of each effect can be altered in real-time using the X and Y Controls whilst the 3-band filter section lets you choose which part of the sound is affected.

Each time this button is set to ON the active effect will commence its cycle from the start point. As an example, if the FILTER effect is selected with a [FALLING] type LFO shape and the trigger duration set to 4 bars, the following will occur when the [FILTER] button is pressed on or slightly before the first beat of the bar:

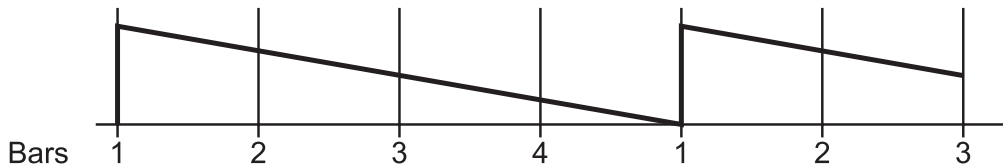

## MIX FADER

This 25mm fader controls the balance between the un-processed and processed signal. At the end-stop marked [ORIGINAL] the effects will be completely bypassed and only the original sound will be heard. As the fader is moved away from this position the processed signal will be gradually introduced until, at the end-stop marked [EFFECT], the maximum processed sound will be heard.

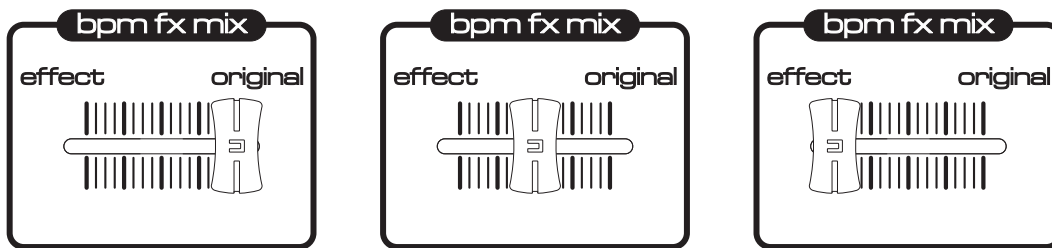

## X-Rotary Encoder

As the pot is moved clockwise from the central "parked" position the X parameter is gradually increased in a positive manner until it reaches its maximum. As the pot is moved anti-clockwise the X parameter is gradually increased in a negative manner until it reaches its maximum.

## Y-Rotary Encoder

As the pot is moved clockwise from the central "parked" position the Y parameter is gradually increased in a positive manner until it reaches its maximum. As the pot is moved anti-clockwise the Y parameter is gradually increased in a negative manner until it reaches its maximum.

**The encoders are geared, so the faster you turn the encoder the faster the response, the slower you turn the encoder the slower the response.**

**Under normal operation, one full rotation in either direction is a full sweep of the encoders.**

### 3-BAND ISOLATOR

The 3-band isolator section allows you to apply the effects to certain frequency bands or the complete audio signal. As an example, effects applied to just the HIGH frequencies will sound very subtle whilst passing the sound through all three bands simultaneously will offer more extreme results.

The three top panel switches control the ON/OFF status of the LOW, MID and HIGH frequency bands respectively.

To select/de-select the frequency bands simply press the relevant momentary switch once. The indicators show when the frequency band is active [ON] or bypassed [OFF], as shown in the following examples:

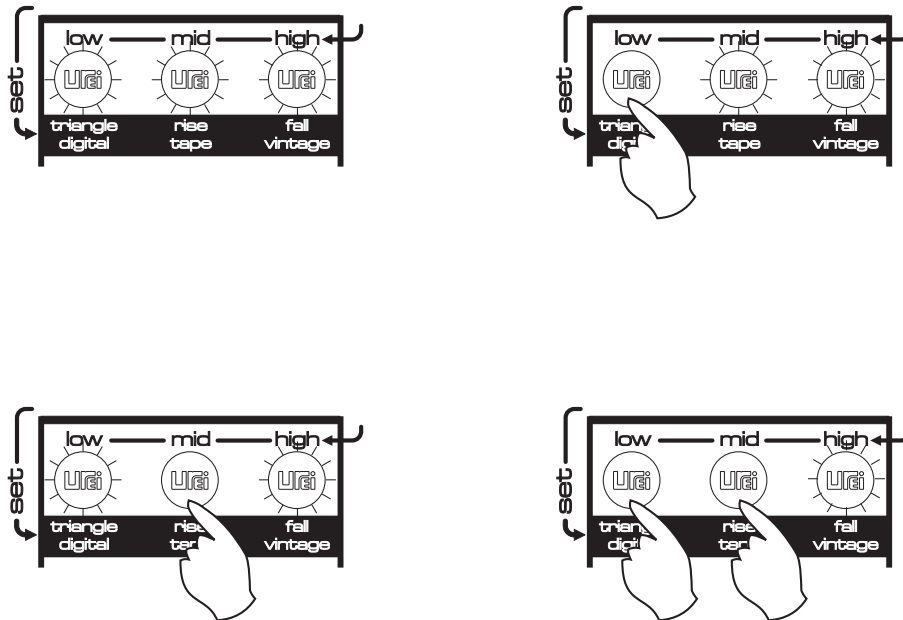

**NOTE 1:** To avoid total effect bypass, the last remaining frequency band cannot be turned off. As an example, if the LOW and MID bands are switched off leaving the HIGH band on, pressing the [HIGH] button will have no affect. To re-enable the HIGH band, first switch ON another band and then de-select the HIGH band.

**NOTE 2:** The ISOLATOR function is memorised whilst switching between effects.

### Applying the BPM-FX

If the **BPM-FX switch** on either of the input channels is set to the **ON** position, the effects will be applied to that **input channel**.

If **both switches** are set to **ON**, the bpm-fx effects will be applied to the **master output**.

## SINGLE/MULTI MODE OPERATION

This is where you choose the basic operating mode for 1601E. In [A] mode only one of the five effects can be applied at a time. The [BEATS] rotary switch can be used to set the trigger rate for each effect. In [MULTI] mode, combinations of the five effects can be applied simultaneously from a selection of factory presets.

### Mode [BANK] select:

The rotary select switch selects single and multi modes.

To select single mode, turn the switch to [A].

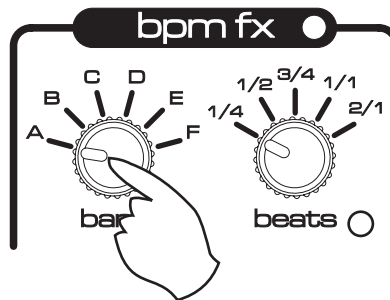

To select multi mode, turn the switch to [B] [C] [D] [E] or [F] position.

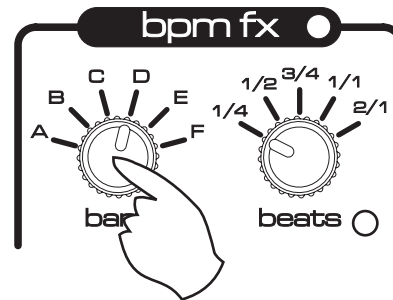

Having dealt with single/multi mode selection, here are the specific functions for each mode.

### SINGLE MODE

The five main effects buttons are used to select the active effect. Only one effect at a time can be activated in single mode. After power-up the default effect (FILTER) will be automatically activated. To select a new effect, press any of the other effect buttons once, as shown in the following example:

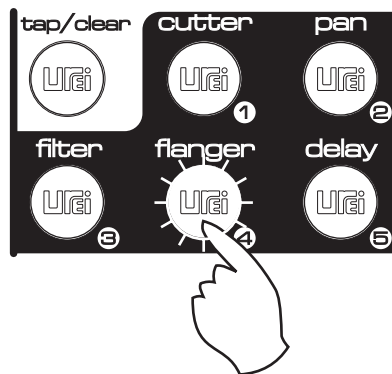

There are five defined FX SPEEDS (BEATS) settings available for each of the five effects and a further five music BAR settings for the FILTER, PAN and FLANGE effects only. The shorter duration BEATS trigger settings are as follows:

1/4 = Four times every beat = 1 bar

1/2 = Twice every beat = 2 bar

3/4 = Every three quarters of a beat = 4 bar

1/1 = Every beat = 8 bar

2/1 = Every other beat = 16 bar

To change the BEATS trigger setting, use the [BEATS] rotary switch to instantly set a new 'groove', as shown in the following example:

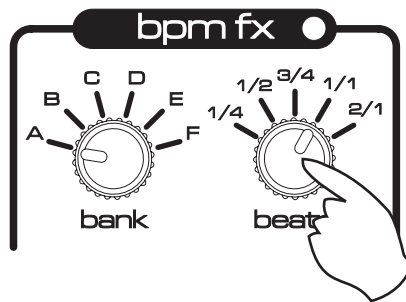

### Additional speed settings for FILTER/FLANGER/PANNER

For example:

**FILTER:** In single mode, press & hold the FILTER effect button and then rotate the FX SPEED rotary switch to one of its 5 positions to access 1 bar, 2 bar, 4 bar, 8 bar & 16 bar settings.

Default settings '4 bars' for FILTER and FLANGER, 2 bars for PANNER.

### MULTI MODE

Multi mode consists of 25 factory preset programs where combinations of the five effects have been carefully setup to offer maximum multi-effects power. The ability to modify the presets in real-time gives added flexibility and allows the user to create customised variations.

The [BANK] rotary switch is used to recall the factory presets from B to F.

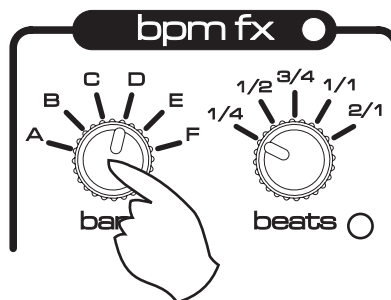

See the PRE-SET VOICE LIST for specific preset program parameters.

**NOTE:** Edited presets are memorised between multi preset selections whilst power remains ON.

### PROGRAM EDIT AND RECALL.

Any alterations to the ISOLATOR and X/Y edit parameters will be memorised. When changing between programs the user can set up a program to their own requirement, change to another program(s) and then return to a previous program and have their special set-up recalled.

To **reset** the factory settings at any time:

**Press & hold the current program button and then press TAP/CLEAR to instantly re-load the default set-up.**

# THE EFFECTS

## THE FILTER

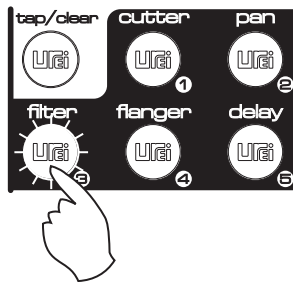

This effect recreates (for many dance music producers and remixers) the most essential part of a classic analogue synthesizer, the filter, and puts it under the direct control of the tempo of the source music via the synchronised Low Frequency Oscillator (LFO).

The Filter allows you to remove or accentuate frequencies in the source signal, the [FREQUENCY] parameter controlling the frequencies to which the changes will be applied. [RESONANCE] allows you to boost the frequencies around the current cut-off frequency, accentuating the action of the filter, especially under the control of the LFO.

### ENVELOPE MODULATION is factory set @ 75%

This is the amount of feedback present in the filter effect, which determines just how exaggerated it becomes.

### FREQUENCY [ X ]

This parameter sets the basic cut-off frequency of the filter which, in [SINGLE] mode, is fixed as a LOW PASS type. (LOW, BAND & HIGH pass filter types are used in [MULTI] mode -see VOICE SHEET for further details).

When the [X] encoder is at the home position the frequency will be at its mid point.

As the encoder is rotated anti-clockwise the frequency will decrease.

As the encoder is rotated clockwise the centre the frequency will increase.

### LFO DEPTH [Y]: single mode [A] only:

In single mode[A] the LFO depth can be turned off to allow purely manual control.

This parameter sets the amount of change (depth) of the cut-off frequency as set by the FREQUENCY [X] control.

The [HIGH-MID-LOW] isolators are used to select either Low Pass, Band Pass or High Pass filter mode.

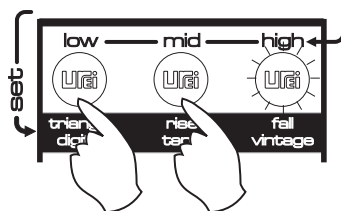

### RESONANCE [ Y ]: multi-mode [B~F] only:

In multi-mode [B~F] the filter frequency is always modulated by the LFO.

This parameter sets the boost level of the frequencies around the cut-off point as set by the [FREQUENCY] control.

When the [Y] encoder is in the centre position the resonance will be at its mid point.

As the encoder is rotated anti-clockwise the resonance level will decrease.

As the encoder is rotated clockwise the resonance level will increase until, at the edge position the resonance will reach self-oscillation producing a new pitched element similar to acoustic feedback.



## SUB-MENU

A special sub-menu for the filter effect lets you choose the LFO (low frequency oscillator) wave shape.

There are three types to choose from, each having their own individual characteristics and subsequent affect on the music.

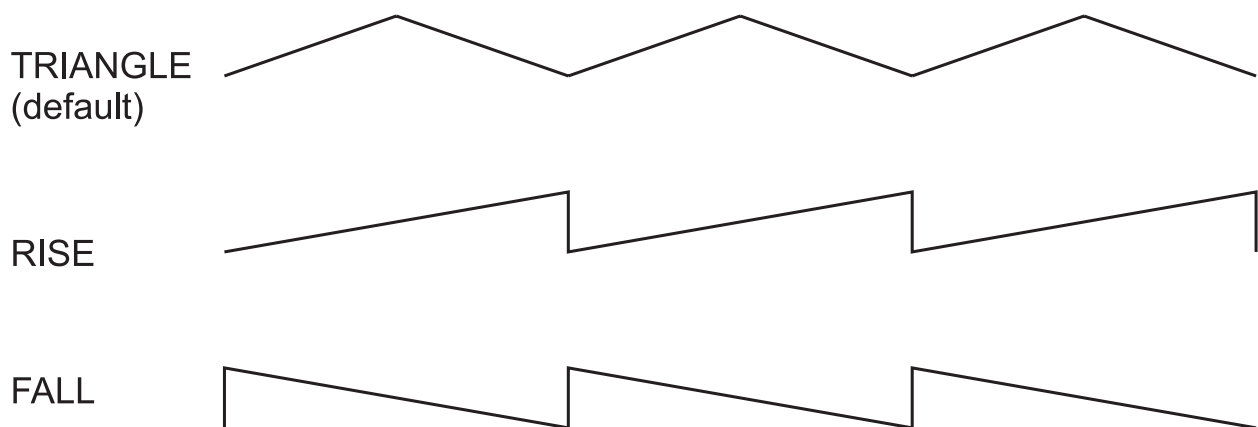

To select a different LFO wave shape , first press and hold down the [FILTER] effect button, then press the Isolator buttons to select [Tri], [Rise] or [Fall].

When you have selected Tri, Rise or Fall, release the FILTER button to store the change.

NOTE: The stored LFO setting will be lost when power is switched OFF. After powering-up, re-configure the effects before a performance.

## THE DELAY

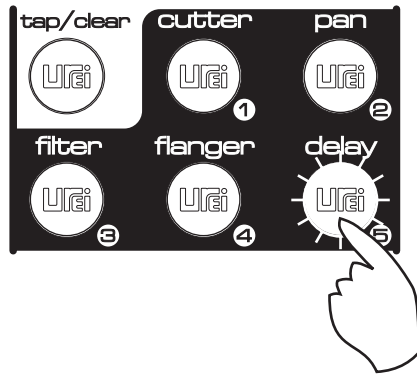

This effect makes a copy of the source signal and then adds it back into the signal after a period of time as set by the BPM analyser. The fidelity and number of repeats can be set to determine how much this affects the original signal. The delayed signal can be a perfect copy of the original, thanks to the high quality of digital technology in 1601E, but this is not always what the user wants. A reproduction parameter is provided to allow the fidelity of the delayed signal to be reduced to that of a classic tape echo machine of the sixties/seventies or beyond to extreme 'grunge'. The number of repeats can be varied from one to increasingly numerous repeats which, although decaying in volume, will still threaten to drown out the source signal (which may be exactly what you want). Use the Max repeat position with caution!

### SPEED [ X ]

This parameter can be used to manually adjust the speed of the DELAY effect. Its operation models the classic tape echo machines of the past, smoothly changing the speed up and down (without a digital glitch) as would the motor driven machines of the 60's and 70's. The inherent speed control time lag of these older tape echo units has also been included. Try rotating the encoder clockwise & anti-clockwise quickly (with multiple repeats set) to hear the delay repeats catch up in a lazy, fluid manner.

When changing to the DELAY effect the delay speed will always be at the rate as set by the BEATS trigger buttons.

As the encoder is moved anti-clockwise the delay speed will smoothly decrease.

As the encoder is moved clockwise the delay speed will smoothly increase.

### REPEATS [ Y ]

This parameter sets the number of times the delayed signal is repeated. At the [MIN] position there will be just a single repeat or echo of the signal (no feedback). As the encoder is moved clockwise the delayed signal will be increasingly fed back into the delay to create more and more repeats, the multiple repeats slowly decaying in volume over a period of time until, at the [MAX] position, the number of repeats feeding back into the delay will be sufficient to maintain the looped section indefinitely.

### SUB-MENU

A special sub-menu for the delay effect lets you adjust the audio reproduction quality of the delayed signal.

To select a different reproduction quality, first \*press and hold down \*the [DELAY] effect button, then press the Isolator button to select [Digital], [Tape] or [Vintage].

At the [DIGITAL] setting the reproduction quality will be at its highest.

At the [TAPE] position the high and low frequency content will be limited whilst harmonic distortion and speed variations (chorus) are also introduced to create the classic sound of an analogue tape machine. This is the default setting.

At the [VINTAGE] position all these elements are exaggerated to an extreme of decay.

NOTE: The stored REPRO setting will be lost when power is switched OFF. After powering-up, re-configure the effects before a performance.

## THE PAN

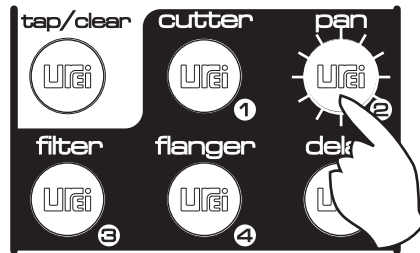

This part of 1601E is quite revolutionary. There have of course been auto-panning devices before, which could use an LFO to move a signal around the stereo field, but none which could trigger the LFO from a BPM analyser and certainly none which could move different frequency bands to different pan positions at the same time. The unique Spatial Panning System featured in 1601E can actually split the incoming signal into three bands (low, mid and high -as normally used by DJs) and then move these bands' pan positions independently.

With SPS Off, the Pan works in a more conventional fashion on the entire signal, moving it around the stereo position at the determined speed, giving you a standard auto-pan controlled by the BPM analyser. As you increase the SPS amount, it will start to move two bands around in the stereo field whilst holding the third user-definable band stationary and as SPS reaches full, all three bands will be constantly cycled to different places in the stereo field.

### SPS [ X ]

This parameter sets the amount of Spatial Panning and how the split frequencies are moved about the stereo field. At the [MIN] position all audio frequencies are locked together and are panned as one. As the encoder is rotated clockwise the audio signal will become increasingly split into high, mid and low frequency elements until, at the centre position, the separation will be at its maximum. This '2-Way' setting of SPS shifts two frequency bands from left to right whilst holding the third in a central position (see [2-WAY SPLIT] section above). As the encoder is rotated further clockwise towards the [MAX] the movement of the split frequency bands increasingly changes, the three bands now starting to 'chase' each other in a left, right, centre, left, right, centre... pattern (or opposite direction) on each triggered pulse until, at the [MAX] end-stop position the Spatial Panning effect will be at its maximum.

NOTE: There is no SUB-MENU function for the PANNER effect.

### 2-WAY SPLIT [ Y ]

This parameter sets the configuration of 2-Way Spatial Panning. When the [Y] encoder is in the start-up position the MID frequency band will be held in a central position with the \*low and high \*frequencies panning from left to right in opposing directions.

As the encoder is rotated in an anti-clockwise direction the configuration will change so that the HIGH frequency band is now held in a central position with the \*low and mid \*frequencies panning from left to right in opposing directions.

As the encoder is rotated in a clockwise direction the configuration will change so that the LOW frequency band is held in a central position with the \*mid and high \*frequencies panning from left to right in opposing directions.

## THE CUTTER

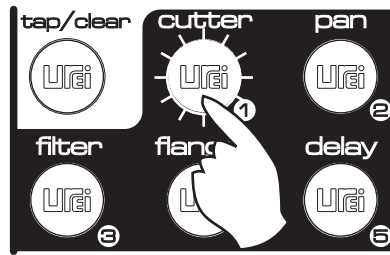

This effect operates in a similar fashion to the filter but on the overall volume of the signal. The Cutter can be set to operate either as a conventional 'gate' which, each time it is triggered, opens instantly to allow the signal through but then after a short period closes completely to cut off the signal. It will also work as a fade-in/fade-out control with a relatively short period of operation.

### DEPTH [ X ] (mark: space ratio)

This parameter sets the length of the square pulse wave 'open' or 'on' period, the period in which the audio signal can be heard.

At the [MIN] position the gate is open for its maximum duration, allowing most of the audio signal to pass. As the encoder is rotated clockwise the centre position the 'open' period becomes increasingly shorter, allowing less and less of the audio signal to pass until, at the [MAX] position the duration of the open period is extremely short, allowing through only a minimal burst of audio.

NOTE: There is no SUB-MENU function for the CUTTER effect.

### SLOPE [ Y ]

This parameter sets the shape of the cutter effect, transforming it from a falling saw tooth to a square pulse with interim settings in between.

When the [Y] encoder is in the default position the shape will be at its mid point. As the encoder is rotated anti-clockwise the shape will become more sloped, the overall volume of the audio rising quickly and falling slowly until, at the edge position it will be a pure saw tooth shape.

As the encoder is rotated clockwise the shape will become more squared-off, quickly rising and falling to form a 'gated' effect until, at the edge position it will be a pure square wave.

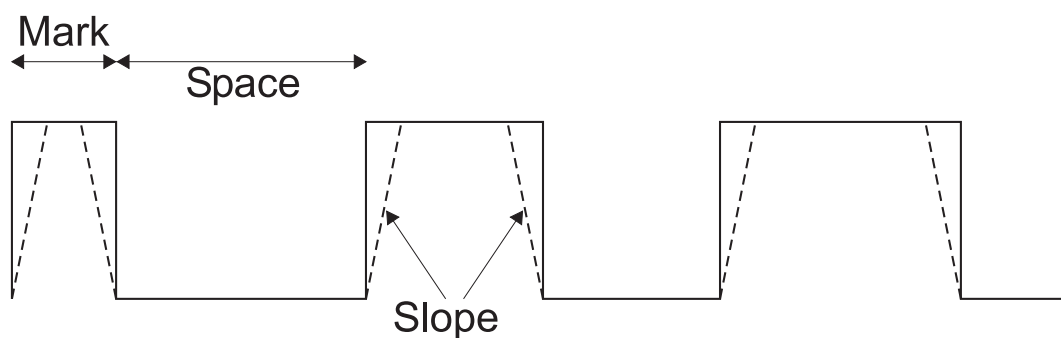

## THE FLANGE

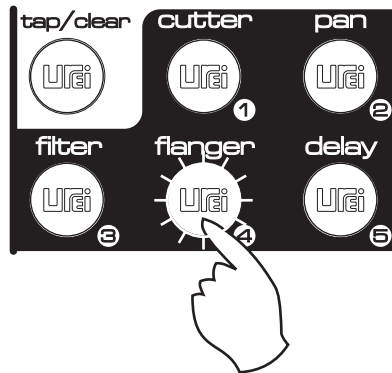

The Flanging effect's name was derived from the way it was first produced back in the sixties, by manually slowing a tape spool (touching the sides or 'flanges' of the spool) on a delay tape machine. This produced the classic 'whooshing' sound, which has been reproduced digitally with a greater degree of reliability and flexibility in 1601E. By feeding more or less of the signal back in to itself, the flanging effect can be exaggerated or made more subtle.

We have included two types of flange in 1601E. Flange 1 accentuates notch frequencies across the range, the most obvious being from 0-250Hz resulting in a boost to low frequency sounds such as the bass drum. Flange 2 accentuates the opposite frequency bands, resulting in a cut to the low frequencies. Flange 1 is assigned to [SINGLE] mode operation whereas both Flange 1 and 2 are featured in [MULTI] mode presets.

### **RESONANCE is factory set @ 75%**

This is the amount of feedback present in the flange effect, which determines just how exaggerated it becomes.

### **FREQUENCY [ X ]**

This parameter sets the frequency of the 'sweeping' element modulated by the trigger setting. This lets you fine tune which frequencies the flanging process will bring out.

At the [MIN] position only the lower frequencies will be affected.

As the encoder is rotated clockwise the higher frequencies will be more affected until, at the [MAX] position only the higher frequencies will be affected.

### **DEPTH [ Y ]**

This parameter sets the overall depth of the flange effect. When the [Y] encoder is in the home position the depth will be at its mid point.

As the encoder is rotated anti-clockwise the depth will decrease making the flange effect more subtle.

As the encoder is rotated clockwise the flanging becomes more and more pronounced until, at the edge position the depth of flanging will be at its greatest.

### **SUB-MENU**

A special sub-menu for the flange effect lets you choose the LFO (low frequency oscillator) wave shape.

There are three types to choose from, each having their own individual characteristics and subsequent affect on the music.

To select a different LFO wave shape, first press and hold down the [FLANGE] effect button, then press the Isolator buttons to select [Tri], [Rise], or [Fall].

TRIANGLE range select [Tri]

RISE range select [Rise] DEFAULT

FALL range select [Fall]

# PRE-SET VOICE LIST

## Multi programs

	X-Encoder		Y-Encoder	Isolator "on"
<b>Bank B</b>				
1	Filter Frequency	50%	Filter Resonance	Low-Mid-Hi
2	Cutter Mix	50%	Delay Speed	Low-Mid-Hi
3	Cutter Mix	50%	Filter Frequency	Low-Mid-Hi
4	Cutter Mix	50%	Filter Env Mod	Low-Mid-Hi
5	Cutter Mix	50%	Filter Frequency	Low Hi
<b>Bank C</b>				
1	Delay repeats	75%	Filter mix	Low Hi
2	Cutter mix	100%	Flanger freq (set res @ 75%)	Mid-Hi
3	Flanger Freq	50%	Flanger depth	Low Hi
4	Delay Mix	25%	Flanger resonance	Low Hi
5	Cutter Mix	100%	DelaySpeed/Filt mix	Low-Mid-Hi
<b>Bank D</b>				
1	Delay repeats	100%	Filter Resonance	Mid-Hi
2	Cutter Mix	75%	Delay input drive	Low-Mid-Hi
3	Filter Env Mod	50%	Filter Frequency	Low Hi
4	Delay Mix	25%	Filter Frequency	Low-Mid-Hi
5	Cutter Mix	50%	Delay speed	Mid-Hi
<b>Bank E</b>				
1	Cutter depth	25%	Filter Resonance	Mid-Hi
2	Delay repeats	75%	Filter Frequency	Low Hi
3	Cutter Mix	50%	Filter frequency	Low-Mid-Hi
4	Cutter Mix	25%	Filter env mod	Low-Mid
5	Cutter Mix	75%	Filter env mod	Low-Mid-Hi
<b>Bank F</b>				
1	Delay speed	100%	Delay repeats	Low Hi
2	Delay speed	50%	Delay repeats	Low-Mid-Hi
3	Delay speed	75%	Flanger freq	Low-Mid-Hi
4	Filter freq	75%	Delay speed	Low-Mid-Hi
5	Filter env mod	100%	Delay speed	Low Hi

All Y parameter values set to 50% default.

## HINTS & TIPS

Synchronisation and Tempo Changes:

Always make slow changes when adjusting the sound source pitch control. This will allow the effects to remain in synchronisation during tempo changes.

Never make tempo changes during quiet passages (when beat information is unavailable) as 1601E BPM engine will lose the BPM range.

# BLOCK DIAGRAM

Please note: to assist the user in understanding the routing of the signals within the mixer, this block diagram has been drawn as if the mixer is an entirely analogue device. In reality much of the mixer is implemented within the DSP.

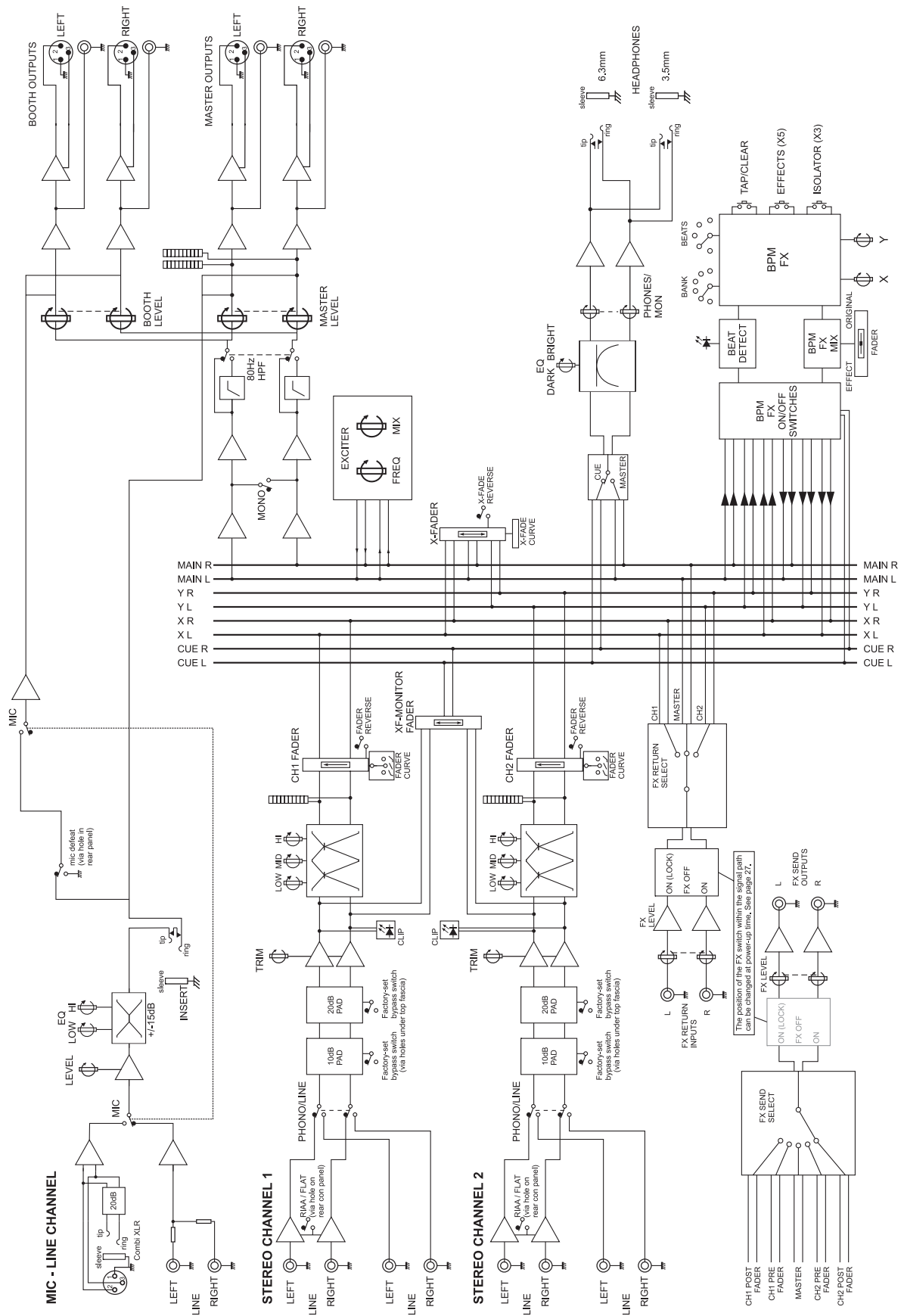

# CONNECTING LEADS

## Audio Connectors Used With The 1601E

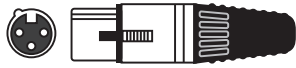

XLR

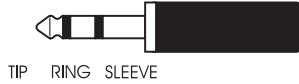

3-pole 1/4" (A gauge TRS) jack



RCA phono

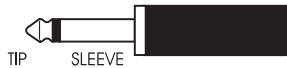

2-pole 1/4" (A gauge TS) jack

## Details Of Audio Connecting Leads That May Be Useful

### Balanced

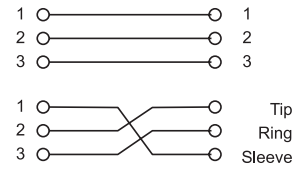
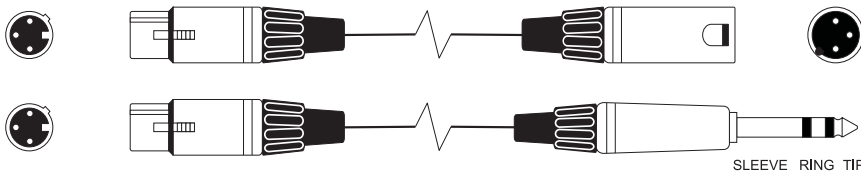

### Unbalanced

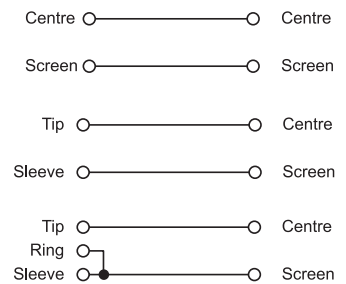
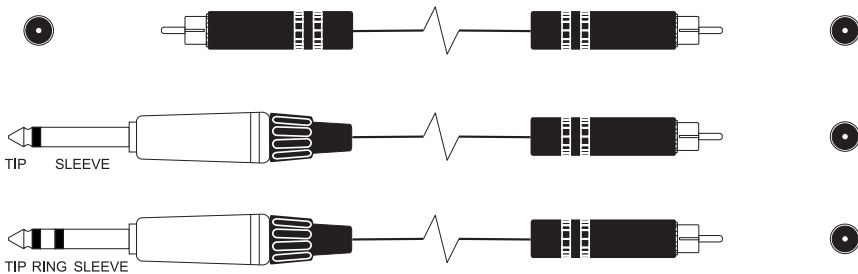

### Mic/Line Insert

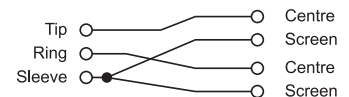
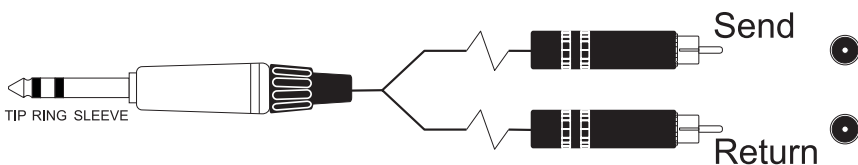



# TROUBLESHOOTING

## **Problem: No Power. No sound**

Check power supply connection.

Check position of input controls: SELECTOR / TRIM / LEVEL / EQ CUT.

Check input connections.

Check crossfader position.

Check output connections.

Check and adjust input TRIM pads.

## **Problem: Faders work the wrong way round.**

Check fader reverse switches on front panel.

## **Problem: DJ Mic causes feedback from booth speakers.**

Engage mic defeat button on rear con. panel.

## **Problem: Turntable volume is very low.**

Check that the phono/line switch on the rear panel is selected. See page 18, item 5.

## **Problem: Buzzing from turntable.**

Check analog player ground connections.

## **BPM engine will not read track**

Check/reset BPM range

Check mixing desk levels are at 0 or above on the input meters

## **Unable to hear effect**

Check MIX fader setting

Check ISOLATOR filter settings

Is the right effect activated?

Check input level fader control

# SPECIFICATIONS

## DIGITAL AUDIO:

Sample rate: 96kHz  
Resolution: 24 bit

## FREQUENCY RESPONSE:

CD/Line: 20 Hz to 20 kHz (+/-0.5 dB)  
Phono: 20 Hz to 20 kHz (+/-1.5 dB/RIAA)  
MIC [Line]: 20 Hz to 20 kHz (+/-2 dB) [20 Hz to 20 kHz (+/-0.5 dB)]  
AUX/FX Return: 20 Hz to 20 kHz (+/-0.5 dB)

## SIGNAL/NOISE RATIO:

CD/Line: 90 dB  
Phono: 75 dB  
MIC [Line]: 70 dB [90 dB]  
AUX/FX Return: 90 dB

## TOTAL HARMONIC DISTORTION / CROSSTALK:

THD: less than 0.02%  
Crosstalk: 80dB

## AUDIO INPUT: (max input level, nominal settings/impedance)

CD/Line: +14dBu / 10k ohms  
Phono: (1kHz) -23dBu / 47k ohms  
MIC [Line]: -22dBu / 3k ohms [+20 / 22k ohms]  
AUX/FX Return: +20dBu / 22k ohms

## AUDIO OUTPUT: (max output level/impedance)

Master unbalanced: +20dBu / 75 ohms  
Master balanced(XLR): +20dBu / 150 ohms  
Booth unbalanced: +20dBu / 75 ohms  
Booth balanced(XLR): +20dBu / 150 ohms  
MIC insert: +20dBu / 75 ohms  
FXSend: +20dBu / 75 ohms  
Headphones: -20dBu / 40 ohms

## CHANNEL EQ:

High: +6 dB/ -85 dB (10kHz)  
Mid: +6 dB/ -85 dB (1kHz)  
Low: +6 dB/ -85 dB (100Hz)

## POWER SUPPLY:

Internal switch mode psu: 100v-240V AC, 50W, 50-60Hz

## DIMENSIONS/WEIGHT:

395(H) x 280(W) x 90(D)mm/4.7kg  
15.5(H) x 11(W) x 3.5(D)inches /10.4lbs

# WARRANTY

- 1 Soundcraft is a trading division of Harman International Industries Ltd.  
End User means the person who first puts the equipment into regular operation.  
Dealer means the person other than Soundcraft (if any) from whom the End User purchased the Equipment, provided such a person is authorised for this purpose by Soundcraft or its accredited Distributor.  
Equipment means the equipment supplied with this manual.
- 2 If within the period of twelve months from the date of delivery of the Equipment to the End User it shall prove defective by reason only of faulty materials and/or workmanship to such an extent that the effectiveness and/or usability thereof is materially affected the Equipment or the defective component should be returned to the Dealer or to Soundcraft and subject to the following conditions the Dealer or Soundcraft will repair or replace the defective components. Any components replaced will become the property of Soundcraft.
- 3 Any Equipment or component returned will be at the risk of the End User whilst in transit (both to and from the Dealer or Soundcraft) and postage must be prepaid.
- 4 This warranty shall only be available if:
  - a) the Equipment has been properly installed in accordance with instructions contained in Soundcraft's manual; and
  - b) the End User has notified Soundcraft or the Dealer within 14 days of the defect appearing; and
  - c) no persons other than authorised representatives of Soundcraft or the Dealer have effected any replacement of parts maintenance adjustments or repairs to the Equipment; and
  - d) the End User has used the Equipment only for such purposes as Soundcraft recommends, with only such operating supplies as meet Soundcraft's specifications and otherwise in all respects in accordance Soundcraft's recommendations.
- 5 Defects arising as a result of the following are not covered by this Warranty: faulty or negligent handling, chemical or electro-chemical or electrical influences, accidental damage, Acts of God, neglect, deficiency in electrical power, air-conditioning or humidity control.
6. The benefit of this Warranty may not be assigned by the End User.
7. End Users who are consumers should note their rights under this Warranty are in addition to and do not affect any other rights to which they may be entitled against the seller of the Equipment.

# GLOSSARY

Amplitude:	Another term used for signal level.
Attenuate:	Reduce the signal level.
Attenuator:	A device which reduces the signal level.
Auxiliary (Aux):	An independent mix derived from the channels for various functions. This can be set pre (before) or post (after) the channel fader.
Balanced, Unbalanced:	Refers to the type of input or output signal connection. An unbalanced connection has two signal carrying conductors, one of which is the cable shield. A balanced connection has three conductors, two for signal and a shield which is connected to earth. Because the signal conductors are at the same impedance and of opposite polarity they are better able to cancel and therefore reject interference and noise pickup. It is standard practice to use balanced connections for long cable runs, for example to amplifiers, or cables carrying sensitive or low level signals, for example microphones.
Bandpass (BPF):	A filter with a bell-shaped response for attenuation of frequencies either side of the centre frequency.
Beat Mixing:	Using the variable pitch controls on turntables/CD players to synchronise the rhythm track of two separate songs, so that the beat remains constant when smoothly cross-fading from one to the other.
Beats Per Minute (BPM):	The measurement of the rhythmic beat or tempo of the music.
Booth:	The area, often enclosed, where the DJ operates. It is usually provided with local booth monitor loudspeakers.
Cutting:	Moving the cross-fade control sharply from one side to the other, to either pick out a sound, a hi-hat, kick drum etc, or to drop straight into another record. Also known as chopping.
Cartridge:	The pickup in a turntable. Uses a stylus to pick up vibrations from the record (vinyl) and convert this to electrical signals that feed the console. The cartridge is usually fitted to a removable headshell that plugs into the turntable arm.
Clipping:	The harsh distorted sound that results when the signal hits the maximum level possible.
Contour (Law, Curve):	The term used to describe the 'law' of a fader, how quickly it responds as it is moved, or the amount of fade per unit of movement. The contour control associated with a fader lets the DJ tailor its response to suit the preferred mixing style.
Cross-fader:	A horizontally operated fader for fading one music track in while fading the other out. Often used by the DJ for cutting and layering sounds while mixing.
Cue (Solo):	A monitor system provided for the DJ to check individual channel signals using headphones while lining up tracks ready to introduce into the mix.
Daisy-Chaining:	Connecting the output of one mixer to an input of another mixer.
dB (Decibel):	The unit of measurement for audio signal level. This is logarithmic to follow the response of the human ear. 'dB' is a relative measurement to compare one level with another, for example gain from input to output. 'dBu' is an absolute measurement referenced to a voltage standard where 0dBu = 0.775V rms. The console main outputs operate at 0dBu = '0' reading on the meters. 'dBV' is a similar measurement but refers to a 1V standard. It is common for consumer equipment to operate at the standard of -10dBV (316mV). 'dBA' refers to sound pressure level and is measured using the 'A' scale that 'hears' in the same way as the human ear.
Dynamic Range:	The difference expressed in dB between the highest and lowest signal levels possible. This is limited by the clipping level and residual noise floor respectively.
Earth (Ground):	The term for the electronic signal reference. This generally connects to the mains supply earth point and all cable shields and conductive equipment cases. It provides the return for the signal voltage within the equipment. It also ensures operator safety by removing the possibility of electric shock should the mains voltage touch any metal part.

Earth Loop (Ground Loop):	The result when the equipment sees more than one path to the system earth. Current flows because a resistive loop susceptible to radio and mains interference is formed. In severe cases this can result in audible hum or buzz in the system. Breaking the loop by removing all but one path to earth usually solves the problem.
EQ (Equaliser):	This provides cut or boost of selected frequencies (equalisation) for tonal shaping of the sound.
Feedback:	Also known as 'howlround' or 'ringing', this is the rapidly increasing tone produced when a microphone picks up its own signal from the speakers. It is usually a shrill and annoying squeal that should be quickly dealt with by repositioning the microphone or speakers, reducing mic gain or equalising the system to notch out the offending frequencies.
Gain:	This is the boost or attenuation applied to the source signal in the channel preamp stage to match it to the console operating level. For example, a large amount of gain is needed to match low microphone signals. It is set using the console meters. Gain is not used for level (volume) control.
Headroom:	The amount of level available expressed in dB to handle peaks above the normal 0dB operating level.
Hz (Hertz):	The measurement of frequency. The audio spectrum ranges from a low (bass) frequency of 20Hz to a high (treble) 20kHz.
Highpass filter (HPF):	A filter that attenuates frequencies below the cut-off frequency.
Hum:	This is the audible noise that usually results from mains interference pickup, earth loops, bad interconnections and induced power supply and lighting fields. It is usually at mains frequency (50/60Hz) or a related harmonic.
Impedance:	A technical term for the resistance of a signal conductor to ground. Low impedance (Low Z) usually refers to microphones of 200 ohms or less, and line signals typically less than 100 ohms. Low Z sources are less prone to interference pickup. Inputs are usually high impedance (High Z) so that one source can connect to more than one channel without signal loss. Note that the operating impedance of a connection is set by the impedance of the source, not that of the unconnected input.
Limiter:	A signal processor that limits the maximum level possible by preventing the signal going over a predetermined threshold level. This is very useful in club installations where it is inserted between the console and house system amplifiers to prevent the DJ exceeding the maximum allowable volume.
Lowpass filter (LPF):	A filter that attenuates frequencies above the cut-off frequency.
Mono:	A single source with no stereo content, or the left and right stereo signals summed together as one.
Mono Sum:	A mono signal which is the sum of the left and right parts of a stereo pair.
Mute (Cut):	To turn off the signal. Transform is a mute, or cut effect.
Noise:	Generic term for an unwanted signal. This may be residual electronic hiss, hum, buzz, clicks and pops.
Noise Floor:	This is the term for the residual electronic noise produced by all powered audio equipment. It usually sounds like a constant hiss, although some equipment may suffer from residual hum as well.
Omni-directional:	The response of a microphone which picks up sounds equally all round. Not suited to live vocal applications as they are more prone to feed back.
Pad:	Another term for attenuator.
Pan (Panoramic):	A control that adjusts the balance of the signal in the left and right speakers.
Peak Meter:	A type of signal meter that has a very fast attack and slower release. This picks up the fast signal transients and holds them long enough for the operator to see the activity on the display. These meters typically use led (light emitting diode) displays.
Phono:	Abbreviation for phonograph as in 'turntable'. Usually means RIAA equipped input when marked on console inputs. Can also refer to the RCA 'phono' type connector found on turntables and CD players.

Polarity:	Sometimes erroneously referred to as 'phase' this is the + / - sense of a balanced signal or loudspeaker connection. Reversed polarity should be avoided and checked for as it can cause uncomfortable phasing effects as the listener moves between the speakers. Polarity Reverse is often used to correct for wrongly wired cables and connectors.
Pre-fade:	The signal is taken from a point in the circuit which is before the fader.
Post-fade:	The signal is taken from a point in the circuit which is after the fader.
RIAA:	Record Industry of America Association, responsible for the long established equalisation standard that is applied to the signal produced by a turntable cartridge. Due to the physical limitations of vinyl reproduction the stylus produces a reasonable level high frequency signal but a much less lower level low frequency. An RIAA pre-amplifier compensates for this by attenuating the high and boosting the low frequencies.
Reverberation:	The way in which sound reflects and bounces around the room after the source is removed. This depends on the size and shape of the room as well as the materials such as carpets, curtains and clothing that absorb certain frequencies.
Reverb Effect:	This is a signal processor that connects to the console to artificially simulate the reverb effect. Parameters such as decay time, diffusion and amount of reverb can be controlled. Typically selected sounds are sent to the processor by turning up the channel post-fade aux sends. The processed (wet) signal is returned to the mix through a channel where it adds to the direct (dry) signal routed from the channel fader.
RPM:	Revolutions Per Minute. The measurement of turntable speed, 33, 45 and 78 RPM.
Sampler:	Another performance effect popular with DJs. The channel signal is sent to a digital processor that samples (stores) a short duration of sound. The output is returned through a channel and replayed by pressing a trigger. Many samplers provide creative effects such as repeat and reverse. The UREI sampler is BPM activated.
Scratching:	The art of rhythmically rocking a record back and forward on a turntable, to repeat a certain sound, a vocal or tone, at the same time operating the cross-fader to create a syncopated "wah wah" chirp added over a bass heavy back beat.
Signal-to-Noise Ratio (SN):	This is the difference expressed in dB between the normal 0dB operating level and the residual noise floor. It represents how far above the equipment hiss level the signal operates. A higher figure is better.
Slip mat:	A fabric turntable mat positioned under the record so that the DJ can hold it stationary ready to let go for a fast start at the point cued.
Split Cue:	A facility to listen to the cue signal in one ear while keeping the program in the other. Used for matching the beat while cueing a new track. Some consoles provide a CUE/MIX fader to preview the mix before going live. On the UREI 1601 series this is the xf-monitor.
Sub Bass:	A loudspeaker designed to reproduce only very low frequency sound, typically from around 30 to 120Hz. A crossover is used to route only the low frequencies to the sub.
Tempo:	The rhythmic beat of the music, usually referred to in BPM (Beats Per Minute).
Turntable:	Otherwise known as a 'record deck' this plays vinyl discs, still the most popular source for DJ mixing. It is common for the output of the cartridge to plug directly into the mixing console 'phono' input which provides the RIAA equalisation required. The turntable usually has variable speed control so that the DJ can synchronise the beat between tracks.
VCA	Voltage Controlled Amplifier: An audio gain element whose level is controlled by a remote DC voltage rather than through a fader or rotary control. VCA Cross fader functions as an audio cross fader but with the audio level controlled by a DC voltage produced by the fader. This voltage can be electronically filtered and is therefore able to remove the clicks, scratches and dropouts associated with worn audio faders.
XLR:	The professional standard 3 pin round connector used for microphone and other balanced connections. Equipment female sockets are for inputs, male for outputs.







## Free Manuals Download Website

<http://myh66.com>

<http://usermanuals.us>

<http://www.somanuals.com>

<http://www.4manuals.cc>

<http://www.manual-lib.com>

<http://www.404manual.com>

<http://www.luxmanual.com>

<http://aubethermostatmanual.com>

Golf course search by state

<http://golfingnear.com>

Email search by domain

<http://emailbydomain.com>

Auto manuals search

<http://auto.somanuals.com>

TV manuals search

<http://tv.somanuals.com>