

SPIRIT

By Soundcraft

CONTENTS

Introduction	1
Basic Principles of PA Mixing	2
Installation & Safety Precautions	4
Connecting It Up	5
Wiring It Up	6
Getting to Know Your Console	10
Input Channel	10
Stereo Inputs>Returns	12
Master Section	13
Using Your Spirit Live 3 ² Console	15
Applications	17
Care Of Your Mixer	21
Glossary	21
Typical Specifications	23
Dimensions	24
Expander Installation Instructions	25
System Block Diagram	27
Panel Layout	Inside rear cover

SPIRIT

SPIRIT LIVE 3²

USERS GUIDE

Thank you for purchasing a SPIRIT LIVE 3² mixer, brought to you with pride by the SPIRIT team of Graham, Simon, James, Chris, Colin, Andy, Peter, Martin, René, Roland and Kevin, with the support of many others - we hope you will have as much fun using it!

© Spirit By Soundcraft™ 1995

All rights reserved

Parts of the design of this product may be protected by worldwide patents

Issue 1

Part No. ZM0???

Information in this manual is subject to change without notice and does not represent a commitment on the part of the vendor. Spirit By Soundcraft™ shall not be liable for any loss or damage whatsoever arising from the use of information or any error contained in this manual.

No part of this manual may be reproduced, stored in a retrieval system, or transmitted, in any form or by any means, electronic, electrical, mechanical, optical, chemical, including photocopying and recording, for any purpose without the express written permission of Spirit By Soundcraft™.

It is recommended that all maintenance and service on the product should be carried out by Spirit By Soundcraft™ or its authorised agents. Spirit By Soundcraft™ cannot accept any liability whatsoever for any loss or damage caused by service, maintenance or repair by unauthorised personnel.

Spirit By Soundcraft™.
Harman International Industries Ltd.,
Cranborne House,
Cranborne Industrial Estate,
Cranborne Road,
Potters Bar,
Hertfordshire,
EN6 3JN, U.K.

Tel: +44 (0) 1707 665000

Fax: +44 (0) 1707 660461

INTRODUCTION

Thanks for purchasing a SPIRIT LIVE 3² mixer. Owning a Soundcraft console brings you the expertise and support of one of the industry's leading manufacturers and the results of over 22 years experience supporting some of the biggest names in the business.

Designed by engineers who understand the individual needs of musicians, SPIRIT LIVE 3² has been built to the highest standards using quality components and employing automated assembly techniques beyond the reach of most manufacturers of compact mixers.

A rugged steel chassis is combined with moulded side trims to give protection and a distinctive appearance. Custom moulded controls, designed for the best 'feel' and visual clarity, complement the styling, resulting in a truly professional product which is ideal for both touring and fixed PA installations.

SPIRIT LIVE 3² is available in 8, 12, 16 and 24 channel frame sizes, which may be extended by adding an 8 channel Expander. The Expander can be attached quickly and securely to the console, requiring only a screwdriver and a steady hand to complete the installation.

SPIRIT LIVE 3² incorporates circuit technology identical to that used on some of the most sophisticated Soundcraft consoles. The input channels are able to accept a wide range of Microphone and Line level signals from separate input sockets. Every channel features wide-range gain control, 4-band Equalisation with swept Hi and Lo Mid ranges, plus a Hi-Pass Filter, 4 Auxiliary Sends, PFL(Pre Fade Listen), Peak LED, Panning to a Stereo bus and routing to a separate Mono bus. The additional bus is a unique feature at this price level and is ideal for driving a centre loudspeaker cluster, or with the Left and Right busses used as subgroups and mixed down to the Mono bus, as the main output. Each channel is controlled by a high-quality long throw fader.

All frame sizes are provided as standard with two dedicated stereo inputs. Each stereo input comprises switchable input gain, two-band EQ and sends to Aux 1 & 2, Mix and Mono busses.

The Master section provides master level control for the Left, Right, Mono and Auxiliary Send buses, with separate AFL monitoring on each Auxiliary Send. Aux 2 & 3 may both be selected as PRE or POST fade sends, allowing flexibility for foldback or effects.

Two Stereo Effects Returns are provided, with switchable input gain and mixing to Left and Right busses.

A dedicated stereo output is provided for recording the Mix. By selecting internal links the Mono output can also be recorded via this stereo output.

The Mix L/R and Mono outputs all have insert points for the connection of external signal processors. Two 12-segment, 3-colour peak-reading LED bargraph meters display the selected headphones source, allowing monitoring of Mix or Mono signals. Pressing any PFL or AFL switch puts the selected signal onto both sides of the headphones output, and the L & R bargraph meters in place of the selected signal.

SPIRIT Live 3² is designed to be as user-friendly as possible, but a few minutes spent reading through this manual will help you become familiar with the product away from the pressure of a live session, and allow you to gain full benefit from the superb performance offered by your new mixer.

Above all, remember that your SPIRIT mixer is designed to extend your creativity. The more you explore the controls and the effect they have on the sound output, the more you will appreciate how you can influence and enhance the final sound.

BASIC PRINCIPLES OF PA MIXING

There was a time when the P.A. system and the operator existed only to increase the overall volume of the performers, so that they could be heard in a large room or above high ambient noise levels. This just isn't true any more. The sound system and the sound engineer have become an integral part of the performance, and the artists are heavily dependent on the operator's skill and the quality of the equipment.

The following introduction to the basics of mixing are included for the benefit of those users who may not have any significant familiarity with sound equipment, and who are baffled by the endless jargon used by engineers and artists alike.

THE MIXER

As one would expect, the main purpose of the mixer is to combine sounds, but under precise and smooth control. This is why long-throw faders are essential on any professional product. The faders provide you with clear and instinctive control of the final sound balance and like an artist playing an instrument you should listen to the effect of your fader movements, not look at your hands.

Your SPIRIT LIVE 32 mixer accepts a wide range of input signals via the UltraMic Plus™ microphone input (for very low level signals) or a line input (for higher level signals) from, for instance, tape machines, effects processors, etc.

Note: Mic and Line inputs have the same gain range, differing only in source impedance.

The mixer is split into two sections. The **Inputs** receive, match and process individual source signals, and distribute them at precise mix levels to either a stereo **Mix** output or **Mono** output. The **Master** section allows overall level control of all outputs, and provides monitoring of the audio signal at many points in the mixer, either on headphones or meters.

The **Equaliser** controls are the most flexible and potentially destructive feature of the mixer. They have a similar effect on the frequency response of the input channel as the tone controls on a hi-fi system, but with much greater precision, and allow particular characteristics of the input signal to be emphasised or reduced. It is very important that you become familiar with the effect each control has on the sound and this is best achieved by spending time listening to the effect of each control on a well-known track played through the mixer.

The **Auxiliary Sends** provide a way of routing the input signals to a number of secondary outputs, for artists foldback, FX units or additional speaker outputs.

The **Pan** control adjusts the position of the input signal within the stereo mix, and can be swept from full left, through to full right. This allows particular artists to retain their correct spatial position within the mix, and can be valuable for live effects.

Pre-Fade-Listen(**PFL**) allows you to monitor the signal at many points in the mixer. Pressing any PFL switch routes the signal at that particular point into the headphones and the meters, to check the quality of the signal or to pin-point problems. Using PFL will not affect the signals on the outputs from the desk.

Each input channel and the three main outputs have an **Insert** 'A' gauge jack socket, which is a break point in the signal path. It allows the signal to be taken out of the mixer, through an external piece of equipment and then back into the mixer directly after its original exit point. The Insert point is normally bypassed by the 'A' gauge jack socket contacts, and is only brought into operation when a plug is inserted. Typical uses would include Effects Processing, Limiting, additional Equalisation or Delay.

The terms **PRE** and **POST** are often used in the context of Inserts, Equalisers and Auxiliary Sends, and describe whether that facility is placed before (Pre) or after (Post) another particular section. This is explained further in the detailed description of facilities.

A mixer is often judged, amongst other factors, by the amount of **Headroom** available. This is a measure of the reserve available to cope with sudden peaks in the input signal, without distortion caused by **Clipping**, when the signal becomes so high that it would exceed the power supply rail voltages and is as a result limited. This commonly occurs where gain settings are incorrectly set or where sources are improperly matched to the mixer input. If the source signal is too high, clipping and distortion results. If the signal is too low it becomes masked by the background noise which is present to some degree in all mixers, although minimal in SPIRIT products. The diagram below illustrates this point.

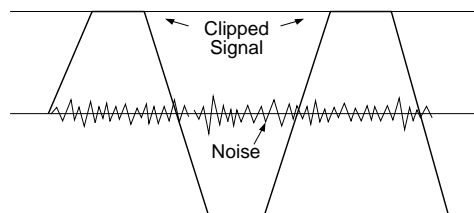

If the signal level is too high, clipping distortion may occur.

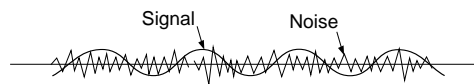

If the signal level is too low it may be masked by the noise.

INSTALLATION AND SAFETY PRECAUTIONS

INSTALLING THE MIXER

Correct connection and positioning of your mixer is important for successful and trouble-free operation. The following sections are intended to give guidance with cabling, connections and configuration of your mixer.

- Choose the mains supply for the sound system with care, and do not share sockets or earthing with lighting dimmers.
- Position the mixer where the sound can be heard clearly, preferably in the centre, and within the audience.
- Run audio cables separately from lighting circuits, using balanced lines wherever possible. If necessary, cross audio and lighting cables at right angles to minimise the possibility of interference. Keep unbalanced cabling as short as possible.
- Do not mix phases on a 3-phase supply without consulting an electrician.
- Check your cables regularly and label each end for easy identification.

SAFETY PRECAUTIONS

For your own safety, and to avoid invalidation of the warranty, please read this section carefully.

The LIVE 3² mixer must only be connected through the Power Supply supplied.

The wires in the mains lead are coloured in accordance with the following code:

Earth:	Green and Yellow	(Green/Yellow - US)
Neutral:	Blue	(White - US)
Live:	Brown	(Black - US)

As the colours of the wires in the mains lead may not correspond with the coloured markings identifying the terminals in your plug, proceed as follows:

The wire which is coloured Green and Yellow must be connected to the terminal in the plug which is marked with the letter E or by the earth symbol.

The wire which is coloured Blue must be connected to the terminal in the plug which is marked with the letter N.

The wire which is coloured Brown must be connected to the terminal in the plug which is marked with the letter L.

Ensure that these colour codings are followed carefully in the event of the plug being changed.

To avoid the risk of fire, replace the mains fuse only with the correct value fuse, as indicated on the power supply.

CONNECTING IT UP

The diagram below shows various equipment that would be connected to a SPIRIT Live 3²

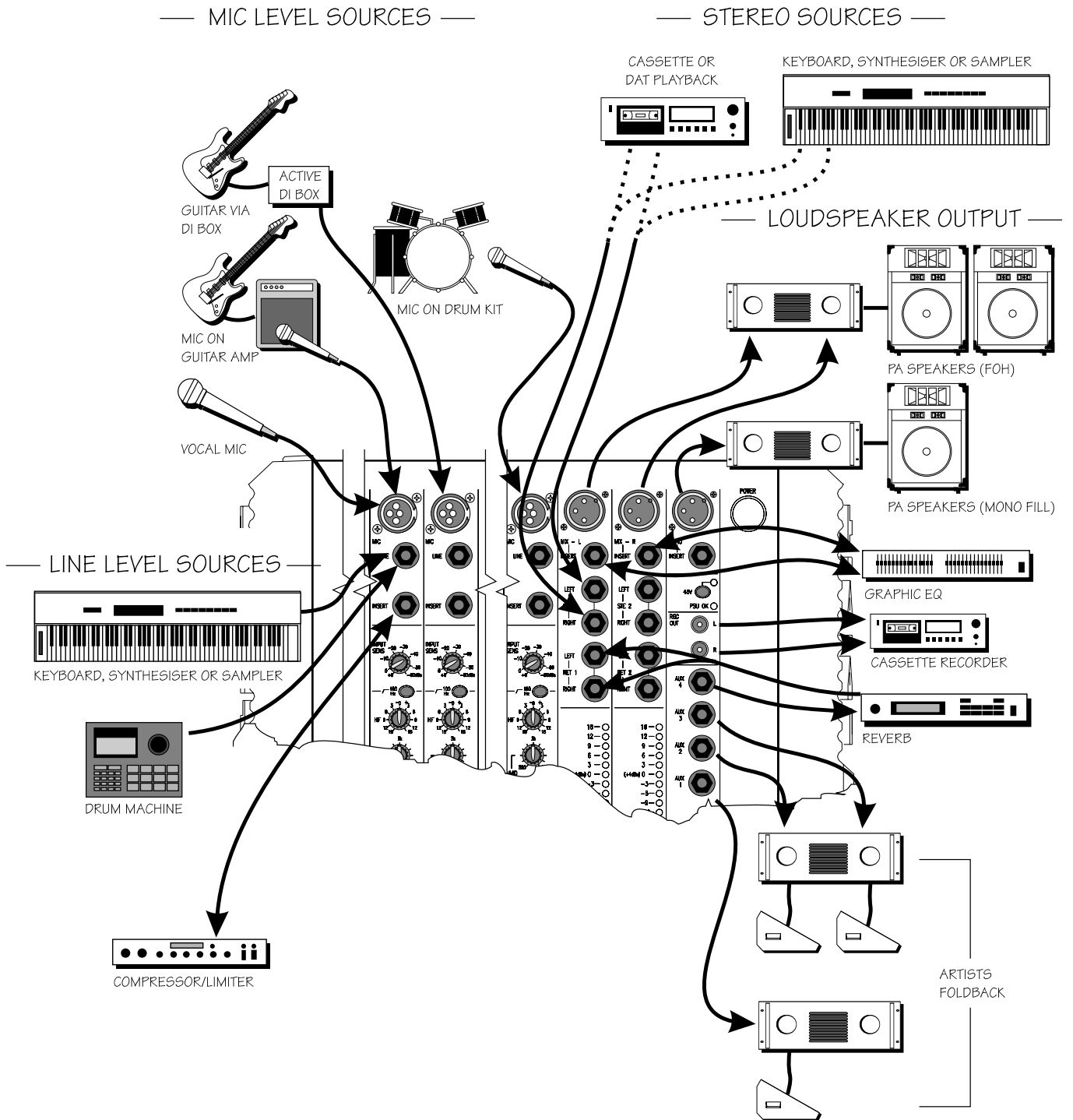

WIRING IT UP

INPUTS

Balanced Mic XLR

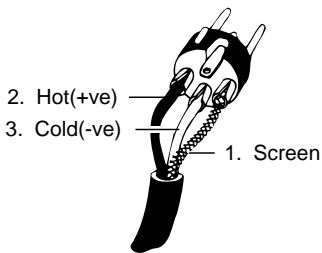

Unbalanced Mic XLR

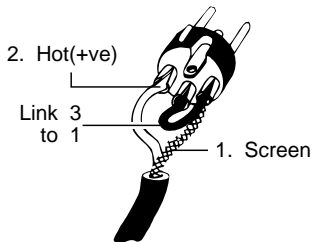

Balanced 3 pole Jack Unbalanced 3 pole Jack

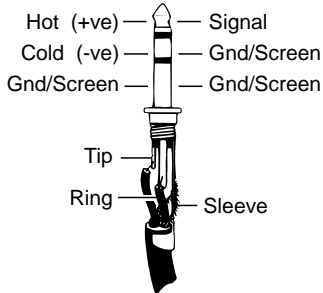

Inserts

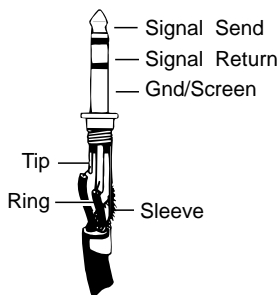

MIC INPUT

The mic input accepts XLR-type connectors and is designed to suit a wide range of **BALANCED** or **UNBALANCED** low-level signals, whether from delicate vocals requiring the best low-noise performance or close-miked drum kits needing maximum headroom. Professional dynamic, condenser or ribbon mics are best because these will be **LOW IMPEDANCE**. While you can use low-cost **HIGH IMPEDANCE** mics, you do not get the same degree of immunity to interference on the microphone cable and as a result the level of background noise may be higher. If you turn the **PHANTOM POWER** on, the socket provides a suitable powering voltage for professional condenser mics.

DO NOT use unbalanced sources with the phantom power switched on. The voltage on pins 2 & 3 of the XLR connector may cause serious damage.

The input level is set using the **INPUT** knob.

WARNING - Start with the **INPUT** knob at the '-6' position when plugging high level sources into the **LINE** input to avoid overloading the input channel or giving you a very loud surprise!

LINE INPUT

The **LINE** input offers the same gain range as the **MIC** input, but at a higher input impedance. This is suitable for most line level sources, and provides the gain needed for lower level keyboards and high impedance microphones. The input accepts 3-pole 'A' gauge jacks, or 2-pole mono jacks which will automatically ground the 'cold' input. Use this input for sources other than mics, such as keyboards, drum machines, synths, tape machines or guitars. The input is **BALANCED** for low noise and immunity from interference, but you can use **UNBALANCED** sources by wiring up the jacks as shown, although you should then keep cable lengths as short as possible to minimise interference pick-up on the cable. Refer to the section 'How to Prevent Interference' later in this manual. Note that the ring must be grounded if the source is unbalanced. Set the input level using the **INPUT** knob, starting with the knob turned fully anticlockwise. Plugging into the **LINE** input automatically cuts off the **MIC** input.

Note that with high level sources it may be necessary to reduce the level at source to avoid overloading the input.

INSERT POINT

The unbalanced, pre-EQ insert point is a break in the channel signal path, allowing limiters, compressors, special EQ or other signal processing units to be added in the signal path. The Insert is a 3-pole 'A' gauge jack socket which is normally bypassed. When a jack is inserted, the signal path is broken, just before the EQ section.

The signal from the channel appears on the **TIP** of the plug and is returned on the **RING**, with the sleeve as a common ground.

OUTPUTS

Mix Outputs
Mono Output

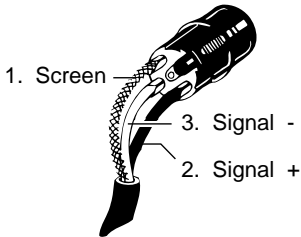

Mix & Mono Inserts

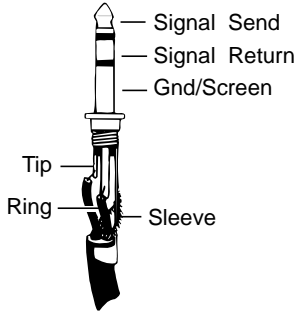

Aux Outputs

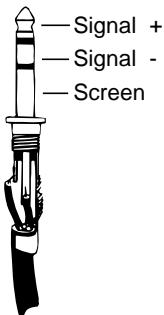

Headphones

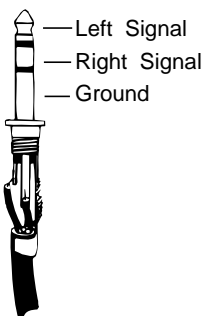

STEREO INPUTS, STEREO RETURNS

Accept 3-pole 'A' gauge jacks, or 2-pole mono jacks which will automatically ground the 'cold' input. Use these inputs for sources such as keyboards, drum machines, synths, tape machines or as returns from processing units. The input is **BALANCED** for low noise and immunity from interference, but you can use **UNBALANCED** sources by wiring up the jacks as shown, although you should then keep cable lengths as short as possible to minimise interference pick-up on the cable. Note that the ring must be grounded if the source is unbalanced. Mono sources can be fed to both paths by plugging into the Left jack only.

MIX INSERTS, MONO INSERT

The unbalanced, pre-fade insert points are a break in the output signal path to allow the connection of, for example, a compressor/limiter or graphic equaliser. The Insert is a 3-pole 'A' gauge jack socket which is normally bypassed. When a jack is inserted, the signal path is broken, just before the mix fader.

The mix signal appears on the **TIP** of the plug and is returned on the **RING**. A 'Y' lead may be required to connect to equipment with separate send and return jacks as shown below:

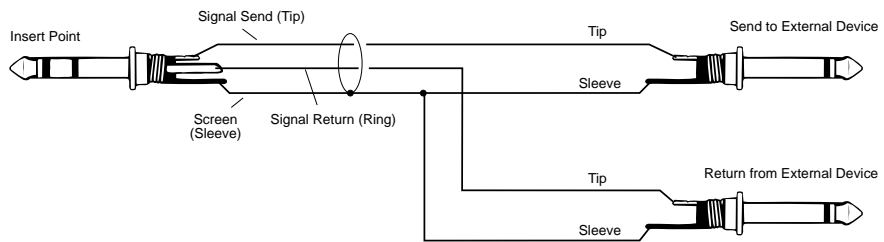

MIX & MONO OUTPUTS

The Mix and Mono outputs are on 3-pole XLR sockets, wired as shown on the left and below, and incorporate impedance balancing, allowing long cable runs to balanced amplifiers and other equipment.

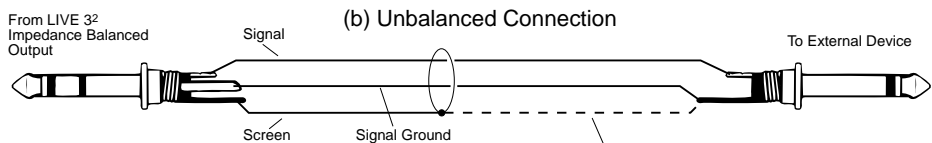
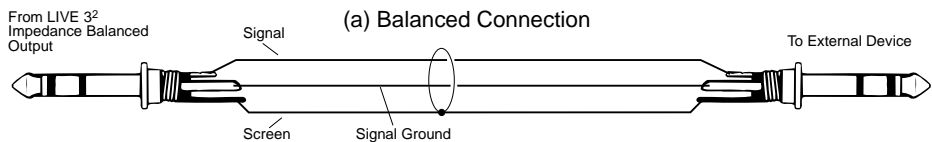

Experience has shown that sometimes it is better not to connect screen at external device end.

OUTPUTS

Mix Outputs
Mono Output

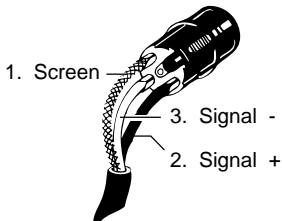

Mix & Mono Inserts

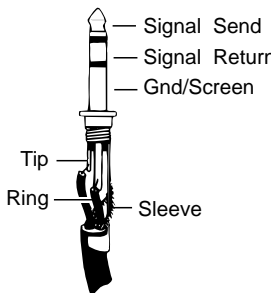

Aux Outputs

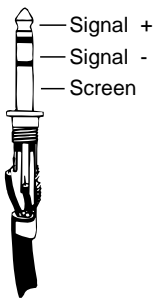

Headphones

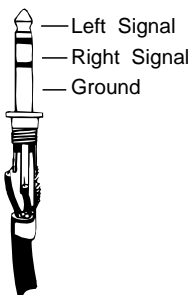

AUX OUTPUTS

The Aux outputs are on 3-pole 'A' gauge jack sockets, wired as shown on the left, and incorporate impedance balancing, allowing long cable runs to balanced amplifiers and other equipment.

HEADPHONES

The PHONES output is a 3-pole 'A' gauge jack, wired as a stereo output as shown, suitable for headphones of 200Ω or greater. 8Ω headphones are not recommended.

POLARITY

You will probably be familiar with the concept of polarity in electrical signals and this is of particular importance to balanced audio signals. Just as a balanced signal is highly effective at cancelling out unwanted interference, so two microphones picking up the same signal can cancel out, or cause serious degradation of the signal if one of the cables has the +ve and -ve wires reversed. This phase reversal can be a real problem when microphones are close together and you should therefore take care always to connect pins correctly when wiring audio cables.

GROUNDING AND SHIELDING

For optimum performance it is vital that all signals are referenced to a solid, noise-free earthing point and that all signal cables have their screens connected to ground. To avoid earth 'loops', use balanced connections where possible and ensure that all cable screens and other signal earths are connected to ground only at their source and not at both ends.

If the use of unbalanced connections is unavoidable, you can minimise noise by following these wiring guidelines:

- On INPUTS, unbalance at the source and use a twin, screened cable as though it were balanced.
- On OUTPUTS, connect the signal to the +ve output pin, and the ground of the output device to -ve. If a twin screened cable is used, connect the screen only at the mixer end.
- Avoid running audio cables or placing audio equipment, close to thyristor dimmer units or power cables.
- Noise immunity is improved significantly by the use of low impedance sources, such as good quality professional microphones or the outputs from most modern audio equipment. Avoid cheaper high impedance microphones, which may suffer from interference over long cable runs, even with well-made cables.

FAULT FINDING GUIDE

Repairing a sound mixing console requires specialist skills, but basic Fault Finding is within the scope of any user if a few basic rules are followed.

- Get to know the Block Diagram of your console (see page 27). It is just like following a road map.

The Block Diagram is a representative sketch of all the components of the console, showing how they connect together and how the signal flows through the system. Once you have become familiar with the various component blocks, you will find the Block Diagram quite easy to follow and you will have gained a valuable understanding of the internal structure of the console.

- Get to know what each component in the system is supposed to do.

Each Component has a specific function and only by getting to know what each part is supposed to do will you be able to tell if there is a genuine fault! Many `faults' are the result of incorrect connection or control settings which may have been overlooked.

- Learn where to look for common trouble spots.

Basic Troubleshooting is a process of applying logical thought to the signal path through the console and tracking down the problem by elimination.

- Swap input connections to check that the source is really present. Check both Mic and Line inputs.
- Eliminate sections of the channel by using the insert point to re-route the signal to other inputs that are known to be working.
- Route channels to different outputs or to auxiliary sends to identify problems on the Master section.
- Compare a suspect channel with an adjacent channel which has been set up identically. Use PFL and AFL to monitor the signal in each section.
- If all else fails, call your local dealer for technical assistance.

GETTING TO KNOW YOUR CONSOLE

INPUT CHANNEL

Two inputs are available to the mono input channel, via XLR connector (normally for microphone sources) or 3-pole 1/4" 'A' gauge jack socket for higher level signals such as keyboards, drum machines, synths or tape machines. Both input sockets are permanently active, and may be used simply by plugging the source into the required input. You do not need to unplug anything in the MIC socket if you want to use the LINE input. The new UltraMic+™ input provides very wide gain control without the need for a pad, high CMRR and +28dBu input capability. +48V phantom powering may be applied to the MIC input sockets for condenser microphones, and this is switched globally by the +48V switch on the Master section. Transformer-coupled dynamic microphones may be used without causing damage, even when the +48V power is turned on, but care must be taken when using unbalanced sources, because of the voltage present on pins 2 and 3 of the XLR connector.

NOTE: Phantom powered mics should not be plugged in with the +48V switched on. Plug in, THEN switch on. Also you should be aware that some microphones draw an unusually large current which may overload the power supply, resulting in distortion. Consult your microphone supplier for guidance if necessary.

An unbalanced INSERT is provided which is a break point in the input channel signal path. It allows the signal to be taken out of the mixer, through an external piece of equipment and then back into the mixer to continue through to the final output. The Insert is a 3-pole 1/4" 'A' gauge Jack Socket, which is normally by-passed. When a jack plug is inserted, the signal path is broken at a point just after the Hi-Pass Filter, but before the EQ section. The signal from the channel appears on the TIP of the plug and is returned on the RING. The insert point allows limiters, compressors and other signal processing units to be added as required to particular input channels and because it is located PRE EQ, noise generated by the external equipment may be reduced by a small amount of H.F. cut in the Equaliser. 'Y' cables are required for connection to and from insert points / limiters, compressors etc.

1 INPUT SENSITIVITY

This knob sets how much of the source signal is sent to the rest of the mixer. Too high and the signal will distort as it overloads the channel (shown by illumination of the PEAK LED), and causes clipping. Too low, and the level of any background hiss will be more noticeable and you may not be able to get enough signal level to the output of the mixer. Set the knob fully anticlockwise as a preliminary position for LINE level sources.

2 HI-PASS FILTER

Pressing this switch inserts a 18dB per octave 100Hz Hi-Pass Filter in the signal path, immediately after the input amplifier. This is particularly useful in live PA situations to reduce stage rumble or 'popping', and its use is strongly recommended, even on male vocals. It can also be used for filtering out low frequency hum.

3 EQUALISER

The Equaliser(EQ) comprises four sections. The upper control provides H.F.(treble) boost and cut of +/-15dB and the lower control provides L.F. (bass) boost and cut of +/-15dB.

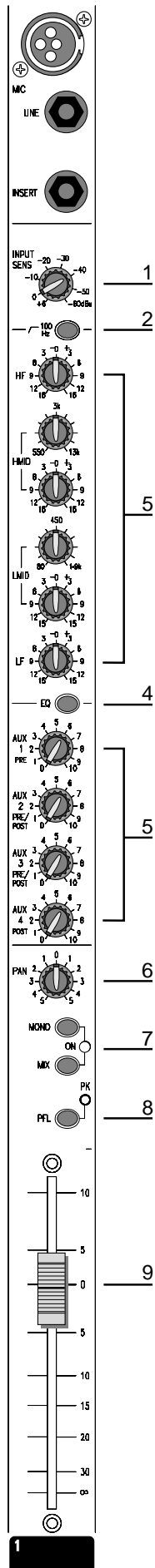

The centre two pairs of knobs are arranged as HI MID and LO MID frequency sections, with a cut/boost control (lower knob) of +/- 15dB, and a SWEEP(frequency) control which determines at which frequency the boost/cut action will be centered. These MID sections, with a combined frequency range from 75Hz to 15kHz are particularly versatile for vocals, enabling particular characteristics of the singer to be lifted or suppressed very precisely.

Set the cut/boost control of each section to the centre-detented position when not required.

4 EQ SWITCH

The EQ switch bypasses the Equalisation section when released. Alternately pressing and releasing the switch provides an easy way of comparing the equalised and unequalised signals.

5 AUXILIARY SENDS

These controls route the input channel signal to any one or more Auxiliary busses. These are separate from the main outputs and can therefore provide additional outputs for foldback, echo units or extra loudspeaker 'fills'.

AUX 1 is normally derived after the EQ section and channel fader (PRE-FADE, POST-EQ), and is therefore unaffected by the fader position and routing status. This makes the send particularly suitable for foldback or monitor feeds, which need to be controlled separately from the main P.A. mix. All pre-fade sends (see also Aux 2 & 3 below) may be selected internally to be PRE-FADE, PRE-EQ.

AUX 2, 3 and 4 are normally derived after the EQ and channel fader (POST FADE, POST EQ), and therefore follow any changes in fader level. They are normally used to drive effects processing units which are fed back into the mixer and which must fade out with the input channel.

AUX 2 and 3 may be altered globally to be PRE FADE, PRE EQ by pressing the AUX 2 PRE and AUX 3 PRE switches on the Master section. The pre-fade source on each channel may be selected internally to be POST-EQ if required.

All of the post-fade Aux Sends are muted when neither MIX or MONO routing switch is pressed.

6 PAN

The PAN control determines the position of the signal within the stereo mix image. Rotation fully anticlockwise feeds the signal solely to the Left mix bus, while rotation clockwise sweeps the image to the Right.

7 ROUTING SWITCHES

The input channel signal may be routed to the main Stereo MIX (subject to the position of the PAN control) or MONO by pressing the respective switches. If either or both switches are pressed, the ON LED illuminates to show that the channel is contributing to the output and that any Auxiliary Send is potentially active.

8 PFL/PEAK

When the PFL switch is pressed, the Pre-Fade signal is fed to the headphones and L & R meters, where it replaces the normal Mix L/R or Mono signal. The PFL/AFL ON LED on the Master section illuminates to warn that the headphones and the meters are now responding to the PFL/AFL selection and the PFL LED on the input channel lights to identify the active channel. This is a useful way of listening to any required input signal without interrupting the main mix, for making adjustments or tracing problems.

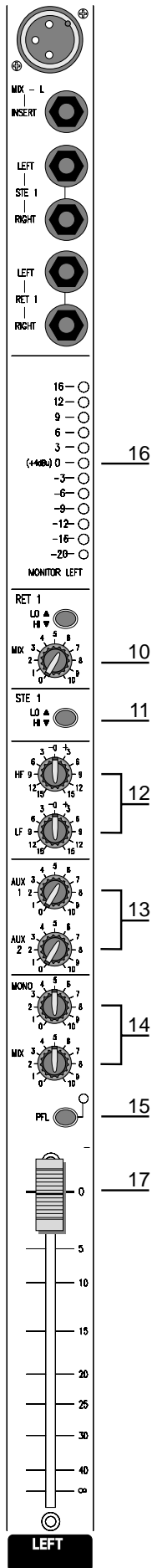

When the PFL switch is released the LED on the channel serves as a PEAK indicator, to warn when an excessively high signal level is present in the channel. The signal is sampled at three points in the channel, immediately after the Hi-Pass Filter (PRE-INSERT), PRE-EQ and POST-EQ. The Peak LED will illuminate approximately 4dB before clipping and therefore give warning of a possible overload even if the peaks are removed by external equipment plugged into the Insert.

9 FADER

This 100mm long-throw fader determines the proportion of the channel in the mix and provides a clear visual indication of channel level. Normal operating position is at the '0' mark, providing 10dB of gain above that point if required.

STEREO INPUTS/RETURNS

10 STEREO RETURNS

Two STEREO RETURNS are provided to allow external equipment to be returned to the mixer and routed to the stereo Mix without using up valuable input channels. These are an ideal way of mixing in the output of a reverb or effects unit, additional keyboards or the output of other consoles used as sub-mixers. A mono return signal may be plugged into the Left socket only of each pair to be fed equally to Left and Right busses. The knobs should be turned fully anticlockwise when not required.

STEREO INPUTS

11 LO/HI

The LO/HI switch provides two input sensitivities. The LO setting (switch released) should be selected for +4dBu professional equipment, and the HI setting (switch pressed) should be selected for -10dBV semi-professional equipment. Start with the LO setting if the source level is unknown.

12 EQUALISER

The Equaliser section has HF and LF shelving controls.

Turn the HF knob to the right to boost high (treble) frequencies by up to 15dB, adding crispness to percussion from drum machines, synths and electronic instruments. Turn to the left to cut these frequencies, reducing hiss or excessive brilliance.

Turn the LF knob to the right to boost low (bass) frequencies by up to 15dB, adding extra punch to synths, guitars and drums. Turn to the left to reduce hum, boominess or improve a mushy sound.

Set both knobs in the centre-detented position when not required.

13 AUXILIARY SENDS

These controls route a mono sum of the input channel signal to Auxiliary busses 1 & 2. These are separate from the main outputs and can therefore provide additional outputs for foldback, echo units or extra loudspeaker 'fills'.

The sends are always derived before the MIX or MONO controls and are not affected by the position of those controls or the Master section AUX 2 PRE switch. This makes them particularly suitable for foldback or monitor feeds, which need to be controlled separately from the main P.A. mix.

14 MIX, MONO

These controls set the level of the signal in stereo to MIX or as a mono sum to MONO. The knobs should be turned fully anticlockwise when not required.

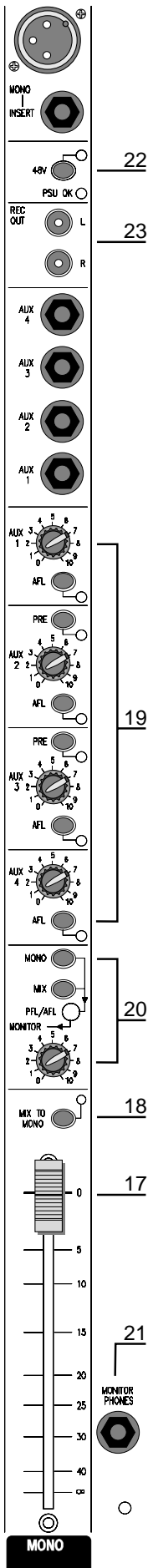

15 PFL

When the PFL switch is pressed, a mono sum of the pre-fade signal is fed to the headphones and L & R meters, where it replaces the normal Mix L/R or Mono signal. The PFL/AFL ON LED on the master section illuminates to warn that the headphones and the meters are now responding to the PFL/AFL selection and the PFL LED on the input section lights to identify the active channel. This is a useful way of listening to any required input signal without interrupting the main mix, for making adjustments or tracing problems.

MASTER SECTION

16 BARGRAPH METERS

Two 12-segment, three-colour peak-reading bargraph meters provide visual monitoring of the levels of the Mix Left and Right, Mono or PFL/AFL signals.

The meters follow the source selection for the Phones (Mono, Mix or both). If any PFL or AFL switch is activated the meters are switched to display the level of the selected PFL or AFL signal.

17 MIX, MONO FADERS

The MIX and MONO Faders set the final level of the Mix and Mono outputs. Unity gain is at the top of their travel.

Pre-fade INSERTS are provided for connection of external processing equipment (e.g. Graphic EQ) if required.

18 MIX TO MONO

This switch routes the Left and Right Mix outputs to the Mono bus, allowing the stereo bus to be used as two mono subgroups mixed down to a single output when stereo is not required.

This facility is also a quick method of using the Mono bus to restore the output if a fault occurs on external equipment (perhaps the power amplifiers or speakers) fed from the stereo output of the mixer, or for reinforcing the stereo mix in the centre cluster of large sound systems where the distance between left and right loudspeakers is considerable.

19 AUXILIARY MASTERS

Each of the Auxiliary Send busses is provided with a rotary MASTER LEVEL fader and an AFL switch with indicating LED which monitors the final output *after* the fader.

AUX 2 and AUX 3 normally receive post-fade sends from the input channels, but may be switched to pre-fade by pressing the respective PRE switch.

20 HEADPHONE MONITORING

The source for the headphones output may be either the stereo Mix or Mono outputs or both, as selected by these switches. The meters also display the selected source.

When any PFL or AFL switch is pressed the selected signal replaces the normal source for the headphones and meters, allowing the signal to be monitored in isolation. The PFL LED illuminates to show that a PFL or AFL is active.

The PHONES control sets the level to the Phones jack.

21 PHONES JACK

The PHONES output is a 3-pole 'A' gauge jack, suitable for headphones of 200Ω or greater. 8Ω headphones are not recommended.

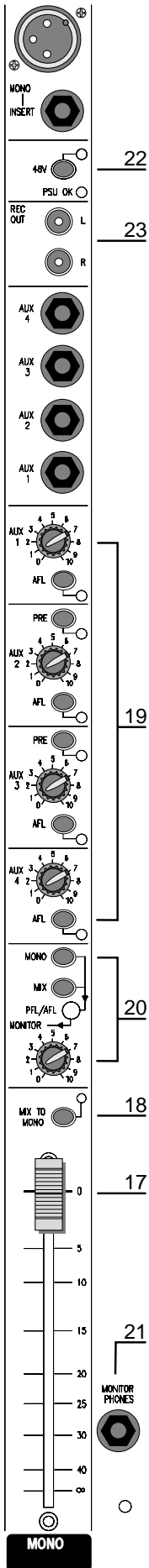

22 +48V & PSU MONITOR

The +48V switch with its associated LED applies phantom powering to all of the microphone XLR sockets on the input channels.

NOTE: Phantom powered mics should not be plugged in with the +48V switched on. Also you should be aware that some microphones draw an unusually large current which may overload the power supply, resulting in distortion. Consult your microphone supplier for guidance if necessary.

The PSU OK LED monitors the voltage from the power supply to give failure warning, and will be illuminated under normal circumstances.

23 RECORD OUT

A pair of RCA phono jacks provide a -20dBV output of the stereo Mix and Mono output for recording. The Mono output may be excluded from the Record Out signal by repositioning internal jumpers if required.

USING YOUR SPIRIT LIVE 3² CONSOLE

The final sound from your P.A. system can only ever be as good as the weakest link in the chain, and especially important is the quality of the source signal because this is the starting point of the chain. Just as you need to become familiar with the control functions of your mixer, so you must recognise the importance of correct choice of inputs, microphone placement and input channel settings. However, no amount of careful setting up can take account of the spontaneity and unpredictability of live performance and the mixer must be set up to provide 'spare' control range to compensate for changing microphone position and the absorption effect of a large audience (different acoustic characteristics from sound check to show).

MICROPHONE PLACEMENT

Careful microphone placement and the choice of a suitable type of microphone for the job is one of the essentials of successful sound reinforcement. The aim should be to place the microphone as close as physically possible to the source, to cut out unwanted surrounding sounds, allowing a lower gain setting on the mixer and thereby avoiding feedback. Also, a well-chosen and well-placed microphone should not need any appreciable equalisation.

There are no exact rules - let your ears be the judge. In the end, the position that gives the desired effect is the correct position!

INITIAL SET UP

Once you have connected up your system (see the sections on connection and wiring earlier in this manual for guidance) you are ready to set initial positions for the controls on your mixer.

The front panel drawing inside the rear cover shows typical initial control positions which may be found a useful guide to setting up the mixer for the first time.

The diagram on page 3 demonstrated how the matching of input gain to the signal source was crucial to avoid distortion (at one extreme) and excessive noise (at the other). Set up individual input channels as follows:

- **Connect your sources** (microphone, keyboard etc.) to the required inputs.
Note: Phantom powered mics should be connected before the +48V is switched on. Route the channel to Mix.
- **Set Master faders at 0***, input faders at 0*, and set power amplifier levels to about 70%.
- **Provide a typical performance level signal** and press the PFL button on the first channel, monitoring the level on the bargraph meters.
- **Adjust the input gain** until the meter display is in the amber section, with occasional peaks to the first red LED at a typical maximum source level. This allows sufficient headroom to accommodate peaks and establishes the maximum level for normal operation (but see note below).
- **Repeat this procedure on other channels** as required. As more channels are added to the mix, the meters may move into the red section. Adjust the overall level using the Master Faders if necessary.

* Note: 0 is the 'unity' level, not level with the fader right down. On SPIRIT consoles '0' or 'unity' is marked at or near the top of the fader travel.

- Listen carefully for the characteristic sound of 'feedback'. If you cannot achieve satisfactory input level setting without feedback, check microphone and speaker placement and repeat the exercise.

Note: The initial settings should only be regarded as a starting point for your mix. It is important to remember that many factors affect the sound during a live performance, for instance the size of the audience!

You are now ready to start building the mix and this should be done progressively, listening carefully for each component in the mix and watching the meters for any hint of overload. If this occurs, back off the appropriate Channel Fader slightly until the level is out of the red segments, or adjust the Master Fader.

NOTE:

The level of any source signal in the final output is affected by many factors, principally the Input Sensitivity control, Channel Fader and Output Faders. You should try to use only as much microphone gain as required to achieve a good balance between signals, with the faders set as described above. If the input gain is set too high, the channel fader will need to be pulled down too far in compensation to leave enough travel for successful mixing and there is a greater risk of feedback because small fader movements will have a very significant effect on output level. If the gain is set too low, you will not find enough gain on the faders to bring the signal up to an adequate level.

APPLICATION 1 - LIVE SOUND REINFORCEMENT

This drawing shows a typical configuration for sound reinforcement, with the main PA fed from Mix L/R and a separate voice cluster fed from the Mono output. The illustration shows the flexibility of the inputs to the mixer and how the Record Output and Stereo Return can be used to link to a cassette or tape machine. The Aux Sends are used for reverb (Aux 1, or 2 & 3 switched to PRE) and for artists foldback (Aux 4, or 2 & 3 switched to POST).

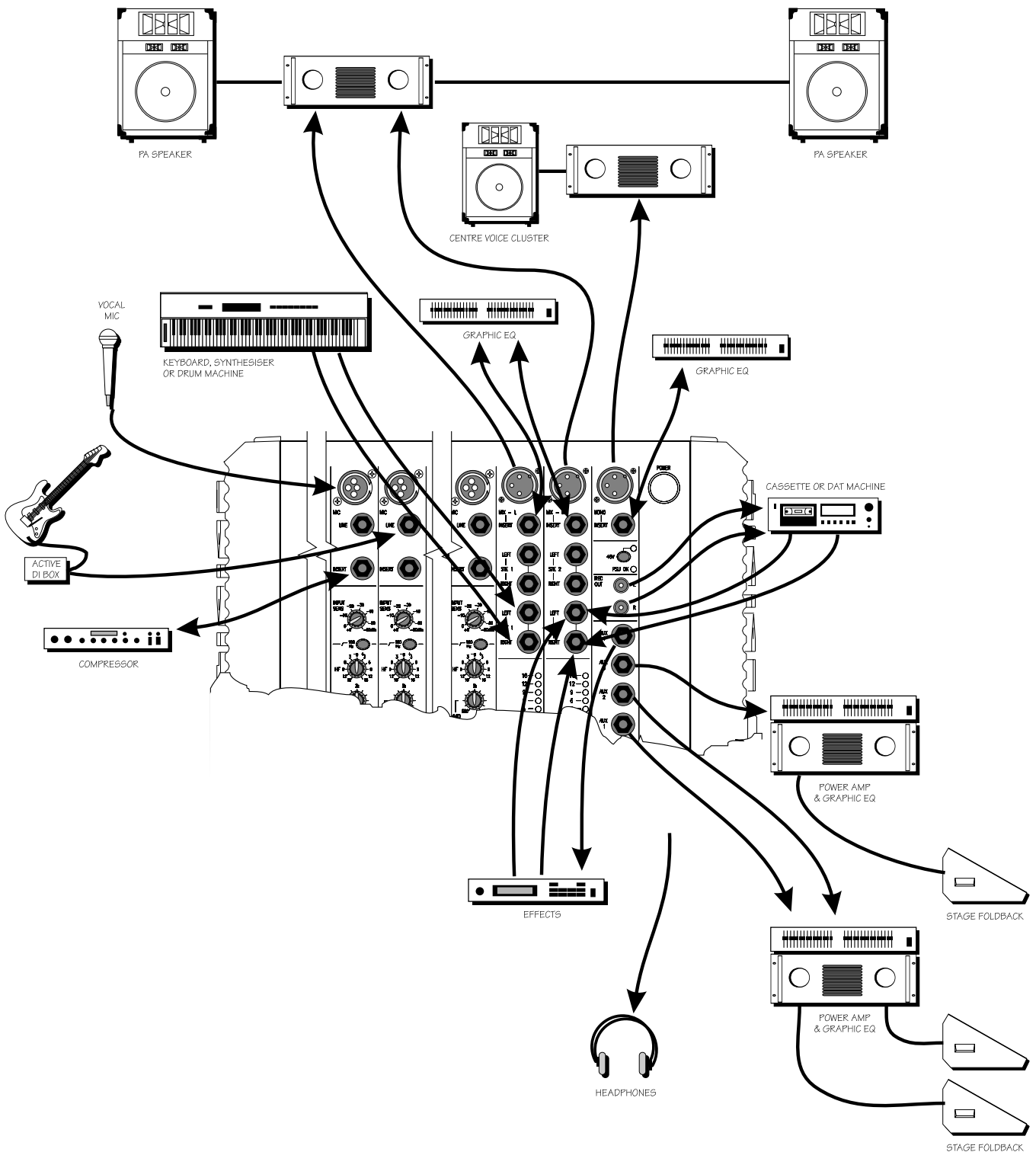

APPLICATION 2 - LIVE SOUND - MONO SYSTEM (E.G. CHURCH)

This configuration is similar to application 1, but is a mono system. In this configuration Mix Left and Mix Right are used as subgroups by pressing the MIX TO MONO switch. As an example, one group could contain a small band, while the other might contain a choir or vocals, and the Left and Right faders are then available to balance the mix to the Mono output. Aux sends 2-4 are used as mono feeds for foldback.

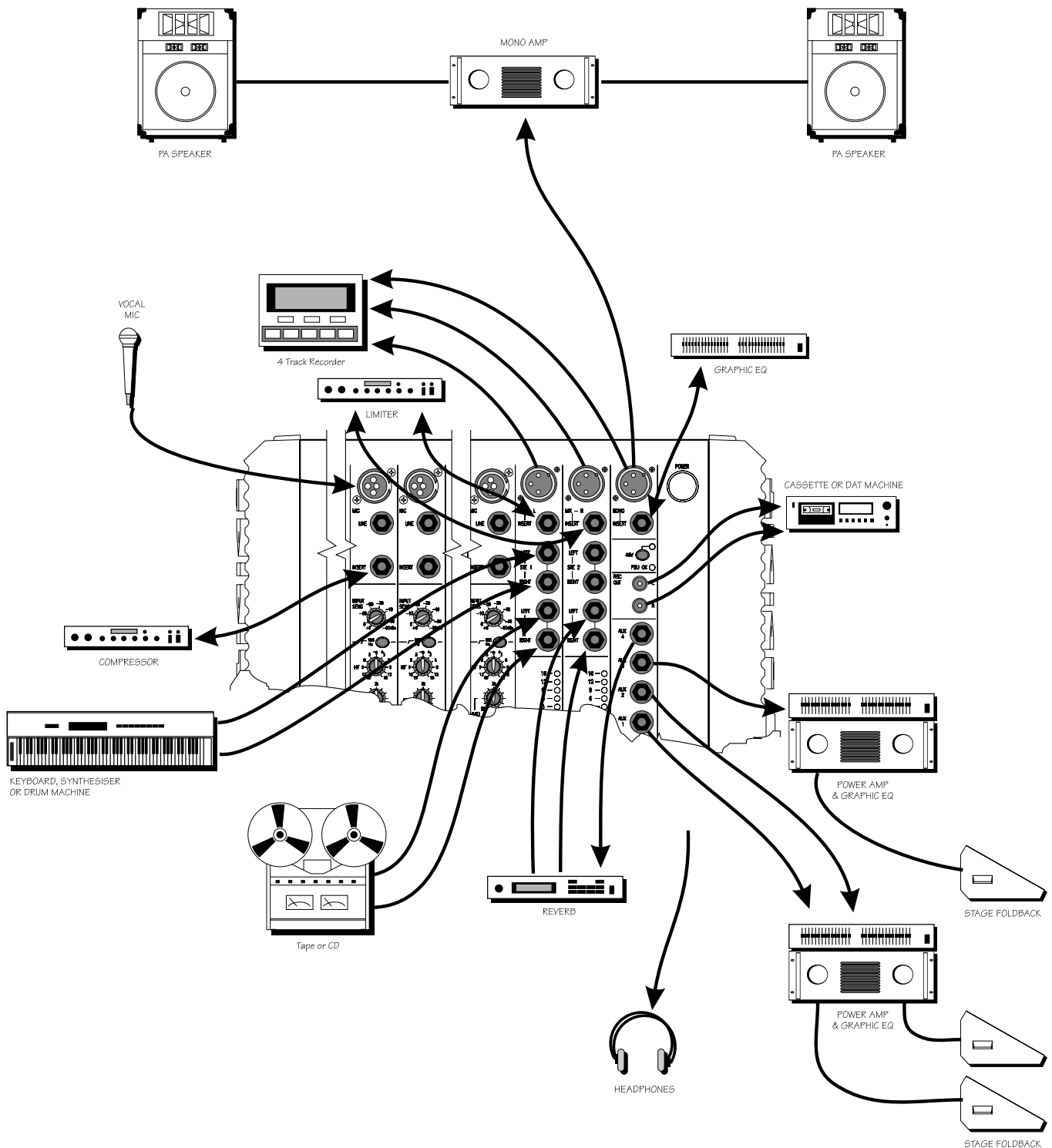

APPLICATION 3 - LIVE SOUND WITH MONO FILL

This is a similar set-up to Application 1, but with the Mono output used to drive a separate amplifier and speaker to provide a mono fill. This can be fed via a delay unit if required, depending on the position of the speakers.

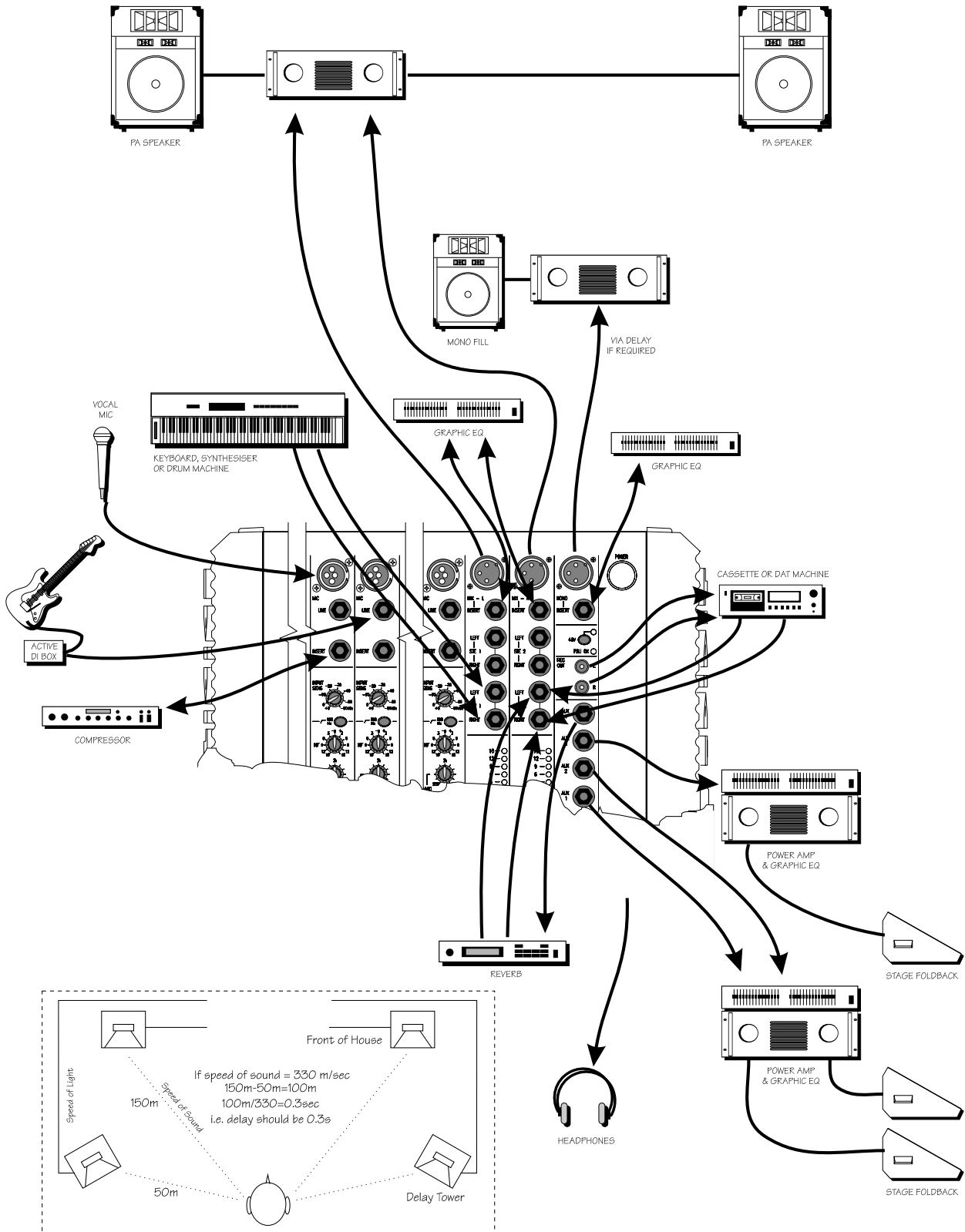

APPLICATION 4 - HOME RECORDING / BROADCAST

In this example the desk is used to provide a final mix for stereo recording (or FM radio broadcast), mono recording (or AM radio broadcast) or laying tracks on a multitrack recorder by tapping off the channel insert points. A separate back-up recording can be made using the Record Out sockets. Effects units may be connected via Aux 2-4 (switched to post-fade) and returned to the mix via the Stereo Returns or Effects Returns. Foldback can be provided from Aux 1 if required.

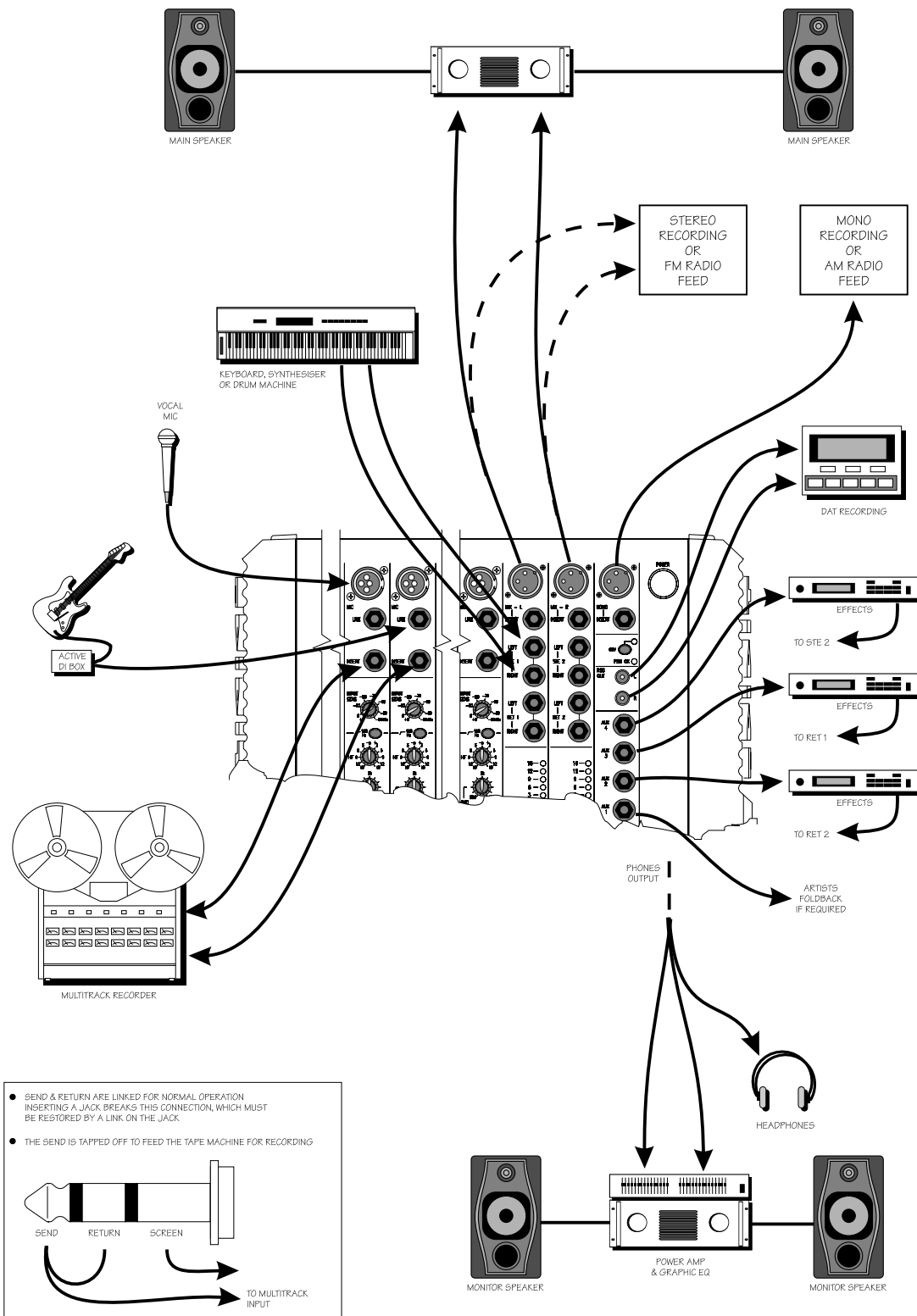

CARE OF YOUR MIXER

GENERAL PRECAUTIONS

- Avoid storing or using the mixer in conditions of excessive heat or cold, or in positions where it is likely to be subject to vibration, dust or moisture.
- Keep the mixer clean using a soft dry brush, and an occasional wipe with a damp cloth or ethyl alcohol. Do not use any other solvents which may cause damage to paint or plastic parts.
- Avoid placing drinks or smoking materials on or near the mixer. Sticky drinks and cigarette ash are frequent causes of damage to faders and switches.

Regular care and inspection will be rewarded by a long life and maximum reliability.

GLOSSARY

AFL (After Fade Listen)	a function that allows the operator to monitor the post-fade signal in a channel independently of the main mix.
auxiliary send	an output from the console comprising a mix of signals from channels and groups derived independently of the main stereo/group mixes. Typically the feeds to the mix are implemented on rotary level controls.
balance	the relative levels of the left and right channels of a stereo signal.
balanced	a method of audio connection which 'balances' the signal between two wires and a screen which carries no signal. Any interference is picked up equally by the two wires, but out of phase resulting in cancellation of the interference signal.
clipping	the onset of severe distortion in the signal path, usually caused by the peak signal voltage being limited by the circuit's power supply voltage.
DAT	Digital Audio Tape, a cassette-based digital recording format.
dB (decibel)	a ratio of two voltages or signal levels, expressed by the equation $dB = 20 \log_{10} (V_1/V_2)$. Adding the suffix 'u' denotes the ratio is relative to 0.775V RMS. Adding the suffix 'V' denotes the ratio is relative to 1V rms.
DI(direct injection)	the practice of connecting an electric musical instrument directly to the input of the mixing console, rather than to an amplifier and loudspeaker which is covered by a microphone feeding the console.
equaliser	a device that allows the boosting or cutting of selected bands of frequencies in the signal path.
fader	a linear control providing level adjustment
feedback	the 'howling' sound caused by bringing a microphone too close to a loudspeaker driven from its amplified signal.
foldback	a feed sent back to the artistes via loudspeakers or headphones to enable them to monitor the sounds they are producing.
frequency response	the variation in gain of a device with frequency.
gain/input sensitivity	the variation in level of the signal
(sub) group	an output into which a group of signals can be mixed.
headroom	the available signal range above the nominal level before clipping occurs.

highpass filter	a filter that rejects low frequencies.
impedance balancing	a technique used on unbalanced outputs to minimise the effect of hum and interference when connecting to external balanced inputs.
insert	a break point in the signal path to allow the connection of external devices, for instance signal processors or to another mixer. line level signals at a nominal level of -10 to +6dBu, usually coming from a low impedance source.
mute groups	a method of combining the on/off status of a selection of channels under a single control button.
pan (pot)	abbreviation of 'panorama': controls levels sent to left and right outputs.
peaking	an equaliser response curve affecting only a band of frequencies i.e. based on a bandpass response.
PFL (pre-fade listen)	a function that allows the operator to monitor the pre-fade signal in a channel independently of the main mix.
polarity	a term used to describe the orientation of the positive and negative poles of an audio connection. Normally connections are made with positive to positive, negative to negative and this would correct polarity. If this is reversed, the result will be out-of-phase signals (see 'phase' above).
post-fade	the point in the signal path after the monitor or master fader and therefore affected by fader position.
pre-fade	the point in the signal path before the monitor or master fader position and therefore unaffected by the fader position.
rolloff	a fall in gain at the extremes of the frequency response.
shelving	an equaliser response affecting all frequencies above or below the break frequency i.e. a highpass or lowpass derived response.
spill	acoustic interference from other sources.
stereo return	an input specifically designed to receive the output of effects or other external processing devices
talkback	the operator speaking to the artistes or to tape via the auxiliary or group outputs.
transient	a momentary rise in the signal level.
unbalanced	a method of audio connection which uses a single wire and the cable screen as the signal return. This method does not provide the noise immunity of a <i>balanced</i> input (see above)
+48V	the phantom power supply, available at the channel mic inputs, for condenser microphones and active DI boxes.

TYPICAL SPECIFICATIONS

NOISE

Measured RMS, 22Hz to 22kHz Bandwidth

Line inputs selected at unity gain and terminated 150R

MIX 16 ch. routed to Mix, input faders down, masters up - 85 dBu

AUX Output at max., input faders down - 90 dBu

E.I.N. Microphone Input, Maximum Gain, terminated 150R -129 dBu

CROSSTALK

@ 1kHz

Typical Channel Fader Attenuation > 84 dB

Typical Aux Attenuation > 80 dB

Typical Pan Isolation > 70 dB

Adjacent Channel Crosstalk > 90 dB

FREQUENCY RESPONSE

20Hz to 20kHz -1dB

T.H.D. -20dBu Input routed to Mix, +14dBu out @ 1kHz < 0.004%

C.M.R.R. Typical at max. gain @ 1 kHz - 85 dB

Typical at any gain @ 50 Hz - 65 dB

INPUT & OUTPUT IMPEDANCES

Microphone Input 1.8 k Ω

Line Input 10 k Ω

Stereo Input 10 k Ω

Stereo Return 10 k Ω

INPUT & OUTPUT LEVELS

Mic/.Line Input Maximum Level +28 dBu

Stereo Input, Stereo Return +26 dBu

Nominal Input for +4dBu at Mix Output, level at '7' +4 dBu (LO)

-10 dBV (HI)

Max. Mic Gain through longest path to Mix 74 dB

DIMENSIONS

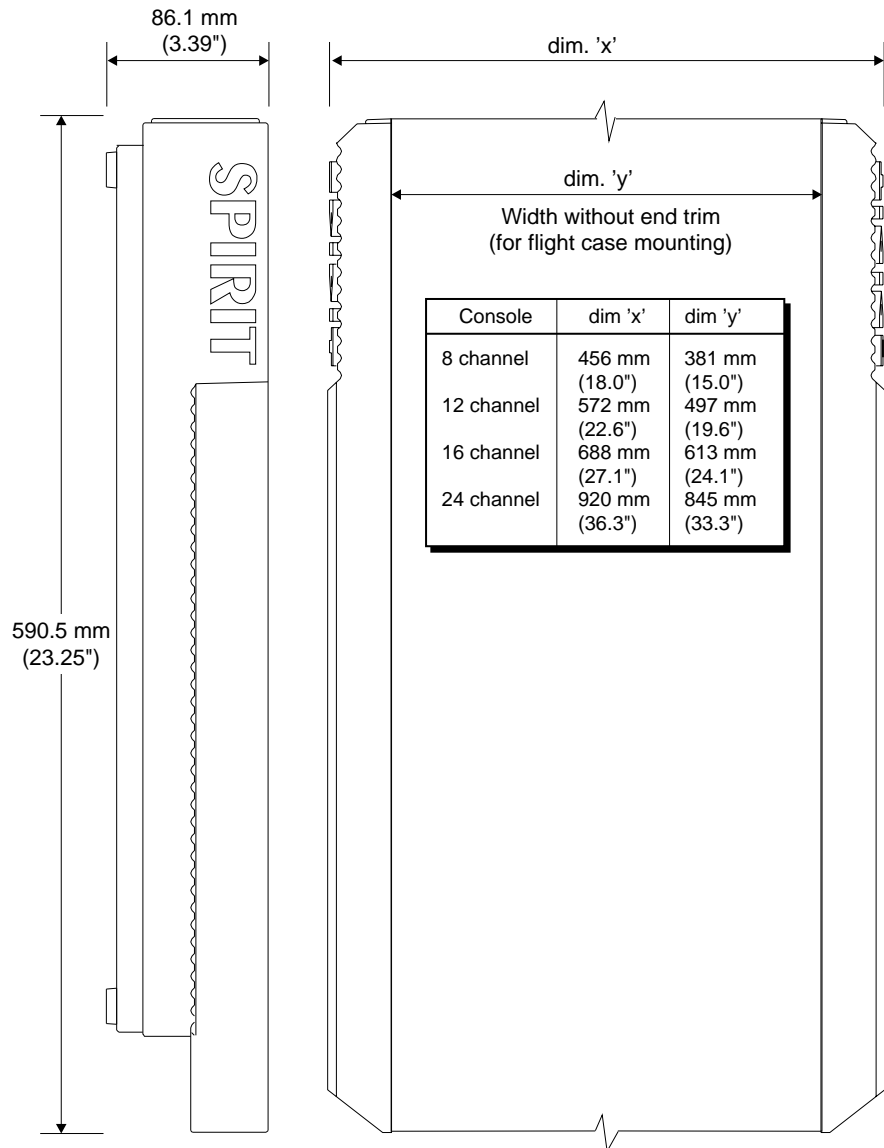

FLIGHT CASE MOUNTING

The console is ideal for flight case mounting, with all connectors on the top panel. The end cheeks may be removed to save space in the flight case if required. The example below shows a 16-channel console, flight case mounted together with the power supply and space for headphones or other accessories.

Refer to the Expander Installation Instructions on the next page for guidance on removing the side cheeks if required.

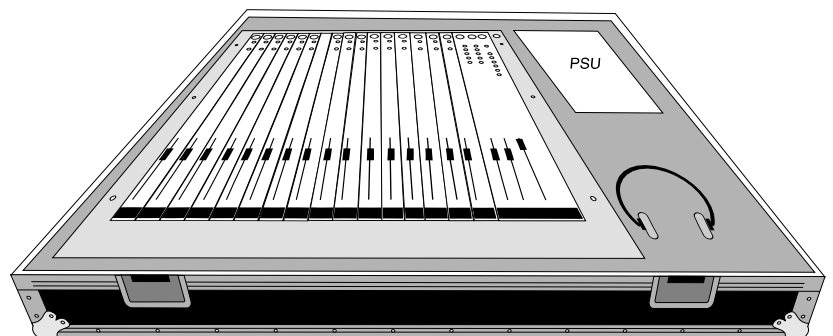

SPIRIT LIVE 3² EXPANDER

INSTALLATION INSTRUCTIONS

EQUIPMENT REQUIRED:

- Screwdriver: No. 1 Pozidriv
- Spanner: 5/16 AF Open (8mm.)
- Spanner: M4
- Nut spinner M3
- Spanner M3 (open)

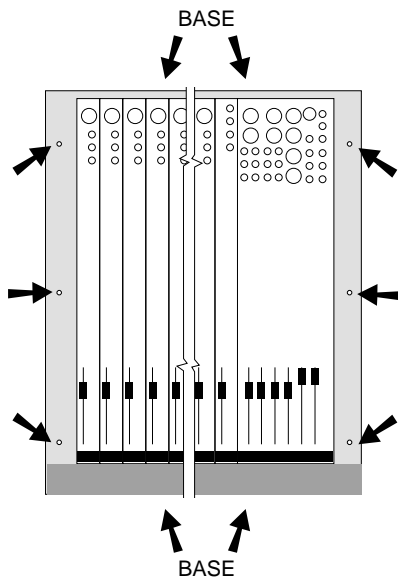

INSTALLATION KIT (PACKED WITH EXPANDER)

- 6 off M5 x 12 Pozidriv Screws (Part No. NA0159)
- 12 off M5 Flat Steel Washer (Part No. NC0216)
- 6 off M5 Nyloc Nut (Part No. NB0116)
- 1 off M3 Pozidriv Screw, Nyloc Nut and Washer

ASSEMBLY INSTRUCTIONS

1. Place the console on a flat clear surface, allowing plenty of space in which to work.
2. Undo the pozidriv screws on both the top and base of the Console and Expander. Keep all screws safely for reassembly.
3. Place the console base down with the faders towards you. Holding the top panel at the front, lift the panel upwards while sliding gently to the rear. Place the top panel face down on a flat surface. Repeat the operation on the Expander.
4. Using a screwdriver remove the screws securing the right-hand side cheek of the console chassis.
5. Fit the side cheek to the right-hand side of the Expander using the screws removed in stage 4.

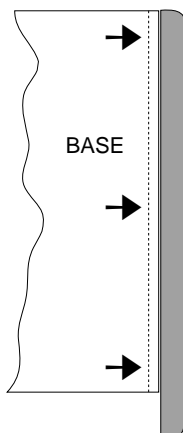
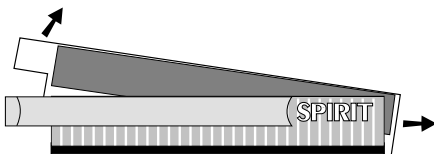

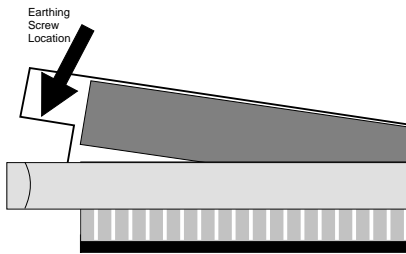

- Using the M3 screw, washer and nut provided, secure one end of the earth lead supplied to the screw hole on the left hand side of the Expander front panel, underneath the arm rest as shown. Ensure that any paint overspray is removed from the inside of the panel to provide a good electrical contact with the panel.

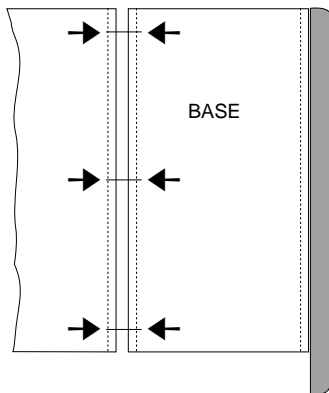

- Using the M5 screws, washers and nuts supplied, bolt the Expander chassis to the Console chassis as shown.

N.B. Ensure correct orientation and alignment.

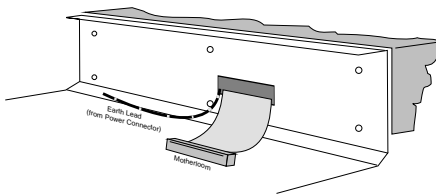

- Re-assemble the Expander top panel and base, gently sliding the units together as the panel is lowered and threading the Expander bus loom and earthing lead through the aperture into the console base.

- The Expander earthing lead must now be joined to the existing earthing point on the power connector on the main console top panel, which should be placed knobs down with the rear of the panel next to the rear of the chassis. Remove the securing nut and washer and reassemble with the expander earthing lead connected in contact with the existing earthing lead as shown opposite. Ensure that the nut is tightened securely.

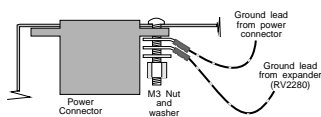

- Rotate the main console top panel backwards and reassemble to the base, taking care not to strain the earthing lead and connecting the bus loom from the Expander onto the track-side pins of the bus connector on the Console Master PCB as shown. Carefully adjust the position of the bus loom as the panel is lowered to ensure that the slack in the cable folds on the right-hand side of the Master PCB and does not become trapped between the boards and the base panel.

- To ensure good mechanical fit, some realignment can be carried out as the top and base panel screws are tightened.

N.B. Taking care with paintwork, use the correct tools, keep screws safely and the expansion of your SPIRIT LIVE 3² should take no longer than 15 minutes.

SYSTEM BLOCK DIAGRAM

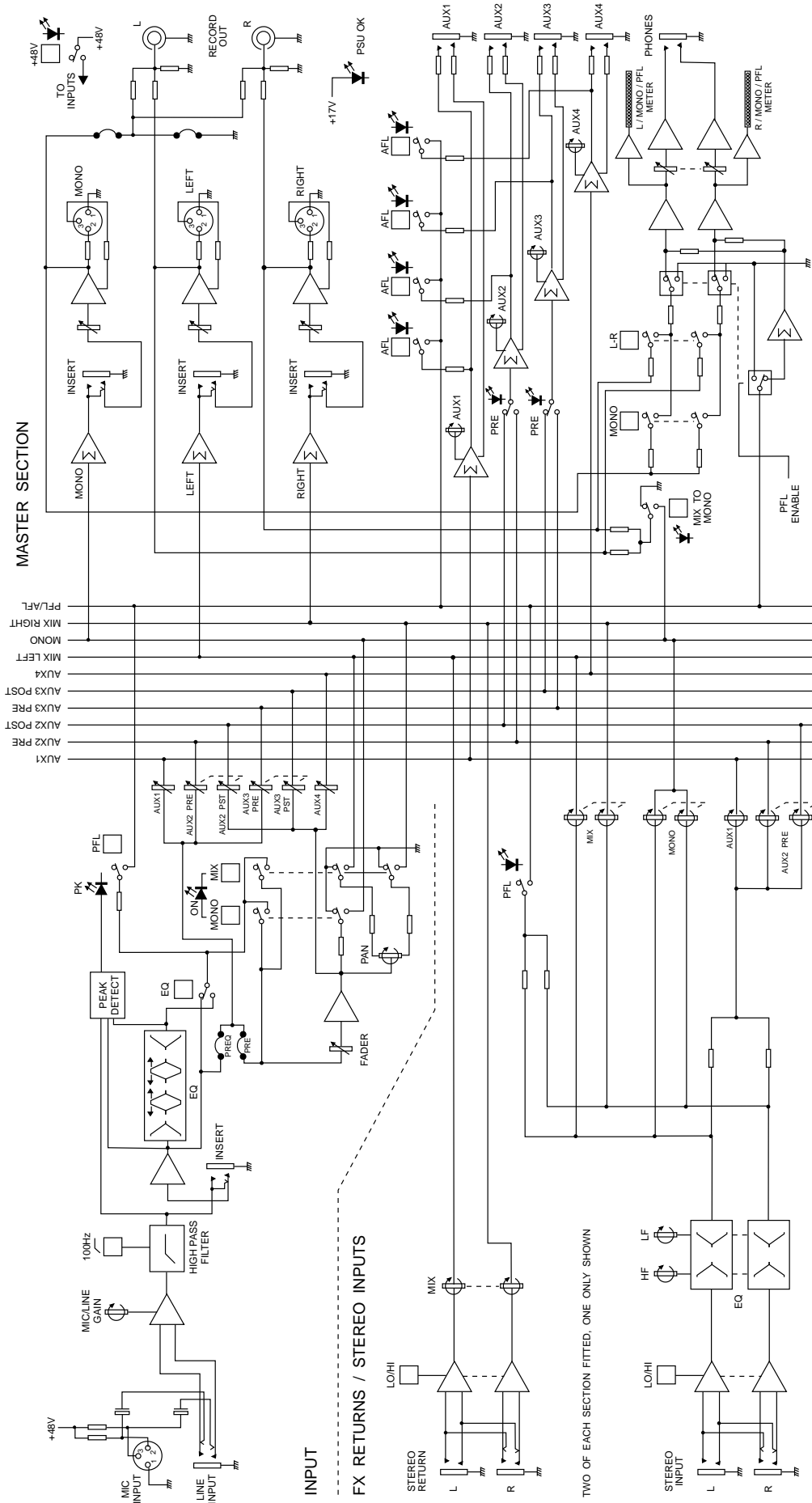

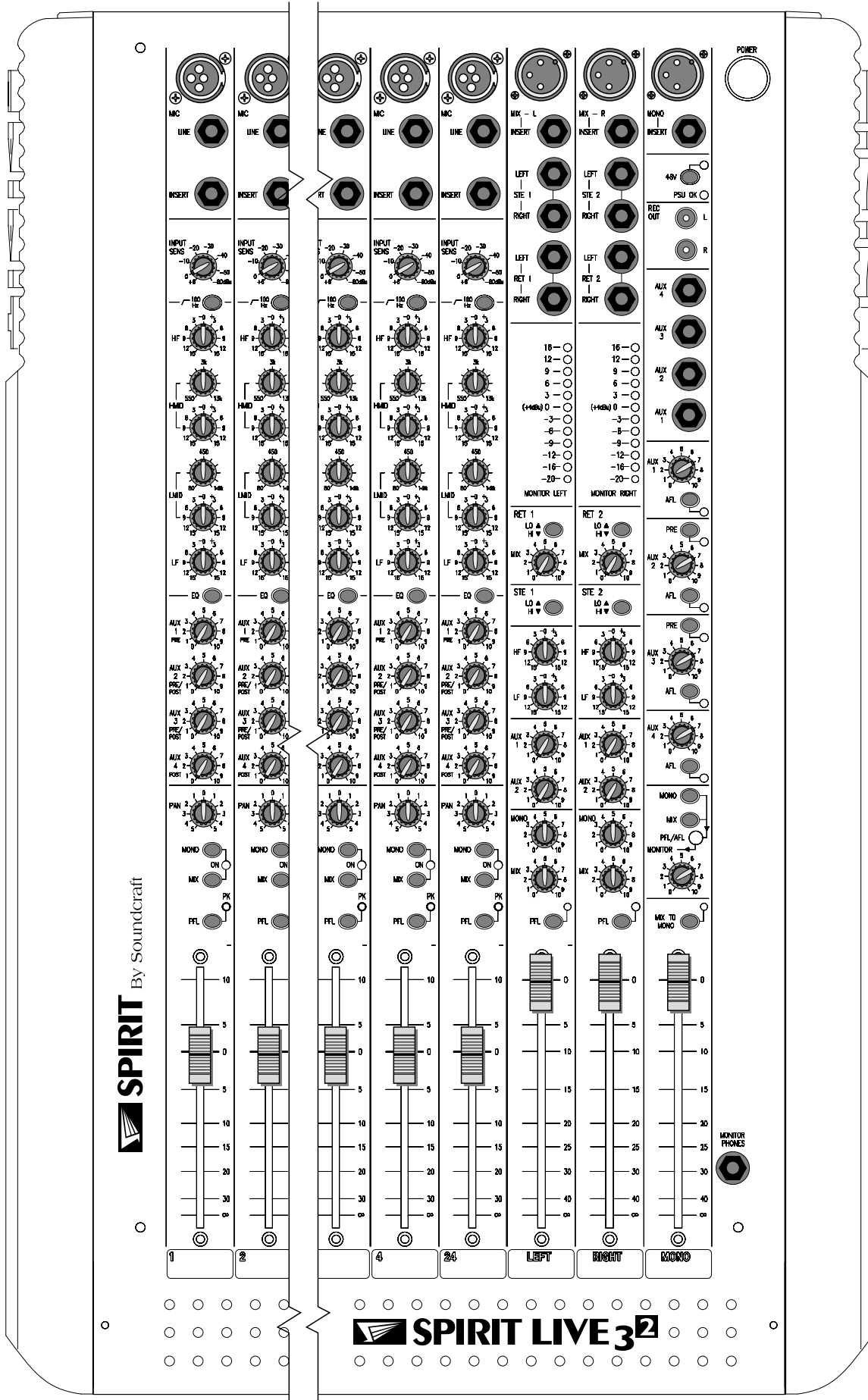

SPIRIT
 By Soundcraft

JUMPER SETTINGS

The settings for internal jumpers, as fitted in the factory, are as follows:

MONO INPUT (SC3611)

PEQ Not Fitted
PRE Fitted

OUTPUT/FX/STEREO (SC3612)

SUM L Fitted for LEFT Output
SUM R Fitted for RIGHT Output

MASTER (SC3613)

J1 Not Fitted
J2 Fitted (Mono On Record)



Spirit By Soundcraft™
Harman International Industries Ltd., Cranborne House, Cranborne Industrial Estate,
Cranborne Road, Potters Bar, Herts., EN6 7JN U.K.
Tel: +44 (0) 1707 665000 Fax: +44 (0) 1707 665461

H A Harman International Company

Part No: ZM0127

Free Manuals Download Website

<http://myh66.com>

<http://usermanuals.us>

<http://www.somanuals.com>

<http://www.4manuals.cc>

<http://www.manual-lib.com>

<http://www.404manual.com>

<http://www.luxmanual.com>

<http://aubethermostatmanual.com>

Golf course search by state

<http://golfingnear.com>

Email search by domain

<http://emailbydomain.com>

Auto manuals search

<http://auto.somanuals.com>

TV manuals search

<http://tv.somanuals.com>