

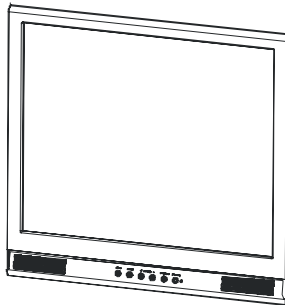

**VM-HT19LCD**  
**High Resolution 19" LCD MONITOR**

---

**USER MANUAL**



**Speco Technologies**

**200 New Highway**

**Amityville, NY 11701**

**800-645-5516 / *www.specotech.com***

**WARNING:**

TO REDUCE THE RISK OF FIRE OR ELECTRIC SHOCK, DO NOT EXPOSE THIS PRODUCT TO RAIN OR MOISTURE.

DO NOT INSERT ANY METALLIC OBJECT THROUGH VENTILATION GRILLS.

**CAUTION:**



**Explanation of Graphical Symbols**



The lightning flash with arrowhead symbol, within an equilateral triangle, is intended to alert the user to the presence of uninsulated "dangerous voltage" within the product's enclosure that may be of sufficient magnitude to constitute a risk of electric shock to persons.



The exclamation point within an equilateral triangle is intended to alert the user to the presence of important operating and maintenance (servicing) instructions in the literature accompanying the product.

# Important Information

## IMPORTANT SAFEGUARDS

### 1. READ INSTRUCTIONS

All the safety and operating instructions should be read before the unit is operated.

### 2. RETAIN INSTRUCTIONS

The safety and operating instructions should be retained for future reference.

### 3. HEED WARNINGS

All warnings on the unit and in the operating instructions should be adhered to.

### 4. FOLLOW INSTRUCTIONS

All operating and usage instructions should be followed.

### 5. CLEANING

Unplug this unit from the wall outlet before cleaning. Do not use liquid cleaners or aerosol cleaners. Clean only with a dry cloth.

### 6. ATTACHMENTS

The manufacturer of this unit does not make any recommendations for attachments, as they may cause hazards.

### 7. WATER AND MOISTURE

Do not use this unit near water. For example, near a bathtub, washbowl, kitchen sink, laundry tub, in a wet basement, or near a swimming pool.

### 8. ACCESSORIES

Do not place this unit on an unstable cart, stand, tripod, bracket, or table. The unit may fall, causing serious injury, and serious damage to the unit. An appliance and cart combination should be moved with care. Quick stops, excessive force, and uneven surfaces may cause the appliance and cart combination to overturn.

### 9. VENTILATION

Slots and openings at the rear cabinet and bottom are provided for ventilation, these are to ensure reliable operation of the unit, and to protect it from overheating. These openings must not be blocked or covered. The openings should never be blocked by placing the unit on a bed, sofa, rug, or other similar surface. This unit should never be placed near or over a radiator or heat source. This unit should not be placed in a built-in installation such as a bookcase or rack unless proper ventilation is provided or the manufacturer's instructions have been adhered to.

### 10. POWER SOURCE

This unit should be operated only from the type of power source indicated on the rating plate. If you are not sure of the type of power supply to your home, consult your appliance dealer or local power company.

### 11. POWER-CORD PROTECTION

Power-supply cords should be routed so that they are not likely to be walked on or pinched by items placed upon or against them, paying particular attention to cords at plugs, convenience receptacles, and the point where they exit from the appliance.

### 12. LIGHTNING

To protect your unit from a lightning storm, or when it is left unattended and unused for long periods of time, unplug it from the wall outlet and disconnect the antenna or cable system. This will prevent damage to the unit due to lightning and power line surges.

### 13. POWER LINES

An outside antenna system should not be located in the vicinity of overhead power lines or other electric light or power circuits, or where it can fall onto or against such power lines or circuits. When installing an outside antenna system, extreme care should be taken to keep from touching such power lines or circuits, as contact with them might be fatal.

### 14. OVERLOADING

Do not overload wall outlets and extension cords, as this can result in a risk of fire or electric shock.

### 15. OBJECT AND LIQUID ENTRY

Do not push objects through any openings in this unit, as they may touch dangerous voltage points or short out parts that could result in fire or electric shock. Never spill or spray any type of liquid into the unit.

### 16. HEAT

The product should be situated away from heat sources such as radiators, heat registers, stoves, or other products (including amplifiers) that produce heat.

### 17. CONNECTING

When you connect the product to other equipment, turn off the power and unplug all of the equipment from the wall outlet. Failure to do so may cause product damage. Read the owner's manual of the other equipment carefully and follow the instructions when making any connections.

### 18. LCD

Do not press on or jolt the LCD panel. Doing so may cause the LCD panel glass to break and injury may occur. Should the LCD panel be broken and liquid leaks out, do not inhale or swallow it. Doing so may cause poisoning. If you have got it into your mouth, wash it out and consult your doctor. If your hands or clothes have touched it, wipe them with alcohol and a cleaning cloth and then wash them well.

## Safety Precautions

### Federal Communications Commission (FCC) Statement

This Equipment has been tested and found to comply with the limits for a Class B digital device, pursuant to Part 15 of the FCC rules. These limits are designed to provide reasonable protection against harmful interference in a residential installation. This equipment generates, uses and can radiate radio frequency energy and, if not installed and used in accordance with the instructions, may cause harmful interference to radio communications. However, there is no guarantee that interference will not occur in a particular installation. If this equipment does cause harmful interference to radio or television reception, which can be determined by turning the equipment off and on, the user is encouraged to try to correct the interference by one or more of the following measures:

- Reorient or relocate the receiving antenna.
  - Increase the separation between the equipment and receiver.
  - Connect the equipment into an outlet on a circuit different from that to which the receiver is connected.
  - Consult the dealer or an experienced radio/TV technician for help.
- You are cautioned that changes or modifications not expressly approved by the party responsible for compliance could void your authority to operate the equipment.

This device complies with Part 15 FCC Rules. Operation is subject to the following two conditions:

- (1) This device may not cause harmful interference.
- (2) This device must accept any interference received including interference that may cause undesired operation

## Table of Contents

Warning.....	2
Important Information.....	3
Safety Precautions.....	4
Table of Contents.....	5
Components.....	5
Feature.....	6
Exploring Your New Monitor.....	7
Backside Connections.....	8
Selecting a Location for the Monitor.....	8
Connecting your Monitor.....	9
Connecting Device.....	10
Setup your Monitor.....	11
General Setup.....	12
Video Setup.....	13
VGA Setup.....	14
Audio Setup.....	14
PIP Setup.....	16
LCD Monitor Mounting Guide.....	17
Desktop.....	17
Mounting the monitor on the rack.....	17
Arm Mount (VESA standard).....	17
Troubleshooting.....	18
LCD Color Monitor Specifications.....	19
LCD Color Monitor Dimensions .....	20

### Components

(1) LCD Color Monitor	1
(2) Accessories	
(a) Power cord	1
(b) User Manual	1
(c) VGA Cable	1

## Features

- Professional TFT LCD for surveillance with multiple connections.
- Compatible with VGA(640X480), SVGA(800X600), XGA(1024X768), SXGA(1280X1024) resolution,
- Picture-In-Picture feature that allow multi-picture display
- High brightness level and contrast ration with super wide viewing angle
- Built-in 3D comb filter and 3D de-interlace for crispy picture performance
- Fast response time and refresh rate without time lagging.
- Provides 6500K and 9300K color temperature selection for user's preference
- Video inputs support NTSC / PAL standards
- Provides Key Lock and power memory function for easy management
- CCD mode control that enable auto-adjust incoming video signal level
- Video looping output supports 75 ohm auto termination
- Support audio and live-out function with stereo phone jack output
- VESA standards (100mm X 100mm) bracket
- Optional rack mount bracket for 19" rack console

# Exploring Your New Monitor

You can operate your monitor by using the buttons on the front panel. The side panels provide the inputs to connect other equipment to your monitor.

## Front Panel

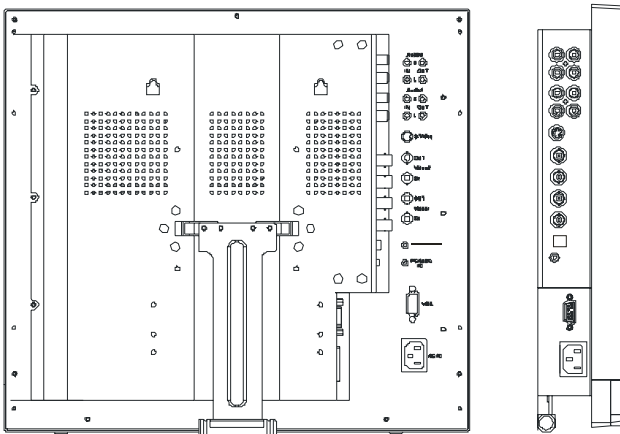
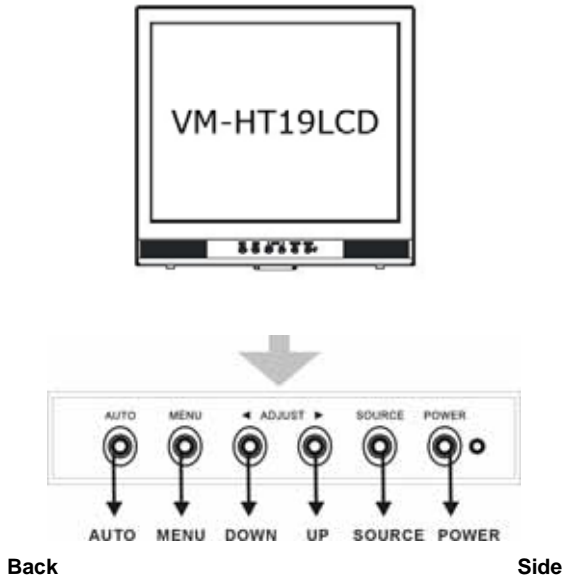

# Rear Connections

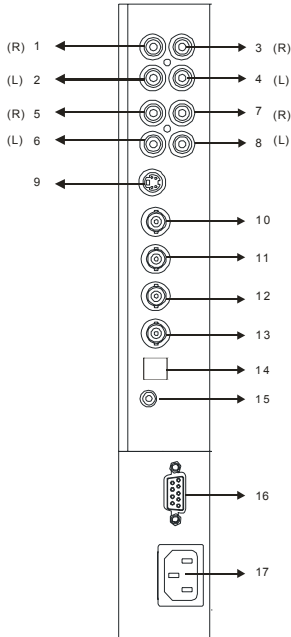

- 1, 2 AUDIO 2 IN (R, L)**  
Stereo Audio Signal Input, this input is for AV2 (Refer to Note below)
- 3, 4 AUDIO 2 OUT (R, L)**  
Audio looping outputs for AUDIO 2
- 5, 6 AUDIO 1 IN (R, L)**  
Stereo Audio Signal Input, this input is for AV1 or S-Video (Refer to Note below)
- 7, 8 AUDIO 1 OUT (R, L)**  
Audio looping outputs for AUDIO 1
- 9 S-VIDEO IN**  
Y/C separated signal input
- 10 VIDEO 2 OUT**  
Video looping output for VIDEO 2
- 11 VIDEO 2 IN**  
Composite signal Input for VIDEO 2
- 12 VIDEO 1 OUT**  
Video looping output for VIDEO 1
- 13 VIDEO 1 IN**  
Composite signal Input for VIDEO 1
- 14 DC 12V OUT DC OUTPUT**  
DC 12V / 500mA power output (Supporting for PVM unit)
- 15. PC AUDIO IN**
- 16 VGA IN**
- 17. AC POWER SOCKET**  
AC100V~240V Input

**Note: Connections of Audio**

	Audio 1	Audio 2	PC Audio
PC			▼
AV1	▼		
AV2		▼	
S-Video	▼		



## Connecting your Monitor

If you don't have experience in electronic equipment connection before, you may wish to read this section. (Cables are not supplied, just for reference)

- Audio cables are usually color coded according to use: red and white for audio. The red audio cable is for the stereo right channel, and the white audio cable is for the stereo left (or mono) channel. If you look at the rear panel of the Monitor, you will see that the terminals are color coded in the same manner as the cables.
- S-video cables provide better picture performance than standard video cables. S-video cables can only be used with S-video compatible components.
- **BNC cable provides better connection and picture performance.**

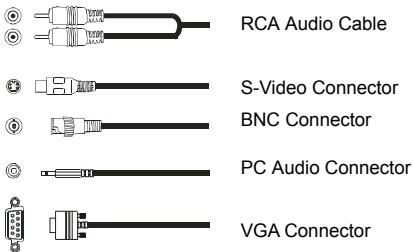

### NOTE:

To prevent equipment damage,  
Do not plug in any power cords until you have  
finished connecting all equipment.

# Connecting Accessories

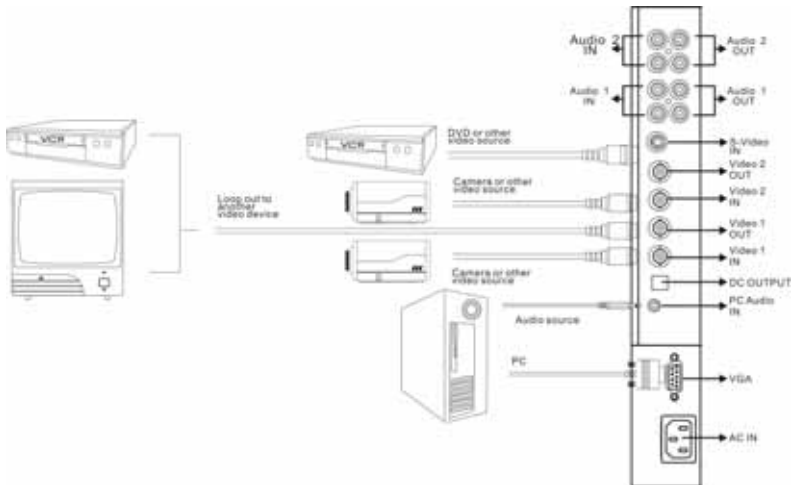

- Connect PC to Monitor through VGA connector as shown on the above picture
- Connect External device such as DVD or Game Player to Monitor as shown on the above picture
- Connect CCD Camera 1 and 2 to Monitor through Video Input 1 and 2 (BNC Connector) as showing on the above picture
- Support Resolution

## Setup your Monitor

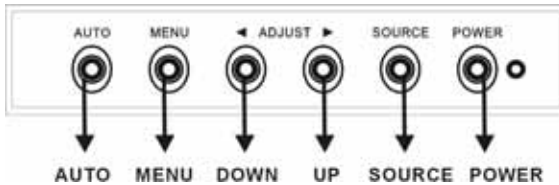

**AUTO:** Auto-optimize displaying picture under PC mode.  
**Enter:** This "Auto" Button can be either "Enter" function in OSD Menu)  
**CCD Mode:** Under AV/1 / AV2 / S-Video press **Auto** can be changed to CCD/Video mode toggle.

**MENU:** OSD menu ON / OFF control.  
(EXIT Item)

**ADJUST:** Increase or decrease the value on OSD menu.  
▶ **Up:** Increase value or turn ON / OFF function.  
◀ **Down:** Decrease value or turn ON / OFF function

**SOURCE:** Select input signal from AV1, AV2, S-Video or VGA (PC).

**POWER:** Monitor power ON / OFF. At OFF mode, monitor will be at standby status.  
**Green Light:** ON Mode  
**Orange Light:** Power Saving (Refer to not below)  
**Red Light:** OFF Mode

- Note:**
1. **AV1, AV2, S-Video:** When there is no input signal, LCD monitor will into Power Saving mode after 60 seconds.
  2. **VGA:** When there is no input signal, LCD monitor will into power saving mode after 5 seconds.
  3. **PIP:** When there is no signal on both input sources, LCD monitor will into Power Saving mode after 120 seconds.

## General Setup

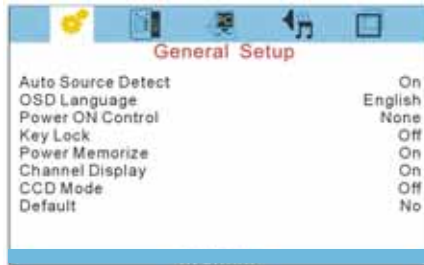

- Auto Source Detect :** The monitor will auto detect the video source when power ON.
- OSD Language :** Multi-Language selection in English.
- Power ON Control :** This function is to assign a specific video signal when power ON.
- Key Lock :** The Key-Lock function is provided to prevent tempering.  
To release key lock function press **AUTO** and **DOWN**
- Power Memorize :** This function enables the monitor to memorize the previous power status before power break.
- Channel Display :** This function is to allow the channel title to be displayed on the monitor.
- CCD Mode:** If video signal source directly comes from CCD camera, using CCD Mode is suggested to obtain better picture performance.
- Default :** Return to factory default value.

## Video Setup



- Brightness :** Adjusts the overall picture shade and brightness.
- Contrast :** Permits adjustment of contrast between light and dark areas of the picture.
- Color :** Adds coloring to the black and white picture content (of a color signal), and is usually set for viewer's preference in color saturation.
- TINT :** Adjusts all the colors on the screen, but is most noticeable to the eye in reds and yellows, and is also usually set for pleasing face tones.
- Sharpness :** Sets the desired sharpening enhancement to the picture.
- Color Temperature :** Selects color temperature of either 6500°K or 9300°K.
- Scale Mode :** Selection of picture size.
- H-position :** Allows adjustment for horizontal position.
- V-position :** Allows adjustment for vertical position.
- AGC Control :** This function provides a small scale of backlight enhancement to compensate the insufficient luminance.
- Default :** Return to factory default value.

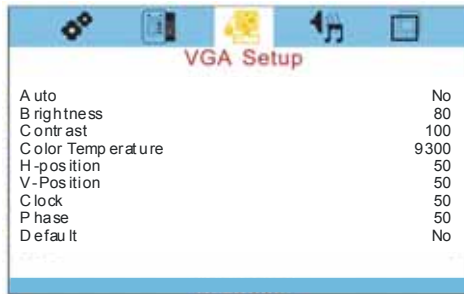

- Auto :** Auto detects screen detail data such as clock and phase.
- Brightness :** Adjusts the overall picture shade and brightness.
- Contrast :** Permits adjustment of contrast between light and dark areas of the picture.
- Color Temperature :** Selects color temperature of either 6500°K or 9300°K.
- H-position :** Allows adjustment for horizontal position.
- V-position :** Allows adjustment for vertical position.
- Clock :** Is used to adjust best picture quality. It adjusts the numbers of the pixel clock across one line time. Therefore it can affect the picture position and size.  
**Note: improper adjustment will caused image failure.**
- Phase :** Is used to adjust best picture quality. It adjusts the sampling phase across one pixel time. When the phase is not adjusted properly, the picture will be unclear. Therefore this value should be carefully adjusted.  
**Note: improper adjustment will cause image failure.**
- Default :** Sets monitor to the original factory setting.

## Audio Setup



- Volume :** Controls built-in speakers' output volumes
- Mute :** To disable the audio function. To enable, press MUTE again.
- Default :** Sets AUDIO settings to the original factory setting.

# PIP Setup

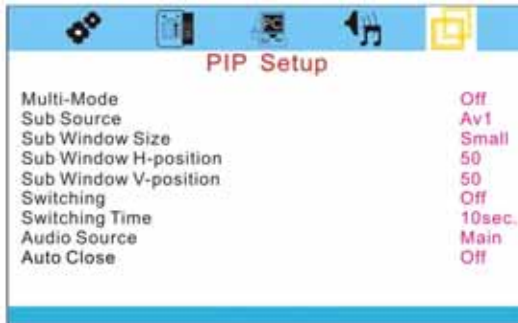

- Multi-Mode :** This function allows the PIP mode to be selected.
- Sub Source :** The function allows the PIP Sub source to be selected.
- Sub Window Size:** The selection of PIP window size.
- Sub Window H-Position :** Control the PIP window position in horizontal position.
- Sub Window V-Position :** Control the PIP window position in vertical position.
- Switching :** Enable PIP sources switching.
- Switching Time :** Control PIP source switching time.
- Audio Source:** Select PIP mode audio source.
- Auto Close :** Detect PIP mode signal.

**\* PIP Hotkey: Auto + Menu**



# LCD monitor Mounting Guide

## Desktop

Adjust the viewing angle of LCD to fit most comfortable monitoring status.

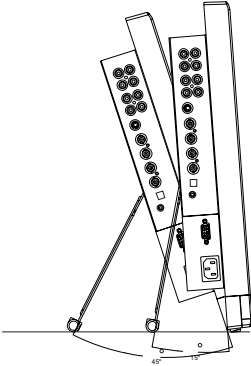

## Arm Mount (VESA Standard)

When adjusting the VESA Standard Arms to the back side of the LCD monitor, please use the 4x8(mm) screw.

For further information's please refer to the Arm Manual.

## Mounting the monitor on the rack

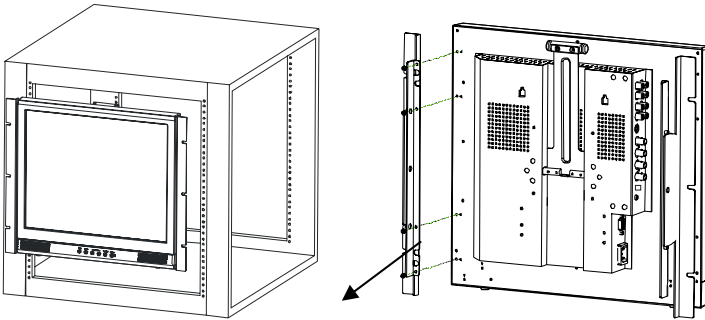

## Note:

When adjusting to a rack, you will need to use an optional rack mount to the back side of the LCD monitor.

## Troubleshooting

Before calling a service technician, please check the following table for a possible cause of the problem and some solution.

<b>Symptom</b>	<b>Solution</b>
Monitor will not turn on	<ul style="list-style-type: none"><li>• Make sure the power cord is plugged in, then press POWER button.</li></ul>
No picture, no sound	<ul style="list-style-type: none"><li>• Check cable connections.</li></ul>
No sound, picture OK	<ul style="list-style-type: none"><li>• Check audio Cable Connections</li><li>• Try pressing Volume up button in the Menu.</li></ul>
Poor color, sound OK	<ul style="list-style-type: none"><li>• Check cable connections</li><li>• Adjust Video set up menu.</li></ul>
Poor color or no color	<ul style="list-style-type: none"><li>• Adjust Color and / or TINT (NTSC only)</li></ul>

## LCD Color Monitor Specification

Model Number	VM-HT19LCD	
Panel Size	19.0"	
Aspect Ratio	5:4	
Resolution / Scan	640 x 480 @ 60/72/75	
	800 x 600 @ 56/60/72/75	
	1024 x 768 @ 60/70/75	
	1280 x 1024 @ 60/75	
Brightness	270cd/m <sup>2</sup> (*1)	
Viewing Angle(H/V)	Left 80° / Right 80° / Up 75° / Down 60°	
Response Time	8ms(Typ)	
Sync. Format	NTSC / PAL	
Frequency (Horizontal)	PC: 31.5K - 80KHz, Video 15750 / 15625Hz (NTSC / PAL) (*2)	
Frequency (Vertical)	PC: 56Hz -75Hz, Video: 50 / 60Hz (*2)	
Input Interfaces	Video Interface	D-SUB 15IN x 1, Video In x 2 (BNC), Video Out x 2 (BNC), S-Video In x 1
	Audio Interface	Audio In x 2, Audio Out x 2, PC-Audio In x 1
	Input Power	AC In x 1
	Termination	75ohm (Auto Termination)
Built-in Speakers	Yes (2pcs)	
Front Panel Button	Power, Source, Up, Down, Menu, Auto	
OSD Language	Multi Language	
VESA Mounting	VESA 100	
Weight (N.W./G.W.)	6.3kg / 7.7kg	
External Dimensions (WxHxD)	425x396x75.6 mm	
Safety & EMI	UL, CUL, FCC, CE	
Power	AC 100-240V 50/60Hz	
Power Consumption (max)	45W	
Temp (Oper.)	-10°C to 50°C (14°F ~122°F)	
Humidity	20% ~ 80%	
Accessories	Power cord, User Manual	

(\*1) The brightness spec. Is from panel spec.

Design and Specifications are subject to change without notice.

(\*2) It is not guaranteed for all the specified range.

# LCD Color Monitor Dimensions

## VM-HT19LCD

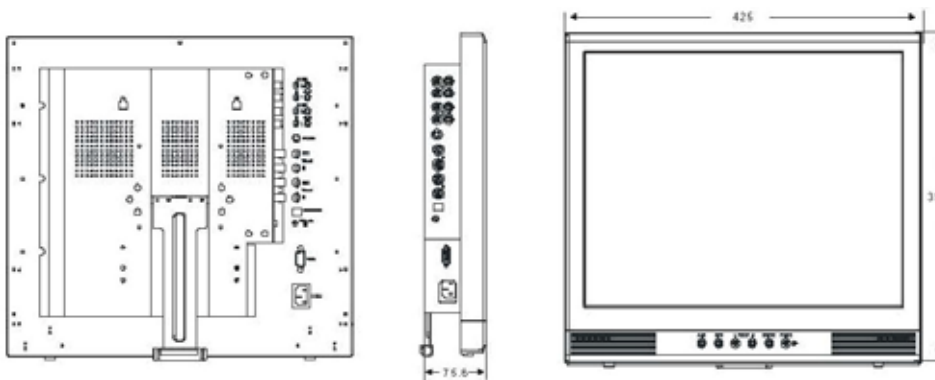

## Free Manuals Download Website

<http://myh66.com>

<http://usermanuals.us>

<http://www.somanuals.com>

<http://www.4manuals.cc>

<http://www.manual-lib.com>

<http://www.404manual.com>

<http://www.luxmanual.com>

<http://aubethermostatmanual.com>

Golf course search by state

<http://golfingnear.com>

Email search by domain

<http://emailbydomain.com>

Auto manuals search

<http://auto.somanuals.com>

TV manuals search

<http://tv.somanuals.com>