



Wide Dynamic Range
Dome Camera

CVC624WDR



200 New Highway
Amityville, NY 11701
631-957-8700
www.specotech.com

WARNING & CAUTION

	CAUTION RISK OF ELECTRIC SHOCK DO NOT OPEN	
CAUTION : TO REDUCE THE RISK OF ELECTRIC SHOCK DO NOT REMOVE COVER (OR BACK). NO USER SERVICEABLE PARTS INSIDE REFER SERVICING TO QUALIFIED SERVICE PERSONNEL.		

 The lightning flash with an arrowhead symbol, within an equilateral triangle is intended to alert the user to the presence of un-insulated "dangerous voltage" within the product's enclosure that may be of sufficient magnitude to constitute a risk of electric shock to persons

 The exclamation point within an equilateral triangle is intended to alert the user to the presence of important operating and maintenance (servicing) instructions in the literature accompanying the appliance

INFORMATION -This equipment has been tested and found to comply with limits for a class A digital device Pursuant to part 15 of the FCC rules. These limits are designed to provide reasonable protection against harmful interference when the equipment is operated in a commercial environment. This equipment generates, uses, and can radiate radio frequency energy and if not installed and used in accordance with the instruction manual, may cause harmful interference to radio communications. Operation of this equipment in a residential area is likely to cause harmful interference in which case the user will be required to correct the interference at his own expense.

WARNING – Change or modification not expressly approved by the manufacturer could void the user's authority to operate the equipment

CAUTION : To prevent electric shock and risk of fire hazards.

DO NOT use power sources other than that specified.

DO NOT expose this appliance to rain or moisture.

This installation should be made by a qualified service person and should conform to all local codes.

CONTENTS

Package Contents	4
Precautions	5
Camera Installation	6-7
Features	8
OSD Menu Tree	9
OSD Menu Details	10-12
Troubleshooting	13-14
Specifications	15
Dimensions	16
Warranty	17

PACKAGE CONTENTS

Please make sure that the following items are included in the package:

- 1 CVC624WDR Camera
- 2 Mounting Screws
- 1 Video Test Connector

Please leave this manual with the end-user for future reference.

COMPATIBILITY

“A” type Box



DFM Series

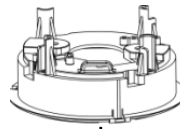

Electrical Box is not included in the package but
Is compatible with the camera

PRECAUTIONS

- **THIS CAMERA SHOULD BE ONLY INSTALLED BY QUALIFIED PERSONNEL**
- **TO PREVENT A FIRE OR ELECTRICAL HAZARD PLEASE USE PROPER POWER CABLE**
- **DO NOT CLEAN THE DOME COVER WITH AN ABRASIVE CLEANING MATERIAL - PLEASE USE A SOFT CLOTH OR TISSUE TO CLEAN THE DOME COVER**
- **THERE ARE NO USER-SERVICEABLE PARTS INSIDE. PLEASE DO NOT DISASSEMBLE THIS CAMERA OTHER THAN TO MAKE INITIAL ADJUSTMENTS**
- **PLEASE USE A UL APPROVED REGULATED 12 VOLT DC POWER SUPPLY**
- **PLEASE USE APPROPRIATE LOW VOLTAGE POWER CABLE TO PREVENT FIRE OR ELECTRICAL SHOCK**
- **PLEASE INSURE THAT YOUR INSTALLATION AREA CAN SUPPORT THE WEIGHT OF THE CAMERA**
- **PLEASE HANDLE THIS CAMERA CAREFULLY:**
 - **DON'T USE A STRONG OR ABRASIVE DETERGENT WHEN CLEANING THE CAMERA.**
 - **DON'T EXPOSE THE CAMERA TO DIRECT SUN**

CAMERA INSTALLATION

CONNECT POWER CABLE

1. WHEN USING 12 VOLTS DC (constant voltage 500 mA)

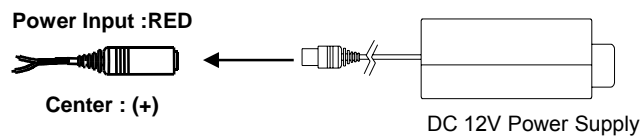

2. CONNECT VIDEO CABLE

-CONNECT BNC CABLE TO THE BNC JACK.

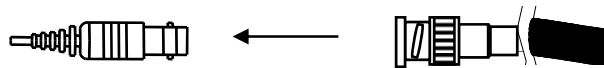

CAMERA INSTALLATION

MECHANICAL

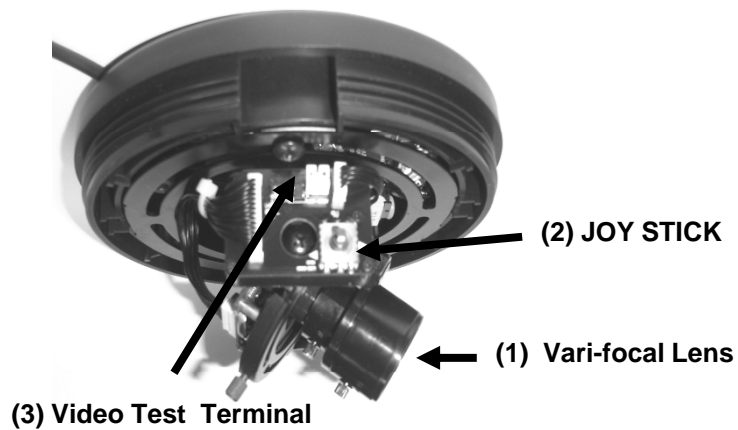

(1) VARI-FOCAL LENS

Adjust between T \leftrightarrow W (TELE \leftrightarrow WIDE) to set the angle (focal length). Set the focus by adjusting ∞ \leftrightarrow N

NOTE: BOTH OF THE ABOVE ADJUSTMENTS GET LOCKED INTO POSITION THROUGH THE USE OF "LOCKING HANDLES".

(2) JOY STICK

TO SET THE OSD (ON SCREEN DISPLAY) , PRESS THE JOY STICK FOR ONE SECOND AND SET AS DESCRIBED IN THE MANUAL

(3) VIDEO TEST TERMINAL

FEATURES

1. Superior Wide Dynamic Image Quality

It has very Wide Dynamic Range by using the Pixim ORCA Chip Set. Film-like colors are achieved under various Light conditions even in High Dynamic range scenes , Dynamic Range achieves a maximum of 120dB.

2. Digital Pixel System

Each pixel is processed independently to get clear and usable images.

3. OSD control

Every function is controlled by OSD menu

- Automatic white balance
- Automatic gain control (max 60dB)
- Slow shutter, AGC on/off
- Line lock phase control
- Lens type control
- Auto exposure control

4. High Resolution

540 lines of horizontal resolution and 460 lines of vertical resolution.

**** Pixim and Digital Pixel System are registered trademarks of Pixim, Inc.**

OSD MENU TREE

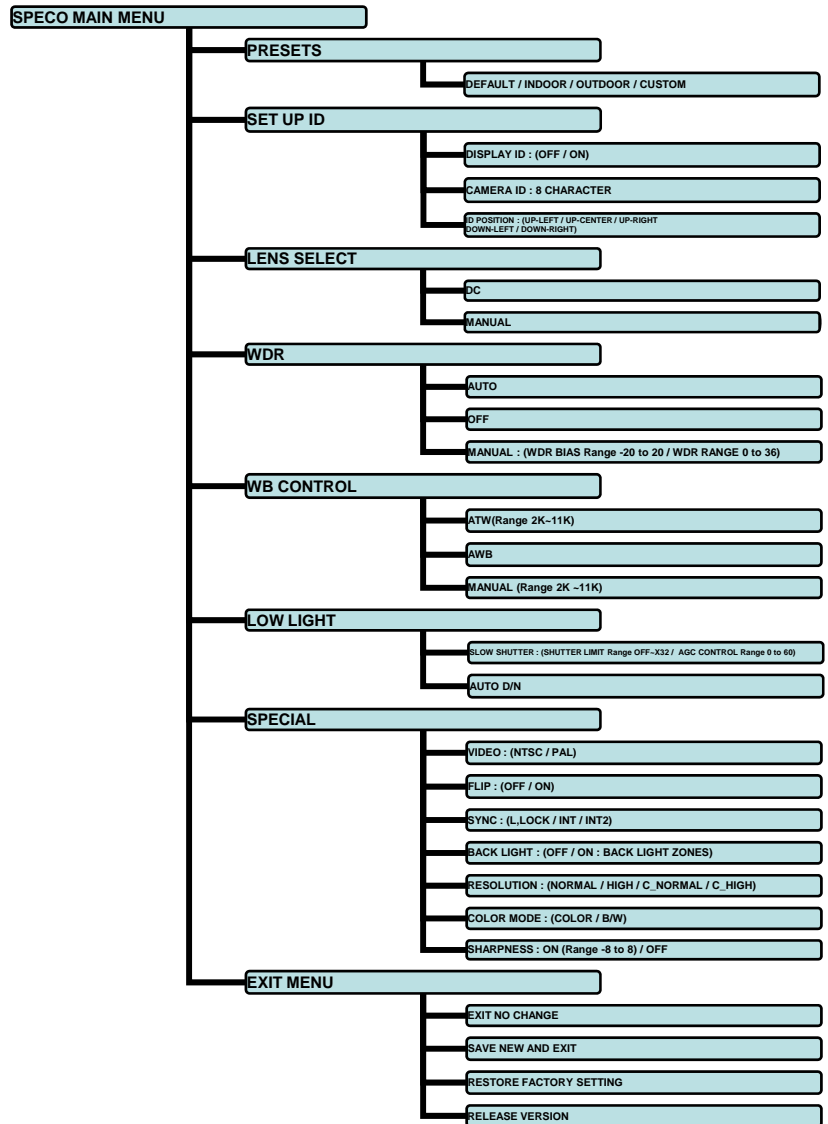

OSD MENU DETAILS

1. OSD MENU ENTER / EXIT

A. OSD MENU ENTER

- Push Center Key for 2 seconds

B. OSD MENU EXIT

- Press EXIT Menu from Main Menu
- If Pressing Set Key for 2 seconds from Main Menu appears.
In this case, just press Set Key.

C. 'SAVE' and 'QUIT'

- Left or Right Key - Selecting Menu
- Up or Down Key - Returning to Menu

1. Press the SET key to access the main setup mode.
2. Select the desired feature using the UP or Down key.
3. Change the status of the selected feature using the LEFT or RIGHT key.

2. MAIN MENU

A. PRESETS

- DEFAULT : Optimized for normal scenes
- INDOOR : Optimized for indoor scenes with windows and/or glass door to capture details both indoors and outdoors.
- OUTDOOR : Optimized for sunny outdoor scene to capture detail both in bright areas and shadows.
- CUSTOM : Change the value of the customer.

B. SETUP ID

- DISPLAY ID
 - ON : The ID name will displayed in the monitor.
 - OFF : The name will not displayed in the monitor.
- CAMERA ID : Enter up to 8 characteristic.
- ID POSITION : Select the screen position of the camera ID.

OSD MENU DETAILS

C. LENS

- MANUAL : Use Manual lens Only.

D. WDR

- WDR (Wide Dynamic Range) : You can adjust the desired WDR BIAS from -20 to 20 and WDR RANGE from 0 to 36

E. WB CONTROL

- ATW (Auto Tracking White Balance) : The camera automatically control the white balance in any environment.
- AWB (Auto White Balance) : The white balance is automatically adjusted in a specific environment.
- MANUAL : Users can adjust the colors by adding or reducing the WB level. You can adjust the desired WB level from 2K to 11K.

F. LOW LIGHT

- SLOW SHUTTER : Control Image brightness by adjusting shutter Speed, You can adjust the desired shutter speed from off to X32.
 - AGC : ON (You can adjust the desired AGC level from 0 to 60dB) or OFF (Deactivate automatic gain control feature)
- AUTO D/N : AUTO DAY/NIGHT

G. SPECIAL

- VIDEO : NTSC or PAL SELECTION
- FLIP : HORIZONTAL REVERSE (OFF or ON)
- SYNC
 - INTERNAL : Internal synchronization
 - INTERNAL2 : Internal synchronization (Color Rolling Mode)
 - LINE LOCK : Phase adjustment may be necessary in multiple camera installations to prevent picture roll when switching between cameras

OSD MENU DETAILS

- BACK LIGHT : BACK LIGHT ADJUST or SELECT AREA
- RESOLUTION : Select Resolution of CCD or PIXIM
- COLOR MODE : COLOR or B/W SELECTION
- SHARPNESS : ON (You can adjust the desired Sharpness form - 8 to 8) or OFF

H. EXIT MENU

- EXIT NO CHANGES : No change
- SAVE NEW AND EXIT : Save change
- RESTORE FACTORY SETTINGS : Factory default
- RELEASE VERSION

I. PREVIOUS PAGE

- PREVIOUS PAGE : Return page

Pixim's patented Digital Pixel System (DPS) technology Marks a fundamental breakthrough in imaging Technology.

Building upon technology developed at Stanford University in the 1990s, Pixim has created An image capture and processing system that provides High-quality pictures with enhanced dynamic Range that significantly improves image quality in Scenes consisting of both bright and dark areas. The core invention in DPS is the inclusion of an Analog-to-digital converter (ADC) within each pixel of the image sensor.

The ADC translates the light Signal into a digital value at the immediate point of Capture, thus minimizing signal degradation and cross-talk in the array and allowing for greater noise Reduction methods.

Once the data is captured in a Digital format, a variety of digital signal processing Techniques are used for optimal image reproduction.

TROUBLESHOOTING

If you have trouble operating your camera, refer to the following

Problem	Solution
Nothing appears on the screen.	<ul style="list-style-type: none">● Check that the power cord and line connection between the camera and monitor are correct● Check that you have properly connected VIDEO cable to the camera VIDEO output jack.
The image on the screen is dim.	<ul style="list-style-type: none">● Is the lens stained with dirt? Clean your lens with soft clean cloth.● Set the monitor for the proper conditions.● If the camera is exposed to too strong light change the camera position.● Adjust the lens' focus.
The image on the screen is dark.	<ul style="list-style-type: none">● Adjust the contrast feature of the monitor.● If you have an intermediate device, set the 75Ω/Hi-z properly.
The camera is not working properly, and the surface of the camera is hot.	<ul style="list-style-type: none">● Check that you have properly connected the camera to an appropriate power source.
MOTION DETECTION function is not active.	<ul style="list-style-type: none">● Have you set 'MOTION DET.' menu to off?● Have you set 'MD LEVEL' to too low?● Have you set 'MD AREA' properly

TROUBLESHOOTING

Problem	Solution
The color of the picture is not proper.	● Check that you have properly set the ' WHITE BALANCE ' menu
The image on the screen flickers.	● Is the camera facing to direct sunlight or fluorescent lighting? Change the camera position.

SPECIFICATIONS

Signal System	NTSC
Pick-up Device	1/3 inch Pixim ORCA CMOS (Dramatic Dynamic range sensor)
Total of pixels	742(H) x 552(V)
Horizontal Resolution	540 Horizontal TV Lines (color)
Vertical Resolution	460 VTVL
Scanning System	525 lines interlaced / 625 lines interlaced
Synchronization	Internal
Video Output	1.0Vp-p/75 ohm Composite
Sensitivity	0.08Lux (DSS on) with F1.2 Lens
S/N Ratio	53dB or more
Dynamic range	120dB(max), 102dB(typical)
Shutter Speed	1/60 - 1/100,000 / 1/50 - 1/100,000
Lens	2.8~12mm Vari-focal Lens
AGC Control	0 - 60dB
OSD Menu Control	Joy-Stick Switch
Voltage Requirements	DC 12V (8V – 18V)
Power Consumption	Max 2.7W
Operating Temperature	-14°F ~ 122°F
Storage Temperature	-4°F ~ 158°F
Operating Humidity	Under 90% Non-condensing
Storage Humidity	under 95% Non-condensing

DIMENSIONS

* SIDE VIEW

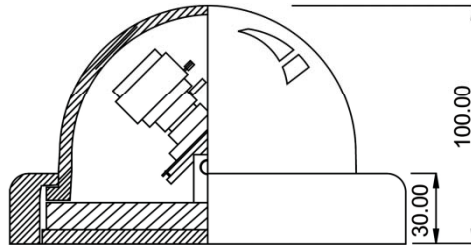

* TOP VIEW

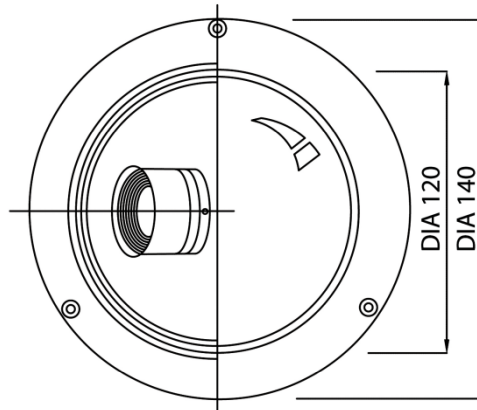

WARRANTY



LIMITED WARRANTY

THIS WARRANTY IS VALID ONLY ON PRODUCTS PURCHASED AND USED IN THE UNITED STATES OF AMERICA. THIS WARRANTY APPLIES ONLY TO THE ORIGINAL USER.

SUBJECT TO CONDITIONS AND EXCLUSIONS FOUND BELOW, THIS PRODUCT IS WARRANTED AGAINST MANUFACTURING DEFECTS IN MATERIAL AND WORKMANSHIP FOR THE FOLLOWING PERIOD FOR PARTS AND LABOR:

SPECO TECHNOLOGIES CAMERAS:	5 YEARS
SPECO TECHNOLOGIES MONITORS:	1 YEAR
BALANCE OF SPECO TECHNOLOGIES LINE:	1 YEAR*
* IR LEDs, Time lapse VCR Drum Assemblies & Heads:	90-DAYS

SPECO TECHNOLOGIES WILL REPAIR OR REPLACE (AT OUR DISCRETION) ANY PARTS FOUND TO BE DEFECTIVE FOR THE WARRANTY PERIOD SPECIFIED. WE WILL PROVIDE A REPLACEMENT FOR ANY DEFECTIVE PART.

CONDITIONS

1. YOU MUST OBTAIN A RETURN AUTHORIZATION NUMBER FOR ANY MERCHANDISE BEING RETURNED TO SPECO TECHNOLOGIES, WHETHER FOR RETURN/EXCHANGE OR REPAIR, WHETHER IN OR OUT OF WARRANTY.

2. THIS WARRANTY WILL BE HONORED ONLY UPON PRESENTATION OF THE ORIGINAL DATED BILL OF SALE OR SALES SLIP.

3. TRANSPORTATION OF THE PRODUCT TO OUR SERVICE DEPARTMENT IS THE RESPONSIBILITY OF THE USER. REPAIRED OR REPLACED PRODUCT WILL BE RETURNED PREPAID DURING THE WARRANTY PERIOD.

EXCLUSIONS

1. THIS WARRANTY SHALL NOT COVER ADJUSTMENT OF CUSTOMER OPERATED CONTROLS AS EXPLAINED IN THE APPROPRIATE MODEL'S INSTRUCTION MANUAL OR PRODUCTS WHICH HAVE BEEN ALTERED, ABUSED, OR HAVE MISSING OR ALTERED SERIAL NUMBERS.

2. THIS WARRANTY SHALL NOT APPLY TO UNCRATING, SETUP, INSTALLATION, OR THE REMOVAL AND REINSTALLATION OF PRODUCTS AFTER REPAIR.

3. THIS WARRANTY SHALL NOT APPLY TO REPAIRS OR REPLACEMENTS NECESSITATED BY ANY CAUSE BEYOND THE RESULT OF MANUFACTURE INCLUDING, BUT NOT LIMITED TO, ANY MALFUNCTION, DEFECTS OR FAILURE CAUSED BY OR RESULTING FROM UNAUTHORIZED SERVICE OR PARTS, IMPROPER MAINTENANCE, MODIFICATION OR REPAIR BY THE USER, ABUSE, MISUSE, NEGLIGENCE, ACCIDENT, FIRE, FLOOD, OR OTHER ACTS OF NATURE, INCORRECT LINE VOLTAGE, DAMAGE OR IMAGE BURNS TO TELEVISION PICTURE TUBES CAUSED BY OR ATTRIBUTABLE TO THE USE OF ANY ACCESSORY, ELECTRONICS GAME OR DEVICE, OR DAMAGE CAUSED TO IMAGE PICKUP DEVICES BY EXCESSIVE LIGHT.

THE FOREGOING IS IN LIEU OF ALL OTHER EXPRESSED WARRANTIES AND WE DO NOT AUTHORIZE ANY PARTY TO ASSUME FOR US ANY OTHER OBLIGATION OF LIABILITY. IN NO EVENT SHALL WE BE LIABLE FOR INCIDENTAL OR CONSEQUENTIAL DAMAGES ARISING FROM THE USE OF THIS PRODUCT, OR FOR ANY DELAY IN THE USE OF THIS PRODUCT DUE TO CAUSES BEYOND OUR CONTROL.

SOME STATES DO NOT ALLOW LIMITATIONS OF HOW LONG AN IMPLIED WARRANTY LASTS AND/OR DO NOT ALLOW THE EXCLUSION OR LIMITATION OF CONSEQUENTIAL DAMAGES. THE ABOVE LIMITATIONS ON IMPLIED WARRANTY AND CONSEQUENTIAL DAMAGES MAY NOT APPLY TO YOU.

THIS WARRANTY GIVES YOU SPECIFIC LEGAL RIGHTS. YOU MAY HAVE OTHER RIGHTS WHICH VARY FROM STATE TO STATE.

NOTE: FOR YOUR PROTECTION IN THE EVENT OF THEFT OR LOSS OF THIS PRODUCT, PLEASE FILL IN THE INFORMATION REQUESTED BELOW AND RETAIN WITH YOUR SALES RECEIPT.

MODEL NO.: _____ SERIAL NO.: _____
(LOCATED ON BACK OR BOTTOM OF UNIT)

DATE OF PURCHASE: _____

WHERE PURCHASED: _____ PURCHASE PRICE: _____

Speco Technologies
200 NEW HIGHWAY
AMITYVILLE, NY 11701 www.specotech.com

FOR MORE INFORMATION REGARDING
SERVICE OR RETURN, CALL US
TOLL FREE: 1-800-645-5516 IN METRO NY: 631-957-8700

ALWAYS USE DISCRETION WHEN INSTALLING VIDEO AND/OR AUDIO SURVEILLANCE EQUIPMENT ESPECIALLY WHEN THERE IS AN EXPECTATION OF PRIVACY. INQUIRE REGARDING FEDERAL, STATE AND/OR LOCAL REGULATIONS APPLICABLE TO THE LAWFUL INSTALLATION OF VIDEO AND/OR AUDIO RECORDING OR SURVEILLANCE EQUIPMENT. PARTY CONSENT MAY BE REQUIRED.

MEMO

MEMO



**200 New Highway
Amityville, NY 11701
631-957-8700
www.specotech.com**

Rev. 100317

**Speco Technologies is constantly developing product improvements.
We reserve the right to modify product design and specifications without notice
and without incurring any obligation.**

Free Manuals Download Website

<http://myh66.com>

<http://usermanuals.us>

<http://www.somanuals.com>

<http://www.4manuals.cc>

<http://www.manual-lib.com>

<http://www.404manual.com>

<http://www.luxmanual.com>

<http://aubethermostatmanual.com>

Golf course search by state

<http://golfingnear.com>

Email search by domain

<http://emailbydomain.com>

Auto manuals search

<http://auto.somanuals.com>

TV manuals search

<http://tv.somanuals.com>