

**Speed Queen**

# User's Guide

for your  
topload  
washer

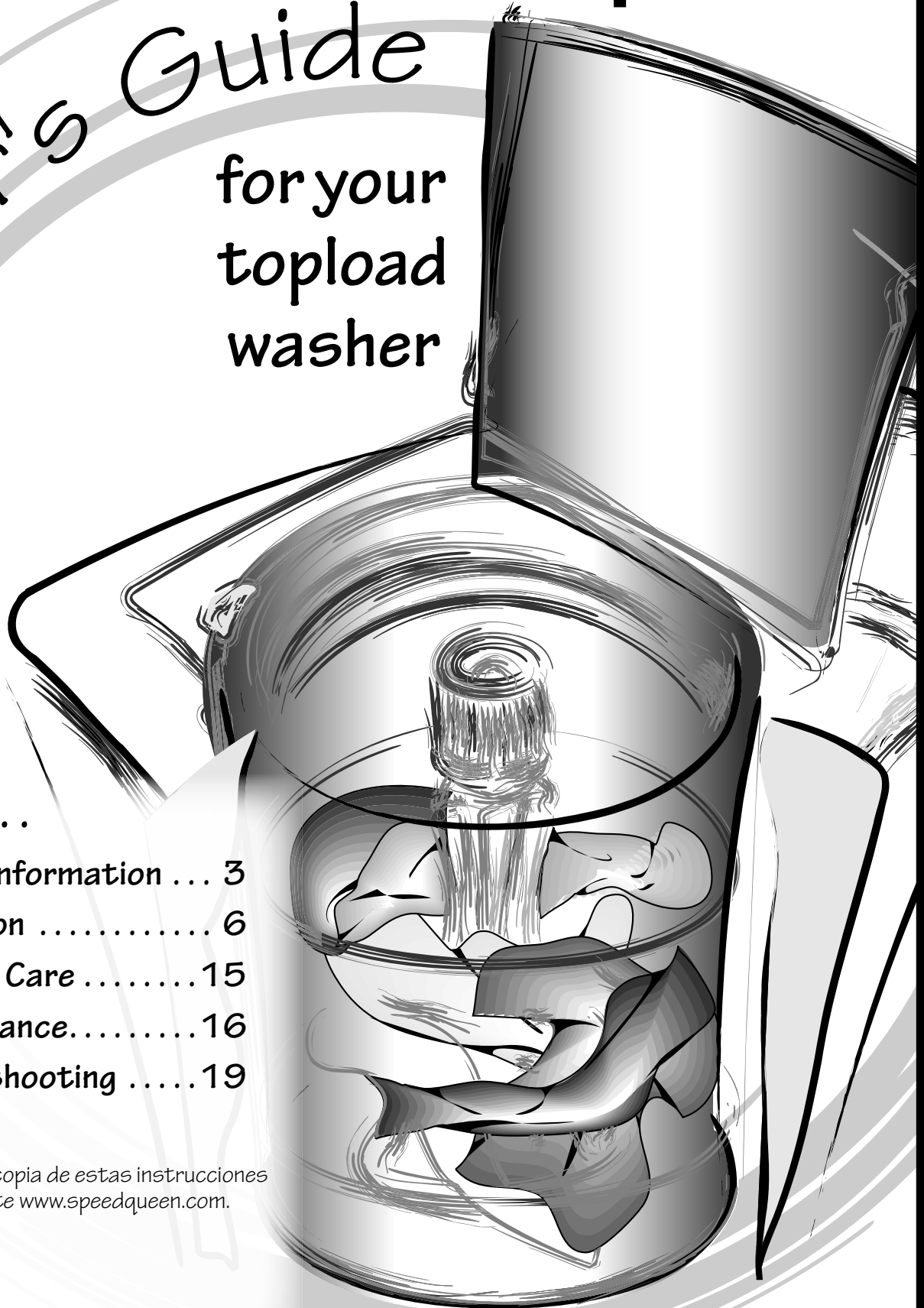

## Inside . . .

Safety Information . . .	3
Operation . . . . .	6
Clothing Care . . . . .	15
Maintenance . . . . .	16
Troubleshooting . . . . .	19

Para bajar una copia de estas instrucciones en español, visite [www.speedqueen.com](http://www.speedqueen.com).

[www.speedqueen.com](http://www.speedqueen.com)

Part No. 202147R2  
June 2011



## WARNING

For your safety and to reduce the risk of fire or an explosion, do not store or use gasoline or other flammable vapors and liquids in the vicinity of this or any other appliance.

W022

# Safety Information

## Explanation of Safety Messages

Throughout this manual and on machine decals, you will find precautionary statements (“DANGER,” “WARNING,” and “CAUTION”) followed by specific instructions. These precautions are intended for the personal safety of the operator, user, servicer, and those maintaining the machine.

	<b>DANGER</b>
Indicates an imminently hazardous situation that, if not avoided, will cause severe personal injury or death.	

	<b>WARNING</b>
Indicates a hazardous situation that, if not avoided, could cause severe personal injury or death.	

	<b>CAUTION</b>
Indicates a hazardous situation that, if not avoided, may cause minor or moderate personal injury or property damage.	

Additional precautionary statements (“IMPORTANT” and “NOTE”) are followed by specific instructions.

**IMPORTANT:** The word “IMPORTANT” is used to inform the reader of specific procedures where minor machine damage will occur if the procedure is not followed.

**NOTE:** The word “NOTE” is used to communicate installation, operation, maintenance or servicing information that is important but not hazard related.

## Important Safety Instructions

### Save These Instructions

	<b>WARNING</b>
To reduce the risk of fire, electric shock, serious injury or death to persons when using your washer, follow these basic precautions:	
W023	

1. Read all instructions before using the washer.
2. Refer to the *Grounding Information* in the Installation Instructions for the proper grounding of the washer.
3. Do not wash articles that have been previously cleaned in, washed in, soaked in, or spotted with gasoline, dry-cleaning solvents, or other flammable or explosive substances as they give off vapors that could ignite or explode.
4. Do not add gasoline, dry-cleaning solvents, or other flammable or explosive substances to the wash water. These substances give off vapors that could ignite or explode.

5. Under certain conditions, hydrogen gas may be produced in a hot water system that has not been used for two weeks or more. HYDROGEN GAS IS EXPLOSIVE. If the hot water system has not been used for such a period, before using a washing machine or combination washer-dryer, turn on all hot water faucets and let the water flow from each for several minutes. This will release any accumulated hydrogen gas. THE GAS IS FLAMMABLE. DO NOT SMOKE OR USE AN OPEN FLAME DURING THIS TIME.
6. Close supervision of children is necessary when the washer is used near children. This is a safety rule for all appliances.
7. Before the washer is removed from service or discarded, remove the lid to the washing compartment.
8. Do not reach into the washer if the washtub or agitator is moving.
9. Do not install or store the washer where it will be exposed to water and/or weather.
10. Do not tamper with the controls.
11. Do not repair or replace any part of the washer, or attempt any servicing unless specifically recommended in the user-maintenance instructions or in published user-repair instructions that you understand and have the skills to carry out.
12. To reduce the risk of an electric shock or fire, DO NOT use an extension cord or an adapter to connect the washer to the electrical power source.
13. Use your washer only for its intended purpose, washing clothes.
14. ALWAYS disconnect the washer from electrical supply before attempting any service. Disconnect the power cord by grasping the plug, not the cord.
15. Install the washer according to the Installation Instructions. All connections for water, drain, electrical power and grounding must comply with local codes and be made by licensed personnel when required. Do not do it yourself unless you know how!
16. To reduce the risk of fire, clothes which have traces of any flammable substances such as vegetable oil, cooking oil, machine oil, flammable chemicals, thinner, etc. or anything containing wax or chemicals such as in mops and cleaning cloths, must not be put into the washer. These flammable substances may cause the fabric to catch on fire by itself.
17. Do not use fabric softeners or products to eliminate static unless recommended by the manufacturer of the fabric softener or product.
18. Keep your washer in good condition. Bumping or dropping the washer can damage safety features. If this occurs, have your washer checked by a qualified service person.
19. Replace worn power cords and/or loose plugs.
20. Be sure water connections have a shut-off valve and that fill hose connections are tight. CLOSE the shut-off valves at the end of each wash day. Replace fill hoses every five years.
21. Lid MUST BE CLOSED any time the washer is to agitate or spin. DO NOT by-pass the lid switch by permitting the washer to agitate or spin with the lid open. A brake will stop the washtub within seconds if the lid is opened during spinning. If the washtub does not stop when the lid is opened, remove the washer from use and call the service person.
22. Check washer for water leaks after each use. If water is found, turn off the water supply and call for service immediately. Don't use washer until it is repaired by an authorized service agent.

23. If the washer's volume or type of sound changes from what is normally heard, call an authorized service agent immediately to prevent possible damage to other components.
24. Never start a cycle and leave the property without first checking to make sure the wash cycle is complete.
25. Always read and follow manufacturer's instructions on packages of laundry and cleaning aids. Heed all warnings or precautions. To reduce the risk of poisoning or chemical burns, keep them out of the reach of children at all times (preferably in a locked cabinet).
26. Always follow the fabric care instructions supplied by the garment manufacturer.
27. Never operate the washer with any guards and/or panels removed.
28. DO NOT operate the washer with missing or broken parts.
29. DO NOT by-pass any safety devices.
30. Failure to install, maintain, and/or operate this machine according to the manufacturer's instructions may result in conditions which can produce bodily injury and/or property damage.
31. Replace washer fill hoses every five years.

**NOTE: The WARNING and Important Safety Instructions appearing in this manual are not meant to cover all possible conditions and situations that may occur. Observe and be aware of other labels and precautions that are located on the machine. They are intended to provide instructions for safe use of the machine. Common sense, caution and care must be exercised when installing, maintaining, or operating the washer.**

Always contact your dealer, distributor or service agent about any problems or conditions you do not understand.

# Operation

## Before Washing

### Prepare Wash Load

#### Empty Pockets and Cuffs

Make sure all pockets are empty and turn them inside out. One bobby pin, metal or plastic toy, nail or sharp object in a load can catch laundry and cause tears. Facial tissue left in a pocket will produce extreme “lint”. A crayon or lipstick in a wash load may cause stains that cannot be removed. Roll down cuffs and shake out grass, sand and gravel.

#### Mend Rips and Tears

Little holes can become bigger in the washer. Mend holes and tears before placing garments in the washer.

#### Close Zipper and Fasten Hooks

These can catch on garments in a wash load and tear them. Tie belts and sashes so they won't wind around clothes.

#### Check For Colorfastness

Squeeze a portion of garment in warm or hot sudsy water. If the color bleeds or runs, wash the item separately in cold water.

### Sorting Items

Different items use different wash cycles and temperatures. Always follow the manufacturer's care label. Proper sorting is easy if you follow a few guidelines:

#### 1. Sort by Color:

Separate items into loads of whites, darks, lights and non-colorfast.



#### 2. Sort by Fabric and Construction:

Separate items into loads of cottons/linens, permanent press, synthetics/blends/poly knits, and delicates.



#### 3. Sort by Temperature:

Separate items into loads that can be washed in cold, warm or hot water.



#### 4. Sort by Type and Amount of Soil:

Heavily soiled clothes will need extra treatment. Lightly soiled clothes can become dingy if washed with heavily soiled items.

#### 5. Sort Lint “Shedders” From Lint “Receivers”:

Some fabrics attract lint and should not be washed with lint-shedding loads. Lint shedders are cottons, terry towels, chenille bedspreads, rugs and clothes that have been heavily bleached.

Lint receivers are synthetics, permanent or durable press, knits (including socks), corduroy, and other smooth fabrics.

### Pretreat

Pretreat shirt collars and cuffs with a pretreat product or liquid detergent when placing them in the washer. Before washing, treat special stains individually. Refer to *Stain Removal* section for procedures on treating specific stains.



## WARNING

Do not wash or dry items soiled with vegetable or cooking oils. Some oils may remain after washing and may cause the fabric to catch on fire by itself.

W527

## Loading the Washer

NOTE: Always add detergent first.

### Load Articles

- Load items by the amount of space they take up, not by their weight. Mix large and small items in a load to get the best washing results.
- Drop items loosely into the washtub. The bulk of the clothes rather than the weight will determine load size. Do not pack items in or wrap them around the agitator. Overloading can cause poor cleaning, excessive wrinkling and tears.

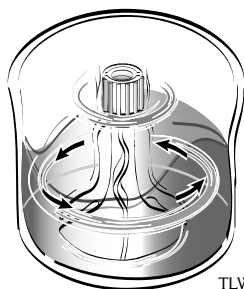

TLW1992N

- Items should move freely through the wash water for best cleaning results. Items should rollover, sink and then reappear.

- When washing very large items, do not fill washtub as full as with other loads.

### Water Level

- The water level in your washer should fit the size of your wash load. Small loads will use lower water levels. There must be enough water in the washtub to allow items to move and turn over freely.

Wrong Water Level for Size of Load



Right Water Level for Size of Load



TLW1993N

- Overloading the washtub can result in poor washing and rinsing.
- Overloading may also cause wrinkling and tearing of items.

**IMPORTANT:** If in doubt, always use a higher water level. Most average loads will require a water setting between Medium and Extra Large. Failure to have the correct volume of water relative to the load will increase the incidence of excessive lint.

**NOTE:** Starting January 2009, the Department of Energy (DOE) mandated new efficiency standards which resulted in reduced water levels in the toload washer.

- Reset (OPTIONAL)  
Use the RESET if agitation has started and more water is needed for the load.

Load Sizes	
Mini	1-2 permanent press dress shirts or 2 pillow cases or 1 lightweight dress or similar size load
Small	3-4 permanent press dress shirts or 1 twin sheet, 1 pillow case or 1-2 lightweight dresses
Medium	6-7 permanent press shirts or 2 twin sheets, 2 pillow cases or 8 standard bath towels, 6 wash cloths
Extra Large	8-9 shirts, 5 pair polyester pants or 2 queen size sheets, 4 pillow cases, 2 nightgowns, 1 pair men's pajamas or 1 queen size bedspread

## Wash Temperature

### Hot Water

Hot water will give the best results of cleaning and sanitizing, but it is not suitable for all items. It is best for sturdy whites and colorfast items, heavily soiled items and diapers.

### Warm Water

By using warm water, there is less chance of color loss in items. Warm water also reduces wrinkling in permanent press items. Use with light and moderate soils, non-colorfast or dark colors, permanent press, silks, woolens, nylon, and acrylic.

### Cold Water

Cold water is less effective in cleaning than hot or warm water, but it does minimize wrinkling and color fading. Use it for washing extra-sensitive clothes and for the rinsing of all fabrics.

**NOTE: In wash temperatures colder than 60°F (15°C), detergents do not dissolve well. This may cause ineffective cleaning, or lint and residue to form.**

## Energy

You can save energy when washing by following a few guidelines:

1. Heating water accounts for the greatest energy expense when washing. Save on heating water by using warm or cold washes as well as cold rinses.
2. Wash full loads, but do not overload.
3. Use soak cycles for heavily soiled items to reduce wash times.
4. Select a shorter wash time for lightly soiled items.

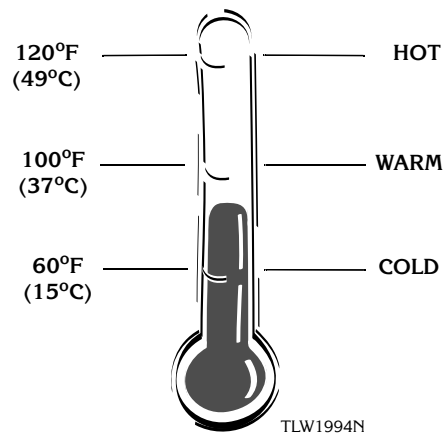

## Wash Temperature Guide

Water Temperature	Use	Comments
HOT (approximately 120°F [49°C], as determined by outside water supply)	<ul style="list-style-type: none"> <li>• Sturdy whites and colorfast items</li> <li>• Work clothes</li> <li>• Soiled items</li> <li>• Diapers</li> </ul>	<ul style="list-style-type: none"> <li>• Best cleaning for heavily soiled items</li> <li>• Best for sanitizing</li> </ul>
WARM (approximately 100° F [37°C]), as determined by outside water supply)	<ul style="list-style-type: none"> <li>• Rinsing of some items (OPTIONAL)</li> <li>• Light and moderately soiled items</li> <li>• Non-colorfast or dark colors</li> <li>• Permanent press</li> <li>• Silks, woolens, nylon, acrylic</li> </ul>	<ul style="list-style-type: none"> <li>• Reduces wrinkling in permanent press fabrics</li> <li>• Less fading</li> <li>• Reduces shrinking in knits</li> </ul>
COLD (approximately 60° F [15°C]), as determined by outside water supply)	<ul style="list-style-type: none"> <li>• Rinsing of most items</li> <li>• Non-colorfast fabrics</li> <li>• Extra sensitive clothing</li> </ul>	<ul style="list-style-type: none"> <li>• Saves energy</li> <li>• Reduces color fading</li> <li>• Reduces wrinkling</li> <li>• Reduces shrinking</li> </ul>



## Operating Your Washer



### WARNING

**To reduce the risk of fire, electric shock, serious injury or death to persons, read the *Safety Information* section before operating your washer.**

W522

### Determine Proper Cycle

(Some cycles may not be included on your model)

#### *Regular Cycle*

Use for sturdy items, like play or work clothes, towels, T-shirts, etc. The wash time selection will depend on the type of fabric and the amount of soil. For the best results when cleaning heavily soiled items, use a longer wash time (15 minutes maximum). Lightly soiled items require less wash time and spin out.

If available, use the Prewash setting for extra heavily soiled items. During the PREWASH setting, the washtub will fill with water, agitate for a reduced period of time and spin out.

There are three settings in the REGULAR cycle – Heavy, Normal and Light.

#### *Permanent Press Cycle*

Use for permanent press items and synthetics. The wash time selection will depend upon the type of fabric and amount of soil.

There are two settings in the PERMANENT PRESS cycle – Normal and Light.

#### *Handwash/Delicate Cycle (on select models only)*

Wash delicate items usually washed by hand on this cycle. A full tub of water is recommended (even for small loads) to allow the delicate items to move freely through the water. More water helps reduce fabric wear, wrinkling, and provides for a clean wash.

On this cycle, the agitation during the wash portion of the cycle is not constant. The wash will alternate between 24 seconds of agitation and then a pause until advancing to the spin portion of the cycle.

There are two settings in the HANDWASH/DELICATE cycle – Normal and Light.

#### *Delicate Cycle (on select models only)*

Wash delicate items usually washed by hand on this cycle. A full tub of water is recommended (even for small loads) to allow the delicate items to move freely through the water. More water helps reduce fabric wear, wrinkling, and provides for a clean wash.

On this cycle, the agitation during the wash portion of the cycle is not constant. The wash will alternate between 24 seconds of agitation and then a pause until advancing to the spin portion of the cycle.

There is one setting in the DELICATE cycle – Normal.

#### *Hand Wash Cycle (on select models only)*

Wash items usually washed by hand on this cycle. A full tub of water is recommended (even for small loads) to allow the delicate items to move freely through the water. More water helps reduce fabric wear, wrinkling, and provides for a clean wash.

On this cycle, the agitation during the wash portion of the cycle is not constant. The wash will alternate between 24 seconds of agitation and then a pause until advancing to the spin portion of the cycle.

#### *Soak/Prewash (on select models only)*

Use for heavily soiled or stained clothing. During the SOAK/PREWASH setting, the washtub will fill with water, agitate for a reduced period of time, pause for approximately 12 minutes, and spin out to complete the cycle.

#### *Extra Rinse (on select models only)*

This optional setting is useful for detergent sensitive skin. By pressing the “Extra Rinse” button to “ON,” the REGULAR, PERMANENT PRESS and HANDWASH/DELICATE cycles will each provide an additional rinse.

## Fabric Selector Setting (on select models only)

The fabric selector setting allows users to control the agitate and spin speeds. However, if certain cycles are selected, their speeds will override these settings. In the Permanent Press cycle the first spin will always be slow. In the Delicate and Hand Wash cycles, all speeds will be slow.

### Regular

This setting provides a fast agitation speed and a fast spin speed.

Use REGULAR setting for sturdy items like work or play clothes. Also use it for items that are heavily soiled.

### Perm Press

This setting provides a fast agitation speed and a slow spin speed.

Use PERM PRESS setting for most permanent press items and items that wrinkle easily.

### Knits

This setting provides a slow agitation speed and a fast spin speed.

Use KNITS setting for loosely woven fabrics, sheer synthetics or cottons, loads that can give off excessive lint or for items that can be damaged by regular agitation.

### Delicates

This setting provides a slow agitation speed and a slow spin speed.

Use DELICATES setting for delicate items, items that wrinkle easily like lightweight synthetics or lightweight permanent press.

## To Wash Clothes

**IMPORTANT:** Before using your new washer, make sure the washer cord is plugged into a 120 Volt electrical outlet that has the proper grounding and polarity. Make sure the washer hoses are connected to the hot and cold water faucets, and that the faucets are turned on. Be sure the drain hose is not kinked and is inserted into a drain. Refer to the INSTALLATION INSTRUCTIONS for details of proper washer installation.

**IMPORTANT:** Prior to first wash, use an all purpose cleaner, or a detergent and water solution, and a damp cloth to remove shipping dust from inside of washtub.

1. Get the clothes ready for washing. Empty pockets and cuffs. Sort items into separate loads. Pretreat stains and heavily soiled areas.



**IMPORTANT:** Remove all sharp objects from laundry to avoid tears and rips to items during normal machine operation.

2. Measure and add detergent to the washtub. Follow instructions on detergent package for amount to use.

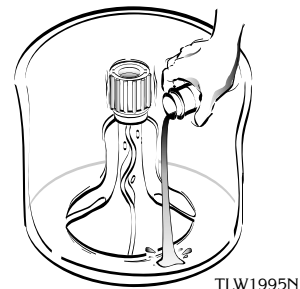

3. Add clothes loosely into the washtub.

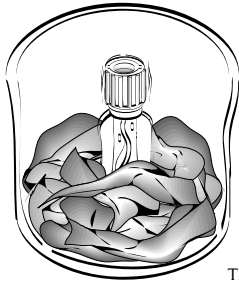

TLW1996N

4. Close the lid. The washer will not agitate or spin with the lid open.

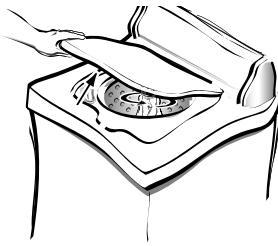

TLW1997N

5. Set WASH/RINSE temperatures. (All rinses are cold.)

**NOTE:** Cold rinses will save you money and energy and will help reduce wrinkling in permanent press and synthetics.

**WASH TEMPERATURE**

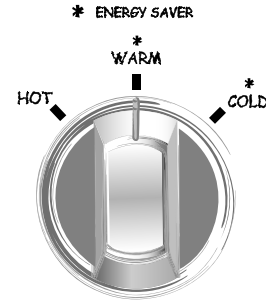

TLW2108N

The Energy Saver settings, marked with an asterisk (\*), show which temperature settings will use the least energy.

6. Set LOAD SIZE (WATER LEVEL) control. Use RESET if agitation has started and more water is needed.

**LOAD SIZE**

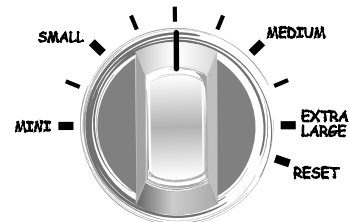

TLW2109N

**IMPORTANT:** Holding the LOAD SIZE (WATER LEVEL) control in the RESET position can cause flooding of the washer.

**NOTE:** Starting January 2009, the Department of Energy (DOE) mandated new efficiency standards which resulted in reduced water levels in the topload washer.

	<h2>WARNING</h2> <p>To reduce the risk of serious injury, do not by-pass the lid switch by permitting the washer to agitate or spin with the lid open.</p>
	W523

7. Set Fabric Selector (on select models only).

### FABRIC SELECTOR

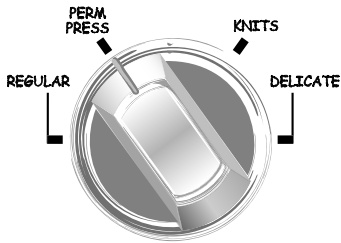

TLW2110N

8. Select Extra Rinse (on select models only) if desired.

### EXTRA RINSE

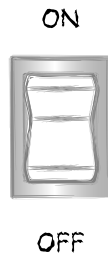

TLW2111N

9. Select the cycle according to the type of fabric being washed. Push the timer knob in and turn clockwise to the desired cycle and wash time.
10. Pull the timer knob out to start the water fill. Agitation will begin when the water reaches the level you selected.

**NOTE: Lid must be closed for agitation and spin to start.**

The washer will stop (pause) shortly before the wash and rinse spins. Do not turn the timer through these pauses. They are part of the cycle.

## Timer

Although the washer cycles are automatic, the timer may be reset to lengthen, shorten or repeat a portion of a cycle.

To set or reset the timer, push timer knob in to stop the washer. Hold timer knob in firmly while turning it clockwise to the setting desired. Pull timer knob out to start the washer.

## Manual Soaking

Set the timer knob in the center of the word "RINSE" (this prevents the washer from spinning without first filling with water). Place the soaking product and clothes load in the washtub. Pull timer knob to start washer fill. After fill is completed and agitation has started, (lid must be closed) push the timer knob in. This will stop the washer. When the clothes have soaked the desired length of time, TURN THE TIMER KNOB TO THE START OF THE SPIN SETTING, then pull the timer knob out to start the spin.



## CAUTION

**Failure to turn the timer knob to the spin cycle and completely drain the washtub after soaking will result in the washer overflowing and cause property damage.**

W524

## Optional Features

### Bleach Dispenser

The bleach dispenser is located in the left front corner, under the lid.

Use liquid bleach in the dispenser. Powdered bleach must not be used in the dispenser. Add powdered bleach to the wash water.

Use no more than one cup chlorine bleach for large loads, three-quarters cup for medium and one-half cup for small loads.

Carefully pour recommended amount of bleach into the dispenser during the first fill of the washer.

Be careful not to spill undiluted bleach. It is a strong chemical and can damage some fabrics if it is not properly diluted.

### Fabric Softener Dispenser

#### *To Use Dispenser*

After the clothes are loaded into the washtub and before the start of the WASH cycle, pour the proper amount of liquid fabric softener into the bottle measuring cap (refer to bottle directions). Pour into dispenser.

The large fabric softener dispenser allows for the fabric softener to be diluted with water. We recommend adding water up to the fill level. Do not exceed tip of arrow which indicates correct fill level. Over-filling can allow fabric softener to spill onto the clothes, causing stains on clothes if the softener comes into contact with detergent suds.

Setting the water level to medium or higher will result in better performance from the fabric softener.

The fabric softener will remain in the dispenser during the wash fill, agitation and spin. At the end of the wash spin, the liquid fabric softener will be dispensed into the washtub through the slots in the agitator and will be mixed with the incoming rinse water.

## To Clean the Dispenser

Remove the dispenser housing from agitator by squeezing the lower part of the dispenser, pulling directly upward and at the same time tilting slightly. This will expose the dispenser cup, which is also removable, for cleaning (refer to illustration). Both housing and cup can be soaked in hot soapy water and rinsed clean. The funnel shape in top of agitator also needs to be cleaned. The hole and the slots in the two rings will require using a small brush for proper cleaning.

After cleaning, install dispenser cup, then push dispenser housing directly downward onto top of agitator until firmly snapped together.

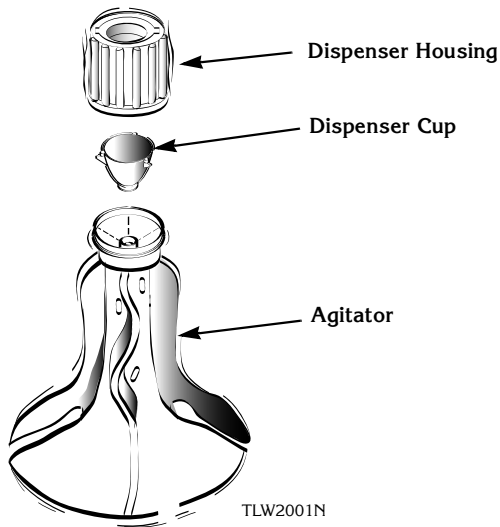

## Use Tips

- Fabric softener spilled onto garments may cause staining. To remove, dampen stain and rub with bar soap. Wash as usual.
- Liquid fabric softeners will be dispensed during the final rinse and should not be combined with bleach, bluing, starch, detergents, soaps or packaged water conditioners.
- Fabric softener is not to be used in dispenser when using Prewash cycle, if available.
- When adding detergent to wash water, do not allow any to enter into softener dispenser cup, as softener will become gummy.

To prevent softener buildup, the dispenser can be filled with clean water for automatic cleaning. This can be done in washing cycles other than when softener is used.

# Clothing Care

## Clothing Concerns

To keep clothes looking white or bright, use good washing practices at all times to prevent a gradual

build-up of soil or water hardness minerals on them. If you notice that your clothes are not as bright as they should be, take corrective measures immediately.

Problem	Cause	Solution
Gray or Dingy Clothes	Insufficient Detergent	Add more detergent to washtub before loading clothes. Mild detergents are not suitable for average soil.
	Improper Sorting	Wash whites separately. Separate light from heavily soiled items. Clothes can pick up soil from dirty wash water.
	Nonphosphate Detergent and Hard Water	Follow package directions. Soften water if possible.
	Water Not Hot Enough	White clothes will stay whiter with hot wash water. Increase temperature.
	Overcrowding Washer	Clothes must circulate freely through the water for best results.
Yellowed Clothes	Unremoved Soil	Skin soil is hard to remove. Check hem edge of sheets and pillowcases, bottom end of t-shirts, etc. If this portion is white and center is yellow, the fabric contains unremoved soil. Use sufficient detergent and a hot wash. Chlorine bleach may be needed.
	Clothes Stained From Iron in the Water	To test if an iron stain, use a rust remover on a portion of the garment. Follow bottle directions for larger items.
	Older Clothes	Some white fabrics turn yellow with age and cannot be whitened.
Clothes Tearing or Damaged	Improper Use of Chlorine Bleach	No correction for bleach damaged clothes. Always measure and dilute bleach. Take extra care to avoid unwanted spilling.
	Overcrowding or Overloading	Make sure all items can move freely during agitation.
	Insufficient Pre-care	Fasten all hooks and zippers. Mend tears. Remove objects from pockets.
Excessive Lint	Improper Sorting	Fabrics which shed lint cannot be washed with fabrics that receive lint.
	Insufficient Detergent / Non-phosphate Detergent	Use enough detergent so lint remains suspended in water and flushed out.
	Mixing Fabric Types	Knits and Permanent Press attract lint. Wash these only with similar items. Use fabric softener in rinse water.
Wrinkling	Improper Sorting	Heavy items like towels should not be washed with light items like nightgowns.
	Too Many Clothes in Washer	Clothes must circulate freely through the water for best results.
	Improper Cycle	Make sure cycle selected is appropriate for type of clothes.
	Improper Temperature	Using a warm or cold wash and a cold rinse reduces wrinkling.

# Maintenance

---

## Cold Weather Care

- If the washer is *delivered on a cold day (below freezing), or is stored in an unheated room or area during the cold months, do not attempt to operate it until the washer has had a chance to warm up.*

## Care of Your Washer

- Use only a damp or sudsy cloth for cleaning the control panel. Some spray pretreat products may harm the finish on the control panel.
- Wipe the washer cabinet as needed. If detergent, bleach or other washing products are spilled on the cabinet, wipe immediately. Some products will cause permanent damage if spilled on the cabinet.
- Do not use scouring pads or abrasive cleansers.
- The washtub will need no particular care though it may need rinsing or wiping after an unusual load has been washed. This also may be necessary if too little detergent has been used.
- Leave the lid open to allow the inside of the washer to dry out after use. This helps prevent musty odors from developing.
- Check the filter screens in the fill hoses for debris or damage at least once a year. Clean or replace them if necessary.

## Replacing Hoses

- Hoses and other natural parts *deteriorate after extended use. Hoses may develop cracks, blisters or material wear from the temperature and constant high pressure they are subjected to.*
- All hoses should be checked on a monthly basis for any visible signs of deterioration. Any hose showing the signs of deterioration listed above should be replaced immediately.
- All hoses should be replaced every five years.

## Vacations and Extended Non-Use

- To avoid possible property damage due to flooding, turn off the water supply to the washer whenever there will be an extended period of non-use.



## Reinstallation of Shipping Materials

You must install the shipping brace and shipping plug any time the washer is moved.

### Shipping Brace

- The shipping brace in the lid opening should be saved and reinstalled whenever the washer is moved. To reinstall the brace, open the washer lid and place the brace over the washer agitator, placing the back of the brace into the washtub first.

### Shipping Plug

- The plastic shipping plug should be saved and reinstalled any time the washer is moved. The plug fits into two openings: The base opening and the shipping plug opening on the bottom of the mobile pivot dome. The plug **MUST** be inserted into both openings to prevent damage to the washer. In order to accomplish this, the shipping plug opening must be directly lined up with the base opening. Refer to illustrations below.

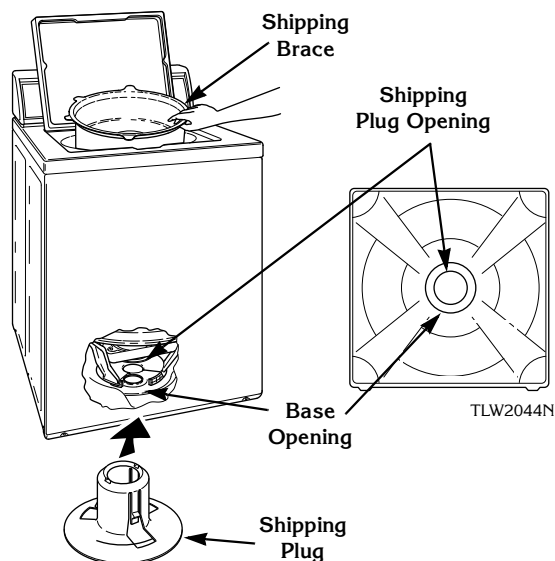

- After the shipping brace has been installed in the lid opening, tilt washer back enough to access base opening.
- Insert shipping plug into base opening and, using the palm of your hand, push shipping plug into washer until it snaps into shipping plug opening.

### Motor Overload Protector

- The internal motor overload protector will stop the motor automatically if there are too many clothes in the washtub or if a failure has occurred within the machine. The overload protector will reset itself in two or three minutes and the motor will restart automatically. If the overload protector stops the motor again, remove the washer from use and call the service person to correct the problem.

## Preventative Maintenance

Follow these guidelines to ensure the washer operates properly. Call for service if you observe any

of the following: water of any amount on the floor, an increase in operating noise or water remaining in the washtub after a cycle.

Frequency	Maintenance Procedure
Monthly	<ol style="list-style-type: none"><li>1. Check all hoses and the drain for leaks.</li><li>2. Check the lid switch for proper operation.</li><li>3. Check to make sure the washer is level.</li></ol>
Every six months	Clean the filter screen in the fill hoses.
Every five years	Have a qualified service technician conduct general preventative maintenance on the washer to ensure it operates properly.

## Optional Control Knob Inserts

Your unit has come equipped from the factory with a gray background on the control panel knobs. If you wish to change the color, additional color inserts are available at additional cost through your dealer.

# Troubleshooting

Try these troubleshooting tips before making a service call. You may save time and money!

Washer Symptom	Possible Cause / Solution
Won't Fill	<ul style="list-style-type: none"> <li>• Make sure power cord is plugged all the way into the electrical outlet.</li> <li>• Make sure hot and cold water faucets are turned on.</li> <li>• Make sure that the fill hoses are not kinked or twisted.</li> <li>• Pull timer knob out to start washer.</li> <li>• Make sure that the controls are properly set.</li> <li>• Make sure that the last spin has been completed.</li> <li>• Check the house fuse or circuit breaker.</li> <li>• Clean the screens in the water mixing valve and the filter screens located at the faucet end of the fill hoses. (Owner is responsible for service calls regarding cleaning of the screens.)</li> <li>• Water is being siphoned from the washer during the cycle. Refer to the Installation Instructions to make sure that the drain hose has been properly installed.</li> </ul>
Won't Start	<ul style="list-style-type: none"> <li>• Make sure lid is closed.</li> <li>• Pull timer knob out to start washer.</li> <li>• Make sure power cord is plugged all the way into the electrical outlet.</li> <li>• Make sure that the controls are properly set.</li> <li>• Check the house fuse or circuit breaker.</li> <li>• The motor overload protector may have stopped the cycle. It will reset itself in two or three minutes and restart the washer automatically.</li> </ul>
Won't Agitate	<ul style="list-style-type: none"> <li>• Make sure lid is closed.</li> <li>• Pull timer knob out to start washer.</li> <li>• Make sure power cord is plugged all the way into the electrical outlet.</li> <li>• Check the house fuse or circuit breaker.</li> <li>• The motor overload protector may have stopped the cycle. It will reset itself in two or three minutes and restart the washer automatically.</li> <li>• Broken drive belt. Call the service person.</li> </ul>
Won't Spin	<ul style="list-style-type: none"> <li>• Make sure lid is closed.</li> <li>• Pull timer knob out to start washer.</li> <li>• Make sure power cord is plugged all the way into the electrical outlet.</li> <li>• Check the house fuse or circuit breaker.</li> <li>• The motor overload protector may have stopped the cycle. It will reset itself in two or three minutes and restart the washer automatically.</li> <li>• Broken drive belt. Call the service person.</li> </ul>
Stops/Pauses During Cycle	<ul style="list-style-type: none"> <li>• Pauses are part of the washer's normal operation. The washer will stop (pause) shortly before the wash and rinse spins.</li> <li>• Check the house fuse or circuit breaker.</li> <li>• The motor overload protector may have stopped the cycle. It will reset itself in two or three minutes and restart the washer automatically.</li> </ul>
Won't Drain	<ul style="list-style-type: none"> <li>• Make sure drain hose is not kinked or twisted.</li> <li>• Make sure drain hose is not clogged.</li> <li>• Make sure drain receptacle is not clogged.</li> <li>• Refer to the Installation Instructions to make sure that the drain hose has been properly installed.</li> </ul>

continued

Washer Symptom	Possible Cause / Solution
Water Leaks	<ul style="list-style-type: none"> <li>• Check that fill hoses are properly installed on the faucets and the washer's water mixing valve.</li> <li>• Replace the fill hoses every five years.</li> <li>• Make sure drain receptacle is not clogged.</li> <li>• Check house plumbing.</li> <li>• Laundry load may be oversudsing or overloaded. Use less detergent (or low-sudsing detergent) and proper load sizes.</li> </ul>
Is Noisy	<ul style="list-style-type: none"> <li>• Wash load may be unbalanced. Open lid and redistribute the load.</li> <li>• Make sure washer is level. Uneven leveling can cause vibration.</li> <li>• A newly installed washer may make a knocking sound if the machine has been in storage. The belt may have settled. Run washer through 4-5 cycles to loosen belt. Washer operation will not be affected.</li> </ul>
Load Is Too Wet	<ul style="list-style-type: none"> <li>• Wash load may be unbalanced. Open lid and redistribute the load.</li> <li>• Load is too small. Add items to make full load.</li> <li>• Make sure the correct spin speed is selected for the type of items being washed (if option is available on your model).</li> </ul>
Wrong Water Temperature	<ul style="list-style-type: none"> <li>• Make sure that the controls are properly set.</li> <li>• Check fill hoses. Make sure hot faucet hose is connected to hot mixing valve (indicated with "H" on the valve bracket) and cold faucet is connected to cold mixing valve (indicated with "C" on the valve bracket).</li> <li>• Make sure house water heater is adjusted properly.</li> </ul>
Low Water Level on Extra Large Setting	<ul style="list-style-type: none"> <li>• Starting January 2009, the Department of Energy (DOE) mandated new efficiency standards which resulted in reduced water levels in the topload washer.</li> </ul>

## Contact Information

If service is required, contact the nearest Factory Authorized Service Center. To find the nearest service center, visit us online at [www.speedqueen.com](http://www.speedqueen.com).

If you are unable to locate an authorized service center or are unsatisfied with the service performed on your unit, contact:

**Speed Queen**  
**Shepard Street**  
**P.O. Box 990**  
**Ripon, Wisconsin 54971-0990**  
**[www.speedqueen.com](http://www.speedqueen.com)**  
**Phone: (920)748-3121**

Date Purchased \_\_\_\_\_

Model Number \_\_\_\_\_

Serial Number \_\_\_\_\_

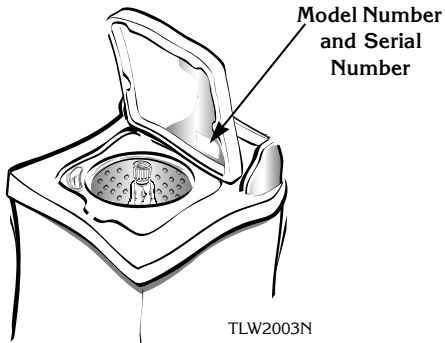

When contacting us about your washer, PLEASE GIVE THE MODEL AND SERIAL NUMBERS. The model and serial numbers are located on the nameplate. The nameplate will be in the location shown. Please include a copy of your bill of sale and any service receipts you have.

If replacement parts are required, contact the source from where you purchased your washer or visit us online at [www.speedqueen.com](http://www.speedqueen.com).

	<h2>WARNING</h2>
<p><b>To reduce the risk of serious injury or death, DO NOT repair or replace any part of the washer or attempt any servicing unless specifically recommended in the user-maintenance instructions or in published user-repair instructions that you understand and have the skills to carry out.</b></p>	
<small>W025</small>	



## Free Manuals Download Website

<http://myh66.com>

<http://usermanuals.us>

<http://www.somanuals.com>

<http://www.4manuals.cc>

<http://www.manual-lib.com>

<http://www.404manual.com>

<http://www.luxmanual.com>

<http://aubethermostatmanual.com>

Golf course search by state

<http://golfingnear.com>

Email search by domain

<http://emailbydomain.com>

Auto manuals search

<http://auto.somanuals.com>

TV manuals search

<http://tv.somanuals.com>