

# CAPTAIN BONES GOLD™

## INSTRUCTIONS

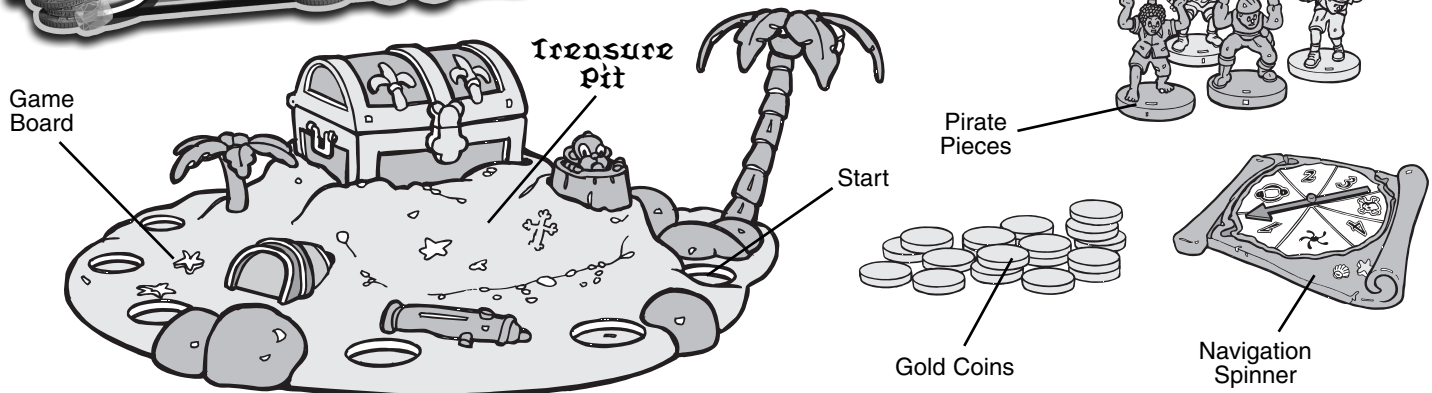

### BATTERY INSTALLATION

1. Using a Phillips screwdriver, unscrew and remove the battery cover.
2. Insert 3 AA Alkaline batteries as shown, making sure that the (+) and (-) are facing the correct way.
3. Replace the screw and battery door.

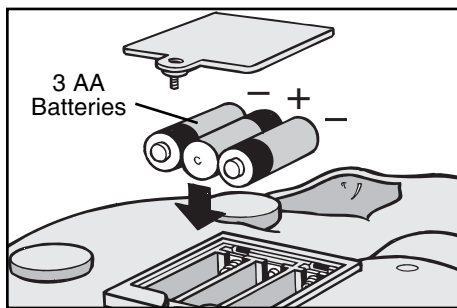

#### Contents:

- Captain Bones Gold™ 3D Game Board
- Navigation Spinner
- 4 Pirate Pieces
- 12 Plastic Magnetic Gold Coins

### GAME SETUP

1. Align joining pegs of the game board 2nd section with the slots in the main section of the game board and press it into place.

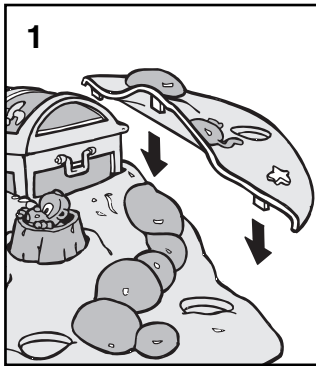

2. Add trees to the Game Board.

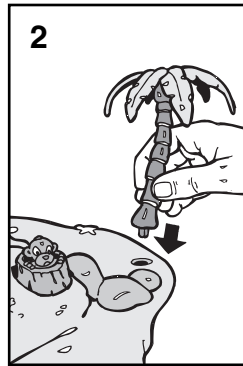

3. Turning the game ON. The ON/OFF switch is located on the underside of the Game Board.

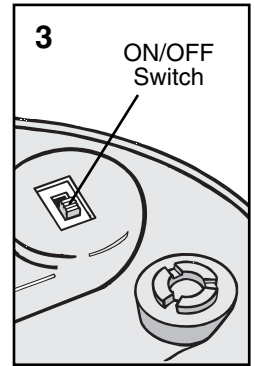

### GAME COMPONENTS

#### NAVIGATION SPINNER

- **Switch Places**, means to move into the lead position.

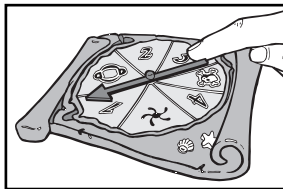

This would be the first available position ahead of every one else on the game board. If you already occupy that space, then you stay where you are.

- **Spin Again**, simply means to respin.

- **Lose a Turn**, means you miss your turn.

#### THE MONKEY

- After each player's turn, they push down the Monkey to activate the Treasure Chest.
- The Skeleton comes to life. Will someone lose their Gold Coin and have to start over?

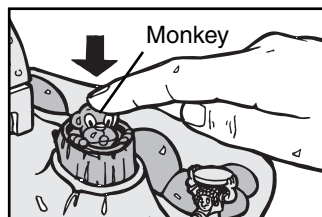

#### THE TREASURE CHEST

- The Treasure Chest contains the Skeleton who comes to life when the Monkey is pushed down.
- If the Skeleton grabs a Gold Coin, remove the coin and return it to the Treasure Pit.
- The Treasure Chest must be closed again at the end of each turn.

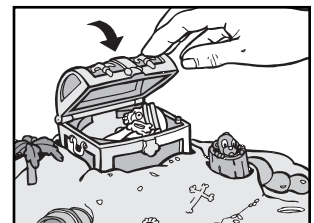

## HOW TO PLAY THE GAME

**Object: The first player to collect 3 Gold Coins wins!**

1. Every player spins the wheel and the player with the highest number goes first (tied players have a spin-off).

2. The first player puts a Gold Coin on his Pirate Piece and puts it on the start position. He then spins until he gets a number and advances that many positions.

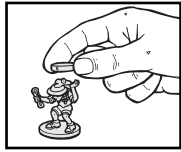

3. All the other players repeat step 2 (if you land on another player take the next available space ahead).

4. The first player spins again and gets either a number or a symbol. If you get a symbol you must obey the instruction (See Game Components). If you land on a

number advance that number of places.

5. At the end of your turn, push down the Monkey.

**IF CAPTAIN BONES TAKES YOUR GOLD YOU ARE REMOVED FROM THE ISLAND AND MUST START AGAIN. PUT THE COIN BACK IN THE TREASURE PIT.**

6. Each player repeats steps 4 and 5.

7. If on your turn you pass or land on the finish position, take the Gold Coin as your own treasure and replace it with a Gold Coin from the Treasure Pit. Remember to press the Monkey at the end of your turn.

8. The game is on until someone can collect 3 Gold Coins!

### BATTERY SAFETY INFORMATION:

- Non-rechargeable batteries are not to be recharged.
- Rechargeable batteries are only to be charged under adult supervision (if removable).
- Battery should always be replaced by an adult.
- Do not mix old and new batteries.
- Do not mix alkaline, standard (carbon-zinc) or rechargeable(nickel-cadmium) batteries.
- Different types of batteries, or new and used batteries are not to be mixed.
- Only batteries of the same or equivalent type as recommended are to be used.
- Batteries are to be inserted with the correct polarity.
- Exhausted batteries are to be removed from the toy.
- The supply terminals are not to be short-circuited.
- Rechargeable batteries are to be removed from the toy before being charged (if removable).
- Please retain this information for future reference.

Manufactured for Spin Master Ltd.  
Spin Master Ltd., 450 Front Street West, Toronto,  
ON M5V 1B6 Canada  
Spin Master, Inc., PMB #10053, 300 International Drive,  
Suite 100, Williamsville, NY 14221, USA  
Spin Master Toys Far East Limited, Rm #1113, 11/F,  
Chinachem Golden Plaza, 77 Mody Rd., Tsimshatsui E.,  
Kowloon, HK  
Spin Master France SAS, 36 rue de Silly,  
92100 Boulogne, France

North American Consumer Information  
Phone: 1-800-622-8339  
[www.spinmaster.com](http://www.spinmaster.com)

Captain Bones Gold TM is a trademark  
of Spin Master Ltd.  
© 2005 Spin Master Ltd. All Rights Reserved.  
Please retain this information for future  
reference. Please remove all packaging material  
before giving to children. Products and colors  
may vary. MADE IN CHINA.

Item #34049 REV 3 US English



## Free Manuals Download Website

<http://myh66.com>

<http://usermanuals.us>

<http://www.somanuals.com>

<http://www.4manuals.cc>

<http://www.manual-lib.com>

<http://www.404manual.com>

<http://www.luxmanual.com>

<http://aubethermostatmanual.com>

Golf course search by state

<http://golfingnear.com>

Email search by domain

<http://emailbydomain.com>

Auto manuals search

<http://auto.somanuals.com>

TV manuals search

<http://tv.somanuals.com>