



**SPIRIT** FITNESS

*A Heritage of Quality | The Spirit of Innovation*



# **XE395** Elliptical **Trainer** OWNER'S MANUAL

Please carefully read this entire manual before operating your new elliptical



Product Registration	1
Important Safety Instructions	2
Important Electrical Instructions	3
Important Operation Instructions	4
<b>XE395</b> Assembly Instructions	5
Product Features	12
Operation of Your Console	14
Programmable Features	17
Using A Heart Rate Transmitter	24
General Maintenance	26
Manufacturer's Limited Warranty	27

ATTENTION

This elliptical is intended for residential use only and is warranted for this application. Any other application voids this warranty in its entirety.





**Congratulations on your new elliptical and welcome to the Spirit Fitness family!**

Thank you for your purchase of this quality group elliptical from Spirit Fitness. Your new elliptical was manufactured by one of the leading fitness manufacturers in the world and is backed by one of the most comprehensive warranties available. Through your dealer, Spirit Fitness will do all we can to make your ownership experience as pleasant as possible for many years to come. If not purchased direct from Spirit Fitness, the local dealership where you purchased this elliptical is your administrator for all Spirit Fitness warranty and service needs. Their responsibility is to provide you with the technical knowledge and service personnel to make your experience more informed and any difficulties easier to remedy.

Please take a moment at this time to record the name of the dealer, their telephone number, and the date of purchase below to make any future, needed contact easy. We appreciate your support and we will always remember that you are the reason that we are in business. Please complete and mail your registration card today and enjoy your new elliptical.

Yours in Health,  
Spirit Fitness

Name of Dealer \_\_\_\_\_  
Dealer Phone # \_\_\_\_\_  
Purchase Date \_\_\_\_\_

**Record Your Serial Number**

Please record the serial number of this fitness product in the space provided below.

Serial Number \_\_\_\_\_

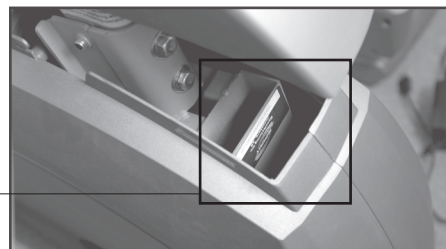

**Register Your Purchase**

The self-addressed product registration card must be completed in full and returned to Spirit Fitness. You can also go to <https://www.spiritfitness.com/residentialwarrantyregistration.html> to register online.

XE395\_20110623

**WARNING** - Read all instructions before using this appliance.

If using the optional power supply:

**DANGER** - To reduce the risk of electric shock disconnect your Spirit Fitness elliptical from the electrical outlet prior to cleaning and/or service work.

**WARNING** - To reduce the risk of burns, fire, electric shock, or injury to persons, install the elliptical on a flat level surface with access to a 110-volt, 15-amp grounded outlet with only the elliptical plugged into the circuit.

DO NOT USE AN EXTENSION CORD UNLESS IT IS A 14AWG OR BETTER, WITH ONLY ONE OUTLET ON THE END:

- Do not operate elliptical on deeply padded, plush or shag carpet. Damage to both carpet and elliptical may result.
- Keep children away from the elliptical. There are obvious pinch points and other caution areas that can cause harm.
- Keep hands away from all moving parts.
- Never operate the elliptical if it has a damaged cord or plug. If the elliptical is not working properly, call your dealer.
- Keep the cord away from heated surfaces.
- Do not operate where aerosol spray products are being used or where oxygen is being administered. Sparks from the motor may ignite a highly gaseous environment.
- Never drop or insert any object into any openings.
- Do not use outdoors.
- To disconnect, turn all controls to the off position, then remove the plug from the outlet.
- Do not attempt to use your elliptical for any purpose other than for the purpose it is intended.
- The hand pulse sensors are not medical devices. Their purpose is to provide you with an approximate measurement in relation to your target heart rate. Use of a chest transmitter strap (sold separately) is a much more accurate method of heart rate analysis. Various factors, including the user's movement, may affect the accuracy of heart rate readings. The pulse sensors are intended only as exercise aids in determining heart rate trends in general.
- Wear proper shoes. High heels, dress shoes, sandals or bare feet are not suitable for use on your elliptical. Quality athletic shoes are recommended to avoid leg fatigue.

SAVE THESE INSTRUCTIONS - THINK SAFETY!

**WARNING!**

**NEVER** remove any cover without first disconnecting AC power. If voltage varies by ten percent (10%) or more, the performance of your elliptical may be affected. Such conditions are not covered under your warranty. If you suspect the voltage is low, contact your local power company or a licensed electrician for proper testing.

**NEVER** expose this elliptical to rain or moisture. This product is NOT designed for use outdoors, near a pool or spa, or in any other high humidity environment. The operating temperature specification is 40 to 120 degrees Fahrenheit, and humidity is 95% non-condensing (no water drops forming on surfaces).

## Grounding Instructions

**This product must be grounded.** If the elliptical should malfunction or breakdown, grounding provides a path of least resistance for electric current, reducing the risk of electric shock. This product is equipped with a cord having an equipment-grounding plug. The plug must be plugged into an appropriate outlet that is properly installed and grounded in accordance with all local codes and ordinances.

**DANGER** - Improper connection of the equipment-grounding conductor can result in a risk of electric shock. Check with a qualified electrician or serviceman if you are in doubt as to whether the product is properly grounded. Do not modify the plug provided with the product if it will not fit the outlet; have a proper outlet installed by a qualified electrician.

This product is for use on a nominal 110-volt circuit, and has a grounding plug that looks like the plug illustrated below. A temporary adapter that looks like the adapter illustrated below may be used to connect this plug to a 2-pole receptacle as shown below if a properly grounded outlet is not available. The temporary adapter should be used only until a properly grounded outlet, (shown below) can be installed by a qualified electrician. The green colored rigid ear-lug, or the like, extending from the adapter; must be connected to a permanent ground such as a properly grounded outlet box cover. Whenever the adapter is used, it must be held in place by a metal screw.

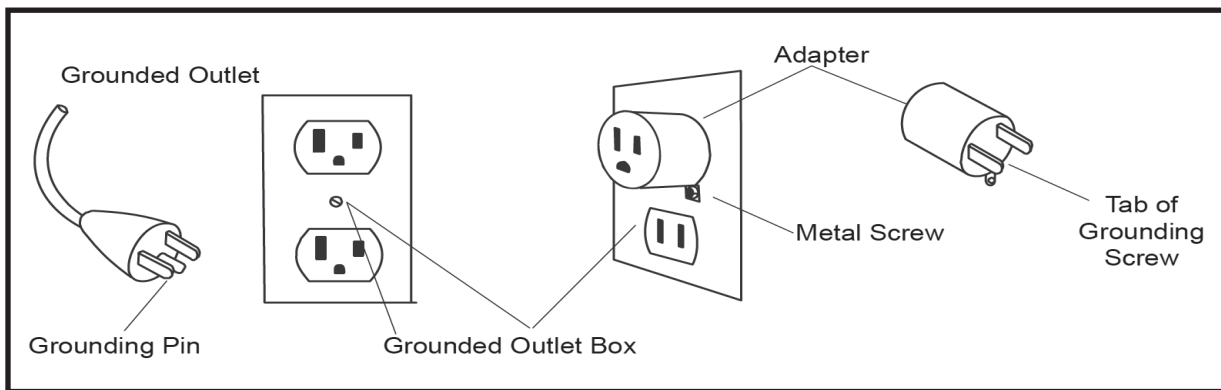

- **NEVER** operate this elliptical without reading and completely understanding the results of any operational change you request from the computer.
- Understand that changes in resistance do not occur immediately. Set your desired resistance level on the computer console and release the adjustment key. The computer will obey the command gradually.
- **NEVER** use your elliptical during an electrical storm. Surges may occur in your household power supply that could damage elliptical components. Unplug the elliptical during an electrical storm as a precaution.
- Use caution while participating in other activities while pedaling on your elliptical; such as watching television, reading, etc. These distractions may cause you to lose balance which may result in serious injury.
- Do not use excessive pressure on console control keys. They are precision set to function properly with little finger pressure.



## Assembly Video

To assist you in assembling your new Spirit Fitness elliptical, we have posted an assembly video at the following link: <http://www.spiritfitness.com/customerservice/video/ellipticalvideos.html>

## Pre-Assembly

1. Using a razor knife (Box Cutter), cut the banding straps that wrap around the carton. Reach under the bottom edge of the carton and pull it away from the cardboard underneath, separating the staples that join the two together. Lift the box over the unit and unpack.
2. Carefully remove all parts from carton and inspect for any damage or missing parts. If damaged parts are found, or parts are missing, contact your dealer immediately.
3. Locate the hardware package. The hardware is separated into four steps. Remove the tools first. Remove the hardware for each step as needed to avoid confusion. The numbers in the instructions that are in parenthesis (#) are the item number from the assembly drawing for reference.

## Assembly Tools

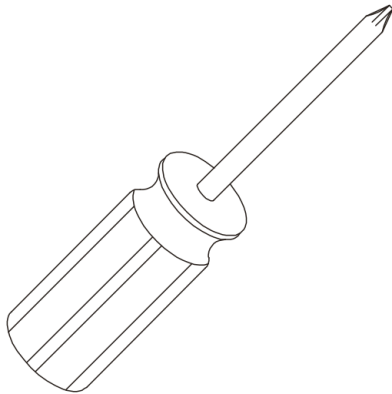

#126. Phillips Head  
Screwdriver

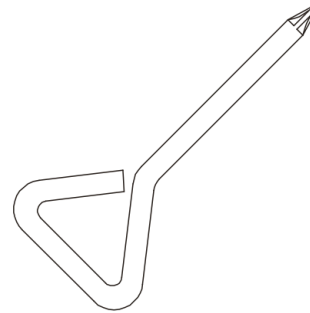

#125. Short Phillips  
Head Screw Driver

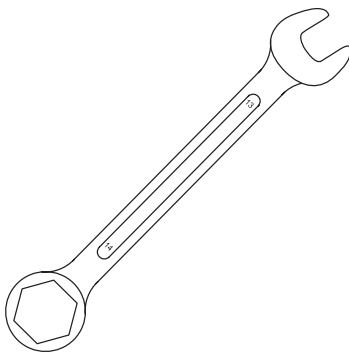

#124. 13/14mm  
Wrench

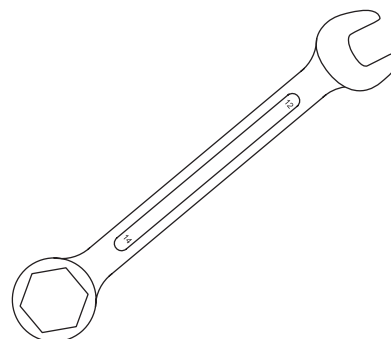

#129. 12/14mm  
Wrench

## STEP 1: Incline Rail & Console Mast

1. Slide the Incline Rail Assembly (2) into the U channel of the Main Frame (1). Be very careful not to damage the wires that exit each part.
2. Connect the Incline Rail Assembly (2) horizontally to the U channel of the Main Frame (1) with two Hex Head Bolts (77), two Flat Washers (96), and two Nyloc Nuts (89). Secure it vertically with four Hex Head Bolts (167), four split washers (178), four Flat Washers (100), and four star washers (179). Tighten using the wrenches provided (124 & 129).
3. Connect the Incline Motor wires (37 & 38) to the wiring harness & black wire that exits the Incline Rail Assembly (2). Push the excess cable inside the U channel.
4. Guide the twist tie that is attached to the Computer Cables (36 & 39) bundle through the Console Mast Cover (49) and the bottom of the Console Mast (12) until it exits the top of the steel tube **Note: make sure the console mast cover is positioned like the illustration.** Secure the Console Mast (12) by loosely threading two Hex Head Bolts (76) from the front and two Curved Washers (104) first. Then secure the mast from the side by loosely threading a Hex Head Bolt (75) and a Split Washer (128); **Note: there is one bolt already installed in the receiving bracket that will engage with the slot at the bottom of the Console Mast. Tighten the bolt from the left side last.**
5. Tighten the two front bolts first, then the side bolts with the wrench (124). Secure the Console Mast Cover (49) over the top of the plastic side covers (50 & 51).
6. Untie the twist tie, which is attached to the Computer Cables (36 & 39). Plug in the connectors of the two Hand pulse cables (44), Computer cable (36 & 39), Resistance cable (146), and Incline cable (146-1) in the bottom of the Console (32). Secure the Console (32) onto the mounting plate with four Phillips Head Screws (85). Tighten them with the Phillips Head Screw Driver (126).

## HARDWARE



**#96.** 3/8" x 19 x 1.5T  
Flat Washer  
(2 pcs)



**#100.** 5/16" x 20 x 1.5T  
Flat Washer  
(4 pcs)



**#104.** 3/8" x 23 x 1.5T  
Curved Washer  
(2 pcs)



**#128.** 3/8" x 2T  
Split Washer  
(1 pc)



**#85.** M5 x 10mm  
Phillips Head Screw  
(4 pcs)



**#89.** 3/8" x 7T  
Nyloc Nut  
(2 pcs)



**#178.** 5/16" x 1.5T  
Split Washer  
(4 pcs)



**#179.** 5/16"  
Star Washer  
(4 pcs)

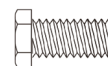

**#76.** 3/8" x 3/4"  
Hex Head Bolt  
(2 pcs)

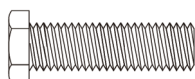

**#77.** 3/8" x 1-1/2"  
Hex Head Bolt  
(2 pcs)

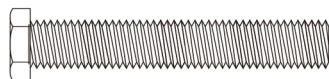

**#167.** 5/16" x 2-1/4"  
Hex Head Bolt  
(4 pcs)

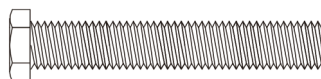

**#75.** 3/8" x 2-1/4"  
Hex Head Bolt  
(1 pc)

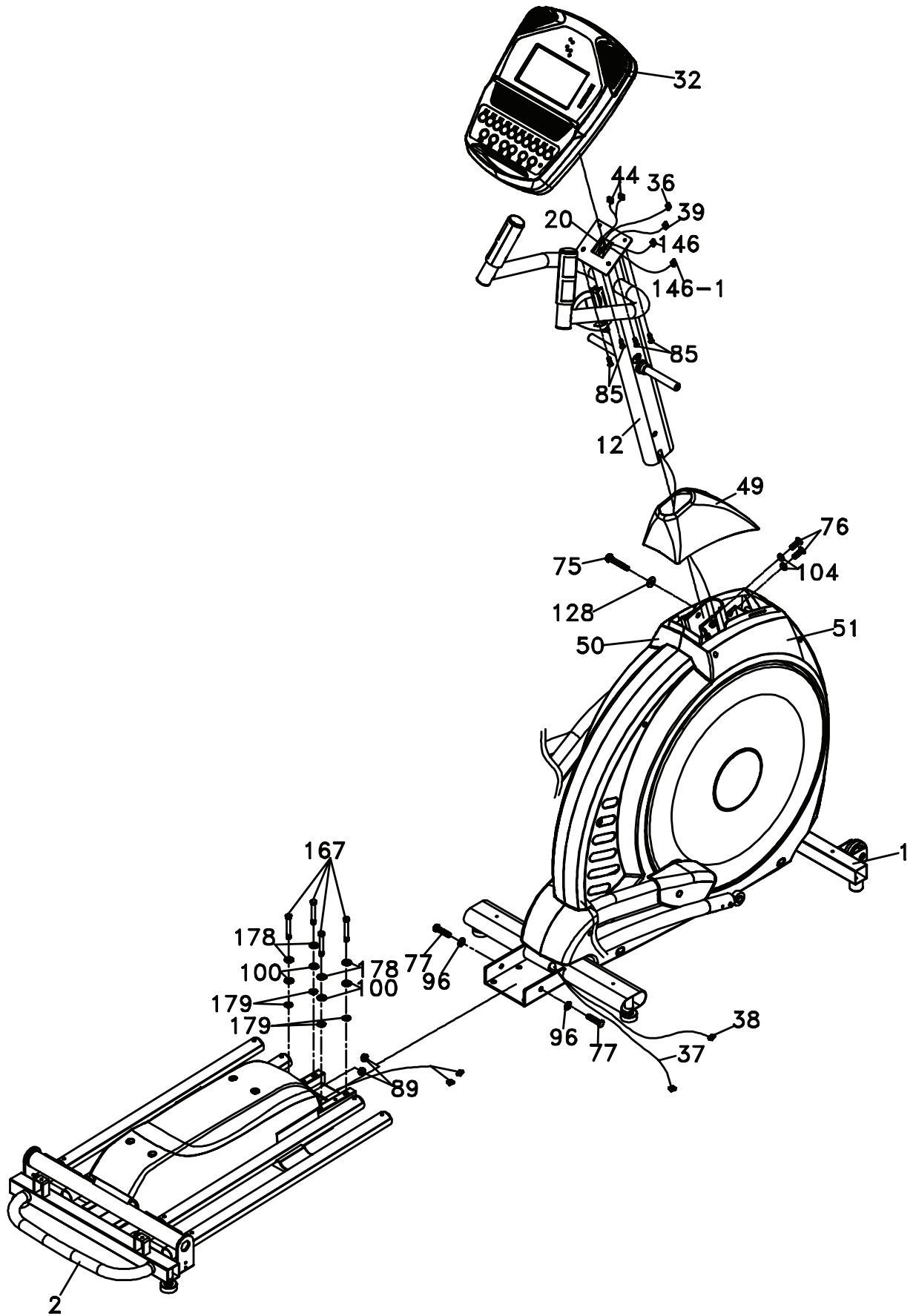

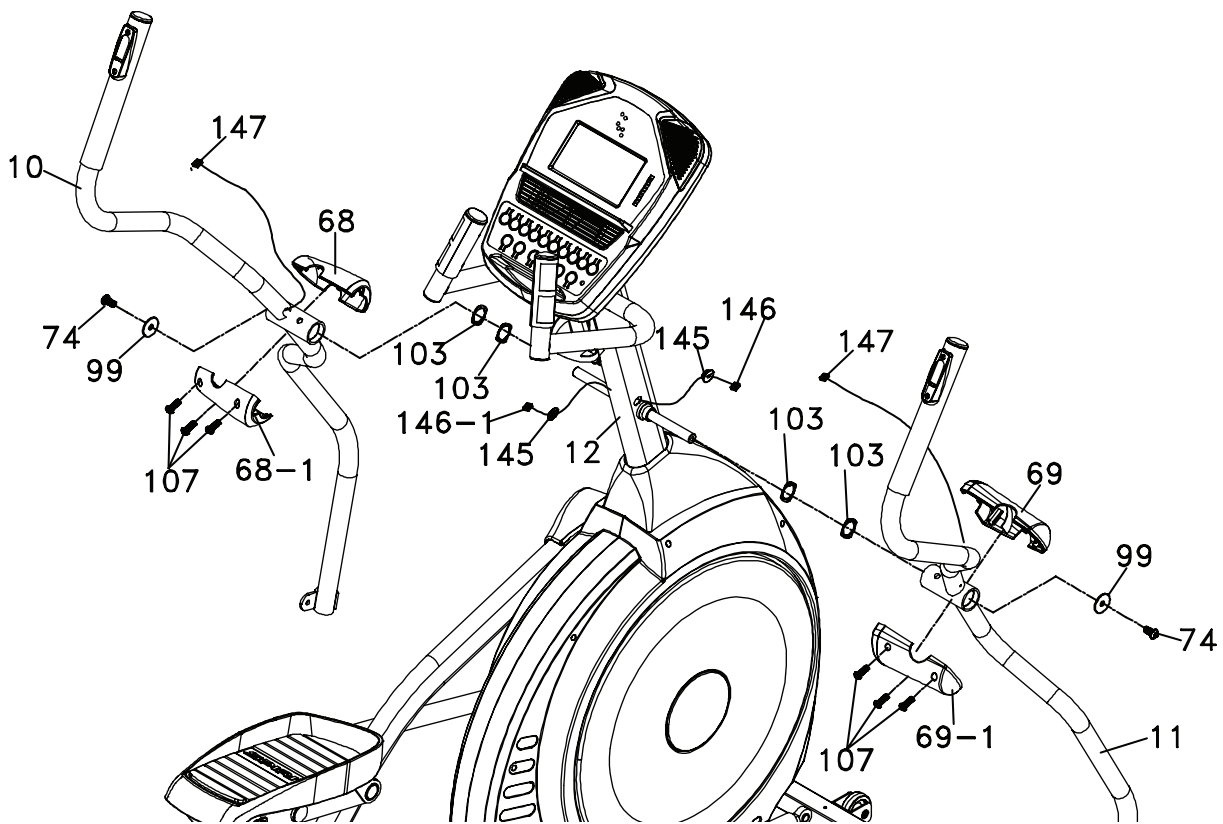

## STEP 2: Swing Arms

1. Place two Wave Washers (**103**) onto the left and right Console Mast shafts; Slide the left (**10**) and right (**11**) swing arms onto the shafts and secure with two Hex Head Bolts (**74**) and two Flat Washers (**99**); tighten with the wrench (**129**). Note: make sure the arms are placed on their respective shafts as shown in the illustration.
2. Slide a grommet (**145**) onto the left cable (**146-1**); connect that cable to the cable (**147**) of the left swing arm (**10**); snap the grommet into the hole on the side of the console mast tube, then push the excess amount of cable through the grommet. Repeat this process on the right side, connecting cables (**146** & **147**).
3. Match the Front Handle Bar Cover (L) (**68**) with Rear Handle Bar Cover (L) (**68-1**) on left Swing Arm (**10**) and secure with three Sheet Metal Screws (**107**). Tighten using the Phillips Head Screw Driver (**126**). Repeat for the right Swing Arm (**11**), matching covers (**69** & **69-1**).

## HARDWARE

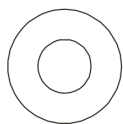

**#103.** 17mm  
Wave Washer  
(4 pcs)

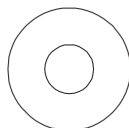

**#99.** 5/6" × 23 × 1.5T  
Flat Washer  
(2 pcs)

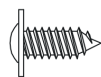

**#107.** 3.5 × 12mm  
Sheet Metal Screw  
(6 pcs)

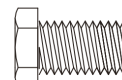

**#74.** 5/6" × 15mm  
Hex Head Bolt  
(2 pcs)



**#145.** Grommet  
(2 pcs)

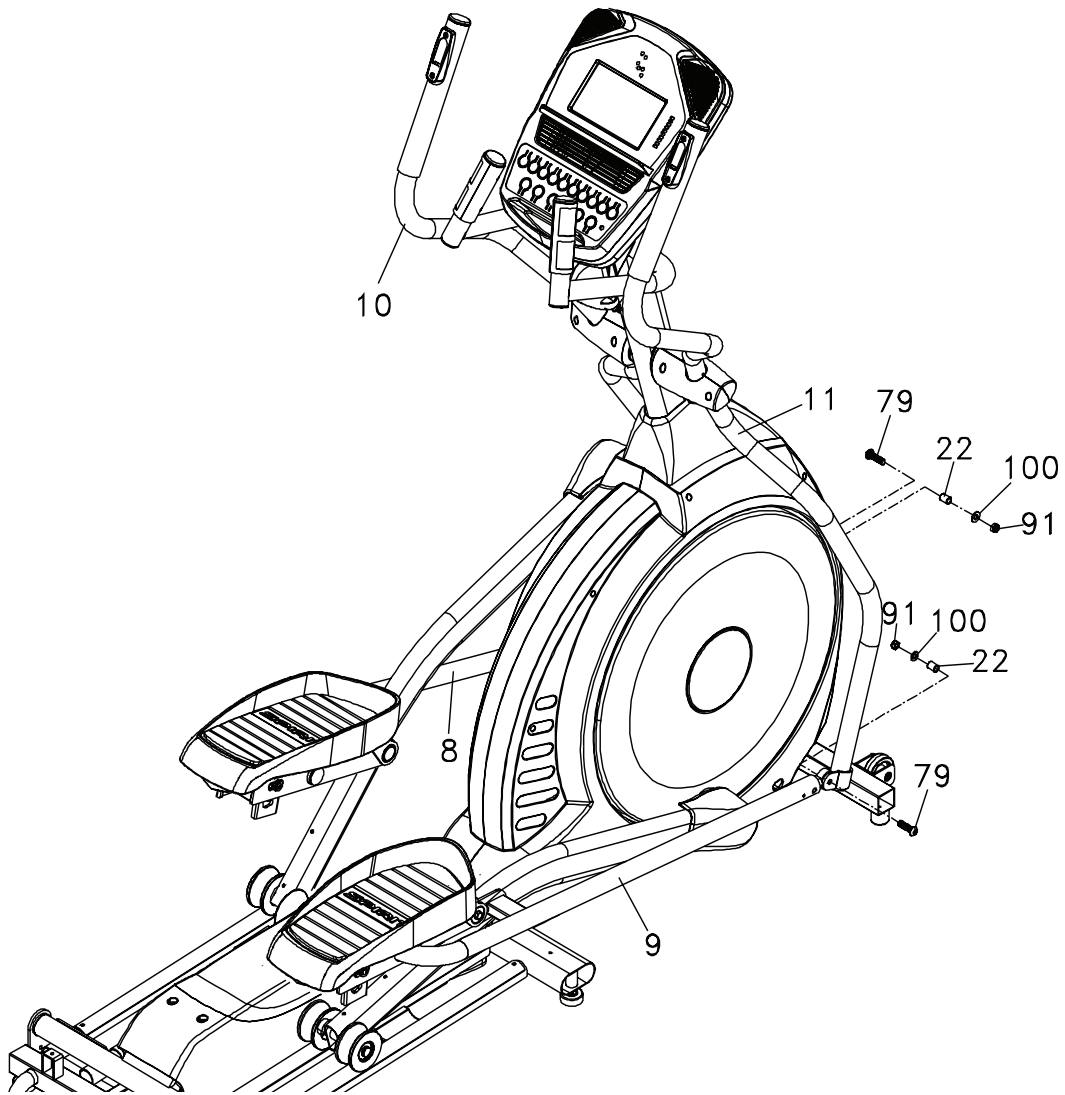

## STEP 3: Connecting Arm

1. Untie the wire on the Rod End Bearing; connect the Swing Arm (L) (**10**) with Connecting Arm (L) (**8**) and secure with a Hex Head Bolt (**79**), Rod End Sleeve (**22**), a Flat Washer (**100**), and a Nyloc Nut (**91**). Tighten using the wrenches provided (**124** & **129**).
2. Repeat the process for the Right Connecting Arm (R) (**9**) and Right Swing Arm (R) (**11**).

## HARDWARE

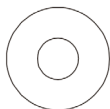

**#100.** 5/16" x 20 x 1.5T  
Flat Washer  
(2 pcs)

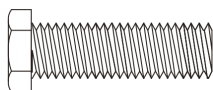

**#79.** 5/16" x 1-1/4" Hex  
Head Bolt  
(2 Pcs)



**#91.** 5/16" x 7T  
Nyloc Nut  
(2 pcs)

## STEP 4: Plastic Parts

1. Mate the Connecting Arm Covers (**71** and **72**) over the Left Connecting Arm (**8**) and secure with two Phillips Head Screws (**82**) and a Sheet Metal Screw (**107**). Tighten the screws using the Short Phillips Head Screw Driver (**125**). Repeat for the opposite side.
2. Install Roller Covers (**64**) onto each set of Rollers. Secure with four Phillips Head Screws (**82**). Tighten using the Phillips Head Screw Driver (**126**).
3. Attach the two covers (L-**60**) & (R-**61**) to the middle stabilizer tube (there is a sticker on the bottom side identifying each). Secure with a Phillips Head Screw (**82**) on each side. Secure with the Phillips Head Screw Driver (**126**).
4. Attach the Front Stabilizer Cover (**59**) to the front stabilizer tube with Use two Phillips Head Screws (**82**). Secure with the Phillips Head Screw Driver (**126**).
5. Attach a steel bracket (**156**) to the rear stabilizer tube on the left and right sides (with the single hole facing the rear), and secure them with four Phillips Head Screws (**157**). Secure using the Phillips Head Screw Driver (**126**).
6. Attach the front Rear Stabilizer Cover to the rear stabilizer tube with two Phillips Head Screws (**82**). Secure with the Phillips Head Screw Driver (**126**). Attach the back Rear Stabilizer Cover (**73-3**) onto the rear stabilizer tube with four Phillips Head Screws (**82**). Secure using the Phillips Head Screw Driver (**126**).
7. Plug in the electrical cord to a properly grounded outlet and turn on the power button, located at the bottom front of the unit. Raise the incline to Level "8" and attach the Incline Cover (**73**) with two Phillips Head Screws (**82**). Secure using the Phillips Head Screw Driver (**126**). Return the Incline to "0".
8. Look closely at the four floor levelers underneath the middle and rear of the elliptical. If any of these aren't in contact with the floor; use the wrench (**124**) to loosen the bottom nut. Once the nut has been loosened, turn the rubber pad clockwise until it makes solid contact with the floor. Retighten the bottom nut to prevent it from moving.

## HARDWARE



**#107.** 3.5 x 12mm  
Sheet Metal Screw  
(2 pcs)

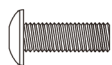

**#82.** M5 x 15mm  
Phillips Head Screw  
(20 pcs)



**#157.** M6 x 10mm  
Phillips Head Screw  
(4 pcs)



**#156.** Bracket  
(2 pcs)

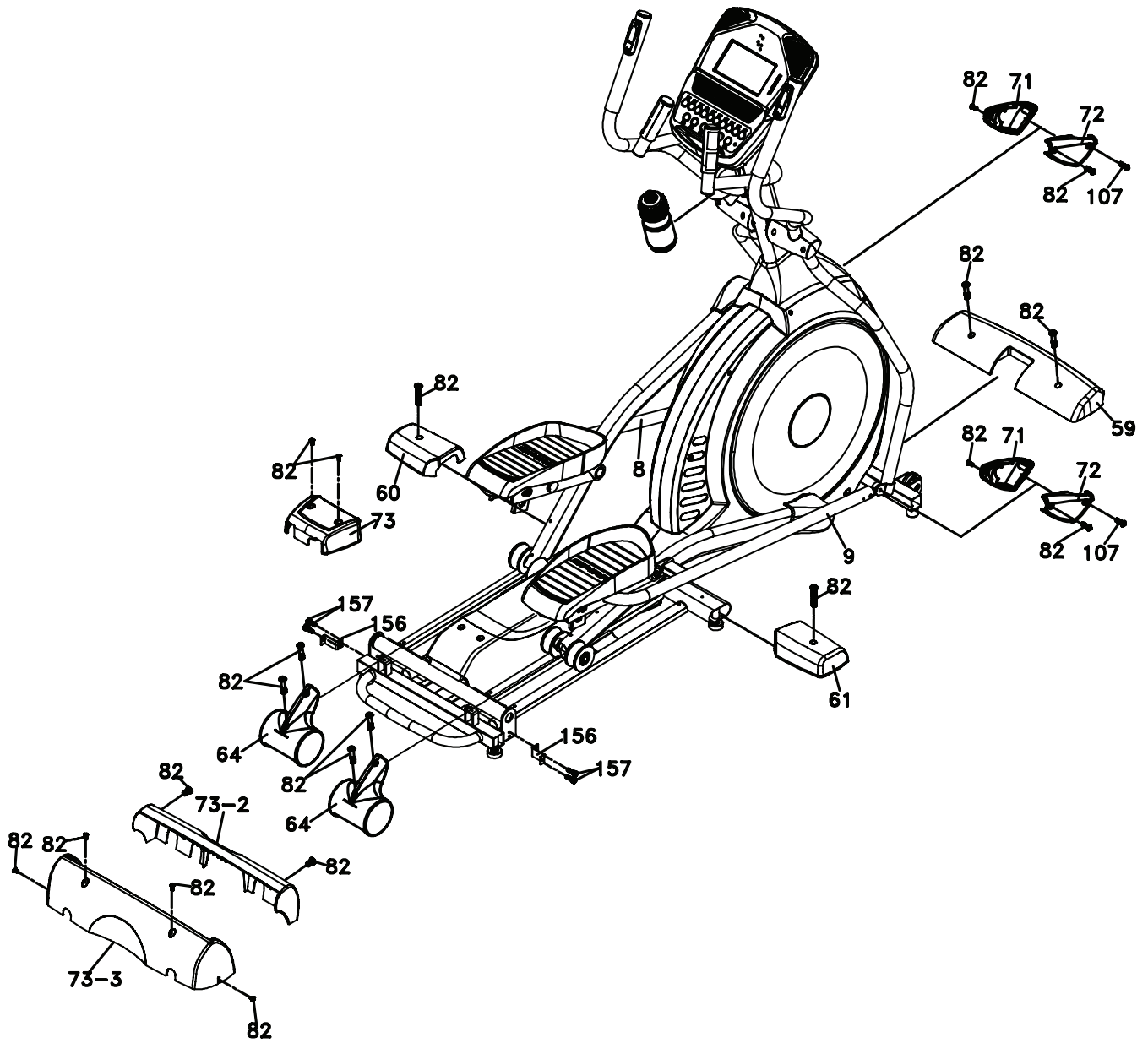

## Footpads

Through research performed with a leading sports scientist and physical rehabilitation expert, Spirit engineering has developed a breakthrough in pedal design. No other elliptical, at any price, offers these unique features. The history of elliptical use over the past few years tells us that many users suffer from numb toes while working out on elliptical trainers. Many other users complain of ankle, Achilles tendon, knee and/or hip pain. While researching a solution to these common problems Spirit engineers consulted Richard DeKok, P.T., M.T.C., of St. Bernards Industrial Rehabilitation Center in Jonesboro Arkansas.

Together we identified the inherent problem in elliptical designs and developed solutions to solve the problems. What we found is that when you use an elliptical you tend to push outward during the power stroke and not just straight back. This causes stress on the outer part of the foot and throws off the natural alignment of the joints. The second problem we found is that many people tend to stay up on the ball of their foot during the elliptical motion. Our solutions were simple but effective:

- The first solution was to add a 2-degree inward angle to the footpads. This might sound simple but what it achieves is not. Pedaling an elliptical, no matter how close together the pedals may be, puts the users musculoskeletal system out of neutral alignment. Adding the 2-degree angle positions the user back into a neutral alignment which eases the over stress of the outer ankles, knees, and hips.
- The second solution was to make the foot pedal adjustable to the user's style of pedaling the elliptical. We achieved this by adding an adjustment that allows the angle of the footpad to be changed. There are three positions available with a simple pull-pin adjustment located under the footpads (see illustration below). The lowest position will set the footpads at zero (0) degrees, or flat at the bottom of the elliptical stroke. The second position sets the footpad at five (5) degrees and the top position sets the footpads at ten (10) degrees. Because everybody is different, we found there is no one angle that fits every user. Some users are up on the balls of their feet, resulting in numb toes, so we decided to allow the user to adjust the back of the foot pad upward to support the heel, taking the pressure off of the nerves in the balls of the feet and the Achilles tendon. The result was relief from the toes going numb. Some users are uncomfortable at a fixed angle, therefore we added the adjustable pedal angles so they could find one that feels best for them. A great side benefit of the adjustable footpad angle is that you end up working the muscles of the lower extremities in a different way. At the highest angle, you will work the quadriceps more. At the lowest angle, you work the hamstrings and gluts harder.

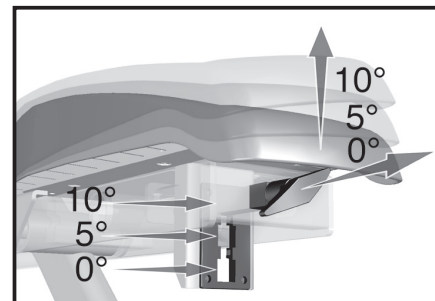



# Console

## MUSCLE ACTIVATION FIGURE

There is an anatomical figure located at the top of the console. This figure will light all areas that are activated when using the elliptical. These will light up during any of the programs. You can control which muscles are activated by changing the incline and swinging your arms. The pre-set programs will determine which lower body muscles will be activated by automatically adjusting the incline. Generally the following guidelines hold true:

- The upper body LED's will light any time your hands aren't in contact with the pulse grip sensors
- The lower body lights will activate in three degrees of engagement: Green represents minimal muscle involvement, Amber represents medium involvement, and Red represents full or heavy activation.
  - 0-4.5% Elevation: even muscle distribution, all four muscle groups will be Amber
  - 5-15% Elevation: Quads are Amber and Glutes, Hamstrings, and Calves are Red



## HEART RATE % PROFILE

The console LCD screen will display your current heart rate anytime a pulse is detected. The Bar Graph, located to the right of the LCD screen, will show your current heart rate % in relation to your projected maximum heart rate, which is determined by your age that you entered during the programming phase of any of the 10 programs. The significance of the bar graph colors are as follows:

- 50-60% of maximum is Amber
- 65-80% of maximum is Amber and Green
- 85-90% or more is Amber, Green, and Red

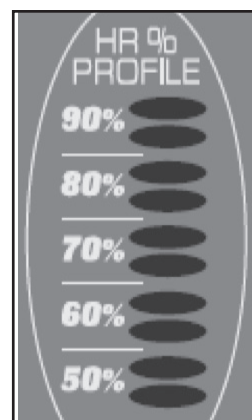

## XE395 Console



## Power

When the A.C. power cord is connected to the elliptical, the console will automatically power up. If there is no input to the console for 20 minutes the console will go to standby mode. In standby mode the console display will turn off. To turn the console on press any key.

When initially powered on the console will perform an internal self-test. During this time all the lights will turn on. When the lights go off, the Message Center will show the software version (i.e.: VER 1.0). The distance window shows the distance in miles and the time window shows the total hours of use.

The odometer will remain displayed for only a few seconds then the console will go to the start up display. The dot matrix display will be scrolling through the different profiles of the programs and the Message Center will be scrolling the start up message. You may now begin to use the console.

## Quick Start

This is the quickest way to start a workout. After the console powers up you just press the **Start** key to begin, this will initiate the Quick Start mode. In Quick Start the Time will count up from zero and the workload may be adjusted manually by pressing the **Level Up/Down** buttons. The dot matrix display will have only the bottom row lit at first. As you increase the work load more rows will light indicating a harder workout. The elliptical will get harder to pedal as the rows increase.

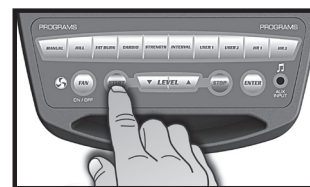

There are 20 levels of resistance available for plenty of variety. The first 5 levels are very easy workloads and the changes between levels are set to a good progression for de-conditioned users. Levels 6-10 are more challenging, but the increases in resistance from one level to the next remain small. Levels 11-15 start getting tough as the levels jump more dramatically. Levels 16-20 are extremely hard and are good for short interval peaks and elite athletic training.

## Basic Information

The Message Center will initially be displaying the Program name. When in scan mode during a program, speed will be displayed for four seconds, then move on and display Watts (indication of workload). If 100 watts is displayed, you are doing enough work to keep a 100-watt light bulb lit. The data changes to Laps completed, Segment time, Max level. Pressing the **Enter** button again will bring you back to the beginning.



The **Stop** button actually has several functions. Pressing the **Stop** key once during a program will pause the program for 5 minutes. If you need to get a drink, answer the phone or any of the many things that could interrupt your workout, this is a great feature. To resume your workout during Pause, just press the **Start** key. If the **Stop** button is pressed twice during a workout, the program will end and the console will display your Workout Summary (Total time, Avg. Speed, Avg. Watts, Avg. HR, total Laps). If the **Stop** key is held down for 3 seconds or a third time during the program, the console will perform a complete **Reset**. During data entry for a program the **Stop** key performs a previous screen or segment function. This allows you to go back to change programming data.

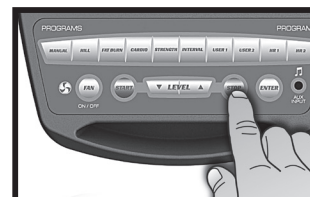

## Program Keys

The program keys are used to preview each program. When you first turn the console on you may press each program key to preview what the program profile looks like. If you decide that you want to try a program, press the corresponding program key and then press the **Enter** key to select the program and enter into the data-setting mode.

The elliptical has a built in heart rate monitoring system. Simply grasping the hand pulse sensors on the stationary handle bars or wearing the heart rate transmitter (see Using Heart Rate Transmitter section) will start the Heart Icon blinking (this may take a few seconds). The Pulse Display Window will display your heart rate, or Pulse in beats per minute.

The console includes a built-in fan to help keep you cool. To turn the fan on, press the button on the left side of the console.

## Programming The Console

Each of the programs can be customized with your personal information and changed to suit your needs. Some of the information asked for is necessary to ensure the readouts are correct. You will be asked for your Age and Weight. Entering your Age is necessary during the Heart Rate programs to ensure the correct settings are in the program for your Age. Otherwise the work settings could be too high or low for you. Entering your Weight aides in calculating a more correct Calorie reading. Although we cannot provide an exact calorie count, we do want to be as close as possible.

CALORIE NOTE: Calorie readings on every piece of exercise equipment, whether it is in a gym or at home, are not accurate and tend to vary widely. They are meant only as a guide to monitor your progress from workout to workout. The only way to measure your calorie burn accurately is in a clinical setting connected to a host of machines. This is because every person is different and burns calories at a different rate. Some good news is that you will continue to burn calories at an accelerated rate for at least an hour after you have finished exercising!

## Entering A Program And Changing Settings

When you enter a program, by pressing a program key, then **Enter** key, you have the option of entering your own personal settings. If you want to workout without entering new settings, then just press the **Start** key. This will bypass the programming of data and take you directly to the start of your workout. If you want to change the personal settings then just follow the instructions in the Message Center. If you start a program without changing the settings, the default or saved settings will be used.

NOTE: Age and Weight default settings will change when you enter a new number. So the last Age and Weight entered will be saved as the new default settings. If you enter your Age and Weight the first time you use the elliptical, you will not have to enter it every time you work out unless either your Age or Weight changes, or someone else enters a different Age and Weight.

# Manual

The Manual program works as the name implies, manually. This means that you control the workload and not the computer. To start the Manual program, follow the instructions below or just press the **Manual** button, then the **Enter** key and follow the directions in the Message Center.

1. Press the **Manual** key, then press the **Enter** key.
2. The Message Center will ask you to enter your Age. You may enter your age, using the **Up/Down** keys, then press the **Enter** key to accept the new value and proceed on to the next screen.
3. You are now asked to enter your Weight. You may adjust the Weight value using the **Up/Down** keys, then press **Enter** to continue.
4. Next is Time. You may adjust the Time and press **Enter** to continue.
5. Now you are finished editing the settings and can begin your workout by pressing the **Start** key. You can also go back and modify your settings by pressing the **Stop** key. **NOTE: At any time during the editing of Data you can press the Stop key to go back one level, or screen.**
6. Once the program starts you will be at level one. This is the easiest level and it is a good idea to stay at level one for a while to warm up. If you want to increase the work load at any time press the **Up** key; the **Down** key will decrease the work-load.
7. During the Manual program you will be able to scroll through the data in the Message Center by pressing the **Enter** key.
8. When the program ends you may press **Start** to begin the same program again or **Stop** to exit the program or you can save the program you just completed as a custom user program by pressing a **User** key and following the instructions in the Message Center.

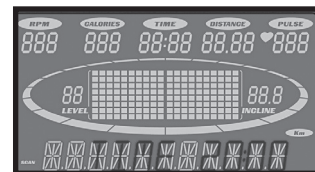
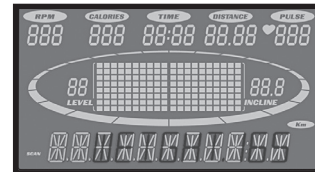
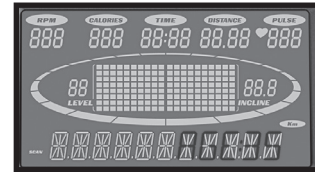

# Preset Programs

The elliptical has five different programs that have been designed for a variety of workouts. These five programs have factory preset work level profiles for achieving different goals.

## HILL

**Resistance:** This program follows a triangle or pyramid type of gradual progression from approximately 10% of maximum effort (the level that you chose before starting this program) up to a maximum effort which lasts for 10% of the total workout time, then a gradual regression of resistance back to approximately 10% of maximum effort.

**Incline:** The pedal elevation is a more gradual and sustained progression. Maximum elevation is in the middle of the workout and lasts for 10% of the duration.

RESISTANCE

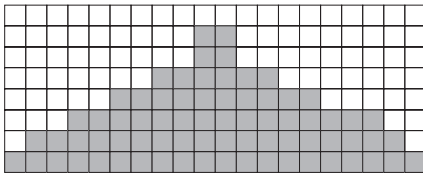

INCLINE

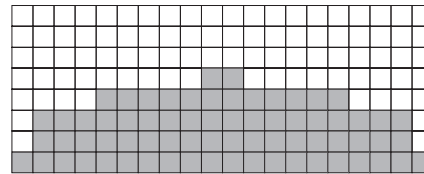

## FAT BURN

**Resistance:** This program follows a quick progression up to the maximum resistance level (default or user input level) that is sustained for 2/3 of the workout. This program will challenge your ability to sustain your energy output for an extended period of time.

**Incline:** The pedal elevation is a quick and sustained progression up to the maximum value (default or user input) for 90% of the workout duration.

RESISTANCE

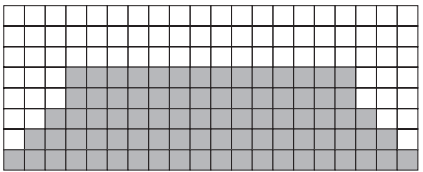

INCLINE

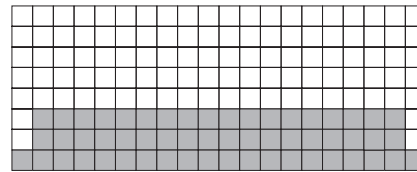

## CARDIO

**Resistance:** This program presents a quick progression up to near maximum resistance level (default or user input level). It has slight fluctuations up and down to allow your heart rate to elevate, and then recover repeatedly, before beginning a quick cool down. This will build up your heart muscle and increase blood flow and lung capacity.

**Incline:** The elevation in this program is moderate. There are several elevation spikes at different points of the workout. Segments 4, 9, and 14 are maximum elevation for this program.

RESISTANCE

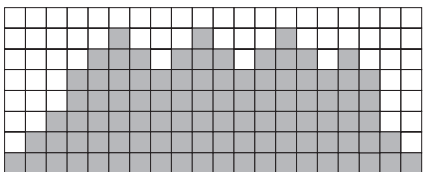

INCLINE

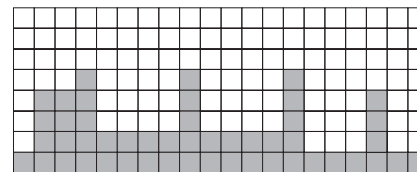

## STRENGTH

**Resistance:** This program has a gradual progression of resistance up to 100% of maximum effort that is sustained for 25% of workout duration. This will help build strength and muscular endurance in the lower body and gluts. A brief cool down follows.

**Incline:** There is a quick climb to a moderate, sustained elevation that lasts the majority of the workout length.

RESISTANCE

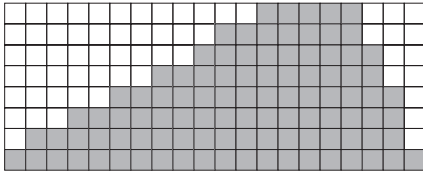

INCLINE

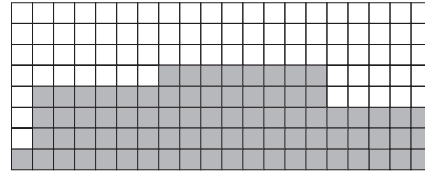

## INTERVAL

**Resistance:** This program takes you through high levels of intensity followed by recovery periods of low intensity. This program utilizes and develops your "Fast Twitch" muscle fibers which are used when performing tasks that are intense and short in duration. These deplete your oxygen level and spike your heart rate, followed by periods of recovery and heart rate drop to replenish oxygen. Your cardiovascular system gets programmed to use oxygen more efficiently.

**Incline:** This program will spike similar to the resistance profile, but in different segments (columns); this means that all of your lower extremity muscles will be equally challenged throughout this program. The incline alternates between 25 & 65 % of maximum elevation

RESISTANCE

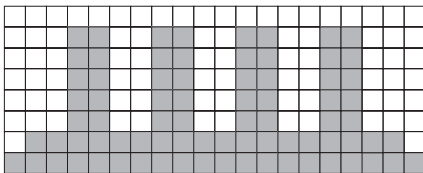

INCLINE

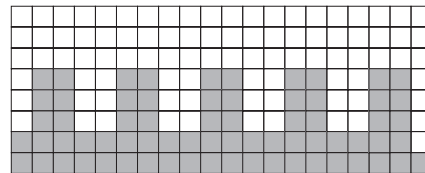

# Programming Preset Programs

1. Select the desired program button then press the **Enter** key.
2. The Message Center will ask you to enter your Age. You may adjust the age setting, using the **Level Up/Down** keys, then press the **Enter** key to accept the new number and proceed on to the next screen.
3. You are now asked to enter your Weight. You may adjust the Weight value using the **Level Up/Down** keys, then press **Enter** to continue.
4. Next is Time. You may adjust the time and press **Enter** to continue.
5. Now you are asked to adjust the Max Resistance Level. This is the peak exertion level you will experience during the program. Adjust the level and then press **Enter**.
6. Now you are finished editing the settings and can begin your workout by pressing the **Start** key. You can also go back and modify your settings by pressing the **Enter** key.
7. If you want to increase or decrease the resistance at any time during the program, press the **Level Up/Down** keys on the console or above the heart rate sensor grips of the stationary handlebars. This will change the resistance settings of the entire profile, although the profile picture on the screen will not change. The reason for this is so that you can see the entire profile at all times. If the profile picture is changed, it also would be distorted and not a true representation of the actual profile. When you make a change to the resistance, the Message Center will show the current column and program maximum levels of work.
8. During the program you will be able to scroll through the data in the message window by pressing the **Enter** key.
9. When the program ends the Message Center will show a summary of your workout. The summary will be displayed for a short time, then the console will return to the start-up display.

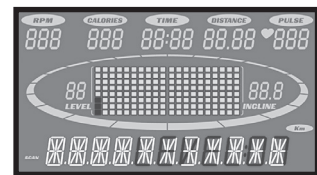
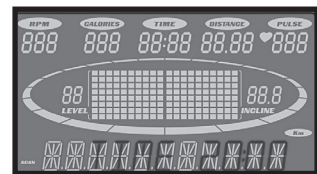
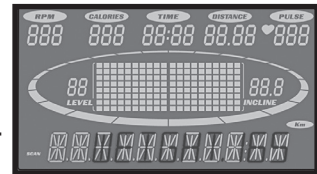
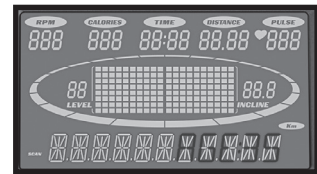



## Custom User Defined Programs

There are two customizable User programs that allow you to build and save your own workout. The two programs, **User 1** and **User 2**, operate exactly the same way so there is no reason to describe them separately. You can build your own custom program by following the instructions below or you can save any other preset program you complete as a custom program. Both programs allow you to further personalize it by adding your name.

1. Press the **User 1** or **User 2** key. The Message Center will show a welcome message. If you had previously saved a program the message will contain your name. Then press the **Enter** key to begin programming.
2. When you press **Enter**, the Message Center will show "Name - A", if there is no name saved. If the name "David" had been previously saved the Message Center will show "Name - David" and the D will be blinking. If there is a name saved you can change it or you may press the **Stop** key to keep the name and continue to the next step. If you want to enter a name use the **Up/Down** key to change the first letter then press **Enter** to save the first letter and continue to the next letter. When you have finished entering the name press the **Stop** key to save the name and continue to the next step.
3. The Message Center will ask you to enter your Age. You may enter your age, using the **Level Up/Down** keys, then press the **Enter** key to accept the new value and proceed on to the next screen.
4. You are now asked to enter your Weight. You may adjust the weight value using the **Up/Down** keys or the numeric key pad, then press **Enter** to continue.
5. Next is Time. You may adjust the time and press **Enter** to continue.
6. Now you are asked to adjust the Max Resistance Level of the program, press **Enter** when resistance has been selected.
7. Now the first column will be blinking and you are asked to adjust the resistance level for the first segment (SEGMENT > 1) of the workout by using the **Level Up** key. When you finish adjusting the first segment, or if you don't want to change, then press **Enter** to continue to the next segment.
8. The next segment will show the same workload resistance level as the previously adjusted segment. Repeat the same process as the last segment then press **Enter**. Continue this process until all twenty segments have been set.
9. The Message Center will then tell you to press **Enter** to save the program. After saving the program the Message Center says "New program saved" then will give you the option to start or modify the program. Pressing **Stop** will exit to the start up screen.

# Heart Rate Programs

The old motto, "no pain, no gain", is a myth that has been overpowered by the benefits of exercising comfortably. A great deal of this success has been promoted by the use of heart rate monitors. With the proper use of a heart rate monitor, many people find that their usual choice of exercise intensity was either too high or too low and exercise is much more enjoyable by maintaining their heart rate in the desired benefit range.

To determine the benefit range in which you wish to train, you must first determine your Maximum Heart Rate. This can be accomplished by using the following formula: 220 minus your age. This will give you the Maximum Heart Rate (MHR) for someone of your age. To determine the effective heart rate range for specific goals you simply calculate a percentage of your MHR. Your Heart rate training zone is 50% to 90% of your maximum heart rate. 60% of your MHR is the zone that burns fat while 80% is for strengthening the cardio vascular system. This 60% to 80% is the zone to stay in for maximum benefit.

For someone who is 40 years old their target heart rate zone is calculated:

$$220 - 40 = 180 \text{ (maximum heart rate)}$$

$$180 \times .6 = 108 \text{ beats per minute}$$

(60% of maximum)

$$180 \times .8 = 144 \text{ beats per minute}$$

(80% of maximum)

So for a 40 year old the training zone would be 108 to 144 beats per minute.

If you enter your age during programming the console will perform this calculation automatically. Entering your age is used for the Heart Rate programs. After calculating your MHR you can decide upon which goal you would like to pursue.

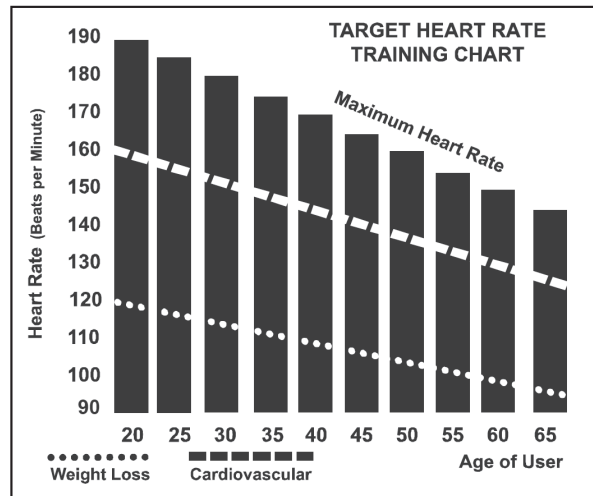

The two most popular reasons for, or goals, of exercise are cardiovascular fitness (training for the heart and lungs) and weight control. The black columns on the chart above represent the MHR for a person whose age is listed at the bottom of each column. The training heart rate, for either cardiovascular fitness or weight loss, is represented by two different lines that cut diagonally through the chart. A definition of the lines' goal is in the bottom left-hand corner of the chart. If your goal is cardiovascular fitness or if it is weight loss, it can be achieved by training at 80% or 60%, respectively, of your MHR on a schedule approved by your physician. Consult your physician before participating in any exercise program.

With all Spirit Fitness Heart Rate programs ellipticals you may use the heart rate monitor feature without using the Heart Rate program. This function can be used during manual mode or during any of the nine different programs. The Heart Rate program automatically controls resistance at the pedals.

# Rate of Perceived Exertion

Heart rate is important but listening to your body also has a lot of advantages. There are more variables involved in how hard you should workout than just heart rate. Your stress level, physical health, emotional health, temperature, humidity, the time of day, the last time you ate and what you ate, all contribute to the intensity at which you should workout. If you listen to your body, it will tell you all of these things.

The rate of perceived exertion (RPE), also known as the Borg scale, was developed by Swedish physiologist G.A.V. Borg. This scale rates exercise intensity from 6 to 20 depending upon how you feel or the perception of your effort.

The scale is as follows:

## Rating Perception of Effort

- 6 Minimal
- 7 Very, very light
- 8 Very, very light +
- 9 Very light
- 10 Very light +
- 11 Fairly light
- 12 Comfortable
- 13 Somewhat hard
- 14 Somewhat hard +
- 15 Hard
- 16 Hard +
- 17 Very hard
- 18 Very hard +
- 19 Very, very hard
- 20 Maximal

You can get an approximate heart rate level for each rating by simply adding a zero to each rating. For example a rating of 12 will result in an approximate heart rate of 120 beats per minute. Your RPE will vary depending upon the factors discussed earlier. That is the major benefit of this type of training. If your body is strong and rested, you will feel strong and your pace will feel easier. When your body is in this condition, you are able to train harder and the RPE will support this. If you are feeling tired and sluggish, it is because your body needs a break. In this condition, your pace will feel harder. Again, this will show up in your RPE and you will train at the proper level for that day.

## Wearing The Chest Strap

1. Attach the transmitter to the elastic strap using the locking parts.
2. Adjust the strap as tightly as possible as long as the strap is not too tight to remain comfortable.
3. Position the transmitter with the logo centered in the middle of your torso facing away from your chest (some people must position the transmitter slightly left of center). Attach the final end of the elastic strap by inserting the round end and, using the locking parts, secure the transmitter and strap around your chest.
4. Position the transmitter directly below the pectoral muscles.
5. Sweat is the best conductor to measure very minute heart beat electrical signals. However, plain water can also be used to pre-wet the electrodes (2 ribbed oval areas on the reverse side of the belt and both sides of the transmitter). It's also recommended that you wear the transmitter strap a few minutes before your work out. Some users, because of body chemistry, have a more difficult time in achieving a strong, steady signal at the beginning. After "warming up", this problem lessens. As noted, wearing clothing over the transmitter/strap doesn't affect performance.
6. Your workout must be within range - distance between transmitter/receiver – to achieve a strong steady signal. The length of range may vary somewhat but generally stay close enough to the console to maintain good, strong, reliable readings. Wearing the transmitter directly on bare skin assures you of proper operation. If you wish, you may wear the transmitter over a shirt. To do so, wet the areas of the shirt that the electrodes will rest upon.

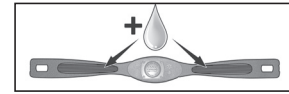
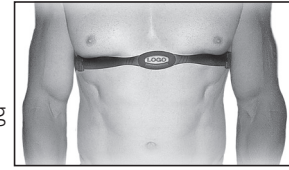

Note: The transmitter is automatically activated when it detects activity from the user's heart. Additionally, it automatically deactivates when it does not receive any activity. Although the transmitter is water resistant, moisture can have the effect of creating false signals, so you should take precautions to completely dry the transmitter after use to prolong battery life (estimated transmitter battery life is 2500 hours). The replacement battery is Panasonic CR2032.

## Erratic Operation

Caution! Do not use this elliptical for Heart Rate programs unless a steady, solid Actual Heart Rate value is being displayed. High, wild, random numbers being displayed indicate a problem.

Areas to look for interference which may cause erratic heart rate:

1. Microwave ovens, TV's, small appliances, etc.
2. Fluorescent lights.
3. Some household security systems.
4. Perimeter fence for a pet.
5. Some people have problems with the transmitter picking up a signal from their skin. If you have problems try wearing the transmitter upside down. Normally the transmitter will be oriented so the Spirit Fitness logo is right side up.
6. The antenna that picks up your heart rate is very sensitive. If there is an outside noise source, turning the whole machine 90 degrees may de-tune the interference.
7. Another Individual wearing a transmitter within 3' of your machine's console.

If you continue to experience problems contact your dealer.

# Heart Rate Program Operation

*Note: You must wear the heart rate transmitter strap for these programs*

Both programs operate the same, the only difference is that **HRI** is set to 60% and **HR2** is set to 80% of the maximum heart rate. They both are programmed the same way.

To start an HR program follow the instructions below or just select the **HRI** or **HR2** program, then the **Enter** button and follow the directions in the Message Center.

After selecting your heart rate target the program will attempt to keep you at or within 3-5 heart beats per minute of this value. Follow the prompts in the Message Center to maintain your selected heart rate value.

1. Press the **HR 1** or **HR 2** key then press the **Enter** key.
2. The Message Center will ask you to enter your Age. You may enter your age, using the **Level Up/Down** keys, then press the **Enter** key to accept the new value and proceed on to the next screen.
3. You are now asked to enter your Weight. You may adjust the weight value using the **Level Up/Down** keys, then press **Enter** to continue.
4. Next is Time. You may adjust the time and press **Enter** to continue.
5. Now you are asked to adjust the Heart Rate Target. This is the heart rate level you will strive to maintain during the program. Adjust the level using the **Level Up/Down** keys, then press **Enter**. *Note: The heart rate that appears is based on the % you accepted in Step 1. If you change this number it will either increase or decrease the % from Step 1.*
6. Now you are finished editing the settings and can begin your workout by pressing the **Start** key. You can also go back and modify your settings by pressing the **Enter** key. *Note: At any time during the editing of Data you can press the **Enter** key to go back one screen.*
7. If you want to increase or decrease the workload at any time during the program press the **Level Up/Down** key. This will allow you to change your target heart rate at any time during the program.
8. During the HR 1 or HR 2 programs you will be able to scroll through the data in the Message Center by pressing the **Enter** key.
9. When the program ends you may press **Start** to begin the same program again or **Stop** to exit the program or you can save the program you just completed as a custom user program by pressing a **User** key and following the instructions in the Message Center.

1. Wipe down all areas in the sweat path with a damp cloth after each workout.
2. If a squeak, thump, clicking or rough feeling develops the main cause is most likely one of two reasons:
  - I. i. The hardware was not sufficiently tightened during assembly. All bolts that were installed during assembly need to be tightened as much as possible. It may be necessary to use a larger wrench than the one provided if you cannot tighten the bolts sufficiently. I cannot stress this point enough; 90% of calls to the service department for noise issues can be traced to loose hardware or the rear rails being dirty.
  - II. ii. Dirt build-up on the rear rails and polyurethane wheels are also a source of noise. Noise from build-up on the rails can cause a thumping sound that you would swear is coming from inside the main body of the machine because noise travels, and is amplified, in the tubing of the frame. Clean the rails and wheels with a lint free cloth and rubbing alcohol. Stubborn build-up can be removed with your thumbnail or a non-metallic scraper, like the back edge of a plastic knife. After cleaning, apply a small amount of lubricant on the rails with your fingers or a lint free cloth. You only need a thin coat of lubrication, wipe off any excess.
3. If squeaks or other noises persist, check that the unit is properly leveled. There are 4 leveling pads on the bottom of the rear rails, use a 14mm wrench (or adjustable wrench) to adjust the levelers.

## Engineering Mode Menu

The console has built in maintenance/diagnostic software. The software will allow you to change the console settings from English to Metric and turn off the beeping of the speaker when a key is pressed for example. To enter the Engineering Mode Menu, press and hold down the **Start**, **Stop** and **Enter** keys. Keep holding the keys down for about 5 seconds and the Message Center will display Engineering Mode Menu. Press the **Enter** button to access the menu below:

- a. Key Test (Will allow you to test all the keys to make sure they are functioning)
- b. Security (Allows the keypad to be locked to prevent unauthorized use)
- c. Functions (Press **Enter** to access settings and **Up** arrow to scroll)
  - i. Sleep Mode (Turn on to have the console power down automatically after 20 minutes of inactivity)
  - ii. Incline On/Off (For e•Glide this is always off)
  - iii. Unit Type (Should show Elliptical, other setting is e•Glide. Switches calorie formula, HR program settings and watt tables for the different units)
  - iv. Motor Test (Press **Enter** to run the resistance motor up and down in a continuous loop. Display shows level setting and position sensor reading. Press stop to end test.)
  - v. Beep (Turns off the speaker so no beeping sound is heard)
  - vi. Units (Sets the display to readout in English or Metric display measurements)
  - vii. ODO Reset (Resets the odometer)
  - viii. Pause Mode (Turn on allow 5 minutes of pause, turn off to have the console pause indefinitely)
- d. LCD Test (Tests all the display functions)

## Elliptical Warranty - Effective September 15, 2010

Spirit Fitness, Inc. (Spirit Fitness) warrants all its elliptical parts for a period of time listed below from the date of retail sale, as determined by sale receipt, or in the absence of a sales receipt eighteen (18) months from the original factory shipping date. Spirit Fitness' responsibilities include providing new or remanufactured parts, at Spirit Fitness' option, and technical support to our independent dealers and servicing organizations. In the absence of a dealer or service organization, these warranties will be administered by Spirit Fitness directly to a consumer. The warranty period applies to the following components:

Warranty	Frame	Brake	Parts	Labor
Residential	Lifetime	Lifetime	10 Years	1 Year

### NORMAL RESPONSIBILITIES OF THE CONSUMER

This warranty applies only to products in ordinary household use, and the consumer is responsible for the items listed below:

- The warranty registration card must be completed and returned to the address listed on the card within 10 days of the original purchase to validate the manufacturer's limited warranty.
- Proper use of the elliptical in accordance with the instructions provided in this manual
- Proper installation in accordance with instructions provided with the elliptical and with all local electric codes.
- Proper connection to a grounded power supply of sufficient voltage, replacement of blown fuses, repair of loose connections or defects in house wiring.
- Expenses for making the elliptical accessible for servicing, including any item that was not part of the elliptical at the time it was shipped from the factory.
- Damages to the elliptical finish during shipping, installation or following installation.
- Routine maintenance of this unit as specified in this manual.

### EXCLUSIONS

This warranty does not cover the following:

- CONSEQUENTIAL, COLLATERAL, OR INCIDENTAL DAMAGES SUCH AS PROPERTY DAMAGE AND INCIDENTAL EXPENSES RESULTING FROM ANY BREACH OF THIS WRITTEN OR ANY IMPLIED WARRANTY.  
Note: Some states do not allow the exclusion or limitation of incidental or consequential damages, so this limitation or exclusion may not apply to you.
- Service call reimbursement to the consumer; Service call reimbursement to the dealer that does not involve malfunction or defects in workmanship or material, for units that are beyond the warranty period, for units that are beyond the service call reimbursement period, for elliptical not requiring component replacement, or elliptical not in ordinary household use.
- Damages caused by services performed by persons other than authorized Spirit Fitness service companies; use of parts other than original Spirit Fitness parts; or external causes such as corrosion, discoloration of paint or plastic, alterations, modifications, abuse, misuse, accident, improper maintenance, inadequate power supply, or acts of God.
- Products with original serial numbers that have been removed or altered.
- Products that have been: sold, transferred, bartered, or given to a third party.
- Products that do not have a warranty registration card on file at Spirit Fitness. Spirit Fitness reserves the right to request proof of purchase if no warranty record exists for the product.
- THIS WARRANTY IS EXPRESSLY IN LIEU OF ALL OTHER WARRANTIES EXPRESSED OR IMPLIED, INCLUDING THE WARRANTIES OF MERCHANTABILITY AND/OR FITNESS FOR A PARTICULAR PURPOSE.
- Product use in any environment other than a residential setting.
- Warranties outside of North America may vary. Please contact your local dealer for details.

### SERVICE

Keep your bill of sale. Twelve (12) months from the date on the bill of sale or eighteen (18) months from the date of factory shipping as determined by the serial number establishes the labor warranty period should service be required. If service is performed, it is in your best interest to obtain and keep all receipts. This written warranty gives you specific legal rights. You may also have other rights that vary from state to state. Service under this warranty must be obtained by following these steps, in order:

- Contact your selling authorized Spirit Fitness dealer. OR
- Contact your local authorized Spirit Fitness service organization.
- If there is a question as to where to obtain service, contact our service department at (870) 935-1107.
- Spirit Fitness' obligation under this warranty is limited to repairing or replacing, at Spirit Fitness' option, the product through one of our authorized service centers. All repairs must be preauthorized by Spirit Fitness. If the product is shipped to a service center freight charges to and from the service center will be the customer's responsibility. For replacement parts shipped while the product is under warranty, the customer will be responsible for shipping and handling charges. For in-home service, the customer will be responsible for a trip charge. There will be an additional trip charge if the customer is located over 100 miles from the nearest service center.
- The owner is responsible for adequate packaging upon return to Spirit Fitness. Spirit Fitness is not responsible for damages in shipping. Make all freight damage claims with the appropriate freight carrier. DO NOT SHIP ANY UNIT TO OUR FACTORY WITHOUT A RETURN AUTHORIZATION NUMBER. All units arriving without a return authorization number will be refused.
- For any further information, or to contact our service department by mail, send your correspondence to:

Spirit Fitness, Inc.  
P.O. Box 2037  
Jonesboro, AR 72402-2037

Product features or specifications as described or illustrated are subject to change without notice. All warranties are made by Spirit Fitness, Inc. This warranty applies only in the 50 states of the U.S.A.

2601 Commerce Drive Jonesboro, AR 72401 - Phone: 800-258-4555 - Fax: 870-935-7611

[www.spiritfitness.com](http://www.spiritfitness.com)

© 2011 All Rights Reserved.  
XE**395** Owner's Manual 1.1  
Rev. 1



## Free Manuals Download Website

<http://myh66.com>

<http://usermanuals.us>

<http://www.somanuals.com>

<http://www.4manuals.cc>

<http://www.manual-lib.com>

<http://www.404manual.com>

<http://www.luxmanual.com>

<http://aubethermostatmanual.com>

Golf course search by state

<http://golfingnear.com>

Email search by domain

<http://emailbydomain.com>

Auto manuals search

<http://auto.somanuals.com>

TV manuals search

<http://tv.somanuals.com>