

SPIRIT



*XE 700
Elliptical*

OWNER'S MANUAL

**PLEASE CAREFULLY READ THIS ENTIRE MANUAL BEFORE
OPERATING YOUR NEW ELLIPTICAL!**

Table of Contents

Product Registration.....	2
Important Safety Instructions.....	3
Important Electrical Information.....	4
Important Operation Instructions.....	4
Assembly Pack Check List.....	5
Assembly Instructions.....	8
Features.....	15
Operation of Your New Elliptical.....	16
Using a Heart Rate Transmitter.....	27
Maintenance.....	29
Manufacturer's Limited Warranty.....	30

SPIRIT

**CONGRATULATIONS ON YOUR
NEW ELLIPTICAL AND WELCOME
TO THE SPIRIT FAMILY!**

Thank you for your purchase of this quality elliptical trainer from Spirit Manufacturing, Inc. Your new elliptical was manufactured by one of the leading fitness manufacturers in the world and is backed by one of the most comprehensive warranties available. Through your dealer, Spirit will do all we can to make your ownership experience as pleasant as possible for many years to come. The local dealership where you purchased this elliptical is your administrator for all Spirit warranty and service needs. Their responsibility is to provide you with the technical knowledge and service personnel to make your experience more informed and any difficulties easier to remedy.

Please take a moment at this time to record the name of the dealer, their telephone number, and the date of purchase below to make any future, needed contact easy. We appreciate your support and we will always remember that you are the reason that we are in business. Please complete and mail your registration card today and enjoy your new elliptical.

Yours in Health,
Spirit Manufacturing, Inc.

Name of Dealer _____

Telephone Number of Dealer _____

Purchase Date _____

Product Registration

RECORD YOUR SERIAL NUMBER

Please record the Serial Number of this fitness product in the space provided below.

Serial Number _____

REGISTER YOUR PURCHASE

The self-addressed product registration card must be completed in full and returned to Spirit Manufacturing, Inc or visit: www.spiritfitness.com/warranty.htm to register online.

ver. A

Important Safety Instructions

WARNING - Read all instructions before using this appliance.

- Do not operate elliptical on deeply padded, plush or shag carpet. Damage to both carpet and elliptical may result.
- Keep children away from the elliptical. There are obvious pinch points and other caution areas that can cause harm.
- Keep hands away from all moving parts.
- Never operate the elliptical if it has a damaged cord or plug. If the elliptical is not working properly, call your dealer.
- Keep the cord away from heated surfaces.
- Do not operate where aerosol spray products are being used or where oxygen is being administered. Sparks from the motor may ignite a highly gaseous environment.
- Never drop or insert any object into any openings.
- Do not use outdoors.
- To disconnect, turn all controls to the off position, then remove the plug from the outlet.
- Do not attempt to use your elliptical for any purpose other than for the purpose it is intended.
- The hand pulse sensors are not medical devices. Various factors, including the user's movement, may affect the accuracy of heart rate readings. The pulse sensors are intended only as exercise aids in determining heart rate trends in general.
- Wear proper shoes. High heels, dress shoes, sandals or bare feet are not suitable for use on your elliptical. Quality athletic shoes are recommended to avoid leg fatigue.

SAVE THESE INSTRUCTIONS - THINK SAFETY!

Important Electrical Information

WARNING!

● This product is self powered by a built in generator but does have the option of being plugged into an A.C. outlet (Optional 24 VAC transformer available through your local Spirit fitness dealer). The following are warnings to be observed when using the A.C. plug in option.

NEVER remove any cover without first disconnecting AC power supply.

● If A.C. voltage varies by ten percent (10%) or more, the performance of your bike may be affected. **Such conditions are not covered under your warranty.** If you suspect the voltage is low, contact your local power company or a licensed electrician for proper testing.

● When operated in the generator mode, be aware that the generator is producing A.C. power while the bike is being used. Do not service the bike while the generator is spinning. Serious electric shock could occur.

NEVER: expose the bike to rain or moisture. This product is **NOT** designed for

Use outdoors, near a pool or spa, or in any other high humidity environment. Maximum environmental ratings are 40-120 degrees Fahrenheit, 95% humidity non-condensing (no water droplets forming on surfaces).

Important Operation Instructions

- **NEVER** operate the bike without reading and completely understanding the results of any operational change you request from the computer.
- **NEVER** use your bike in the A.C. power mode during an electrical storm. Surges may occur in your household power supply that could damage the bike's electrical components.
- Do not use excessive pressure on console control keys. They are precision set to properly function with little finger pressure. Pushing harder is not going to make the unit go faster or slower. If you feel the buttons are not functioning properly with normal pressure, contact your Spirit dealer.

Assembly Pack Check List

Step 1

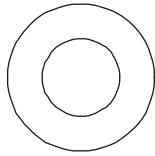

(#96) 3/8" x 19 x 1.5T
Flat Washer (2pcs)

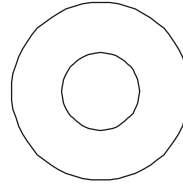

(#104) 3/8" x 23 x 2.0T
Curved Washer (4pcs)

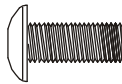

(#84) M5 x 12m/m
Phillips Head Screw (2pcs)

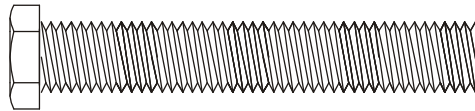

(#75) 3/8" x 2-1/4"
Hex Head Bolt (2pcs)

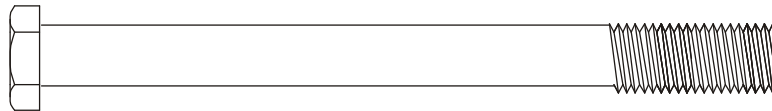

(#77) 3/8" x 3-3/4"
Hex Head Bolt (4pcs)

Step 2

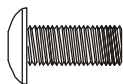

(#84) M5 x 12m/m
Phillips Head Screw (4pcs)



(#128) 3/8" x 2.0T
Split Washer (1pc)

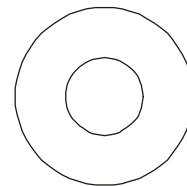

(#104) 3/8" x 23 x 2.0T
Curved Washer (2pcs)

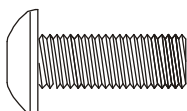

(#76) 3/8" x 3/4"
Button Head Socket Screw (2pcs)

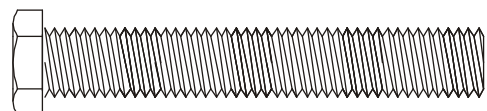

(#75) 3/8" x 2-1/4"
Hex Head Bolt (1pc)

Step 3

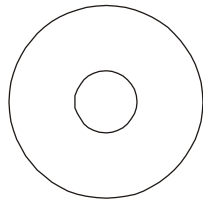

(#102) Ø 25 Wave Washer (2 pcs)

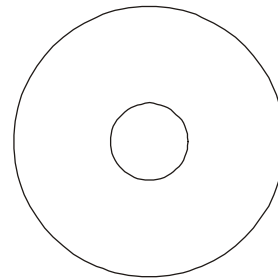

(#131) 3/8" x 30 x 2.0T Flat Washer (2 pcs)

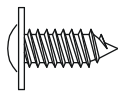

(#107) 3.5 x 12m/m Self Tapping Screw (10pcs)

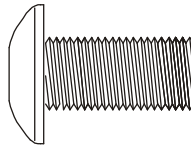

(#76) 3/8" x 3/4" Button Head Socket Screw (2pcs)

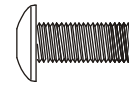

(#84) M5 x 12m/m Phillips Head Screw (17pcs)

Step 4

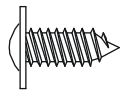

(#107) 3.5 x 12m/m Self Tapping Screw (8 pcs)



(#91) 5/16" x 7T Nylon Nut (2 pcs)

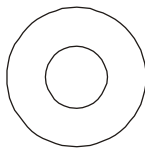

(#100) 5/16" x 18 x 1.5T Flat Washer (2 pcs)

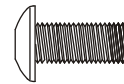

(#84) M5 x 12m/m Phillips Head Screw (16 pcs)

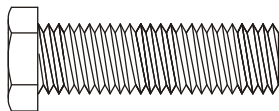

(#79) 5/16" x 1-1/4" Hex Head Bolt (2 pcs)

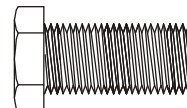

(#80) 5/16" x 3/4" Hex Head Bolt (8 pcs)

Tools

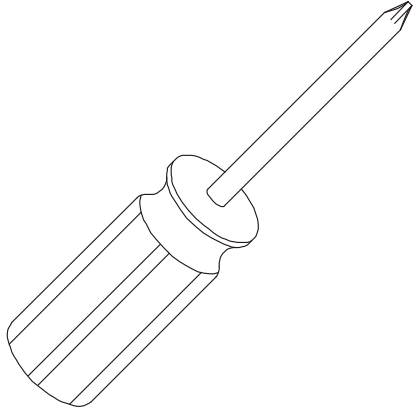

(#126) Phillips Screw Driver (1 pc)

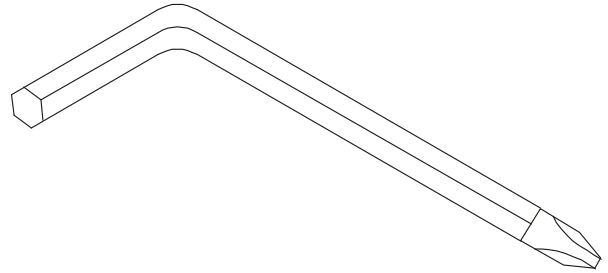

(#125) Combination M6 Allen Wrench & Phillips Head Screw Driver (1 pc)

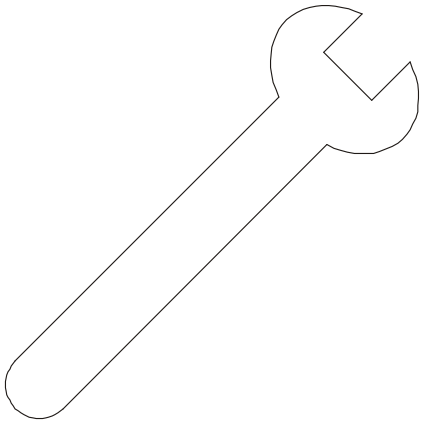

(#129) 12m/m Wrench (1 pc)

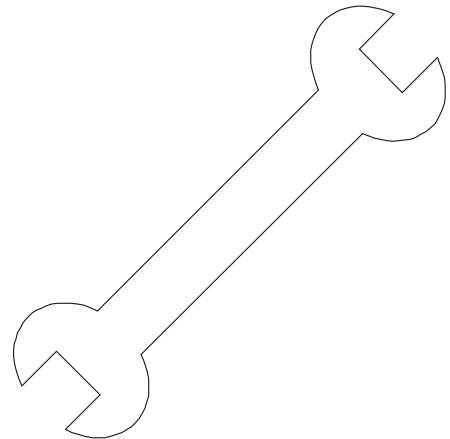

(#124) 13/14m/m Wrench (1 pc)

Assembly Instructions XE700

UNPACKING THE UNIT

1. Using a razor knife (Box Cutter) cut the outside, bottom, edge of box along the dotted Line. Lift Box over the unit and unpack.
2. Carefully remove all parts from carton and inspect for any damage or missing parts. If damaged parts are found, or parts are missing, contact your dealer immediately.
3. Locate the hardware package. The hardware is separated into four steps. Remove the tools first. Remove the hardware for each step as needed to avoid confusion. The numbers in the instructions that are in parenthesis (#) are the item number from the assembly drawing, for reference.

STEP 1: REAR RAIL ASSEMBLY

1. Install the two 3/8" flat washers (96) on the two 3/8" X 2-1/4" bolts (75) and install them through the two holes in the top of the middle stabilizer tube and hand tighten into the rear rail assembly (2).
2. Install the four curved washers (104) on the 3/8" X 3-3/4" bolts (77) and hand-tighten them through the front of the middle stabilizer tube and into the rear rail assembly.
3. Using the wrench provided tighten all six bolts securely.
4. Install the front stabilizer cover (59) with the two M5 X 12mm screws (84).

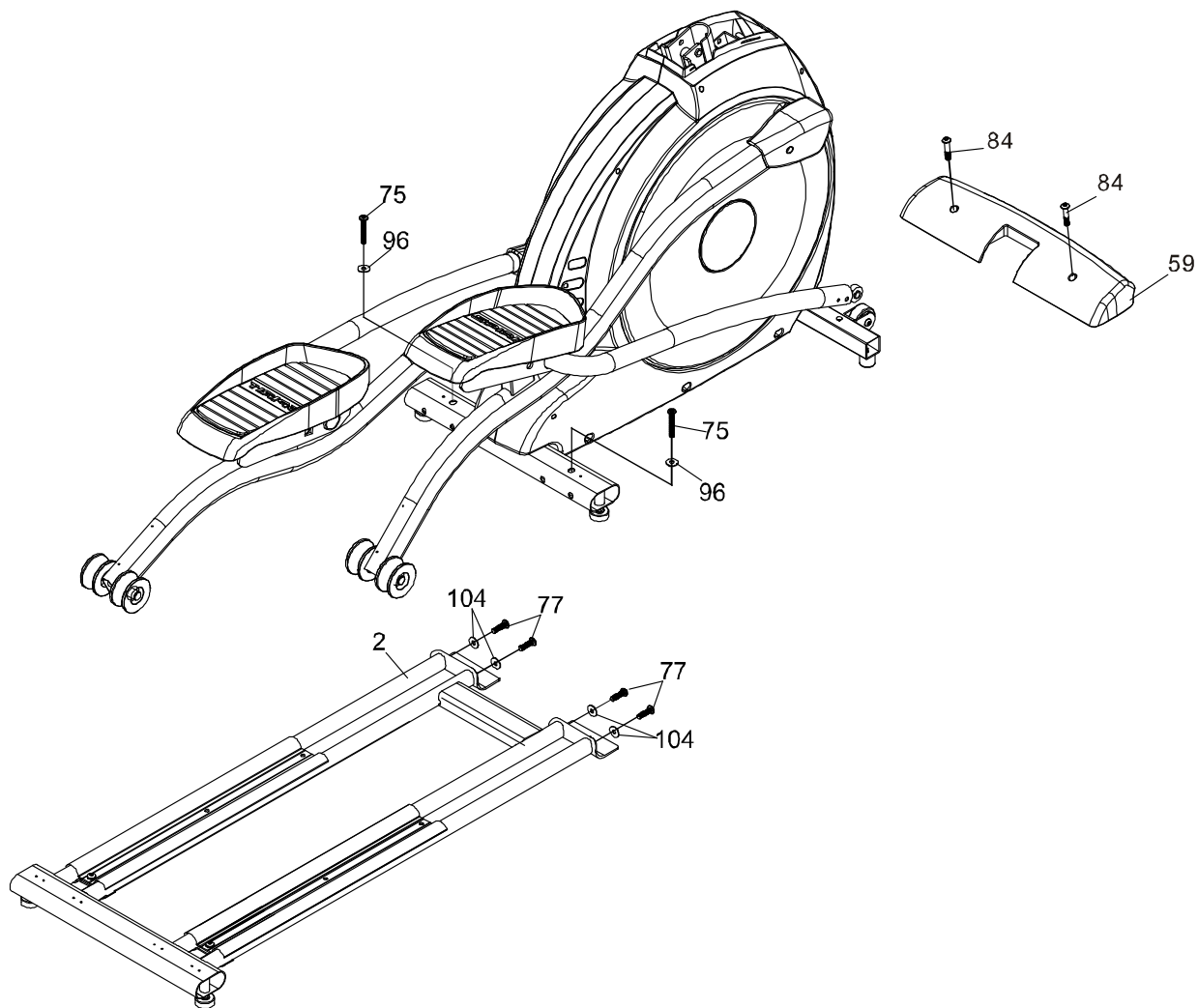

STEP 2: CONSOLE MAST ASSEMBLY

1. Locate the console mast (12) and console mast cover (49) and slide the cover onto the mast as far as it will go. Make sure the cover is facing the correct way.
2. At the top opening of the main body of the elliptical is a wire harness (39). Unravel and straighten out the wire harness and feed it into the bottom of the console mast tube and out of the top opening.
3. Install the console mast into the receiving bracket in the top of the main body with one hand, while holding the wire harness in the other, keeping tension on the wire so it is not cut by the console mast during installation. NOTE: there is one bolt already installed in the receiving bracket that will engage with the slot at the bottom of the console mast. This needs to be tightened at the end along with the three other console mast bolts.
4. Install the 3/8" split washer (128) onto the 3/8" X 2-1/4" bolt (75), and the two curved washers (104) onto the two 3/8" X 3/4" bolts (76). Install, and hand tighten, the 2-1/4" bolt (75) through the left side of the receiving tube into the console mast. NOTE: There is a wire running through the tube. Be careful not to damage or pinch this wire during this procedure. Damage to the electronic console could result. Install and hand tighten the two 3/4" bolts (76) through the front of the receiving tube into the console mast.
5. Using the two sided, 13mm/14mm wrench, tighten the four bolts firmly. These bolts should be tightened as much as you possibly can. You can now remove the white Styrofoam sheet from just below the bolts. This sheet is there to prevent bolts from falling inside the machine during assembly and should be removed to prevent it from rubbing on moving parts during use of the elliptical. Install the console mast cover (49) by snapping it in place.
6. There will be three electrical wire connectors at the top opening of the console mast. Two 2-pin connectors (hand pulse sensors) (44) and one 10-pin connector (main wire harness) (39). Connect these to the mating connectors on the back of the console. The connectors are keyed to avoid them being plugged in the wrong way. Do not force them. There may be another connector on the back of the console. This connector is used for a different product and will remain unused in the XE700.
7. Storing the excess wire back into the console mast, carefully install the console onto the mounting plate and secure using the four M5 X 12mm Phillips head screws (84). Make sure you do not pinch the wires between the back of the console and the mounting plate. Ensure all excess wire goes down into the tube.

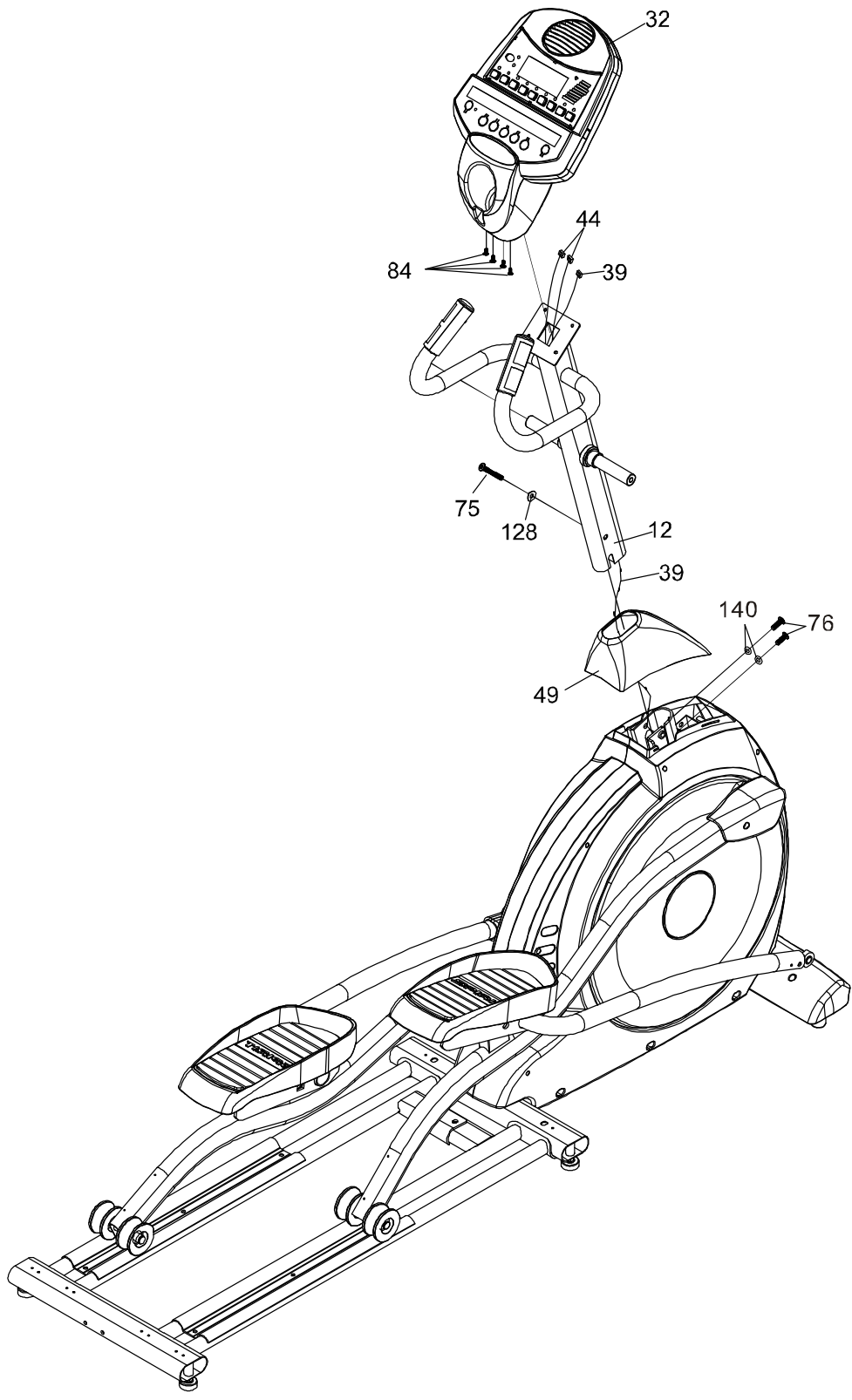

STEP 3: HANDLE BAR ASSEMBLY

1. Locate and install the two large wave washers (102) onto the handle bar axle, one on each side.
2. Slide the left and right handle bars onto the appropriate side of the axle. There is a sticker on each handle bar indicating **L** for left and **R** for right. The left and right sides of the elliptical are determined as if standing on and using the elliptical.
3. Install the two flat washers (131) onto the two 3/8" x 5/8" bolts (76), then install and tighten into the threaded holes in the ends of the axle.
4. Install the four handlebar covers (157, 157-1, 158, 158-1) with the eight 3.5 x 12 mm screws (107)
5. Install the front (159) and rear (160) console mast covers with three M5 x 15m/m Screws (84) and two 3.5x12m/m Self Tapping Screws (107).
6. Install the two middle stabilizer covers (116, 117) and the two wheel covers (64) with the six M5 x 12 mm screws (84).
7. Install the four L-brackets (149) on the rear stabilizer with the eight M5 x 12 mm screws (84).

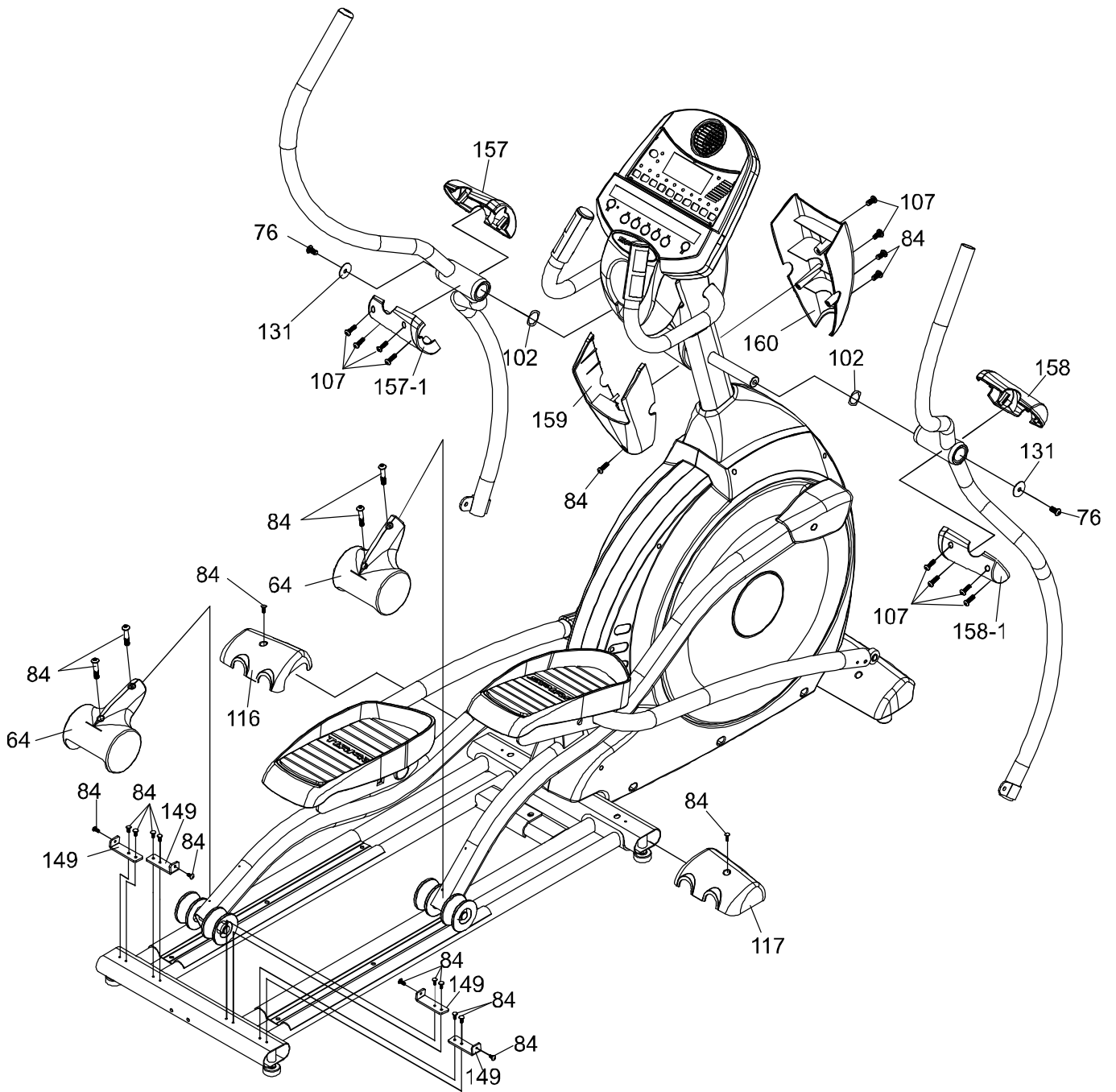

STEP 4: FOOT PAD/CONNECTING ARM ASSEMBLY & REAR SHROUD INSTALLATION.

1. Align the hole of the rod end bearing - located at the end of the Connecting Arms (8&9) - with the holes in the bracket of the Handle Bars (10&11). The rod end bearing should be aligned inside the U shaped Handle Bar bracket. Take two 5/16" x 1-1/4" Hex Head Bolts (79) and install them through the left and right Handle Bar brackets and rod ends. Install two 5/16" x 18 mm Flat Washers (100) and the 5/16" Nylon Nuts (91) on the 5/16" x 1-1/4" Hex Head Bolts (104) and tighten firmly by using 12m/mWrench (109) and 13/14 m/m Wrench (106). There is a sleeve spacer installed in the rod end bearing; make sure it does not fall out during assembly.
2. Install the plastic covers (71,71-1, 72, 72-1) over the connection of the rod end and handle bar with the eight 3.5 x 12 mm screws (107) and eight M5 x 12 mm screws (84)
3. **Rear shroud (steel cover) installation.** Unpack the rear shrouds and remove the 12 screws (84) holding the four front caps (152, 153) to the left and right shrouds (150, 151).
4. Locate and install the two middle mounting brackets (148). These two brackets install from beneath the left and right aluminium rails and are held in place by 5/16" x 3/4" bolts (80). There are holes located in the middle of the aluminium rails where the hole in the brackets line up and the bolts go through.
5. Locate and install the two front mounting brackets (147). These two brackets mount from the top and are secured by 5/16" x 3/4" bolts (80). The two bolts screw into brackets (24) that need to be placed under the aluminium rails.
6. Install the shrouds by lifting the pedal arm and carefully sliding the shroud over the covered wheels of the pedal arms. Lower the pedal arms until the wheels are resting on the aluminium rails again. Position the shroud so the holes in the mounting brackets (147, 148, 149) line up with the mounting holes in the shroud. Install and tighten the twelve M5 x 12mm screws (84) that hold the shrouds in place.
7. Re-install the four front caps (152, 153) that were removed in step 3.
8. Install the center support brace (3) with four 5/16" x 3/4" bolts (80).

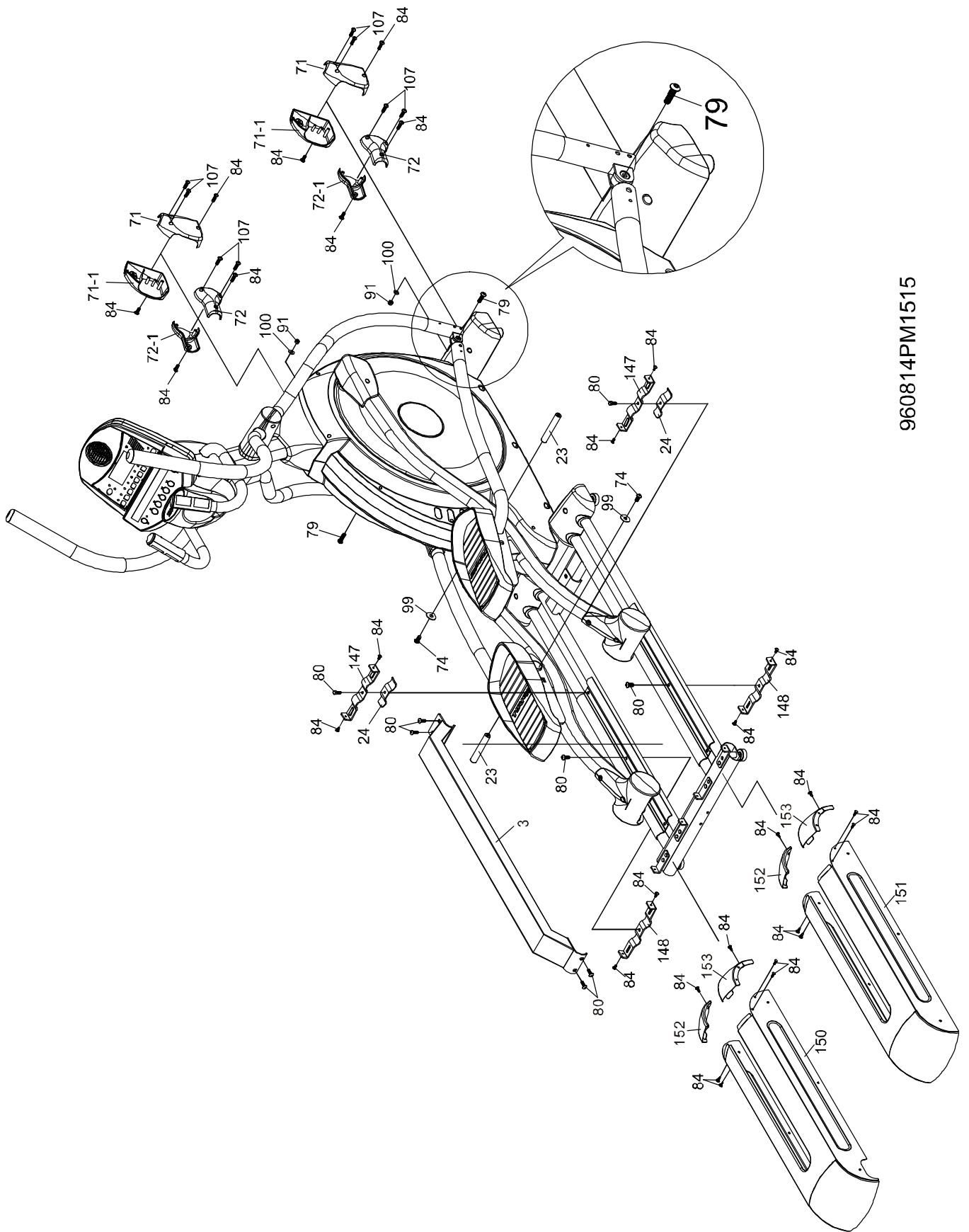

960814PM1515

Features

Footpads

Through research performed with a leading sports scientist and physical rehabilitation expert, Spirit engineering has developed a breakthrough in pedal design. The history of elliptical use over the past few years tells us that many users suffer from ankle, Achilles tendon, knee and/or hip pain.

While researching a solution to these common problems Spirit engineers consulted Richard DeKok, P.T., M.T.C., of St. Bernards Industrial Rehabilitation Center in Jonesboro Arkansas. Together we identified the inherent problem in elliptical designs and developed a solution to solve the problem. What we found is that when you use an elliptical you tend to push outward during the power stroke and not just straight back. This causes stress on the outer part of the foot and throws off the natural alignment of the body's joints. The solution we discovered was to add a 2-degree inward angle to the footpads. This might sound simple but it was all that was needed to put the user's joints back into a neutral alignment. This eases the over stressing of the ankles, knees and hips and allows the user to exercise longer without discomfort.

Transportation

The elliptical is equipped with two transport wheels, which are engaged when rear of XE Series Elliptical is lifted.

Operation of Your Elliptical

■ XE700 Console

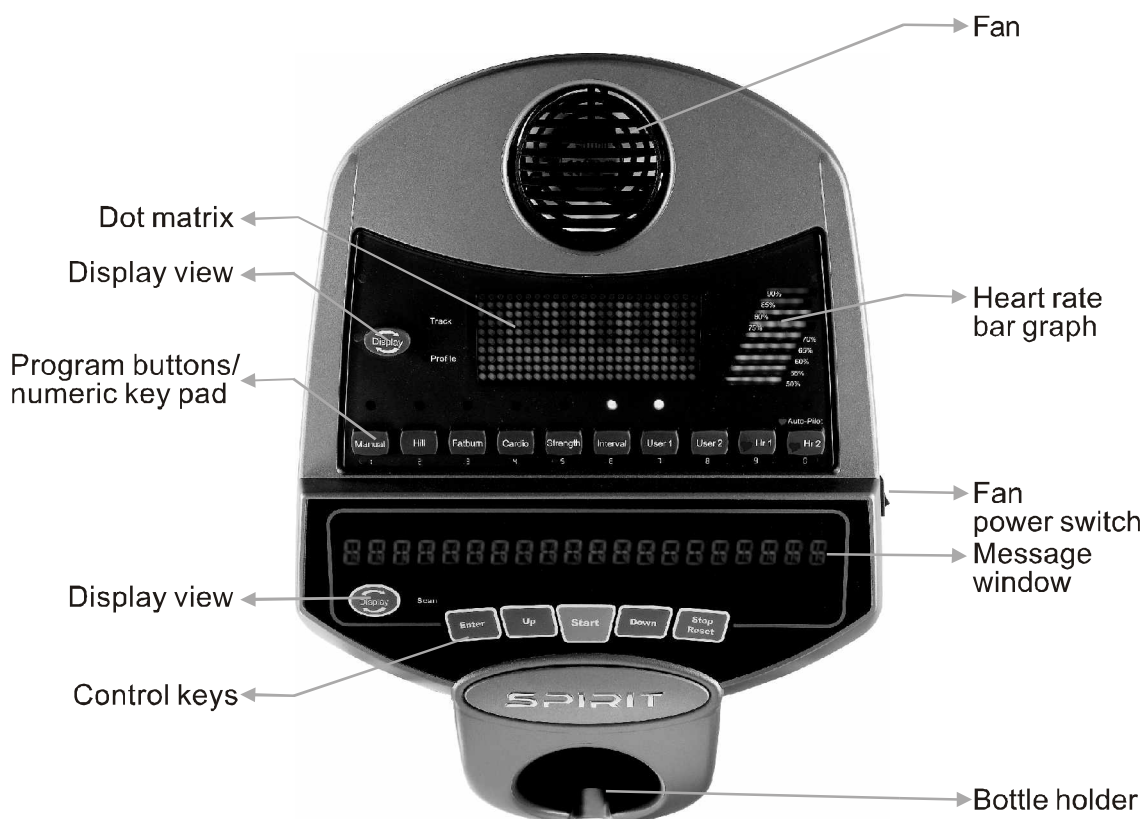

Power on

The XE700 has a built-in generator for power and does not need to be plugged into an AC outlet. To power up the Elliptical simply start to pedal, the console will turn on automatically. If the console does not light when you pedal, check that the power switch is set to **0** (Generator). The switch is located on the front, lower left side of the main plastic cover. There is an optional AC power transformer that is available through your dealer or direct from Spirit. The AC power transformer would be used if the Elliptical will be operated at very low speeds. In this scenario the power to the electronic console will be too low to maintain the display. To use the AC power transformer, plug it into an AC outlet and the power input module of the bike and set the power switch to **1** (AC power input).

When initially powered on the console will perform an internal self-test. During this time all the lights will turn on for a short time. When the lights go off the dot matrix display will show a software version (i.e. VER 1.0) and the message window will display an odometer reading. The odometer reading displays how many hours the Elliptical has been used and how many virtual miles the Elliptical has gone. The display shows: ODO 123 MI 123 HRS.

The odometer will remain displayed for only a few seconds then the console will go to the start up display. The dot matrix display will be scrolling through the different profiles, showing the programs, and the message window will be scrolling the start up message. You may now begin to use the console.

Console Operation

Quick Start

This is the quickest way to start a workout. After the console powers up you just press the Start key to begin. This will initiate the Quick Start mode. In Quick Start the Time will count up from zero, all workout data will start to accrue and the workload may be adjusted manually by pressing the Up or Down buttons. The dot matrix display will show only the bottom row lit at first. As you increase the workload, more rows will light indicating a harder workout. The bike will get harder to pedal as the rows increase. The dot matrix has 24 columns of lights and each column represents 1 minute. At the end of the 24th column (or 24 minutes of work) the display will wrap around and start at the first column again.

There are 40 levels of resistance – displayed as 10 rows of lights - available for plenty of variety. The first 10 levels are very easy workloads, and the changes between levels are set to a good progression for de-conditioned users. Levels 10-20 are more challenging but the increases from one level to the next remain small. Levels 20-30 start getting tough as the levels jump more dramatically. Levels 30-40 are extremely hard and are good for short interval peaks and elite athletic training.

Basic information

The **Dot Matrix, or Profile window**, has two display modes. When you begin a program the dot matrix will display the workout Profile. To the left of the dot matrix there is a button labeled Display. Pressing this button once will switch the display to show a quarter mile track. If the Display button is pressed again the dot matrix will switch back and forth between Track and Profile mode every few seconds. To turn off the scan mode press the Display key again. This will return you to the profile display mode.

The **Message Window** will initially be displaying Time and Distance information. On the bottom left of the message window is a button labeled Display. Each time this Display button is pressed the next set of information will appear, four windows in all. In order: Time and Distance, Pulse and Calories, Speed in RPM and MPH, Work Level and Watts. If the Display button is pressed during the Level and Watts display the Scan light will come on and the message window will show each set of data for four seconds then switch to the next set of data in a continuous loop. Pressing the Display button again will bring you back to the beginning.

To the right of the Dot matrix display is a **Heart Icon** and a **Bar Graph**. The Elliptical has a built in heart rate monitoring system. Simply grasping the hand pulse sensors, or wearing the Polar chest strap heart rate transmitter, will start the **Heart Icon** blinking (this may take a few seconds). The Message Window will display your heart rate, or Pulse, in beats per minute. The **Bar Graph** represents the percentage of your maximum heart rate you are currently achieving. NOTE: You must enter your age for the Bar Graph to be accurate. Refer to Heart Rate section for details about these features and how they can help you work out more efficiently.

The **Stop/Reset** button actually has several functions. Pressing the Stop/Reset key once during a program will **Pause** the program for 5 minutes (when you stop pedaling without AC power, the display will turn off, but the memory will be saved for 5 minutes just like the pause mode). If you need to get a drink, answer the phone or any of the many things that could interrupt your workout, this is a great feature. To resume your workout during Pause just press the Start key or start pedaling. If the Stop/Reset button is pressed twice during a workout the program will end and the console will return to the start up screen. If the Stop/Reset key is held down for 3 seconds the console will perform a complete **Reset**. During data entry for a program the Stop/Reset key performs a **Previous Screen** function. This allows you to go back one step in the programming each time you press the Stop/Reset key.

The **Program Keys** are used to preview each program. When you first turn the console on you may press each program key to preview what the program profile looks like. If you decide that you want to try a program, press the corresponding program key and then press the Enter key to select the program and enter into the data-setting mode.

The program keys also act as a **Number Key Pad** when you are in the data-setting mode. Under each program key is a number. If you are setting new data, such as Age, weight etc., you can use these keys to enter the numbers quickly.

The console includes a built-in fan to help keep you cool. To turn the fan on, flip the switch on the right side of the console case.

Programming the console

Each of the programs can be customized with your personal information and changed to suit your needs. Some of the information asked for is necessary to ensure the readouts are correct. You will be asked for your **Age** and **Weight**. Entering your **Age** ensures that the Heart Rate bar graph shows the correct number. Your Age is also necessary during the Heart Rate control programs to ensure the correct settings are in the program for your Age. Otherwise the work settings could be too high or low for you. Entering your **Weight** aides in calculating a more correct **Calorie** reading. Although we cannot provide an exact calorie count we do want to be as close as possible.

A message about Calories: Calorie readings on every piece of exercise equipment, whether it is in a gym or at home, are not accurate and tend to vary widely. They are meant only as a guide to monitor your progress from workout to workout. The only way to measure your calorie burn accurately is in a clinical setting connected to a host of machines. This is because every person is different and burns calories at a different rate. Some good news is that you will continue to burn calories at an accelerated rate for an hour after you have finished exercising!

Entering/Changing Settings

When you enter a program (by pressing a program key, then enter key) you have the option of entering your own personal settings. If you want to workout without entering new settings then just press the Start key. This will bypass the programming of data and take you directly to the start of your workout. If you want to change the personal settings then just follow the instructions in the message window. If you start a program without changing the settings the default - or pre-saved – settings will be used.

The default computer settings are: Age = 35, Weight = 155 Lbs., Time = 30:00, Max Level: each program has a different maximum work level: Hill = 14, Fatburn = 10, Cardio = 14, Strength = 16, Interval = 14.

NOTE: Changing Age and Weight settings will also change these settings in all other programs except the User 1&2 programs. The last Age and Weight entered will be saved as the new default settings. If you enter your Age and Weight the first time you use the Bike you will not have to enter it every time you work out unless either your Age or Weight changes or someone else enters a different Age and Weight.

Manual

The Manual program works as the name implies, manually. This means that you control the workload yourself and not the computer. To start the Manual program follow the instructions below or just press the Manual button then the Enter button and follow the directions in the message window.

1. Press the **Manual** key then press the **Enter** key.
2. The message window will ask you to enter your **Age**. You may enter your Age, using the Up and Down keys or the numeric key pad, then press the Enter key to accept the new number and proceed on to the next screen.
3. You are now asked to enter your **Weight**. You may adjust the Weight number using the Up and Down keys, or the numeric key pad, then press enter to continue.
4. The next setting is **Time**. You may adjust the Time and press enter to continue.
5. Now you are finished editing the settings and can begin your workout by pressing the Start key. You can also go back and modify your settings by pressing the Enter key. NOTE: At any time during the editing of Data you can press the Stop key to go back one level, or screen.
6. The program automatically starts you at level one. This is the easiest level and it is a good idea to stay at level one for a while to warm up. If you want to increase the work load at any time press the Up key; the Down key will decrease the workload.
7. During the Manual program you will be able to scroll through the data in the message window by pressing the adjacent **Display key**. You may also switch between the profile display and a quarter mile track by pressing the Display key adjacent to the dot matrix display.
8. When the program ends you may press Start to begin the same program again or Stop to exit the program, or you can save the program you just completed as a **custom user program** by pressing a User key and following the instructions in the message window.

Preset Programs

The Elliptical has five different programs that have been designed for a variety of workout goals. These five programs have factory preset profiles for achieving these different goals. The initial built-in level of difficulty for each program is set to a relatively easy level. You may adjust the level of difficulty (Max level) for each program before beginning by following the instructions in the message window after selecting your program.

The Programs

HILL

The **Hill** program simulates going up and down a hill. The resistance in the pedals will steadily increase and then decrease during the program. To start the Hill program follow the instructions below or just press the Hill button then the Enter button and follow the directions in the message window.

1. Press the **Hill** key then press the **Enter** key.
2. The message window will ask you to enter your **Age**. You may enter your Age, using the Up and Down keys or the numeric key pad, then press the Enter key to accept the new number and proceed on to the next screen.
3. You are now asked to enter your **Weight**. You may adjust the Weight number using the Up and Down keys or the numeric key pad, then press enter to continue.
4. Next is **Time**. You may adjust the Time and press enter to continue.
5. Now you are asked to adjust the **Max Level**. This is the peak exertion level you will experience during the program, at the top of the hill. The factory setting is level seven. Adjust the level and then press enter.
6. Now you are finished editing the settings and can begin your workout by pressing the Start key. You can also go back and modify your settings by pressing the Enter key. NOTE: At any time during the editing of Data you can press the Stop key to go back one level, or screen.
7. If you want to increase or decrease the workload at any time during the program press the Up or Down key. This will only affect the workload for the present position in the profile. When the profile changes to the next column it will return to the preset work level.
8. During the Hill program you will be able to scroll through the data in the message window by pressing the adjacent **Display key**, switch between the profile display and a quarter mile track by pressing the Display key adjacent to the matrix, use the heart rate monitoring features and can switch to heart rate **Auto-Pilot** mode. See Heart Rate section for details of this feature).
9. When the program ends you may press Start to begin the same program again or Stop to exit the program or you can save the program you just completed as a **custom user program** by pressing a User key and following the instructions in the message window.

Fat Burn

The **Fat Burn** program is designed, as the name implies, to maximize the burning of fat. There are many schools of thought on the best way to burn fat but most experts agree that a lower exertion level that stays steady is the best. The absolute best way to burn fat is to keep your heart rate at around 60% to 70% of it's maximum potential. This program does not use heart rate but simulates a lower, steady, exertion workout.

To start the Fat Burn program follow the instructions below or just press the Fat Burn button then the Enter button and follow the directions in the message window.

1. Press the **Fat Burn** key then press the **Enter** key.
2. The message window will ask you to enter your **Age**. You may enter your Age, using the Up and Down keys or the numeric key pad, then press the Enter key to accept the new number and proceed on to the next screen.
3. You are now asked to enter your **Weight**. You may adjust the Weight number using the Up and Down keys or the numeric key pad, then press enter to continue.

4. Next is **Time**. You may adjust the Time and press enter to continue.
5. Now you are asked to adjust the **Max Level**. This is the peak exertion level you will experience during the program. The factory setting is level five. Adjust the level and then press enter.
6. Now you are finished editing the settings and can begin your workout by pressing the Start key. You can also go back and modify your settings by pressing the Enter key. NOTE: At any time during the editing of Data you can press the Stop key to go back one level, or screen.
7. If you want to increase or decrease the workload at any time during the program press the Up or Down key. This will only affect the workload for the present position in the profile. When the profile changes to the next column it will return to the preset work level.
8. During the Fat Burn program you will be able to scroll through the data in the message window by pressing the adjacent **Display key**, switch between the profile display and a quarter mile track by pressing the Display key adjacent to the matrix, use the heart rate monitoring features and can switch to heart rate **Auto-Pilot** mode. See Heart Rate section for details of this feature).
9. When the program ends you may press Start to begin the same program again or Stop to exit the program or you can save the program you just completed as a **custom user program** by pressing a User key and following the instructions in the message window.

Cardio

The **Cardio** program is designed to increase your Cardio vascular function. This is, simply said, exercise for your heart and lungs. It will build up your heart muscle and increase blood flow and lung capacity. This is achieved by incorporating a higher level of exertion with slight fluctuations in work. To start the Cardio program follow the instructions below or just press the Cardio button then the Enter button and follow the directions in the message window.

1. Press the **Cardio** key then press the **Enter** key.
2. The message window will ask you to enter your **Age**. You may enter your Age, using the Up and Down keys or the numeric key pad, then press the Enter key to accept the new number and proceed on to the next screen.
3. You are now asked to enter your **Weight**. You may adjust the Weight number using the Up and Down keys or the numeric key pad, then press enter to continue.
4. Next is **Time**. You may adjust the Time and press enter to continue.
5. Now you are asked to adjust the **Max Level**. This is the peak exertion level you will experience during the program. The factory setting is level seven. Adjust the level and then press enter.
6. Now you are finished editing the settings and can begin your workout by pressing the Start key. You can also go back and modify your settings by pressing the Enter key. NOTE: At any time during the editing of Data you can press the Stop key to go back one level, or screen.
7. If you want to increase or decrease the workload at any time during the program press the Up or Down key. This will only affect the workload for the present position in the profile. When the profile changes to the next column it will return to the preset work level.
8. During the Cardio program you will be able to scroll through the data in the message window by pressing the adjacent **Display key**, switch between the profile display and a quarter mile track by pressing the Display key adjacent to the matrix, use the heart rate monitoring features and can switch to heart rate **Auto-Pilot** mode. See Heart Rate section for details of this feature).
9. When the program ends you may press Start to begin the same program again or Stop to exit the program or you can save the program you just completed as a **custom user program** by

pressing a User key and following the instructions in the message window.

Strength

The **Strength** program is designed to increase muscular strength in your lower body. This program will steadily increase in resistance to a high level and then keeps you there. This is designed to strengthen and tone your legs and gluteus. To start the Strength program follow the instructions below or just press the Strength button then the Enter button and follow the directions in the message window.

1. Press the **Strength** key then press the **Enter** key.
2. The message window will ask you to enter your **Age**. You may enter your Age, using the Up and Down keys or the numeric key pad, then press the Enter key to accept the new number and proceed on to the next screen.
3. You are now asked to enter your **Weight**. You may adjust the Weight number using the Up and Down keys or the numeric key pad, then press enter to continue.
4. Next is **Time**. You may adjust the Time and press enter to continue.
5. Now you are asked to adjust the **Max Level**. This is the peak exertion level you will experience during the program. The factory setting is level eight. Adjust the level and then press enter.
6. Now you are finished editing the settings and can begin your workout by pressing the Start key. You can also go back and modify your settings by pressing the Enter key. NOTE: At any time during the editing of Data you can press the Stop key to go back one level, or screen.
7. If you want to increase or decrease the workload at any time during the program press the Up or Down key. This will only affect the workload for the present position in the profile. When the profile changes to the next column it will return to the preset work level.
8. During the Strength program you will be able to scroll through the data in the message window by pressing the adjacent **Display key**, switch between the profile display and a quarter mile track by pressing the Display key adjacent to the matrix, use the heart rate monitoring features and can switch to heart rate **Auto-Pilot** mode. See Heart Rate section for details of this feature).
9. When the program ends you may press Start to begin the same program again or Stop to exit the program or you can save the program you just completed as a **custom user program** by pressing a User key and following the instructions in the message window.

Interval

The **Interval** program takes you through high levels of intensity followed by periods of low intensity. This program increases your endurance by depleting your oxygen level followed by periods of recovery to replenish oxygen. Your cardio vascular system gets programmed to use oxygen more efficiently this way. To start the Interval program follow the instructions below or just press the Interval button then the Enter button and follow the directions in the message window.

1. Press the **Interval** key then press the **Enter** key.
2. The message window will ask you to enter your **Age**. You may enter your Age, using the Up and Down keys or the numeric key pad, then press the Enter key to accept the new number and proceed on to the next screen.
3. You are now asked to enter your **Weight**. You may adjust the Weight number using the Up and Down keys or the numeric key pad, then press enter to continue.
4. Next is **Time**. You may adjust the Time and press enter to continue.

5. Now you are asked to adjust the **Max Level**. This is the peak exertion level you will experience during the program. The factory setting is level seven. Adjust the level and then press enter.
6. Now you are finished editing the settings and can begin your workout by pressing the Start key. You can also go back and modify your settings by pressing the Enter key. NOTE: At any time during the editing of Data you can press the Stop key to go back one level, or screen.
7. If you want to increase or decrease the workload at any time during the program press the Up or Down key. This will only affect the workload for the present position in the profile. When the profile changes to the next column it will return to the preset work level.
8. During the Interval program you will be able to scroll through the data in the message window by pressing the adjacent **Display key**, switch between the profile display and a quarter mile track by pressing the Display key adjacent to the matrix, use the heart rate monitoring features and can switch to heart rate **Auto-Pilot** mode. See Heart Rate section for details of this feature).
9. When the program ends you may press Start to begin the same program again or Stop to exit the program or you can save the program you just completed as a **custom user program** by pressing a User key and following the instructions in the message window.

Custom User Defined Programs

There are two customizable **User** programs that allow you to build and save your own workout. The two programs, **User 1** and **User 2**, operate exactly the same way so there is no reason to describe them separately. You can build your own custom program by following the instructions below or you can save any other preset program you complete as a custom program. Both programs allow you to further personalize it by adding your name.

1. Press the **User 1** or **User 2** key. The message window will show a welcome message. If you had previously saved a program the message will contain your name. Then press the **Enter** key to begin programming.
2. When you press enter, the message window will show "Name – A", if there is no name saved. If the name "David" had been previously saved the message window will show "Name – David" and the D will be blinking. If there is a name saved you can change it or you may press the Stop key to keep the name and continue to the next step. If you want to enter a name use the Up and/or the Down key to change the first letter then press Enter to save the first letter and continue to the next letter. When you have finished entering the name press the Stop key to save the name and continue to the next step.
3. The message window will ask you to enter your **Age**. You may enter your Age, using the Up and Down keys or the numeric key pad, then press the Enter key to accept the new number and proceed on to the next screen.
4. You are now asked to enter your **Weight**. You may adjust the Weight number using the Up and Down keys or the numeric key pad, then press enter to continue.
5. Next is **Time**. You may adjust the Time and press enter to continue.
6. Now you are asked to adjust the **Max Level**. This is the peak exertion level you will experience during the program. The factory setting is level seven. Adjust the level and then press enter.
7. Now the first column will be blinking and you are asked to adjust the level for the first segment of the workout. When you finish adjusting the first segment, or if you don't want to change, then press enter to continue to the next segment.
8. The next segment will show the same level as the previously adjusted segment. Repeat the same process as the last segment then press enter. Continue this process until all twenty

segments have been set.

9. The message window will then tell you to press enter to save the program. After saving the program the message window says "New program saved" then will give you the option to Start or modify the program. Pressing Stop will exit to the start up screen.
10. If you want to increase or decrease the workload at any time during the program press the Up or Down key. This will only affect the workload for the present position in the profile. When the profile changes to the next column it will return to the preset work level.
11. During the User 1 or User 2 program you will be able to scroll through the data in the message window by pressing the adjacent **Display key**, switch between the profile display and a quarter mile track by pressing the Display key adjacent to the matrix, use the heart rate monitoring features and can switch to heart rate **Auto-Pilot** mode. See Heart Rate section for details of this feature).

Heart Rate programs

Before we get started, a word about Heart Rate:

The old motto, "no pain, no gain", is a myth that has been overpowered by the benefits of exercising comfortably. A great deal of this success has been promoted by the use of heart rate monitors. With the proper use of a heart rate monitor, many people find that their usual choice of exercise intensity was either too high or too low and exercise is much more enjoyable by maintaining their heart rate in the desired benefit range.

To determine the benefit range in which you wish to train, you must first determine your Maximum Heart Rate. This can be accomplished by using the following formula: 220 minus your age. This will give you the Maximum heart rate (MHR) for someone of your age. To determine the effective heart rate range for specific goals you simply calculate a percentage your MHR. Your Heart rate training zone is 50% to 90% of your maximum heart rate. 60% of your MHR is the zone that burns fat while 80% is for strengthening the cardio vascular system. This 60% to 80% is the zone to stay in for maximum benefit.

For someone who is 40 years old their target heart rate zone is calculated:

$220 - 40 = 180$ (maximum heart rate)
 $180 \times .6 = 108$ beats per minute (60% of maximum)
 $180 \times .8 = 144$ beats per minute (80% of maximum)

So for a 40 year old the training zone would be 108 to 144 beats per minute.

If you enter your age during programming the console will perform this calculation automatically. Entering your age is used for the Heart Rate control programs and also for the Heart rate bar graph. After calculating your Maximum Heart Rate you can decide upon which goal you would like to pursue.

The two most popular reasons for, or goals, of exercise are cardiovascular fitness (training for the heart and lungs) and weight control. The black columns on the chart below represent the Maximum Heart Rate for a person whose age is listed at the bottom of each column. The heart rate training zone, for either cardiovascular fitness or weight loss is represented by two different diagonal lines in the chart. A definition of the line's goal is in the bottom left-hand corner of the chart. If your goal is cardiovascular fitness or if it is weight loss, it can be achieved by training at 90% or 70%, respectively, of your Maximum Heart Rate on a schedule approved by your physician. Consult your physician before participating in any exercise program.

With all Spirit Heart Rate Control bikes you may use the heart rate monitor feature without using the Heart Rate Control program. This function can be used during manual mode or during any of the nine different programs. The Heart Rate Control program automatically controls resistance at the pedals.

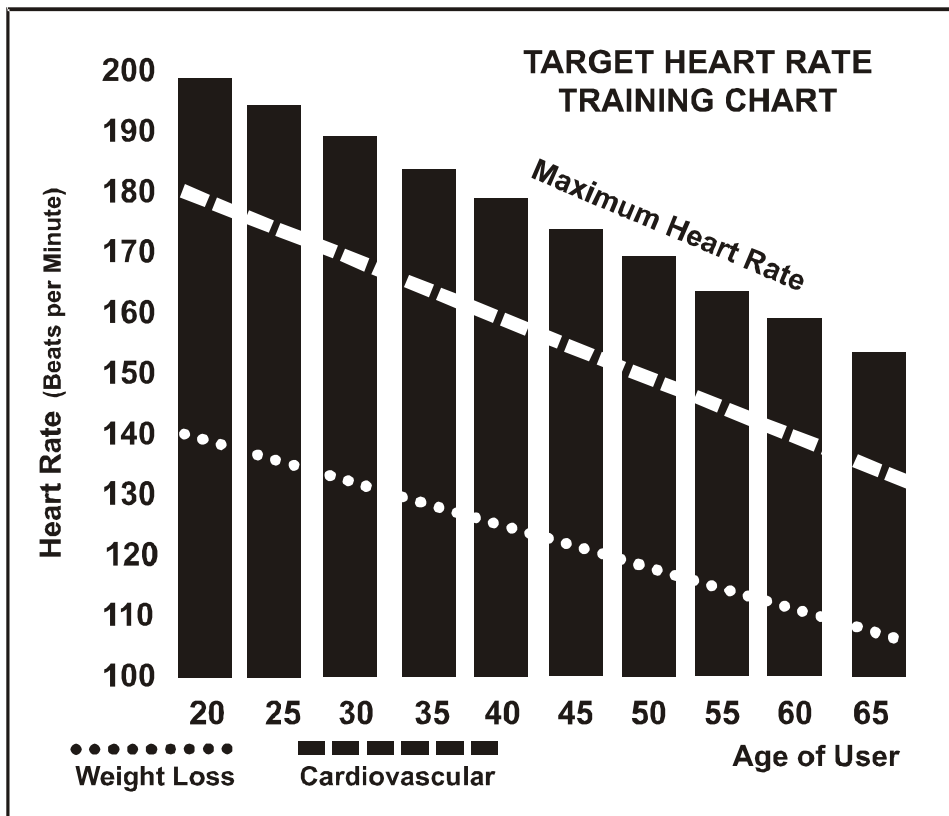

Rate of Perceived Exertion

Heart rate is important but listening to your body also has a lot of advantages. There are more variables involved in how hard you should workout than just heart rate. Your stress level, physical health, emotional health, temperature, humidity, the time of day, the last time you ate and what you ate, all contribute to the intensity at which you should workout. If you listen to your body, it will tell you all of these things.

The rate of perceived exertion (RPE), also know as the Borg scale, was developed by Swedish physiologist G.A.V. Borg. This scale rates exercise intensity from 6 to 20 depending upon how you feel or the perception of your effort.

The scale is as follows:

Rating Perception of Effort

- 6 Minimal
- 7 Very, very light
- 8 Very, very light +
- 9 Very light
- 10 Very light +
- 11 Fairly light
- 12 Comfortable
- 13 Somewhat hard
- 14 Somewhat hard +
- 15 Hard
- 16 Hard +
- 17 Very hard
- 18 Very hard +
- 19 Very, very hard
- 20 Maximal

You can get an approximate heart rate level for each rating by simply adding a zero to each rating. For example a rating of 12 will result in an approximate heart rate of 120 beats per minute. Your RPE will vary depending up the factors discussed earlier. That is the major benefit of this type of training. If your body is strong and rested, you will feel strong and your pace will feel easier. When your body is in this condition, you are able to train harder and the RPE will support this. If you are feeling tired and sluggish, it is because your body needs a break. In this condition, your pace will feel harder. Again, this will show up in your RPE and you will train at the proper level for that day.

Using a Heart Rate Transmitter

How to wear your wireless chest strap transmitter:

1. Attach the transmitter to the elastic strap using the locking parts.
2. Adjust the strap as tightly as possible as long as the strap is not too tight to remain comfortable.
3. Position the transmitter with the Polar logo centered in the middle of your body facing away from your chest (some people must position the transmitter slightly left of center). Attach the final end of the elastic strap by inserting the round end and, using the locking parts, secure the transmitter and strap around your chest.
4. Position the transmitter immediately below the pectoral muscles.
5. Sweat is the best conductor to measure very minute heart beat electrical signals. However, plain water can also be used to pre-wet the electrodes (2 black square areas on the reverse side of the belt and either side of transmitter). It's also recommended that you wear the transmitter strap a few minutes before your work out. Some users, because of body chemistry, have a more difficult time in achieving a strong, steady signal at the beginning. After "warming up", this problem lessens. As noted, wearing clothing over the transmitter/strap doesn't affect performance.
6. Your workout must be within range - distance between transmitter/receiver – to achieve a strong steady signal. The length of range may vary somewhat but generally stay close enough to the console to maintain good, strong, reliable readings. Wearing the transmitter immediately against bare skin assures you of proper operation. If you wish, you may wear the transmitter over a shirt. To do so, moisten the areas of the shirt that the electrodes will rest upon.

Note: The transmitter is automatically activated when it detects activity from the user's heart. Additionally, it automatically deactivates when it does not receive any activity. Although the transmitter is water resistant, moisture can have the effect of creating false signals, so you should take precautions to completely dry the transmitter after use to prolong battery life (estimated transmitter battery life is 2500 hours). The replacement battery is Panasonic CR2032.

Erratic Operation:

Caution! Do not use this bike for Heart Rate Control unless a steady, solid Actual Heart Rate value is being displayed. High, wild, random numbers being displayed indicate a problem.

Areas to look at for interference, which may cause erratic heart rate:

- (1) Microwave ovens, TVs, small appliances, etc.
- (2) Fluorescent lights.
- (3) Some household security systems.
- (4) Perimeter fence for a pet.
- (5) Some people have problems with the transmitter picking up a signal from their skin. If you have problems try wearing the transmitter upside down. Normally the transmitter will be oriented so the Polar logo is right side up.
- (6) The antenna that picks up your heart rate is very sensitive. If there is an outside noise source, turning the whole machine 90 degrees may de-tune the interference.
- (7) *If you continue to experience problems contact your dealer.*

Heart Rate Control Program 1 & 2 (HR 1, HR 2) operation

Both programs operate the same, the only difference is that HR 1 is set to 60% and HR 2 is set to 80% of maximum heart rate. They both are programmed the same way.

To start the **HR 1 or HR 2** programs follow the instructions below or just press the HR 1 or HR 2 button then the Enter button and follow the directions in the message window.

1. Press the **HR 1 or HR 2** key then press the **Enter** key.
2. The message window will ask you to enter your **Age**. You may enter your Age, using the Up and Down keys or the numeric key pad, then press the Enter key to accept the new number and proceed on to the next screen.
3. You are now asked to enter your **Weight**. You may adjust the Weight number using the Up and Down keys or the numeric key pad, then press enter to continue.
4. Next is **Time**. You may adjust the Time and press enter to continue.
5. Now you are asked to adjust the **Heart rate Level**. This is the heart rate level you will experience during the program. Adjust the level and then press enter.
6. Now you are finished editing the settings and can begin your workout by pressing the Start key. You can also go back and modify your settings by pressing the Enter key. **NOTE:** At any time during the editing of Data you can press the Stop key to go back one level, or screen.
7. If you want to increase or decrease the workload at any time during the program press the Up or Down key. This will allow you to change your target heart rate at any time during the program.
8. During the HR 1 or HR 2 programs you will be able to scroll through the data in the message window by pressing the adjacent **Display key**.
9. When the program ends you may press Start to begin the same program again or Stop to exit the program or you can save the program you just completed as a **custom user program** by pressing a User key and following the instructions in the message window.

Auto-pilot

The **Auto-pilot** feature is a unique heart rate program. This program allows you to enter the Heart Rate Control program on the fly. At any time, during any program, you can press the Auto-pilot button and the console will switch to heart rate control mode. The console will maintain your heart rate at the current level when you press the Auto-pilot button. For instance: If you are in the Manual mode and your heart rate is at 150 beats per minute, pressing the Auto-pilot button will switch the console to heart rate control and keep your heart rate at 150 beats per minute automatically.

Maintenance:

1. Wipe down all areas in the sweat path with a damp cloth after each workout.
2. If a squeak, thump, clicking or rough feeling develops the main cause is most likely one of two reasons:
 - i. The hardware was not sufficiently tightened during assembly. All bolts that were installed during assembly need to be tightened as much as possible. It may be necessary to use a larger wrench than the one provided if you cannot tighten the bolts sufficiently. I cannot stress this point enough; 90% of calls to the service department for noise issues can be traced to loose hardware or the rear rails being dirty.
 - ii. Dirt build-up on the rear rails and polyurethane wheels are also a source of noise. Noise from build-up on the rails can cause a thumping sound that you would swear is coming from inside the main body of the machine because noise travels, and is amplified, in the tubing of the frame. Clean the rails and wheels with a lint free cloth and rubbing alcohol. Stubborn build-up can be removed with your thumbnail or a non-metallic scraper, like the back edge of a plastic knife. After cleaning, apply a small amount of lubricant on the rails with your fingers or a lint free cloth. You only need a thin coat of lubrication, wipe off any excess.
3. If squeaks or other noises persist, check that the unit is properly leveled. There are 4 leveling pads on the bottom of the rear rails, use a 14mm wrench (or adjustable wrench) to adjust the levelers.

Maintenance Menu in console software:

The console has built in maintenance/diagnostic software. The software will allow you to change the console settings from English to Metric and turn off the beeping of the speaker when a key is pressed for example. To enter the Maintenance menu (may be called Engineering mode, depending on version) press and hold down the Start, Stop and Enter keys. Keep holding the keys down for about 5 seconds and the message window will display "ALTXXX Engineering mode". Press the enter button to access the menu below:

- a. **Key test** (will allow you to test all the keys to make sure they are functioning)
- b. **Display test** (tests all the display functions)
- c. **Functions** (Press enter to access settings)
 - i. **Sleep mode** (Turn on to have the console power down automatically after 20 minutes of inactivity)
 - ii. **Pause Mode** (Turn on allow 5 minutes of pause, turn off to have the console pause indefinitely)
 - iii. **ODO reset** (reset the odometer)
 - iv. **Units** (Set to English or Metric display readings)
 - v. **Beep** (Turn on or off the beep when a key is pressed)
 - vi. **D/A test** (tests the brake resistance)
 - vii. **Exit**
- d. **Security** (Allows you to lock the keypad so no unauthorized use is allowed)
- e. **Factory settings** (Access only allowed by manufacturing)

Manufacturer's Limited Warranty

Effective October 15, 2007
ELLIPTICAL WARRANTY

Spirit Manufacturing Inc. warrants all its elliptical parts for a period listed below, from the date of retail sale as determined by sale receipt, or in the absence of a sales receipt eighteen (18) months from the original factory shipping date, whichever comes first. Spirit's responsibilities include providing new or remanufactured parts, at Spirit's option, and technical support to our independent dealers and servicing organizations. In the absence of a dealer or service organization, these warranties will be administered by Spirit directly to a consumer. The warranty period applies to the following components:

<u>Home use</u>		<u>Light commercial</u>	
Labor	1 Year	Labor	1 year
Frame weldments	Lifetime	All Other Components	3 Years
All Other Components	10 Years	Frame Weldments	Lifetime
Brake	Lifetime	Brake	5 years

NORMAL RESPONSIBILITIES OF THE CONSUMER

This warranty applies only to products in ordinary household use, and the consumer is responsible for the items listed below:

1. The warranty registration card must be completed and returned to the address listed on the card within 10 days of the original purchase to validate the manufacturer's limited warranty.
2. Proper use of the elliptical in accordance with the instructions provided in this manual
3. Proper installation by an authorized Spirit service company in accordance with instructions provided with the elliptical and with all local electric codes.
4. Proper connection to a grounded power supply of sufficient voltage, replacement of blown fuses, repair of loose connections or defects in house wiring.
5. Expenses for making the elliptical accessible for servicing, including any item that was not part of the elliptical at the time it was shipped from the factory.
6. Damages to the elliptical finish during shipping, installation or following installation.

EXCLUSIONS

This warranty does not cover the following:

1. CONSEQUENTIAL, COLLATERAL, OR INCIDENTAL DAMAGES SUCH AS PROPERTY DAMAGE AND INCIDENTAL EXPENSES RESULTING FROM ANY BREACH OF THIS WRITTEN OR ANY IMPLIED WARRANTY.

Note: Some states do not allow the exclusion or limitation of incidental or consequential damages, so this limitation or exclusion may not apply to you.

2. Service call reimbursement to the consumer. Service call reimbursement to the dealer that does not involve malfunction or defects in workmanship or material, for units that are beyond the warranty period, for units that are beyond the service call reimbursement period, for elliptical not requiring component replacement, or elliptical not in ordinary household use.
3. Damages caused by services performed by persons other than authorized Spirit service companies; use of parts other than original Spirit parts; or external causes such as alterations, modifications, abuse, misuse, accident, improper maintenance, inadequate power supply, or acts of God.
4. Products with original serial numbers that have been removed or altered.
5. Products that have been sold, transferred, bartered, or given to a third party.
6. Products that do not have a warranty registration card on file at Spirit Mfg. Spirit reserves the right to request proof of purchase if no warranty record exists for the product.
7. THIS WARRANTY IS EXPRESSLY IN LIEU OF ALL OTHER WARRANTIES EXPRESSED OR IMPLIED, INCLUDING THE WARRANTIES OF MERCHANTABILITY AND/OR FITNESS FOR A PARTICULAR PURPOSE.

SERVICE

Keep your bill of sale. Twelve (12) months from the date on the bill of sale or eighteen (18) months from the date of factory shipping as determined by the serial number establishes the warranty period should service be required. If service is performed, it is in your best interest to obtain and keep all receipts. This written warranty gives you specific legal rights. You may also have other rights that vary from state to state. Service under this warranty must be obtained by following these steps, in order:

1. Contact your selling authorized Spirit dealer. OR
2. Contact your local authorized Spirit service organization.
3. If there is a question as to where to obtain service, contact our service department at (870) 935-1107.
4. If no local service is available, Spirit will repair or replace the parts, at Spirit's option, within the warranty period at no charge for parts. All transportation costs, both to our factory and upon return to the owner, are the responsibility of the owner. The owner is responsible for adequate packaging upon return to Spirit. Spirit is not responsible for damages in shipping. Make all freight damage claims with the appropriate freight carrier. DO NOT SHIP ANY UNIT TO OUR FACTORY WITHOUT A RETURN AUTHORIZATION NUMBER. All units arriving without a return authorization number will be refused.
5. For any further information, or to contact our service department by mail, send your correspondence to:

Spirit Manufacturing, Inc.
P.O. Box 2037
Jonesboro, AR 72402-2037

Product features or specifications as described or illustrated are subject to change without notice. All warranties are made by Spirit Manufacturing, Inc. This warranty applies only in the 50 states of the U.S.A.

Free Manuals Download Website

<http://myh66.com>

<http://usermanuals.us>

<http://www.somanuals.com>

<http://www.4manuals.cc>

<http://www.manual-lib.com>

<http://www.404manual.com>

<http://www.luxmanual.com>

<http://aubethermostatmanual.com>

Golf course search by state

<http://golfingnear.com>

Email search by domain

<http://emailbydomain.com>

Auto manuals search

<http://auto.somanuals.com>

TV manuals search

<http://tv.somanuals.com>