

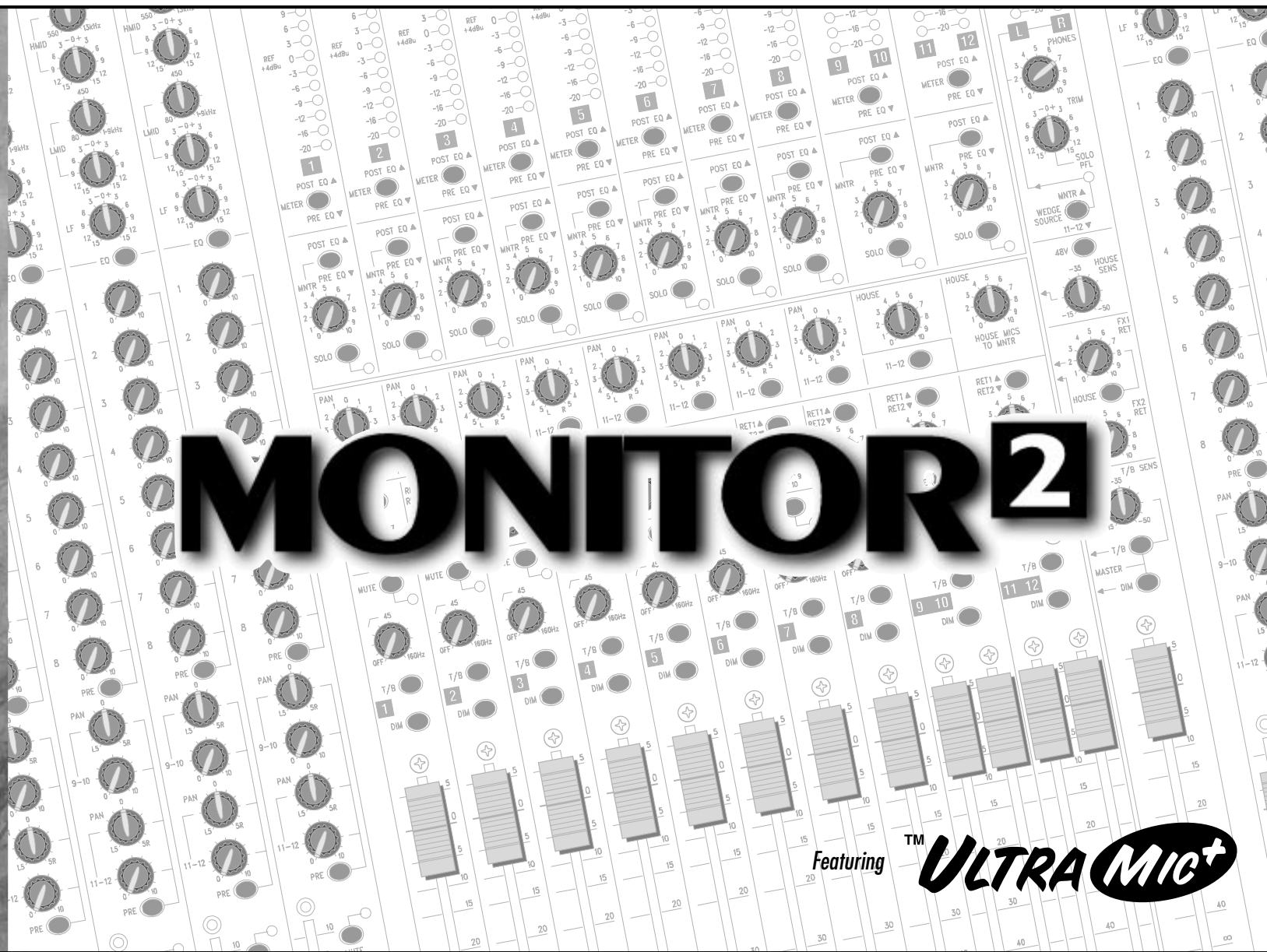

**SPIRIT**  
By Soundcraft

**SPIRIT**



# MONITOR 2

Featuring **ULTRA MIC<sup>+</sup>**

## USERS GUIDE

Handbuch  
Manuel d'utilisation

Manuale Utente  
Guía del usuario

**For your own safety and to avoid invalidation of the warranty please read this section carefully.**



## **INTRODUCTION**

**Thank you for purchasing a Monitor 2 mixer, brought to you with pride by the SPIRIT team of Andy, Colin, Chris, James, Simon, Mukesh, Graham, Martin, Paul, Tony and Peter, with the support of many others - we hope you will have as much fun using it as we did building it!**

## **SAFETY PRECAUTIONS**

**The SPIRIT MONITOR 2 mixer must only be connected through the Power Supply supplied.**

The wires in the mains lead are coloured in accordance with the following code:

*Earth:* Green and Yellow  
(Green/Yellow - US)

*Neutral:* Blue  
(White - US)

*Live:* Brown  
(Black - US)

As the colours of the wires in the mains lead may not correspond with the coloured markings identifying the terminals in your plug, proceed as follows:

- The wire which is coloured Green and Yellow must be connected to the terminal in the plug which is marked with the letter E or by the earth symbol.
- The wire which is coloured Blue must be connected to the terminal in the plug which is marked with the letter N.
- The wire which is coloured Brown must be connected to the terminal in the plug which is marked with the letter L.

Ensure that these colour codings are followed carefully in the event of the plug being changed.

**To avoid the risk of fire, replace the mains fuse only with the correct value fuse, as marked on the rear panel.**

# Connecting Up

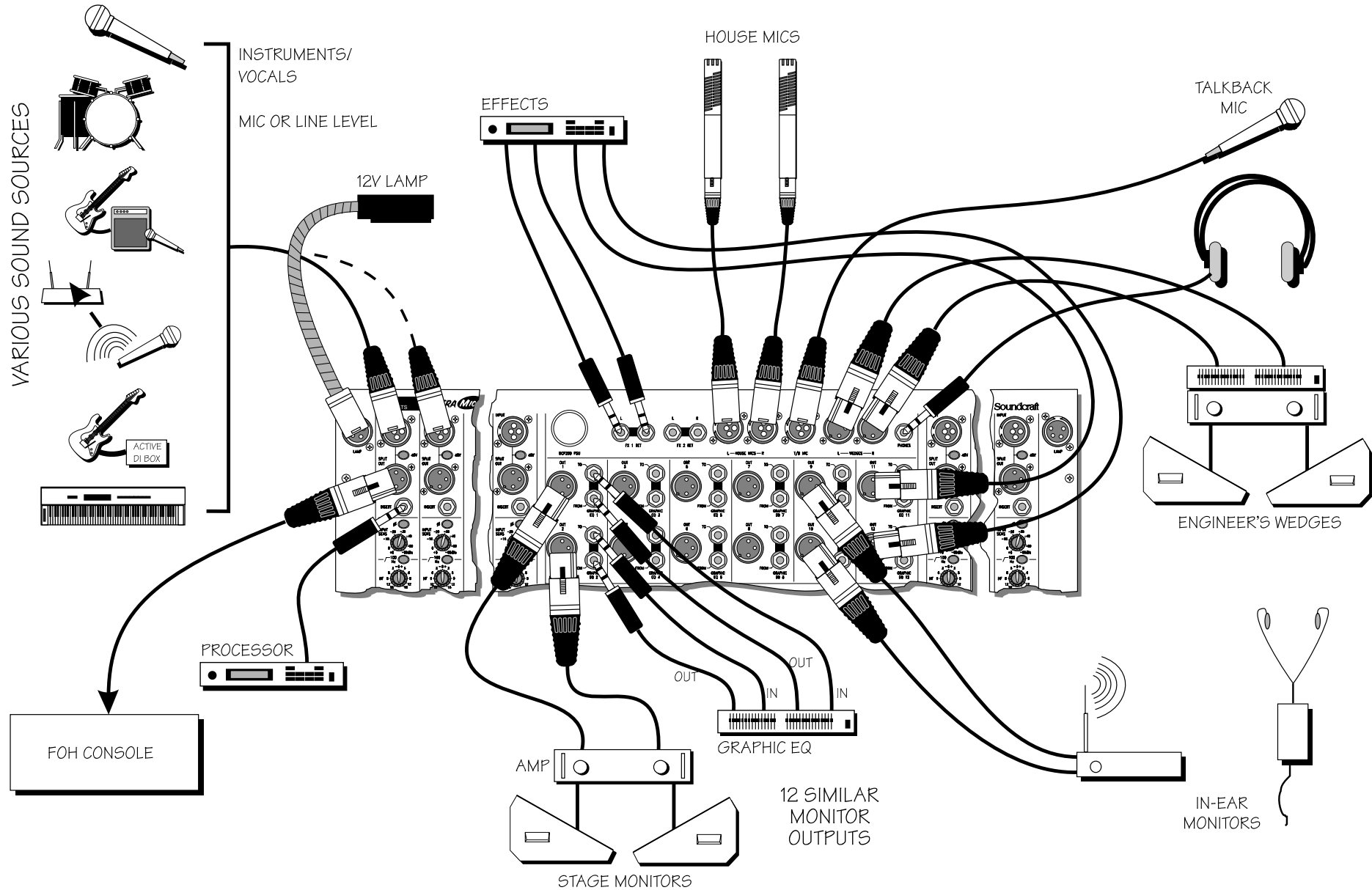

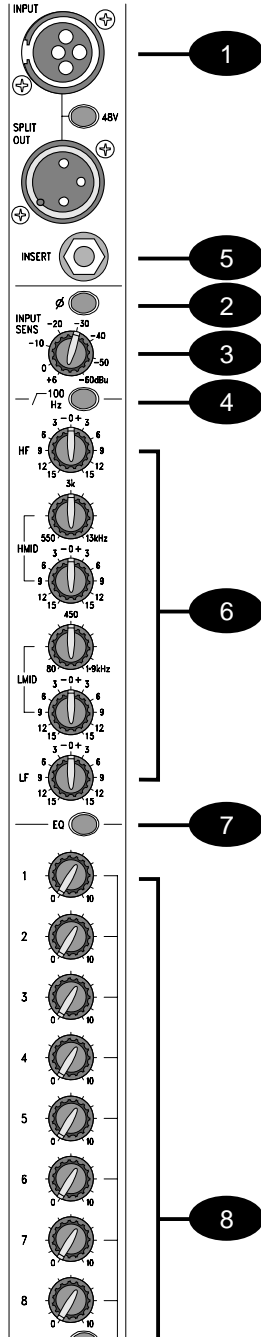
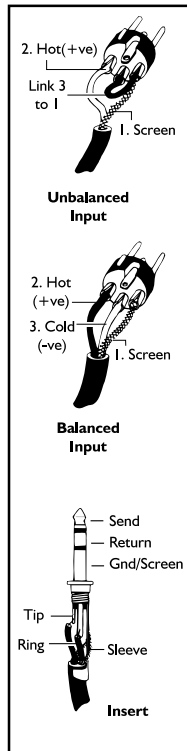

## USING MONITOR 2

### Mono Input Channel

#### 1 XLR Input <sup>™</sup> ULTRA MIC<sup>+</sup>

The UltraMic Plus padless input preamp is designed to accept BALANCED or UNBALANCED signals at a wide range of input levels up to +28dBu. When using microphones, professional dynamic, condenser or ribbon mics are best because these will be LOW IMPEDANCE. You can use low-cost HIGH IMPEDANCE mics, but the level of background noise will be higher. If you press the 48V switch down the socket provides a suitable powering voltage for professional condenser mics (this is also known as Phantom Power).

Each input is provided with a male XLR-type SPLIT OUT connector, which enables mic signals to be fed directly to a Front-of-House mixer without the need for special cables or splitter boxes. Always provide 48V powering from the Monitor 2 console if required, and turn off the powering at the FOH console.

An internal jumper option is provided to allow the ground connection to the SPLIT OUT connector to be lifted to prevent ground loops in certain installations.

**ONLY connect condenser microphones with the 48V powering OFF (switch UP), and ONLY turn the 48V powering on or off with all output faders DOWN, to prevent damage to the mixer or external devices. If the SPLIT OUT connectors are used to feed another mixer, the MONITOR 2 console should be powered up first, or the faders on the FOH console should all be down when the MONITOR 2 is powered up or split feeds connected.**

**DO NOT turn on the +48V when using unbalanced sources or line level signals, which may be damaged by the phantom power voltage on pins 2 & 3 of the XLR connector, and ONLY connect the SPLIT OUT feed to inputs which can tolerate phantom power voltages if the powering is in use.**

#### 2 PHASE REVERSE

Pressing this switch reverses the polarity of the input, providing a convenient method of compensating for incorrect wiring or microphone placement. In some circumstances it may be found that pressing PHASE REVERSE will help with feedback avoidance. The switch should normally be released when not required. Note that the SPLIT OUT feed is NOT affected by this switch.

#### 3 SENS (Sensitivity)

This knob sets how much of the source signal is sent to the rest of the mixer. Too high, and the signal will distort as it overloads the channel. Too low, and the level of any background hiss will be more noticeable and you may not be able to get enough signal level to the output of the mixer. Setting the knob to the '0' mark gives unity gain for line level signals. See 'Setting Up & Troubleshooting' on page 8 to learn how to set SENS correctly.

#### 4 100Hz HI-PASS FILTER

Pressing this switch activates a steep 18dB per octave filter which reduces the level of bass frequencies only. Use this in live PA situations to clean up the mix, reducing stage rumble or 'popping' from microphones.

#### 5 INSERT POINT

The unbalanced, pre-EQ insert point is a break in the channel signal path, allowing limiters, compressors, special EQ or other signal processing units to be added in the signal path. The Insert is a 3-pole 'A' gauge jack socket which is normally bypassed. When a jack is inserted, the signal path is broken, just before the EQ section. The Send may be tapped off as a line level, pre-fade, pre-EQ send of a mic source if required, using a lead with tip and ring shorted together so that the signal path is not interrupted.

#### 6 EQUALISER

Powerful, corrective Equalisation (EQ) is essential in live situations to cope with varying venue acoustics and original signals which may be far from ideal. Each Monitor 2 input is provided with a comprehensive 4-Band EQ section, with two swept mids for extra control.

#### HF EQ

Turn clockwise to boost high (treble) frequencies (12kHz and above) by up to 15dB, adding crispness to cymbals, vocals and electronic instruments. Turn anticlockwise to cut by up to 15dB, reducing hiss or excessive sibilance which can occur with certain types of microphone. Set the knob in the centre-detented position when not required.

#### MID EQ (HMID & LMID)

There are two pairs of knobs which work together to form HI and LO MID frequency EQ sections. The lower knob in each pair provides 15dB of boost and cut, just like the HF EQ knob, but the frequency at which this occurs can be set by the upper knob over a range of 550Hz to 13kHz (HMID) or 80Hz to 1.9kHz (LMID). This allows some truly creative improvement of the signal in live situations, because the mid bands cover the range of most vocals. Listen carefully as you use these controls together to find how particular characteristics of, for instance, a vocal signal can be enhanced or reduced. Set the gain (lower) knob to the centre-detented position when not required. Note: Q is set at 1.5.

#### LF EQ

Turn clockwise to boost low (bass) frequencies (60Hz and below) by up to 15dB, adding warmth to vocals or extra punch to synths, guitars and drums. Turn anticlockwise to cut low frequencies by up to 15dB for reducing hum, stage rumble or to improve a mushy sound. Set the knob to the centre-detented position when not required.

#### 7 EQ SWITCH

The EQ switch bypasses the Equalisation section when released. Alternately pressing and releasing the switch provides an easy way of comparing the equalised and unequalised signals.

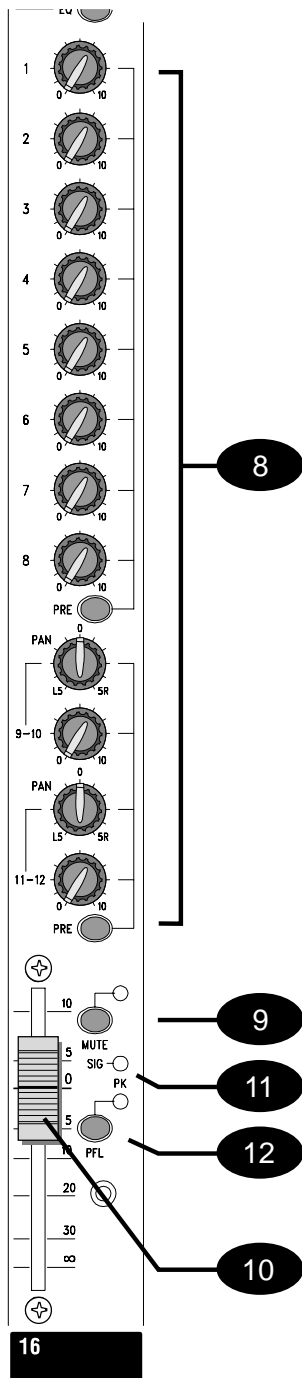

## 8 MONITOR SENDS

These controls route the input channel signal to any one or more Monitor Busses and the associated Monitor Outputs, allowing a number of unique monitor mixes to be created. The sends are arranged as a group of mono sends (1-8) and two stereo pairs (9/10 & 11/12). Each group of sends is normally POST-FADE, POST-EQ but may be switched to PRE-FADE, POST-EQ by pressing the corresponding PRE switch. All sends are muted when the MUTE switch (9) is pressed. Sends 9-12 are arranged as two stereo pairs, with a send level control and a PAN control to position the channel signal in the stereo image. With the PAN control centered, the signal is fed equally to both sends in the pair. You get most control when the input Sensitivity is set up correctly, giving maximum travel on the send controls. See the 'Setting Up & Troubleshooting' section on page 8 for help in setting a suitable signal level.

## 9 MUTE

All monitor sends are disabled when the MUTE switch is down, and the associated amber LED illuminates to show that the switch is pressed.

## 10 FADER

The FADER provides overall level control of any Monitor Sends which are selected as post-fade. You get most control when the input Sensitivity is set up correctly, giving full travel on the fader. See the 'Setting Up & Troubleshooting' section on page 8 for help in setting a suitable signal level.

## 11 SIGNAL LED

This green LED illuminates to show that a signal with a level greater than -20dB is present in the channel.

## 12 PFL/PEAK

When the latching PFL switch is pressed, the pre-fade, post-EQ signal is fed to the headphones and engineer's wedge outputs, replacing the selected wedge source and illuminating the SOLO/PFL LED on the Master section to show that a PFL is active. The adjacent red LED lights to identify the selected channel. This is a useful way of listening to any required input signal without interrupting any of the monitor sends, for making adjustments or tracing problems.

When the PFL switch is released the LED serves as a PEAK indicator which illuminates approximately 4dB before clipping to give warning of a possible overload. The signal is sampled at two points in the EQ section and at the Insert Send.

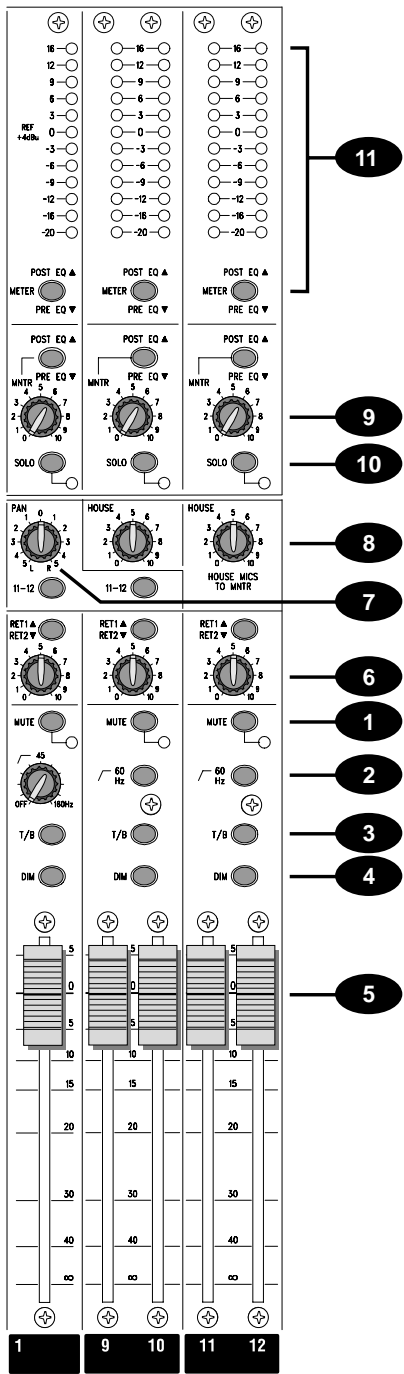

## OUTPUT SECTION

### MONITOR OUTPUTS

These outputs provide summing of the corresponding input channel monitor sends, and drive XLR-type output sockets from impedance balanced outputs. A break-point is included before each output socket for the connection of an external graphic equaliser.

Outputs 1-8 are configured as mono sends, and outputs 9/10 and 11/12 are arranged as stereo pairs.

#### 1 MUTE

The monitor send is completely disabled when the MUTE switch is pressed, and the adjacent LED illuminates to warn that the mute is active.

#### 2 HIGH PASS FILTER (1-8 only)

A variable High Pass Filter is provided to reduce the level of stage-driven low frequency feedback, or particularly to tailor the output frequency to match the frequency range of smaller wedge monitor speakers which may not be able to tolerate high levels of LF signal. Rotate the control fully anticlockwise when the filter is not required.

#### 60Hz Filter (9-12 only)

A fixed 60Hz high-pass filter is provided on outputs 9/10 and 11/12, which might typically be used for in-ear monitor transmitters, effects sends or FOH PA. The filter helps to clean up the mix and reduce large low frequency transients.

#### 3 T/B

Pressing the T/B (Talkback) switch routes the talkback mic signal to the monitor output and simultaneously dims the monitor signal to allow the engineer's voice to be heard over the mix. The Talkback level is set by the T/B SENS control on the Master section. Talkback is disabled when the DIM switch is pressed.

#### 4 DIM

Pressing the DIM switch attenuates the monitor output by 6dB as an immediate way of eliminating feedback while the source of the problem is identified.

#### 5 FADER

The 100mm fader controls the overall level of each output. The '0' mark gives unity gain from the fader, leaving 5dB in hand.

#### 6 FX RETURNS

The signal from either of the two stereo FX Returns may be mixed directly to the Monitor output at a level set by the local control (overall level is set by the FX1 RET and FX2 RET controls on the Master section). The RET1/RET2 switch selects FX Return 1 when released, and FX Return 2 when pressed. On outputs 1-8 the FX Return signal will be a mono sum of left and right, and on 9-10 and 11-12 the signal will be fed in stereo. Note that FX Return 1 may be globally switched from the Master section to be the House Mic signal if required.

#### 7 FOH Facility

A sub-grouping facility is included on outputs 1-10 to allow the console to be used as a FOH mixer. Pressing the 11-12 switch routes the post-fade, post-insert signal to the Monitor 11/12 busses, enabling these outputs to be used as a stereo final mix. The PAN control positions the monitor signal in the stereo image (outputs 1-8 only). Final mix level is controlled by the 11-12 Monitor Fader.

#### 8 HOUSE

On the stereo output pairs (9/10 and 11/12) the HOUSE control injects an ambience signal picked up from the stereo House Mic inputs into the monitor outputs, which is particularly important when feeding in-ear monitors.

#### 9 MNTR (Monitor - Engineer's Wedge)

A separate monitor mix may be created for the Engineer's Wedge monitor or Headphones. The POST EQ/PRE EQ switch selects the source for the mix as before or after the Graphic EQ insert point, and will normally be post-EQ (switch released). Rotate the MNTR control fully anticlockwise when not required.

#### 10 SOLO

When the latching SOLO switch is pressed, the post- or pre-Graphic EQ signal (as selected by the POST EQ/PRE EQ switch) is fed to the headphones and engineer's wedge outputs, replacing the selected wedge source and illuminating the SOLO/PFL LED on the Master section. The adjacent red LED lights to identify the active solo. This is a useful way of listening to any required output signal without interrupting any of the monitor sends, for making adjustments or tracing problems. In the case of outputs 1-8 the SOLO signal will be mono to left and right, while 9/10 and 11/12 are fed as stereo.

#### 11 BARGRAPH METERS

3-colour peak reading BARGRAPH METERS are provided to monitor the final output, giving you a constant warning of excessive peaks in the signal which might cause overloading. Aim to keep the signal within the amber segments at peak levels for best performance. Similarly, if the output level is too low and hardly registering at all on the meters, the level of background noise may become significant. Take care to set up the input levels for best performance.

The source for the meter may be selected as PRE or POST the Graphic EQ insert point, as set by the adjacent METER switch. With the switch released the meter will be fed from the POST-EQ signal.

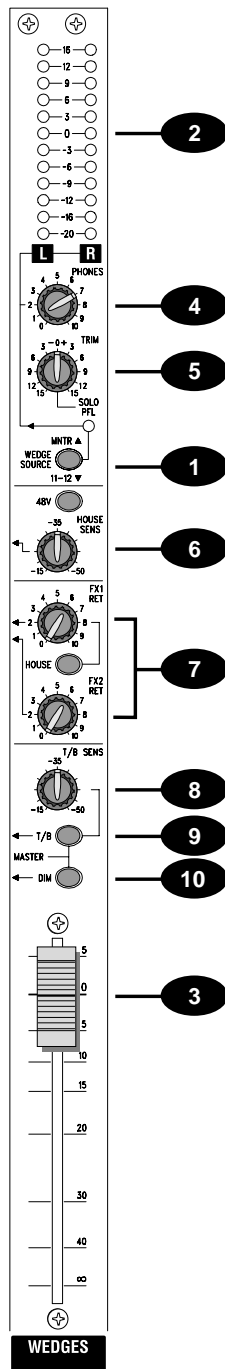

FOH

## MASTER SECTION

### 1 WEDGE SOURCE

The Engineer's Wedge outputs are normally fed from a mix of the MNTR feeds from outputs 1-12. The pre-fade wedge signal feeds the headphones and meters and the post-fade signal feeds the XLR outputs.

Pressing the WEDGE SOURCE switch selects monitor outputs 11-12 as the source for the wedge outputs, and would be used to monitor those outputs when the mixer is used as a FOH console with outputs 1-10 submixing to 11-12.

When any PFL or SOLO switch is pressed the source for the Wedges is switched to the PFL/SOLO signal without interrupting the other outputs from the mixer, to allow individual signals to be monitored. The original wedge source is restored when the PFL/SOLO switches are released.

### 2 BARGRAPH METERS

3-colour peak reading BARGRAPH METERS are provided to monitor the wedge outputs, giving you a constant warning of excessive peaks in the signal which might cause overloading. Aim to keep the signal within the amber segments at peak levels for best performance. Similarly, if the output level is too low and hardly registering at all on the meters, the level of background noise may become significant. Take care to set up the input levels for best performance.

The source for the meter is selected by the WEDGE SOURCE switch (see above).

### 3 FADER

The 100mm fader controls the overall level of the wedges output. The '0' mark gives unity gain from the fader, leaving 5dB in hand.

### 4 PHONES

This control sets the level to the PHONES jack. The source for the Phones is selected by the WEDGE SOURCE switch.

When any PFL or SOLO switch is pressed the source for the Headphones is switched to the PFL/SOLO signal without interrupting the other outputs from the mixer, to allow individual signals to be monitored. The original phones source is restored when the PFL/SOLO switches are released.

### 5 SOLO/PFL TRIM

The TRIM control provides +/-15dB level adjustment of the SOLO/PFL signal to allow for differences in operating levels. Note that the position of this control does not affect the level to the meters.

### 6 HOUSE MICS

Two balanced XLR inputs are provided for House Mics, and the HOUSE SENS control sets the input level.

Pressing +48V switches on the powering voltage for condenser microphones if required.

**ONLY connect condenser microphones with the 48V powering OFF (switch UP), and ONLY turn the 48V powering on or off with all output faders DOWN, to prevent damage to the mixer or external devices.**

### 7 FX RETURNS

Two balanced Stereo Returns are included for the outputs of effects units and are made available for mixing directly to the Monitor outputs at a level set by the FX1 RET or FX2 RET controls. If a mono source is used, plugging into the Left jack only automatically feeds the signal to both Left and Right. Pressing the HOUSE switch replaces the FX Return 1 signal with the House Mics signal (at a level set by the HOUSE SENS control), to allow the House Mics signal to be fed to any of the monitor outputs. Note that the House Mics signal can be injected directly into outputs 9/10 and 11/12 without using this facility.

### 8 T/B SENS

A balanced XLR input is provided for a local talkback microphone, and this controls sets the level that this mic signal is fed to the selected monitor outputs.

### 9 MASTER T/B

Pressing this switch routes the Talkback signal to ALL monitor outputs and simultaneously dims the monitor signals to allow the engineer's voice to be heard over the mix. The Talkback level is set by the T/B SENS control. Talkback is disabled when the Master DIM switch is pressed.

### 10 MASTER DIM

Pressing the DIM switch attenuates ALL monitor outputs and the wedges output by 6dB as an immediate way of eliminating feedback while the source of the problem is identified. The previous level is restored when the switch is released.

### LAMP CONNECTOR (not illustrated)

Two 4-pin XLR-type connectors are fitted at either end of the console for the mounting of 12V gooseneck lamps (Littlite or similar).

The connector pinout is as follows:

Pin 1 -	12V AC (1)
Pin 2 -	No connection
Pin 3 -	12V AC (1)
Pin 4 -	12V AC (2)

# Setting Up & Troubleshooting

## Initial Set Up

Once you have connected up your system (see the sections on connection and wiring earlier in this manual for guidance) you are ready to set initial positions for the controls on your mixer.

**The front panel drawing on page 17 shows typical initial control positions which may serve as a useful guide to setting up the mixer for the first time.**

Set up individual input channel as follows:

- Connect your sources (microphone, keyboard etc.) to the required inputs. Note: Phantom powered mics should be connected before the 48V is switched on.
- The input provides very wide gain range without the need for a pad. When using LINE level sources, set the INPUT SENS control fully anticlockwise as a preliminary position.
- Set Monitor faders at 0, input faders at 0, and set power amplifier levels to suit the application. Make sure that the EQ switches are released to bypass the EQ sections.
- Provide a typical performance level signal and press the PFL button on the first channel, monitoring the level on the L/R bargraph meters.
- Adjust the input sensitivity until the meter display is in the amber section, with occasional peaks to the first red LED at a typical maximum source level. This allows sufficient headroom to accommodate peaks and establishes the maximum level for normal operation (but see note below).

- Feed the signal to selected monitor outputs by setting the appropriate monitor sends to an initial working level (approx. position 7 on the send knob). Listen to the signal by feeding the selected monitor signal to the engineer's wedge by turning up the MNTR control on the appropriate outputs, checking that the wedge source is selected to MNTR.
- Repeat this procedure on other channels as required. As more channels are added to the mix, the meters may move into the red section. Adjust the overall level using the Monitor Output faders if necessary.
- Listen carefully for the characteristic sound of 'feedback'. If you cannot achieve satisfactory input level setting without feedback, check microphone and speaker placement and repeat the exercise. If feedback persists, it may be necessary to use a Graphic Equaliser to reduce the system response at particular resonant frequencies.

*Note: The initial settings should only be regarded as a starting point for your mix. It is important to remember that many factors affect the sound during a live performance, for instance the channel EQ settings or even the size of the audience!*

Each monitor mix can now be built up progressively, listening carefully for each component in the mix and watching the meters for any hint of overload. If this occurs, back off the appropriate Input Fader slightly until the level is out of the red segments, or adjust the Monitor Faders.

## Troubleshooting

### No Power

- Is the mains supply present? Check the mains outlet with another device.
- Is the power lead firmly connected?

### Condenser Mic Not Working

- Is the 48V turned on?
- Is there an unbalanced device connected to the SPLIT OUT connector?
- Is the mic cable a balanced 3-wire type?

### Meters not showing any signal

- Has the input gain been set correctly (see above)?
- Are the Monitor faders set at a working level., and are input faders set high enough?
- Is the MUTE switch released on the relevant channels?
- If monitoring on the wedge outputs, is the appropriate Monitor output feeding the wedges (MNTR control set to working level), and the wedge source selected to MNTR?
- Is there a PFL/AFL pressed on another channel?

### No Monitor output, or output low level

- Is the MUTE switch released?
- Is a Graphic EQ or other external device connected to the graphic Insert, and is this device switched on and set up correctly?
- Are the local or Master DIM or T/B switches released?

### Headphones Distorting

- Are the headphones less than 200Ω impedance?
- Is the Phones level set too high?

*Hum on outputs when SPLIT OUT sockets are used*

- Check for ground loops, and try isolating the SPLIT OUT ground connection by removing the internal jumper which is normally fitted (see below).

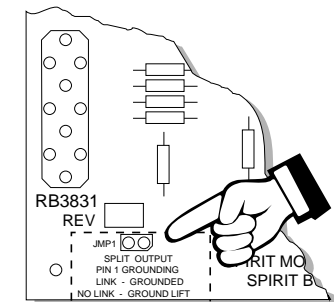



# APPLICATIONS

## Live Monitor with Effects

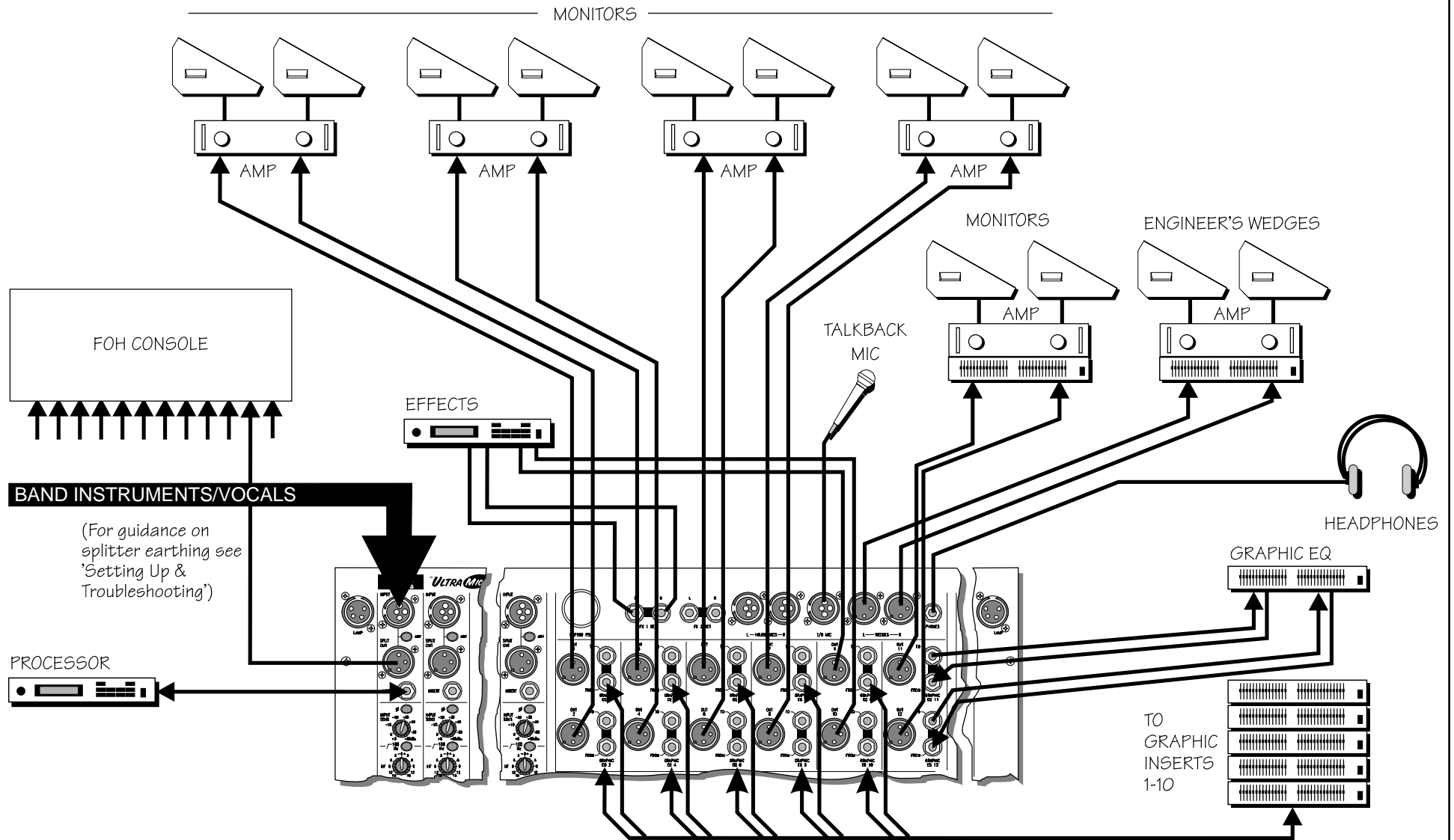

# Live Monitor with In-Ear Monitoring

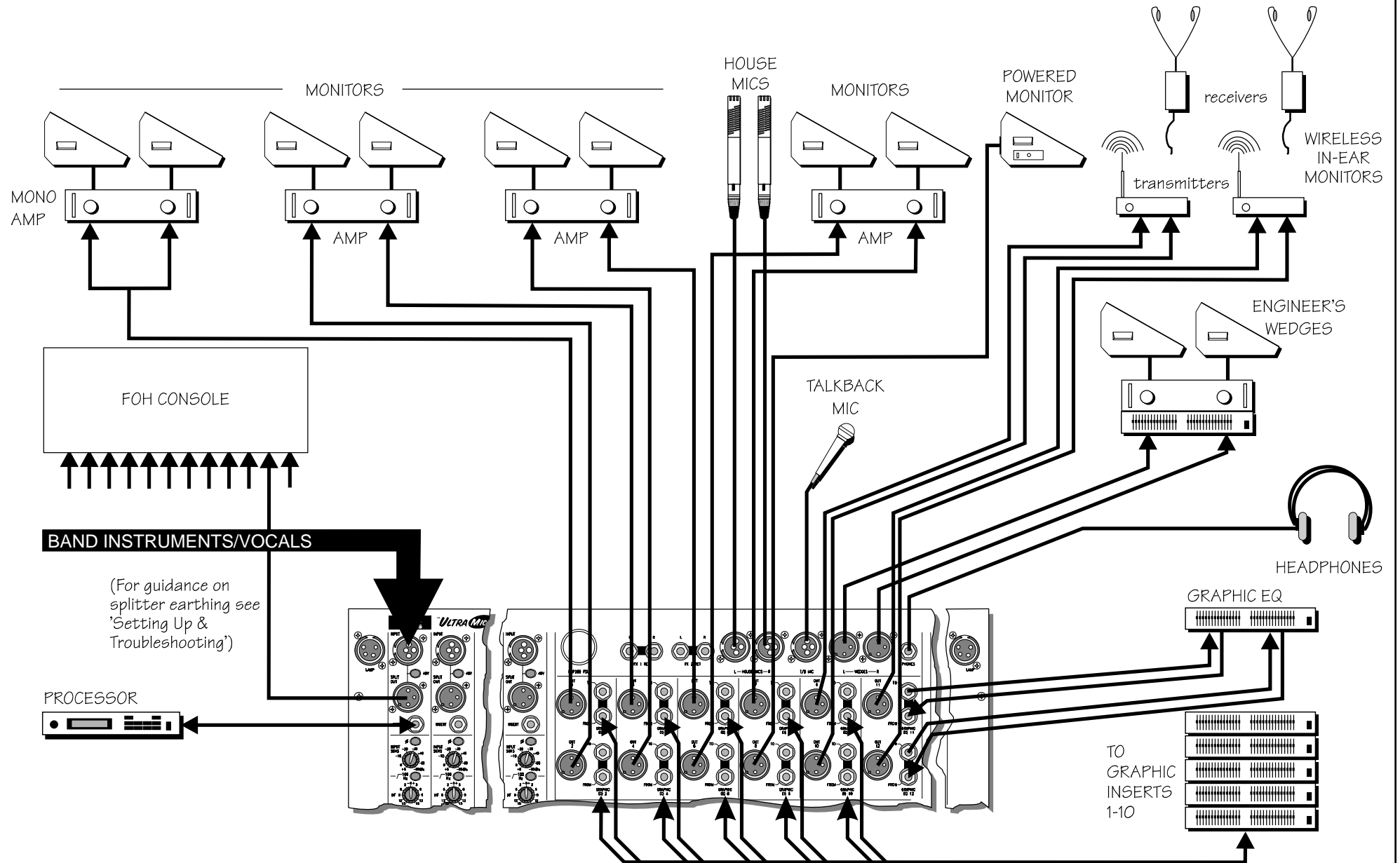

# Theatre

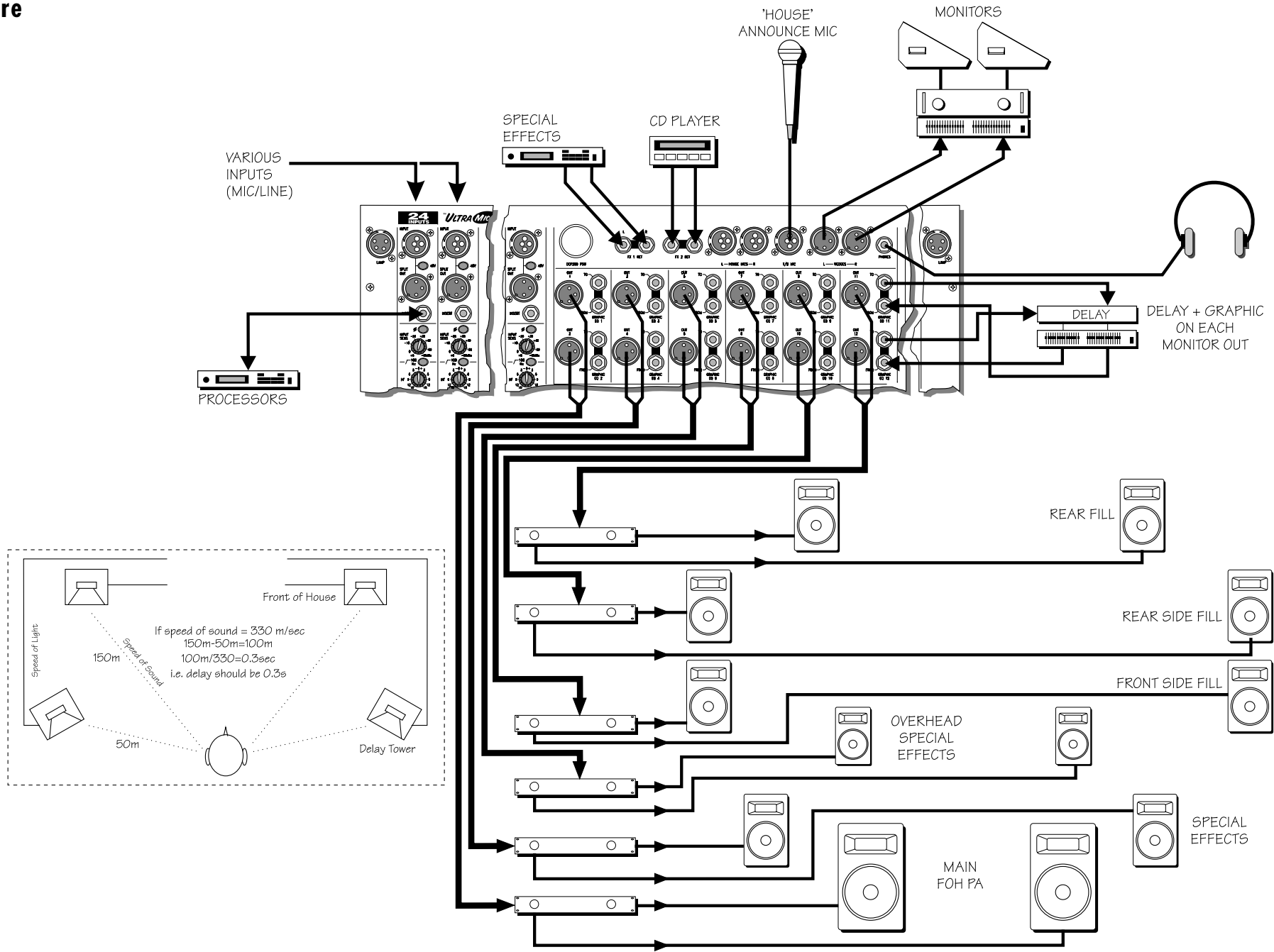

# FOH Console

MONITOR SENDS CONFIGURATION		
PRE/POST FADE	SEND	APPLICATION
PRE	1	MONITOR 1
PRE	2	MONITOR 2
PRE	3	MONITOR 3
PRE	4	MONITOR 4
PRE	5	MONITOR 5
PRE	6	MONITOR 6
PRE	7	MONITOR 7
PRE	8	MONITOR 8
POST	9-10	EFFECTS 1 & 2
POST	11-12	MAIN PA BUSS

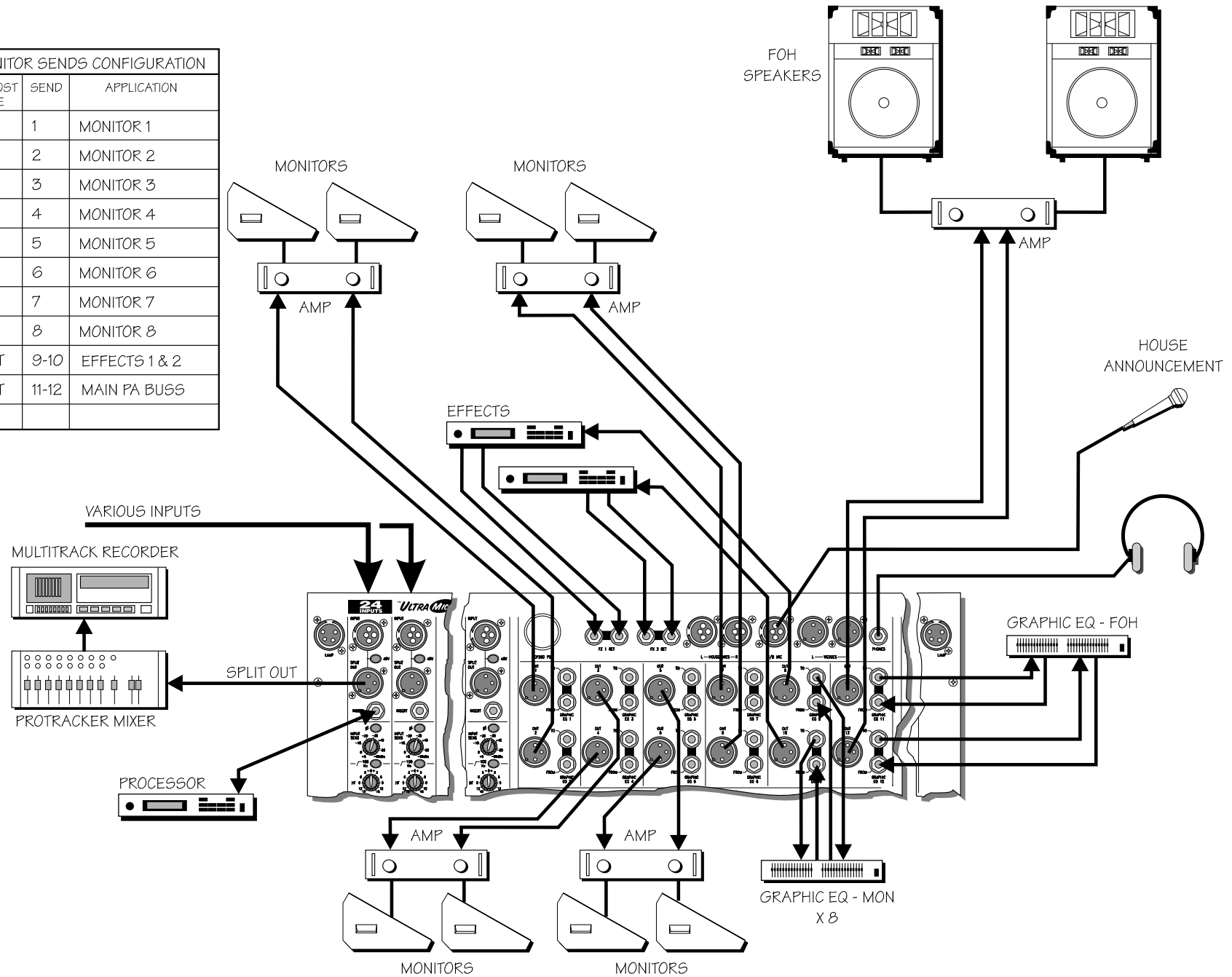

# FOH Console with Subgrouping

MONITOR SENDS CONFIGURATION		
PRE/POST FADE	SEND	APPLICATION
POST	1	> 11-12
POST	2	> 11-12
POST	3	> 11-12
POST	4	> 11-12
POST	5	> 11-12
POST	6	> 11-12
POST	7	EFFECTS 1
POST	8	EFFECTS 2
PRE	9-10	STAGE MONITORS
PRE	11-12	MAIN PA BUSS (Channel Sends not used)

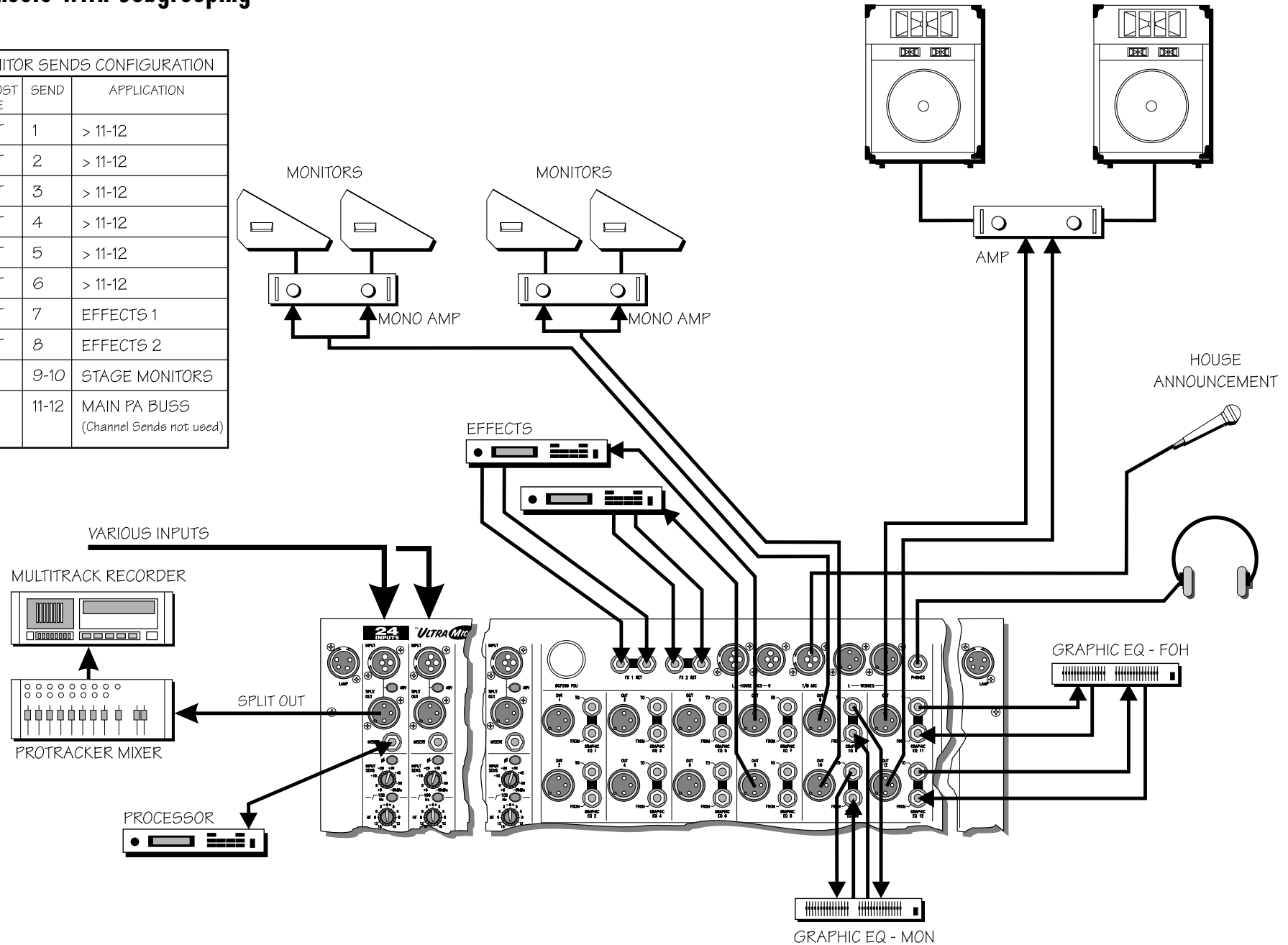

# System Block Diagram

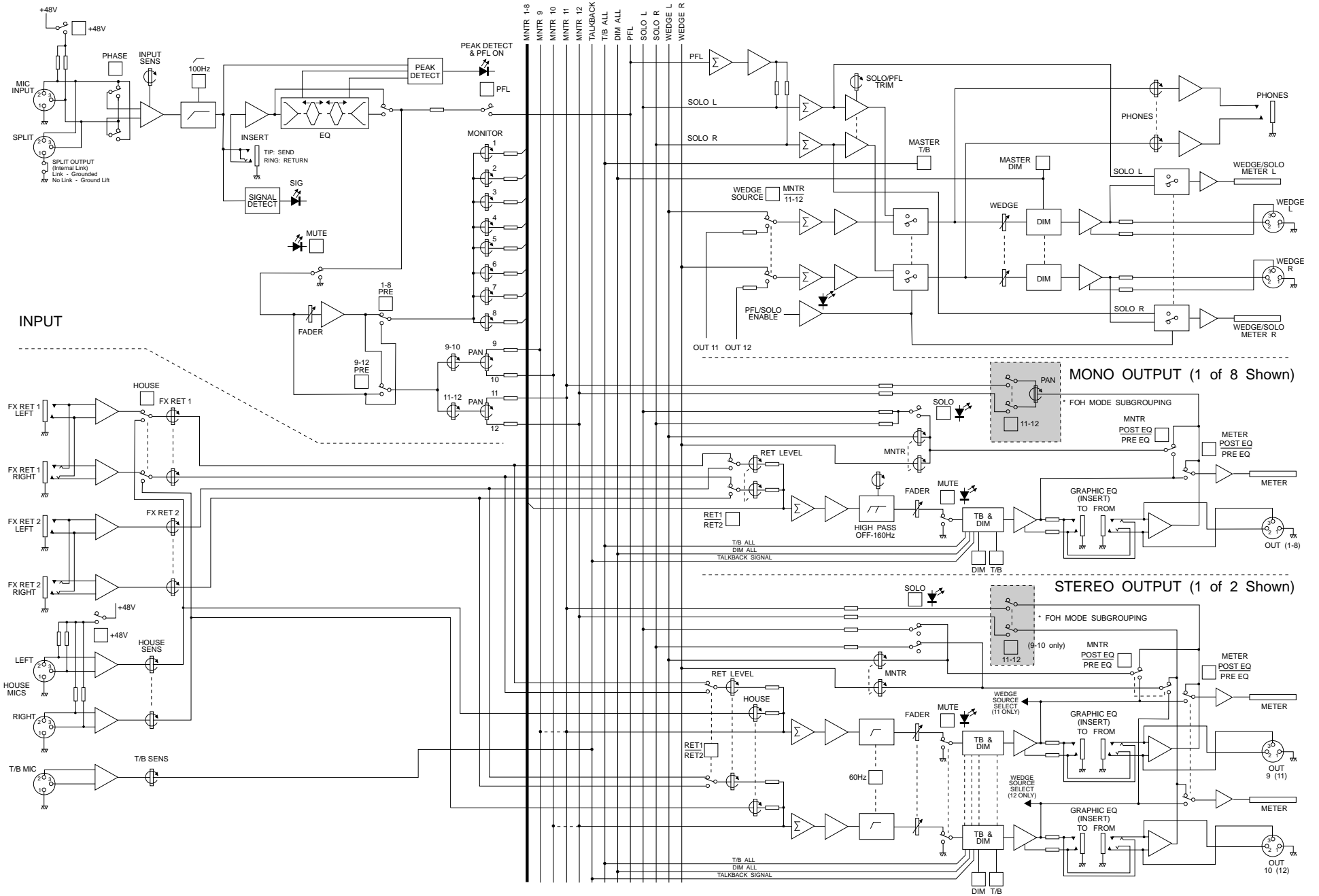

# Connecting Leads

## Balanced

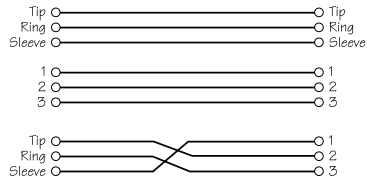
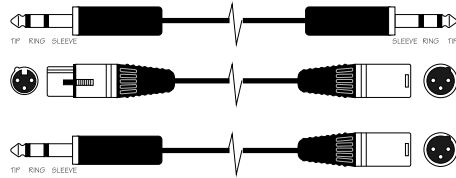

## Unbalanced

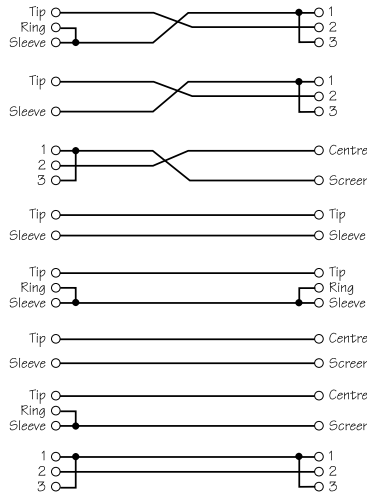
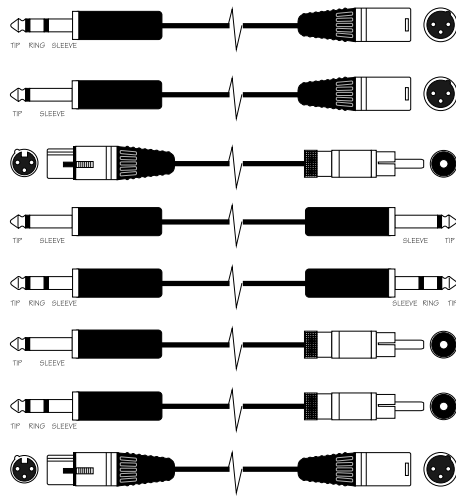

## Insert Leads

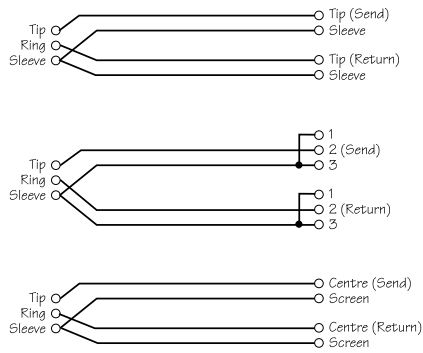
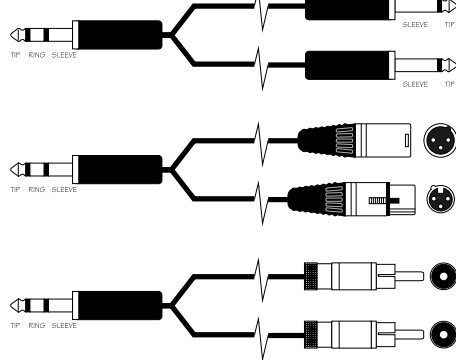

## 'Y' Leads (Balanced)

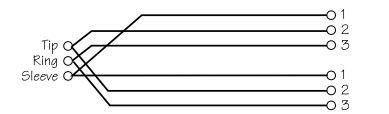
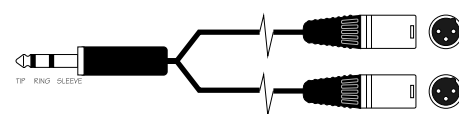
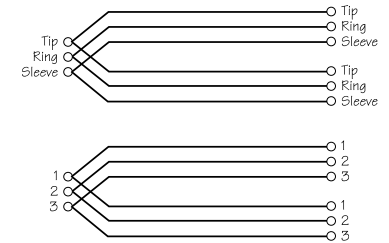
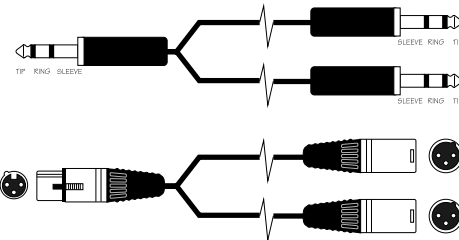

## Headphone Splitter

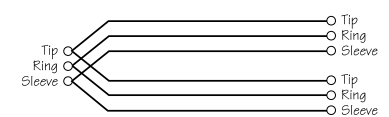

## 'Y' Leads (Unbalanced)

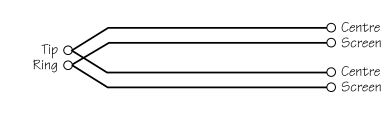
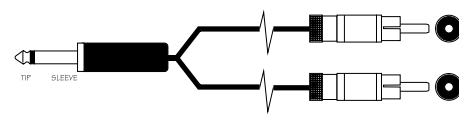
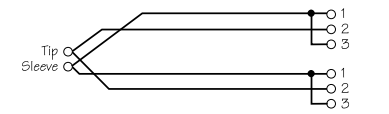
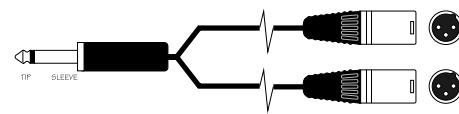
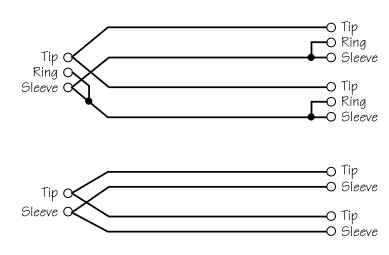
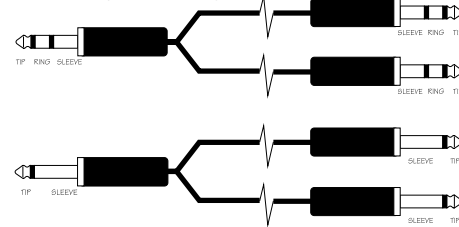

## Lamp Connections



Gig: .....

Date: .....

Engineer: .....

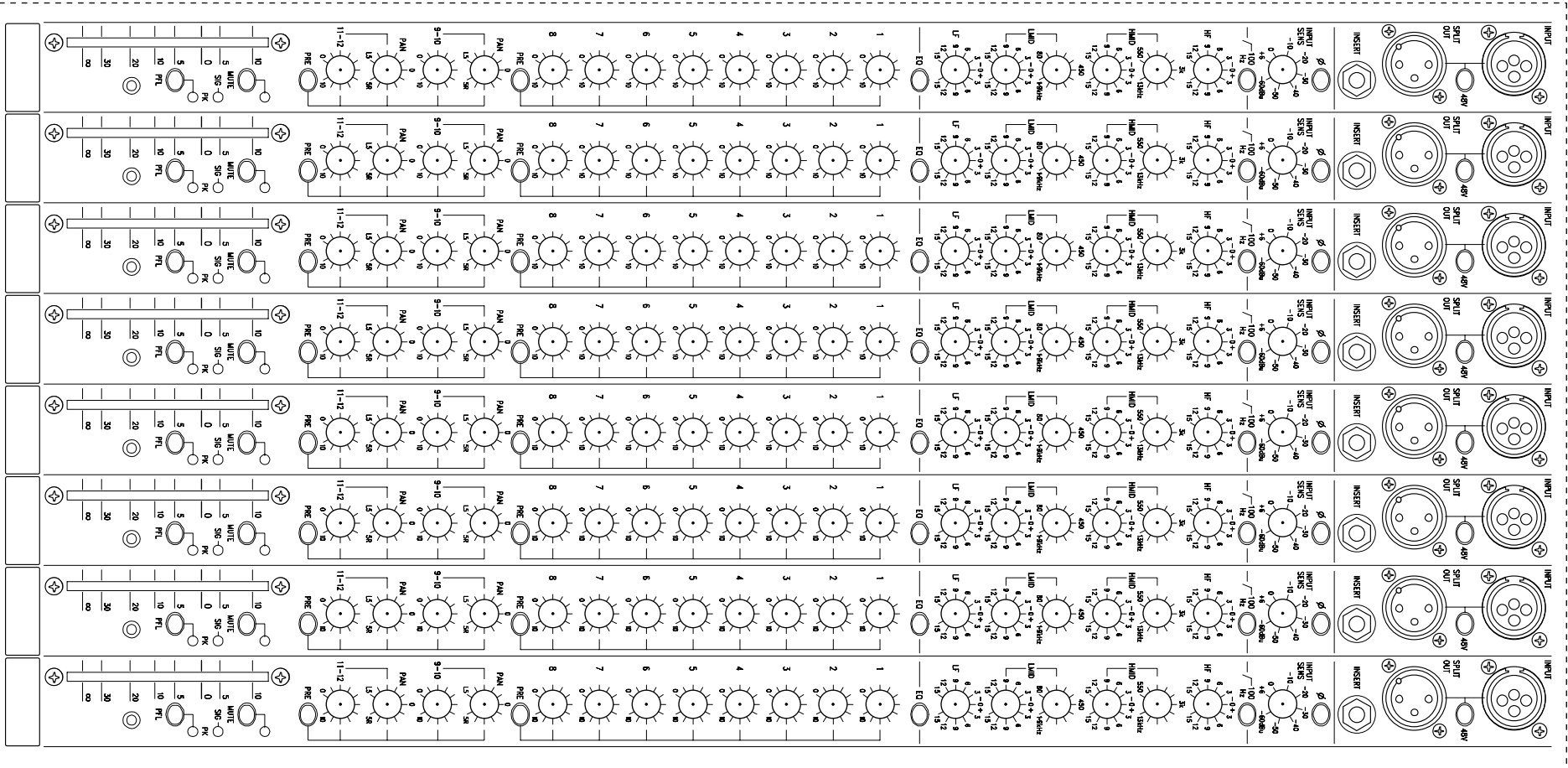

### Control Position Sheet

You may freely copy this page to mark control positions to assist in resetting the desk between performances.

Sheet Title:

Sheet Title:

Sheet Title:

Sheet Title:

Sheet Title:

Sheet Title:

Sheet Title:





# MONITOR 2 CONSOLE

## Typical Starting Out Control Positions

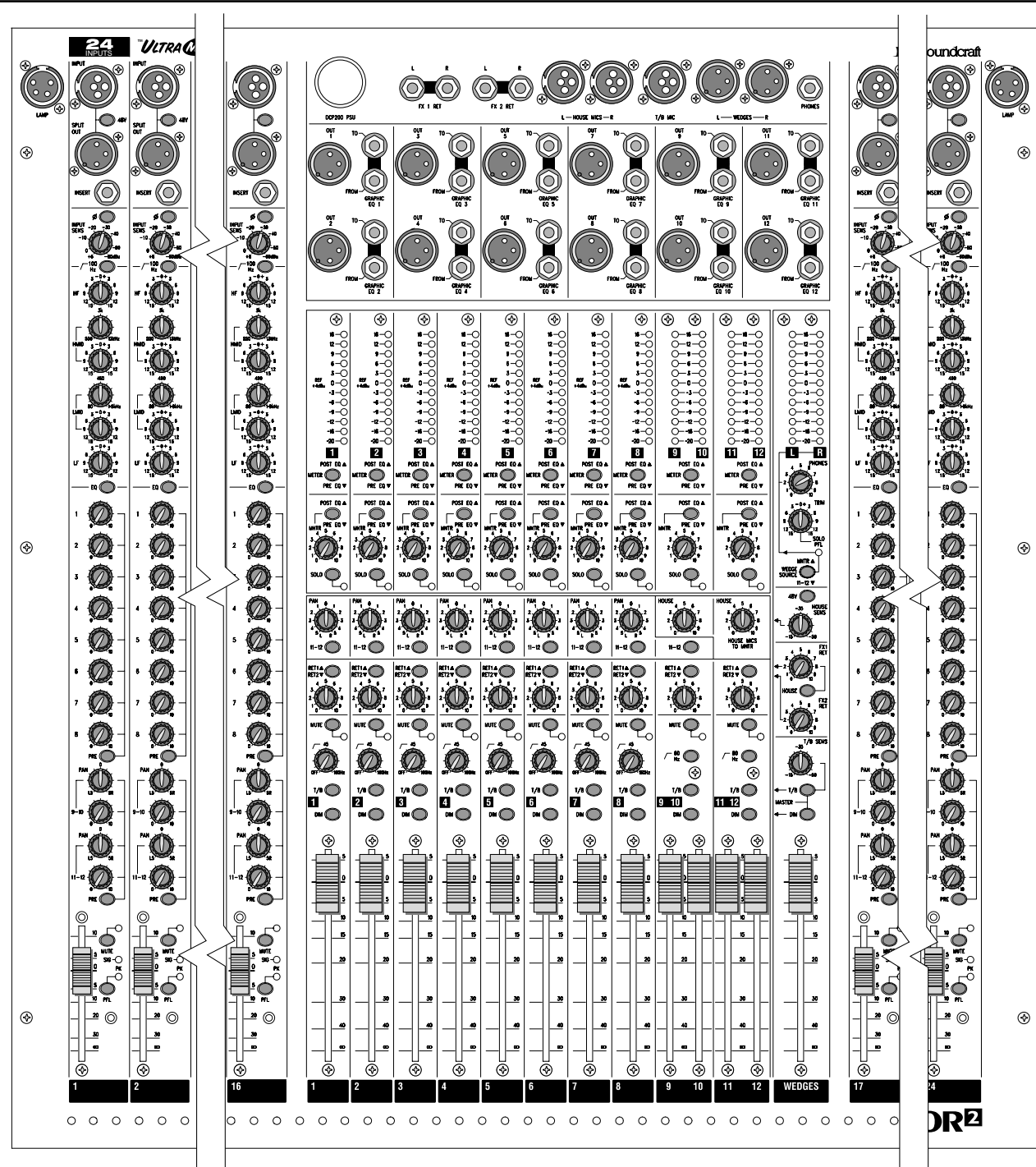

## Dimensions

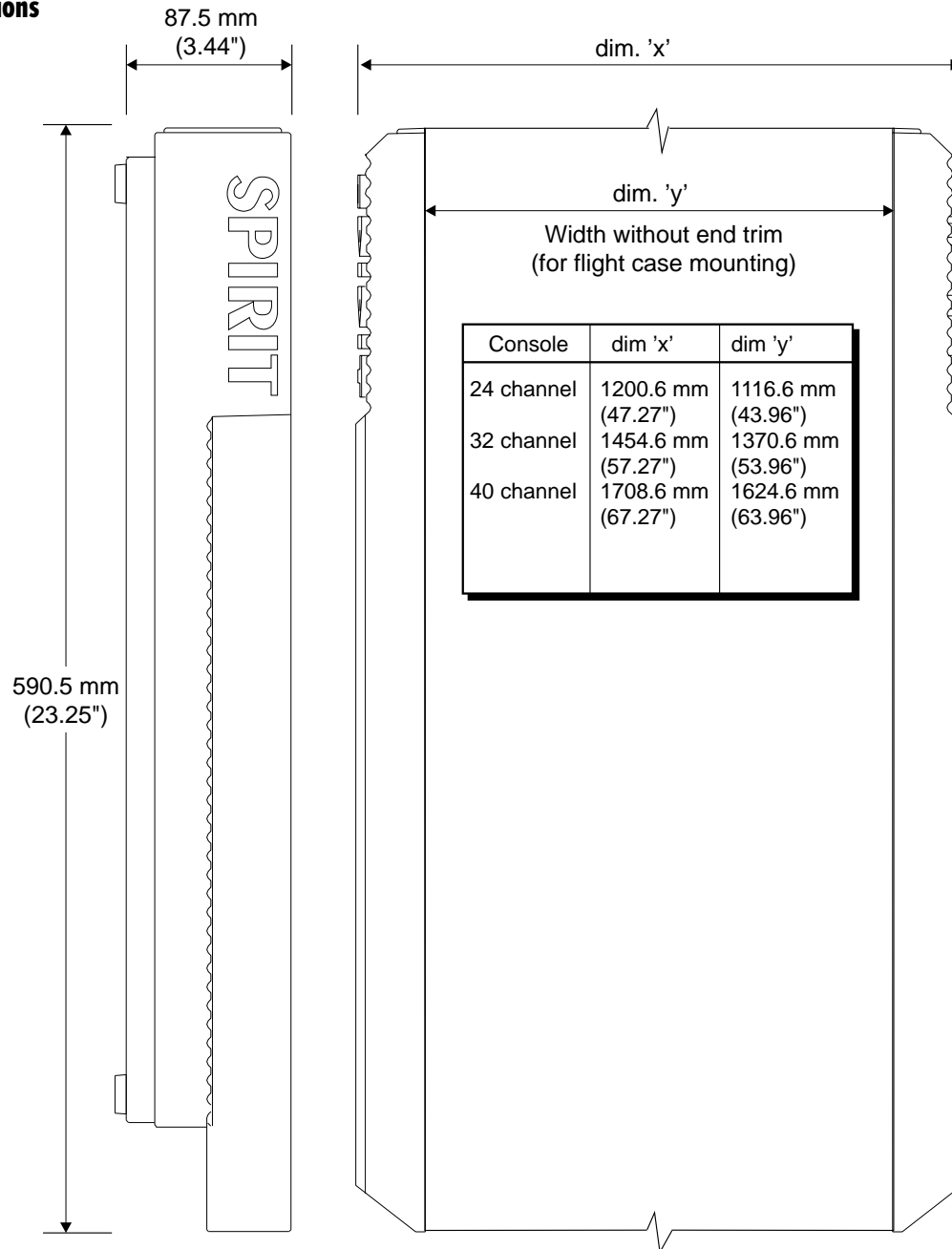

## Specifications

### Noise

Measured RMS, 22Hz to 22kHz Bandwidth. Inputs at unity gain and terminated 150Ω  
 Output Noise  
 24 inputs routed, sends down, master @ unity < -80dBu

### EIN

Mic EIN @ max. gain (150Ω terminated) -129dBu

### THD+N

Mic sens. -10dBu, Faders @ unity, send at max., +20dBu at all outputs @ 1kHz < 0.005%

### Crosstalk (@ 1kHz) Typical

Channel send range > 90dB  
 Channel fader range > 80dB  
 Mute attenuation > 100dB  
 Adjacent output isolation > 90dB

### CMRR

Typical at max gain @ 1kHz > 85dB  
 Typical at any gain @ 50Hz > 65dB

### Frequency Response

Input to output, medium gain, via output (Hi-pass filter off)  
 15Hz to 45kHz < -3dB  
 25Hz to 25kHz < -1dB

### Typical Input and Output levels

Maximum output > +22dBu  
 Maximum signal into mic input +28dBu  
 Maximum signal into FX return & insert return +22dBu  
 Maximum sensitivity of FX return (Output faders @ unity) -15dBu  
 Maximum level into Talkback mic input +3dBu  
 Maximum level into House mic input +8dBu  
 Headphones (@ 200Ω) 150mW

### Input and Output Impedance

Mic Input 1.8kΩ  
 FX returns 8.6kΩ  
 Monitor Outputs, Wedge & Inserts 75Ω



Spirit By Soundcraft™  
Harman International Industries Ltd., Cranborne House,  
Cranborne Road, Potters Bar, Herts., EN6 3JN U.K.  
Tel: +44 (0) 1707 665000 Fax: +44 (0) 1707 665461  
<http://www.spirit-by-soundcraft.co.uk>

**H** A Harman International Company

Spirit By Soundcraft™ Inc.,  
11820 Kemper Road,  
Auburn, CA. 95603  
Tel: (916) 888 0488 Fax: (916) 888 0480

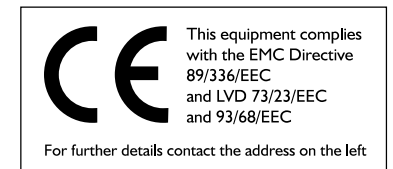

Part No: ZM0192

## Free Manuals Download Website

<http://myh66.com>

<http://usermanuals.us>

<http://www.somanuals.com>

<http://www.4manuals.cc>

<http://www.manual-lib.com>

<http://www.404manual.com>

<http://www.luxmanual.com>

<http://aubethermostatmanual.com>

Golf course search by state

<http://golfingnear.com>

Email search by domain

<http://emailbydomain.com>

Auto manuals search

<http://auto.somanuals.com>

TV manuals search

<http://tv.somanuals.com>