



QUANTUM GX5500S

25 Watt VHF/FM

Marine Transceiver

Owner's Manual

- Commercial Grade ITU Class D DSC Transceiver
 - Superior Receiver Performance (80 dB rejection)
 - 30W Loud Hailer complete with Listen Back and 4 Fog Horns, Bells, and Whistle
 - 2.2 inch Internal Speaker Produces Clear Load Audio
 - 2.58 x 1.28 inch Dot Matrix Display
 - Alphanumeric keypad allows direct entry of channel numbers or selection of most used functions
 - NAV mode, Displays Latitude/Longitude, Position Time, SOG, COG
 - Oversized Rotary Selector, Volume and Squelch Knobs
 - Programmable Scan, Selectable Priority Scan, and Dual Watch
 - One-Button Access to Channel 16 and 9
 - Treble and Bass Audio Tone Control
 - Two Inputs for Optional RAM+ or VH-310 Remote Microphone
 - Optional Voice Scrambler
 - Plug and Play Front or Rear Panel Microphone (optional MEK-4 extension cable available)
- * When attached to GPS Receiver



TABLE OF CONTENTS

1	GENERAL INFORMATION	4
1.1	INTRODUCTION	4
2	PACKING LIST	4
3	OPTIONS	5
4.	SAFETY/WARNING INFORMATION	5
5	FCC RADIO LICENSE INFORMATION	6
5.1	STATION LICENSE	6
5.2	RADIO CALL SIGN	6
5.3	CANADIAN SHIP STATION LICENSING	6
5.4	FCC / INDUSTRY CANADA INFORMATION	6
6	FCC NOTICE	7
7	GETTING STARTED	8
7.1	ABOUT VHF RADIO	8
7.2	SELECTING AN ANTENNA	8
7.3	COAXIAL CABLE	8
8	INSTALLATION	9
8.1	LOCATION	9
8.2	ELECTRICAL CONNECTIONS	9
8.3	ACCESSORY CABLE	10
8.4	CHECKING GPS CONNECTIONS	12
8.5	CHANGING THE GPS TIME	12
8.6	CHANGING THE TIME LOCATION	13
8.7	CHANGING COG TO TRUE OR MAGNETIC	13
8.8	TREBLE AND BASS AUDIO TONE CONTROL	14
8.9	OPTIONAL MMB-84 FLUSH MOUNT INSTALLATION	15
8.10	OPTIONAL ENHANCED RAM+ SECOND STATION MIC OR VH-310 HANDSET INSTALLATION	16
9	CONTROLS AND INDICATORS	18
9.1	CONTROLS AND CONNECTIONS	18
10	BASIC OPERATION	24
10.1	PROHIBITED COMMUNICATIONS	24
10.2	RECEPTION	24
10.3	TRANSMISSION	25
10.4	TRANSMIT TIME-OUT TIMER (TOT)	25
10.5	SIMPLEX/DUPLEX CHANNEL USE	25
10.6	USA, CANADA, AND INTERNATIONAL MODE	25
10.7	NOAA WEATHER CHANNELS	26
10.7.1	NOAA Weather Alert	26
10.7.2	NOAA Weather Alert Testing	26
10.8	EMERGENCY (CHANNEL 16 USE)	27
10.9	CALLING ANOTHER VESSEL (CHANNEL 16 OR 9)	27
10.10	MAKING TELEPHONE CALLS	28
10.11	OPERATING ON CHANNELS 13 AND 67	28
10.12	DUAL WATCH (TO CH16)	29
10.13	SCANNING	29
10.13.1	Selecting the Scan Type	29
10.13.2	Memory Scanning (M-SCAN)	29
10.13.3	Priority Scanning (P-SCAN)	30
10.14	PA/FOG OPERATION	31
10.14.1	Operating the PA HAIL mode	31
10.14.2	Operating the FOG HORN mode	32
10.15	DISPLAY SOG AND COG INFORMATION	32
10.16	LCD DIMMER	32
10.17	INTERCOM OPERATION	34
10.17.1	Communication	34
10.17.2	Calling	35
10.18	VOICE SCRAMBLER	35
11	DIGITAL SELECTIVE CALLING	36
11.1	GENERAL	36
11.2	MARITIME MOBILE SERVICE IDENTITY (MMSI)	36
11.2.1	What is an MMSI?	36
11.2.2	Programming the MMSI	37
11.3	DSC DISTRESS CALL	38
11.3.1	Transmitting a DSC Distress Call	38
11.3.2	Receiving a DSC Distress Call	40
11.4	ALL SHIPS CALL	40
11.4.1	Transmitting an All Ships Call	41
11.4.2	Receiving an All Ships Call	41

TABLE OF CONTENTS

11.5	INDIVIDUAL CALL	41
11.5.1	Setting up the Individual / Position Call Directory	41
11.5.2	Setting up Individual Reply	43
11.5.3	Setting up Individual / Group Call Ringer	43
11.5.4	Transmitting an Individual Call	44
11.5.5	Receiving an Individual Call	46
11.6	CALL WAITING DIRECTORY	46
11.6.1	Enabling the Call Waiting Feature	46
11.6.2	Reviewing Received Calls Logged into the Call Waiting Directory	47
11.6.3	To Delete the Received Log from the "DSC Log" Directory	47
11.7	GROUP CALL	48
11.7.1	Setup a Group Call	48
11.7.2	Transmitting a Group Call	49
11.7.3	Receiving a Group Call	50
11.8	POSITION REQUEST	51
11.8.1	Setting up Position Reply	51
11.8.2	Transmitting a Position Request to Another Vessel	52
11.8.3	Receiving a Position Request	53
11.9	POSITION SEND	54
11.9.1	Transmitting a DSC Position Send Ringer	54
11.9.2	Transmitting a DSC Position Send Call	54
11.9.3	Receiving a DSC Position Send Call	56
11.10	MANUAL INPUTTING OF THE GPS LOCATION (LAT/LON)	56
12	RADIO SETUP MODE	58
12.1	LCD CONTRAST	58
12.2	TIME OFFSET	59
12.3	TIME DISPLAY	60
12.4	SOG (SPEED OVER GROUND) UNIT	60
12.5	TRUE MAGNETIC CHANGE (NAV DISPLAY)	61
12.6	PRIORITY CHANNEL SET	61
12.7	SCAN TYPE	62
12.8	SCAN RESUME TIME	62
12.9	KEY BEEP	63
12.10	WEATHER ALERT SETUP	63
12.11	CHANNEL NAMING	64
12.12	NAMING THE RADIO OR SECOND STATION MIC OR HANDSET	65
12.13	TREBLE AND BASS AUDIO TONE CONTROL	66
12.14	FOG ALERT TONE FREQUENCY	67
12.15	CALENDAR SETUP	67
13	ENHANCED RAM+ MIC OPERATION	70
13.1	RAM+ MIC CONTROLS	70
13.2	INTERCOM OPERATION	73
13.2.1	Communication	73
13.2.2	Calling	73
13.3	PA/FOG OPERATION	74
13.3.1	Operating the PA / Hailer	74
13.3.2	Operating the FOG Horn	74
13.4	MANUAL INPUTTING OF THE GPS LOCATION (LAT/LON)	75
13.5	DSC / RADIO SETUP MODE	76
13.5.1	Lat/Lon or Time and SOG display	77
14	VH-310 HANDSET OPERATION	78
14.1	VH-310 HANDSET CONTROLS	78
14.2	INTERCOM OPERATION	82
14.2.1	Communication	82
14.2.2	Calling	82
14.3	PA/FOG OPERATION	83
14.3.1	Operating the PA / Hailer	83
14.3.2	Operating the FOG Horn	83
14.4	MANUAL INPUTTING OF THE GPS LOCATION (LAT/LON)	84
14.5	DSC / RADIO SETUP MODE	85
14.5.1	Lat/Lon or Time and SOG display	86
14.5.2	External Speaker AF Selection	86
15	MAINTENANCE	88
15.1	REPLACEMENT PARTS	88
15.2	FACTORY SERVICE	88
15.3	TROUBLESHOOTING CHART	89
16	CHANNEL ASSIGNMENTS	90
17	WARRANTY	96
18	SPECIFICATIONS	99



1 GENERAL INFORMATION

1.1 INTRODUCTION

The STANDARD HORIZON **GX5500S** is a VHF/FM Marine Transceiver designed for use in the frequency range of 156.025 to 163.275 MHz. The **GX5500S** can be operated from 11 to 16 VDC and has a switchable RF output power of 1 watt or 25 watts.

The **GX5500S** is capable of DSC (Digital Selective Calling) Class D operation and two Enhanced second station RAM+ mic (**CMP25** remote-control speaker/microphone with display) and/or **VH-310** Handset. Class D operation allows continuous receiving of Digital Selective Calling functions on channel 70 even if the radio is receiving a call.

The **GX5500S** operates on all currently-allocated marine channels which are switchable for use with USA, International, or Canadian regulations. It has an emergency channel 16 which can be immediately selected from any channel by pressing the red [16/9] key. NOAA Weather channels can also be accessed immediately by pressing the [WX] key with channel selection.

Other features of the **GX5500S** include: 30W PA/Fog, multi-station intercom, scanning, priority scanning, removeable speaker mic, high and low voltage warning, and GPS repeatability.

2 PACKING LIST

When the package containing the transceiver is first opened, please check it for the following contents:

- **GX5500S** Transceiver
- Mounting Bracket and attaching hardware
- Owner's Manual
- Quick-Reference Card
- Power Cord



3 OPTIONS

MMB-84	Flush-Mount Bracket
CMP25B/W	Remote-Access Microphone (RAM+ Mic, Black/White)
VH-310	Remote Handset (available in Black)
CT-100	23-foot Extension Cable for RAM+ Mic
CVS2500	Voice Scrambler
MLS-310	10W amplified External Speaker with on/off volume control
MLS-300	External Loudspeaker
101W	Mini White Extension Speaker
220SW	4.5" Round Hail/PA Horn
240SW	5" x 8" Rectangular Hail/PA Horn
MEK-4	Microphone Extension Kit (to remote front panel mic to rear panel)

4 SAFETY / WARNING INFORMATION

This radio is restricted to occupational use, work related operations only where the radio operator must have the knowledge to control the exposure conditions of its passengers and bystanders by maintaining the minimum separation distance of 0.89 m (2.92 feet). Failure to observe these restrictions will result in exceeding the FCC RF exposure limits.

Antenna Installation:

The antenna must be located at least 0.89 m (2.92 feet) away from passengers in order to comply with the FCC RF exposure requirements.

Lithium Battery Included:

This radio contains a Lithium Battery. At the end of radio's useful life, under various state and laws, it may be illegal to dispose of Lithium Battery into the municipal waste stream. Check with your local solid waste officials for details in your area for recycling options or proper disposal.

ON-LINE WARRANTY REGISTRATION

Please visit www.standardhorizon.com to register the **GX5500S** Marine VHF. It should be noted that visiting the Web site from time to time may be beneficial to you, as new products are released they will appear on the STANDARD HORIZON Web site.

PRODUCT SUPPORT INQUIRIES

If you have any questions or comments regarding the use of the **GX5500S**, you can visit the STANDARD HORIZON Web site to send an E-Mail or contact the Product Support team at 800-767-2450 M-F 7:00-5:00PST.

5 FCC RADIO LICENSE INFORMATION

Standard Horizon radios comply with the Federal Communication Commission (FCC) requirements that regulate the Maritime Radio Service.

5.1 STATION LICENSE

An FCC ship station license is no longer required for any vessel traveling in U.S. waters (except Hawaii) which is under 20 meters in length. However, any vessel required to carry a marine radio on an international voyage, carrying a HF single side band radiotelephone or marine satellite terminal is required to have a ship station license. FCC license forms, including applications for ship (506) and land station licenses can be downloaded via the Internet at www.fcc.gov/forms. To obtain a form from the FCC, call (888) 225-5322.

5.2 RADIO CALL SIGN

Currently the FCC does not require recreational boaters to have a Ship Radio Station License. The USCG recommends the boats registration number and the state to be used.

5.3 CANADIAN SHIP STATION LICENSING

You may need a license when traveling in Canada. If you do need a license contact their nearest field office or regional office or write:

**Industry Canada
Radio Regulatory Branch
Attn: DOSP
300 Slater Street
Ottawa, Ontario
Canada, KIA 0C8**

5.4 FCC / INDUSTRY CANADA INFORMATION

The following data pertaining to the transceiver is necessary to fill out the license application.

Type Acceptance FCC Part 80
Output Power 1 Watt (low) and 25 Watts (high)
Emission 16K0G3E, 16K0G2B
Frequency Range 156.025 to 163.275 MHz
FCC Type Number K6630283X3S
Industry Canada Type Approval 511B-30283X3S



6 FCC NOTICE

NOTICE

Unauthorized changes or modifications to this equipment may void compliance with FCC Rules. Any change or modification must be approved in writing by STANDARD HORIZON.

NOTICE

This equipment has been tested and found to comply with the limits for a Class B digital device, pursuant to Part 15 of the FCC Rules. These limits are designed to provide reasonable protection against harmful interference in a residential installation. This equipment generates, uses and can radiate radio frequency energy and, if not installed and used in accordance with the instructions, may cause harmful interference to radio communications. However, there is no guarantee that interference will not occur in a particular installation. If this equipment does cause harmful interference to radio or television reception, which can be determined by turning the equipment off and on, the user is encouraged to try to correct the interference by one or more of the following measures:

- Reorient or relocate the receiving antenna.
- Increase the separation between the equipment and receiver.
- Connect the equipment into an outlet on a circuit different from that to which the receiver is connected.
- Consult the dealer or an experienced radio/TV technician for help.



7 GETTING STARTED

7.1 ABOUT VHF RADIO

The radio frequencies used in the VHF marine band lie between 156 and 158 MHz with some shore stations available between 161 and 163 MHz. The marine VHF band provides communications over distances that are essentially "line of sight" (VHF signals do not travel well through objects such as buildings, hills or trees). Actual transmission range depends much more on antenna type, gain and height than on the power output of the transmitter. On a fixed mount 25W radio transmission expected distances can be greater than 15 miles, for a portable 5W radio transmission the expected distance can be greater than 5 miles in "line of sight".

7.2 SELECTING AN ANTENNA

Marine antennas are made to radiate signals equally in all horizontal directions, but not straight up. The objective of a marine antenna is to enhance the signal toward the horizon. The degree to which this is accomplished is called the antenna's gain. It is measured in decibels (dB) and is one of the major factors in choosing an antenna. In terms of effective radiated power (ERP), antennas are rated on the basis of how much gain they have over a theoretical antenna with zero gain. A 3 foot, 3dB gain antenna represents twice as much gain over the imaginary antenna.

Typically a 3 foot 3dB gain stainless steel whip is used on a sailboat mast. The longer 8 foot 6dB fiberglass whip is primarily used on power boats that require the additional gain.

7.3 COAXIAL CABLE

VHF antennas are connected to the transceiver by means of a coaxial cable – a shielded transmission line. Coaxial cable is specified by it's diameter and construction.

For runs less than 20 feet, RG-58/U, about 1/4 inch in diameter is a good choice. For runs over 20 feet but less than 50 feet, the larger RG-8X or RG-213/U should be used for cable runs over 50 feet RG-8X should be used. For installation of the connector onto the coaxial cable refer to the figure below.

To get your coax cable through a fitting and into your boat's interior, you may have to cut off the end plug and reattach it later. You can do this if you follow the directions that come with the connector. Be sure to make good soldered connections.

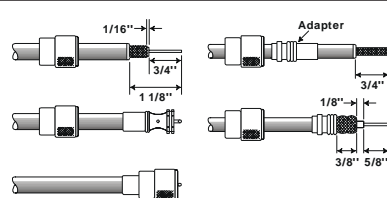

8 INSTALLATION

8.1 LOCATION

The radio can be mounted at any angle. Choose a mounting location that:

- is far enough from any compass to avoid any deviation in compass reading due to the speaker magnet
- provides accessibility to the front panel controls
- allows connection to a power source and an antenna
- has nearby space for installation of a microphone hanger
- the antenna must be mounted at least 3 feet from radio

Note: To insure the radio does not affect the compass or radios performance is not affected by the antenna location, temporarily connect the radio in the desired location and:

- a. Examine the compass to see if the radio causes any deviation
- b. Connect the antenna and key the radio. Check to ensure the radio is operating correctly by requesting a radio check.

8.2 ELECTRICAL CONNECTIONS

CAUTION

Reverse polarity connections will damage the radio!

Connect the power cord and antenna to the radio. Antenna and Power Supply connections are as follows (see Figure 1):

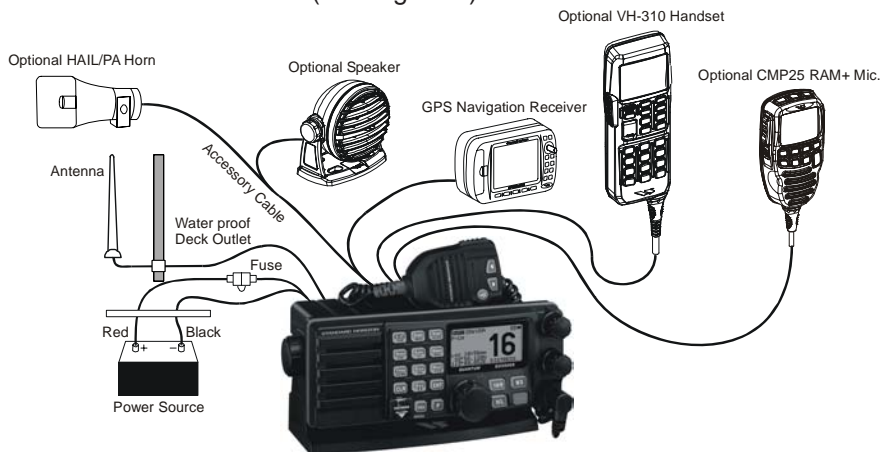

Figure 1. General Installation

1. Mount the antenna at least 3 feet away from the radio. At the rear of the radio, connect the antenna cable. It must have a PL259 connector. RG-8/U coaxial cable must be used if the antenna is 25 feet or more from the radio. RG58 cable can be used for distances less than 25 feet.

2. Connect the red power wire to a 13.8 VDC $\pm 20\%$ power source. Connect the black power wire to a negative ground.
3. If an optional remote extension speaker is to be used, refer to section 3.3 for connections.
4. It is advisable to have a Certified Marine Technician check the power output and the standing wave ratio of the antenna after installation.

8.3 ACCESSORY CABLE

Wire Color/Description	Connection Examples
WHITE - External Speaker (+)	Connect to external 4 Ohm audio speaker
SHIELD - External Speaker (-)	Connect to external 4 Ohm audio speaker
RED - PA Speaker (+)	Connect to external 4 Ohm PA speaker
SHIELD - PA Speaker (-)	Connect to external 4 Ohm PA speaker
GREEN - NMEA Ground	Connect to NMEA (-) connection of GPS
BLUE- NMEA Input (+)	Connect to NMEA (+) output of GPS
GRAY-NMEA Output (+)	Connect to NMEA (+) input of GPS

When connecting the PA speaker, external speaker or GPS navigation receiver, strip off about 1 inch (2.5 cm) of the specified wire's insulation, then splice the ends together.

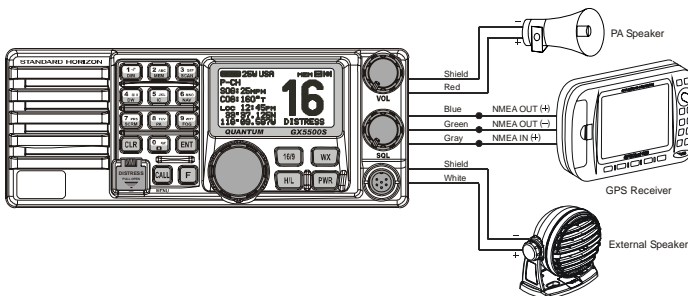

Note: In some areas powerful AM Broadcast stations may be heard when in listen back mode. In this case the speaker wire will have to be changed to 2 conductor Shielded audio cable available from Radio Shack part number 278-514. refer to image below for connections

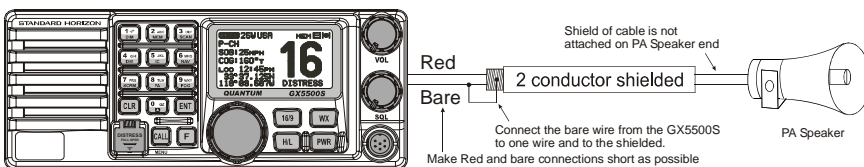

- The GPS must have the NMEA Output turned on and set to 4800 Baud in the setup menu. If there is a selection for parity select none.
- For further information on interfacing /setting up your GPS. Please contact the manufacturer of the GPS receiver.
- **GX5500S** can read NMEA-0183 version 2.0 or higher.
- The NMEA supported sentences are:
Input: GLL, GGA, RMC and GNS (RMC sentence is recommended)
Output: DSC and DSE
(DSC sentences to Standard Horizon Plotter for Position Polling)

If you have further inquires, please feel free to contact Product Support at:

Phone: (800) 767-2450

Email: marinetech@vxstdusa.com



8.4 CHECKING GPS CONNECTIONS

After connections have been made between the **GX5500S** and the GPS, a small satellite icon will appear on the top right corner of the LCD display. To see additional GPS information press and hold the **[H/L(NAV)]** key until the **GX5500S** shows the SOG and COG.

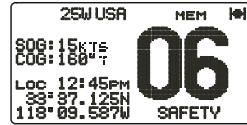

8.5 CHANGING THE GPS TIME

From the Factory the **GX5500S** shows GPS satellite time or UTC time when a optional GPS is connected. A time offset is needed to show the local time in your area.

1. Press and hold down the **[CALL(MENU)]** key until "Radio Setup" menu appears.
2. Press the **[ENT]** key, then select "Time Offset" with the **CHANNEL** selector knob.
3. Press the **[ENT]** key.
4. Turn the **CHANNEL** selector knob to select time offset from UTC. See illustration below to find your offset time from UTC. If "00:00" is assigned, the time is the same as UTC (Universal Time Coordinated or GMT Greenwich Mean Time).
5. Press the **[ENT]** key to store the time offset.
6. Press the **[CLR]** key to return to the "Radio Setup" menu, then press the **[CLR]** key again to return to radio operation.

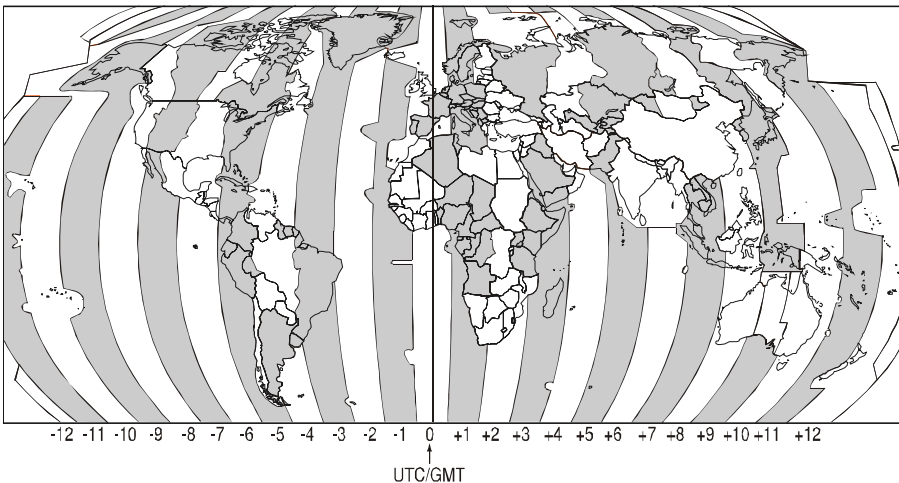
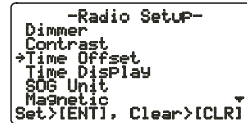

OFFSET TIME TABLE

8.6 CHANGING THE TIME LOCATION

Set the radio show UTC time or local time with the offset inputted in section 8.5 CHANGING THE GPS TIME.

1. Press and hold down the [CALL(MENU)] key until “Radio Setup” menu appears.
2. Press the [ENT] key, then select “Time Display” in the “Radio Setup” menu with the CHANNEL selector knob.
3. Press the [ENT] key.
4. Turn the CHANNEL selector knob to select “UTC” or “Local.”
5. Press the [ENT] key to store the selected setting.
6. Press the [CLR] key to return to the “Radio Setup” menu, then press the [CLR] key again to return to radio operation.

```
-Setup Menu-
->Radio Setup
DSC Setup

Set>[ENT], Clear>[CLR]
```

```
-Radio Setup-
Dimmer
Contrast
Time Offset
->Time Display
SOG Unit
Magnetic
Set>[ENT], Clear>[CLR]
```

```
-Time Display-
->UTC
Local

Set>[ENT], Clear>[CLR]
```

8.7 CHANGING COG TO TRUE OR MAGNETIC

Allows the GPS Course Over Ground to be selected to show in True or Magnetic. Factory default is True however following the steps below the COG can be changed to Magnetic.

1. Press and hold down the [CALL(MENU)] key until “Radio Setup” menu appears.
2. Press the [ENT] key, then select “Magnetic” in the “Radio Setup” menu with the CHANNEL selector knob.
3. Press the [ENT] key.
4. Turn the CHANNEL selector knob to select “Magnetic” or “True.”
5. Press the [ENT] key to store the selected setting.
6. Press the [CLR] key to return to the “Radio Setup” menu, then press the [CLR] key again to return to radio operation.

```
-Setup Menu-
->Radio Setup
DSC Setup

Set>[ENT], Clear>[CLR]
```

```
-Radio Setup-
Dimmer
Contrast
Time Offset
Time Display
SOG Unit
->Magnetic
Set>[ENT], Clear>[CLR]
```

```
-Magnetic-
Magnetic
->True

Set>[ENT], Clear>[CLR]
```

8.8 TREBLE AND BASE AUDIO TONE CONTROL

Allows the treble and bass of the speaker audio to be adjusted for the best acoustics in noisy environments. The effect is similar to adjusting the treble and bass controls on a stereo.

1. Press and hold down the [**CALL(MENU)**] key until “**Radio Setup**” menu appears.
2. Press the [**ENT**] key, then select “**Tone Control**” in the “**Radio Setup**” menu with the **CHANNEL** selector knob.
3. Press the [**ENT**] key, then select “**Bass**” with the **CHANNEL** selector knob.
4. Press the [**ENT**] key, then turn the **CHANNEL** selector knob to select desired audio response in the lower frequency range. Available selections are “-6” through “+6.”
5. Press the [**ENT**] key to store the selected setting.
6. Select “**Treble**” with the **CHANNEL** selector knob.
7. Press the [**ENT**] key, then turn the **CHANNEL** selector knob to select desired audio response in the high frequency range. Available selections are “-6” through “+6.”
8. Press the [**ENT**] key to store the selected setting.
9. Press the [**CLR**] key to return to the “**Radio Setup**” menu, then press the [**CLR**] key again to return to radio operation.

```
-Setup Menu-
+Radio Setup
DSC Setup

Set>[ENT], Clear>[CLR]
```

```
-Radio Setup-
SCAN Resume
Key Beep
Weather Alert
CH Name
Unit Name
+Tone Control
Set>[ENT], Clear>[CLR]
```

```
-Tone Control-
Control Range
Bass
Tone Level
0
Set>[ENT], Clear>[CLR]
```

```
-Tone Control-
Control Range
Bass
Tone Level
-02
Set>[ENT], Clear>[CLR]
```

```
-Tone Control-
Control Range
Treble
Tone Level
0
Set>[ENT], Clear>[CLR]
```

```
-Tone Control-
Control Range
Treble
Tone Level
+02
Set>[ENT], Clear>[CLR]
```

8.9 OPTIONAL MMB-84 FLUSH MOUNT INSTALLATION

1. Make a rectangular template for the flush mount measuring 2.9" H x 8.1" W (72 x 205 mm).
2. Use the template to mark the location where the rectangular hole is to be cut. Confirm the space behind the dash or panel is deep enough to accommodate the transceiver (at least 6 inches deep).
There should be at least 1/2 inch between the transceiver's heatsink and any wiring, cables or structures.
3. Cut out the rectangular hole and insert the transceiver.
4. Fasten the brackets to the sides of the transceiver with the lock washer nut combination; so that the mounting screw base faces the mounting surface (see Figure 2).
5. Turn the adjusting screw to adjust the tension so that the transceiver is tight against the mounting surface.

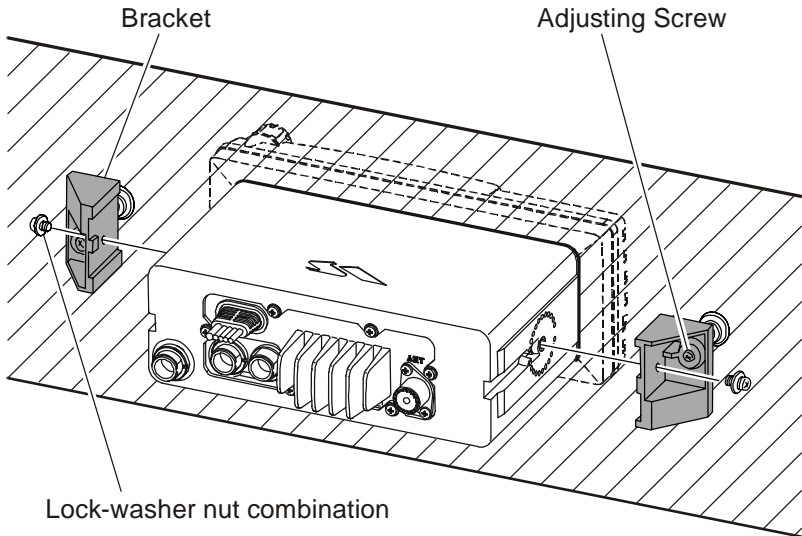

Figure 2. MMB-84 Flush Mount Installation

8.10 OPTIONAL CMP25 ENHANCED RAM+ SECOND STATION MIC OR VH-310 HANDSET INSTALLATION

The **GX5500S** is capable of using a **CMP25** Enhanced RAM+ mic or **VH-310** Handset to remotely control the Radio, DSC and PA/Fog functions. In addition the **GX5500S** can operate as a full function intercom system.

1. Connect the Extension Cable to the Remote Mic eight pin connector on the rear panel, then tighten the Cable Nut (See Figure 3).
2. Referring to Figure 3, make a 1.2" (30 mm) hole in the wall, then insert the Extension Cable into this hole. Connect the Gasket and Mount Base to the Extension Cable Connector using the Nut.
3. Drill the four Screw holes (approx. 2 mm) on the wall, then install the Mounting Base to the wall using four screws.
4. Put the Rubber Cap on to the Nut. The installation is now complete.

NOTE

The routing cable can be cut and spliced, however care needs to be taken when reconnecting the wires to ensure water integrity.

Before cutting the cable make sure it is not plugged into the radio. After cutting you will notice there are the following wires:

Yellow, Green, Brown, Purple, Blue, Green, Red*, Shield*

* The red and shield wires are wrapped in foil. Remove the foil, and separate the Red and shield wires.

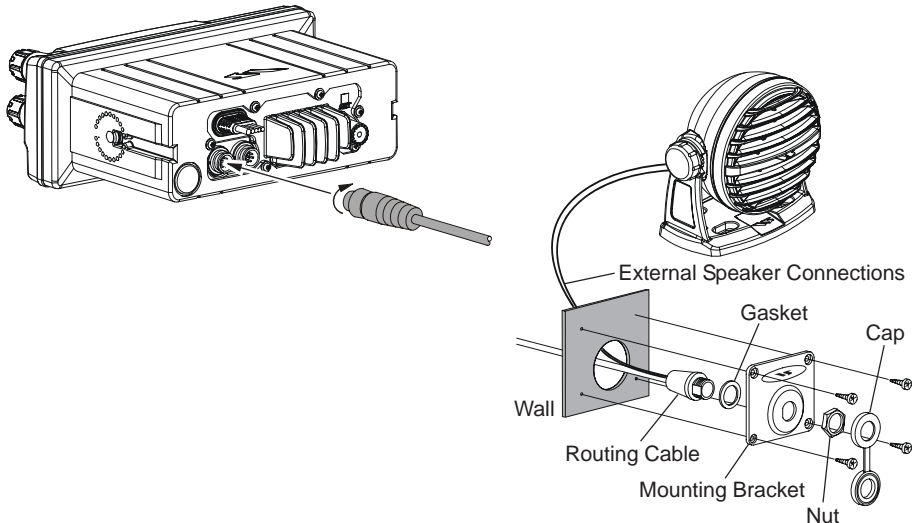

Figure 3. Enhanced RAM+ MIC Installation

Remote Mic or External Speaker Selection

By default the RAM+ or **VH-310** Handset internal speaker is turned on, however using the RAM+ mic (or **VH-310** Handset) this speaker can be turned off so the external speaker can be used.

RAM+ mic procedure

1. Press and hold the [CALL(SET)MENU] key.
2. Press the [▲] or [▼] key to select "RADIO SETUP."
3. Press the [CALL(SET)MENU] key.
4. Press the [▼] key to until "EXT SPK" is shown and press the [CALL(SET)MENU] key.
5. Press the [▲] or [▼] key to select "oF" (External speaker off) or "on" (External speaker on).
6. Press the [CALL(SET)MENU] key to save the selection.
7. Press the [16/9] key to exit this mode.

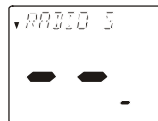

VH-310 Procedure

1. Press and hold the [CALL(MENU)] key.
2. Press the [▲] or [▼] key to select "RADIO SETUP."
3. Press the [ENT] key
4. Press the [▼] key to until "EXT SPK" is shown and press the [ENT] key.
5. Press the [▲] or [▼] key to select "oF" (External speaker off) or "on" (External speaker on).
6. Press the [ENT] key to save the selection.
7. Press the [16/9] key to exit this mode.

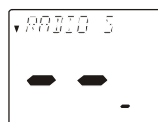

9 CONTROLS AND INDICATORS

NOTE

This section defines each control of the transceiver. See Figure 4 for location of controls. For detailed operating instructions refer to chapter 10 of this manual.

9.1 CONTROLS AND CONNECTIONS

① VOLUME CONTROL (VOL/PWR)

Adjusting this control clockwise, increases the audio volume level.

Secondary Use

When in PA or Fog mode, controls the listen back volume.

② SQUELCH CONTROL (SQL)

Adjusting this control clockwise, sets the point at which random noise on the channel does not activate the audio circuits but a received signal does. This point is called the squelch threshold. Further adjustment of the squelch control will degrade reception of wanted transmissions.

③ MIC Connector

Connects to the supplied noise canceling speaker microphone.

④ KEYPAD

[WX] Key

Press the [WX] key immediately recalls the previously selected NOAA weather channel from any channel. Pressing the [WX] key again reverts to the previous selected working channel.

Secondary use:

Press the [WX] key while pressing and holding the [16/9] key to switch between USA, International and Canadian bands.

[PWR] Key

Turns the transceiver on and off. To turn the transceiver on, press and hold this key until the LCD turns on. To turn it off, press and hold this key until the LCD turns off. When the power is turned on, the transceiver is set to the last selected channel.

[16/9] Key

Press the [16/9] key immediately recalls channel 16 from any channel location. Holding down the [16/9] key recalls channel 9. Pressing the [16/9] key again reverts to the previous selected working channel.

Secondary use:

Press the [WX] key while pressing and holding the [16/9] key to switch between USA, International and Canadian bands.

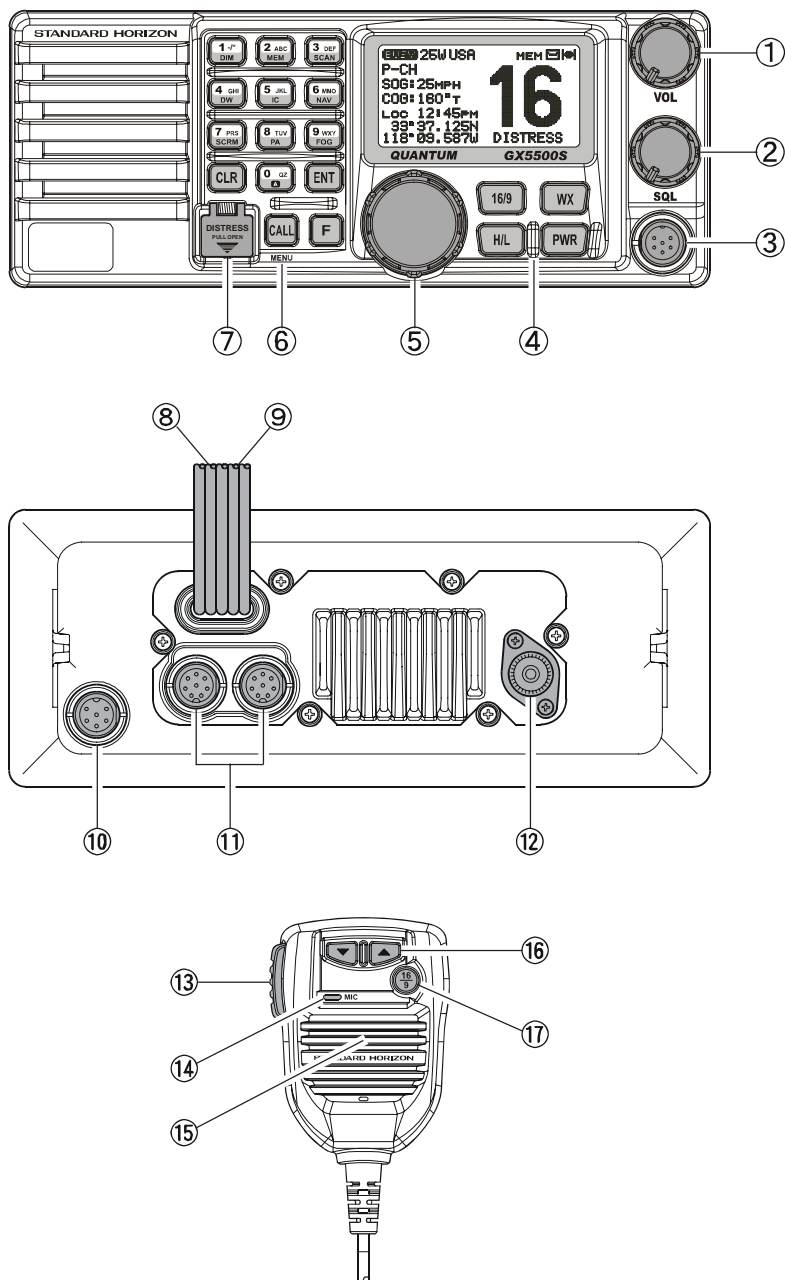

Figure 4. Controls and Connectors

[H/L] Key

Press the [H/L] key to toggles between 25 W (High) and 1 W (Low) power. When the [H/L] key is pressed while the transceiver is on channel 13 or 67, the power will temporarily switch from LO to HI power until the **PTT** is released. The [H/L] key does not function on transmit inhibited and low power only channels.

⑤ CHANNEL SELECTOR KNOB

Rotary knob used to select channels and to choose menu items (such as the DSC menu, Radio Setup and DSC Setup menu). The [UP(▲)] / [DOWN(▼)] keys on the microphone can also be used to select channels and menu items.

Secondary Use

- Press the [F] key first then press the [3(SCAN)] key, and turning the **CHANNEL** selector knob while holding down the [3(SCAN)] key, you can confirm memory channels for scanning.
- Adjusts the PA output level while in PA/FOG mode.

⑥ KEYPAD

[1(DIM)] Key

When in radio mode, this key is used to directly select channel digit “1” in a channel number.

Secondary use

Press the [F] key first then press the [1(DIM)] key, access the LCD Dimmer menu. Refer to section “**10.16 LCD DIMMER**” for details.

[2(MEM)] Key

When in radio mode, this key is used to directly select channel digit “2” in a channel number.

Secondary use

Press the [F] key first then press the [2(MEM)] key, memorize the selected channel into the transceiver scan memory for scanning. When repeat the same procedures ([F] → [2(MEM)]), DELETES the channel from the scan memory. Refer to section “**10.13 SCANNING**” for details.

[3(SCAN)] Key

When in radio mode, this key is used to directly select channel digit “3” in a channel number.

Secondary use (*Depends on the transceiver version*)

Press the [F] key first then press the [3(SCAN)] key, start and stop the scanning of programmed channels. Refer to section “**10.13 SCANNING**” for details.

[4(DW)] Key

When in radio mode, this key is used to directly select channel digit “4” in a channel number.

Secondary use

Press the [F] key first then press the [4(DW)] key, scan for voice communications on the priority channel and another selected channel until a signal is received on either channel (Dual Watch). Refer to section “**10.12 DUAL WATCH (TO PRIORITY CHANNEL)**” for details.

[5(IC)] Key

When in radio mode, this key is used to directly select channel digit “5” in a channel number.

Secondary use

Press the [F] key first then press the [5(IC)] key, when the optional RAM+ Mic is connected, intercom operation will operate between radio and RAM+ Mic. Refer to section “**10.17 INTERCOM OPERATION**” for details.

[6(NAV)] Key

When in radio mode, this key is used to directly select channel digit “6” in a channel number.

Secondary use

Press the [F] key first then press the [6(NAV)] key, the LCD displays NAV GPS Data; Time, SOG (Speed Over Ground), and COG (Course Over Ground) when a GPS is connected to the accessory cable of the **GX3500S**. See section “**8.4 CHECKING GPS CONNECTION**” for details.

[7(SCRM)] Key

When in radio mode, this key is used to directly select channel digit “7” in a channel number.

Secondary use

Press the [F] key first then press the [7(SCRM)] key, when the optional **CVS2500** Voice Scrambler Unit is installed, available to operate the Voice Scrambler function. Refer to section “**10.18 VOICE SCRAMBLER**” for details.

[8(PA)] Key

When in radio mode, this key is used to directly select channel digit “8” in a channel number.

Secondary use

Press the [F] key first then press the [8(PA)] key, available to operate the 30 Watt PA function. Refer to section “**10.14 PA/FOG OPERATION**” for details.

[9(FOG)] Key

When in radio mode, this key is used to directly select channel digit “9” in a channel number.

Secondary use

Press the [F] key first then press the [9(FOG)] key, available to operate the Fog Horn function. Refer to section “10.14 PA/FOG OPERATION” for details.

[0] Key

When in radio mode, this key is used to directly select channel digit “0” in a channel number.

[CLR] Key

Press the [CLR] Key to cancel the menu selection and/or keypad entry.

[ENT] Key

Press the [ENT] Key to determine the menu selection and/or keypad entry.

[CALL(MENU)] Key

Press the [CALL(MENU)] key to access the DSC OPERATION menu. The “INDIVIDUAL CALL,” “GROUP CALL,” and “ALL SHIPS CALL” functions can be accessed from the DSC OPERATION menu.

Secondary use

Press and hold the [CALL(MENU)] key to access the “Radio Setup” (refer to section “12 RADIO SETUP MODE”) or “DSC Setup” menu (refer to section “11 DIGITAL SELECTIVE CALLING”).

RADIO SETUP menu	DSC SETUP menu
Contrast	Individual Directory
Time Offset	Individual Reply
Time Display	Individual Ack
SOG Unit	Individual Ringer
Magnetic	Group Directory
Priority CH	Position Reply
SCAN Type	Position Input*
SCAN Resume	DSC Beep
Key Beep	User MMSI
Weather Alert	*: Only shown when a GPS is not connected.
CH Name	
Unit Name	
Tone Control	
FOG Frequency	
Calendar	

[F] Key

Press the [F] key to activate the “Alternate” key function.

⑦ [DISTRESS] Key

Used to send a DSC Distress Call. To send the distress call refer to section “11.3.1 Transmitting a DSC Distress Call.”

⑧ **ACCESSORY CONNECTION CABLE**

Connects the **GX5500S** to a GPS, a PA speaker, and an external speaker. See section “**3 OPTIONS**” for a list of optional STANDARD HORIZON Speakers.

⑨ **DC INPUT CABLE**

Connects the radio to a DC power supply capable of delivering 12 to 16V DC.

⑩ **FRONT PANEL REMOTE MIC Connector**

Connects the supplied Hand Microphone if desired. This connector is used to remote the Front panel speaker mic using the optional **MEK-4** Microphone Extension Kit. 2 front panel microphones to the front mic jack and the rear panel mic connector at the same time.

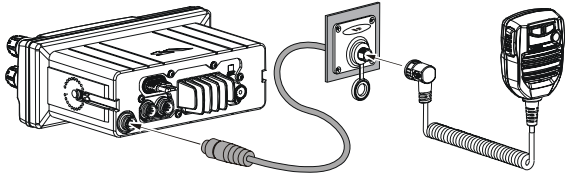

⑪ **RAM+ MIC CONNECTORS**

Connects the **GX5500S** to the enhanced RAM+ MIC (Remote Access Microphone) or the **VH-310** Handset. Refer to section “**13 ENHANCED RAM+ MIC OPERATION**” or “**14 VH-310 HANDSET OPERATION**” for details.

⑫ **ANTENNA JACK**

Connects an antenna to the transceiver. Use a marine VHF antenna with an impedance of 50 ohms.

⑬ **PTT (Push-To-Talk) SWITCH**

Keys the transmitter when the transceiver is in radio mode. If the transceiver is in the intercom operation mode (between the RAM+ and the **GX5500S**), it activates the **GX5500S** microphone for voice communications.

⑭ **MICROPHONE**

Transmits the voice message with reduction of background noise, using Clear Voice Noise Reduction Technology.

⑮ **MICROPHONE SPEAKER**

The same audio heard through internal radio speaker is heard through microphone speaker.

⑯ **[UP(▲)] / [DOWN(▼)] KEYS**

The **[UP(▲)]** and **[DOWN(▼)]** on the microphone function the same as the **CHANNEL** selector knob on the front panel of the transceiver.

⑰ **[16/9] Key**

Pressing the **[16/9]** key immediately recalls channel 16 from any location. Press and hold the **[16/9]** key to recall channel 9. Pressing the **[16/9]** key again will revert the radio to the previous selected channel.

10 BASIC OPERATION

10.1 PROHIBITED COMMUNICATIONS

The FCC prohibits the following communications:

- False distress or emergency messages;
- Messages to “any boat” except in emergencies and radio tests;
- Messages to or from a vessel on land;
- Transmission while on land;
- Obscene, indecent, or profane language (potential fine of \$10,000).

10.2 RECEPTION

1. After the transceiver has been installed, ensure that the power supply and antenna are properly connected.
2. Press and hold the **PWR** key until the radio turns on.
3. Turn the **SQL** knob fully counterclockwise. This state is known as “squelch off”.
4. Turn up the **VOL** knob until noise or audio from the speaker is at a comfortable level.
5. Turn the **SQL** knob clockwise until the random noise disappears. This state is known as the “squelch threshold.”
6. Turn the **CHANNEL** selector knob to select the desired channel. Refer to the channel chart on page 91 for available channels.
7. The keypad on the front may be used to directly select channels. Example to select channel 68:
 1. Press [**6(NAV)**]
 2. Press [**8(PA)**]
 3. Press [**ENT**]In the USA and Canadian modes, press and hold in the [**0**] key to select the “A” channel. Example to select channel 22A:
 1. Press [**2(MEM)**]
 2. Press [**2(MEM)**]
 3. Press [**0**] until “A” appears to the right of the channel number
 4. Press [**ENT**]
8. When a message is received, adjust the volume to the desired listening level. The “**BUSY**” indicator in the LCD is displayed indicating that the channel is being used.



10.3 TRANSMISSION

1. Perform steps 1 through 6 of RECEPTION.
2. Before transmitting, monitor the channel to ensure it is clear.
THIS IS AN FCC REQUIREMENT!
3. Press the **PTT** (push-to-talk) switch. The “” indicator on the LCD is displayed.
4. Speak slowly and clearly into the microphone.
5. When the transmission is finished, release the **PTT** switch.

NOTE

This is a noise-canceling microphone. Position the Oval Slot label “**MIC**” within 1 inch (2.5 cm) from the mouth for optimum performance.

10.4 TRANSMIT TIME - OUT TIMER (TOT)

When the **PTT** switch on the microphone is held down, transmit time is limited to 5 minutes. This limits unintentional transmissions due to a stuck microphone. About 10 seconds before automatic transmitter shutdown, a warning beep will be heard from the speaker(s). The transceiver will automatically go to receive mode, even if the **PTT** switch is continually held down. Before transmitting again, the **PTT** switch must first be released and then pressed again.

10.5 SIMPLEX/DUPLEX CHANNEL USE

Refer to the VHF MARINE CHANNEL CHART (page 91) for instructions on use of simplex and duplex channels.

NOTE

All channels are factory-programmed in accordance with FCC (USA), Industry Canada (Canada), and International regulations. Mode of operation cannot be altered from simplex to duplex or vice-versa.

10.6 USA, CANADA, AND INTERNATIONAL MODE

1. To change the modes, hold the [16/9] key and press the [WX] key. The mode changes from USA to International to Canadian with each press of the [WX] key.
2. “**USA**” will be displayed on the LCD for USA mode, “**INTL**” will be displayed for International mode, and “**CAN**” will be displayed for Canadian mode.
3. Refer to the VHF MARINE CHANNEL CHART (page 91) for allocated channels in each mode.



10.7 NOAA WEATHER CHANNELS

1. To receive a NOAA weather channel, press the [WX] key from any channel. The transceiver will go to the last selected weather channel.
2. Turn the **CHANNEL** selector knob on the radio or [UP(▲)] / [DOWN(▼)] keys on the microphone to select a different NOAA weather channel.
3. To exit from the NOAA weather channels, press the [WX] key. The transceiver returns to the channel it was on prior to a weather channel.

10.7.1 NOAA Weather Alert

In the event of extreme weather disturbances, such as storms and hurricanes, the NOAA (National Oceanic and Atmospheric Administration) sends a weather alert accompanied by a 1050 Hz tone and subsequent weather report on one of the NOAA weather channels. When the Weather Alert feature is enabled (see section “**12.10 WEATHER ALERT (ON/OFF)**”), the transceiver is capable of receiving this alert if the following is performed:

1. Program NOAA weather channels into the transceiver’s memory for scanning. Follow the same procedure as for regular channels under section “**10.13.2 Memory Scanning (M-SCAN).**”
2. Press the [SCAN] key once to start memory scanning.
3. The programmed NOAA weather channels will be scanned along with the regular-programmed channels. However, scanning will not stop on a normal weather broadcast unless a NOAA alert is received.
4. When an alert is received on a NOAA weather channel, scanning will stop and the transceiver will emit a loud beep to alert the user of a NOAA broadcast.
5. Press the [WX] key to stop the alert tone and receive the weather report.

NOTE

If the [WX] key is not pressed the alert tone will be emitted for 5 minutes and then the weather report will be received.

NOTE

The Weather Alert feature is also engaged while the transceiver is receiving on one of the NOAA weather channels.

10.7.2 NOAA Weather Alert Testing

NOAA tests the alert system every Wednesday between 11AM and 1PM. To test the **GX5500S**’s NOAA Weather feature, on Wednesday between 11AM and 1PM, setup as in section “**10.7.1 NOAA Weather Alert**” and confirm the alert is heard.

10.8 EMERGENCY (CHANNEL 16 USE)

Channel 16 is known as the Hail and Distress Channel. An emergency may be defined as a threat to life or property. In such instances, be sure the transceiver is on and set to CHANNEL 16. Then use the following procedure:

1. Press the microphone push-to-talk switch and say "**Mayday, Mayday, Mayday**. This is __ , __ , __ " (your vessel's name).
2. Then repeat once: "**Mayday, __** " (your vessel's name).
3. Now report your position in latitude/longitude, or by giving a true or magnetic bearing (state which) to a well-known landmark such as a navigation aid or geographic feature such as an island or harbor entry.
4. Explain the nature of your distress (sinking, collision, aground, fire, heart attack, life-threatening injury, etc.).
5. State the kind of assistance your desire (pumps, medical aid, etc.).
6. Report the number of persons aboard and condition of any injured.
7. Estimate the present seaworthiness and condition of your vessel.
8. Give your vessel's description: length, design (power or sail), color and other distinguishing marks. The total transmission should not exceed 1 minute.
9. End the message by saying "**OVER**". Release the microphone button and listen.
10. If there is no answer, repeat the above procedure. If there is still no response, try another channel.

10.9 CALLING ANOTHER VESSEL (CHANNEL 16 OR 9)

Channel 16 may be used for initial contact (hailing) with another vessel. However, its most important use is for emergency messages. This channel must be monitored at all times except when actually using another channel. It is monitored by the U.S. and Canadian Coast Guards and by other vessels. **Use of channel 16 for hailing must be limited to initial contact only.** Calling should not exceed 30 seconds, but may be repeated 3 times at 2-minute intervals. In areas of heavy radio traffic, congestion on channel 16 resulting from its use as a hailing channel can be reduced significantly in U.S. waters by using **channel 9** as the initial contact (hailing) channel for non-emergency communications. Here, also, calling time should not exceed 30 seconds but may be repeated 3 times at 2-minute intervals.

Prior to making contact with another vessel, refer to the channel charts in this manual, and select an appropriate channel for communications after initial contact. For example, Channels 68 and 69 of the U.S. VHF Charts are some of the channels available to non-commercial (recreational) boaters. Monitor your desired channel in advance to make sure you will not be interrupting other



traffic, and then go back to either channel 16 or 9 for your initial contact.

When the hailing channel (16 or 9) is clear, state the name of the other vessel you wish to call and then **“this is”** followed by the name of your vessel and your Station License (Call Sign). When the other vessel returns your call, immediately request another channel by saying **“go to,”** the number of the other channel, and **“over.”** Then switch to the new channel. When the new channel is not busy, call the other vessel.

After a transmission, say **“over,”** and release the microphone’s push-to-talk (PTT) switch. When all communication with the other vessel is completed, end the last transmission by stating your Call Sign and the word **“out.”** Note that it is not necessary to state your Call Sign with each transmission, only at the beginning and end of the contact.

Remember to return to Channel 16 when not using another channel. Some radios automatically monitor Channel 16 even when set to other channels or when scanning.

10.10 MAKING TELEPHONE CALLS

To make a radiotelephone call, use a channel designated for this purpose. The fastest way to learn which channels are used for radiotelephone traffic is to ask at a local marina. Channels available for such traffic are designated **Public Correspondence** channels on the channel charts in this manual. Some examples for USA use are Channels 24, 25, 26, 27, 28, 84, 85, 86, and 87. Call the marine operator and identify yourself by your vessel’s name. The marine operator will then ask you how you will pay for the call (telephone credit card, collect, etc.) and then link your radio transmission to the telephone lines.

The marine telephone company managing the VHF channel you are using may charge a link-up fee in addition to the cost of the call.

10.11 OPERATING ON CHANNELS 13 AND 67

Channel 13 is used at docks and bridges and by vessels maneuvering in port. Messages on this channel must concern navigation only, such as meeting and passing in restricted waters.

Channel 67 is used for navigational traffic between vessels.

By regulation, power is normally limited to 1 Watt on these channels. Your radio is programmed to automatically reduce power to this limit on these channels. However, in certain situations it may be necessary to temporarily use a higher power. See page 20 ([H/L] key) for means to temporarily override the low-power limit on these two channels.

10.12 DUAL WATCH (TO CH16)

1. Adjust the **SQL** knob until the background noise disappears.
2. Select the channel you wish to dual watch to CH16.
3. Press the **[F]** key followed by the **[4(DW)]** key. The display will scan between CH16 and the channel that was selected in step 2.

If a transmission is received on the channel selected in step 2, the **GX5500S** will dual watch to CH16.

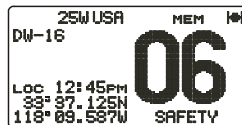

4. To stop Dual Watch press the **[F]** key followed by the **[4(DW)]** key again.

10.13 SCANNING

Allows the user to select the scan type from Memory scan or Priority scan. "Memory scan" scans the channels that were programmed into memory. "Priority scan" scans the channels programmed in memory with the priority channel.

10.13.1 Selecting the Scan Type

1. Press and hold down the **[CALL(MENU)]** key until "Radio Setup" menu appears.
2. Press the **[ENT]** key, then select "SCAN Type" in the "Radio Setup" menu with the **CHANNEL** selector knob.
3. Press the **[ENT]** key.
4. Turn the **CHANNEL** selector knob to select "Priority SCAN" or "Memory SCAN."
5. Press the **[ENT]** key to store the selected setting.
6. Press the **[CLR]** key to return to the "Radio Setup" menu, then press the **[CLR]** key again to return to radio operation.

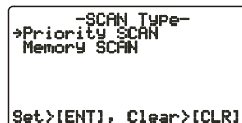
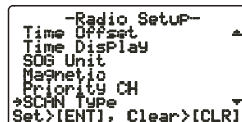

10.13.2 Memory Scanning (M-SCAN)

1. Adjust the **SQL** knob until background noise disappears.
2. Select a desired channel to be scanned using the **CHANNEL** selector knob. Press the **[F]** key followed by the **[2(MEM)]** key, "MEM" appears on the LCD which indicates the channel has been programmed into the transceivers memory.
3. Repeat step 2 for all the desired channels to be scanned.
4. To DELETE a channel from the transceiver's memory, select the channel then press the **[F]** key followed by the **[2(MEM)]** key, "MEM" will disappear from the LCD.

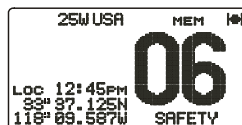

- To start scanning, press the [F] key followed by the [3(SCAN)] key, "M-SCAN" appears on the LCD. Scanning will proceed from the lowest to the highest programmed channel number and will stop on a channel when a transmission is received.

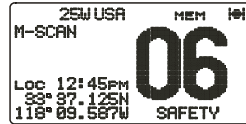

- The channel number will blink during reception.
- To stop scanning, press the [CLR], [16/9], or [WX] key.

10.13.3 Priority Scanning (P-SCAN)

In the default setting, Channel 16 is set as the priority channel. You may change the priority channel to the desired channel from the Channel 16 by the Radio Setup Mode, refer to section "10.13.1 Selecting the Scan Type," and "12.6 PRIORITY CHANNEL SET."

- Adjust the **SQL** knob until background noise disappears.
- Select a desired channel to be scanned using the **CHANNEL** selector knob. Press the [F] key followed by the [2(MEM)] key, "MEM" will appear on the display which indicates the channel has been programmed into the transceivers memory.
- Repeat step 2 for all the desired channels to be scanned.
- To DELETE a channel from the transceiver's memory, select the channel then press the [F] key followed by the [2(MEM)] key, "MEM" is removed from the display.
- To start priority scanning, press the [F] key followed by the [3(SCAN)] key. "P-SCAN" appears on the LCD. Scanning will proceed between the memorized channels and the priority channel. The priority channel will be scanned after each programmed channel.

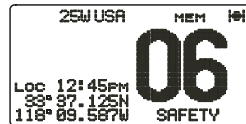

- To stop scanning, press the [CLR], [16/9], or [WX] key.

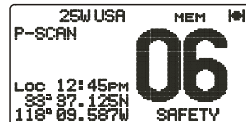

You may change the scan resume time in the Radio Setup Mode, refer to section "12.8 SCAN RESUME TIME."

10.14 PA/FOG OPERATION

The **GX5500S** has a 30W Hailer built-in and can be used with any 4 Ohm PA Horns. Standard Horizon offers a small and a large PA horn called the 220SW and 240SW. When in Hail mode the PA speaker Listen's Back (acts as a microphone and sends sound to the front panel speaker and the speaker mic) through the PA horn speaker which provides two-way communications through the PA horn speaker.

NOTE

When in PA or FOG mode the **GX5500S** will receive on the last selected VHF channel before entering into the PA or FOG mode and receive DSC calls.

NOTE

in some areas powerful AM Broadcast stations may be heard when in listen back mode. In this case the speaker wire will have to be changed to 2 conductor Shielded audio cable available from Radio Shack part number 278-514. refer to section "**8.3 ACCESSORY CABLE.**"

PA HAIL mode:

PA HAIL mode allows the transceiver to be used as a power hailer when an optional STANDARD HORIZON 220SW or 240SW HAIL/PA speaker is installed. The Hail mode has a listen-back feature which provides two way communication through the HAIL/PA speaker.

FOG HORN mode:

Automatic signaling is transmitted through the HAIL/PA speaker. When the Fog horn, Bells or Whistle signal is not being outputted the **GX5500S** listens back through the connected PA Horn speaker.

10.14.1 Operating the PA HAIL mode

1. Press the **[F]** key followed by the **[2(MEM)]** key, activate the PA HAIL mode.
2. Press the **PTT** switch to speak through the HAIL/PA speaker.

Rotate the **CHANNEL** selector knob to control the AF output level. The AF output level can be set from 0 to 30 watts.

3. When the fog signal is not outputted, rotate the **VOL** knob to adjust listen back volume.
4. To exit the PA HAIL mode, press the **[CLR]** key.

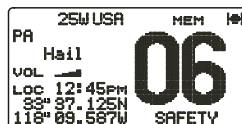
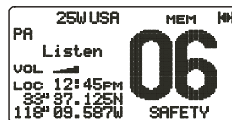

10.14.2 Operating the FOG HORN mode

Operator can select from Underway, Stop, Sail, Tow, Aground, Anchor, Horn and Siren. Refer to the Fog Horn Timing Chart on the next page.

1. Press the [F] key followed by the [9(FOG)] key.
2. Turn the **CHANNEL** selector knob to select the one of the eight functions described above.
3. Press the [ENT] key.
4. On the HORN and SIREN modes, press the **PTT** switch to activate the tone through the HAIL/PA speaker.
Rotate the **CHANNEL** selector knob to control the AF output level. The AF output level can be set from 0 to 30 watts.
6. When the fog signal is not outputted, rotate the **VOL** knob to adjust listen back volume.
7. To exit the FOG HORN mode, press the [CLR] key.

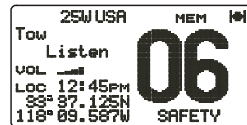
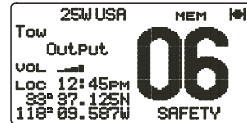

10.15 DISPLAY SOG AND COG INFORMATION

The transceiver has the ability to display the time, SOG and COG date, as well as the vessel's position (LAT/LON), when connected to a GPS receiver.

1. Press the [F] key followed by the [6(NAV)] key to display SOG and COG information.
2. To hide SOG and COG information, press the [F] key followed by the [6(NAV)] key again.

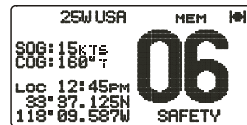

10.16 LCD DIMMER

Allows setting up the backlight intensity or to turn it off.

1. Press the [F] key followed by the [1(DIM)] key to enabling the setting up the backlight intensity.
2. Turn the **CHANNEL** selector knob to select the desired backlight intensity.
3. Press the [CLR] key the mode will revert to "Radio" mode.

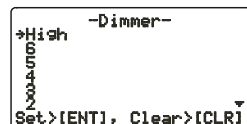

FOG HORN TIMING CHART

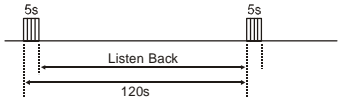
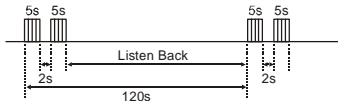
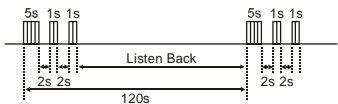
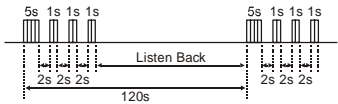
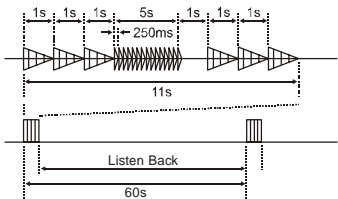
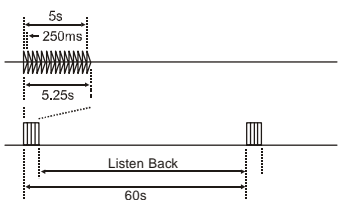
TYPE	PATTERN	USAGE
UNDERWAY	<p>One 5-second blasts every 120 seconds.</p> 	Motor vessel underway and making way.
STOP	<p>Two 5-second blasts (separated by 2 seconds) every 120 seconds.</p> 	Motor vessel underway but stopped (not making way).
SAIL	<p>One 5-second blasts followed by two 1-second blasts (separated by 2 seconds) every 120 seconds.</p> 	Sailing vessel underway, fishing vessel (underway or anchored), vessel not under command, a vessel restricted in her ability to maneuver (underway or at anchor), or a vessel towing or pushing another ahead.
TOW	<p>One 5-second blasts followed by three 1-second blasts (separated by 2 seconds) every 120 seconds.</p> 	Vessel under tow (manned).
AGROUND	<p>One 11-second rings every 60 seconds.</p> 	Vessel is aground.
ANCHOR	<p>One 5-second rings every 60 seconds.</p> 	Vessel is at anchor.

10.17 INTERCOM OPERATION

Connecting a **CMP25 RAM+** or **VH-310 Handset** to the **GX5500S** allows intercom communications. Refer to section “**13.2 INTERCOM OPERATION**” for **CMP25 RAM+** Microphone or section “**14.2 INTERCOM OPERATION**” for **VH-310 Handset**.

10.17.1 Communication

1. Press and hold the **[5(IC)]** key while in the “Radio” mode, the mode is changed to “Intercom” mode.
2. If your **GX5500S** is equipped two RAM+ Mic’s (or **VH-310 Handset**), select the companion you wish to communicate (**RAM1**, **RAM2**, or **ALL**) with the **CHANNEL** selector knob, then press the **[ENT]** key.
3. When the “Intercom” operation is activated, “Intercom” is displayed on the **GX5500S**, and “IC” is displayed on the **CMP25 RAM+** or **VH-310 Handset**.
4. Press the **PTT** switch. “Talk” will be shown on the display.
NOTE: A warning beep will be emitted when the **GX5500S** microphone’s **PTT** switch is pressed while the RAM+ Mic’s **PTT** switch is pressed.
5. Speak slowly and clearly into the microphone, hold the microphone about 1/2 inch away from your mouth.
6. When finished, release the **PTT** (Second Station Mic’s **PTT** switch is pressed) switch.
7. Press the **[CLR]** key the mode will revert to “Radio” mode.

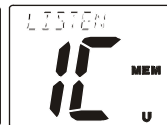
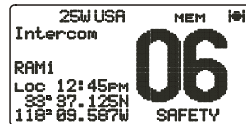

(GX5500S's PTT switch is pressed)

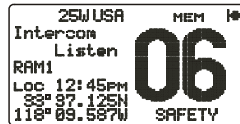

(Second Station Mic's PTT switch is pressed)

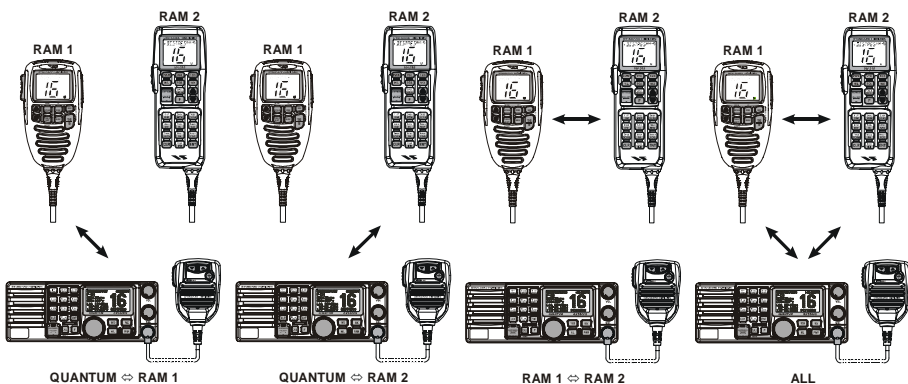

10.17.2 Calling

Hold down the [5(IC)] key when the “Intercom” mode is activated to send a calling beep to the RAM+ or **VH-310** remote mic.

NOTE

When both RAM+ microphones (or **VH-310** Handsets) are set to intercom mode, the **GX5500S** will be temporarily disabled until the remote mics exit the intercom mode.

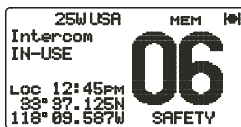

10.18 VOICE SCRAMBLER

If privacy of communications is desired, an optional **CVS2500** 4 code voice scrambler (VS) can be installed in the transceiver. Contact your Dealer to have a **CVS2500** installed.

1. Turn the **CHANNEL** selector knob to select the channel to be scrambled.
Note: Channel 16 and 70 can not operate the voice scrambler.
2. Press the [F] key followed by the [7(SCRM)] key, the voice scrambler is activated. “VS” and scrambler number (“0,” “1,” “2,” or “3”) will appear on the LCD.
3. Press the [F] key, then press and hold down the [7(SCRM)] key until “Scrambler” menu appears.
4. Turn the **CHANNEL** selector knob to change the scrambler code. The scrambler code can be set from “0” to “3.”
5. Press the [ENT] key to save the scrambler code and return to radio operation mode (with voice scrambler).
6. Monitor the channel before transmitting.
7. To disable the voice scrambler, press the [F] key followed by the [7(SCRM)] key again. “VS” and scrambler number (“0,” “1,” “2,” or “3”) disappear from the LCD.

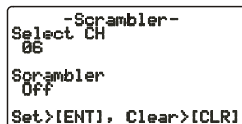
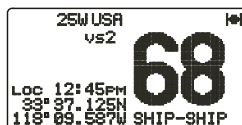

11 DIGITAL SELECTIVE CALLING

11.1 GENERAL

WARNING

This radio is designed to generate a digital maritime distress and safety call to facilitate search and rescue. To be effective as a safety device, this equipment must be used only within communication range of a shore-based VHF marine channel 70 distress and safety watch system. The range of signal may vary but under normal conditions should be approximately 20 nautical miles.

NOTE

A DSC Warning sticker is included with the **GX5500S**. To comply with FCC regulations this sticker must be mounted in a location that can be easily viewed from the location of the **GX5500S**.

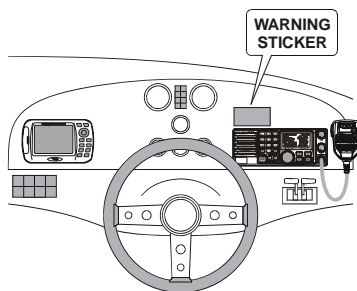

Digital Selective Calling is a semi-automated method of establishing a radio call, it has been designated by the International Maritime Organization (IMO) as an international standard for establishing VHF, MF and HF radio calls. It has also been designated as part of the Global Maritime Distress and Safety System (GMDSS). It is planned that DSC will eventually replace aural watches on distress frequencies and will be used to announce routine and urgent maritime safety information broadcasts.

This new system allows mariners to instantly send a distress call with GPS position (when connected to the transceiver) to the US Coast Guard and other vessels within range of the transmission. DSC will also allow mariners to initiate or receive Distress, Urgency, Safety, Routine, POSITION REQUEST, POSITION SEND, and Group calls to or from another vessel equipped with a DSC transceiver.

11.2 MARITIME MOBILE SERVICE IDENTITY (MMSI)

11.2.1 What is an MMSI?

An MMSI is a nine digit number used on Marine Transceivers capable of using Digital Selective Calling (DSC). This number is used like a telephone number to selectively call other vessels.

THIS NUMBER MUST BE PROGRAMMED INTO THE RADIO TO OPERATE THE GX5500S DSC FUNCTIONS.

How can I obtain an MMSI assignment?

In the USA, visit the following websites to register:

- <http://www.boatus.com/mmsi/> or
- www.seatow.com/boatingsafety/mmsiinfo.htm.

In the Canada, visit

- [http://strategis.ic.gc.ca/epic/site/smt-gst.nsf/vwapj/cpc_2307e.pdf/\\$FILE/cpc_2307e.pdf](http://strategis.ic.gc.ca/epic/site/smt-gst.nsf/vwapj/cpc_2307e.pdf/$FILE/cpc_2307e.pdf)

11.2.2 Programming the MMSI

WARNING

A user MMSI can be inputted only once. Therefore **please be careful not to input the incorrect MMSI number.** If the user needs to change the MMSI number after it has been entered, the radio will have to be returned to Factory Service. Refer to the section “15.2. FACTORY SERVICE.”

1. Press and hold down the [CALL(MENU)] key until the “Radio Setup” menu appears.
2. Turn the CHANNEL selector knob to the left to select “DSC Setup” menu.
3. Press the [ENT] key, then select “User MMSI” with the CHANNEL selector knob.
4. Press the [ENT] key.
5. Turn the CHANNEL selector knob or press the [UP(▲)] / [DOWN(▼)] key on the microphone to select the first number of your MMSI, then press the [ENT] key to step to the next number.
6. Repeat step 5 to set your MMSI (nine digits).
7. When finished programming the number, press and hold the [ENT] key. Appears the confirmation message on the display. Set your MMSI again, then press and hold the [ENT] key.
8. Press the [ENT] key to store the number in memory.
9. Press the [CLR] key twice to return to the “Radio Setup” menu, then press the [CLR] key again to return to radio operation.

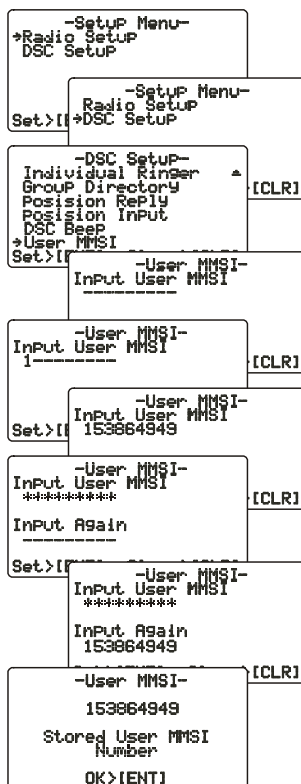

11.3 DSC DISTRESS CALL

The **GX5500S** is capable of transmitting and receiving DSC Distress messages to all DSC radios. The **GX5500S** may be connected to a GPS to also transmit the Latitude, Longitude of the vessel.

11.3.1 Transmitting a DSC Distress Call

NOTE

To be able to transmit a DSC distress call an MMSI number must be programmed, refer to section “**11.2.2 Programming the MMSI.**”

In order for your ships location to be transmitted a GPS must be connected to the **GX5500S**, refer to section “**8.3 ACCESSORY CABLE.**”

1. Lift the red spring loaded DISTRESS cover and press the [DISTRESS] key. The “DISTRESS ALERT” menu will appear on the LCD.
2. Press and hold the [DISTRESS] key. The radios display will count down (5-4-3-2-1) and then transmit the Distress call. The backlight of the LCD and keypad flashes while the radios display is countdown.
3. When the distress signal is sent, CH70 and “ ” icon will appear on the LCD.
4. The transceiver “shadow-watches” for a transmission between CH16 and CH70 until an acknowledgment signal is received. “DISTRESS” and “WAITING” will appear on the LCD.
5. If an acknowledgement is received, select channel 16 and advise your distress situation.
6. If no acknowledgment is received, the distress call is repeated in 4 minute intervals until an acknowledgment is received.
7. When a DSC Distress acknowledgment is received, a distress alarm sounds and channel 16 is automatically selected. The LCD shows the MMSI of the ship responding to your distress.
RECEIVED ACK: acknowledgment signal is received.
RECEIVED RLY: relay signal is received from another vessel or coast station.
8. To cancel the DSC distress alarm signal from the speaker, press any key.

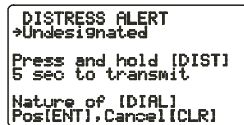

```
DISTRESS ALERT
+Undesignated
Press and hold [DIST]
5 sec to transmit
Nature of [DIAL]
Pos[ENT], Cancel [CLR]
```

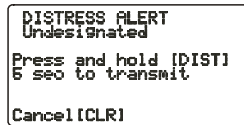

```
DISTRESS ALERT
Undesignated
Press and hold [DIST]
5 sec to transmit
Cancel [CLR]
```



```
25W USA
Transmitting
Distress
Undesignated
70
```

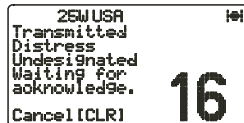

```
25W USA
Transmitted
Distress
Undesignated
Waiting for
acknowledge.
16
Cancel [CLR]
```

Transmitting a DSC Distress Alert with Nature of Distress

The **GX5500S** is capable of transmitting a DSC Distress Alert with the following “Nature of Distress” categories:

Undesignated, Fire, Flooding, Collision, Grounding, Capsizing, Sinking, Adrift, Abandoning, Piracy, MOB

1. Lift the red spring loaded **DISTRESS** cover and press the [**DISTRESS**] key. The “**DISTRESS ALERT**” menu will appear on the LCD.

```
DISTRESS ALERT
+Undesignated
Press and hold [DIST]
5 sec to transmit
Nature of [DIAL]
Pos[ENT],Cancel[CLR]
```

2. Turn the **CHANNEL** selector knob to select the desired nature of distress category.

```
DISTRESS ALERT
+Fire
Press and hold [DIST]
5 sec to transmit
Nature of [DIAL]
Pos[ENT],Cancel[CLR]
```

3. When the **GX5500S** is connected the GPS receiver, to skip to step 4.

When the **GX5500S is not** connected the GPS receiver, you may send the Latitude/Longitude of your vessel manually, if desired.

- a. Press the [**ENT**] key twice. The display will be as shown in the illustration on the right.

```
-Position Input-
UTC: --:--
Lat: --°--'--"____
Lon: --°--'--"____
Set>[ENT], Clear>[CLR]
```

- b. Enter your local time from the keypad by the 24-hour system on the UTC time, then press the [**ENT**] key.

- c. Enter the Latitude/Longitude of your vessel location by the keypad, then press the [**ENT**] key. To select North (N) press [**6(NAV)**] key, South (S) press the [**7(SCRM)**] key, East (E) press the [**3(SCAN)**] key or West (W) press the [**9(FOG)**] key.

- d. To store the data entered, press and hold the [**ENT**] key.

4. Press and hold the [**DISTRESS**] key. The radios display will count down (5-4-3-2-1) and then transmit the Distress call. The backlight of the LCD and keypad flashes while the radios display is countdown.

```
DISTRESS ALERT
Fire
Press and hold [DIST]
5 sec to transmit
Cancel[CLR]
```

5. When the distress signal is sent, CH70 and “” icon will appear on the LCD.

```
25W USA
Transmitting
Distress
Fire
70
```

6. The transceiver will watch for a DSC acknowledgment transmission on CH70 and also receive calls on CH16.

7. When a DSC Distress acknowledgment is received, a distress alarm sounds and channel 16 is automatically selected. The LCD shows the MMSI of the ship responding to your distress.

```
25W USA
Transmitted
Distress
Fire
Waiting for
acknowledge.
Cancel[CLR]
16
```

RECEIVED ACK: acknowledgment signal is received.

RECEIVED RLY ACK: relay acknowledgment signal is received from another vessel or coast station.

8. To cancel the DSC Distress alarm signal from the speaker, press any key.

Cancel a DSC Distress Call

If a DSC Distress call was sent by error the **GX5500S** allows you to send a message to other vessels to cancel the Distress Call that was made in error.

Press the **[CLR]** key, then press the **[ENT]** key.

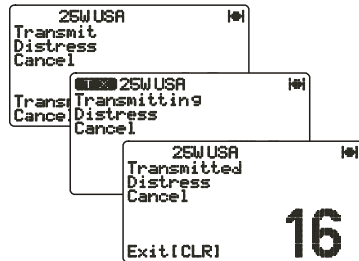

11.3.2 Receiving a DSC Distress Call

1. When a DSC Distress call is received, an emergency alarm sounds.

Then channel 16 is automatically selected.

2. Press any key to stop the alarm.

3. The LCD shows the position of the vessel in distress.

4. If the position of the vessel distress data does not include position, the LCD will show the display on the right.



NOTE

You must continue monitoring channel 16 as a coast station may require assistance in the rescue attempt.

11.4 ALL SHIPS CALL

The All Ships Call function allows contact to be established with other vessel stations without having their ID in the individual calling directory. Also, priority for the call can be designated as Urgency or Safety.

URGENCY Call: This type of call is used when a vessel may not truly be in distress, but have a potential problem that may lead to a distress situation. This call is the same as saying PAN PAN PAN on channel 16.

SAFETY Call: Used to transmit boating safety information to other vessels. This message usually contains information about an overdue boat, debris in the water, loss of a navigation aid or an important meteorological message. This call is the same as saying Securite, Securite, Securite.”

11.4.1 Transmitting an All Ships Call

1. Press the [CALL(MENU)] key. The “DSC Call Menu” will appear.
2. Turn the **CHANNEL** selector knob to select “All Ships.”
3. Press the [ENT] key. (To cancel, turn the **CHANNEL** selector knob to select “Exit.”)
4. Turn the **CHANNEL** selector knob to select the nature of call (“Urgency” or “Safety”), then press the [ENT] key.
5. Press the [ENT] key again to transmit the selected type of all ships DSC call.
6. After the All Ships Call is transmitted, the transceiver will switch to CH16.
7. Listen to the channel to make sure it is not busy, then key the microphone and say PAN PAN PAN or “Securite, Securite, Securite” depending on the priority of the call. Then announce your call sign and announce the channel you wish to switch to for communications.

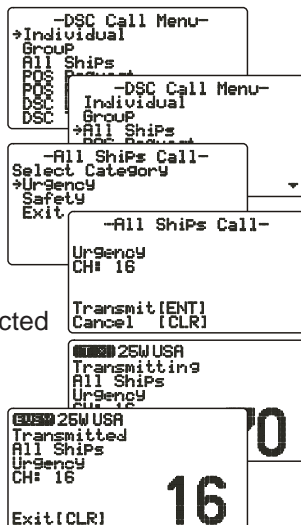

11.4.2 Receiving an All Ships Call

1. When an all ships call is received, an emergency alarm sounds. The radio will automatically change to channel 16. The LCD shows the MMSI of the vessel transmitting the All Ships Call.
2. Press any key to stop the alarm.
3. Monitor channel 16 or traffic channel until the URGENCY voice communication is completed.



11.5 INDIVIDUAL CALL

This feature allows the **GX5500S** to contact another vessel with a DSC VHF radio and automatically switch the receiving radio to a desired communications channel. This feature is similar to calling a vessel on CH16 and requesting to go to another channel (switching to the channel is private between the two stations).

11.5.1 Setting up the Individual / Position Call Directory

The **GX5500S** has a DSC directory that allows you to store a vessel or person’s name and the MMSI number associated with vessels you wish to transmit Individual calls, Position Requests and Position Send transmissions.

To transmit an Individual call you must program this directory with information

of the persons you wish to call, similar to a cellular phones telephone directory.

1. Press and hold down the **[CALL(MENU)]** key until “Radio Setup” menu appears.
2. Turn the **CHANNEL** selector knob to select “DSC Setup” menu.
3. Press the **[ENT]** key, then select “Individual Directory” with the **CHANNEL** selector knob.
4. Press the **[ENT]** key.
5. Select “Add” with the **CHANNEL** selector knob, then press the **[ENT]** key.

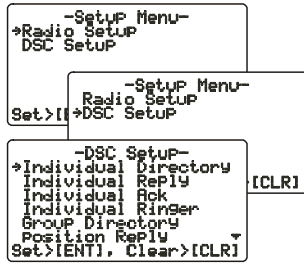

6. Press the one of the Keypad keys to enter the first letter of the name of the vessel or person you want to reference in the directory.

Example: Press the **[2(MEM)]** key repeatedly to toggle among the seven available characters associated with that key: **2** → **A** → **B** → **C** → **a** → **b** → **c** → **2** ...

If a mistake was made entering in the name, pressing the **[CLR]** key to delete the wrong character.

7. Press the **[ENT]** key to store the first letter in the name and step to the next letter to the right.
8. Repeat step 6 and 7 until the name is complete. The name can consist of up to eleven characters, if you do not use all eleven characters press the **[ENT]** key to move to the next space. This method can also be used to enter a blank space in the name. If a mistake was made entering in the name repeat pressing the **[H/L]** key until the wrong character is selected, then enter the correct character.

9. After the eleventh letter or space has been entered, press and hold the **[ENT]** key to advance to the MMSI (Maritime Mobile Service Identity Number) number entry.

10. Enter the desired number by the keypad. If a mistake was made entering in the MMSI number repeat pressing the **[H/L]** key until the wrong number is selected, then enter the correct number.

11. To store the data entered, press and hold the **[ENT]** key.
12. To enter another individual address, repeat steps 5 through 11.

13. Press the **[CLR]** key twice to return to the “Radio Setup” menu, then press the **[CLR]** key again to return to radio operation.

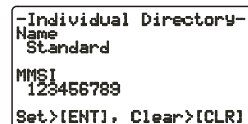
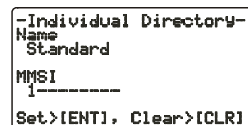
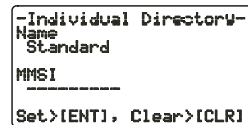
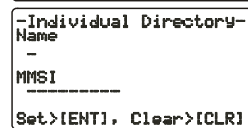
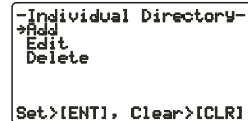

11.5.2 Setting up Individual Reply

Allows setting up the radio to automatically (default setting) or manually respond to a DSC Individual call requesting you to switch to a working channel for voice communications. When Manual is selected the MMSI of the calling vessel is shown allowing you to see who is calling. This function is similar to caller id on a cellular phone.

1. Press and hold down the [CALL(MENU)] key until "Radio Setup" menu appears.
2. Turn the CHANNEL selector knob to select "DSC Setup" menu.
3. Press the [ENT] key, then select "Individual Reply" with the CHANNEL selector knob.
4. Press the [ENT] key.
5. Turn the CHANNEL selector knob to select "Automatic" or "Manual."
6. Press the [ENT] key to store the selected setting.
7. Press the [CLR] key twice to return to the "Radio Setup" menu, then press the [CLR] key again to return to radio operation.

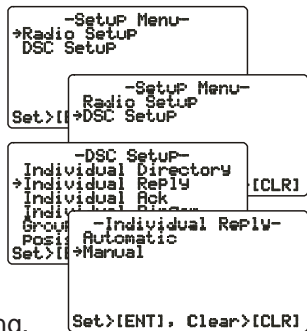

11.5.3 Setting up Individual/Group Call Ringer

When a Individual Call or Group Call is received the radio will produce a ringing tone for 2 minutes. This selection allows the Individual Call ringer time to be changed.

1. Press and hold down the [CALL(MENU)] key until "Radio Setup" menu appears.
2. Turn the CHANNEL selector knob to select "DSC Setup" menu.
3. Press the [ENT] key, then select "Individual Ringer" with the CHANNEL selector knob.
4. Press the [ENT] key.
5. Turn the CHANNEL selector knob to select ringing time of a Individual Call.
6. Press the [ENT] key to store the selected setting.
7. Press the [CLR] key twice to return to the "Radio Setup" menu, then press the [CLR] key again to return to radio operation.

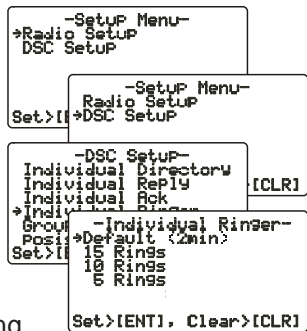

The **GX5500S** has the capability to turn off the Individual call ringer.

1. Press and hold down the **[CALL(MENU)]** key until "Radio Setup" menu appears.
2. Turn the **CHANNEL** selector knob to select "DSC Setup" menu.
3. Press the **[ENT]** key, then select "DSC Beep" with the **CHANNEL** selector knob.
4. Press the **[ENT]** key.
5. Turn the **CHANNEL** selector knob to select "Individual" if you wish to disable the Individual ringer, or "Group" if you wish to disable the Group Call ringer and press the **[ENT]** key.
6. Turn the **CHANNEL** selector knob to select "Off."
7. Press the **[ENT]** key to store the selected setting.
8. Press the **[CLR]** key twice to return to the "Radio Setup" menu, then press the **[CLR]** key again to return to radio operation.

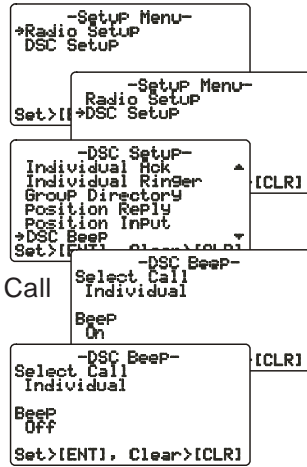

To enable the individual ringer tone, repeat the above procedure, turning the **CHANNEL** selector knob to select "On" in step "6" above.

11.5.4 Transmitting an Individual Call

This feature allows the user to contact another vessel with a DSC radio. This feature is similar to calling a vessel on CH16 and requesting to go to another channel.

Pre-Programmable Calling

1. Press the **[CALL(MENU)]** key. The "DSC Call Menu" will appear.
2. Turn the **CHANNEL** selector knob to select "Individual." (To cancel, press the **[CLR]** key.)
3. Press the **[ENT]** key. The transceiver will beep, and the "Individual directory" will appear.
4. Turn the **CHANNEL** selector knob to select the "Individual" you want to contact.
5. Press the **[ENT]** key, then turn the **CHANNEL** selector knob to select the operating channel you want to communicate on and press the **[ENT]** key.
6. Press the **[ENT]** key again to transmit the individual DSC signal.

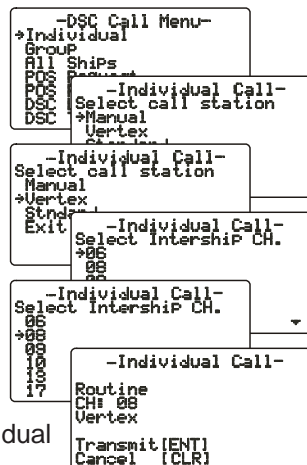

- When an individual call acknowledgment is received, the established channel is automatically changed to the channel which is selected on step 5 above and a ringing tone sounds.
- Press [CLR] key to listen to the channel to make sure it is not busy, then key the microphone and call the other vessel you desire to communicate with.

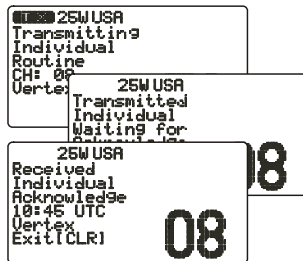

Manual Calling

You may enter an MMSI number manually to contact without storing it in the Individual Directory.

- Press the [CALL(MENU)] key. The “DSC Operation” menu will appear.
- Turn the CHANNEL selector knob to select “Individual.” (To cancel, press the [CLR] key.)
- Press the [ENT] key. The transceiver will beep, and the “Individual directory” will appear.
- Turn the CHANNEL selector knob to select “Manual,” then press the [ENT] key.
- Enter the MMSI number (nine digits) which you want to contact by the keypad, then press the [ENT] key.
- If a mistake was made entering in the MMSI number repeat pressing the [H/L] key until the wrong number is selected, then enter the correct number.
- When finished entering the MMSI number, press and hold the [ENT] key.
- Turn the CHANNEL selector knob to select “Manual,” then press the [ENT] key.
- Turn the CHANNEL selector knob to select the operating channel you want to communicate on and press the [ENT] key.
- Press the [ENT] key again to transmit the individual DSC signal.
- When an individual call acknowledgment is received, the established channel is automatically changed to the channel which is selected on step 5 above and a ringing tone sounds.
- Press the [CLR] key to listen to the channel to make sure it is not busy, then key the microphone and call the other vessel you desire to communicate with.

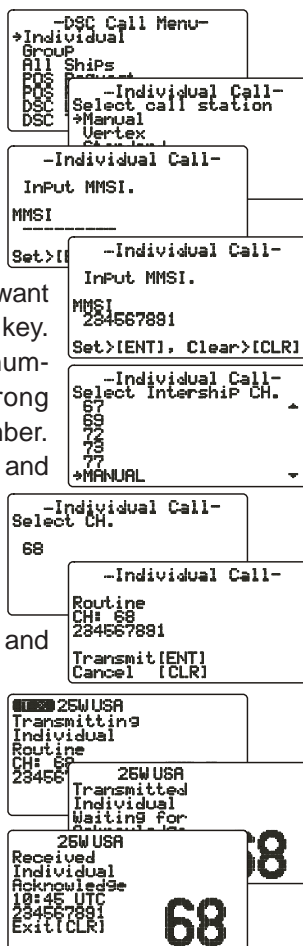

11.5.5 Receiving an Individual Call

When receiving an individual call, an acknowledgment must be sent back to the calling station. The **GX5500S** default setting is Automatic, but has a selection that allows you to manually send a reply before the radio will switch to the requested calling channel. This selection is useful if you want to see who is calling and requesting you to switch to a channel for communications, similar to caller id on a cellular phone.

1. When an individual call is received, an individual call ringing alarm sounds. The radio automatically (automatic mode selected) switches to the requested channel. The LCD shows the MMSI of the vessel calling.
2. Press any key to stop the alarm.
3. Press the **PTT** on the mic and talk to the calling ship.

```
25W USA
Received
Individual
10:45 UTC
Routine
CH:06
799012345
Exit [CLR] 08
```

11.6 CALL WAITING DIRECTORY

The **GX5500S** logs received distress calls and individual calls. The DSC Call Waiting feature is similar to an answer machine where calls are recorded for review. When a call is logged while the radio is set on the DSC Standby function, a "☒" icon will appear on the LCD. The **GX5500S** can memorize up to the latest 30 Distress, and up to the latest 80 Individual Calls.

```
25W USA MEM 06
DW-16
LOC 12:45PM
33° 37.125N
118° 09.587W SAFETY
```

11.6.1 Enabling the Call Waiting Feature

Follow the steps below to enable or disable the Call Waiting feature.

1. Press and hold down the **[CALL(MENU)]** key until "Radio Setup" menu appears.
2. Turn the **CHANNEL** selector knob to select "DSC Setup" menu.
3. Press the **[ENT]** key, then select "Individual Ack" with the **CHANNEL** selector knob.
4. Press the **[ENT]** key.
5. Turn the **CHANNEL** selector knob to select "Able to comply" or "Unable."
6. Press the **[ENT]** key to store the selected setting.
7. Press the **[CLR]** key twice to return to the "Radio Setup" menu, then press the **[CLR]** key again to return to radio operation.

```
-Setup Menu-
+Radio Setup
DSC Setup

-Setup Menu-
Radio Setup
Set>| | +DSC Setup

-DSC Setup-
Individual Directory
Individual Reply
+Individual Ack
Indiv. Ack-
Group
Pos:| | -Individual Ack-
Set>| | Able to comply
Unable

Set>[ENT], Clear>[CLR]
```

11.6.2 Reviewing Received Calls Logged into the Call Waiting Directory

1. Press the [CALL(MENU)] key. The “DSC Call Menu” will appear.
2. Turn the CHANNEL selector knob to select “DSC Log” menu.
3. Press the [ENT] key, then turn the CHANNEL selector knob to select the category (“Distress Alert LOG” or “DSC Call Log”) you want to review and/or call back.
4. Press the [ENT] key, then turn the CHANNEL selector knob to select the station (name or MMSI number) you want to review and/or call back.
5. Press the [ENT] key, to review details for the selected station.
6. Press the [ENT] key again, to call the selected station.

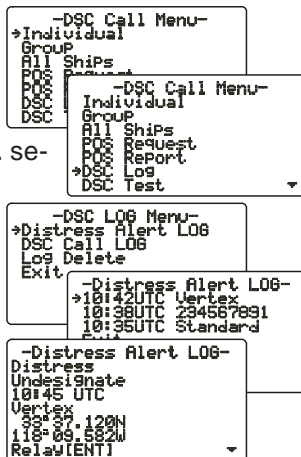

NOTE

When there is an unread received call, the category (“Distress Alert LOG” or “DSC Call Log”) notation will blink.

11.6.3 To Delete the Received Log from the “DSC Log” Directory

1. Press the [CALL(MENU)] key. The “DSC Call Menu” will appear.
2. Turn the CHANNEL selector knob to select “DSC Log” menu.
3. Press the [ENT] key, then turn the CHANNEL selector knob to select “Log Delete.”
4. Press the [ENT] key, then turn the CHANNEL selector knob to select the category (“Distress Alert LOG” or “DSC Call LOG”) to be deleted.
5. Press the [ENT] key, then turn the CHANNEL selector knob to select the station (name or MMSI number) to be deleted.
6. Press and hold the [ENT] key until the station (name or MMSI number) is removed from the display.
7. To exit this menu and return to radio operation mode press the [16/9] key.

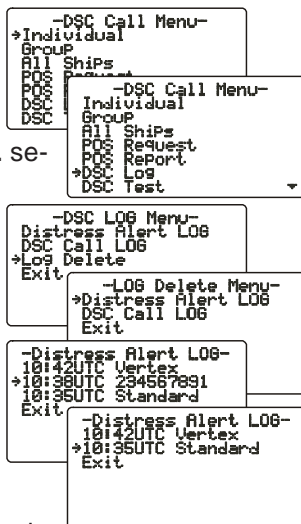

11.7 GROUP CALL

This feature allows the user to contact a group of specific vessels (example members of a yacht club) using DSC radios with Group call function to automatically switch to a desired channel for voice communications.

11.7.1 Setup a Group Call

For this function to operate the same Group MMSI must be programmed into all the DSC VHF radios within the group of vessels that will be using this feature. The group MMSI is a 9 digit (first digit permanently set to "0") that will allow other radios to call your vessel along with others to automatically switch to a working channel for voice communications. This function is very useful for yacht clubs and vessels traveling together that want to collectively make announcements on a predetermined channel.

1. Press and hold down the **[CALL(MENU)]** key until "**Radio Setup**" menu appears.
2. Turn the **CHANNEL** selector knob to select "**DSC Setup**" menu.
3. Press the **[ENT]** key, then select "**Group Directory**" with the **CHANNEL** selector knob.
4. Press the **[ENT]** key, then select "**Add**" with the **CHANNEL** selector knob.
5. Press the **[ENT]** key.

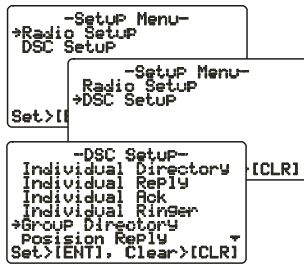

6. Press one of the Keypad keys to enter the first letter of the name of the group you want to reference in the directory.

Example: Press the **[2(MEM)]** key repeatedly to toggle among the seven available characters associated with that key: **2** → **A** → **B** → **C** → **a** → **b** → **c** → **2** ... If a mistake was made entering in the name, pressing the **[CLR]** key to delete the wrong character.

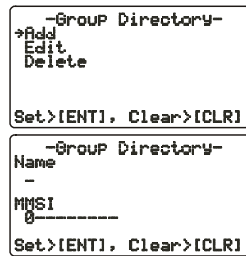

7. Press the **[ENT]** key to store the first letter in the name.
8. Repeat step 6 and 7 until the name is complete. The name can consist of up to eleven characters, if you do not use all eleven characters press the **[ENT]** key to move to the next space. This method can also be used to enter a blank space in the name. If a mistake was made entering in the name repeat pressing the **[H/L]** key until the wrong character is selected, then enter the correct character.
9. After the eleventh letter or space has been entered, press and hold the **[ENT]** key to advance to the GROUP MMSI (Maritime Mobile Service Ident-

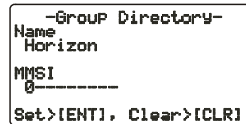

tity Number) number entry.

10. Enter the desired number by the keypad. If a mistake was made entering in the MMSI number repeat pressing the [H/L] key until the wrong number is selected, then enter the correct number.
11. To store the data entered, press and hold the [ENT] key.
12. To enter another group address, repeat steps 4 through 13.
13. Press the [CLR] key twice to return to the "Radio Setup" menu, then press the [CLR] key again to return to radio operation.

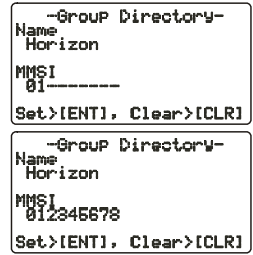

11.7.2 Transmitting a Group Call

Pre-Programmable Calling

1. Press the [CALL(MENU)] key. The "DSC Call Menu" will appear.
2. Turn the CHANNEL selector knob to select "Group." (To cancel, press the [CLR] key.)
3. Press the [ENT] key. The transceiver will beep, and the "Group directory" will appear.
4. Turn the CHANNEL selector knob to select the "Group" you want to contact.
5. Press the [ENT] key, then turn the CHANNEL selector knob to select the operating channel you want to communicate on and press the [ENT] key.
6. Press the [ENT] key again to transmit the Group Call signal.
7. When the Group Call signal is sent, the LCD will be as shown in the illustration at the right.
8. After the GROUP CALL is transmitted, all the radios in the group will switch to the designated channel.
9. Listen to the channel to make sure it is not busy, then key the microphone and call the other vessels you desire to communicate with.

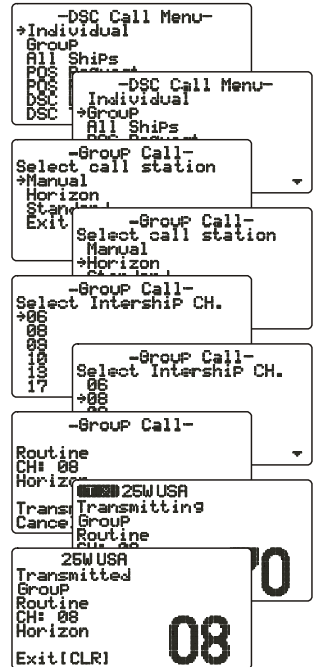

Manual Calling

You may enter a Group MMSI number manually to contact without the Setting up a Group call number.

1. Press the [**CALL(MENU)**] key. The “DSC Call Menu” will appear.
2. Turn the **CHANNEL** selector knob to select “Group.” (To cancel, press the [**CLR**] key.)
3. Press the [**ENT**] key. The transceiver will beep, and the “Group Directory” will appear.
4. Turn the **CHANNEL** selector knob to select “Manual,” then press the [**ENT**] key.
5. Enter the MMSI number (nine digits: first digit permanently set to “0”) which you want to contact by the keypad, then press the [**ENT**] key.
6. If a mistake was made entering in the MMSI number repeat pressing the [**H/L**] key until the wrong number is selected, then enter the correct number.
7. When finished entering the MMSI number, press and hold the [**ENT**] key.
8. Turn the **CHANNEL** selector knob to select “Manual,” then press the [**ENT**] key.
9. Turn the **CHANNEL** selector knob to select the operating channel you want to communicate on and press the [**ENT**] key.
10. Press the [**ENT**] key again to transmit the Group Call signal.
11. After the GROUP CALL is transmitted, all the radios in the group will switch to the designated channel.
12. Listen to the channel to make sure it is not busy, then key the microphone and call the other vessels you desire to communicate with.

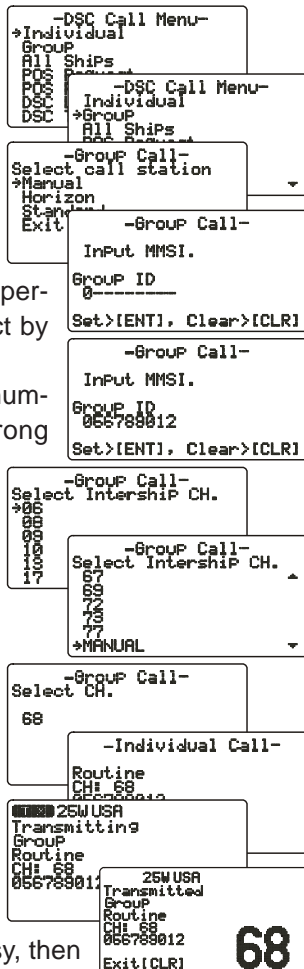

11.7.3 Receiving a Group Call

1. When a group call is received, the **GX5500S** will produce a ringing alarm sound and the radio automatically switches to the requested channel.
2. Press any key to stop the alarm.
3. Monitor the channel for the person calling the Group for a message.

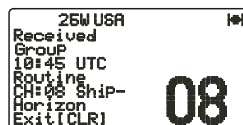

- If you want to respond, monitor the channel to make sure it is clear, then press the **PTT** on the mic and talk to the calling ship(s).

NOTE

After a Group call is received, the time the call was made and the ships MMSI or vessels name will appear on the LCD.

11.8 POSITION REQUEST

Advancements in DSC have made it possible to poll the location of another vessel and show the position of that vessel on the display of the **GX5500S**. Standard Horizon has taken this feature one step further, if any Standard Horizon GPS chart plotters are connected to the **GX5500S**, the polled position of the vessel is shown on the display of the GPS chart plotter making it easy to navigate to the location of the polled vessel. This is a great feature for anyone wanting to know the position of another vessel. For example your buddy that is catching fish, or finding the location of a person you are cruising with.

NOTE

The other vessel must have an operating GPS receiver connected to its DSC transceiver and must not have its transceiver set to deny position requests. (Refer the section “**11.5 INDIVIDUAL CALL**” to enter information into the individual directory).

11.8.1 Setting up Position Reply

The **GX5500S** can be set up to automatically or manually send your position to another vessel. This selection is important if you are concerned about someone polling the position of your vessel that you may not want to. In the manual mode you will see the MMSI or persons name shown on the display allowing you to choose to send your position to the requesting vessel.

- Press and hold down the [**CALL(MENU)**] key until “**Radio Setup**” menu appears.
- Turn the **CHANNEL** selector knob to select “**DSC Setup**” menu.
- Press the [**ENT**] key, then select “**Position Reply**” with the **CHANNEL** selector knob.
- Turn the **CHANNEL** selector knob to select “**Automatic**” or “**Manual.**” In “**Automatic**” mode, after a DSC POS Request is received, the radio will automatically transmit your vessels position. In “**Manual**” mode, the display of the **GX5500S** will show who is requesting the position.

```

-Setup Menu-
→Radio Setup
  DSC Setup

Set>[ENT], Clear>[CLR]

```

```

-Setup Menu-
  Radio Setup
→DSC Setup

Set>[ENT], Clear>[CLR]

```

```

-DSC Setup-
  Individual Directory
  Individual Reply
  Individual Ack
  Individual Ringer
  Group Directory
→Position Reply
Set>[ENT], Clear>[CLR]

```

- Press the [ENT] key to store the selected setting.
- Press the [CLR] key twice to return to the “Radio Setup” menu, then press the [CLR] key again to return to radio operation.

```

-Position Reply-
→Automatic
Manual

Set>[ENT], Clear>[CLR]

```

11.8.2 Transmitting a Position Request to Another Vessel

Pre-Programmable Request

- Press the [CALL(MENU)] key. The “DSC Call Menu” will appear in the display.
- Turn the CHANNEL selector knob to select the “Pos Request.”
- Press [ENT] key to show the “Position Request Directory.” This directory uses the “Individual Directory” information.
- Turn the CHANNEL selector knob to select a name, then press the [ENT] key.
- Press the [ENT] key again to transmit the Position Request DSC call.
- When the **GX5500S** receives the position from the polled vessel it is shown on the radio display and also transferred to the GPS Chart plotter.

```

-DSC Call Menu-
→Individual
Group
All Ships
POS
POS Request
DSC
DSC

-DSC Call Menu-
Individual
Group
→POS Request
POS Report

-POS Request Call-
Select call station
→Manual
Vertex
Standard
Exit

-POS Request Call-
Select call station
Manual
Vertex
→Standard
Exit

-POS Request Call-
Standard

25W USA
Transmitting
POS Request
Cancel
Standard

25W USA
Received
POS Reply
10:45 UTC
Standard
33° 37.120N
118° 09.582W
10:45 UTC

```

NOTE

If the **GX5500S** does not receive position data from the polled vessel, the LCD will show “NO POSITION DATA.”

Manual Request

You may enter an MMSI number manually to contact without Setting up the Individual / Position Call Directory.

- Press the [CALL(MENU)] key. The “DSC Call Menu” menu will appear in the display.
- Turn the CHANNEL selector knob to select “Pos Request.”
- Press [ENT] key to show the Position request directory. This directory uses the INDIVIDUAL Directory information.

```

-DSC Call Menu-
→Individual
Group
All Ships
POS
POS Request
DSC
DSC

-DSC Call Menu-
Individual
Group
→POS Request
POS Report
DSC Log
DSC Test

```

- Turn the **CHANNEL** selector knob to select the “Manual,” then press the [ENT] key.
- Enter the MMSI number (nine digits) which you want to contact by the keypad, then press the [ENT] key.
- If a mistake was made entering in the MMSI number repeat pressing the [H/L] key until the wrong number is selected, then enter the correct number.
- When finished entering the MMSI number, press and hold the [ENT] key.
- Press the [ENT] key to transmit the position request DSC call.
- When the **GX5500S** receives the position from the polled vessel it is shown on the radio display and also transferred to the GPS Chart plotter.

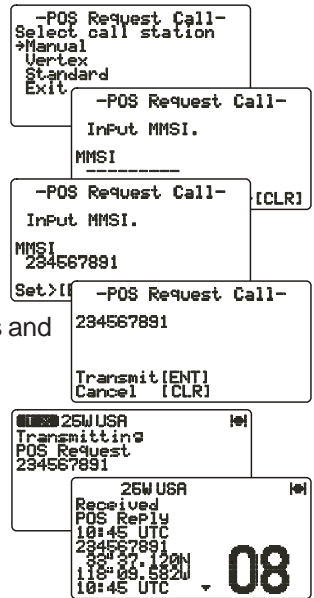

11.8.3 Receiving a Position Request

When a position request call is received from another vessel, a ringing alarm will sound and POS REQUEST will be shown in the LCD. Operation and transceiver function differs depending on “Position Reply” in the “DSC Setup” menu setting.

Automatically reply:

- When a position request call is received, a calling alarm sounds 4 times. Then requested position coordinates are transmitted automatically to the vessel requesting your vessels position.
- To exit from position request display, press the [CLR] key.

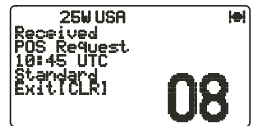

Manually reply:

- When a position request call is received from another vessel, the LCD will show the time and MMSI or name of person requesting your vessel’s position.
- A ringing alarm sounds 4 times. To send your vessels position to the requesting vessel, press the [ENT] key. Or to exit from position request display, press the [CLR] key.

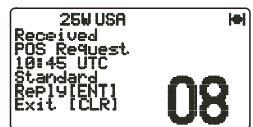

11.9 POSITION SEND

The feature is similar to Position Request, however instead of requesting a position of another vessel this function allows you to send your position to another vessel. Your vessel must have an operating GPS receiver connected for the **GX5500S** to send the position.

NOTE

To transmit a Position Send Call, you must setup the **GX5500S** DSC Individual / Position Call Directory with the name of the vessel(s) or person and the MMSI of the DSC radio you wish to send your position to. To setup this directory refer to section “11.5.1 Setting up the Individual / Position Call Directory.”

11.9.1 Setting up a Position Send Ringer

The **GX5500S** has the capability to turn off the Position Send ringer.

1. Press and hold down the **[CALL(MENU)]** key until “Radio Setup” menu appears.
2. Turn the **CHANNEL** selector knob to select “DSC Setup” menu.
3. Press the **[ENT]** key, then select “DSC Beep” with the **CHANNEL** selector knob.
4. Press the **[ENT]** key, then select “Position Report” with the **CHANNEL** selector knob.
5. Press the **[ENT]** key, then select “Off” with the **CHANNEL** selector knob.
6. Press the **[ENT]** key to store the selected setting.
7. Press the **[CLR]** key twice to return to the “Radio Setup” menu, then press the **[CLR]** key again to return to radio operation.

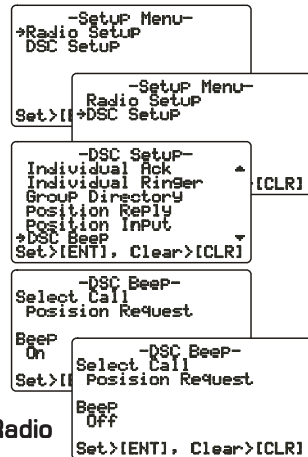

To return to enabling the ringer tone, repeat the above procedure, turning the **CHANNEL** selector knob to select “On” in step “6” above.

11.9.2 Transmitting a DSC Position Send Call

Pre-Programmable Calling

1. Press the **[CALL(MENU)]** key. The “DSC Call Menu” will appear in the display.
2. Turn the **CHANNEL** selector knob to select the “Pos Report.”
3. Press **[ENT]** key to show the “Position Send Direc-

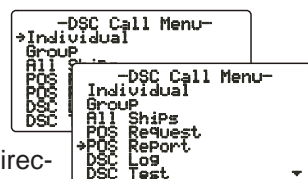

tory.” This directory uses the “Individual Directory” information.

4. Turn the **CHANNEL** selector knob to select a name in the directory, then press the [ENT] key.
5. Press the [ENT] key again to send your position to the selected vessel.
6. Press the [CLR] key twice to return to the “Radio Setup” menu, then press the [CLR] key again to return to radio operation.

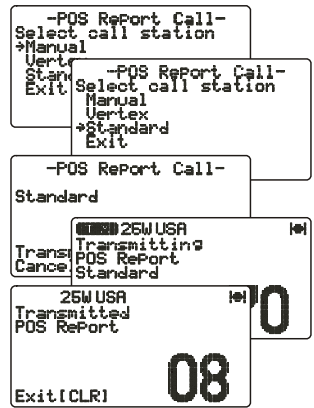

Manual Calling

You may enter an MMSI number manually to contact without the Setting up the Individual / Position Call Directory.

1. Press the [CALL(MENU)] key. The “DSC Call Menu” will appear in the display.
2. Turn the **CHANNEL** selector knob to select the “Pos Report.”
3. Press [ENT] key to show the “Position Send Directory.” This directory uses the “Individual Directory” information.
4. Turn the **CHANNEL** selector knob to select “Manual,” then press the [ENT] key.
5. Enter the MMSI number (nine digits: first digit permanently set to “0”) which you want to contact by the keypad, then press the [ENT] key.
6. If a mistake was made entering in the MMSI number repeat pressing the [H/L] key until the wrong number is selected, then enter the correct number.
7. When finished entering the MMSI number, press and hold the [ENT] key.
8. Press the [ENT] key to send your position to the selected vessel.

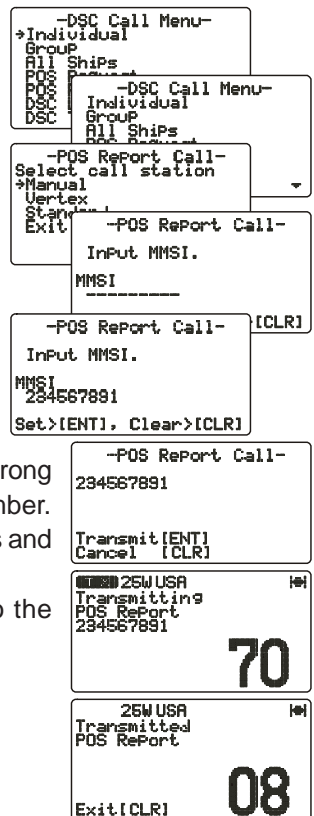

11.9.3 Receiving a DSC Position Send Call

When another vessel transmits their vessels location to the **GX5500S** the following will happen:

1. A ringing sound will be produced when the call is received.
2. Press any key to stop ringing.
3. The position from the vessel sending it's position will be shown on the display of the radio and also transferred to any Standard Horizon GPS Chart plotter if connected.

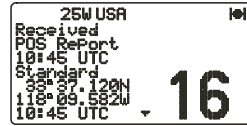

11.10 MANUAL INPUTTING OF THE GPS LOCATION (LAT/LON)

You may send the Latitude/Longitude of your vessel manually when the **GX5500S** is not connected the GPS receiver.

After the position is entered, transmitting a DSC Distress, Position Request, or Position Send will contain the manually entered position.

1. Press and hold down the **[CALL(MENU)]** key until “**Radio Setup**” menu appears.
2. Turn the **CHANNEL** selector knob to select “**DSC Setup**” menu.
3. Press the **[ENT]** key, then select “**Position Input**” with the **CHANNEL** selector knob.
4. Press the **[ENT]** key. The transceiver will beep, and the display will be as shown in the illustration on the right.
5. Enter the your local time from the keypad by the 24-hour system on the UTC time, then press the **[ENT]** key.
6. Enter the Latitude/Longitude of your vessel location by the keypad, then press the **[ENT]** key. To select North (N) press **[6(NAV)]** key, South (S) press the **[7(SCRM)]** key, East (E) press the **[3(SCAN)]** key or West (W) press the **[9(FOG)]** key.
7. To store the data entered, press and hold the **[ENT]** key.
8. Press the **[CLR]** key twice to return to the “**Radio Setup**” menu, then press the **[CLR]** key again to return to radio operation.

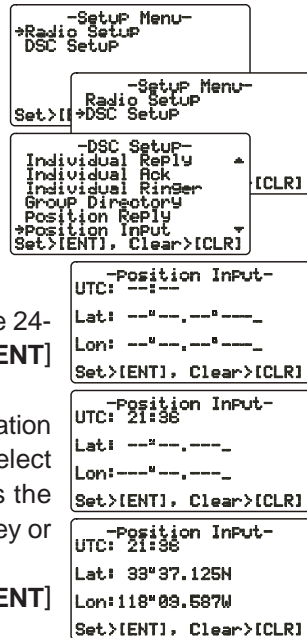

12 RADIO SETUP

NOTE

The optional **CMP25** RAM+ mic and **VH-310** Handset can also change the SETUP menu. Refer to page 75 (**CMP25**) and page 85 (**VH-310**) for details.

12.1 LCD CONTRAST

Due to varying mounting (overhead or below) this selection sets up the display for best viewability.

1. Press and hold down the [**CALL(MENU)**] key until “**Radio Setup**” menu appears.
2. Press the [**ENT**] key, then select “**Contrast**” in the “**Radio Setup**” menu with the **CHANNEL** selector knob.
3. Press the [**ENT**] key.
4. Turn the **CHANNEL** selector knob to select the desired level. The contrast level can be set from “0” to “31.”
5. Press the the [**ENT**] key to store the selected level.
6. To exit this menu and return to radio operation mode press the [**16/9**] key.

```
-Setup Menu-
+Radio Setup
DSC Setup
Set>[ENT], Clear>[CLR]
```

```
-Radio Setup-
+Contrast
Time Offset
Time Display
SOS Unit
Magnetic
Priority CH
Set>[ENT], Clear>[CLR]
```

```
-Contrast-
20
10
00
10
10
10
10
Set>[ENT], Clear>[CLR]
```

12.2 TIME OFFSET

Sets the time offset between local time and UTC shown on the display. Time is displayed when the GPS unit (not supplied) is connected.

1. Press and hold down the [CALL(MENU)] key until "Radio Setup" menu appears.
2. Press the [ENT] key, then select "Time Offset" in the "Radio Setup" menu with the CHANNEL selector knob.
3. Press the [ENT] key.
4. Turn the CHANNEL selector knob to select time offset from UTC. See illustration below to find your offset time from UTC. If "0:00" is assigned, the time is the same as UTC (Universal Time Coordinated or GMT Greenwich Mean Time).
5. Press the [EN] key to store the time offset.
6. To exit this menu and return to radio operation mode press the [16/9] key.

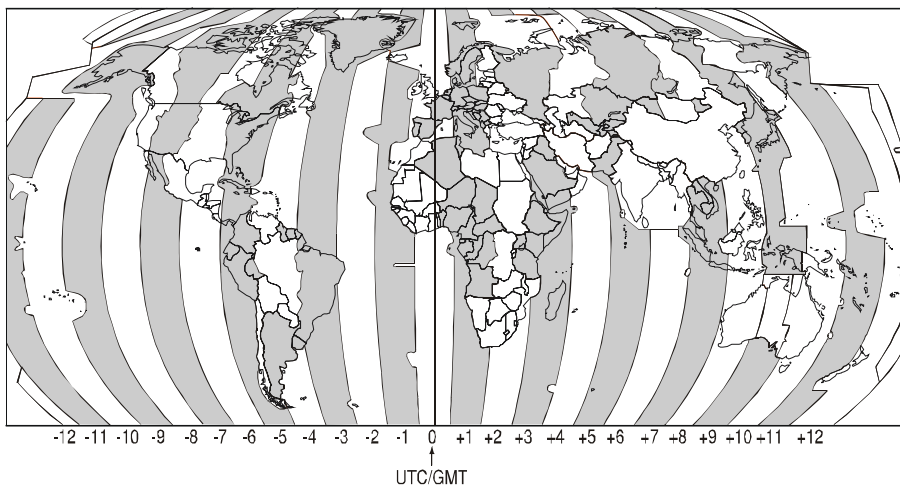
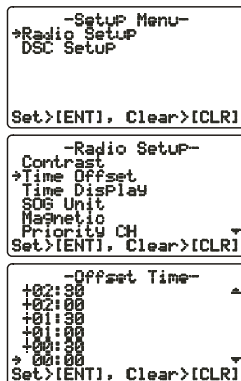

OFFSET TIME TABLE

12.3 TIME DISPLAY

Allows the time shown on the display to be shown in local or UTC time. Time is displayed when the optional GPS unit is connected.

1. Press and hold down the [CALL(MENU)] key until "Radio Setup" menu appears.
2. Press the [ENT] key, then select "Time Display" in the "Radio Setup" menu with the CHANNEL selector knob.
3. Press the [ENT] key.
4. Turn the CHANNEL selector knob to select "UTC" or "Local."
5. Press the [ENT] key to store the selected setting.
6. To exit this menu and return to radio operation mode press the [16/9] key.

```

-Setup Menu-
+Radio Setup
DSC Setup

Set>[ENT], Clear>[CLR]
    
```

```

-Radio Setup-
Contrast
Time Offset
+Time Display
SOG Unit
Magnetic
Priority CH
Set>[ENT], Clear>[CLR]
    
```

```

-Time Display-
+UTC
Local

Set>[ENT], Clear>[CLR]
    
```

In the local time mode, the display shows the time by the 12-hour system, while the display shows the time by the 24-hour system in the UTC mode.

```

25W USA MEM
SOG: 15 kts
COG: 180°r
UTC 18:45
33° 37.125N
118° 09.587W SAFETY
06
    
```

("UTC" mode)

```

25W USA MEM
SOG: 15 kts
COG: 180°r
LOC 10:45AM
33° 37.125N
118° 09.587W SAFETY
06
    
```

("LOCAL" mode)

12.4 SOG (SPEED OVER GROUND) UNIT

Allows the SOG shown on the NAV display to be shown in Knot, MPH or KPH.

1. Press and hold down the [CALL(MENU)] key until "Radio Setup" menu appears.
2. Press the [ENT] key, then select "SOG Unit" in the "Radio Setup" menu with the CHANNEL selector knob.
3. Press the [ENT] key.
4. Turn the CHANNEL selector knob to select desired unit.
5. Press the [ENT] key to store the selected setting.
6. To exit this menu and return to radio operation mode press the [16/9] key.

```

-Setup Menu-
+Radio Setup
DSC Setup

Set>[ENT], Clear>[CLR]
    
```

```

-Radio Setup-
Contrast
Time Offset
Time Display
+SOG Unit
Magnetic
Priority CH
Set>[ENT], Clear>[CLR]
    
```

```

-SOG Unit-
+Kts :Knots
MPH :Mile/hour
Kmh :Kilo-Meter/hour

Set>[ENT], Clear>[CLR]
    
```

12.5 TRUE MAGNETIC CHANGE (NAV DISPLAY)

This selection allows customizing the GPS COG (Course Over Ground) displayed on the LCD to be in True or Magnetic.

1. Press and hold down the [CALL(MENU)] key until "Radio Setup" menu appears.
2. Press the [ENT] key, then select "Magnetic" in the "Radio Setup" menu with the CHANNEL selector knob.
3. Press the [ENT] key.
4. Turn the CHANNEL selector knob to select "Magnetic" or "True."
5. Press the [ENT] key to store the selected setting.
6. To exit this menu and return to radio operation mode press the [16/9] key.

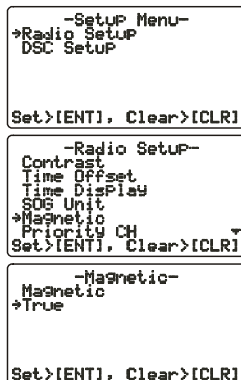

12.6 PRIORITY CHANNEL SET

Allows selection of the priority channel when priority scan is enabled.

1. Press and hold down the [CALL(MENU)] key until "Radio Setup" menu appears.
2. Press the [ENT] key, then select "Priority CH" in the "Radio Setup" menu with the CHANNEL selector knob.
3. Press the [ENT] key.
4. Turn the CHANNEL selector knob to select the channel to be a priority.
5. Press the [ENT] key to store the selected setting.
6. To exit this menu and return to radio operation mode press the [16/9] key.

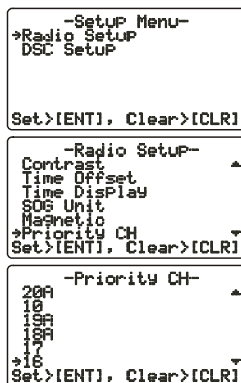

12.7 SCAN TYPE

This selection is used to select the scan mode between “Memory Scan” and “Priority Scan.”

1. Press and hold down the [CALL(MENU)] key until “Radio Setup” menu appears.
2. Press the [ENT] key, then select “SCAN Type” in the “Radio Setup” menu with the CHANNEL selector knob.
3. Press the [ENT] key.
4. Turn the CHANNEL selector knob to select “Priority SCAN” or “Memory SCAN.”
5. Press the [ENT] key to store the selected setting.
6. To exit this menu and return to radio operation mode press the [16/9] key.

```
-Setup Menu-
+Radio Setup
DSC Setup

Set>[ENT], Clear>[CLR]
```

```
-Radio Setup-
Time Offset      ▲
Time Display
SDG Unit
Magnetic
Priority CH
+SCAN Type      ▼
Set>[ENT], Clear>[CLR]
```

```
-SCAN Type-
+Priority SCAN
Memory SCAN

Set>[ENT], Clear>[CLR]
```

12.8 SCAN RESUME TIME

This selection is used to select the time the GX5500S waits after a transmission ends before starting scanning.

1. Press and hold down the [CALL(MENU)] key until “Radio Setup” menu appears.
2. Press the [ENT] key, then select “SCAN Resume” in the “Radio Setup” menu with the CHANNEL selector knob.
3. Press the [ENT] key.
4. Turn the CHANNEL selector knob to select the desired resume time. The resume time can be set to “1sec” through “5sec,” or “Off.” In the “Off” selection, the scanner will resume after the other station stops transmitting (carrier drops).
5. Press the [ENT] key to store the selected setting.
6. To exit this menu and return to radio operation mode press the [16/9] key.

```
-Setup Menu-
+Radio Setup
DSC Setup

Set>[ENT], Clear>[CLR]
```

```
-Radio Setup-
Time Display      ▲
SDG Unit
Magnetic
Priority CH
SCAN Type
+SCAN Resume     ▼
Set>[ENT], Clear>[CLR]
```

```
-SCAN Resume-
Off
1sec
+2sec
3sec
4sec
5sec
Set>[ENT], Clear>[CLR]
```

12.9 KEY BEEP

This selection is used to select the beep tone volume level when a key is pressed.

1. Press and hold down the [CALL(MENU)] key until "Radio Setup" menu appears.
2. Press the [ENT] key, then select "Key Beep" in the "Radio Setup" menu with the CHANNEL selector knob.
3. Press the [ENT] key.
4. Turn the CHANNEL selector knob to select the desired level. The contrast level can be set from "Level 1" to "Level 6," "High," or "Off,"
5. Press the [ENT] key to set the key beep condition.
6. To exit this menu and return to radio operation mode press the [16/9] key.

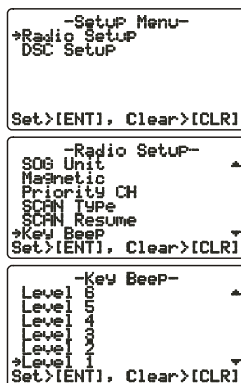

NOTE

Emergency alarm and beeps for DSC operation cannot be turned OFF.

12.10 WEATHER ALERT SETUP

This selection allows the NOAA Weather alert to be turned off. Default setting is "On SCAN and WX CH."

1. Press and hold down the [CALL(MENU)] key until "Radio Setup" menu appears.
2. Press the [ENT] key, then select "Weather Alert" in the "Radio Setup" menu with the CHANNEL selector knob.
3. Press the [ENT] key.
4. Turn the CHANNEL selector knob to select the desired WX alert mode. The WX alert mode can be set to "On WX CH," "On SCAN," "On SCAN and WX CH," or "Off."
5. Press the [ENT] key to store the selected setting.
6. To exit this menu and return to radio operation mode press the [16/9] key.

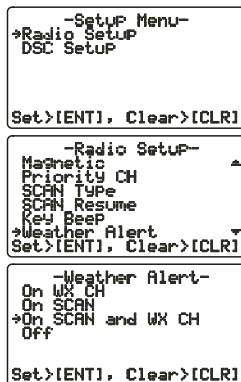

12.11 CHANNEL NAMING

This selection allows you to customize the name of a channel from the default name.

Example: CH69 PLEASURE to HOOKUP

1. Press and hold down the [**CALL(MENU)**] key until “Radio Setup” menu appears.
2. Press the [**ENT**] key, then select “CH Name” in the “Radio Setup” menu with the **CHANNEL** selector knob.

```
-Setup Menu-
+Radio Setup
DSC Setup

Set>[ENT], Clear>[CLR]
```

3. Press the [**ENT**] key.
4. Turn the **CHANNEL** selector knob to select the channel to be named and press the [**ENT**] key.
5. Press the one of the Keypad keys to enter the first letter of channel name.

```
-Radio Setup-
Priority CH      ▲
SCAN TYPE
SCAN Resume
Key Beep
Weather Alert
+CH Name       ▼
Set>[ENT], Clear>[CLR]
```

Example: Press the [4(**GHI**)] key repeatedly to toggle among the seven available characters associated with that key: 4 → G → H → I → g → h → i → 2

```
-CH Name-
Select CH
69
CH Name
PLEASURE
Set>[ENT], Clear>[CLR]
```

6. Press the [**ENT**] key to enter the desired letter and move the cursor one space to the right.

```
-CH Name-
Select CH
69
CH Name
HLEASURE
Set>[ENT], Clear>[CLR]
```

7. Repeat step 5 and 6 until the name is complete. The name can consist of up to 16 characters. If you do not use all 16 characters, press the [**ENT**] key to move to the next space. This method can also be used to enter a blank space in the name. To clear the previous letter, press the [**CLR**] key.

```
-CH Name-
Select CH
69
CH Name
HOOKUPRE
Set>[ENT], Clear>[CLR]
```

8. Press and hold down the [**ENT**] key to enter the name.

```
-CH Name-
Select CH
69
CH Name
HOOKUP
Set>[ENT], Clear>[CLR]
```

9. If you want to enter the name of another channel, repeat steps 3 through 8.
10. To exit this menu and return to radio operation mode press the [**16/9**] key.

12.12 NAMING THE RADIO OR SECOND STATION MIC OR HANDSET

This function allows you to change the name of the RADIO or second station microphone. Example: "RADIO - Cabin," "RAM1 - Flybridge."

1. Press and hold down the **[CALL(MENU)]** key until "Radio Setup" menu appears.
2. Press the **[ENT]** key, then select "Unit Name" in the "Radio Setup" menu with the **CHANNEL** selector knob.
3. Press the **[ENT]** key.
4. With the second station mic or handset connected, turn the **CHANNEL** selector knob to select the Unit ("Radio" or "RAM1") to be named, then press the **[ENT]** key, otherwise press the **[ENT]** key.
5. Press the one of the Keypad keys to enter the first letter of channel name.
Example: Press the **[2(MEM)]** key repeatedly to toggle among the seven available characters associated with that key: **2** → **A** → **B** → **C** → **a** → **b** → **c** → **2**
6. Press the **[ENT]** key to enter the first letter in the name and step to the next letter to the right.
7. Repeat step 5 and 6 until the name is complete. The name can consist of up to 8 characters, if you do not use all 8 characters press the **[ENT]** key to move to the next space. This method can also be used to enter a blank space in the name. To clear the previous letter, press the **[CLR]** key.
8. Press and hold the **[ENT]** key to enter the name and return to the "Unit Name" menu.
9. If you want to enter the name of another unit, repeat steps 4 through 8.
10. To exit this menu and return to radio operation mode press the **[16/9]** key.

```

-Setup Menu-
->Radio Setup
  DSC Setup

Set>[ENT], Clear>[CLR]
  
```

```

- Radio Setup-
SCAN Type
SCAN Resume
Key Beep
Weather Alert
Ch Name
->Unit Name
Set>[ENT], Clear>[CLR]
  
```

```

-Unit Name-
Select Unit
RADIO
Unit Name
RADIO
Set>[ENT], Clear>[CLR]
  
```

```

-Unit Name-
Select Unit
RADIO
Unit Name
CADIO
Set>[ENT], Clear>[CLR]
  
```

```

-Unit Name-
Select Unit
RADIO
Unit Name
Cabin
Set>[ENT], Clear>[CLR]
  
```

12.13 TREBLE AND BASS AUDIO TONE CONTROL

Allows the treble and bass of the speaker audio to be adjusted for best listening in noisy environments. The effect is similar to adjusting the treble and bass controls on a stereo.

1. Press and hold down the [CALL(MENU)] key until "Radio Setup" menu appears.
2. Press the [ENT] key, then select "Tone Control" in the "Radio Setup" menu with the CHANNEL selector knob.
3. Press the [ENT] key, then select "Bass" with the CHANNEL selector knob.
4. Press the [ENT] key, then turn the CHANNEL selector knob to select desired audio response in the lower frequency range. Available selections are "-6" through "+6."
5. Press the [ENT] key to store the selected setting.
6. Select "Treble" with the CHANNEL selector knob, then press the [ENT] key.
7. Turn the CHANNEL selector knob to select desired audio response in the higher frequency range. Available selections are "-6" through "+6."
8. Press the [ENT] key to store the selected setting.
9. To exit this menu and return to radio operation mode press the [16/9] key.

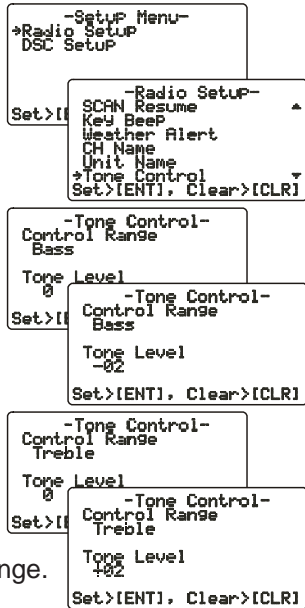

12.14 FOG ALERT TONE FREQUENCY

This selection allows you to select the Tone Frequency for the PA/FOG Operation. Available selections are "200Hz" through "850Hz" in 50Hz steps. The default Tone Frequency is 400Hz.

1. Press and hold down the [CALL(MENU)] key until "Radio Setup" menu appears.
2. Press the [ENT] key, then select "FOG Frequency" in the "Radio Setup" menu with the CHANNEL selector knob.
3. Press the [ENT] key.
4. Turn the CHANNEL selector knob to select desired tone frequency.
5. Press the [ENT] key to store the selected setting.
6. To exit this menu and return to radio operation mode press the [16/9] key.

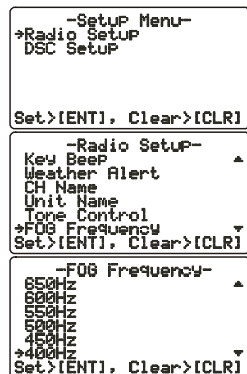

12.15 CALENDAR SETUP

Calendar Menu

The **GX5500S** has a built in clock to remember date, time, latitude and longitude. Connecting a GPS to the **GX5500S** is very important as it not only will be used to update the calendar automatically and also when a DSC Distress call is transmitted will send your vessels location to other vessels to aid in the rescue. Refer to section “**8.3 ACCESSORY CONNECTIONS.**”

GPS Connected

When a GPS is connected, the **GX5500S** will automatically store the calendar date and time information after being connected for 1 hour.

GPS Not Connected

If a GPS is not connected to the **GX5500S**, the date and time has to be manually entered into the Calendar Menu in order for the clock to operate. The time you will enter will be your local time in UTC format. To calculate your local UTC time:

- a. Find you location on the Standard Time chart below.

NOTE

The chart below is show in Standard Time. For Daylight Savings subtract one hour from your offset.

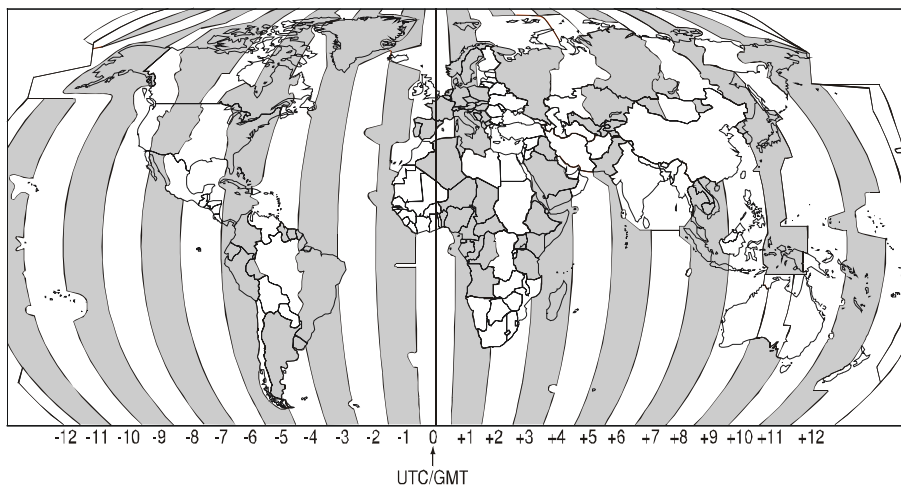

Examples:

NOTE

If you are west of UTC time you will add the offset to your time.
 If you are East of UTC time you will subtract the offset from your time.

City	Los Angeles
Offset	-8
Time (convert local time to 24 hour)	4:00PM (local) or 16:00 (24hour)
Calculate 24hour local + Offset (East of UTC)	16:00 + 08:00 = 22:00
City	NY
Offset	-5
Time (convert local time to 24 hour)	4:00PM (local) or 16:00 (24hour)
Calculate 24hour local + Offset (East of UTC)	16:00 + 05:00 = 21:00
City	Rome
Offset	+1
Time (convert local time to 24 hour)	4:00PM (local) or 16:00 (24hour)
Calculate 24hour local + Offset (East of UTC)	16:00 - 01:00 = 15:00

1. Press and hold the **[CALL(MENU)]** key until “Radio Setup” menu is shown.
2. Press the **[ENT]** key
3. Select “Calendar” with the **CHANNEL** selector knob.
4. Press the **[ENT]** key
5. Select “Date (20YY/MM/DD)” with the **CHANNEL** selector knob.
6. Press the **[ENT]** key.
7. Enter the current date (Yr/Mo/day) from the keypad.
8. If a mistake was made entering repeat pressing the **[H/L]** key until the wrong number is selected, then enter the correct number.
9. Using the Standard time table above, calculate the UTC time of your position.
Note: For daylight savings time subtract one hour to the offset in your time zone.
9. To enter the time, press the **[ENT]** key until the first digit in the “Time (hh/mm [UTC])” is selected on the display, then enter the time from the keypad.
10. Press and hold down the **[ENT]** key to store the selected setting.
11. Select “Update” with the **CHANNEL** selector knob, then press the **[ENT]** key.

```

-Setup Menu-
+Radio Setup
DSC Setup

Set>[ENT], Clear>[CLR]
    
```

```

-Calendar-
+Calendar
Update

Set>[ENT], Clear>[CLR]
    
```

```

-Date-
Date<20YY/MM/DD>
20--/--/--

Time<hh/mm[UTC]>
--:--

Set>[ENT], Clear>[CLR]
    
```

```

-Date-
Date<20YY/MM/DD>
2007/04/01

Time<hh/mm[UTC]>
--:--

Set>[ENT], Clear>[CLR]
    
```

```

-Date-
Date<20YY/MM/DD>
2007/04/01

Time<hh/mm[UTC]>
18:00

Set>[ENT], Clear>[CLR]
    
```

```

-Calendar-
+Calendar
+Update

Set>[ENT], Clear>[CLR]
    
```

12. Turn the **CHANNEL** selector knob to select the method of the time adjustment between “**Automatic**” and “**Manual**.”
13. Press the **[ENT]** key to store the selected setting.
14. To exit this menu and return to radio operation mode press the **[16/9]** key.

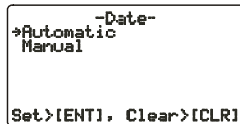

13 ENHANCED RAM+ MIC OPERATION

When the RAM+ microphone is connected to the **GX5500S**, most VHF, DSC, setup menus and PA modes can be remotely operated. The RAM+ Mic supplied with 23 feet (7 m) of routing cable and can be extended up to 70 feet (21 m) using three 23 feet extension cables model **CT-100**. The intercom operation can be used between the RAM+ Mic and the transceiver. In addition, speaker wires are supplied at the panel mount of the routing cable allowing the **STANDARD HORIZON MLS-300** or **MLS-310** External speakers to be connected in noisy environments.

13.1 RAM+ MIC CONTROLS

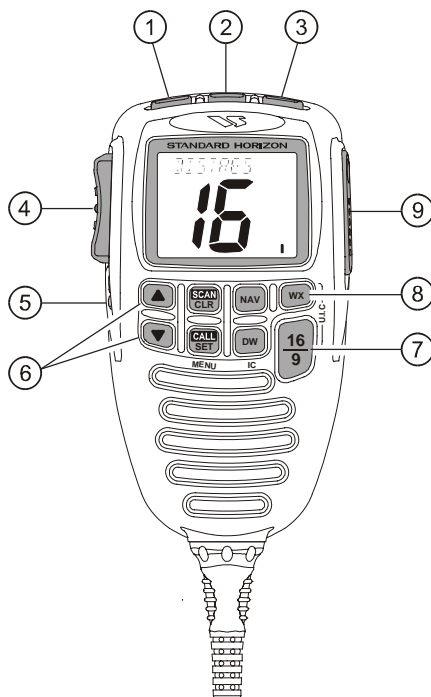

① SQUELCH CONTROL (SQL)

Press this key to activate the squelch adjusting mode. Press the microphone's [▲] or [▼] key to adjust the squelch.

② VOLUME KEY (VOL)

Press this key to activate the volume adjusting mode. Press the microphone's [▲] or [▼] to adjust the volume.

③ **POWER SWITCH (PWR)**

Press and hold down this key to turn to the transceiver and RAM+ Mic on or off.

④ **PTT (Push-To-Talk) SWITCH**

Activates transmission.

⑤ **[H/L] KEY**

Toggles between high and low power. When the [H/L] key is pressed while the transceiver is on channel 13 or 67, the power will temporarily switch from LO to HI power until the **PTT** is released. The [H/L] key does not function on transmit inhibited and low power only channels.

⑥ **[▲](UP)/[▼](DOWN) KEY**

These keys are used to select channels, adjust the volume and squelch level, and to choose the item selection of different functions (such as the DSC operation). In many ways, these keys emulate the function of the transceiver's **CHANNEL** selector knob.

⑦ **[16/9] KEY**

Immediately recalls channel 16 from any channel location. Holding down this key recalls channel 9. Pressing the [16/9] key reverts to the previous selected working channel.

Secondary use

Please see secondary use for the [WX] and [MEM] key.

⑧ **KEY PAD**

[SCAN(CLR)] Key

1. Starts and stops scanning of programmed channels.
2. If held while the [UP(▲)] or [DOWN(▼)] key on the microphone are pressed, the radio will show the channels programmed in scan memory. This function will not work if the unit is scanning.

NOTE: The priority channel is channel 16 only.

[CALL(SET)MENU] Key

The [CALL(SET)MENU] key functions as the enter key.

Secondary use

Press the [CALL(SET)MENU] key to access the DSC OPERATION menu.

Press and hold the [CALL(SET)MENU] key to access the SETUP menu.

[DW(IC)] Key

Watches for a transmission on CH16 and another selected channel until either signal is received. (Dual watch)

Secondary use

Press and hold [DW(IC)] key, intercom operation will operate between radio and RAM Mic.

[NAV] Key

Press this key, when connected to the GPS receiver to show GPS position data (Lat/Lon) and Time on the display of the RAM+.

Secondary use

Press and hold [NAV] key to access PA/FOG function menu.

NOTE

When in PA or FOG mode the **GX5500S** will receive on the last selected VHF channel before entering into the PA or FOG mode and receive DSC calls.

[WX] Key

Immediately recalls the previously selected NOAA weather channel from any channel location.

Secondary use

Holding down the [16/9] key while pressing the [WX] key changes the mode from USA to International or Canadian.

⑨ [DISTRESS] KEY

Used to send a DSC Distress Call. To send the distress call:

1. Lift the red rubber cover.
2. Press and hold the Red button. The RAM+ display will count down (5-4-3-2-1) and then transmit the Distress call.
3. When the distress signal is sent, CH70 and "TX" icon will appear on the LCD. After the message has been sent, the radio will sound a Distress Alarm.
4. The transceiver "shadow-watches" for a transmission on CH16 or CH70 until an acknowledgment signal is received. "DISTRESS" and "WAITING" will appear on the LCD.
5. When a DSC Distress acknowledgment is received, a distress alarm sounds and channel 16 is automatically selected. The LCD shows the MMSI of the ship responding to your distress.



RECEIVED ACK: acknowledgment signal is received.

RECEIVED RLY: relay signal is received from another vessel or coast station.

6. To cancel the DSC distress alarm signal from the speaker, press any key.

13.2 INTERCOM OPERATION

13.2.1 Communication

1. Press and hold the [DW(IC)] key while in the "RADIO" mode, the mode is changed to "INTERCOM" mode.
2. If your **GX5500S** is equipped with two RAM+ Mics (or **VH-310** Handsets), select the station you wish to communicate (RADIO, RAM, or ALL) with the [▼]/[▲] key, then press the [ENT] key.



3. When the "INTERCOM" operation is activated, "IC" is displayed on the RAM+ Mic and "INTERCOM" is displayed on the **GX5500S**.

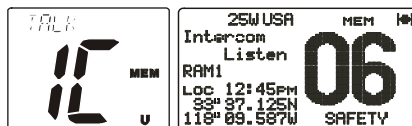

(RAM+ Mic's PTT switch is pressed)

4. Press the PTT switch, "TALK" is displayed.

NOTE: A warning beep is emitted when the RAM+ Mic PTT switch is pressed while the transceiver microphone's PTT switch is pressed.

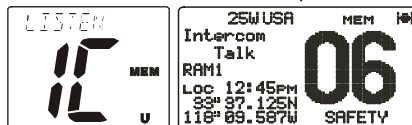

(GX5500S's PTT switch is pressed)

5. Speak slowly and clearly into the microphone, hold the microphone about 1/2 inch away from your mouth.
6. When finished, release the PTT switch.
7. Press the [DW(IC)] key again the mode will revert to "RADIO" mode.

13.2.2 Calling

Press and hold the [DW(IC)] key for one second when the "INTERCOM" is activated, a calling beep is emitted from the **GX5500S** speaker.

13.3 PA/FOG OPERATION

When the RAM+ is connected to the **GX5500S** it is capable of controlling the 30W Public address, 4 fog horns, bells, and whistles.

NOTE

When in PA or FOG mode the **GX5500S** will receive on the last selected VHF channel before entering into the PA or FOG mode and receive DSC calls.

13.3.1 Operating the PA / Hailer

1. Press and hold the **[NAV]** key then select PA with the **[▲]** or **[▼]** key.
2. Press the **[CALL(SET)MENU]** key.
3. Press the **PTT** switch and speak into the microphone.
4. To turn up the PA Volume, press the **PTT** switch and press the **[▲]** or **[▼]** keys to adjust the Audio output level. The level can be set from 0 to 30W.
5. To adjust the listen back volume, (while in listenback mode) press the **[VOL]** Key, then press the **[▲]** or **[▼]** key to the desired listen back volume.



To exit from the PA Hailer mode, press the **[CALL(SET)MENU]**, **[16/9]**, or **[WX]** key.

13.3.2 Operating the FOG Horn

The **GX5500S** is capable of sending 4 pre-programmed fog signals and also Horn, Siren, Aground and Anchor signals.

UNDERWAY: POWER BOAT UNDERWAY

STOPPED: POWER BOAT STOPPED

SAIL: SAIL BOAT, FISH VESSEL, TOW VESSEL

TOW: VESSEL UNDER TOW

1. Press and hold the **[NAV]** key then select FOG with the **[▲]** or **[▼]** key.
2. Press the **[CALL(SET)MENU]** key.
3. Select the one of the eight functions described above with the **[▲]** or **[▼]** key and press the **[CALL(SET)MENU]** key.
4. On the "Horn" and "Siren" modes, press the **PTT** switch to activate the tone through the HAIL/PA speaker. Press the **[▲]** or **[▼]** keys to adjust the Audio output level. The level can be set from 0 to 30W.



5. To adjust the listen back volume, (while in listenback mode) press the **[VOL]**

Key, then press the [▲] or [▼] key to the desired listen back volume.

To exit from the FOG or other signaling mode, press the [16/9], [WX], or [CALL/SET] key.

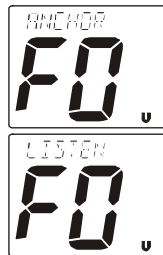

13.4 MANUAL INPUTTING OF THE GPS LOCATION (LAT/LON)

You may send the Latitude/Longitude of your vessel manually from the RAM+ Mic when the **GX5500S** is not connected the GPS receiver.

After the position is entered, transmitting a DSC Distress, Position Request, or Position Send will contain the manually entered position.

1. Press and hold down the [CALL(SET)MENU] key until “**RADIO SETUP**” menu appears.
2. Press the [▼] key to select “**DSC SETUP**” menu.
3. Press the [CALL(SET)MENU] key, then select “**POS INPUT**” with the [▲]/[▼] key.
4. Press the [CALL(SET)MENU] key. The display will be as shown in the illustration on the right.
5. Enter the your local time by the 24-hour system on the UTC time. Use the [CALL(SET)MENU] and [H/L] key to navigate to each column of the time, then use the [▲]/[▼] key to select the desired numbers in each column. Repeat for each column, to complete the time.
6. Enter the Latitude/Longitude of your vessel location with the same procedure as description above.
7. To store the data entered, press the [16/9] key to exit this menu and return to radio operation mode.



13.5 DSC/RADIO SETUP MODE

The RAM+ can access the DSC / RADIO setup menu (refer to section “11 DIGITAL SELECTIVE CALLING” and section “12 RADIO SETUP MODE” for details). However, the LAMP, CONTRAST, and KEY BEEP menu item which is accessed from the RAM+ only controls the RAM+’s display and speaker.

DSC/RADIO Setup mode from the RAM+:

1. Press and hold down the [**CALL(SET)MENU**] key until “**RADIO SETUP**” menu appears.
2. Press the [**▲**]/[**▼**] key to select “**RADIO SETUP**” or “**DSC SETUP**” menu.
3. Press the [**CALL(SET)MENU**] key, then select the menu item you wish to work on by pressing the [**▲**]/[**▼**] key.
4. Press the [**CALL(SET)MENU**] key.
5. Press the [**▲**]/[**▼**] key to change the value or condition for the menu item, then press the [**CALL(SET)MENU**] key to save the new setting.
6. Press the [**▲**]/[**▼**] key to select “**EXIT**,” then press the [**CALL(SET)MENU**] key to return to the normal operation.

RADIO SETUP	Function
DIMMER	Adjusts the backlight
CONTRAST	Contrast adjustment of the display
NAV DISPLAY	Selects Lat/Lon or SOG to be displayed
SOG UNIT	Knots, MPH or KPH selection
MAGNETIC	True or Magnetic selection
KEY BEEP	On or off selection
UNIT NAME	Allow changing the name of the connected mic
EXT SPK	Internal or External speaker selection
EXIT	Exits the RADIO SETUP menu

DSC SETUP	Function
INDIVIDUAL DIR	Setup the Individual Directory
INDIVIDUAL REPLY	Auto or manual selection
INDIVIDUAL ACK	Able or Unable to acknowledge Individual Call
INDIVIDUAL RINGER	Selects from 1 to 4 rings
GROUP DIR	Setup the Group Directory
POSITION REQUEST	Auto or manual selection
DSC BEEP	Turns on or off the Individual, Group, Position request or send beep
EXIT	Exits the DSC Setup menu

13.5.1 Lat/Lon or Time and SOG Display

Factory default is “Your Vessel’s Current Position,” however, following the steps below the GPS Information can be changed to “Course Over Ground (COG).”

1. Press and hold down the [CALL(SET)MENU] key until “**RADIO SETUP**” menu appears.
2. Press the [CALL(SET)MENU] key, then select “**NAV DISPLAY**” with the [▲]/[▼] key.
3. Press the [CALL(SET)MENU] key.
4. Press the [▼] or [▲] key to select “**Pos** (Your Vessel’s Current Position)” or “**Cru** (Course Over Ground).”
5. Press the [CALL(SET)MENU] key to store the data entered, then press the [16/9] key to exit this menu and return to radio operation mode.

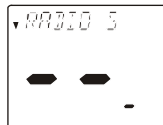

14 VH-310 HANDSET OPERATION

When the **VH-310** HANDSET is connected to the **GX5500S**, most VHF, DSC, and setup menus can be remotely operated. The **VH-310** HANDSET is supplied with 7 m of routing cable and can be extended up to 21 m using three 7 m extension cables model **CT-100**. The intercom operation can be used between the **VH-310** HANDSET or the **GX5500S**. In addition, speaker wires are supplied at the panel mount of the routing cable allowing the **STANDARD HORIZON MLS-300** or **MLS-310** External speakers to be connected in noisy environments

14.1 VH-310 HANDSET CONTROLS

- ① **PWR** key
Press and hold down this key to turn to the transceiver and **VH-310** HANDSET on and off.
- ② **PTT (Push-To-Talk)** Switch
Activates transmission.
- ③ **[H/L]** key
Toggles between high and low power. When the **[H/L]** key is pressed while the transceiver is on channel 13 or 67, the power will temporarily switch from “LO” to “HI” power until the **PTT** is released. The **[H/L]** key does not function on transmit inhibited and low power only channels.
- ④ **[DISTRESS]** key
Used to send a DSC Distress Call. To send the distress call refer to section “11.3.1. Transmitting a DSC Distress Alert.”
- ⑤ **RADIO CONTROL KEYS**
[VOL] key
Activates the volume adjusting mode.
Press this key to activate the volume adjusting mode.
Press the **[▲]** or **[▼]** to adjust the volume.

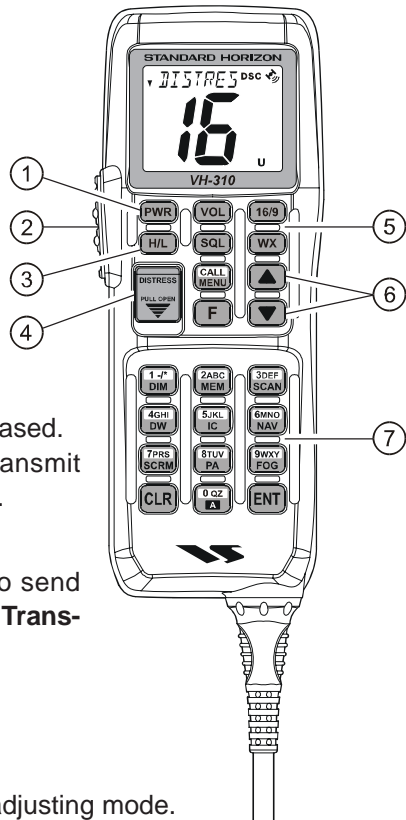

NOTE

When the **VH-310** handset is removed from the cradle the speaker audio will be automatically reduced so not to damage your hearing. When the **VH-310** is in the cradle the speaker audio will increase so communications can be heard.

[SQL] key

Activates the squelch adjusting mode.

Press this key to activate the squelch mode. Press the [▲] or [▼] key to adjust the squelch.

[CALL(MENU)] key

The [CALL(MENU)] key functions as the enter key.

Secondary use

Press the [CALL(MENU)] key to access the DSC OPERATION menu. The "INDIVIDUAL CALL," "GROUP CALL," "ALL SHIP CALL," "POSITION REQUEST," "POSITION SEND," "STANDBY MODE," and "CALL WAITING" functions can be accessed from the DSC OPERATION menu. Press and hold the [CALL(MENU)] key to access the RADIO SETUP (refer to section 12) or DSC SETUP menu (refer to section 11).

[F] key

Activates the "Alternate" key function.

Press this key to activate the "Alternate" key function of the numeric keypad.

[16/9] key

Immediately recalls channel 16 from any channel location. Holding down this key recalls channel 9. Pressing the [16/9] key reverts to the previously selected working channel.

Secondary use

Press and hold the [16/9] key then press the [WX] key to switch between the USA, International or Canadian channels.

[WX] key

Immediately recalls the previously selected US NOAA weather channel from any channel location.

Secondary use

Holding down the [16/9] key while pressing the [WX] key switches the Channel Group.

⑥ [▲] / [▼] KEY

These keys are used to select channels, adjust the volume and squelch level, and to choose the item selection of different functions (such as DSC operation).

⑦ **KEYPAD**

[1(DIM)] key

When in radio mode, this key is used to directly select digit “1” in a channel number.

Secondary use

Press the **[F]** key first then press the **[1(DIM)]** key to access the LCD Dimmer menu. Refer to section “**10.16 LCD DIMMER**” for details.

[2(MEM)] Key

When in radio mode, this key is used to directly select digit “2” in a channel number.

Secondary use

Press the **[F]** key first then press the **[2(MEM)]** key, memorize the selected channel into the transceiver scan memory for scanning. When repeat the same procedures (**[F]** → **[2(MEM)]**), will delete the channel from the scan memory. Refer to section “**10.13 SCANNING**” for details.

[3(SCAN)] Key

When in radio mode, this key is used to directly select digit “3” in a channel number.

Secondary use

- 1) Press the **[F]** key first then press the **[3(SCAN)]** key to start and stop the scanning of programmed channels. Refer to section “**10.13 SCANNING**” for details.
- 2) While holding down the **[3(SCAN)]** key and pressing the **[▲]** or **[▼]** key, you can confirm memory channels for scanning.

[4(DW)] Key

When in radio mode, this key is used to directly select digit “4” in a channel number.

Secondary use

Press the **[F]** key first then press the **[4(DW)]** key to scan for voice communications on the priority channel and another selected channel until a signal is received on either channel (Dual Watch). Refer to section “**10.12 DUAL WATCH (TO CH-16)**” for details.

[5(IC)] Key

When in radio mode, this key is used to directly select digit “5” in a channel number.

Secondary use

Press the **[F]** key then press the **[5(IC)]** key to activate intercom function between RAM+(s) or **VH-310** handset(s). Refer to section “**10.16 INTERCOM OPERATION**” for details.

[6(NAV)] Key

When in radio mode, this key is used to directly select digit “6” in a channel number.

Secondary use

Press the [F] key first then press the [6(NAV)] key, the LCD will display NAV GPS Data, Time, SOG (Speed Over Ground), and COG (Course Over Ground) when a GPS is connected to the accessory cable of the **GX5500S**. See section “**8.3 ACCESSORY CABLE**” for details.

[7(SCRM)] Key

When in radio mode, this key is used to directly select digit “7” in a channel number.

Secondary use

Press the [F] key then press the [7(SCRM)] key to toggle the Voice Scrambler “on” and “off.” Press the [F] key then press and hold the [7(SCRM)] key to enable the selection the Voice Scrambler code. Refer to section “**10.18 VOICE SCRAMBLER**” for details.

[8(PA)] Key

When in radio mode, this key is used to directly select digit “8” in a channel number.

Secondary use

Press the [F] key then press the [8(PA)] key to operate the 30 Watt PA function. Refer to section “**10.14 PA/FOG OPERATION**” for details.

NOTE

When in PA or FOG mode the **GX5500S** will receive on the last selected VHF channel before entering into the PA or FOG mode and receive DSC calls.

[9(FOG)] Key

When in radio mode, this key is used to directly select digit “9” in a channel number.

Secondary use

Press the [F] key then press the [9(FOG)] key to operate the Fog Horn function. Refer to section “**10.14 PA/FOG OPERATION**” for details.

[0(A)] Key

When in radio mode, this key is used to directly select digit “0” in a channel number.

Secondary use

Used to select A (alpha channels). Press the desired channel keys then press and hold [0] key until “A” appears next to the channel number and press [ENT] to select the channel.

[CLR] Key



Press the [CLR] key to cancel the menu selection and/or keypad entry.



[ENT] Key

Press the [ENT] key to enter the menu selection and/or keypad entry.

14.2 INTERCOM OPERATION

14.2.1 Communication

1. Press the [F] key followed by the [5(IC)] key, the mode is changed to "INTERCOM" mode.
2. If your **GX5500S** is equipped with two **VH-310** Handsets (or RAM+ Mics), select the station you wish to communicate (**RADIO**, **RAM**, or **ALL**) with the [▼]/[▲] key, then press the [ENT] key.

3. When the "INTERCOM" operation is activated, "IC" is displayed on the **VH-310** Handset (and RAM+ Mic, if used) and "INTERCOM" is displayed on the **GX5500S**.



(VH-310 Mic's PTT switch is pressed)
4. Press the PTT switch, "TALK" is displayed.
NOTE: A warning beep is emitted when the RAM+ Mic PTT switch is also being pressed while the transmitter microphone's PTT switch is pressed.



(GX5500S's PTT switch is pressed)
5. Speak slowly and clearly into the microphone, hold the microphone about 1.5 cm away from your mouth.
6. When finished, release the PTT switch.
7. To exit the "INTERCOM" mode and return to radio operation mode, press the [F] key followed by the [5(IC)] key again.

14.2.2 Calling

Press and hold the [5(IC)] key for 1 second when the "INTERCOM" is activated, a calling beep is emitted from the **GX5500S** speaker.

14.3 PA/FOG OPERATION

The **VH-310** Handset is capable of controlling the 30W Public address, 4 fog horns, bells and whistles.

NOTE

When in PA or FOG mode the **GX5500S** will receive on the last selected VHF channel before entering into the PA or FOG mode and receive DSC calls.

14.3.1 Operating the PA / Hailer

1. Press the [F] key followed by the [8(PA)] key, activate the "PA / HAIL" mode.
2. Press the **PTT** switch and speak into the microphone.
3. To turn up the PA Volume, press the **PTT** switch and press the [▲] or [▼] keys to adjust the Audio output level. The level can be set from 0 to 30W.
4. To adjust the listen back volume, (while in listenback mode) press the [VOL] Key, then press the [▲] or [▼] key to the desired listen back volume.

To exit from the PA / Hailer mode, press the [F] key followed by the [8(PA)] key again.

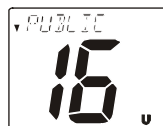

14.3.2 Operating the FOG Horn

The **GX5500S** is capable of sending Underway, Stop, Sail, Tow, Horn, Siren, Aground and Anchor signals.

1. Press the [F] key followed by the [9(FOG)] key, to activate the "FOG HORN" menu.
2. Select the one of the eight functions described above with the [▲] or [▼] key and press the [ENT] key.
3. On the "Horn" and "Siren" modes, press the **PTT** switch to activate the tone through the HAIL/PA speaker. Press the [▲] or [▼] keys to adjust the Audio output level. The level can be set from 0 to 30W.
4. To adjust the listen back volume, (while in listenback mode) press the [VOL] Key, then press the [▲] or [▼] key to the desired listen back volume.

To exit from the FOG HORN mode, press the [F] key followed by the [9(FOG)] key again.



14.4 MANUAL INPUTTING OF THE GPS LOCATION (LAT/LON)

You may send the Latitude/Longitude of your vessel manually from the **VH-310** Handset when the **GX5500S** is not connected the GPS receiver.

After the position is entered, transmitting a DSC Distress, Position Request, or Position Send will contain the manually entered position.

1. Press and hold down the [**CALL(MENU)**] key until “Radio Setup” menu appears.
2. Press the [**▼**] key to select “DSC SETUP” menu.
3. Press the [**ENT**] key, then select “POS INPUT” with the [**▲**]/
[**▼**] key.
4. Press the [**ENT**] key then, enter the your local time from the keypad by the 24-hour system on the UTC time.
5. Enter the Latitude of your vessel location (xx.xx.xx) by the keypad, then press the [**6(NAV)**] key to select North (N), or [**7(SCRM)**] key to select South (S).
6. Enter the Longitude of your vessel location (xxx.xx.xx) by the keypad, then press the [**3(SCAN)**] to select East (E), or [**9(FOG)**] key to select West (W).
7. If a number was entered by mistake, press the **H/L** key repeatedly to select the number. Press the [**▲**]/
[**▼**] key to select the desired number.
8. Press and hold in the [**ENT**] key to store the data entered, then press the [**16/9**] key to exit this menu and return to radio operation mode.



14.5 DSC/RADIO SETUP MODE

The **VH-310** Handset can access the DSC / RADIO setup menu (refer to section “**11 DIGITAL SELECTIVE CALLING**” and section “**12 RADIO SETUP MODE**” for details). The **CONTRAST**, **NAV DISPLAY**, **KEY BEEP**, and **AF SELECT** menu item accessed from the **VH-310** Handset only controls the **VH-310** Handset’s display and speaker.

DSC/RADIO Setup mode from the **VH-310** Handset:

1. Press and hold down the [**CALL(MENU)**] key until “**RADIO SETUP**” menu appears.
2. Press the [**▲**]/[**▼**] key to select “**RADIO SETUP**” or “**DSC SETUP**” menu.
3. Press the [**ENT**] key, then select the menu item you wish to work on by pressing the [**▲**]/[**▼**] key.
4. Press the [**ENT**] key.
5. Press the [**▲**]/[**▼**] key to change the value or condition for the menu item, then press the [**ENT**] key to save the new setting.
6. Press the [**▲**]/[**▼**] key to select “**EXIT**,” then press the [**ENT**] key to return to the normal operation.

RADIO SETUP	Function
CONTRAST	Contrast adjustment of the display
NAV DISPLAY	Selects Lat/Lon or SOG to be displayed
SOG UNIT	Knots, MPH or KPH selection
MAGNETIC	True or Magnetic selection
KEY BEEP	On or off selection
UNIT NAME	Allow changing the name of the connected mic
EXT SPK	Internal or External speaker selection
AF SELECT	Shown when VH-310 connected
EXIT	Exits the RADIO SETUP menu

DSC SETUP	Function
INDIVIDUAL DIR	Setup the Individual Directory
INDIVIDUAL REPLY	Auto or manual selection
INDIVIDUAL ACK	Able or Unable to acknowledge Individual Call
INDIVIDUAL RINGER	Selects from 1 to 4 rings
GROUP DIR	Setup the Group Directory
POSITION REQUEST	Auto or manual selection
DSC BEEP	Turns on or off the Individual, Group, Position request or send beep
EXIT	Exits the DSC Setup menu

NOTE

When the **SETUP** menu is selected, using the **VH-310** Handset, the **GX5500S** will be temporarily disabled until the **VH-310** Handset exits from the setup mode.

14.5.1 Changing the display to show Lat/Lon or Time and SOG

Factory default is “Your Vessel’s Current Position,” however, following the steps below the GPS Information can be changed to “Course Over Ground (COG).”

1. Press and hold down the [CALL(MENU)] key until “**RADIO SETUP**” menu appears.
2. Press the [ENT] key, then select “**NAV DISPLAY**” with the [▲]/[▼] key.
3. Press the [ENT] key.
4. Press the [▼] or [▲] key to select “**Pos** (Your Vessel’s Current Position)” or “**Cru** (Course Over Ground).”
5. Press the [ENT] key to store the data entered, then press the [16/9] key to exit this menu and return to radio operation mode.

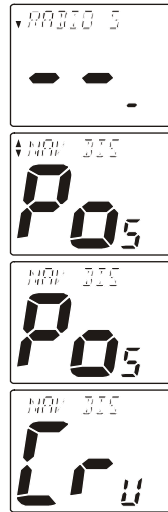

14.5.2 External Speaker AF Selection

The **AF SELECT** menu allows you to set the audio output level of the **VH-310's** External Speaker to a fixed level regardless of the **VOL** level setting of the **VH-310**, which is useful when using the **STANDARD HORIZON MLS-310 10W** amplified speaker with on/off volume control.

1. Press and hold down the [CALL(MENU)] key until “**Radio Setup**” menu appears.
2. Press the [ENT] key, then select “**AF SELECT**” with the [▲]/[▼] key.
3. Press the [ENT] key.
4. Press the [▲] or [▼] key to select “**Pr**” (External Speaker Level is “Fixed”) or “**Po**” (External Speaker Level is “Adjustable”).
5. Press the [ENT] key to store the data entered, then press the [16/9] key to exit this menu and return to radio operation mode.

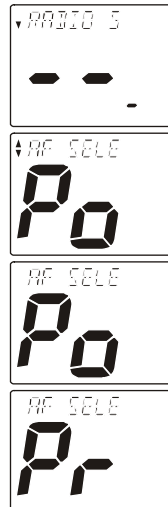

15 MAINTENANCE

The inherent quality of the solid-state components used in this transceiver will provide many years of continuous use. Taking the following precautions will prevent damage to the transceiver.

- Keep the microphone connected or the jack covered at all times to prevent corrosion of electrical contacts;
- Never key the microphone unless an antenna or suitable dummy load is connected to the transceiver.
- Ensure that the supply voltage to the transceiver does not exceed 16 VDC or fall below 11 VDC.
- Use only STANDARD HORIZON-approved accessories and replacement parts.

In the unlikely event of serious problems, please contact your Dealer or our repair facility. Address and phone numbers for this facility, as well as warranty information, are contained in section "17 WARRANTY."

15.1 REPLACEMENT PARTS

Occasionally an owner needs a replacement mounting bracket or knob. These can be ordered from our Parts Department by writing or calling:

Marine Division of Vertex Standard

US Headquarters

10900 Walker Street, Cypress, CA 90630, U.S.A.

Telephone (714) 827-7600

Commonly requested parts, and their part numbers are listed below.

- **Power Cord:** T9023306
- **VOL/SQL Knob:** RA0542600
- **Rotary Channel Knob:** RA0542500
- **Mounting Bracket:** RA0544200
- **Mounting Bracket Knob:** RA045910A
- **Microphone Hanger:** RA0458800
- **Microphone Assembly:** M3090118
- **RAM+ Mic Routing Cable Assembly:** S8101512

15.2 FACTORY SERVICE

In the unlikely event that the radio fails to perform or needs servicing, please contact the following:

Standard Horizon

Attention Marine Repair Department

10900 Walker Street, Cypress, CA 90630

Telephone (800) 366-4566

An "RA" Return Authorization number is not necessary to send a product in for service. Include a brief note describing the problem along with your name, return address, phone number, and proof of purchase.

15.3 TROUBLESHOOTING CHART

SYMPTOM	PROBABLE CAUSE	REMEDY
Transceiver fails to power up.	No DC voltage to the transceiver, or blown fuse.	a. Check the 12VDC battery connections and the fuse. b. The PWR switch needs to be pressed and held to turn the radio on.
Transceiver blows fuse when connected to power supply.	Reversed power wires.	Check the power cable for DC voltage, or replace the fuse (6A 250V). Make sure the red wire is connected to the positive (+) battery post, and the black wire is connected to the negative (-) battery post. If the fuse still blows, contact marine product support.
Popping or whining noise from the speaker while engine runs.	Engine noise.	Reroute the DC power cables away from the engine. Add noise suppressor on power cable. Change to resistive spark plug wires and/or add an alternator whine filter.
Sound is not emitted from the internal or external speaker.	Accessory cable.	Check the connections of the accessory cable (Short Circuit the External speaker cable WHITE/SHIELD).
Sound is not emitted from the PA speaker.	Accessory cable.	Check the accessory cable connection (Short Circuit the PA speaker cable RED/SHIELD).
Receiving station reports low transmit power, even with transceiver set to HI power.	Antenna.	Have the antenna checked or test the transceiver with another antenna. If the problem persists, contact your Dealer for servicing.
"HI BATTERY" or "LO BATTERY" message appears when the power is turned on.	The power supply voltage is too high or too low.	Confirm that the connected power supply voltage is not 17 volts or lower than 10 volts.
"PA ERROR" or "FOG ERROR" message is shown when the PA/FOG mode is activated.	Accessory cable.	Check the accessory cable connection (Short Circuit the PA speaker cable RED/SHIELD).
Your position is not displayed.	Accessory cable.	Check the accessory cable connection. Some GPS use the battery ground line for NMEA connection.
	Setting of the GPS navigation receiver.	Check the output signal format of the GPS navigation receiver. This radio requires NMEA0183 format with GLL, RMB, or RMC sentence as an output signal. If the GPS has a baud rate setting make sure to select 4800 and parity to NONE.
While in PA or FOG listen back modes, am broadcasts can be heard.	Strong AM radio stations are being pickup up by the speaker wires.	Need to replace the speaker wires to a sheilded 2 conductor wire available from Radio Shack part number 278-513. Refer to section " 8.3 ACCESSORY CABLE " for cable connections.

16 CHANNEL ASSIGNMENTS

Tables on the following columns list the VHF Marine Channel assignments for U.S.A. and International use. Below are listed some data about the charts.

1. VTS. Where indicated, these channels are part of the U.S. Coast Guard's **Vessel Traffic System**.
2. Alpha channel numbers, that is, channel numbers followed by the letter A (such as Channel 07A) are **simplex** channels on the U.S.A. or Canadian channel assignments whose counterparts in the International assignments are **duplex** channels. International channels do not use "alpha" numbers. If you call the Coast Guard on Channel 16, they will sometimes ask you to "**go to channel 22 Alpha**." This is a channel assigned to U.S.A., and Canadian Coast Guards for handling distress and other calls. If your radio is set for **International** operation you will go to Channel 22 instead of 22A, and will not be able to communicate with the Coast Guard. To use Channel 22A, your radio must be set for **USA** or **Canada** operation, usually by a U/I/C (USA/International/Canada) control or combination of controls. Channel 22 (without an "A") is an **International** duplex channel for port operations. Some radios indicate an "A" adjacent to the alpha channels on the display; on others "alpha" is not indicated but the proper channel is selected based on the U/I/C setting.
3. Bridge-to-Bridge channels (for example, Channel 13) are for use by bridge operators on intercoastal waterways and rivers. It is also used by marine vessels in the vicinity of these bridges for navigation and for communicating with the bridge operators. Note that a limit of 1 Watt is specified for these channels. See page 27 for additional information.
4. The **S/D** column on the chart indicates either S (simplex) or D (duplex). **Simplex** means transmitting and receiving on the same frequency. Only one party at a time can talk, unlike a telephone. Be sure to say "**over**" and release your microphone push-to-talk switch at the end of each transmission. **Duplex** operation involves the use of one frequency for transmitting and a separate frequency for receiving. On channels specified as duplex on the charts, correct mode of operation is established automatically by your radio when you select a channel; you cannot change the mode. And you still must release the push-to-talk switch after each transmission in order to listen to the radio.
5. Channels normally used by recreational boaters are those that include the term "non-commercial" in the **Channel Use** column of the chart. Some of these are shared with other users and some are used only in certain geographic regions.



6. Marine vessels equipped with VHF radios are required to monitor Channel 16.

VHF MARINE CHANNEL CHART								
CH	U	C	I	S/D	TX	RX	CHANNEL USE	
01		X	X	D	156.050	160.650	Public Correspondence (Marine Operator)	
01A	X			S	156.050		Port Operation and Commercial. VTS in selected areas	
02		X	X	D	156.100	160.700	Public Correspondence (Marine Operator)	
03		X	X	D	156.150	160.750	Public Correspondence (Marine Operator)	
03A	X			S	156.150		US Government only, Coast Guard	
04			X	D	156.200	160.800	Public Correspondence (Marine Operator), Port operation, ship movement	
04A		X		S	156.200		Pacific coast: Coast Guard, East Coast: Commercial fishing	
05			X	D	156.250	160.850	Public Correspondence (Marine Operator), Port operation, ship movement	
05A	X	X		S	156.250		Port operation. VTS in Seattle	
06	X	X	X	S	156.300		Inter-ship Safety	
07			X	D	156.350	160.950	Public Correspondence (Marine Operator), Port operation, ship movement	
07A	X	X		S	156.350		Commercial	
08	X	X	X	S	156.400		Commercial (Inter-ship only)	
09	X	X	X	S	156.450		Boater Calling channel. Commercial & Non-commercial (Recreational)	
10	X	X	X	S	156.500		Commercial	
11	X	X	X	S	156.550		Commercial. VTS in selected areas.	
12	X	X	X	S	156.600		Port operation. VTS in selected areas.	
13	X	X	X	S	156.650		Inter-ship Navigation Safety (Bridge-to-bridge)	
14	X	X	X	S	156.700		Port operation. VTS in selected areas.	
15	X			S	---	156.750	Environmental (Receive only)	
15		X	X	S	156.750		Commercial, non-commercial, ship movement (1 W)	
16	X	X	X	S	156.800		International Distress, Safety and Calling	
17	X	X	X	S	156.850		State Controlled (1 W)	
18			X	D	156.900	161.500	Port operation, ship movement	
18A	X	X		S	156.900		Commercial	
19			X	D	156.950	161.550	Port operation, ship movement	
19A	X			S	156.950		US: Commercial	
19A		X		S	156.950		Coast Guard	
20	X	X	X	D	157.000	161.600	Canadian Coast Guard Only, International: port operations and shipment	
20A	X			S	157.000		Port operation	
21			X	D	157.050	161.650	Port operation, ship movement	
21A	X	X		S	157.050		U.S. Government Only, Canadian Coast Guard	
22			X	D	157.100	161.700	Port operation, ship movement	
22A	X	X		S	157.100		US and Canadian Coast Guard Liaison and Maritime Safety Information Broadcasts announced on channel 16	

VHF MARINE CHANNEL CHART							
CH	U	C	I	S/D	TX	RX	CHANNEL USE
23		X	X	D	157.150	161.750	Public Correspondence (Marine Operator)
23A	X			S	157.150		U.S. Government Only
24	X	X	X	D	157.200	161.800	Public Correspondence (Marine Operator)
25	X	X	X	D	157.250	161.850	Public Correspondence (Marine Operator)
26	X	X	X	D	157.300	161.900	Public Correspondence (Marine Operator)
27	X	X	X	D	157.350	161.950	Public Correspondence (Marine Operator)
28	X	X	X	D	157.400	162.000	Public Correspondence (Marine Operator)
60		X	X	D	156.025	160.625	Public Correspondence (Marine Operator)
61			X	D	156.075	160.675	Public Correspondence (Marine Operator), Port operation, ship movement
61A	X	X		S	156.075		U.S. Government Only, Canadian Coast Guard-Pacific Coast, Commercial Fishing-East Coast
62			X	D	156.125	160.725	Public Correspondence (Marine Operator), Port operation, ship movement
62A		X		S	156.125		Public Coast: Coast Guard; East Coast: commercial fishing only
63			X	D	156.175	160.775	Public Correspondence (Marine Operator), Port operation, ship movement
63A	X			S	156.175		Port Operation and Commercial. VTS in selected areas.
64		X	X	D	156.225	160.825	Public Correspondence (Marine Operator), Port operation, ship movement
64A	X	X		S	156.225		U.S. Government Only, Canadian Commercial Fishing
65			X	D	156.275	160.875	Public Correspondence (Marine Operator), Port operation, ship movement
65A	X	X		S	156.275		Port Operations
66			X	D	156.325	160.925	Public Correspondence (Marine Operator), Port operation, ship movement
66A	X	X		S	156.325		Port Operations
67	X	X	X	S	156.375		US: Commercial. Used for Bridge-to-bridge communications in lower Mississippi River. Inter-ship only, Canada: Commercial fishing, S&R
68	X	X	X	S	156.425		Non-commercial (Recreational)
69	X	X	X	S	156.475		US: Non-commercial (Recreational), Canada: Commercial fishing only, International: Inter-ship, Port operations and Ship movement
70	X	X	X	S	156.525		Digital selective calling (voice communications not allowed)
71	X	X	X	S	156.575		US, Canada: Non-commercial (Recreational), International: Port operations and Ship movement
72	X	X	X	S	156.625		Non-commercial (Inter-ship only)
73	X	X	X	S	156.675		US: Port Operations, Canada: Commercial fishing only, International: Inter-ship, Port operations and Ship movement
74	X	X	X	S	156.725		US: Port Operations, Canada: Commercial fishing only, International: Inter-ship, Port operations and Ship movement

VHF MARINE CHANNEL CHART							
CH	U	C	I	S/D	TX	RX	CHANNEL USE
75	X		X	S	156.775		Port Operations (Inter-ship only) (1W)
76	X		X	S	156.825		Port Operations (Inter-ship only) (1W)
77	X	X		S	156.875		Port Operations (Inter-ship only) (1W)
77			X	S	156.875		Port Operations (Inter-ship only)
78			X	D	156.925	161.525	Public Correspondence (Marine Operator), Port operation, ship-movement
78A	X	X		S	156.925		Non-commercial (Recreational)
79			X	D	156.975	161.575	Port operation and Ship movement
79A	X	X		S	156.975		Commercial
80			X	D	157.025	161.625	Port operation, ship movement
80A	X	X		S	157.025		Commercial
81			X	D	157.075	161.675	Port operation, ship movement
81A	X	X		S	157.075		U.S. Government Only - Environmental protection operations.
82			X	D	157.125	161.725	Public Correspondence (Marine Operator), Port operation, ship movement
82A	X	X		S	157.125		U.S. Government Only, Canadian Coast Guard Only
83		X	X	D	157.175	161.775	Canadian Coast Guard Only
83A	X	X		S	157.175		U.S. Government Only, Canadian Coast Guard Only
83		X	X	D	157.175	161.775	Public Correspondence (Marine Operator)
84	X	X	X	D	157.225	161.825	Public Correspondence (Marine Operator)
85	X	X	X	D	157.275	161.875	Public Correspondence (Marine Operator)
86	X	X	X	D	157.325	161.925	Public Correspondence (Marine Operator)
87	X	X		D	157.375	161.975	Public Correspondence (Marine Operator)
87			X	S	157.375		Public Correspondence (Marine Operator)
88	X	X		D	157.425	162.025	Public Correspondence (ship-to-coast)
88			X	S	157.425		Public Correspondence (ship-to-coast)
88A	X			S	157.425		Commercial, Inter-ship Only
WX01	X	X	X	D	---	162.550	Weather (receive only)
WX02	X	X	X	D	---	162.400	Weather (receive only)
WX03	X	X	X	D	---	162.475	Weather (receive only)
WX04	X	X	X	D	---	162.425	Weather (receive only)
WX05	X	X	X	D	---	162.450	Weather (receive only)
WX06	X	X	X	D	---	162.500	Weather (receive only)
WX07	X	X	X	D	---	162.525	Weather (receive only)
WX08	X	X	X	D	---	161.650	Weather (receive only)
WX09	X	X	X	D	---	161.775	Weather (receive only)
WX10	X	X	X	D	---	163.275	Weather (receive only)

The above **BOLD** channels are not for use of the general public in U.S. waters, unless proper authorization is given.



Channel designator	Carrier frequency (MHz)		Points of communication (Intership and between coast and ship unless otherwise indicated)	
	Ship transmit	Coast transmit		
Port Operations				
01A ¹	156.050	156.050	Intership only. Intership only.	
63A ¹	156.175	156.175		
05 ²	156.250	156.250		
65A	156.275	156.275		
66A	156.325	156.325		
12 ³	156.600	156.600		
73	156.675	156.675		
14 ³	156.700	156.700		
74	156.725	156.725		
77 ⁴	156.875			
20A ¹²	157.000			
Navigational (Bridge-to-Bridge)⁵				
13 ⁶	156.650	156.650		
67 ⁷	156.375	156.375		
Commercial				
01A ¹	156.050	156.050	Intership only. Do.	
63A ¹	156.175	156.175		
07A	156.350	156.350		
67 ⁷	156.375			
08	156.400		
09	156.450	156.450		
10	156.500	156.500		
11 ³	156.550	156.550		
18A	156.900	156.900		
19A	156.950	156.950		
79A	156.975	156.975		
80A	157.025	157.025		
88A ⁸	157.425		
72 ¹⁴	156.625		
Digital Selective Calling				
70 ¹⁵	156.525	156.525		

Channel designator	Carrier frequency (MHz)		Points of communication (Intership and between coast and ship unless otherwise indicated)	
	Ship transmit	Coast transmit		
Noncommercial				
68 ¹⁷	156.425	156.425	Intership only. Great Lakes only. Do. Intership only.	
09 ¹⁶	156.450	156.450		
69	156.475	156.475		
71	156.575	156.575		
72	156.625		
78A	156.925	156.925		
79A	156.975	156.975		
80A	157.025	157.025		
67 ¹⁴	156.375		
Distress, Safety and Calling				
16	156.800	156.800		EPRIB
Intership Safety				
06	156.300		a. Intership, or b. For SAR: Ship and aircraft for the U.S. Coast Guard.
Environmental				
15 ¹³	156.750	Coast to ship only.	
Maritime Control				
17 ^{9,10}	156.850	156.850		
Liaison, U.S. Coast Guard				
22A ¹¹	157.100	157.100	Ship, aircraft, and coast stations of the U.S. Coast Guard and at Lake Mead, Nev., ship and coast stations of the National Park Service, U.S. Department of the Interior.	

- 1: 156.050 MHz and 156.175 MHz are available for port operations and commercial communications purposes when used only within the U.S. Coast Guard designated Vessel Traffic Services (VTS) area of New Orleans, on the lower Mississippi River from the various pass entrances in the Gulf of Mexico to Devil's Swamp Light at River Mile 242.4 above head of passes near Baton Rouge.
- 2: 156.250 MHz is available for port operations communications use only within the U.S. Coast Guard designated VTS radio protection areas of New Orleans and Houston described in Sec. 80.383. 156.250 MHz is available for intership port operations communications used only within the area of Los Angeles and Long Beach harbors, within a 25-nautical mile radius of Point Fermin, California.
- 3: 156.550 MHz, 156.600 MHz and 156.700 MHz are available in the U.S. Coast Guard designated port areas only for VTS communications and in the Great Lakes available primarily for communications relating to the movement of ships in sectors designated by the St. Lawrence Seaway Development Corporation or the U.S. Coast Guard. The use of these frequencies outside VTS and ship movement sector protected areas is permitted provided they cause no interference to VTS and ship movement communications in their respective designated sectors.

- 4: Use of 156.875 MHz is limited to communications with pilots regarding the movement and docking of ships. Normal output power must not exceed 1 watt.
- 5: 156.375 MHz and 156.650 MHz are available primarily for intership navigational communications. These frequencies are available between coast and ship on a secondary basis when used on or in the vicinity of locks or drawbridges. Normal output power must not exceed 1 watt. Maximum output power must not exceed 10 watts for coast stations or 25 watts for ship stations.
- 6: On the Great Lakes, in addition to bridge-to-bridge communications, 156.650 MHz is available for vessel control purposes in established vessel traffic systems. 156.650 MHz is not available for use in the Mississippi River from South Pass Lighted Whistle Buoy "2" and Southwest Pass entrance Midchannel Lighted Whistle Buoy to mile 242.4 above Head of Passes near Baton Rouge. Additionally it is not available for use in the Mississippi River-Gulf Outlet, the Mississippi River-Gulf Outlet Canal, and the Inner Harbor Navigational Canal, except to aid the transition from these areas.
- 7: Use of 156.375 MHz is available for navigational communications only in the Mississippi River from South Pass Lighted Whistle Buoy "2" and Southwest Pass entrance Midchannel Lighted Whistle Buoy to mile 242.4 above head of Passes near Baton Rouge, and in addition over the full length of the Mississippi River-Gulf Outlet Canal from entrance to its junction with the Inner Harbor Navigation Canal, and over the full length of the Inner Harbor Navigation Canal from its junction with the Mississippi River to its entry to Lake Pontchartrain at the New Seabrook vehicular bridge.
- 8: Within 120 km (75 miles) of the United States/Canada border, in the area of the Puget Sound and the Strait of Juan de Fuca and its approaches, 157.425 MHz is half of the duplex pair designated as Channel 88. In this area, Channel 88 is available to ship stations for communications with public coast stations only. More than 120 km (75 miles) from the United States/Canada border in the area of the Puget Sound and the Strait of Juan de Fuca, its approaches, the Great Lakes, and the St. Lawrence Seaway, 157.425 MHz is available for intership and commercial communications. Outside Puget Sound area and its approaches and the Great Lakes, 157.425 MHz is also available for communications between commercial fishing vessels and associated aircraft while engaged in commercial fishing activities.
- 9: When the frequency 156.850 MHz is authorized, it may be used additionally for search and rescue training exercises conducted by state or local governments.
- 10: The frequency 156.850 MHz is additionally available to coast stations on the Great Lakes for transmission of scheduled Coded Marine Weather Forecasts (MAFOR), Great Lakes Weather Broadcast (LAWEB) and unscheduled Notices to Mariners or Bulletins. F3C and J3C emissions are permitted. Coast Stations on the Great Lakes must cease weather broadcasts which cause interference to stations operating on 156.800 MHz until the interference problem is resolved.
- 11: The frequency 157.100 MHz is authorized for search and rescue training exercises by state or local government in conjunction with U.S. Coast Guard stations. Prior U.S. Coast Guard approval is required. Use must cease immediately on U.S. Coast Guard request.
- 12: The duplex pair for channel 20 (157.000/161.600 MHz) may be used for ship to coast station communications.
- 13: Available for assignment to coast stations, the use of which is in accord with an agreed program, for the broadcast of information to ship stations concerning the environmental conditions in which vessels operate, i.e., weather; sea conditions; time signals; notices to mariners; and hazards to navigation.
- 14: Available only in the Puget Sound and the Strait of Juan de Fuca.
- 15: The frequency 156.525 MHz is to be used exclusively for distress, safety and calling using digital selective calling techniques. No other uses are permitted.
- 16: The frequency 156.450 MHz is available for intership, ship and coast general purpose calling by noncommercial vessels, such as recreational boats and private coast stations.
- 17: The frequency 156.425 MHz is assigned by rule to private coast stations in Alaska for facsimile transmissions as well as voice communications.

17 WARRANTY

Marine Products Limited Warranty

STANDARD HORIZON (a division of VERTEX STANDARD) warrants, to the original purchaser only, each new Marine Communications Product ("Product") manufactured and/or supplied by STANDARD HORIZON against defects in materials and workmanship under normal use and service for a period of time from the date of purchase as follows:

Fixed Mount and Portable Transceivers

1 year - if purchased before 01/01/91

3 years - if purchased between 01/01/91 and 01/01/94

3 years Waterproof - if purchased after 01/01/94

Loud hailers

1 year - if purchased before 01/01/91

3 years - if purchased after 01/01/91

Associated Chargers

1 year - if purchased before 01/01/91

3 years - if purchased after 01/01/91

Associated Batteries - 18 months. Note: Batteries will be deemed defective only if storage capacity drops below 80% of rated capacity or if leakage develops.

Associated Accessories - 1 year. Includes: Microphones/Handsets, External Speakers, Antennas, Carrying Accessories, Power Supplies, and Signaling Boards.

To receive warranty service, the purchaser must deliver the Product, transportation and insurance prepaid, to STANDARD HORIZON (a division of VERTEX STANDARD), Attention Marine repairs 10900 Walker Street, Cypress, CA 90630. Include proof of purchase indicating model, serial number, and date of purchase. STANDARD HORIZON will return the Product to the purchaser freight prepaid. Products purchased prior to January 1, 1991 will bear the STANDARD HORIZON warranty terms in effect prior to that date.

In the event of a defect, malfunction or failure of the Product during the warranty period, STANDARD HORIZON's liability for any breach of contract or any breach of express or implied warranties in connection with the sale of Products shall be limited solely to repair or replacement, at its option, of the Product or part(s) therein which, upon examination by STANDARD HORIZON, appear to be defective or not up to factory specifications. STANDARD HORIZON may, at its option, repair or replace parts or subassemblies with new or



reconditioned parts and subassemblies. Parts thus repaired or replaced are warranted for the balance of the original applicable warranty.

STANDARD HORIZON will not warrant installation, maintenance or service of the Products. In all instances, STANDARD HORIZON's liability for damages shall not exceed the purchase price of the defective Product.

This warranty only extends to Products sold within the 50 States of the United States of America and the District of Columbia.

STANDARD HORIZON will pay all labor to repair the product and replacement parts charges incurred in providing the warranty service except where purchaser abuse or other qualifying exceptions exist. The purchaser must pay any transportation expenses incurred in returning the Product to STANDARD HORIZON for service.

This limited warranty does not extend to any Product which has been subjected to misuse, neglect, accident, incorrect wiring by anyone other than STANDARD HORIZON, improper installation, or subjected to use in violation of instructions furnished by STANDARD HORIZON, nor does this warranty extend to Products on which the serial number has been removed, defaced, or changed. STANDARD HORIZON cannot be responsible in any way for ancillary equipment not furnished by STANDARD HORIZON which is attached to or used in connection with STANDARD HORIZON's Products, or for the operation of the Product with any ancillary equipment, and all such equipment is expressly excluded from this warranty. STANDARD HORIZON disclaims liability for range, coverage, or operation of the Product and ancillary equipment as a whole under this warranty. STANDARD HORIZON reserves the right to make changes or improvements in Products, during subsequent production, without incurring the obligation to install such changes or improvements on previously manufactured Products.

The implied warranties which the law imposes on the sale of this Product are expressly LIMITED, in duration, to the time period specified above. STANDARD HORIZON shall not be liable under any circumstances for consequential damages resulting from the use and operation of this Product, or from the breach of this LIMITED WARRANTY, any implied warranties, or any contract with STANDARD HORIZON. IN CONNECTION WITH THE SALE OF ITS PRODUCTS, STANDARD HORIZON MAKES NO WARRANTIES, EXPRESS OR IMPLIED AS TO THE MERCHANTABILITY OR FITNESS FOR A PARTICULAR PURPOSE OR OTHERWISE, EXCEPT AS EXPRESSLY SET FORTH HEREIN.



Some states do not allow the exclusion or limitation of incidental or consequential damages, or limitation on how long an implied warranty lasts, so the above limitations or exclusions may not apply. This warranty gives specific legal rights, and there may be other rights which may vary from state to state.

ONLY PRODUCTS SOLD ON OR AFTER JANUARY 1, 1991 ARE COVERED UNDER THE TERMS OF THIS LIMITED WARRANTY.

ON-LINE WARRANTY REGISTRATION

THANK YOU for buying STANDARD HORIZON (a division of Vertex Standard) products! We are confident your new radio will serve your needs for many years!

Please visit **www.standardhorizon.com** to register the **GX5500S** Marine VHF. It should be noted that visiting the Web site from time to time may be beneficial to you, as new products are released they will appear on the STANDARD HORIZON Web site. Also a statement regarding product support should be added to the manual.

Product Support Inquiries

If you have any questions or comments regarding the use of the **GX5500S**, you can visit the STANDARD HORIZON Web site to send an E-Mail or contact the Product Support team at (714) 827-7600 ext 6300 M-F 7:00-5:00PST.

In addition to the warranty, STANDARD HORIZON includes a lifetime "flat rate" and "customer loyalty" programs to provide service after the warranty period has expired. If you wish to obtain the flat rate price for out-of-warranty repair, you must include the information on the Owner's Record with the unit when you return it to your Dealer or to STANDARD HORIZON.

Lifetime Flat Rate Service Program: For the original Owner only, for the lifetime of the unit, STANDARD HORIZON will repair the unit to original specifications.

Note: The flat rate amount is payable by the Owner only if STANDARD HORIZON or the STANDARD HORIZON Dealer determines that a repair is needed. After the repair, a 90-day warranty will be in effect from the date of return of the unit to the Owner.

This service program is not available for equipment which has failed as a result of neglect, accident, breakage, misuse, improper installation or modification, or water damage (depending on the product).

18 SPECIFICATIONS

Performance specifications are nominal, unless otherwise indicated, and are subject to change without notice.

18.1 GENERAL

Channels	All USA, International and Canadian
Input Voltage	13.8 VDC \pm 20%
Current Drain	
Standby	0.5 A
Receive	1.5 A
Transmit	5.0 A (Hi); 1.5 A (Lo)
Dimensions	3.5" H x 9.1" W x 5.9" D (90 H x 230 W x 150 D mm)
Flush-Mount Dimensions	2.8" H x 8.1" W x 5.1" D (72 H x 205 W x 130 D mm)
Weight	3.2 lbs (1.45 kg)

18.2 TRANSMITTER

Frequency Range	156.025 to 157.425 MHz
RF Output	25 W (Hi); 1 W (Lo)
Conducted Spurious Emissions	80 dB (Hi); 66 dB (Lo)
Audio Response	within \pm 1/-3 of a 6 dB/octave pre-emphasis characteristic at 300 to 3000 Hz
Audio Distortion	5 %
Modulation	16K0G3E, for DSC 16K0G2B
Frequency Stability (-20°C to +60°C)	\pm 0.0005%
FM Hum and Noise	50 dB

18.3 RECEIVER

Frequency Range	156.050 to 163.275 MHz
Sensitivity	
20 dB Quieting	0.35 μ V
12 dB SINAD	0.30 μ V
Squelch Sensitivity (Threshold)	0.13 μ V
Modulation Acceptance Bandwidth	\pm 7.5 kHz
Selectivity (Typical)	
Spurious and Image Rejection	-80 dB
Intermodulation and Rejection at 12 dB SINAD	-80 dB
Audio Output	4.5 W
Audio Response	within \pm 1/-3 of a 6 dB/octave de-emphasis characteristic at 300 to 3000 Hz
Frequency Stability (-20°C to +60°C)	\pm 0.0005 %
Channel Spacing	25 kHz
DSC Format	EN 301 025
NMEA Input/Output	Output - DSC, DSE Input - GLL, GGA, RMC and GNS



**Marine Division of VERTEX STANDARD
US Headquarters**
10900 Walker Street, Cypress, CA 90630, U.S.A.

[www. standardhorizon.com](http://www.standardhorizon.com)



E M 0 2 8 N 2 0 0

Copyright 2007
VERTEX STANDARD CO., LTD.
All rights reserved.

No portion of this manual
may be reproduced
without the permission of
VERTEX STANDARD CO., LTD.

Free Manuals Download Website

<http://myh66.com>

<http://usermanuals.us>

<http://www.somanuals.com>

<http://www.4manuals.cc>

<http://www.manual-lib.com>

<http://www.404manual.com>

<http://www.luxmanual.com>

<http://aubethermostatmanual.com>

Golf course search by state

<http://golfingnear.com>

Email search by domain

<http://emailbydomain.com>

Auto manuals search

<http://auto.somanuals.com>

TV manuals search

<http://tv.somanuals.com>