

**Pro Upright Bike  
Pro Recumbent Bike**

---

**OWNER'S MANUAL**



# TABLE OF CONTENTS

<b>Introduction</b> .....	<b>4</b>
About This Manual .....	4
<b>Safety Instructions</b> .....	<b>5</b>
English .....	5
Dutch .....	6
French .....	6
German .....	7
Italian .....	7
Portuguese .....	8
Spanish .....	8
Swedish .....	9
Chinese .....	9
Japanese .....	10
<b>Assembly and Setup</b> .....	<b>11</b>
Pro Upright Bike Assembly and Setup .....	11
Pro Recumbent Bike Assembly and Setup .....	13
<b>Operating Instructions</b> .....	<b>15</b>
Seat Adjustments .....	15
Pedal Strap Operation .....	16
Heart Rate Bar Operation (Pro Recumbent Bike) .....	16
Display Panel Features .....	16
Hints and Tips for Getting Started .....	18
Viewing Workout Data During a Program .....	18
Cooldown Cycle .....	19
Using the Personal Fan .....	19
Heart Rate Monitoring .....	19
Quick Start .....	20
Preset Programs .....	20
Training Tools Programs .....	23
<b>Preventative Maintenance</b> .....	<b>28</b>
Daily Maintenance .....	28
Weekly Maintenance .....	28
Monthly Maintenance .....	28
<b>Manager / Maintenance Mode</b> .....	<b>28</b>
Manager Mode .....	28
Maintenance Mode .....	28
<b>Troubleshooting</b> .....	<b>31</b>
Start-Up Service Messages .....	31
<b>Regulatory Information</b> .....	<b>31</b>

Copyright 2003. Star Trac by Unisen, Inc. All rights reserved, including those to reproduce this book or parts thereof in any form without first obtaining written permission from Star Trac.

Every effort has been made to keep this information current; however, periodically, changes are made to the information herein, and these changes will be incorporated into new editions of this publication. All product names and logos are trademarks of their respective owners. Printed in the USA.



**Pro Upright Bike**



**Pro Recumbent Bike**

# INTRODUCTION

Thank you for choosing the **STAR TRAC PRO BIKE**. The Upright and Recumbent Bikes have been designed to provide the user the most rewarding experience based upon the carefully planned features it possesses. The design elements of these Bikes will provide you with a comfortable, intuitive, safe and reliable experience, guiding you to a habit-forming lifestyle. Our mission is to provide products to mold lifelong habits for health and fitness, and our Bikes will provide the path to meet your goals. Enjoy the ride.

## ABOUT THIS MANUAL

This manual is applicable to the **STAR TRAC PRO UPRIGHT BIKE** and the **STAR TRAC PRO RECUMBENT BIKE**. The manual is divided into eight sections, as follows:

### **Introduction**

Provides an overview of each section within the manual.

### **Safety Instructions**

Provides guidelines, in multiple languages, for safely operating the Star Trac Pro Bikes.

### **Assembly and Setup**

Provides instructions for unpacking, assembling and setting up the Star Trac Pro Bikes.

### **Operating Instructions**

Provides a detailed description of the Display Panel, and includes step-by-step instructions for operating the Star Trac Pro Bikes.

### **Preventative Maintenance**

Describes the preventative maintenance measures required to keep the Star Trac Pro Bikes in top condition.

### **Manager / Maintenance Mode**

Provides step-by-step instructions for changing universal parameters on Star Trac Pro Bikes, and for performing built-in testing procedures.

### **Troubleshooting**

Describes the start-up and shutdown messages provided as a result of the self-test routine.

### **Regulatory Information**

Provides regulatory information for the Star Trac Pro Bikes.

# SAFETY INSTRUCTIONS

This chapter includes fitness safeguards and precautions for the installation and use of the Star Trac Pro Bikes. Please read this chapter carefully before installing or using your equipment.

Safety instructions are provided in the following languages (in the order shown):

- English
- Dutch
- French
- German
- Italian
- Portuguese
- Spanish
- Swedish
- Chinese
- Japanese

## PRECAUTIONS

These safety notes are directed to you as the owner of the Star Trac Pro Bike. Please train all your users and fitness staff to follow these safety instructions.

### Do

- Do encourage each of your users to discuss their health program or fitness regimen with a healthcare professional.
- Do stop operating your Pro Bike if you feel dizzy or faint.
- Do perform regular preventative maintenance.
- Do exercise slowly until you reach a level of comfort.
- Do use the Pro Bike only for its intended use, as described in this manual.

### Do Not

- Do not let unsupervised children operate your Pro Bike.
- Do not use without athletic shoes.
- Do not use in rainy weather outdoors, or in an enclosed pool environment.
- Do not drop or insert any object, hands, or feet into any opening, or underneath your Pro Bike.
- Do not attempt to remove any shrouds or modify your Pro Bike.

## WARNING

Your Star Trac Pro Bike is designed for aerobic exercise in a commercial or consumer environment.

Please check with your physician prior to beginning any exercise program.

Do not push yourself to excess. Stop if you are feeling faint, dizzy, or exhausted. Use common sense when cycling.

Read the Owner's Manual in its entirety before operating your cycle.

Failure to obey this warning can result in injury or death.

## VEILIGHEIDSINSTRUCTIES

Deze veiligheidsinstructies zijn aan u gericht als de eigenaar van de Star Trac Pro Bikes. Train uw leden en fitness-personeel om dezelfde veiligheidsinstructies te volgen.

### Doe Dit Wel

- Moedig uw leden aan om hun gezondheids- of fitnessprogramma met een geneeskundige te bespreken.
- Stop met de fiets als u zich duizelig voelt of het gevoel heeft dat u flauwvalt.
- Verricht regelmatig preventief onderhoud.
- Begin langzaam totdat u een comfortabel en veilig niveau heeft bereikt.
- Gebruik het apparaat alleen voor het doel waarvoor het bestemd is en zoals in dit handboek beschreven.

### Doe Dit Neit

- Laat kinderen niet zonder toezicht de fiets bedienen.
- Plaats uw voeten niet onder uw fiets.
- Gebruik de fiets niet zonder sportschoenen.
- Niet buiten in regenachtig weer gebruiken of in een omgeving met een overdekt zwembad.
- Laat nooit objecten in het apparaat vallen en steek geen objecten, handen of voeten in welke opening dan ook of onder het apparaat.
- Verwijder nooit afschermingen en verander het apparaat niet.

## WAARSCHUWING

Uw Star Trac Pro Bike is ontworpen voor aerobics in een commerciële of consumentenomgeving.

Vraag advies aan uw arts voordat u met een fitnessprogramma begint.

Vraag niet teveel van uzelf. Stop als u het gevoel heeft dat u flauw gaat vallen, als u duizelig bent of uitgeput. Gebruik uw gezonde verstand bij het stappen. Lees de gebruikshandleiding helemaal door voordat u uw fiets gebruikt.

## CONSIGNES DE SÉCURITÉ

Ces consignes de sécurité sont destinées au propriétaire du Vélo d'exercice Star Trac. Veuillez enseigner ces consignes à tous vos membres et employés.

### À Faire

- Encouragez vos membres à discuter de leur programme de santé ou d'exercice avec un médecin.
- Arrêtez tout exercice sur le vélo si vous éprouvez un étourdissement ou une défaillance.
- Effectuez régulièrement un entretien préventif.
- Exercez-vous lentement jusqu'à ce que vous vous sentiez à l'aise et en sécurité.
- N'utilisez cet appareil que dans le but pour lequel il est conçu.

### À Ne Pas Faire

- Ne laissez pas des enfants utiliser le vélo sans surveillance.
- Ne placez pas vos pieds sous le vélo.
- Ne permettez à personne de s'exercer sans chaussures athlétiques.
- N'utilisez pas l'appareil à l'extérieur par temps pluvieux ou à proximité d'une piscine.
- N'insérez jamais la main, le pied ou un objet dans les ouvertures de l'appareil, ni sous l'appareil.
- Ne modifiez jamais cet appareil et ne retirez aucun de ses éléments protecteurs.

## MISE EN GARDE

Votre Vélo Star Trac est conçu pour l'exercice d'aérobic dans un contexte commercial ou à la maison.

Veuillez consulter votre médecin avant d'entreprendre tout programme d'exercice.

Évitez tout exercice excessif. Arrêtez si vous éprouvez un étourdissement, une défaillance ou de la fatigue. Fiez-vous à votre bon sens. Lisez attentivement la notice d'utilisation dans son intégralité avant d'utiliser votre vélo.

## SICHERHEITSVORSCHRIFTEN

Diese Sicherheitshinweise sind an Sie, den Besitzer des Fitness-Bikes von Star Trac gerichtet. Bitte weisen Sie Ihre Mitglieder und Mitarbeiter an, sich an die folgenden Sicherheitsvorschriften zu halten.

### Sie Sollten

- Ihren Mitgliedern nahelegen, ihr Gesundheitsprogramm oder Fitneß-Training mit einem Arzt zu besprechen.
- Die Benutzung des Fitneß-Bikes beenden, wenn Benommenheit oder Schwindel auftritt.
- Das Gerät regelmäßig warten.
- Langsam trainieren, bis Sie sicher mit dem Gerät umgehen können.
- Dieses Gerät nur für den vorgesehenen Zweck gemäß der Beschreibung in diesem Handbuch verwenden.

### Sie Sollten Niemals

- Kinder das Fitneß-Bike unbeaufsichtigt benutzen lassen.
- Die Füße unter das Fitneß-Bike stellen.
- Die Benutzung des Fitneß-Bikes ohne die passenden Sportschuhe zulassen.
- Das Gerät bei Regenwetter im Freien oder in einem Hallen-bzw, überdachten Schwimmbad verwenden.
- Gegenstände in eine Öffnung des Geräts stecken oder darunter fallen lassen oder Hände bzw. Füße unter das Gerät halten.
- Abdeckungen abnehmen oder das Gerät ändern.

## WARNUNG

Das Fitness-Bike von Star Trac ist für das Aerobik-Training in einem kommerziellen oder Verbraucherumfeld vorgesehen.

Bitte konsultieren Sie Ihren Arzt, bevor Sie mit einem Trainingsprogramm beginnen.

Überanstrengen Sie sich nicht. Hören Sie auf, wenn Schwindel, Benommenheit oder Erschöpfung eintreten. Gehen Sie beim Training vernünftig vor. Lesen Sie bitte das Benutzerhandbuch vor Verwendung des Fitneß-Bikes vollständig durch.

## ISTRUZIONI DI SICUREZZA

Queste indicazioni sono indirizzate ai proprietari dello Star Trac cyclette. Chiedete a tutti i membri della vostra palestra e al vostro staff di seguire queste istruzioni di sicurezza.

### Da Fare

- Incoraggiate i membri della vostra palestra a discutere il loro programma o regime di allenamento con uno specialista medico.
- Fermate lo cyclette se avete dei capogiri o vi sentite svenire.
- Eseguite la manutenzione regolarmente.
- Esercitatevi lentamente fino a quando raggiungete un livello confortevole e sicuro.
- Usate questo attrezzo solo per l'uso inteso, come descritto in questo manuale.

### Da Non Fare

- Non permettete a bambini di usare lo cyclette senza sorveglianza.
- Non inserite i piedi sotto lo cyclette.
- Non usate lo cyclette se non calzate scarpe da ginnastica.
- Non usatelo all'aperto quando piove o vicino ad una piscina coperta.
- Non lasciate cadere oggetti e non inserite mani o piedi nelle aperture o al di sotto di questo attrezzo.
- Non rimuovete nessun coperchio o modificate questo attrezzo.

## ATTENZIONE

Lo Star Trac Cyclette è stato progettato per l'esercizio aerobico in un ambiente commerciale o domestico.

Consultatevi con il vostro medico di famiglia prima di intraprendere un programma di esercizi.

Siate coscienti dei vostri limiti. Fermatevi se avete dei capogiri, vi sentite svenire o siete esausti. Usate il vostro buon senso quando usate lo cyclette. Leggete tutto il manuale delle istruzioni prima di usare lo cyclette.

## INSTRUÇÕES DE SEGURANÇA

Estas observações de segurança destinam-se à você, proprietário da bicicleta Star Trac. Treine todos os membros e funcionários que utilizarão o equipamento para que sigam estas instruções de segurança.

### Faça

- Estimule seus usuários para que discutam seus programas de saúde ou de exercícios com um profissional de saúde.
- Pare de usar a bicicleta se você se sentir fraco ou com tontura.
- Faça manutenção preventiva regularmente.
- Faça o exercício lentamente até que você alcance um nível de conforto e segurança.
- Utilize este equipamento única e exclusivamente para o seu devido fim, conforme descrito neste manual.

### Não Faça

- Não permita que crianças operem a bicicleta sem supervisão de um adulto.
- Não coloque seus pés embaixo da bicicleta.
- Não utilize a bicicleta sem calçar tênis.
- Não use este equipamento ao ar livre, em dias chuvosos ou em um ambiente de piscina interna.
- Nunca deixe cair ou introduza nenhum objeto, as mãos ou pés em nenhuma abertura do equipamento ou debaixo deste.
- Não remova nenhum protetor ou modifique este equipamento.

## ADVERTÊNCIA

A sua bicicleta Star Trac foi projetada para exercício aeróbico em um ambiente comercial ou residencial.

Faça um exame físico com seu médico antes de iniciar qualquer programa de exercícios.

Não abuse. Para se estiver sentindo tontura, fraqueza ou exaustão. Use bom senso quando se exercitar. Leia o manual do proprietário por completo antes de operar a sua bicicleta.

## INSTRUCCIONES DE SEGURIDAD

Estas notas de seguridad van dirigidas a Vd. Como propietario del bicicleta Star Trac. Haga que todos los usuarios y preparadores físicos cumplan estas instrucciones de seguridad.

### Qué Hacer

- Anime a sus miembros a que discutan su programa de salud o régimen de ejercicio con un profesional de la salud.
- Detenga el escalón si se nota desfallecido o mareado.
- Realice un mantenimiento preventivo de manera regular.
- Haga ejercicio despacio hasta alcanzar un nivel de comodidad y seguridad.
- Utilice este producto sólo para los usos indicados, tal como se describe en este manual.

### Qué No Hacer

- No permita que los niños utilicen el bicicleta sin supervisión.
- No ponga los pies debajo del bicicleta.
- No permita su uso sin calzado deportivo.
- No lo utilice en el exterior con tiempo lluvioso o en un recinto cerrado con piscina.
- No deje caer ni introduzca ningún objeto, manos o pies en ninguna abertura del aparato o debajo del mismo.
- No quite ninguna cubierta ni modifique este equipo.

## ADVERTENCIA

Su bicicleta Star Trac está diseñado para realizar ejercicio aeróbico en un entorno comercial o en forma individual.

Consulte a su médico antes de empezar cualquier programa de ejercicio.

No se exceda. Interrumpa el ejercicio si se nota desfallecido, mareado o agotado. Utilice el sentido común al usar este ararato. Lea el manual del propietario en su totalidad antes de poner en marcha el escalón.



## SIKKERHEDSINSTRUKTIONER

Disse sikkerhedsinstruktioner henvendes til ejeren af Star Trac cykel. Sørg venligst for, at alle medlemmer og alt kondipersonale kender og følger disse sikkerhedsregler.

### Råd

- Medlemmer bør opfordres til at tale om deres helseprogram eller kondiregime med en læge.
- Stig af cyklen, hvis du bliver mat i kroppen eller svimmel.
- Foretag forebyggende vedligeholdelse med regelmæssige mellemrum.
- Gør øvelserne langsomt, indtil du når et behageligt og sikkert niveau.
- Udstyret bør udelukkende bruges til det formål, det er beregnet til ifølge denne brugsanvisning.

### Advarsler

- Tillad ikke børn uden opsyn at bruge cyklen.
- Sæt ikke fødderne under cyklen.
- Brug ikke cyklen uden kondisko.
- Brug ikke cyklen udendørs i regnvejrs eller i et indelukket område med svømmebassin.
- Undgå at tabe eller at stikke genstande, hænder eller fødder ind i en åbning i eller under udstyret.
- Undlad at fjerne afskærmning eller forandre udstyret på nogen måde.

### ADVARSEL

Din Star Trac cykel er konstrueret til konditræning i et erhvervseller forbrugermiljø.

Vær venlig at rådføre dig med din læge, før du påbegynder et kondiprogram.

Du må ikke overanstrenge dig alt for meget. Stop hvis du føler dig mat i kroppen, svimmel eller udmattet. Brug sund fornuft, når du cykler. Vær venlig at læse hele brugsanvisningen, før du stiger på cyklen.

**(CHINESE SAFETY INSTRUCTIONS HERE)**

***(JAPANESE SAFETY INSTRUCTIONS HERE)***

# ASSEMBLY AND SETUP

## PRO UPRIGHT BIKE ASSEMBLY AND SETUP

Use the following procedures to unpack and assemble your *STAR TRAC PRO UPRIGHT BIKE*.

### UNPACKING

Open the shipping carton, remove all parts from the carton and foam inserts, and verify that the following parts are included in your shipment:

Description	Qty.	Description	Qty.
Bike Frame	1	Screw, Flat Head, M6 X 16	4
Display Console Assembly	1	Screw, Socket Head, M6 X 10	1
Seat Post Assembly	1	Screw, Socket Head, M4 X 20	2
Front Foot	1	Wrench, Hex, 6mm	1
Rear Foot	1	Wrench, Hex, 4mm	1
Pedals (set of two)	1	Multi-end Wrench, 10mm, 12mm, 15mm	1
Screw, Button Head, M10 X 30	8	Wrench, Hex, 3mm	1

Take time now to enter your Pro Bike serial number in the space below. If parts are missing, or if you have any operational questions, please call Star Trac's Service Department at (800) 503-1221; have your serial number ready.

Serial No. \_\_\_\_\_

### ASSEMBLY

#### 1. Install the Front Foot

**NOTE:** The front foot assembly has wheels attached to the front edge. Be sure the wheels face forward when installing the front foot assembly.

Stand the bike frame upright and place the front foot assembly under the frame, aligning the holes in the foot with the holes in the frame.

Using the 6mm hex wrench and four M10 X 30 button head screws, secure the front foot assembly to the frame. Tighten all four screws securely.

#### 2. Install the Rear Foot

**NOTE:** Be sure the rear foot assembly is positioned with the curved edge facing forward (similar to the front foot).

Lift up the rear of the bike frame and place the rear foot assembly in position under the frame, aligning the holes in the foot with the holes in the frame.

Using the 6mm hex wrench and four M10 X 30 button head screws, secure the rear foot assembly to the frame. Tighten all four screws securely.



Step 1

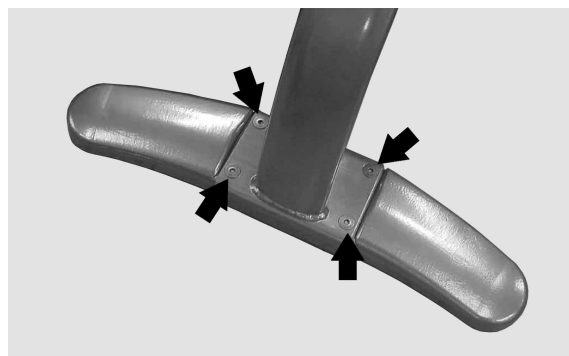

Step 2

### 3. Install the Seat Post

Carefully slide the seat post into the seat tube.

Pull out on the seat release knob, and slide the seat post fully into the seat tube. Release the seat release knob.

Install two M4 X 20 socket head screws into the seat sleeve to secure it. Tighten the screws securely using the 3mm hex wrench.

Install the M6 X 10 socket head screw into the hole in the back of the seat tube. Using the 4mm hex wrench, tighten the screw securely.

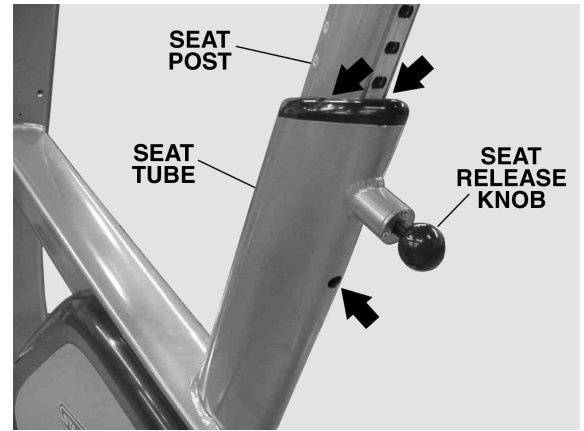

Step 3

### 4. Install the Display Console

**NOTE:** It may be necessary to have one person support and position the display console while a second person makes the cable connection.

Carefully slide the display console neck approximately one inch onto the neck brackets of the bike frame. With the console partially supported by the neck brackets, plug the display console cable into the receptacle on the bike frame.

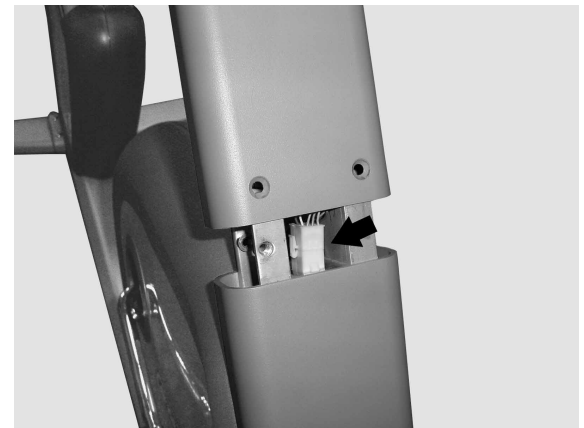

Step 4A

**CAUTION:** Be careful not to pinch your fingers between the console neck and the bike frame when sliding the console into place.

**CAUTION:** Be sure not to pinch the display cable between the console neck and the bike frame.

Carefully slide the console neck onto the neck brackets until it is fully seated. Secure the display console to the frame with four M6 X 16 flat head screws (two screws in front side and two screws in back side). Using the 4mm hex wrench, tighten all four screws securely.

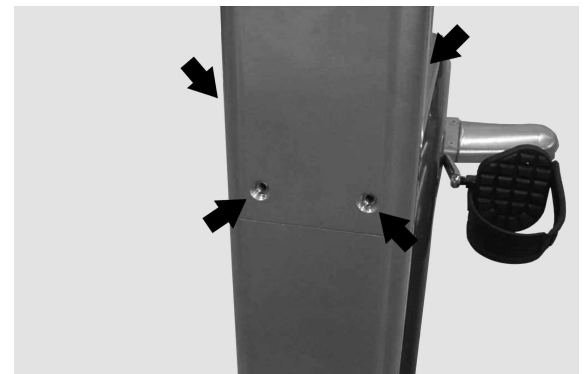

Step 4B

### 5. Install the Pedals

Install the pedals on the pedal cranks using a 5/8-inch open-end wrench. Tighten the pedals securely.

**NOTE:** Turn the left pedal spindle counterclockwise when threading into the crank arm; turn the right pedal spindle clockwise when threading into the crank arm.



Step 5

## 6. Leveling the Bike

Place the bike on the floor in the position in which it will be used. Use the leveling adjusters (located on the underside of the front and rear feet) to compensate for uneven floor surfaces and to eliminate wobbling.

You have now completed assembly of your *STAR TRAC PRO UPRIGHT BIKE*.

# PRO RECUMBENT BIKE ASSEMBLY AND SETUP

Use the following procedures to unpack and assemble your *STAR TRAC PRO RECUMBENT BIKE*.

## UNPACKING

Open the shipping carton, remove all parts from the carton and foam inserts, and verify that the following parts are included in your shipment:

Description	Qty.	Description	Qty.
Bike Frame	1	Screw, Socket Head, M10 X 10	4
Display Console Assembly	1	Screw, Flat Head, M6 X 20	4
Seat Frame Assembly	1	Washer, Locking, M10	4
Front Foot	1	Wrench, Hex, 6mm	1
Rear Foot	1	Wrench, Hex, 4mm	1
Pedals (set of two)	1	Multi-end Wrench, 10mm, 12mm, 15mm	1
Screw, Button Head, M10 X 30	8		

Take time now to enter your Pro Bike serial number in the space below. If parts are missing, or if you have any operational questions, please call Star Trac's Service Department at (800) 503-1221; have your serial number ready.

Serial No. \_\_\_\_\_

## ASSEMBLY

### 1. Install the Front Foot

**NOTE:** The front foot assembly has wheels attached to the front edge. Be sure the wheels face forward when installing the front foot assembly.

Stand the bike frame upright on the floor. Raise the front end of the bike frame by placing a 2-inch Styrofoam spacer under the front main beam. Insert four M10 X 30 button head screws through the holes in the front foot attachment plate.

Position the front foot assembly under the attachment plate, aligning the holes in the foot with the four screws.

Using the 6mm hex wrench, secure the front foot assembly to the frame with the four M10 X 30 button head screws. Tighten all four screws securely.

### 2. Install the Rear Foot

**NOTE:** Be sure the rear foot assembly is positioned with the curved edge facing forward (similar to the front foot).

Lift up the rear of the bike frame and place the rear foot assembly in position under the frame, aligning the holes in the foot with the holes in the frame.

Using the 6mm hex wrench and four M10 X 30 button head screws, secure the rear foot assembly to the frame. Tighten all four screws securely.

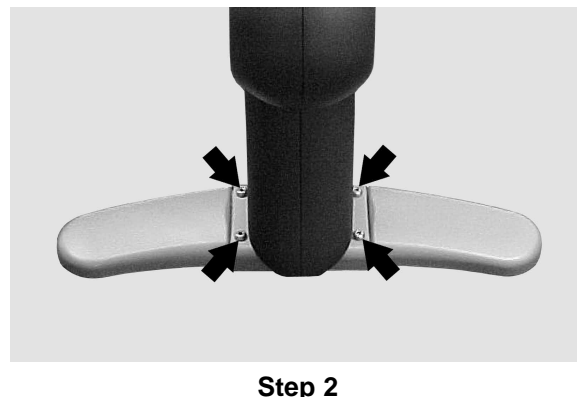
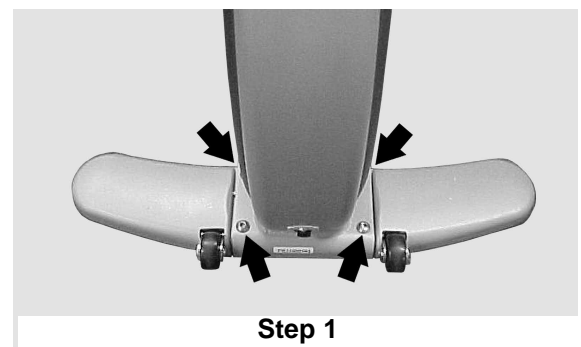

### 3. Install the Seat Frame

Carefully position the seat frame over the seat carriage on the bike frame, aligning the attachment holes in the sides of the seat frame with the holes in the seat carriage.

Using the 6mm hex wrench and four M10 X 10 socket head screws, secure the seat frame to the seat carriage. Tighten all four screws securely.



Step 3

### 4. Install the Display Console

**NOTE:** It may be necessary to have one person support and position the display console while a second person makes the cable connection.

Carefully slide the display console neck approximately one inch onto the neck brackets of the bike frame. With the console partially supported by the neck brackets, plug the display console cable into the receptacle on the bike frame.

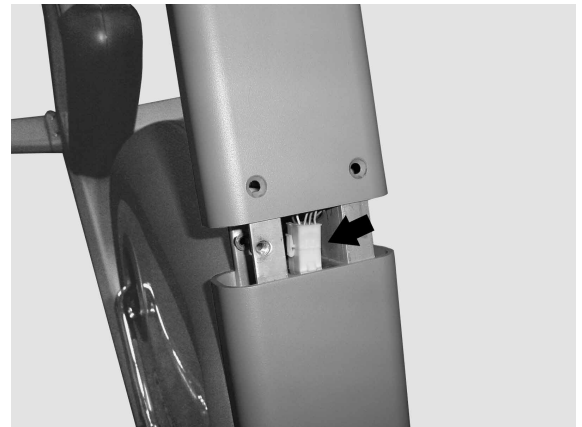

Step 4A

**CAUTION:** Be careful not to pinch your fingers between the console neck and the bike frame when sliding the console into place.

**CAUTION:** Be sure not to pinch the display cable between the console neck and the bike frame.

Carefully slide the console neck onto the neck brackets until it is fully seated. Secure the display console to the frame with four M6 X 16 socket head screws (two screws in front side and two screws in back side). Using the 4mm hex wrench, tighten all four screws securely.

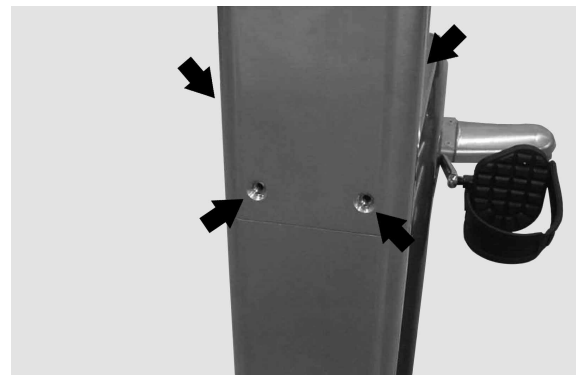

Step 4B

### 5. Install the Pedals

Install the pedals on the pedal cranks using a 5/8-inch open-end wrench. Tighten the pedals securely.

**NOTE:** Turn the left pedal spindle counterclockwise when threading into the crank arm; turn the right pedal spindle clockwise when threading into the crank arm.



Step 5

## 6. Leveling the Bike

Place the bike on the floor in the position in which it will be used. Use the leveling adjusters (located on the underside of the front and rear feet) to compensate for uneven floor surfaces and to eliminate wobbling.

## 7. Adjusting the Armrests

If needed, the arm rest angle may be adjusted by turning a screw under the arm rest. Using the 4mm hex wrench, turn the screw clockwise to lower or counterclockwise to raise the arm rest angle. Both arm rests should be adjusted to the same angle, slightly above level.



You have now completed assembly of your **STAR TRAC PRO RECUMBENT BIKE**.

# OPERATING INSTRUCTIONS

Operating the **STAR TRAC PRO BIKE** is very easy. Simply mount the bike, begin pedaling, and press QUICK START. Learning the features and incorporating the **STAR TRAC PRO BIKE** into your members' fitness programs is just as easy. In this chapter, you will learn the display function and how to get the most out of every **STAR TRAC PRO BIKE** workout.

**IMPORTANT:** Before operating the bike, you must be familiar with the following equipment limitations:

- **Maximum Weight:** Your **STAR TRAC PRO BIKE** is designed for a maximum user weight of 350 lbs/159 kg. DO NOT exceed the maximum user weight.

## SEAT ADJUSTMENTS

Proper seat positioning helps ensure maximum exercise efficiency and comfort, while reducing the risk of injury. Always adjust the seat position prior to beginning your workout.

**IMPORTANT:** When adjusting the seat height for either bike, your knee should never completely “lock out” during any portion of the cycle pattern.

### Adjusting Seat Height (Pro Upright Bike)

When sitting on the seat of your Pro Upright Bike, your knees should be almost fully extended when the pedals are at the lowest point of their rotation. To adjust the seat height:

**NOTE:** When raising the seat, the seat will ratchet up when pulled. When lowering the seat, you must use the seat release knob.

With the pedal at its lowest point of rotation, stand on the pedal with your knee slightly bent. To raise the seat, carefully lift up on the “nose” of the saddle and raise the seat to the desired position (the seat release knob does not need to be pulled out). To lower the seat, carefully pull out on the seat release knob (located at the rear of the seat tube) and lower the seat to the desired position. Release the knob, ensuring that the spring retracts to its original position, and that the seat stays firmly in place.

Note your height adjustment (shown on the front of the seat post) for future reference. This number is the highest number visible on the seat post.



## Adjusting Seat Position (Pro Recumbent Bike)

When sitting on the seat of your Pro Recumbent Bike, your knees should be almost fully extended when the pedals are at the lowest point of their rotation. To adjust the seat position:

Sit on the seat and grasp the seat adjustment handle (located under the seat). Lift up on the handle, and slide the seat forward or backward on the seat carriage to the closest available position that allows your knees to be slightly bent toward the lower pedal. Release the handle, ensuring that the spring retracts to its original position, and that the seat stays firmly in place.

Note your height adjustment (shown on the top of the seat rail either in front of or behind the seat) for future reference.



## PEDAL STRAP OPERATION

The pedal straps should be adjusted to hold each foot comfortably but firmly on the pedal. Place your foot on the pedal, then adjust the pedal strap as necessary. Pull the free end of the strap down to tighten. Press the release button to loosen.



## HEART RATE BAR OPERATION (PRO RECUMBENT BIKE)

After adjusting the seat to a comfortable riding position, grasp the heart rate grip and press the red release button with your thumb. Pull the heart rate bar out to a comfortable position, and release the button. BE SURE to return the heart rate bar to its original position before dismounting the bike.



## DISPLAY PANEL FEATURES

Your Star Trac Pro Bike is equipped to provide you and your users unlimited exercise opportunities. Experiment with its features to find the right combination for your fitness regimen. The Display panel provides the operating controls and display elements described in the following paragraphs, and is consistent for both the Pro Upright and Pro Recumbent bikes.



**QUICK START Key:** Enables the bike for manual operation using a default weight of 155 pounds, a default LEVEL of "1", and a default time limit of 99 minutes.

**NOTE:** Default time and weight are adjustable through Manager/Maintenance mode. See Chapter 7 for details.



**Numeric Keypad:** Allows you to enter specific values for program parameters during program setup. During a program, these keys may be used to change difficulty level.



**OK Key:** (part of numeric keypad) Allows you to confirm selections during program setup and operation.



**ARROW Key:** (part of numeric keypad) Allows you to make corrections to values entered during program setup.



**Increase LEVEL Key:** Increases the difficulty level from **1** (least difficulty) to **20** (greatest difficulty), in one-level increments. Current level setting is shown in the LEVEL display window.



**Decrease LEVEL Key:** Decreases the difficulty level from **20** (greatest difficulty) to **1** (least difficulty), in one-level increments. Current level setting is shown in the LEVEL display window.



**Fan Key:** Allows you to control the speed of the personal cooling fan, either OFF, HIGH or LOW.



**SCROLL Keys:** Scrolls the upper and lower data information windows between the three available data displays.

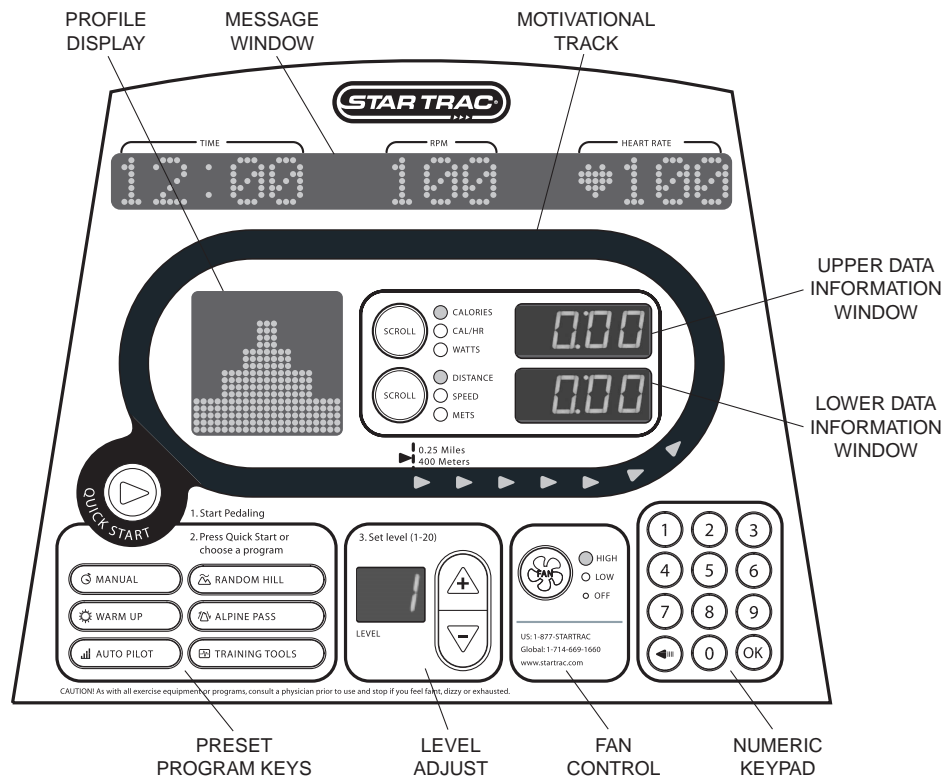

**Preset Program Keys:** Allow you to access a desired preset workout program.

**Upper Data Information Window:** Shows current and aggregate data related to your workout. Pressing the associated SCROLL key scrolls between the following displays:

- CALORIES - Shows your aggregate caloric expenditure thus far in your workout.
- CAL/HR - Shows your average caloric expenditure per hour thus far in your workout.
- WATTS - Shows your aggregate watts expenditure thus far in your workout.

**Lower Data Information Window:** Shows current and aggregate data related to your workout. Pressing the associated SCROLL key scrolls between the following displays:

- DISTANCE - Shows the total number of miles or kilometers you have ridden thus far.
- SPEED - Shows the speed at which you are currently pedaling, in miles-per-hour or kilometers-per-hour.
- METS - Shows your aggregate METS expenditure thus far in your workout.

**Profile Display:** Traces your progress through each of the programs and allows you to anticipate changes in terrain. Display elements illuminate from left to right across the bottom of the display to indicate your progress through the course. At each step, display elements illuminate in columns to indicate your ascent up the gradient that is in effect.

**Motivational Track:** Shows your progress counter clockwise around 1/4-mile (400-meter) course, starting from the bottom center.

**Message Window:** Provides informational messages, prompts during program setup, feedback during your workout, notification when your workout is complete, and scrolling summarized workout data after your workout. During your workout, the Information Window shows the following data:

- **TIME** - Shows the duration of your workout thus far in minutes and seconds.
- **RPM** - Shows the current speed at which you are pedaling in revolutions-per-minute.
- **HEART RATE** - Shows your current heart rate in beats-per-minute (BPM) while wearing the heart rate strap or grasping the heart rate grips.

Depending on the program completed and bike settings as set in Manager/Maintenance mode, workout data may include:

- Time consumed
- Average minutes per mile/kilometer
- Calories expended
- Average RPM
- Distance traveled - miles or kilometers
- Average watts
- Average speed - mph or kph
- Average METS
- Average calories expended per hour
- Average heart rate

## **HINTS AND TIPS FOR GETTING STARTED**

The following hints and tips will assist in training your users to maximize the fitness benefits of your STAR TRAC PRO BIKE.

- **Pedal at a rate that feels comfortable and most natural, yet is sufficiently vigorous to get a good cardio workout.**
- **Try different pedaling rhythms.** In manual operation, vary your pedaling speed from slow to fast, then back to slow. As you become more comfortable with your bike, try pedaling faster, varying the resistance LEVEL, or using the preset programs.
- **Watch the Graphic Display to anticipate terrain changes.** When you use the preset programs, the display shows changes in terrain as tall or short columns.

## **VIEWING WORKOUT DATA DURING A PROGRAM**

Workout data is shown in three windows on the Pro Bike Display Panel: the Message Window (located at the top of the Display Panel) and the Upper and Lower Data Information Windows (located inside the Motivational Track, to the right of the Profile Window).

Information shown in the Message Window during a workout includes elapsed time, revolutions per minute (RPM's), and heart rate (HR), when in use. After the workout is complete, workout summary information is shown in the Message Window.

The Message Window also displays important instructions and cues throughout the workout.

The Upper and Lower Data Information Windows also display information during a workout.

### **To view workout data during your workout:**





1. Press the Upper Data Display Window SCROLL key to view the following workout data (the current data display is indicated by an LED next to the parameter name):
  - **CALORIES** - Shows your aggregate caloric expenditure thus far in your workout.
  - **CAL/HR** - Shows your average caloric expenditure per hour thus far in your workout.
  - **WATTS** - Shows your current watts expenditure during that specific time of the workout.
2. Press the Lower Data Display Window SCROLL key to view the following workout data (the current data display is indicated by an LED next to the parameter name):
  - **DISTANCE** - Shows the total number of miles or kilometers you have ridden thus far.
  - **SPEED** - Shows the speed at which you are currently pedaling, in miles-per-hour or kilometers-per-hour.
  - **METS** - Shows your current METS expenditure during that specific time of the workout.

## COOLDOWN CYCLE

In most programs, once you have completed your workout, the bike enters a two-minute Cooldown cycle.

**NOTE:** The Pro Bike software is programmed to properly decrease pedaling resistance to provide a cooldown.

### To operate the bike during Cooldown:

1. You can adjust the difficulty LEVEL during Cooldown.
  - Use the ... keys to enter a difficulty LEVEL (from 1 to 20); or press the  or  key, as desired, to increase or decrease the difficulty LEVEL in 1 unit increments.
  - When the desired difficulty LEVEL has been entered, press the  key to accept the displayed LEVEL.
2. When the Cooldown cycle ends, your workout summary displays in the Information Window. If you wish to exit the Cooldown cycle before it ends automatically, stop pedaling.

## USING THE PERSONAL FAN

The **STAR TRAC PRO BIKE** is equipped with a built-in personal fan to increase your comfort during a workout. You can control the fan speed during your workout.

### To operate the personal fan:

- Press the  key, as necessary, to cycle the personal fan from OFF to HIGH to LOW to OFF. An LED indicator lights to show the currently selected fan speed.
- The fan remains set at the set speed if you pause your program.
- The fan turns off automatically if you exit your workout, or when you complete your workout program.

## HEART RATE MONITORING

Heart rate monitoring allows you to determine if your workout is too challenging or not challenging enough. Monitoring heart rate is easy with the **STAR TRAC PRO BIKE**. You may use a heart rate strap (not provided with the Pro Bike), or you can simply grasp the silver contact heart rate grips.

**NOTE:** The Heart Rate monitor is not a medical test, nor is it designed as a medical test. It is simply a guide to target heart rate training. Please consult with your physician prior to engaging in any strenuous physical activity.

**IMPORTANT:** The manufacturer does not warrant the heart rate system **performance** on this product, as the heart rate system performance varies, based on a user's physiology, fitness level, age, method of use and other factors. Furthermore, the heart rate system is not for medical use.

## CONTACT HEART RATE MONITORING

You may use the heart rate contact grips to automatically check your heart rate. Just follow these steps.

1. Grasp the stainless steel heart rate contact grips; you do not have to squeeze tightly.
2. It may take from 30 to 60 seconds for the heart rate system to acquire and display your heart rate.
3. When your heart rate has been acquired, the  indicator, and your heart rate in beats per minute (BPM) displays in the HEART RATE field of the Information Window.
4. Release the Heart Rate grips if you wish to remove your heart rate reading from the display.

## CHEST STRAP HEART RATE MONITORING

You may use the heart rate strap to automatically check your heart rate. Just follow these steps:

1. Before beginning your workout, or during a pause, moisten the back of the transmitter on the heart rate strap (not included). Place the strap snugly around your chest with the transmitter resting directly over your sternum.







2. When your heart rate has been acquired, the  indicator and your heart rate in beats per minute (BPM) display in the HEART RATE field of the Information Window.
3. Remove the heart rate strap, if you wish to remove your heart rate reading from the display.

**NOTE:** The performance of the transmitter may be affected by body types, body oils, metal in clothing, and outside electrical interference. Always be sure that the transmitter and skin are in good contact. Avoid operating other electrical equipment near your treadmill when you use the heart rate strap.

## QUICK START

Quick Start lets you begin your workout by simply pressing one key, or by pedaling for approximately 10 seconds without pressing any key. Quick Start uses a default weight of 155 pounds (70 kg), a difficulty LEVEL of 1, and a time limit of 99 minutes. YOU control resistance LEVEL during the entire program.







### To operate the Quick Start program:

1. Mount the bike (please refer to “SEAT ADJUSTMENTS” section), begin pedaling, and press the QUICK START key.
2. If desired, you can use the personal fan during your workout (see “Using the Personal Fan” for details).
3. You can adjust the resistance LEVEL during the program, using either of the following methods.
  - Use the ... keys to enter a resistance level (from 1 to 20). When the desired level has been entered, press the  key to confirm the resistance level.
  - Press the  or  key, as desired, to increase or decrease the resistance LEVEL in 1 unit increments.
4. You can scroll through workout data during the program (see “Viewing Workout Data During a Program” for details).
5. If you wish to pause the program, stop pedaling. The bike will enter pause mode and display your workout results for one entire cycle.
6. When you have reached your workout goal, the bike enters the Cooldown cycle (see “Cooldown Cycle” for details). If you wish to exit the program before you have reached your workout goal, stop pedaling and allow the Pause timer to expire. If you wish to skip the Cooldown cycle, press the  key to view your workout summary.

## PRESET PROGRAMS

The **STAR TRAC PRO BIKES** offer 10 preset programs to add variety and challenge to your workout, including the advanced TRAINING TOOLS function that provides four cardio-intensive training programs and a Fitness Test.

















Pre-set programs include:

- |  |   |
|--|---|
|  | Allows the user to pre-program a time goal and user weight. Resistance is determined by the user during the program.                            |
|  | Seven-minute program with three resistance level settings designed to properly warm-up the muscles prior to working out.                        |
|  | Allows the user to positively increase the level of resistance by increasing pedaling speed (rpm's). No keys to press with this one!            |
|  | 200 varied hill programs that allow the user to pre-program a time goal, user weight and program level (from 1 to 20).                          |
|  | An intense 3-peak ride that allows the user to pre-program a time goal, user weight and program level (from 1 to 20).                           |
|  | Our advanced program that offers the user the ability to train in specific HR zones or watt ranges, or to complete the integrated Fitness Test. |

# WARM UP PROGRAM

The WARM UP program provides a seven-minute program with three resistance level settings designed to properly warm-up the muscles prior to working out.







## To operate the WARM UP program:

1. Mount the bike (please refer to “SEAT ADJUSTMENTS” section), begin pedaling, and press the  key.
2. You are prompted to enter your weight. The bike displays a default weight of 155 pounds (70 kg). You may enter any weight from 0 to 350 pounds (0 to 159 kg).
  - Use the ... keys to enter your current weight; or press the  or  key, as necessary, to increase or decrease the displayed weight in 1 pound (or 1 kg) increments.
  - When your correct weight has been entered, press the  key to accept the displayed value.
3. You are prompted to enter a difficulty LEVEL.
  - Use the ... keys to enter a difficulty level (1 = beginners to working out, 2 = intermediate-level users, 3 = advanced users) or press the  or  key, as desired, to increase or decrease the difficulty LEVEL in 1 unit increments.
  - When the desired difficulty LEVEL has been entered, press the  key to accept the displayed LEVEL.
4. If desired, you can use the personal fan during your workout (see “Using the Personal Fan” for details).
5. You can adjust the resistance LEVEL during the program, using either of the following methods:
  - Use the ... keys to enter a resistance level (from 1 to 20). When the desired level has been entered, press the  key to confirm the resistance level.
  - Press the  or  key, as desired, to increase or decrease the resistance LEVEL in 1 unit increments.
6. You can scroll through workout data during the program (see “Viewing Workout Data During a Program” for details).
7. If you wish to pause the program, stop pedaling. The bike will enter pause mode and display your workout results for one entire cycle.
8. When you have reached your workout goal, the bike provides a Workout Summary.











# MANUAL PROGRAM

The MANUAL program allows the user to pre-program a time goal and user weight. Resistance is determined by the user during the program.

## To operate the MANUAL program:

1. Mount the bike (please refer to “SEAT ADJUSTMENTS” section), begin pedaling, and press the  key.
2. You are prompted to enter your weight. The bike displays a default weight of 155 pounds (70 kg). You may enter any weight from 0 to 350 pounds (0 to 159 kg).
  - Use the ... keys to enter your current weight; or press the  or  key, as necessary, to increase or decrease the displayed weight in 1 pound (or 1 kg) increments.
  - When your correct weight has been entered, press the  key to accept the displayed value.
3. You are prompted to enter a time goal.

The default time is 20 minutes. You may enter any time from 1 to 99 minutes.

  - Use the ... keys to enter your desired time goal; or press the  or  key, as necessary, to increase or decrease the displayed value in 1 minute increments.
  - When your desired goal has been entered, press the  key to accept the displayed value.
4. You are prompted to enter a difficulty LEVEL.
  - Use the ... keys to enter a difficulty level (from 1 to 20) or press the  or  key, as desired, to increase or decrease the difficulty LEVEL in 1 unit increments.
  - When the desired difficulty LEVEL has been entered, press the  key to accept the displayed LEVEL.

5. If desired, you can use the personal fan during your workout (see “Using the Personal Fan” for details).
6. You can adjust the resistance LEVEL during the program, using either of the following methods:
  - Use the **0...9** keys to enter a resistance level (from 1 to 20). When the desired level has been entered, press the **OK** key to confirm the resistance level.
  - Press the **▲** or **▼** key, as desired, to increase or decrease the resistance LEVEL in 1 unit increments.
7. You can scroll through workout data during the program (see “Viewing Workout Data During a Program” for details).
8. If you wish to pause the program, stop pedaling. The bike will enter pause mode and display your workout results for one entire cycle.
9. When you have reached your workout goal, the bike enters the Cooldown cycle (see “Cooldown Cycle” for details). If you wish to exit the program before you have reached your workout goal, stop pedaling and allow the Pause timer to expire.

## AUTO PILOT PROGRAM

The AUTO PILOT program allows the user to positively increase the level of resistance by increasing pedaling speed (rpm’s). No keys to press with this one!

### To operate the AUTO PILOT program:

1. Mount the bike (please refer to “SEAT ADJUSTMENTS” section), begin pedaling, and press the **AUTO PILOT** key.
2. If desired, you can use the personal fan during your workout (see “Using the Personal Fan” for details).
3. You can increase the resistance LEVEL during the program by increasing your pedaling speed. Decreasing your pedaling speed will lower the resistance LEVEL.
4. You can scroll through workout data during the program (see “Viewing Workout Data During a Program” for details).
5. If you wish to pause the program, stop pedaling. The bike will enter pause mode and display your workout results for one entire cycle.
6. When you have reached your workout goal, the bike enters the Cooldown cycle (see “Cooldown Cycle” for details). If you wish to exit the program before you have reached your workout goal, stop pedaling and allow the Pause timer to expire.

## RANDOM HILL / ALPINE PASS PROGRAMS

The RANDOM HILL program offers 200 varied hill programs that allow the user to pre-program a time goal, user weight and program level (from 1 to 20). The ALPINE PASS program is an intense 3-peak ride that allows the user to pre-program a time goal, user weight and program level (from 1 to 20).

### To operate the RANDOM HILL or ALPINE PASS program:

1. Mount the bike (please refer to “SEAT ADJUSTMENTS” section), begin pedaling, and press the **RANDOM HILL** or **ALPINE PASS** key, as desired.
2. You are prompted to enter your weight. The bike displays a default weight of 155 pounds (70 kg). You may enter any weight from 0 to 350 pounds (0 to 159 kg).
  - Use the **0...9** keys to enter your current weight; or press the **▲** or **▼** key, as necessary, to increase or decrease the displayed weight in 1 pound (or 1 kg) increments.
  - When your correct weight has been entered, press the **OK** key to accept the displayed value.
3. You are prompted to enter a time goal. The bike displays a default time of 20 minutes. You may enter any time from 5 to 99 minutes.
  - Use the **0...9** keys to enter the desired time goal, or press the **▲** or **▼** key, as necessary, to increase or decrease the displayed value in 1 minute increments.
  - When your desired time goal has been entered, press the **OK** key to accept the displayed value.
4. You are prompted to enter a difficulty LEVEL.
  - Use the **0...9** keys to enter a difficulty level (from 1 to 20) or press the **▲** or **▼** key, as desired, to increase or decrease the difficulty LEVEL in 1 unit increments.
  - When the desired difficulty LEVEL has been entered, press the **OK** key to accept the displayed LEVEL.

5. If desired, you can use the personal fan during your workout (see “Using the Personal Fan” for details).
6. You can adjust the resistance LEVEL during the program, using either of the following methods:
  - Use the  $\odot \dots \ominus$  keys to enter a resistance level (from 1 to 20). When the desired level has been entered, press the  $\odot \text{OK}$  key to confirm the resistance level.
  - Press the  $\triangle$  or  $\nabla$  key, as desired, to increase or decrease the resistance LEVEL in 1 unit increments.
7. You can scroll through workout data during the program (see “Viewing Workout Data During a Program” for details).
8. If you wish to pause the program, stop pedaling. The bike will enter pause mode and display your workout results for one entire cycle.
9. When you have reached your workout goal, the bike enters the Cooldown cycle (see “Cooldown Cycle” for details). If you wish to exit the program before you have reached your workout goal, stop pedaling and allow the Pause timer to expire.

## TRAINING TOOLS PROGRAMS

The TRAINING TOOLS programs include the HEART RATE CONTROL and WATTS CONTROL programs, and the FIT TEST program. When using the HEART RATE CONTROL programs, use of the heart rate strap (rather than the heart rate grips) is recommended.

## HEART RATE CONTROL PROGRAMS

TRAINING TOOLS offers both a Dynamic Heart Rate Control program and a Constant Heart Rate Control program.

**NOTE:** For best results, use a heart rate strap. If user is wearing a heart rate strap, the bike will automatically use the data from the heart rate strap.

### To operate the Dynamic Heart Rate Control program:

This heart rate feature is designed to gradually elevate your heart rate to the upper end of your selected training range, then gradually decrease your heart rate to the lower end of your selected training range by dynamically controlling pedaling resistance. During the workout, this cycle will repeat several times until the time goal is complete, creating an interval training effect that is customized to the user’s desired heart rate training range.

During program setup, there must be at least an 18 BPM difference between the lower heart rate limit and upper heart rate limit to ensure an interval workout.

By including interval exercise in your regular aerobic program, greater effects are noticed. Your heart and muscles will adapt to the increases in demand by utilizing stored calories for energy more effectively. Dynamic Heart Rate Control may potentially result in more calories expended. It will strengthen the heart, provide stress relief and variety to a workout. This program is more effective in training the body to remove excess lactic acid from the muscles.

To calculate your training zone, use the following formulas:  
(theoretical max HR = 220 - Age)

#### Heart Rate Training Range Upper Level

$$\frac{\text{Your Theoretical Max}}{\text{Your Theoretical Max}} \times 0.75 = \frac{\text{Training Range Upper Limit}}{\text{Training Range Upper Limit}}$$

#### Heart Rate Training Range Lower Level

$$\frac{\text{Your Theoretical Max}}{\text{Your Theoretical Max}} \times 0.60 = \frac{\text{Training Range Lower Limit}}{\text{Training Range Lower Limit}}$$

**NOTE:** Calculating your theoretical maximum heart rate using age is an approximation. For more information, please contact a fitness professional or doctor.

1. Mount the bike (please refer to “SEAT ADJUSTMENTS” section), begin pedaling, and press the  $\text{TRAINING TOOLS}$  key.
2. You are prompted to select the desired TRAINING TOOLS program. Press the  $\text{1}$  key to select the Heart Rate Control program, then press the  $\text{1}$  key when prompted to select Interval Heart Rate Control.
3. You are prompted to enter your weight. The bike displays a default weight of 155 pounds (70 kg). You may enter any weight from 0 to 350 pounds (0 to 159 kg).
  - Use the  $\odot \dots \ominus$  keys to enter your current weight; or press the  $\triangle$  or  $\nabla$  key, as necessary, to increase or decrease the displayed weight in 1 pound (or 1 kg) increments.
  - When your correct weight has been entered, press the  $\odot \text{OK}$  key to accept the displayed value.
4. You are prompted to enter a time goal. The bike displays a default time of 20 minutes. You may enter any time from 5 to 99 minutes.
  - Use the  $\odot \dots \ominus$  keys to enter the desired time goal, or press the  $\triangle$  or  $\nabla$  key, as necessary, to increase or decrease the displayed value in 1 minute increments.
  - When your desired time goal has been entered, press the  $\odot \text{OK}$  key to accept the displayed value.

5. You are prompted to enter your age.
  - Use the **0...9** keys to enter your age, or press the **▲** or **▼** key, as necessary, to increase or decrease the displayed value in 1 year increments.
  - When your correct age has been entered, press the **OK** key to accept the displayed value.
6. You are prompted to enter an upper heart rate limit. The bike displays a default upper heart rate limit that is based on 80% of your theoretical maximum heart rate (220 BPM - age). You may enter any value from \_\_\_ to \_\_\_ BPM.
  - Use the **0...9** keys to enter an upper heart rate limit, or press the **▲** or **▼** key, as desired, to increase or decrease the heart rate limit in 1 BPM increments.
  - When the desired upper heart rate limit has been entered, press the **OK** key to accept the displayed value.
7. You are prompted to enter a lower heart rate limit. The bike displays a default lower heart rate limit that is based on 60% of your theoretical maximum heart rate (220 BPM - age). You may enter any value from \_\_\_ to \_\_\_ BPM.
  - Use the **0...9** keys to enter a lower heart rate limit, or press the **▲** or **▼** key, as desired, to increase or decrease the heart rate limit in 1 BPM increments.
  - When the desired lower heart rate limit has been entered, press the **OK** key to accept the displayed value.
8. If desired, you can use the personal fan during your workout (see “Using the Personal Fan” for details).
9. You can scroll through workout data during the program (see “Viewing Workout Data During a Program” for details).
10. If you wish to pause the program, stop pedaling. The bike will enter pause mode and display your workout results for one entire cycle.
11. When you have reached your workout goal, the bike enters the Cooldown cycle (see “Cooldown Cycle” for details). If you wish to exit the program before you have reached your workout goal, stop pedaling and allow the Pause timer to expire.

#### To operate the Constant Heart Rate Control program:

This heart rate feature is designed to maintain your heart rate at a constant level by controlling pedaling resistance and prompting you to pedal at a specified RPM. Please note that your heart rate may vary above and below your target heart rate during this program.

1. Mount the bike (please refer to “SEAT ADJUSTMENTS” section), begin pedaling, and press the **TRAINING TOOLS** key.
2. You are prompted to select the desired TRAINING TOOLS program. Press the **1** key to select the Heart Rate Control program, then press the **2** key when prompted to select Constant Heart Rate Control.
3. You are prompted to enter your weight. The bike displays a default weight of 155 pounds (70 kg). You may enter any weight from 0 to 350 pounds (0 to 159 kg).
  - Use the **0...9** keys to enter your current weight; or press the **▲** or **▼** key, as necessary, to increase or decrease the displayed weight in 1 pound (or 1 kg) increments.
  - When your correct weight has been entered, press the **OK** key to accept the displayed value.
4. You are prompted to enter a time goal. The bike displays a default time of 20 minutes. You may enter any time from 5 to 99 minutes.
  - Use the **0...9** keys to enter the desired time goal, or press the **▲** or **▼** key, as necessary, to increase or decrease the displayed value in 1 minute increments.
  - When your desired time goal has been entered, press the **OK** key to accept the displayed value.
5. You are prompted to enter your age.
  - Use the **0...9** keys to enter your age, or press the **▲** or **▼** key, as necessary, to increase or decrease the displayed value in 1 year increments.
  - When your correct age has been entered, press the **OK** key to accept the displayed value.
6. You are prompted to enter a target heart rate. The bike displays a default target heart rate that is based on 70% of your theoretical maximum heart rate (220 BPM - age). You may enter any value from \_\_\_ to \_\_\_ BPM.
  - Use the **0...9** keys to enter your target heart rate, or press the **▲** or **▼** key, as desired, to increase or decrease the target heart rate in 1 BPM increments.
  - When the desired target heart rate has been entered, press the **OK** key to accept the displayed value.



































7. If desired, you can use the personal fan during your workout (see “Using the Personal Fan” for details).
8. You can scroll through workout data during the program (see “Viewing Workout Data During a Program” for details).
9. If you wish to pause the program, stop pedaling. The bike will enter pause mode and display your workout results for one entire cycle.
10. When you have reached your workout goal, the bike enters the Cooldown cycle (see “Cooldown Cycle” for details). If you wish to exit the program before you have reached your workout goal, stop pedaling and allow the Pause timer to expire.

## WATTS PROGRAMS

TRAINING TOOLS offers both a Dynamic Watts Interval program and a Constant Watts program. Watts are a measurement of workload that are dependant upon the resistance of the bike and the user’s RPM.























### To operate the Watts Interval program:

This feature is designed to alternate your watts expenditure to the upper end of your selected training range, then gradually decrease it to the lower end of your selected training range by dynamically controlling pedaling resistance and prompting you to pedal at a specified RPM. During the workout, this cycle will repeat several times, creating an interval training effect that is customized to the user’s desired watts training range.

1. Mount the bike (please refer to “SEAT ADJUSTMENTS” section), begin pedaling, and press the  key.
2. You are prompted to select the desired TRAINING TOOLS program. Press the  key to select the Watts program, then press the  key when prompted to select Watts Interval.
3. You are prompted to enter your weight. The bike displays a default weight of 155 pounds (70 kg). You may enter any weight from 0 to 350 pounds (0 to 159 kg).
  - Use the    keys to enter your current weight; or press the  or  key, as necessary, to increase or decrease the displayed weight in 1 pound (or 1 kg) increments.
  - When your correct weight has been entered, press the  key to accept the displayed value.
4. You are prompted to enter a time goal. The bike displays a default time of 20 minutes. You may enter any time from 5 to 99 minutes.
  - Use the    keys to enter the desired time goal, or press the  or  key, as necessary, to increase or decrease the displayed value in 1 minute increments.
  - When your desired time goal has been entered, press the  key to accept the displayed value.
5. You are prompted to enter your age.
  - Use the    keys to enter your age, or press the  or  key, as necessary, to increase or decrease the displayed value in 1 year increments.
  - When your correct age has been entered, press the  key to accept the displayed value.
6. You are prompted to enter an upper watts limit. The bike displays a default upper watts limit of 300 watts. You may enter any value from 50 to 600 watts.
  - Use the    keys to enter an upper watts limit, or press the  or  key, as desired, to increase or decrease the watts limit in 1 watt increments.
  - When the desired upper heart rate limit has been entered, press the  key to accept the displayed value.
7. You are prompted to enter a lower watts limit. The bike displays a default lower watts limit of 200 watts. You may enter any value from 50 to 600 watts.
  - Use the    keys to enter a lower watts limit, or press the  or  key, as desired, to increase or decrease the watts limit in 1 watt increments.
  - When the desired lower watts limit has been entered, press the  key to accept the displayed value.
8. If desired, you can use the personal fan during your workout (see “Using the Personal Fan” for details).
9. You can scroll through workout data during the program (see “Viewing Workout Data During a Program” for details).
10. If you wish to pause the program, stop pedaling. The bike will enter pause mode and display your workout results for one entire cycle.
11. When you have reached your workout goal, the bike enters the Cooldown cycle (see “Cooldown Cycle” for details). If you wish to exit the program before you have reached your workout goal, stop pedaling and allow the Pause timer to expire.

## To operate the Constant Watts program:

This feature is designed to maintain your watts expenditure at a constant level by controlling pedaling resistance and prompting you to pedal at a specified RPM. Please note that your watts level may vary above and below your target watts level during this program.

1. Mount the bike (please refer to “SEAT ADJUSTMENTS” section), begin pedaling, and press the  key.
2. You are prompted to select the desired TRAINING TOOLS program. Press the  key to select the Watts program, then press the  key when prompted to select Constant Watts.
3. You are prompted to enter your weight. The bike displays a default weight of 155 pounds (70 kg). You may enter any weight from 0 to 350 pounds (0 to 159 kg).
  - Use the ... keys to enter your current weight; or press the  or  key, as necessary, to increase or decrease the displayed weight in 1 pound (or 1 kg) increments.
  - When your correct weight has been entered, press the  key to accept the displayed value.
4. You are prompted to enter a time goal. The bike displays a default time of 20 minutes. You may enter any time from 5 to 99 minutes.
  - Use the ... keys to enter the desired time goal, or press the  or  key, as necessary, to increase or decrease the displayed value in 1 minute increments.
  - When your desired time goal has been entered, press the  key to accept the displayed value.
5. You are prompted to enter your age.
  - Use the ... keys to enter your age, or press the  or  key, as necessary, to increase or decrease the displayed value in 1 year increments.
  - When your correct age has been entered, press the  key to accept the displayed value.
6. You are prompted to enter a watts rate. The bike displays a default wattage based on your entered age. You may enter any value from 50 to 600 watts.
  - Use the ... keys to enter your target watts rate, or press the  or  key, as desired, to increase or decrease the target watts rate in 1 watt increments.
  - When the desired target watts rate has been entered, press the  key to accept the displayed value.
7. If desired, you can use the personal cooling fan during your workout (see “Using the Cooling Fan” for details).
8. You can scroll through workout data during the program (see “Viewing Workout Data During a Program” for details).
9. If you wish to pause the program, stop pedaling. The bike will enter pause mode and display your workout results for one entire cycle.
10. When you have reached your workout goal, the bike enters the Cooldown cycle (see “Cooldown Cycle” for details). If you wish to exit the program before you have reached your workout goal, stop pedaling and allow the bike to enter the Workout Summary Mode.

## FITNESS TEST

The Fitness Test performs a single-stage, sub-maximal protocol, and calculates the results using the Astrand-Rhyming nomogram. The Fitness Test requires 6-7 minutes to complete. During the Fitness Test, you will be required to pedal at a constant 60 revolutions per minute (RPM). You can view your RPM's in the RPM field in the center of the Message Window (located at the top of the Display Panel).

**NOTE:** The test information is invalid if the RPM is not maintained at approximately 60 RPM.

You are required to raise your heart rate between 120 and 170 BPM for minutes 5, 6 and 7 (optional minute determined by the program). It is best to use a heart rate strap to properly measure your heart rate.















If, during the test, your heart rate reading levels out increase the resistance LEVEL, but DO NOT change the speed at which you are pedaling.

The Fitness Test utilizes age, gender, weight, workload output and HR to calculate two values:

- Max VO<sub>2</sub> (in m/O<sub>2</sub>/Kg/min) - measurement of oxygen consumption, which is used to define aerobic fitness.
- Fitness Level - allows a user to track progress on a scale from 0% to 100%.

**NOTE:** You must wear the heart rate strap during the FITNESS TEST to monitor your heart rate.

**To operate the Fitness Test program:**

1. Mount the bike (please refer to “SEAT ADJUSTMENTS” section), begin pedaling, and press the  key.
2. You are prompted to select the desired TRAINING TOOLS program. Press the  key when prompted to select Fitness Test.
3. You are prompted to enter your weight. The bike displays a default weight of 155 pounds (70 kg). You may enter any weight from 0 to 350 pounds (0 to 159 kg).
  - Use the ... keys to enter your current weight; or press the  or  key, as necessary, to increase or decrease the displayed weight in 1 pound (or 1 kg) increments.
  - When your correct weight has been entered, press the  key to accept the displayed value.
4. You are prompted to enter your gender.
  - Press the  key to set the gender to “male”, press the  key to set the gender to “female”.
  - When your correct gender has been entered, press the  key to accept the displayed value.
5. You are prompted to enter your age.
  - Use the ... keys to enter your age, or press the  or  key, as necessary, to increase or decrease the displayed value in 1 year increments.
  - When your correct age has been entered, press the  key to accept the displayed value.
6. The FITNESS TEST runs for 6~7 minutes. During the Fitness Test, you must maintain pedaling speed at a constant 60 RPM.

During the test, you may adjust the difficulty LEVEL at any time.
7. If desired, you can use the personal cooling fan during your workout (see “Using the Cooling Fan” for details).
8. When the test is completed, the bike enters the Cooldown cycle (see “Cooldown Cycle” for details). If you wish to exit the program before you have reached your workout goal, stop pedaling and allow the Pause timer to expire.

# PREVENTATIVE MAINTENANCE

With durable, high performance components, **STAR TRAC PRO BIKES** are designed for heavy usage with minimal maintenance required. To keep your bike in top condition, Star Trac strongly recommends performing the regular daily, weekly and monthly preventative maintenance routines outlined below. Any unusual symptoms, such as a loud continuous noise during operation, should be reported to **STAR TRAC PRODUCT SUPPORT DEPARTMENT** at (800) 503-1221, or USA 1-714-669-1660.

## DAILY MAINTENANCE

- Remove excessive accumulations of dust, dirt, and other substances by using a clean, soft cloth and a non-abrasive liquid cleaner, such as Formula 409™ or FANTASTIK™. Wipe down the exterior of the display panel, handlebars, seat, pedals, shrouds and heart rate grips.

**NOTE:** DO NOT spray the cleaner directly onto the display panel or heart rate grips.

## WEEKLY MAINTENANCE

Perform the following services each week:

- Vacuum the floor under and around the bike. Move the bike to another spot, if necessary, to vacuum thoroughly.
- Inspect the display panel mounting screws for security, and retighten if necessary.
- Inspect the display panel keypads for wear.

## MONTHLY MAINTENANCE

Perform the following services each month, or as needed:



- Check that the seat, pedals and shrouds are secure.
- Tighten the pedals onto their respective pedal cranks using a 5/8-inch open end wrench.

# MANAGER / MAINTENANCE MODE

After using your **STAR TRAC PRO BIKE** for a period of time, you may wish to change some of its settings.

## MANAGER MODE

The Manager Settings allow you to query and modify the basic settings of your bike. To enter Manager Settings:

1. Press and *hold* the ,  and  keys together.
2. A beep will sound and “MANAGER SETTINGS” will display momentarily in the Information Window.
3. Release all keys. “SERIAL NUMBER” will display in the Information Window.

**NOTE:** The system will automatically exit Manager Settings if no key is pressed for 30 seconds.

The following keys are used to modify MANAGER SETTINGS:



**Upper and Lower Data Information Window SCROLL Keys:** Display the next and previous parameters, respectively. Keys will repeat if held.



**Increase and Decrease LEVEL Keys:** Adjust the value of the displayed parameter up and down, respectively, in increments of 1 unit. These keys *do not* save the new value - see **OK Key** below.



**OK Key:** Updates (saves) the value of the displayed parameter in Flash memory, and exits Manager Mode.



**NOTE:** To exit Manager Mode without saving any values or settings, press the **QUICK START** key.

The items that you may display and change with the previous keys are:

Item	Lowest Value	Highest Value	Default Value	Meaning
Serial Number	0	65535	0	Pro Bike serial number (set by factory)
Date	01/00	12/99	07/03	Manufacture date for the Pro Bike (set by factory)
Display Vers 1	1.0	9.99	N/A	Display panel software version (set by factory)
Display Vers 2	1.0	9.99	N/A	Display panel software version (set by factory)
LCB Vers	1.0	9.99	N/A	Display panel software version (set by factory)
Units	English	Metric	English	English = units of pounds, miles, feet, inches; Metric = units of kilograms, kilometers, centimeters.
Time	5	99	20	Maximum time in minutes allowed for program, excluding warm-up and cool-down.
Weight	50 (Lb) 22 (KG)	350 (Lb) 158 (KG)	155 lbs 70 (KG)	Default (to user), typical weight in lb (UNITS=English), or kg (UNITS=Metric).
Language	N/A	N/A	English	Language is English, Dutch, French, German, Portuguese, Spanish, Swedish, Italian or Katakana.

## MAINTENANCE MODE

Your Service Representative may need to check accumulated data about the past usage of your bike, test its display controls, or investigate error messages. For these reasons, your bike is equipped with a Maintenance Mode. The Maintenance mode includes all of the items available through Manager Mode, plus additional items for Service and Diagnostic use. To enter Maintenance Mode:

1. Press and *hold* the ,  and  keys together.
2. A beep will sound and “MAINTENANCE SETTINGS” will display momentarily in the Information Window.
3. Release all keys. “SERIAL NUMBER” will display in the Information Window.

The following keys are available in MAINTENANCE SETTINGS:



**Upper and Lower Data Information Window SCROLL Keys:** Display the next and previous parameters, respectively. Keys will repeat if held.



**Increase and Decrease LEVEL Keys:** Adjust the value of the displayed parameter up and down, respectively, in increments of 1 unit . These keys *do not* save the new value - see **OK Key** below.



**OK Key:** Updates (saves) the value of the displayed parameter in Flash memory, and exits Maintenance Mode.

**NOTE:** To exit Maintenance Mode without saving any values or settings, press the QUICK START key.

The items that you may display and change with the previous keys are:

Item	Lowest Value	Highest Value	Default Value	Meaning
Serial Number	0	65535	0	Pro Bike serial number (set by factory)
Date	01/00	12/99	07/03	Manufacture date for the Pro Bike (set by factory)
Display Vers 1	1.0	9.99	N/A	Display panel software version (set by factory)
Display Vers 2	1.0	9.99	N/A	Display panel software version (set by factory)
LCB Vers	1.0	9.99	N/A	Load Control Board software version (set by factory)
Units	English	Metric	English	English = units of pounds, miles, feet, inches; Metric = units of kilograms, kilometers, centimeters.

Item	Lowest Value	Highest Value	Default Value	Meaning
Time	5	99	20	Maximum time in minutes allowed for program, excluding warm-up and cool-down.
Weight	50 (Lb) 22 (KG)	350 (Lb) 158 (KG)	155 lbs 70 (KG)	Default (to user), typical weight in lb (UNITS=English), or kg (UNITS=Metric).
Language	N/A	N/A	English	Language in English, Dutch, French, German, Portuguese, Spanish, Swedish, Italian or Katakana.
Model	N/A	N/A	PB-UB	PB-UB = Pro Bike - Upright PB-RB = Pro Bike - Recumbent NAT-RUNNER = Natural Runner
OPER Hours	0	65535	0	Total operating hours
BATT Hours	0	65535	0	Total battery use hours
Quick Start	0	65535	0	Number of times the Quick Start program was run since last reset.
Manual	0	65535	0	Number of times the Manual Program was run since last reset.
Warm Up	0	65535	0	Number of times the Warm Up Program was run since last reset.
Auto Pilot	0	65535	0	Number of times the Auto Pilot Program was run since last reset.
IHR Program	0	65535	0	Number of times the Interval Heart Rate Control Program was run since last reset.
CHR Program	0	65535	0	Number of times the Constant Heart Rate Control Program was run since last reset.
WI Program	0	65535	0	Number of times the Watts Interval Program was run since last reset.
CW Program	0	65535	0	Number of times the Continuous Watts Program was run since last reset.
Fit Test	0	65535	0	Number of times the Fitness Test Program was run since last reset.
Alpine	0	65535	0	Number of times the Alpine Pass Program was run since last reset.
Rndm Prog	0	65535	0	Number of times the Random Hill Program was run since last reset.
Over Temp	0	65535	0	Number of times an "Over Temperature" condition occurred since last reset.
No Temp	0	65535	0	Number of times a "No Temperature" condition occurred since last reset.
Low Batt	0	65535	0	Number of times a "Low Battery" condition occurred since last reset.
Comm Lost	0	65535	0	Number of times a "Communication Lost" condition occurred since last reset.
Key Down	0	65535	0	Number of times a "Key Down" condition occurred since last reset.
LED Test	N/A	N/A	N/A	Access to integral LED test function (for use by authorized Maintenance Technician).
Keypad Test	N/A	N/A	N/A	Access to integral keypad test function (for use by authorized Maintenance Technician).
Heart Rate Test	N/A	N/A	N/A	Access to integral heart rate system test function (for use by authorized Maintenance Technician).
Measurements	N/A	N/A	N/A	Access to integral Measurements function (for use by authorized Maintenance Technician).
Auto Status	N/A	N/A	OFF	Turns on/off the unsolicited status of the CSAFE feature.

# TROUBLESHOOTING

**STAR TRAC PRO BIKES** perform a self-test at the beginning of every workout. If a problem is detected, a message displays before or after the workout, depending on the nature of the problem. Star Trac recommends that you refer your questions about your **STAR TRAC PRO BIKE** operation and suspected malfunctions to Star Trac's Service Hotline at (800) 503-1221, or USA 1-714-669-1660.

## START-UP SERVICE MESSAGES

The following messages are displayed at the beginning of a workout if the associated problem is detected during self-test.

- **Key Down** - One or more keys on the display panel are stuck in the "on" position. This can occur if a user presses keys before the system is turned on. Call Star Trac Product Support for assistance if the **Key Down** message continues to display.

# REGULATORY INFORMATION

TO BE PROVIDED WHEN AVAILABLE



STAR TRAC  
14410 Myford Road  
Irvine, California 92606  
Telephone: (800) 228-6635, (714) 669-1660  
Fax: (714) 508-3303  
<http://www.startrac.com>



## Free Manuals Download Website

<http://myh66.com>

<http://usermanuals.us>

<http://www.somanuals.com>

<http://www.4manuals.cc>

<http://www.manual-lib.com>

<http://www.404manual.com>

<http://www.luxmanual.com>

<http://aubethermostatmanual.com>

Golf course search by state

<http://golfingnear.com>

Email search by domain

<http://emailbydomain.com>

Auto manuals search

<http://auto.somanuals.com>

TV manuals search

<http://tv.somanuals.com>