

COMMERCIAL ELECTRIC BOILERS

MODELS SW 37-670

**INSTALLATION - OPERATION - SERVICE -
MAINTENANCE - LIMITED WARRANTY**



A DIVISION OF A. O. SMITH CORPORATION
RENTON, WASHINGTON
www.statewaterheaters.com

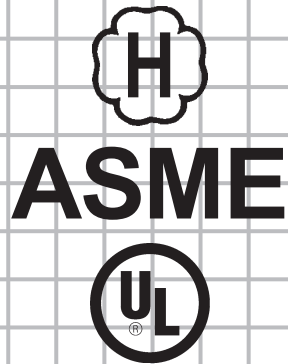

Thank you for buying this energy efficient boiler from us. We appreciate your confidence in our products.





PLACE THESE INSTRUCTIONS ADJACENT TO BOILER AND NOTIFY OWNER TO KEEP FOR FUTURE REFERENCE.

SAFE INSTALLATION, USE AND SERVICE

Your safety and the safety of others is extremely important in the installation, use, and servicing of this boiler.

Many safety-related messages and instructions have been provided in this manual and on your own boiler to warn you and others of a potential injury hazard. Read and obey all safety messages and instructions throughout this manual. It is very important that the meaning of each safety message is understood by you and others who install, use, or service this boiler.

	This is the safety alert symbol. It is used to alert you to potential personal injury hazards. Obey all safety messages that follow this symbol to avoid possible injury or death.
---	--

	DANGER indicates an imminently hazardous situation which, if not avoided, will result in death or injury.
	WARNING indicates a potentially hazardous situation which, if not avoided, could result in death or injury.
	CAUTION indicates a potentially hazardous situation which, if not avoided, could result in minor or moderate injury.
	CAUTION used without the safety alert symbol indicates a potentially hazardous situation which, if not avoided, could result in property damage.

All safety messages will generally tell you about the type of hazard, what can happen if you do not follow the safety message, and how to avoid the risk of injury.

The California Safe Drinking Water and Toxic Enforcement Act requires the Governor of California to publish a list of substances known to the State of California to cause cancer, birth defects, or other reproductive harm, and requires businesses to warn of potential exposure to such substances.

This product contains a chemical known to the State of California to cause cancer, birth defects, or other reproductive harm. This appliance can cause low level exposure to some of the substances listed.

IMPORTANT DEFINITIONS

- **Qualified Installer or Service Agency:**

Installation and service of this boiler requires ability equivalent to that of a Qualified Agency (as defined by ANSI below) in the field involved. Installation skills such as plumbing and electrical supply are required in addition to electrical testing skills when performing service.

- **ANSI Z223.1 2006 Sec. 3.3.83:**

“Qualified Agency” - “Any individual, firm, corporation or company that either in person or through a representative is engaged in and is responsible for (a) the installation, testing or replacement of gas piping or (b) the connection, installation, testing, repair or servicing of appliances and equipment; that is experienced in such work; that is familiar with all precautions required; and that has complied with all the requirements of the authority having jurisdiction.”

GENERAL SAFETY INFORMATION

PRECAUTIONS

DO NOT USE THIS APPLIANCE IF ANY PART HAS BEEN UNDER WATER. Immediately call a qualified service technician to inspect the appliance and to replace any part of the control system which has been under water.

If the unit is exposed to the following, do not operate boiler until all corrective steps have been made by a qualified service agency.

1. External fire.
2. Damage.
3. Firing without water.

GROUNDING INSTRUCTIONS

This boiler must be grounded in accordance with the National Electrical Code and/or local codes. These must be followed in all cases. Failure to ground this boiler properly may also cause erratic control system operation on ELECTRONIC CONTROL models.

This boiler must be connected to a grounded metal, permanent wiring system, or an equipment grounding conductor must be run with the circuit conductors and connected to the equipment grounding terminal or lead on the boiler.

HYDROGEN GAS (FLAMMABLE)

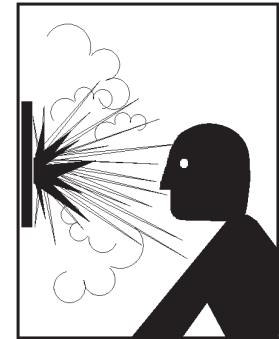

⚠ WARNING

Explosion Hazard

- Flammable hydrogen gases may be present.
- Keep all ignition sources away from faucet when turning on hot water.

Hydrogen gas can be produced in a hot water system served by this boiler that has not been used for a long period of time (generally two weeks or more). Hydrogen gas is extremely flammable. To reduce the risk of injury under these conditions, it is recommended that the hot water faucet be opened for several minutes at the kitchen sink before using any electrical appliance connected to the hot water system. If hydrogen is present there will probably be an unusual sound such as air escaping through the pipe as the water begins to flow. THERE SHOULD BE NO SMOKING OR OPEN FLAME NEAR THE FAUCET AT THE TIME IT IS OPEN.

When servicing this unit, verify the power to the unit is turned off prior to opening the control cabinet door.



⚠ WARNING

Read and understand this instruction manual and the safety messages herein before installing, operating, or servicing this water heater.

Failure to follow these instructions and safety messages could result in death or serious injury.

This manual must remain with the water heater.

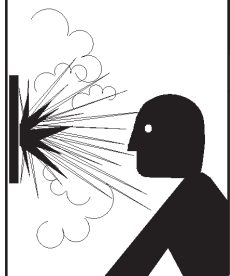

⚠ WARNING

Explosion Hazard

- Flammable hydrogen gases may be present.
- Keep all ignition sources away from faucet when turning on hot water.

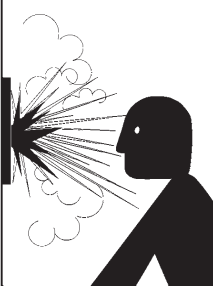

⚠ WARNING

Explosion Hazard

- Relief Valve must comply with ASME code.
- Properly sized Relief Valve must be installed in opening provided.
- Can result in overheating and excessive tank pressure.
- Can cause serious injury or death.



⚠ WARNING

- Before removing any access panels or servicing the water heater, make sure the electrical supply to the water heater is turned "OFF."
- Failure to do this could result in death, serious bodily injury, or property damage.

CAUTION

Improper Installation, use and service may result in property damage.

- Do not operate water heater if flood damaged.
- Inspect anode rods regularly, replace when significantly depleted.
- Install in location with drainage.
- Fill tank with water before operation.
- Properly sized thermal expansion tanks are required on all closed water systems.

Refer to this manual for installation and service.

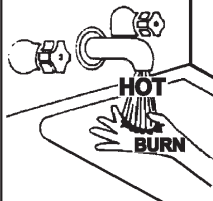

⚠ DANGER

Water temperature over 125°F (52°C) can cause severe burns instantly resulting in severe injury or death.

Children, the elderly, and the physically or mentally disabled are at highest risk for scald injury.

Feel water before bathing or showering.

Temperature limiting valves are available.

Read instruction manual for safe temperature setting.

TABLE OF CONTENTS

SAFE INSTALLATION, USE AND SERVICE.....	2	Calculating Amperage/Overcurrent Protection.....	12
GENERAL SAFETY INFORMATION.....	3	Boiler Circuits.....	12
Precautions.....	3	Control Circuits.....	12
Hydrogen Gas (Flammable).....	3	WIRING DIAGRAMS.....	13
TABLE OF CONTENTS.....	4	OPERATION.....	15
INTRODUCTION.....	4	Important.....	15
Preparing for the Installation.....	4	General.....	15
DIMENSIONS AND CAPACITIES DATA.....	5	High Temperature Limit.....	15
FEATURES AND COMPONENTS.....	8	Filling the Boiler.....	15
APPROVALS.....	9	Initial Start Up.....	15
MODEL AND RATING.....	9	Temperature Regulation.....	15
LOCATING THE NEW BOILER.....	9	Temperature Controls.....	16
Facts to Consider About the Location.....	9	Draining.....	16
INSTALLATION.....	10	MAINTENANCE.....	17
Required Ability.....	10	Schedule.....	17
General.....	10	System Cleaning.....	17
Pressure Relief Valve.....	10	Flushing.....	17
Water Line Connections.....	10	Sediment Removal.....	17
Closed Water Systems.....	11	Lime Scale Removal.....	17
Thermal Expansion.....	11	TROUBLESHOOTING CHECKLIST.....	18
ELECTRICAL DATA.....	12	Not Enough or No Hot Water.....	18
General.....	12	Water is Too Hot.....	18
Branch Circuit.....	12	Boiler Makes Strange Sounds.....	18
		Leakage Checkpoints.....	18
		WARRANTY.....	19

INTRODUCTION

Thank You for purchasing this boiler. Properly installed and maintained, it should give you years of trouble free service.

Abbreviations Found In This Instruction Manual:

- ANSI - American National Standards Institute
- ASME - American Society of Mechanical Engineers
- GAMA - Gas Appliance Manufacturer's Association
- NEC - National Electrical Code
- NFPA - National Fire Protection Association
- UL - Underwriters Laboratory

PREPARING FOR THE INSTALLATION

1. Read the "General Safety" section of this manual first and then the entire manual carefully. If you don't follow the safety rules, the boiler may not operate safely. It could cause DEATH, SERIOUS BODILY INJURY AND/OR PROPERTY DAMAGE.

This manual contains instructions for the installation, operation, and maintenance of the electric boiler. It also contains warnings throughout the manual that you must read and be aware of. All warnings and all instructions are essential to the proper operation of the boiler and your safety. READ THE ENTIRE MANUAL BEFORE ATTEMPTING TO INSTALL OR OPERATE THE BOILER.

Detailed installation diagrams are in this manual. These diagrams will serve to provide the installer with a reference for the materials and method of piping suggested. IT IS NECESSARY THAT ALL WATER PIPING AND THE ELECTRICAL WIRING BE INSTALLED AND CONNECTED AS SHOWN IN THE DIAGRAMS.

Particular attention should be given to the installation of thermometers at the locations indicated in the diagrams as these are necessary for checking the operation of the heater.

Be sure to turn off power when working on or near the electrical system of the heater. Never touch electrical components with wet hands or when standing in water. When replacing

fuses always use the correct size for the circuit. See page 12 through 14.

The principal components of the heater are identified on page 8. The model and rating plate on page 9 interprets certain markings into useful information. Both of these references should be used to identify the heater, its components and optional equipment.

2. The installation must conform with these instructions and the local code authority having jurisdiction and the requirements of the power company. In the absence of code requirements, follow NFPA-70 (current edition). The National Electrical Code may be ordered from: National Fire Protection Association, 1 Batterymarch Park, Quincy, MA 02269.
3. If after reading this manual you have any questions or do not understand any portion of the instructions, call the toll free number on the back cover for further assistance.

A sample rating plate and barcode tag are shown on page 9 of this manual. In order to expedite your request, please have the serial number and item ID from the barcode tag available for the technician.

4. Carefully plan your intended placement of the boiler. Examine the location to ensure the boiler complies with the "Locating the New Boiler" section in this manual.

Installation and service of this boiler requires ability equivalent to that of a licensed tradesman or qualified agency (page 2) in the field involved. Plumbing and electrical work are required.

5. For installation in California this boiler must be braced or anchored to avoid falling or moving during an earthquake. See instructions for correct installation procedures. Instructions may be obtained from California Office of the State Architect, 1102 Q Street, Suite 5100, Sacramento, CA 95811.
6. Massachusetts Code requires this boiler to be installed in accordance with Massachusetts 248-CMR 2.00: State Plumbing Code and 248-CMR 5.00.

DIMENSION DATA

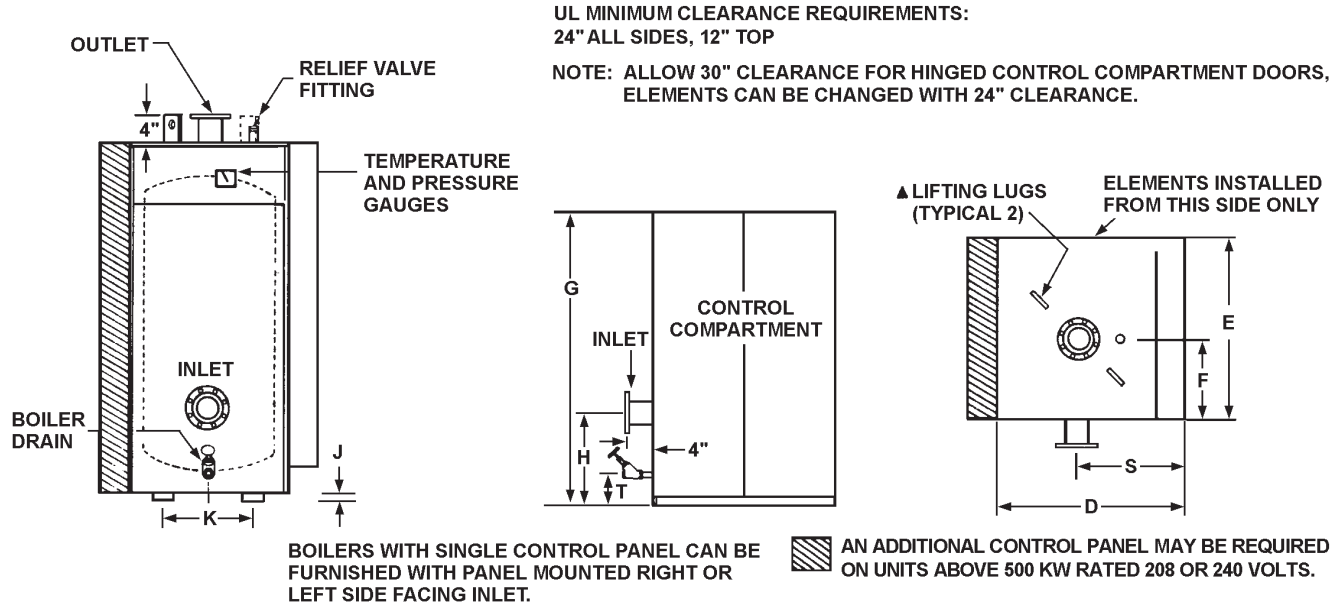

SIZES AND DATA NW37 THRU NW150

Model Number			D	E	F	G**	H	J	K	S	T	Inlet* & Outlet*	Boiler Drain
Prefix	Gal. Cap.	Std. KW Input											
SW	37	45K	32	30	12	42	12 1/2	-	-	20	4	3	1
SW	37	60K	32	30	12	42	12 1/2	-	-	20	4	3	1
SW	37	75K	32	30	12	42	12 1/2	-	-	20	4	2	1
SW	37	90K	32	30	12	42	12 1/2	-	-	20	4	3	1
SW	37	105K	32	30	12	42	12 1/2	-	-	20	4	3	1
SW	37	120K	32	30	12	42	12 1/2	-	-	20	4	3	1
SW	37	150K	32	30	12	42	12 1/2	-	-	20	4	3	1
SW	37	180K	32	30	12	42	12 1/2	-	-	20	4	3	1
SW	60	210K	32	30	12	57	12 1/2	-	-	20	4	3	1
SW	60	240K	32	30	12	57	12 1/2	-	-	20	4	3	1
SW	60	270K	32	30	12	57	12 1/2	-	-	20	4	3	1
SW	60	300K	32	30	12	57	12 1/2	-	-	20	4	3	1
SW	96	330K	36	38	16	69 1/2	17	1 1/2	17	22	5	4	1 1/4
SW	96	390K	36	38	16	69 1/2	17	1 1/2	17	22	5	4	1 1/4
SW	96	420K	36	38	16	69 1/2	17	1 1/2	17	22	5	4	1 1/4
SW	96	450K	36	38	16	69 1/2	17	1 1/2	17	22	5	4	1 1/4
SW	96	480K	36	38	16	69 1/2	17	1 1/2	17	22	5	4	1 1/4
SW	150	540K	46	44	19	69 1/2	20	2	20	27	5 1/2	5	1 1/2
SW	150	600K	46	44	19	69 1/2	20	2	20	27	5 1/2	5	1 1/2
SW	150	660K	46	44	19	69 1/2	20	2	20	27	5 1/2	5	1 1/2
SW	150	720K	46	44	19	69 1/2	20	2	20	27	5 1/2	5	1 1/2

* All fittings under 4" will be threaded type. All fittings 4" and larger will be flanged. 3" fittings extend 4" beyond jacket.

** Where overall height is a problem a larger diameter vessel with a reduced height may be furnished.

▲ Lifting lugs and channel skid base on 96 gallon and larger units.

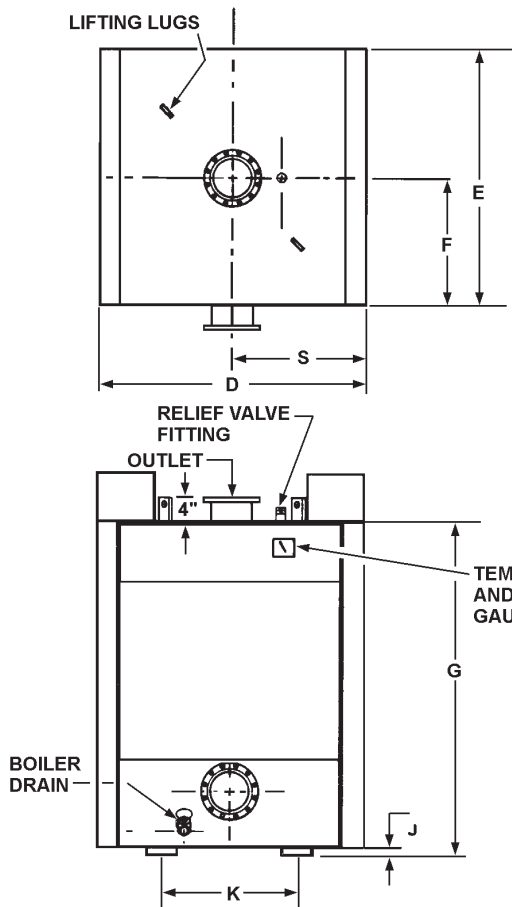

UL MINIMUM CLEARANCE REQUIREMENTS:
24" ALL SIDES, 12" TOP

NOTE: ALLOW 30" CLEARANCE FOR HINGED CONTROL COMPARTMENT DOORS.

ELEMENTS CAN BE CHANGED WITH 24" CLEARANCE.

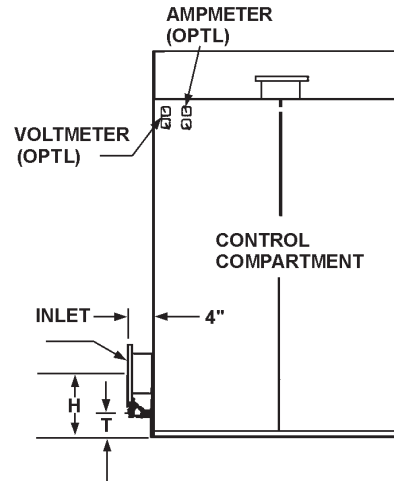

SIZES AND DATA NW220 THRU 670

Model Number			D	E	F	G**	H	J	K	S	T	Inlet* & Outlet*	Boiler Drain
Prefix	Gal. Cap.	Std. KW Input											
SW	220	780K	60	50	25	71	21	2	25 1/2	30	5 1/2	5	1 1/2
SW	220	840K	60	50	25	71	21	2	25 1/2	30	5 1/2	5	1 1/2
SW	220	900K	60	50	25	71	21	2	25 1/2	30	5 1/2	5	1 1/2
SW	220	960K	60	50	25	71	21	2	25 1/2	30	5 1/2	5	1 1/2
SW	220	1020K	60	50	25	71	21	2	25 1/2	30	5 1/2	5	1 1/2
SW	220	1080K	60	50	25	71	21	2	25 1/2	30	5 1/2	5	1 1/2
SW	220	1140K	60	50	25	71	21	2	25 1/2	30	5 1/2	5	1 1/2
SW	334	1200K	60	50	25	99	25	2	25 1/2	30	7 1/4	6	2
SW	334	1260K	60	50	25	99	25	2	25 1/2	30	7 1/4	6	2
SW	334	1380K	60	50	25	99	25	2	25 1/2	30	7 1/4	6	2
SW	334	1500K	60	50	25	99	25	2	25 1/2	30	7 1/4	6	2
SW	334	1620K	60	50	25	99	25	2	25 1/2	30	7 1/4	6	2
SW	334	1740K	60	50	25	99	25	2	25 1/2	30	7 1/4	6	2
SW	400	1800K	66	56	28	90 1/2	25 1/2	2 1/2	30	33	7 3/4	8	2
SW	400	1860K	66	56	28	90 1/2	25 1/2	2 1/2	30	33	7 3/4	8	2
SW	400	1980K	66	56	28	90 1/2	25 1/2	2 1/2	30	33	7 3/4	8	2
SW	400	2100K	66	56	28	90 1/2	25 1/2	2 1/2	30	33	7 3/4	8	2
SW	500	2200K	72	62	31	90 1/2	26 1/2	2 1/2	34	36	7 3/4	8	2
SW	500	2340K	72	62	31	90 1/2	26 1/2	2 1/2	34	36	7 3/4	8	2
SW	500	2460K	72	62	31	90 1/2	26 1/2	2 1/2	34	36	7 3/4	8	2
SW	500	2580K	72	62	31	90 1/2	26 1/2	2 1/2	34	36	7 3/4	8	2
SW	670	2700K	78	68	34	96 1/2	30 1/2	2 1/2	38	39	7 3/4	8	2
SW	670	2820K	78	68	34	96 1/2	30 1/2	2 1/2	38	39	7 3/4	8	2
SW	670	2940K	78	68	34	96 1/2	30 1/2	2 1/2	38	39	7 3/4	8	2
SW	670	3060K	78	68	34	96 1/2	30 1/2	2 1/2	38	39	7 3/4	8	2
SW	670	3180K	78	68	34	96 1/2	30 1/2	2 1/2	38	39	7 3/4	8	2
SW	670	3300K	78	68	34	96 1/2	30 1/2	2 1/2	38	39	7 3/4	8	2

NOTE: For boilers 3400KW to 6000KW, consult factory.

* All fittings under 4" will be threaded type. All fittings 4" and larger will be flanged.

** Where overall height is a problem a larger diameter vessel with a reduced height may be furnished.

DIMENSION DATA (cont'd)

BOILER SPECIFICATIONS (STANDARD)

Model Number			BTU Output	Gal./Hr. 100°F Rise	Number of Elements	Number of Steps *	Standard Number and KW of Steps *	Amperage 3 Phase			
Prefix	Gal. Cap.	Std. KW Input						208V	240V	480V	575V
SW	37	45K	153,585	180	3	1	1@45	128	108	55	45
SW	37	60K	204,720	240	4	1	1@60	171	144	73	60
SW	37	75K	255,975	300	5	1	1@75	213	180	90	75
SW	37	90K	307,170	369	6	3	3@30	250	217	108	90
SW	37	105K	358,365	430	7	4	3@30+1@15	292	253	126	105
SW	37	120K	409,560	492	8	4	4@30	334	289	144	121
SW	37	150K	511,950	615	10	5	5@30	417	361	180	151
SW	37	180K	614,340	738	12	6	6@30	500	433	216	181
SW	60	210K	716,730	861	14	7	7@30	584	505	252	211
SW	60	240K	819,120	984	16	8	8@30	668	577	288	241
SW	60	270K	921,510	1107	18	9	9@30	751	650	324	271
SW	60	300K	1,023,900	1230	20	10	10@30	834	722	360	301
SW	96	330K	1,126,290	1353	22	10	1@60+9@30	917	794	396	331
SW	96	360K	1,228,680	1476	24	10	2@60+8@30	1001	866	432	362
SW	96	390K	1,331,070	1599	26	10	3@60+7@30	1084	938	468	392
SW	96	420K	1,433,460	1722	28	10	4@60+6@30	1168	1010	504	422
SW	96	450K	1,535,850	1845	30	10	5@60+5@30	1251	1083	540	452
SW	96	480K	1,638,240	1968	32	10	6@60+4@30	1334	1155	576	487
SW	150	540K	1,843,020	2214	36	10	8@60+2@30	↑ 1501	↑ 1299	648	542
SW	150	600K	2,047,800	2460	40	10	10@60			720	602
SW	150	660K	2,252,580	2706	44	10	8@60+2@90			792	663
SW	150	720K	2,457,360	2952	48	10	4@90+6@60			864	723
SW	220	780K	2,662,140	3198	52	10	6@90+4@60	↑	↑	936	783
SW	220	840K	2,866,920	3444	56	10	9@90+1@30			1008	843
SW	220	900K	3,071,700	3690	60	10	10@90			1080	904
SW	220	960K	3,276,480	3936	64	10	8@90+2@120			1152	964
SW	220	1020K	3,481,260	4182	68	10	6@90+4@120			1224	1024
SW	220	1080K	3,636,040	4428	72	10	4@90+6@120			1296	1084
SW	220	1140K	3,890,820	4674	76	10	2@90+8@120			1368	1145
SW	334	1200K	4,095,600	4920	80	10	10@120	↑ Not Recommended	↑ Not Recommended	1440	1205
SW	334	1260K	4,300,380	5166	84	10	8@120+2@150			1512	1265
SW	334	1380K	4,709,940	5658	92	10	4@120+6@150			1656	1386
SW	334	1500K	5,119,500	6150	100	10	10@150			1800	1506
SW	334	1620K	5,529,060	6642	108	16	10@90+6@120			1944	1627
SW	334	1740K	5,938,630	7134	116	17	10@90+7@120			2068	1747
SW	400	1800K	6,143,400	7380	120	17	8@90+9@120	↑ Not Recommended	↑ Not Recommended	2160	1807
SW	400	1860K	6,348,180	7626	124	17	6@90+11@120			2232	1868
SW	400	1980K	6,757,740	8118	132	18	6@90+12@120			2376	1988
SW	400	2100K	7,167,300	8610	140	19	6@90+13@120			2520	2109
SW	500	2220K	7,576,860	9102	148	15	1@120+14@150	↓	↓	2664	2229
SW	500	2340K	7,986,420	9594	156	20	18@120+2@90			2808	2350
SW	500	2460K	8,395,980	10080	164	20	18@120+2@150			2952	2470
SW	500	2580K	8,805,540	10578	172	20	14@120+6@150			3096	2590
SW	670	2700K	9,315,100	11070	180	20	10@120+10@150	↓	↓	3240	2711
SW	670	2820K	9,624,660	11562	188	20	6@120+14@150			3384	2832
SW	670	2940K	10,034,220	12054	196	20	2@120+18@150			3528	2952

NOTE: For boilers 3000KW to 6000KW consult factory.

*Consult factory for optional number of steps and Kw per step.

FEATURES AND COMPONENTS

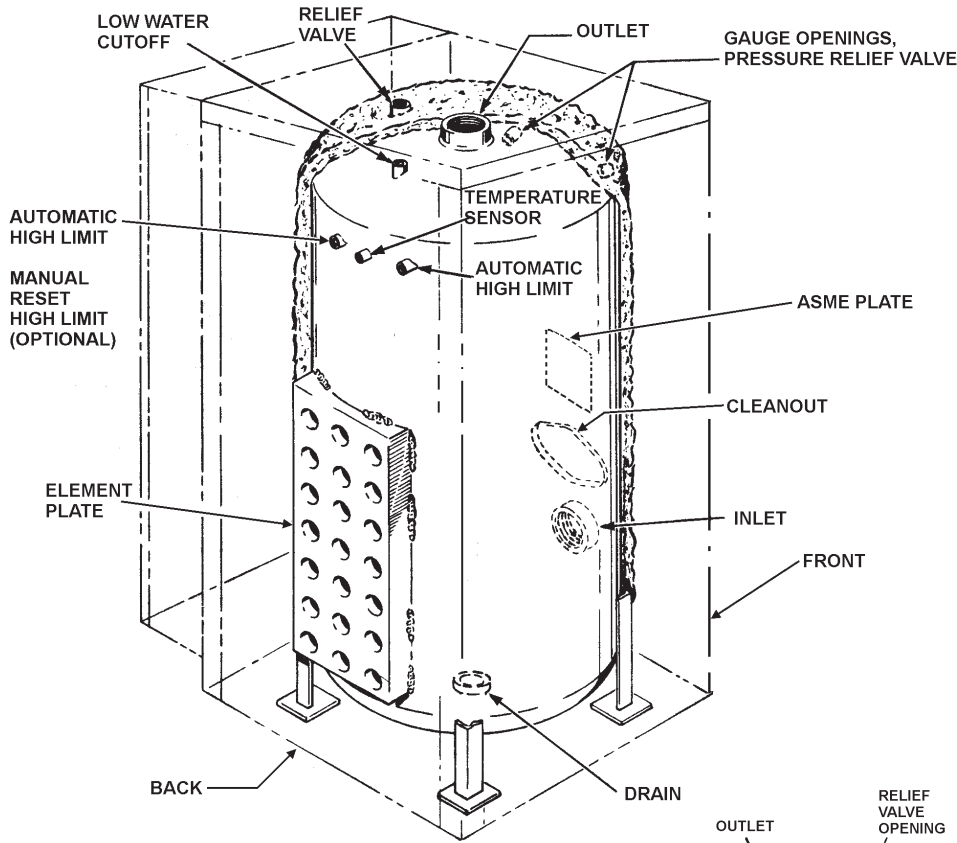

ACTUAL CONFIGURATION MAY VARY.

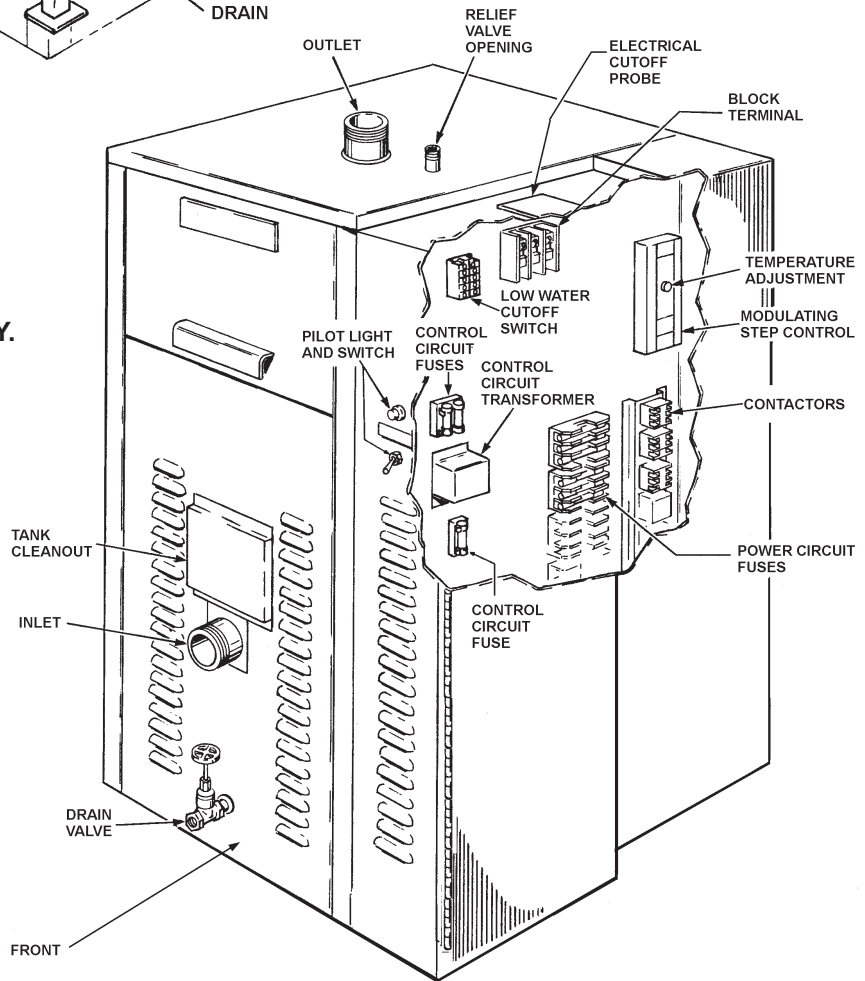

APPROVALS



ASME

MODEL AND RATING



STATE WATER HEATERS					
P.O. BOX 58549, RENTON, WA. 98058-1549					
AUTOMATIC WATER BOILER					
MODEL NO.	ASME NO.	PH.	CY	AMP.	VOLTS
<input type="text"/>	<input type="text"/>	<input type="text"/>	<input type="text"/>	<input type="text"/>	<input type="text"/>
STORAGE CAP.	<input type="text"/>	GALLONS	<input type="text"/>	BTU/HR	
NO. ELEMENTS	<input type="text"/>	WATTS EA.	<input type="text"/>	TOTAL WATTS	
<input type="text"/>	<input type="text"/>	<input type="text"/>	<input type="text"/>	<input type="text"/>	
MAX. WORKING PRESSURE			<input type="text"/>	TEST PRESSURE	
<input type="text"/>			<input type="text"/>		
USE ON A.C. CURRENT ONLY					
FOR SUPPLY CONNECTIONS, USE WIRE SUITABLE FOR AT LEAST 75C					
				17T8 LISTED	

LOCATING THE BOILER

FACTS TO CONSIDER ABOUT THE LOCATION

CAUTION

Property Damage Hazard

- All boilers eventually leak.
- Do not install without adequate drainage.

Carefully choose a location for the boiler. The placement is a very important consideration for the safety of the occupants in the building and for the most economical use of the appliance.

Whether replacing an old boiler or putting the boiler in a new location, the following critical points must be observed. The boiler must be located:

1. On a level surface. Shim the channel type skid base as necessary if levelling is required.

2. Near a floor drain. The boiler should be located in an area where leakage of the tank or connections will not result in damage to the area adjacent to the boiler or to lower floors of the structure.
3. The discharge opening of the temperature and pressure relief valve should always be piped to an open drain.
4. Close to the point of major hot water usage and the power supply.

Hot water piping and branch circuit wiring should be as short as possible.

Insulate hot and cold water piping where heat loss and condensation may be a problem.

Boiler construction permits installation, maintenance, and service work to be performed through panels located in multiple sides of the boiler.

Suggested clearances from adjacent surfaces are 12 inches on top, 30 inches in front for access to the unit.

The boiler may be installed in a confined space if adequate ventilation is provided.

The temperature of the space in which the boiler is installed must not go below 32°F or above 122°F.

INSTALLATION

REQUIRED ABILITY

Installation and service of this boiler requires ability equivalent to that of a qualified agency (page 2) in the field involved. Plumbing and electrical work is required.

GENERAL

The installation must conform with these instructions and the local code authority having jurisdiction and the requirements of the power company. In the absence of code requirements, follow NFPA-70 (current edition). In the absence of local codes, the installation must comply with the latest editions of the National Electrical Code, NFPA 70 or the Canadian Electrical Code CSA C22.1. The National Electrical Code may be ordered from: National Fire Protection Association, 1 Batterymarch Park, Quincy, MA 02269. The Canadian Electrical Code is available from the Canadian Standards Association, 8501 East Pleasant Valley Road, Cleveland, OH 44131.

Do **NOT** test electrical system before boiler is filled with water, follow the START UP procedure in the OPERATION section of this manual.

The principal components of the boiler are identified in the Features and Components illustration on page 8.

Boilers are usually placed in a series with the heating system on the outlet side of the circulating pump. The boiler piping should include inlet and outlet water valves to permit maintenance and service work to be performed without disturbing the rest of the system.

Detailed system installation drawings are normally provided by the equipment purchaser or system designer.

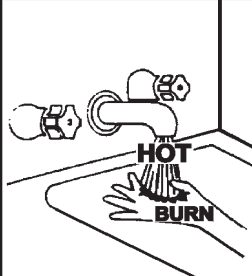
	<p>⚠ DANGER</p> <p>Water temperature over 125°F (52°C) can cause severe burns instantly resulting in severe injury or death.</p> <p>Children, the elderly, and the physically or mentally disabled are at highest risk for scald injury.</p> <p>Feel water before bathing or showering.</p> <p>Temperature limiting valves are available.</p> <p>Read instruction manual for safe temperature setting.</p>
---	---

PRESSURE RELIEF VALVE

An ASME rated pressure relief valve is furnished with the boiler. A fitting for the relief valve is provided in the top of the boiler. Never operate the heating elements without being certain the boiler is filled with water and a properly sized pressure relief valve is installed in the relief valve opening provided.

The pressure rating of the relief valve should be equal to or less than the rated pressure capacity of any component in the system including the boiler. Should the valve need to be replaced, call the toll free phone number listed on the back of this manual for further technical assistance.

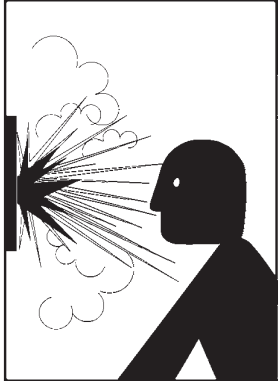
	⚠ WARNING
	Explosion Hazard
	<ul style="list-style-type: none">• Relief Valve must comply with ASME code.• Properly sized Relief Valve must be installed in opening provided.• Can result in overheating and excessive tank pressure.• Can cause serious injury or death.

A discharge pipe from the relief valve should terminate at an adequate floor drain. Do not thread, plug, or cap the end of the drain line.

CAUTION
Water Damage Hazard
<ul style="list-style-type: none">• Pressure Relief Valve discharge pipe must terminate at adequate drain.

The Discharge Pipe:

- Shall not be smaller in size than the outlet pipe size of the valve, or have any reducing couplings or other restrictions.
- Shall not be plugged or blocked.
- Shall not be exposed to freezing temperatures.
- Shall be of material listed for hot water distribution.
- Shall be installed so as to allow complete drainage of both the relief valve and the discharge pipe.
- Must terminate a maximum of six inches above a floor drain or external to the building. In cold climates, it is recommended that the discharge pipe be terminated at an adequate drain inside the building.
- Shall not have any valve or other obstruction between the relief valve and the drain.

Once the boiler is installed and filled with water and the system is pressurized, manually test the operation of the pressure relief valve. See the maintenance section of this manual for instructions.

WATER LINE CONNECTIONS

The boiler may be installed by itself, or with a separate storage tank, on both single and two-temperature systems. When used with a separate storage tank, the circulation may be either by gravity or by means of a circulating pump. When a circulating pump is used it is important to note that the flow rate should be slow so that there will be a minimum of turbulence inside the heater.

CLOSED WATER SYSTEMS

Water supply systems may, because of code requirements or such conditions as high line pressure, among others, have installed devices such as pressure reducing valves, check valves, and back flow preventers. Devices such as these cause the water system to be a closed system.

THERMAL EXPANSION

As water is heated, it expands (thermal expansion). In a closed system the volume of water will grow when it is heated. As the volume of water grows there will be a corresponding increase in

water pressure due to thermal expansion. Thermal expansion can cause premature tank failure (leakage). This type of failure is not covered under the limited warranty. Thermal expansion can also cause intermittent pressure relief valve operation: water discharged from the valve due to excessive pressure build up. This condition is not covered under the limited warranty. The pressure relief valve is not intended for the constant relief of thermal expansion.

A properly sized thermal expansion tank should be installed on all closed systems to control the harmful effects of thermal expansion. Contact a local plumbing service agency to have a thermal expansion tank installed.

ELECTRICAL DATA

GENERAL

Check the boiler model and rating plate information against the characteristics of the branch circuit electrical supply. Do not connect the boiler to an improper source of electricity.

Voltage applied to the boiler should not vary more than + 5% to -10% of the model and rating plate marking for satisfactory operation.

Do not energize the branch circuit for any reason before the boiler is filled with water. Doing so may cause the heating elements to burn out. Such damage is not covered under the terms of the warranty.

The branch circuit is connected to the block through an opening provided on top of the boiler.

The boiler should be connected to a separate, grounded, branch circuit with overcurrent protection and disconnect switch. These are part of the electrical supply system not components of the boiler, as such they are obtained locally. The boiler should be grounded in accordance with national and local codes.

BRANCH CIRCUIT

The branch circuit wire size should be established through reference to the National Electrical Code or other locally approved source in conjunction with boiler amperage rating. Branch circuit wiring which connects to the boiler terminal block should be temperature rated at 75°C. For convenience, portions of the wire size tables from the Code are reproduced here. It is suggested the electrician size the branch circuit at 125 percent of the boiler rating and further increase wire size as necessary to compensate for voltage drop in long runs. Branch circuit voltage drop should not exceed 3% at the boiler.

CALCULATING AMPERAGE/ OVERCURRENT PROTECTION

The boiler is factory wired for connection to three wire single-phase or three and four wire three-phase branch circuits. In addition, a ground conductor may be required.

A diagram of the wiring "as built" is furnished with the boiler for the electrician's use. An amperage table is on pages 7 & 12 of this manual. The boiler model and rating plate provides full load amperage data. Typical or Standard wiring diagrams are provided on pages 13 & 14 of this manual.

The rating of the overcurrent protection should be computed on the basis of 125 percent of the total connected load amperage. Where the standard ratings and settings do not correspond with this computation, the next higher standard rating or setting should be selected.

BOILER CIRCUITS

The boiler's electrical components are pictured and identified on page 8. The model and rating plate illustration on page 9 identifies the electrical characteristics. Basically, there are two electrical circuits:

- The control circuit, where the temperature control directly or indirectly operates the contactor coils.
- The power circuit, which is operated by the control circuit, carries the electrical load of the heating elements.

The following describes the circuits and includes typical wiring diagrams. All circuits are designed for 60 or 50 Hertz alternating current.

Refer to ELECTRICAL CONFIGURATION TABLE, below, and wiring diagram provided with your boiler before completing connections to electrical supply.

NOTE: Wiring diagrams in this manual are typical examples. The specific wiring diagram "as built" for your boiler is typically attached to the "inner side" of the control panel.

CONTROL CIRCUIT

All control circuits are operated on single-phase 120V. A transformer is used in the control circuit.

Control circuit wiring is 14 Awg, THHN or THWN type, rated 600 volts, 105°C.

Separate instructional literature is provided with the boiler for step control.

Portion of Table 310-16 Allowable Ampacities of Insulated Copper Conductors		Portion of Table 310-16 Allowable Ampacities of Insulated Aluminum and Copper-Clad Aluminum Conductors	
Not more than three conductors in raceway or cable or direct burial (based on ambient temperature of 30°C, 86°F.)		Not more than three conductors in raceway or cable or direct burial (based on ambient temperature of 30°C, 86°F.)	
Size	Temperature Rating of Conductor. See Table 310-13 in Code	Size	Temperature Rating of Conductor. See Table 310-13 in Code
AWG MCM	75°C (167°F) Types RH, RHW, RUH (14- 2), THW, THWN, XHHW, USE	AWG MCM	75°C (167°F) Types RH, RHW, RUH (12- 2), THW, THWN, XHHW, USE
18	-----	12	15
16	-----	10	25
14	15	8	40
12	20	6	50
10	30	4	65
8	45	3	75
6	65	2	90
4	85	1	100
3	100	1/0	120
2	115	2/0	135
1	130	3/0	155
1/0	150	4/0	180
2/0	175	250	205
3/0	200	300	230
4/0	230	350	250
250	255	400	270
300	285	500	310
350	310	600	340
400	335	700	375
500	380	750	385
600	420	800	395
700	460	900	425
750	475	1000	445
800	490	1250	485
900	520	1500	520
1000	545	1750	545
1250	590	2000	560
1500	625	These capacities relate only to conductors described in Table 310-13 in Code. For ambient temperatures over 30°C, see Correction Factors, Note 13 in Code	
1750	650		
2000	665		

WIRING DIAGRAMS

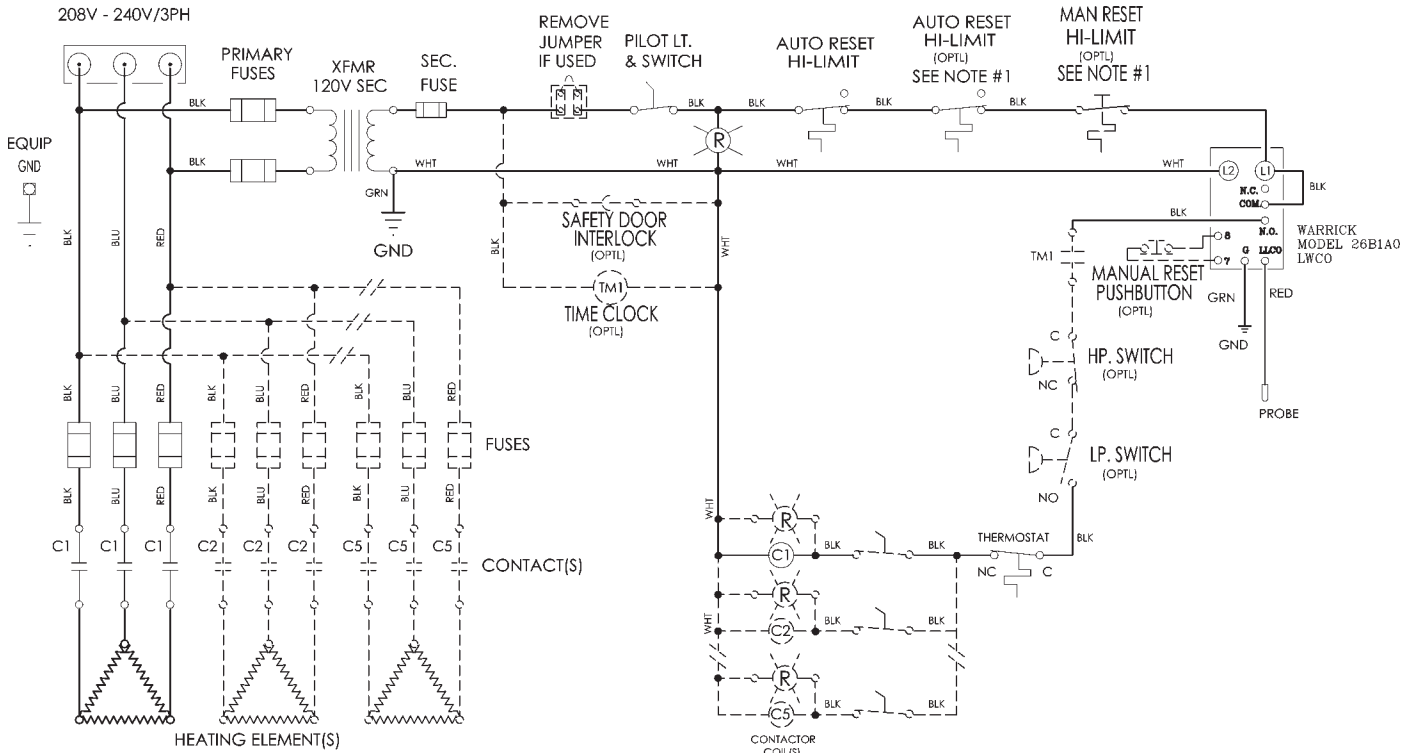

- NOTE(S):
1. IF A MANUAL RESET HLMT IS USED, THE SECOND AUTO RESET HLMT SWITCH IS NOT USED.
- STD. WIRING
 - - - OPTIONAL OR FIELD WIRING AS REQ'D

DIAGRAM 1.
THREE PHASE DELTA WITH THERMOSTAT

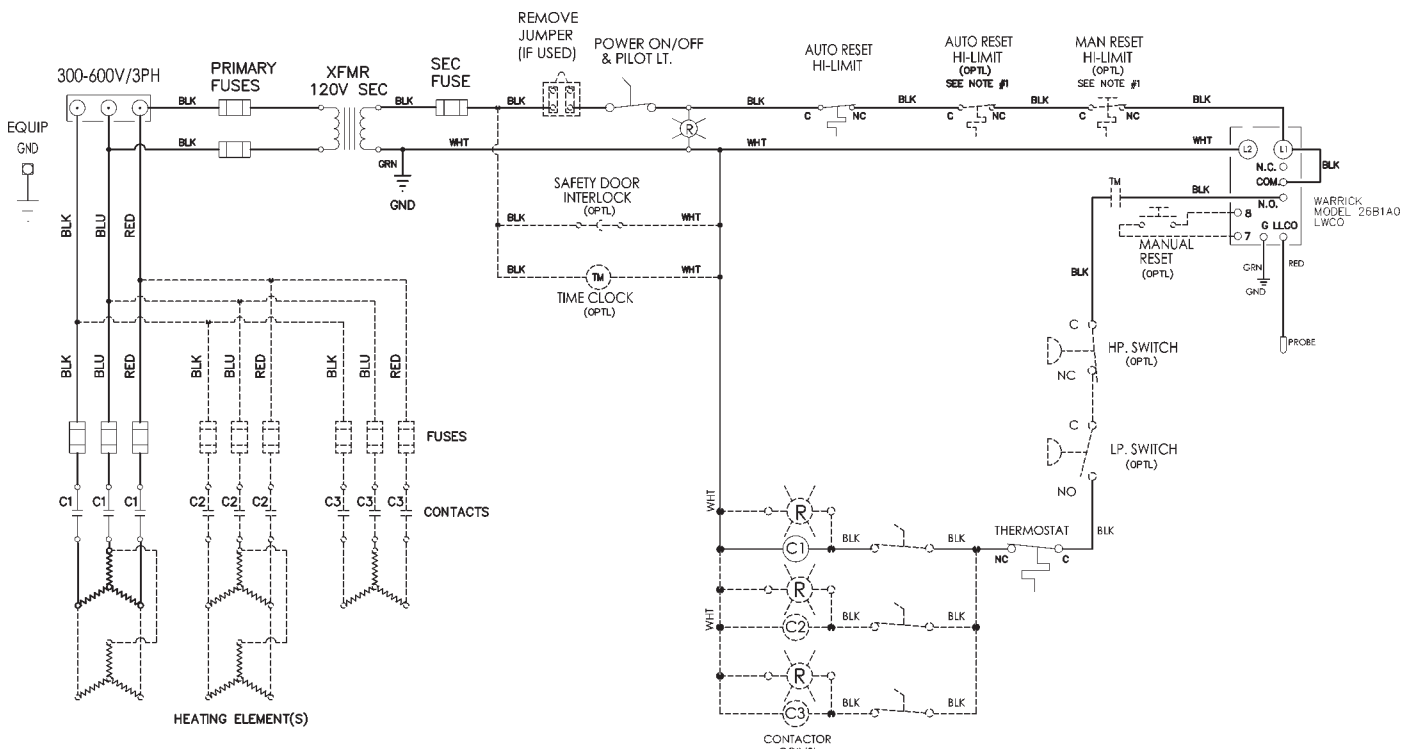

- NOTE(S):
1. IF A MANUAL RESET HLMT IS USED, THE SECOND AUTO RESET HLMT SWITCH IS NOT USED.
- STD. WIRING
 - - - OPTIONAL OR FIELD WIRING AS REQ'D
- ⊙ CONTACTOR COIL
 ⓧ INDICATION LIGHT

DIAGRAM 2.
THREE PHASE WYE WITH THERMOSTAT

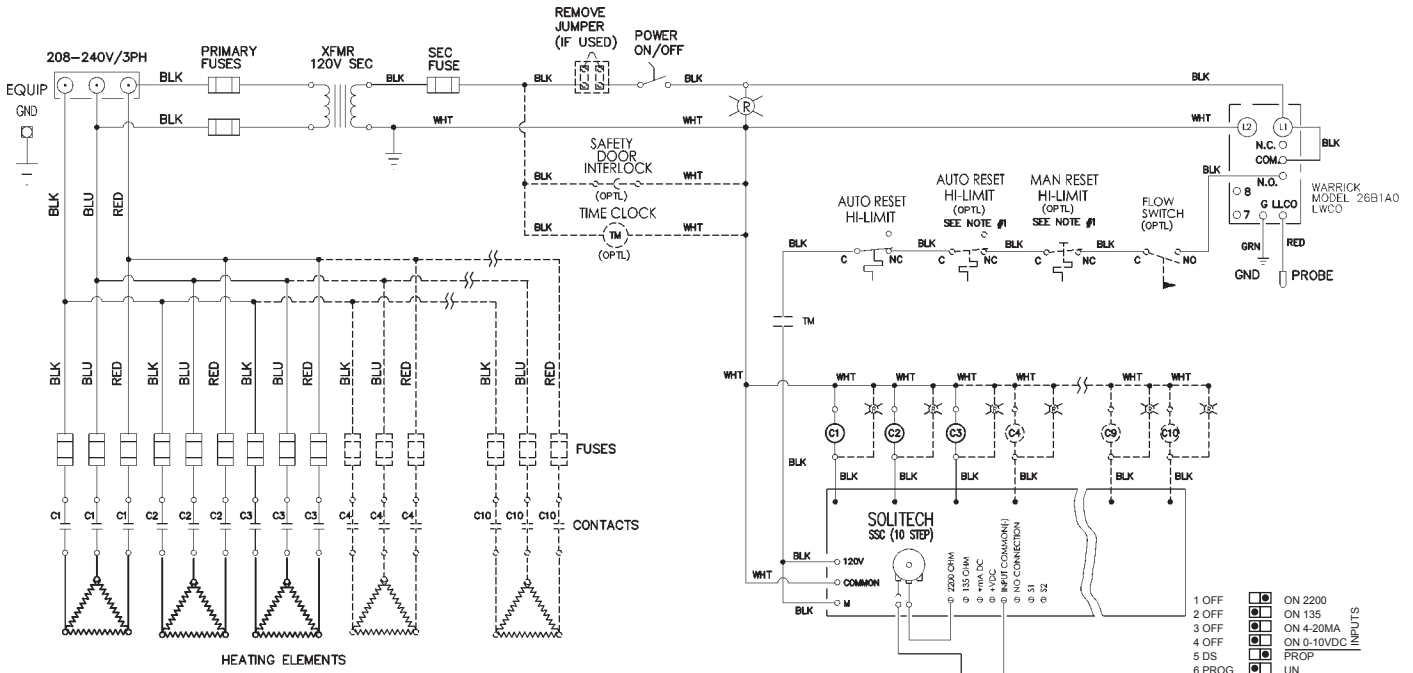

NOTE(S):
 1. SUBSTITUTE A MANUAL RESET HLMT SWITCH FOR ONE(1) OF THE AUTO RESET HLMT SWITCHES.
 ——— STD. WIRING
 - - - - - OPTIONAL OR FIELD WIRING AS REQ'D
 ○ CONTACTOR COIL
 ⓧ INDICATION LIGHT

DIAGRAM 3.
THREE PHASE DELTA WITH STEP CONTROL

INPUTS	DELAY	STAGES
1 OFF	ON 2200	1
2 OFF	ON 135	2
3 OFF	ON 4-20MA	3
4 OFF	ON 0-10VDC	4
5 DS	PROP	5
6 PROG	UN	6
7 OFF	VER	7
8 SEC	MIN	8

THE ABOVE DIP SWITCH SETTINGS ARE AN EXAMPLE FOR THE FOLLOWING:
 2200 OHM
 PROPORTIONAL
 PROGRESSIVE
 VERNER "OFF"
 SECONDS
 10 SECOND
 3 STAGE

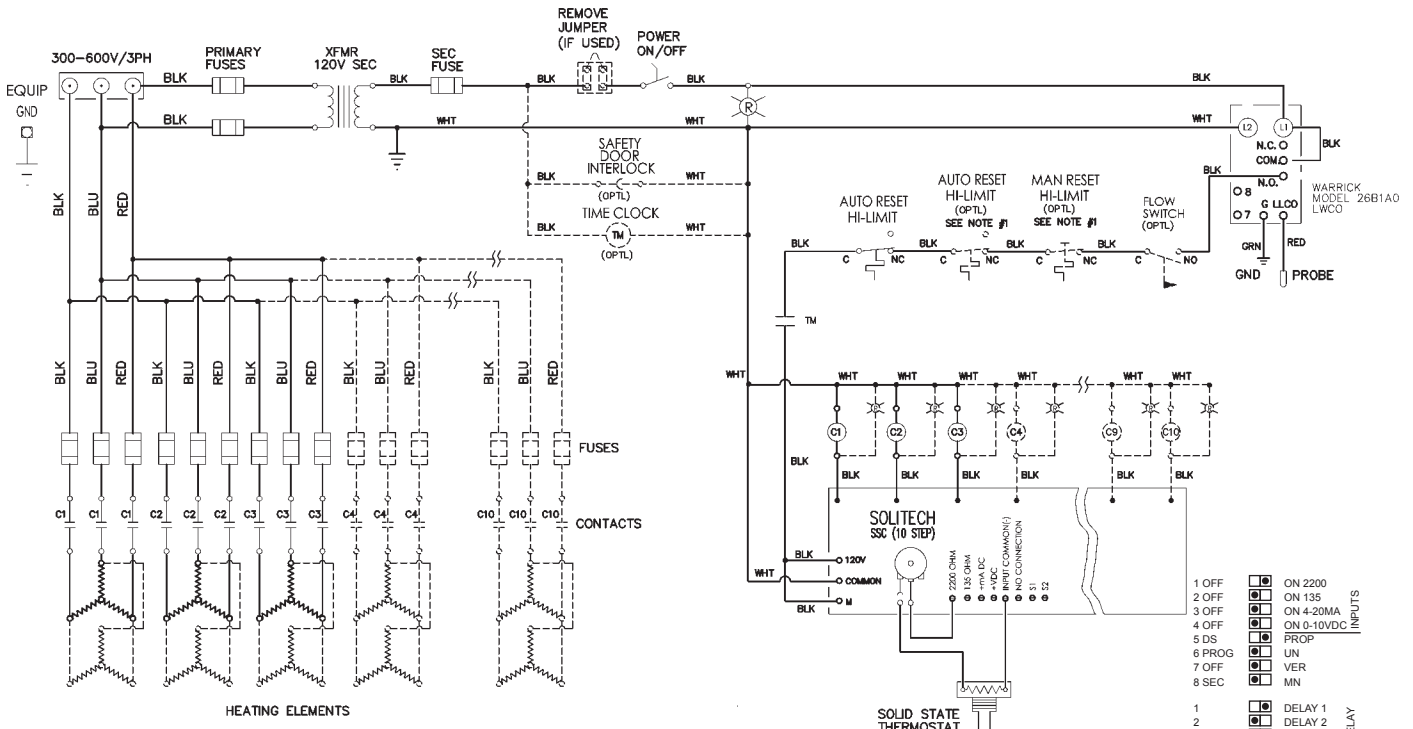

NOTE(S):
 1. SUBSTITUTE A MANUAL RESET HLMT SWITCH FOR ONE(1) OF THE AUTO RESET HLMT SWITCHES.
 ——— STD. WIRING
 - - - - - OPTIONAL OR FIELD WIRING AS REQ'D
 ○ CONTACTOR COIL
 ⓧ INDICATION LIGHT

DIAGRAM 4.
THREE PHASE WYE WITH STEP CONTROL

INPUTS	DELAY	STAGES
1 OFF	ON 2200	1
2 OFF	ON 135	2
3 OFF	ON 4-20MA	3
4 OFF	ON 0-10VDC	4
5 DS	PROP	5
6 PROG	UN	6
7 OFF	VER	7
8 SEC	MIN	8

THE ABOVE DIP SWITCH SETTINGS ARE AN EXAMPLE FOR THE FOLLOWING:
 2200 OHM
 PROPORTIONAL
 PROGRESSIVE
 VERNER "OFF"
 SECONDS
 10 SECOND
 3 STAGE

IMPORTANT

IT IS RECOMMENDED THAT A QUALIFIED SERVICE TECHNICIAN PERFORM THE INITIAL FIRING OF THE BOILER. AT THIS TIME THE USER SHOULD NOT HESITATE TO ASK THE TECHNICIAN ANY QUESTIONS WHICH THEY MAY HAVE IN REGARD TO THE OPERATION AND MAINTENANCE OF THE BOILER.

BEFORE FILLING THE SYSTEM FOR OPERATION the hot water system should be internally cleaned and flushed to remove any contaminants which may have accumulated during installation. See section of this manual titled SYSTEM CLEANING.

GENERAL

Never operate the heating elements without being certain the boiler is filled with water and a pressure relief valve is installed in the relief valve opening provided.

LWCO

An electronic type low water cutoff is provided on all boilers as standard equipment. The water probe is installed near the top of the tank to monitor the presence of water. The control circuit is opened if the water level is below this point.

Power On/Off

The pilot switch on the cabinet front permits the boiler to be turned on and off without having to operate the electrical disconnect switch. Additional switches may be provided for manually operating contactor coils.

Relief Valve

An ASME rated pressure relief valve is furnished with the boiler. A fitting for the relief valve is provided in the top of the boiler. A drain line from the relief valve should terminate near a suitable drain. Do not thread, plug, or cap the end of the drain line.

The pressure setting of the relief valve should not exceed the pressure capacity of any component in the system including the boiler.

HIGH TEMPERATURE LIMITS

Automatic High Limit

The boiler control circuit contains two high temperature cutoff switches. This device shuts off the heating elements if excessive water temperatures are reached. The high temperature cutoff has an adjustable range of 100° to 240°F and automatically resets on a drop of temperature.

Manual High Limit (Optional)

A manual reset high limit may be in the control circuit in addition to the automatic high limit previously described. The control has an adjustable range of 110°F to 290°F and activates and locks on a temperature increase. When the temperature declines the manual reset high limit can be reset. A manual reset high limit is an optional substitution for one of the automatic high limits mentioned above.

The manual reset button is located on the high limit switch which is located in the control panel.



⚠ DANGER

Full power is present whenever the cabinet door is opened even with the pilot switch turned off.

FILLING THE BOILER

Refer to SYSTEM CLEANING section for preparing the system prior to final filling and operation.

CAUTION

Property Damage Hazard

In order to avoid boiler damage, fill tank with water before operating.

Hard Water: in areas which have hard water it may be desirable to fill the system with soft water and/or provide water treatment as recommended by a consultant familiar with local conditions. In this way harmful water scale build-up on the heating elements is minimized.

1. Close the boiler drain valve and system valves as necessary.
2. Open a vent in the highest point of the system to allow the air to escape.
3. Fully open the make-up water inlet valve. Fill the boiler and piping.
4. Close the vent as water starts to flow from the opening. Place the make-up water valve in the desired position. The boiler is now ready for START UP and TEMPERATURE REGULATION if being placed in operation for the first time.

INITIAL START UP

The following checks should be made by the installer when the boiler is placed into operation for the first time:

1. Check all factory and field made water and electrical connections for tightness.
 - Repair water leaks and tighten electrical connections as necessary.
2. Turn on the electrical disconnect switch and pilot switch(es) mounted on the boiler cabinet.
3. Observe the operation of the boiler during the first heating cycle.
 - Temperature control and contactor operation should be checked by allowing the boiler to come up to temperature and shutoff automatically.

TEMPERATURE REGULATION

Always turn off the electricity at the electrical disconnect switch when making a temperature control adjustment.

It is suggested the temperature adjustment be turned to the lowest setting which satisfies the hot water requirements of the system.

TEMPERATURE CONTROLS

The boilers covered in this instruction manual are equipped with (adjustable) thermostat or step control to regulate water temperature and other controls to provide safety features. See the wiring diagrams on page 13 & 14 and/or literature included with this manual for additional information.

Hot water temperatures required for automatic dishwasher and laundry use can cause scald burns resulting in serious personal injury and/or death. The temperature at which injury occurs varies with the person's age and duration of exposure. The slower response time of children, the elderly or disabled persons increases the hazards to them. Never allow small children to use a hot water tap or draw their own bath water. Never leave a child or disabled person unattended in a bathtub or shower. The boiler should be located in an area where the general public does not have access to set temperatures.

Figure 1. shows the approximate time-to-burn relationship for normal adult skin.

Water Temperature	Time to Produce 2nd & 3rd Degree Burns on Adult Skin
180°F (82°C)	Nearly Instantaneous
160°F (82°C)	About 1/2 second
150°F (82°C)	About 1-1/2 seconds
140°F (82°C)	Less than 5 seconds
130°F (82°C)	About 30 seconds
120°F (82°C)	More than 5 minutes
80°F (82°C)	-----

FIGURE 1.

- Additional instructional literature is provided with the boiler for adjusting this control.

Always close and lock the cabinet door after making a temperature adjustment. Turn on electricity.

DRAINING

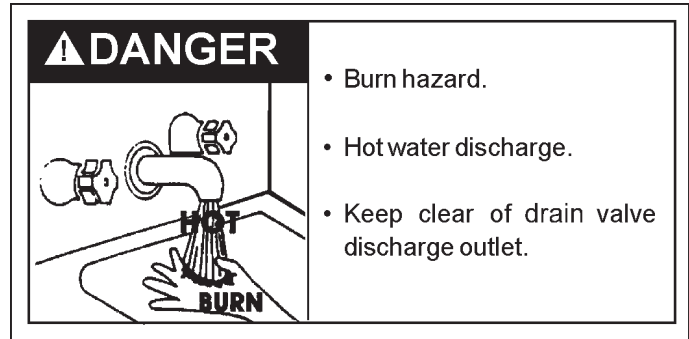

The boiler must be drained if it is to be shut down and exposed to freezing temperatures. Maintenance and service procedures may also require draining the boiler.

1. Turn off the electrical disconnect switch.
2. Open a nearby outlet until the water is no longer hot and close the make-up water valve and system valves as necessary.
3. Open a nearby outlet to vent the parts of the system being drained.
4. Open the boiler drain valve.
5. If the boiler is being drained for an extended shutdown, it is suggested the drain valve be left open during this period.
 - Follow FILLING instructions to restore boiler to service.

MAINTENANCE

Boiler maintenance includes periodic tank flushing and cleaning, and removal of lime scale from the heating elements. Circulating pumps should be oiled.

MAINTENANCE SCHEDULE

Component	Operation	Interval	Required
Tank	Flushing	Monthly	
	Sediment Removal	As Needed	
Elements	Lime Scale Removal	As Needed	UN•LIME® Delimer and element gaskets
Circulating Pump(s)	Oiling	Per pump makers instructions	
Pressure Relief Valve Test	Manually Operate	Annually	

PRESSURE RELIEF VALVE TEST

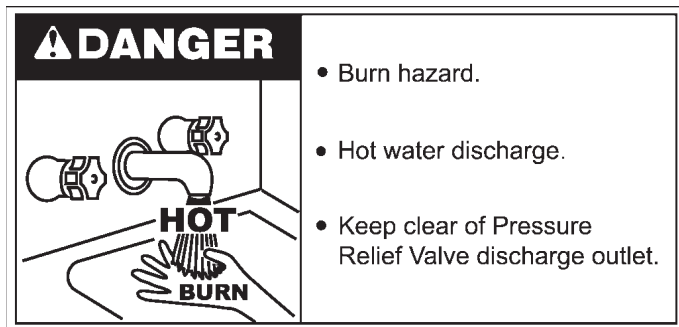

The pressure relief valve must be manually operated at least once a year. Caution should be taken to ensure that (1) no one is in front of or around the outlet of the pressure relief valve discharge line, and (2) the water manually discharged will not cause any bodily injury or property damage because the water may be extremely hot.

To test the relief valve, lift the lever at the end of the valve several times, see Figure 2. The valve should seat properly and operate freely.

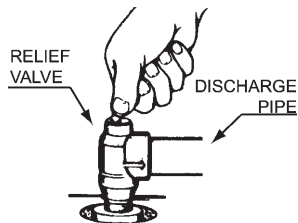

FIGURE 2.

If after manually operating the valve, it fails to completely reset and continues to release water, turn off power to the boiler at the main disconnect switch or breaker. Close the cold water inlet to the boiler and follow the draining instructions in this manual to drain the boiler. Should the relief valve need to be replaced, call the toll free phone number listed on the back of this manual for further technical assistance.

Tank flushing and circulating pump lubrication should be performed in accordance with the above schedule. Tank sediment removal and element lime scale removal must be performed when needed as determined by period inspections. Following are the instructions for performing recommended maintenance.

SYSTEM CLEANING

The hot water system should be internally cleaned and flushed to remove contaminants which may have accumulated during installation. System cleaning provides chemical stability necessary for component life and system performance.

Failure to clean the system may cause:

- Poor heating due to formation of gas.
 - Residential pipe dope, thread cutting oil, solder flux, dirt and other foreign materials breakdown to form gas. This is indicated by a continuing need for purging even through the system is "closed".
- Pump seal leakage.
 - Acidic water (low pH) and contamination such as soil and sand result in premature or recurring pump seal failures.
- Automatic air valve leakage.
 - Contaminants cause sticky sealing surfaces and result in leakage.
- Relief valve operation.
 - Gas formation increases system pressure and relief valve spillage.
- Water leaks at joints and fittings.
 - Corrosion and eventual failure of connections occur when system pH is low.
- Noisy operation.
 - Heat transfer surfaces can be fouled with dirty, oily water. This plus gas lead to noisy water circulation.

FLUSHING

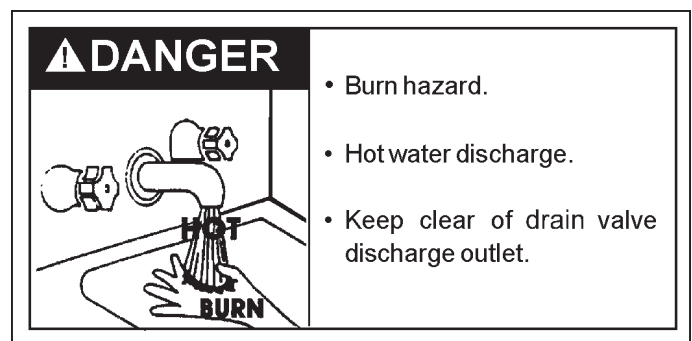

- Turn off the electrical disconnect switch.
- Open the boiler drain valve. Allow water to flow to an open drain until it runs clean. Do not come in contact with the water being drained as it may be very hot.
- Close the drain valve when finished flushing.
- Turn on the electrical disconnect switch.

SEDIMENT REMOVAL

Water borne impurities consist of fine particles of soil and sand which settle out and form a layer of sediment on the bottom of the tank. In time, if not removed, the level of sediment might reach the heating elements.

For convenience, sediment removal and element lime scale removal should be performed at the same time as follows:

WATER AND LIME SCALE REMOVAL

Water and lime scale accumulations on the heating elements is a normal condition, common to all immersion type elements. Factors which affect the amount of this formation are:

- Amount of make-up water used. As the volume of make-up water heated increases, more scale results.
- Water temperature. As the temperature of the water is increased, more scale is deposited on the elements.
- Characteristics of water supply. Regardless of water treatment, the elements should be examined regularly.

Water scale accumulations may cause noises to occur during operation.

It is recommended that a lower heating element be removed periodically for examination. If it is scaled, all of the elements should be removed and cleaned. If the tank bottom has an accumulation of sediment, it should be cleaned.

Lime scale should be removed from the elements by dissolving the accumulation in UN•LIME® delimer. UN•LIME is a non-muriatic delimer, available through your dealer or distributor. Do not use muriatic or hydrochloric acid base deliming solutions to remove lime scale from the elements. Do not pour delimer into tank.

All models:

1. Turn off electrical disconnect switch.
2. Drain the boiler following DRAINING instructions.
3. Remove the cabinet panel which covers the heating elements.
 - Remove insulation as necessary to reach the element area.
4. Remove the bolts from each element and remove the elements from the opening.
 - Disconnect element wiring as necessary.
 - Use a twisting, pulling action to remove elements scaled beyond the size of the tank opening.
 - Brush loose scale from elements.
 - Silicates, sulfates and aluminates must be removed by scraping or other mechanical means. Lime scale solvents will not remove these types of scale which are occasionally encountered.
5. Lime scale removal:

- Place limed ends of heating elements into UN•LIME delimer and allow scale to dissolve. Do not permit delimer or water to contact heating element electrical terminals.
6. Flush cleaned ends of elements with water when deliming or cleaning is completed.
 7. Remove sediment and scale from the tank bottom through the tank cleanout.
 - The make-up water valve and boiler drain valve may be opened to flush during the cleanout process.
 8. Clean remaining gasket material from tank and element flanges. Do not reuse original element gasket. The element gasket is Part No. 5109.
 9. Replace elements as follows:
 - Put a new gasket on each element.
 - Install into tank opening.
 - Uniformly tighten element bolts. Torque to approximately 32 ft /lbs.
 10. Connect element wiring as necessary.
 11. Follow FILLING instructions to restore boiler to service.
 - Check for water leaks around elements and proper operation when boiler is filled.
 - Replace insulation and cabinet panel.

TROUBLESHOOTING CHECKLIST

Before calling for service, check the following points to see if the cause of trouble can be identified and corrected. Reviewing this checklist may eliminate the need of a service call and quickly restore the boiler to service. The illustration on page 5 identifies the location of most of the boiler components.

BE SURE TO TURN OFF THE ELECTRICITY WHEN CHECKING EQUIPMENT.

Not enough or no hot water

1. Be certain the electrical disconnect switch serving the boiler is in the ON position. The pilot switch(es) on the cabinet front should be on.
 - In some installations the boiler electrical service may be limited by the power company or boiler controls. If the boiler operates on a controlled circuit heat may be effected.
2. Check the fuses.
 - The electrical disconnect switch usually contains fuses.
 - The boiler has fuses located behind the cabinet door, see page 5 for location.
3. If the water was excessively hot, and is now cold, the high temperature cutoff may have operated (manual reset equipped models).
 - To reset, turn off electricity and remove the back panel and push the reset button.
 - Repeated operation of the high temperature cutoff should be investigated by your servicer.
4. The capacity of the boiler may have been exceeded by a large demand for heat.
 - Large demands require a recovery period to restore water temperature.
5. Sediment or lime scale may be affecting boiler operation. Refer to MAINTENANCE for details.

Water is too hot

1. Refer to TEMPERATURE REGULATION.

Boiler makes sounds

1. Sediment or lime scale accumulation on the elements may cause

- sizzling and hissing noises when the boiler is operating.
- The sounds are normal, however, the tank bottom and elements should be cleaned. Refer to MAINTENANCE for details.
2. Some of the electrical components of the boiler make sounds which are normal.
 - Contactors will "click" or snap as the boiler starts and stops.
 - Transformers and contactors often hum.

Water leakage is suspected

1. Check to see if the drain valve is tightly closed.
2. If the outlet of the relief valve is leaking it may represent:
 - Excessive water pressure or air in the system.
 - Faulty relief valve.
3. Examine the flange area of the elements and tank cleanout for gasket leakage.
 - Tighten the bolts or, if necessary, follow the WATER AND LIME SCALE REMOVAL procedure to replace the gaskets.

SYSTEM WATER TEST

System water test

Review SYSTEM CLEANING section, for a description of six problems which result from loss of system chemical stability. Chemical stability is checked by:

1. Draw off water from system. Is it dirty, discolored or odorous?
2. What is the pH of the system water? It should be neutral or slightly alkaline.
3. Does "air" purged from system vents burn? If so, the "air" is actually gas.

If any of the above conditions are present, all waterways should be cleaned and the water adjusted to an alkaline condition.

If you cannot identify or correct the source of malfunction:

1. Place the boiler electrical disconnect switch in the OFF position.
2. Close the make-up water inlet valve to the boiler.
3. Contact your servicer.

SW-37 THRU SW-670 ELECTRIC HOT WATER BOILER LIMITED WARRANTY

State Water Heaters, the warrantor, extends the following LIMITED WARRANTY to the owner of this boiler.

1. THE TANK

If the tank in this boiler shall prove upon examination by the warrantor to have leaked due to natural corrosion from water therein, during the FIRST year after initial installation, the warrantor will at its option, repair it or provide a replacement tank less elements and controls of equivalent size and then current model. Some government agencies are requiring energy efficient standards for boilers. In the event regulations prohibit sale of a model of equivalent size and construction, State Water Heaters will provide a model which complies with the regulations of your area, in which case the consumer will be charged the difference in price between the like replacement and the energy efficient model required. The warranty on the repair or replacement of the part, portion or tank will be limited to the unexpired term of the original warranty.

2. ALL OTHER PARTS

If within ONE year after initial installation of this boiler, any part or portion shall prove upon examination by the warrantor to be defective in material or workmanship, the warrantor will repair or replace such part or portion at its option.

3. CONDITIONS AND EXPECTATIONS

This warranty shall apply only when the boiler is installed in accordance with local plumbing and building codes, ordinances and regulations, the printed instructions provided with it and good industry practices. In addition, a pressure relief valve, approved by the American Society of Mechanical Engineers, must have been installed.

This warranty shall apply only when the boiler is used:

- a. (1) at temperatures not exceeding the maximum setting of its control;
- (2) at water pressure not exceeding the working pressure shown on the boiler;
- (3) when filled with water, free to circulate at all times and with the tank free of damaging scale deposits;
- (4) in a noncorrosive and non-contaminated atmosphere;
- (5) in its original installation location;
- (6) in the United States, its territories or possessions, and Canada;
- (7) when operated free of the damaging effects of uncontrolled thermal expansion and/or water hammer.
- b. Any accident to the boiler, any misuse, abuse (including freezing) or alteration of it, any operation of it in a modified form will void this warranty.

4. SERVICE AND REPAIR EXPENSE

Under this limited warranty the warrantor will provide only repair or a replacement tank or part thereof. The owner is responsible for all other costs. Such costs may include but are not limited to:

- a. Labor charges for service, removal, repair, or reinstallation of the tank or any component part;
- b. Shipping, delivery, handling, and administrative charges for forwarding the new tank or replacement part from the nearest distributor and returning the claimed defective tank or part to such distributor.
- c. All cost necessary or incidental for any materials and/or permits required for installation of the replacement tank or part.

5. LIMITATION ON IMPLIED WARRANTIES

Implied warranties, including any warranty of merchantability imposed on the sale of this boiler under state law are limited to one (1) year duration for the tank or any of its parts. Some states do not allow limitations on how long an implied warranty lasts, so the above limitation may not apply to you.

6. CLAIM PROCEDURE

Any claim under this warranty should be initiated with the dealer who sold the boiler, or with any other dealer handling the warrantor's products. If this is not practicable, the owner should contact:

U.S. Customers
State Water Heaters
500 Tennessee Waltz Parkway
Ashland City, TN 37015
Telephone: 800-365-0024

Canadian Customers
State Water Heaters
599 Hill St. W.
Fergus, ON N1M 2X1
Attn: Warranty
Telephone: 888-479-9283

- a. The warrantor will only honor replacement with identical or similar tank or parts thereof which are manufactured or distributed by the warrantor.
- b. Dealer replacements are made subject to in-warranty validation by warrantor.

7. DISCLAIMER

NO OTHER EXPRESS WARRANTY HAS BEEN OR WILL BE MADE IN BEHALF OF THE WARRANTOR WITH RESPECT TO THE BOILER OR THE INSTALLATION, OPERATION, REPAIR OR REPLACEMENT OF THE TANK OR PARTS. THE WARRANTOR SHALL NOT BE RESPONSIBLE FOR WATER DAMAGE, LOSS OF USE OF THE UNIT, INCONVENIENCE, LOSS OR DAMAGE TO PERSONAL PROPERTY, OR OTHER CONSEQUENTIAL DAMAGE. THE WARRANTOR SHALL NOT BE LIABLE BY VIRTUE OF THIS WARRANTY OR OTHERWISE FOR DAMAGE TO ANY PERSONS OR PROPERTY, WHETHER DIRECT OR INDIRECT, AND WHETHER ARISING IN CONTRACT OR IN TORT.

- a. Some states do not allow the exclusion or limitation of the incidental or consequential damage, so the above limitation or exclusion may not apply to you.
- b. This warranty gives you specific legal rights, and you may also have other rights which vary from state to state.

Fill in the following for your own reference. Keep it. Registration is not a condition of warranty. The model and ASME numbers are found on the boiler's rating plate.

Model No. _____ ASME No. _____ Date Installed _____
Dealer's Name _____
Dealer's Address _____ Phone No. _____
City and State _____ Zip _____

KEEP THIS WARRANTY AND MANUAL POSTED ADJACENT TO THE BOILER FOR FUTURE REFERENCE WHENEVER MAINTENANCE, ADJUSTMENT OR SERVICE IS REQUIRED. BE SURE YOUR DEALER HAS FILLED IN THIS WARRANTY.



A DIVISION OF A. O. SMITH CORPORATION
RENTON, WASHINGTON
Technical Support: 800 527-1953
Parts Department: 800 433-2515
www.statewaterheaters.com

Free Manuals Download Website

<http://myh66.com>

<http://usermanuals.us>

<http://www.somanuals.com>

<http://www.4manuals.cc>

<http://www.manual-lib.com>

<http://www.404manual.com>

<http://www.luxmanual.com>

<http://aubethermostatmanual.com>

Golf course search by state

<http://golfingnear.com>

Email search by domain

<http://emailbydomain.com>

Auto manuals search

<http://auto.somanuals.com>

TV manuals search

<http://tv.somanuals.com>