

MODELS SBD71120NE THRU SBD85500NE

COMMERCIAL GAS, GLASS-LINED, TANK-TYPE WATER HEATER

• INSTALLATION • OPERATION • MAINTENANCE • LIMITED WARRANTY



Thank you for buying this energy efficient water heater from State Water Heaters. We appreciate your confidence in our product.

WARNING: If the information in these instructions is not followed exactly, a fire or explosion may result causing property damage, personal injury or death.

- Do not store or use gasoline or other flammable vapors and liquids in the vicinity of this or any other appliance.
- **WHAT TO DO IF YOU SMELL GAS**
 - Do not try to light any appliance.
 - Do not touch any electrical switch; do not use any phone in your building.
 - Immediately call your gas supplier from a neighbor's phone. Follow the gas supplier's instructions.
 - If you cannot reach your gas supplier, call the fire department.
- Installation and service must be performed by a qualified installer, service agency or the gas supplier.



CAUTION

TEXT PRINTED OR OUTLINED IN RED CONTAINS INFORMATION RELATIVE TO YOUR SAFETY. PLEASE READ THOROUGHLY BEFORE INSTALLING AND USING THIS APPLIANCE.



500 Lindahl Parkway
Ashland City, TN 37015

PLACE THESE INSTRUCTIONS ADJACENT TO HEATER
AND NOTIFY OWNER TO KEEP FOR FUTURE REFERENCE.

ROUGH-IN-DIMENSIONS

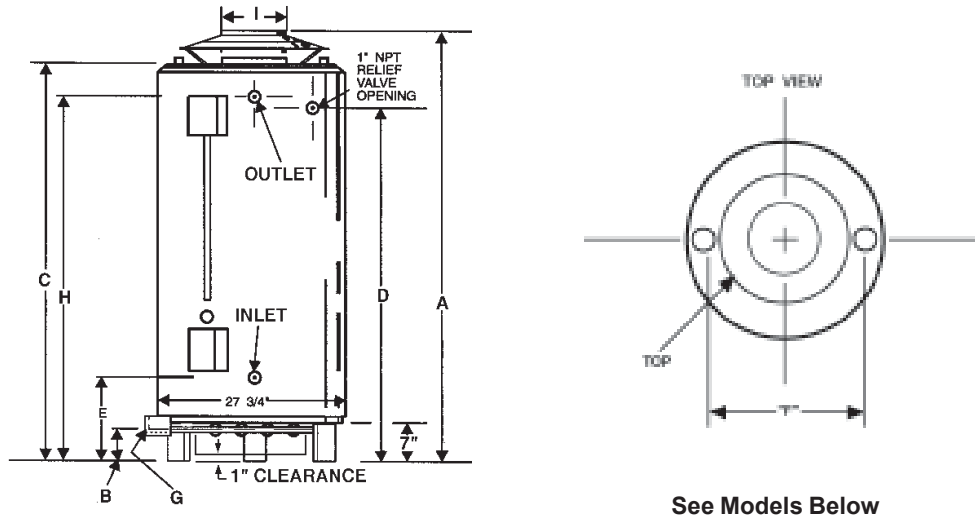

FIGURE 1

STANDARD SANDBLASTER - TABLE 1A

MODEL	INPUT RATE BTU/Hr.	APPROX. TANK CAP.	A	B	C	D	E	F	GAS INLET G	H	VENT DIA I	J	CONNECTIONS						Approximate Ship. Weight	
													INLET			OUTLET			STD.	ASME
													TOP	FRONT	BACK	TOP	FRONT	BACK		
SBD71120	120,000 BTU/Hr. 35 kW/Hr	71 Gal 268L	69.75" 177 cm	4.25" 11 cm	59.50" 151 cm	50.87" 129 cm	19.69" 50 cm	19" 48 cm	1/2" 1/2"	51.88" 132 cm	5" 13 cm	27.75" 71 cm	1.50" 1.50"	1.50" 1.50"	1.50" 1.50"	1.50" 1.50"	1.50" 1.50"	400 Lbs 182 Kg	NA NA	
SBD81154	154,000 BTU/Hr 45 kW/Hr	81 Gal 307L	73.00" 185 cm	4.25" 11 cm	66.50" 169 cm	57.87" 147 cm	19.69" 50 cm	19" 48 cm	1/2" 1/2"	59.00" 150 cm	6" 15 cm	27.75" 71 cm	1.50" 1.50"	1.50" 1.50"	1.50" 1.50"	1.50" 1.50"	1.50" 1.50"	470 Lbs 213 Kg	NA NA	
SBD81180	180,000 BTU/Hr 53 kW/Hr	81 Gal 307L	67.50" 171 cm	4.50" 12 cm	62.00" 157 cm	53.62" 136 cm	20.50" 52 cm	21" 53 cm	1/2" 1/2"	54.62" 139 cm	6" 15 cm	27.75" 71 cm	1.50" 1.50"	1.50" 1.50"	1.50" 1.50"	1.50" 1.50"	1.50" 1.50"	470 Lbs 213 Kg	NA NA	
SBD100199*	199,000 BTR/Hr 58 kW/Hr	100 Gal 379L	75.00" 192 cm	4.50" 12 cm	70.00" 178 cm	61.62" 157 cm	20.50" 52 cm	21" 53 cm	1/2" 1/2"	62.62" 159 cm	6" 15 cm	27.75" 71 cm	1.50" 1.50"	1.50" 1.50"	1.50" 1.50"	1.50" 1.50"	1.50" 1.50"	603 Lbs 273 Kg	NA NA	
SBD100199	199,000 BTU/Hr. 58 kW/Hr	100 Gal 379L	75.00" 192 cm	4.50" 12 cm	70.00" 178 cm	61.62" 157 cm	20.50" 52 cm	21" 53 cm	1/2" 1/2"	61.50" 150 cm	6" 15 cm	27.75" 71 cm	1.50" 1.50"	1.50" 1.50"	2.00" 2.00"	1.50" 1.50"	1.50" 1.50"	603 Lbs 273 Kg	NA NA	
SBD81190	190,000 BTR/Hr 56 kW/Hr	81 Gal 307L	67.50" 171 cm	4.50" 12 cm	62.00" 157 cm	53.62" 136 cm	20.50" 52 cm	21" 53 cm	1/2" 1/2"	54.62" 139 cm	6" 15 cm	27.75" 71 cm	1.50" 1.50"	1.50" 1.50"	1.50" 1.50"	1.50" 1.50"	1.50" 1.50"	470 Lbs 213 Kg	NA NA	
SBD100199**	199,000 BTR/Hr 58 kW/Hr	100 Gal 379L	72.00" 183 cm	4.50" 12 cm	65.13" 165 cm	55.87" 142 cm	19.75" 50 cm	23" 58 cm	1/2" 1/2"	56.38" 143 cm	6" 15 cm	30.25" 77 cm	1.50" 1.50"	2.00" 2.00"	2.00" 2.00"	1.50" 1.50"	2.00" 2.00"	630 Lbs 286 Kg	725 Lbs 329 Kg	
SBD100250	250,000 BTR/Hr 72 kW/Hr	100 Gal 379L	72.00" 183 cm	4.50" 12 cm	65.13" 165 cm	55.87" 142 cm	19.75" 50 cm	23" 58 cm	1/2" 1/2"	56.38" 143 cm	8" 20 cm	30.25" 77 cm	1.50" 1.50"	2.00" 2.00"	2.00" 2.00"	1.50" 1.50"	2.00" 2.00"	630 Lbs 286 Kg	725 Lbs 329 Kg	
SBD65251	251,000 BTR/Hr 73 kW/Hr	65 Gal 246L	75.00" 191 cm	4.50" 12 cm	65.75" 167 cm	57.25" 145 cm	20.00" 51 cm	NA NA	1/2" 1/2"	58.75" 149 cm	8" 20 cm	27.75" 70 cm	1.50" 1.50"	1.50" 1.50"	NA NA	1.50" 1.50"	1.50" 1.50"	750 Lbs 341 Kg	862 Lbs 391 Kg	
SBD100275	275,000 BTR/Hr 80 kW/Hr	100 Gal 379L	72.00" 183 cm	4.50" 12 cm	65.13" 165 cm	55.87" 142 cm	19.75" 50 cm	23" 58 cm	1/2" 1/2"	56.38" 143 cm	8" 20 cm	30.25" 77 cm	1.50" 1.50"	2.00" 2.00"	2.00" 2.00"	1.50" 1.50"	2.00" 2.00"	630 Lbs 286 Kg	725 Lbs 329 Kg	
SBD65305	305,000 BTR/Hr 89 kW/Hr	65 Gal 246L	75.00" 191 cm	4.50" 12 cm	65.75" 167 cm	57.25" 145 cm	20.00" 51 cm	NA NA	1/2" 1/2"	58.75" 149 cm	8" 20 cm	27.75" 70 cm	1.50" 1.50"	1.50" 1.50"	NA NA	1.50" 1.50"	1.50" 1.50"	750 Lbs 341 Kg	862 Lbs 391 Kg	
SBD85365	365,000 BTR/Hr 107 kW/Hr	85 Gal 322L	79.50" 202 cm	4.50" 12 cm	70.25" 178 cm	62.50" 159 cm	22.50" 57 cm	23" 58 cm	3/4" 3/4"	63.00" 160 cm	8" 20 cm	27.75" 70 cm	1.50" 1.50"	1.50" 1.50"	1.50" 1.50"	1.50" 1.50"	1.50" 1.50"	725 Lbs 329 Kg	833 Lbs 379 Kg	
SBD100399	399,000 BTR/Hr 117 kW/Hr	100 Gal 379L	75.50" 192 cm	4.50" 12 cm	67.50" 171 cm	58.25" 148 cm	26.75" 68 cm	23" 58 cm	3/4" 3/4"	59.00" 150 cm	8" 20 cm	30.25" 77 cm	1.50" 1.50"	2.00" 2.00"	2.00" 2.00"	1.50" 1.50"	2.00" 2.00"	760 Lbs 345 Kg	874 Lbs 396 Kg	
SBD85500	500,000 BTR/Hr 147 kW/Hr	85 Gal 322L	82.25" 209 cm	4.50" 12 cm	73.50" 187 cm	65.25" 166 cm	25.50" 65 cm	21" 53 cm	1" 1"	65.75" 167 cm	8" 20 cm	27.75" 70 cm	1.50" 1.50"	1.50" 1.50"	1.50" 1.50"	1.50" 1.50"	1.50" 1.50"	745 Lbs 338 Kg	857 Lbs 389 Kg	

* Tall model.
** Short model.

CANADIAN - STANDARD SANDBLASTER - TABLE 1B

MODEL (CGA)	INPUT RATE BTU/Hr.	APPROX. TANK CAP.	A	B	C	D	E	F	GAS INLET G	H	VENT DIA I	J	CONNECTIONS						Approximate Ship. Weight	
													INLET			OUTLET			STD.	ASME
													TOP	FRONT	BACK	TOP	FRONT	BACK		
SBD71120	120,000 BTU/Hr. 35 kW/Hr	71 Gal 268L	69.75" 177 cm	4.25" 11 cm	59.50" 151 cm	50.87" 129 cm	19.69" 50 cm	19" 48 cm	1/2" 1/2"	51.88" 132 cm	5" 13 cm	27.75" 71 cm	1.50" 1.50"	1.50" 1.50"	1.50" 1.50"	1.50" 1.50"	1.50" 1.50"	400 LBS 182 Kg	NA NA	
SBD81154	154,000 BTU/Hr 45 kW/Hr	81 Gal 307L	73.00" 185 cm	4.25" 11 cm	66.50" 169 cm	57.87" 147 cm	19.69" 50 cm	19" 48 cm	1/2" 1/2"	59.00" 150 cm	6" 15 cm	27.75" 71 cm	1.50" 1.50"	1.50" 1.50"	1.50" 1.50"	1.50" 1.50"	1.50" 1.50"	470 LBS 213 Kg	NA NA	
SBD76180	180,000 BTU/Hr 53 kW/Hr	76 Gal 288L	70.50" 179 cm	4.25" 11 cm	63.75" 162 cm	55.13" 140 cm	17.75" 45 cm	19" 48 cm	1/2" 1/2"	56.50" 144 cm	6" 15 cm	27.75" 71 cm	1.50" 1.50"	1.50" 1.50"	1.50" 1.50"	1.50" 1.50"	1.50" 1.50"	470 LBS 213 Kg	NA NA	
SBD95199	199,000 BTR/Hr 58 kW/Hr	95 Gal 360L	81.50" 207 cm	4.25" 11 cm	74.75" 190 cm	66.13" 168 cm	17.75" 45 cm	19" 48 cm	1/2" 1/2"	67.50" 171 cm	6" 15 cm	27.75" 71 cm	1.50" 1.50"	1.50" 1.50"	1.50" 1.50"	1.50" 1.50"	1.50" 1.50"	603 LBS 273 Kg	NA NA	
SBD76190	190,000 BTR/Hr 56 kW/Hr	76 Gal 288L	70.50" 179 cm	4.25" 11 cm	63.75" 162 cm	55.13" 140 cm	17.75" 45 cm	19" 48 cm	1/2" 1/2"	56.50" 144 cm	6" 15 cm	27.75" 71 cm	1.50" 1.50"	1.50" 1.50"	1.50" 1.50"	1.50" 1.50"	1.50" 1.50"	470 LBS 213 Kg	NA NA	
SBD100199	199,000 BTR/Hr 58 kW/Hr	100 Gal 379L	72.00" 183 cm	4.50" 12 cm	65.13" 165 cm	55.87" 142 cm	19.75" 50 cm	23" 58 cm	1/2" 1/2"	56.38" 143 cm	6" 15 cm	30.25" 77 cm	1.50" 1.50"	2.00" 2.00"	2.00" 2.00"	1.50" 1.50"	2.00" 2.00"	630 lbs 286 Kg	725 lbs 329 Kg	
SBD100250	250,000 BTR/Hr 72 kW/Hr	100 Gal 379L	72.00" 183 cm	4.50" 12 cm	65.13" 165 cm	55.87" 142 cm	19.75" 50 cm	23" 58 cm	1/2" 1/2"	56.38" 143 cm	8" 20 cm	30.25" 77 cm	1.50" 1.50"	2.00" 2.00"	2.00" 2.00"	1.50" 1.50"	2.00" 2.00"	630 lbs 286 Kg	725 lbs 329 Kg	
SBD65251	251,000 BTR/Hr 73 kW/Hr	65 Gal 246L	75.00" 191 cm	4.50" 12 cm	65.75" 167 cm	57.25" 145 cm	20.00" 51 cm	NA NA	1/2" 1/2"	58.8" 149 cm	8" 20 cm	27.75" 70 cm	1.50" 1.50"	1.50" 1.50"	NA NA	1.50" 1.50"	1.50" 1.50"	750 lbs 341 Kg	862 lbs 391 Kg	
SBD100275	275,000 BTR/Hr 80 kW/Hr	100 Gal 379L	72.00" 183 cm	4.50" 12 cm	65.13" 165 cm	55.87" 142 cm	19.75" 50 cm	23" 58 cm	1/2" 1/2"	56.38" 143 cm	8" 20 cm	30.25" 77 cm	1.50" 1.50"	2.00" 2.00"	2.00" 2.00"	1.50" 1.50"	2.00" 2.00"	630 lbs 286 Kg	725 lbs 329 Kg	
SBD65305	305,000 BTR/Hr 89 kW/Hr	65 Gal 246L	75.00" 191 cm	4.50" 12 cm	65.75" 167 cm	57.25" 145 cm	20.00" 51 cm	NA NA	1/2" 1/2"	58.8" 149 cm	8" 20 cm	27.75" 70 cm	1.50" 1.50"	1.50" 1.50"	NA NA	1.50" 1.50"	1.50" 1.50"	750 lbs 341 Kg	862 lbs 391 Kg	
SBD65365	365,000 BTR/Hr 107 kW/Hr	85 Gal 322L	79.50" 199 cm	4.50" 12 cm	70.25" 178 cm	62.50" 159 cm	22.50" 57 cm	23" 58 cm	3/4" 3/4"	63.00" 160 cm	8" 20 cm	27.75" 70 cm	1.50" 1.50"	1.50" 1.50"	NA NA	1.50" 1.50"	1.50" 1.50"	750 lbs 341 Kg	862 lbs 391 Kg	
SBD100399	399,000 BTR/Hr 117 kW/Hr	100 Gal 379L	75.50" 192 cm	4.50" 12 cm	67.50" 171 cm	58.25" 148 cm	26.75" 68 cm	23" 58 cm	3/4" 3/4"	59.00" 150 cm	8" 20 cm	30.25" 77 cm	1.50" 1.50"	2.00" 2.00"	2.00" 2.00"	1.50" 1.50"	2.00" 2.00"	760 lbs 345 Kg	874 lbs 396 Kg	
SBD85500	500,000 BTR/Hr 147 kW/Hr	85 Gal 322L	82.25" 209 cm	4.50" 12 cm	73.50" 187 cm	65.25" 166 cm	25.50" 65 cm	21" 53 cm	1" 1"	65.8" 167 cm	8" 20 cm	27.75" 70 cm	1.50" 1.50"	1.50" 1.50"	1.50" 1.50"	1.50" 1.50"	1.50" 1.50"	745 lbs 338 Kg	857 lbs 389 Kg	

TABLE 1C - HEATER PERFORMANCE DATA SBD MODELS

MODEL	INPUT RATE BTUH	APPROX. GAL CAP.	EFF. %	RECOVERY RATING CAPACITIES (GPH AND LPH)											
				30° F	40° F	50° F	60° F	70° F	80° F	90° F	100° F	110° F	120° F	130° F	140° F
				(-) 1 C	4 C	10 C	15 C	21 C	27 C	32 C	38 C	43 C	49 C	54 C	60 C
SBD71120	120,000 BTUH 35 kW/Hr	71 Gal 268 L	80	388 1469	291 1102	233 882	194 734	166 628	145 549	129 488	116 439	106 401	97 367	90 341	83 314
SBD81154	154,000 BTUH 45 kW/Hr	81 Gal 306 L	80	498 1885	373 1412	299 1132	249 943	213 806	187 708	166 628	149 564	136 515	124 469	115 435	107 405
SBD81180	180,000 BTUH 53 kW/Hr	81 Gal 306 L	80	579 2192	434 1643	347 1314	289 1094	248 939	217 821	193 731	174 659	158 598	145 549	134 507	124 469
SBD100199*	199,000 BTUH 58 kW/Hr	100 Gal 379 L	80	643 2434	482 1825	386 1461	322 1219	276 1045	241 912	214 810	193 731	175 662	161 609	148 560	132 500
SBD100199	199,000 BTUH 58 kW/Hr	100 Gal 379 L	80	643 2434	482 1825	386 1461	322 1219	276 1045	241 912	214 810	193 731	175 662	161 609	148 560	132 500
SBD81190	190,000 BTUH 56 kW/Hr	81 Gal 306 L	80	614 2324	461 1745	368 1393	307 1162	263 996	230 871	205 776	184 697	167 632	154 583	142 538	132 500
SBD100199**	199,000 BTUH 58 kW/Hr	100 Gal 379 L	80	643 2434	482 1825	386 1461	322 1219	276 1045	241 912	214 810	193 731	175 662	161 609	148 560	132 500
SBD100250	250,000 BTUH 73 kW/Hr	100 Gal 379 L	80	808 3059	606 2294	485 1835	404 1529	346 1311	303 1147	269 1020	242 918	220 834	202 765	186 706	173 655
SBD65251	251,000 BTUH 73 kW/Hr	65 Gal 246 L	80	811 3071	608 2303	487 1843	406 1536	348 1316	304 1152	270 1024	243 921	221 838	203 768	187 709	174 658
SBD100275	275,000 BTUH 80 kW/Hr	100 Gal 379 L	80	889 3365	667 2524	533 2019	444 1682	381 1442	333 1262	296 1122	267 1009	242 918	222 841	205 776	190 721
SBD65305	305,000 BTUH 89 kW/Hr	65 Gal 246 L	80	986 3732	739 2799	592 2239	493 1866	423 1599	370 1399	329 1244	296 1120	269 1018	246 933	228 861	211 800
SBD85365	365,000 107 kW/Hr	85 Gal 322 L	80	1180 4466	885 3349	708 2680	590 2233	506 1914	442 1675	393 1489	354 1340	322 1218	295 1116	272 1031	253 957
SBD100399	399,000 BTUH 117 kW/Hr	100 Gal 379 L	80	1293 4894	970 3671	776 2936	646 2447	554 2097	485 1835	431 1631	388 1468	353 1335	323 1224	298 1129	277 1049
SBD85500	500,000 BTUH 147 kW/Hr	85 Gal 322 L	80	1616 6118	1212 4588	970 3671	808 3059	693 2622	606 2294	539 2039	485 1835	441 1668	404 1529	373 1412	346 1311

* Tall models.
** Short models.

TABLE 1D - HEATER PERFORMANCE DATA SBD (CGA) MODELS

(CGA) MODEL	INPUT RATE BTUH	APPROX. GAL CAP.	EFF. %	RECOVERY RATING CAPACITIES (GPH AND LPH)											
				30° F	40° F	50° F	60° F	70° F	80° F	90° F	100° F	110° F	120° F	130° F	140° F
				(-) 1 C	4 C	10 C	15 C	21 C	27 C	32 C	38 C	43 C	49 C	54 C	60 C
SBD71120	120,000 BTUH 35 kW/Hr	71 Gal 268 L	80	388 1469	291 1102	233 882	194 734	166 628	145 549	129 488	116 439	106 401	97 367	90 341	83 314
SBD81154	154,000 BTUH 45 kW/Hr	81 Gal 306 L	80	498 1885	373 1412	299 1132	249 943	213 806	187 708	166 628	149 564	136 515	124 469	115 435	107 405
SBD76180	180,000 BTUH 53 kW/Hr	76 Gal 288 L	80	579 2192	434 1643	347 1314	289 1094	248 939	217 821	193 731	174 659	158 598	145 549	134 507	124 469
SBD95199	199,000 BTUH 58 kW/Hr	95 Gal 360 L	80	643 2434	482 1825	386 1461	322 1219	276 1045	241 912	214 810	193 731	175 662	161 609	148 560	132 500
SBD76190	190,000 BTUH 56 kW/Hr	76 Gal 288 L	80	614 2324	461 1745	368 1393	307 1162	263 996	230 871	205 776	184 697	167 632	154 583	142 538	132 500
SBD100199	199,000 BTUH 58 kW/Hr	100 Gal 379 L	80	643 2434	482 1825	386 1461	322 1219	276 1045	241 912	214 810	193 731	175 662	161 609	148 560	132 500
SBD100250	250,000 BTUH 73 kW/Hr	100 Gal 379 L	80	808 3059	606 2294	485 1835	404 1529	346 1311	303 1147	269 1020	242 918	220 834	202 765	186 706	173 655
SBD65251	251,000 BTUH 73 kW/Hr	65 Gal 246 L	80	811 3071	608 2303	487 1843	406 1536	348 1316	304 1152	270 1024	243 921	221 838	203 768	187 709	174 658
SBD100275	275,000 BTUH 80 kW/Hr	100 Gal 379 L	80	889 3365	667 2524	533 2019	444 1682	381 1442	333 1262	296 1122	267 1009	242 918	222 841	205 776	190 721
SBD65305	305,000 BTUH 89 kW/Hr	65 Gal 246 L	80	986 3732	739 2799	592 2239	493 1866	423 1599	370 1399	329 1244	296 1120	269 1018	246 933	228 861	211 800
SBD65365	365,000 BTUH 107 kW/Hr	65 Gal 246 L	80	1164 4405	873 3304	698 2643	582 2202	499 1888	436 1652	388 1468	349 1321	317 1201	291 1101	269 1016	249 944
SBD100399	399,000 BTUH 117 kW/Hr	100 Gal 379 L	80	1293 4894	970 3671	776 2936	646 2447	554 2097	485 1835	431 1631	388 1468	353 1335	323 1224	298 1129	277 1049
SBD85500	500,000 BTUH 147 kW/Hr	85 Gal 322 L	80	1616 6118	1212 4588	970 3671	808 3059	693 2622	606 2294	539 2039	485 1835	441 1668	404 1529	373 1412	346 1311

TABLE OF CONTENTS

	Page		Page
ROUGH-IN-DIMENSIONS	2-3	INSTALLATION DIAGRAMS	15-21
TABLE OF CONTENTS	4	MANIFOLDS	22
FOREWORD	4	MECHANICAL VENTING	23
GENERAL SAFETY INFORMATION	4-5	Single Unit Installation	23
Chemical Vapor Corrosion	5	Vent Installation	23
Improper Combustion	5	Multiple Unit Installation	23
Liquid Petroleum Models	5	OPERATION	24
Extended Non-Use Periods	5	General	24
Insulation Blankets	5-6	Filling	24
High Altitude Installation	6	Purging	24
FEATURES	6	Lighting and Operating Labels	25-26
Self-Cleaning Hydro Cannon	6	Water Temperature Control	27
High Limit Switch (E.C.O.)	6	Testing Damper Control	27
Electronic Ignition Control	7	Checking Venting	27-28
Automatic Flue Damper Device	7	PREVENTIVE MAINTENANCE	28
Circulating Pump	7	Check The Pilot	28
Dishwashing Machine Requirement	7	Pilot Burner	28
INSTALLATION INSTRUCTIONS	7	Main Burner	28-29
Uncrating	7	Gas Valves	29
Locating The Heater	8	Checking The Input	29
Levelling	8	Venting System	30
Clearances	8	Remote Storage Tank Temperature Control	30
Hard Water	8	Relief Valve	30
Air Requirements	8-9	Hot Water Odor	30
Unconfined Space	9	Anode Rod Inspection	30
Confined Space	9	Recommended Procedure For Periodic Removal of Lime Deposits From Tank Type Commercial Water Heaters	30-31
Vent Reducer	9	Deliming Solvents	31
Venting	9-10	Tank Cleanout Procedures	31-32
Multiple Heater Manifold	10	Troubleshooting Ignition Module System	32
Water Line Connections	10	SERVICE	32
Water (Potable) Heating and Space Heating	10	Electrical Servicing	32
Thermometers (Not Supplied)	10	Replacement Parts	32
Relief Valve	10	Effikal Flue Damper Troubleshooting Guide	33
Technical Data Venting	11-12	Operational Checklist	34
Gas Piping	13-14	LIMITED WARRANTY	Insert
Gas Pressure Regulator	14		
Heater Wiring	14		

FOREWORD

These designs comply with ANSI Z21.10.3/CSA 4.3 M98 as an automatic circulating or automatic storage tank type water heater.

Heaters having an input of 305,000 (89 kWh), 365,000 (107 kWh), 399,000 (117 kWh) and 500,000 (147 kWh) Btuh with a recovery rating of 277.3 gph (1049 Lph) or more also comply with ANSI Z21.10.3 as an automatic instantaneous type heater.

Detailed installation diagrams are found in this manual. These diagrams will serve to provide the installer with a reference for the materials and methods of piping necessary. It is highly essential that all water, gas piping and wiring be installed as shown on the diagrams.

Particular attention should be given to the installation of thermometers at the locations indicated on the diagrams as these are necessary for checking the proper functioning of the heater.

The heater is designed to operate on natural or propane gases. HOWEVER, MAKE SURE the gas on which the heater will operate is the same as that specified on the heater model and rating plate.

These heaters may be installed on combustible floors. Refer to LOCATING THE HEATER and INSTALLATION ON COMBUSTIBLE FLOORING sections for details.

In addition to these instructions, the equipment shall be installed in accordance with those installation regulations in force in the local area where the installation is to be made. These shall be carefully followed in all cases. Authorities having jurisdiction should be consulted before installations are made.

The installation must conform to these instructions and the local code authority having jurisdiction. In the absence of local codes, the installation must comply with the latest editions of the National Fuel Gas Code, ANSI Z223.1/NFPA 54 and the National Electrical Code, NFPA 70, CAN/CSA B149.1-00, and CSA 2 C22.1. The former is available from the Canadian Standards Association, 8501 East Pleasant Valley Road, Cleveland, OH 44131, and both documents are available from the National Fire Protection Association, 1 Batterymarch Park, Quincy, MA 02269.

GENERAL SAFETY INFORMATION

PRECAUTIONS

DO NOT USE THIS APPLIANCE IF ANY PART HAS BEEN UNDER WATER. Immediately call a qualified service technician to inspect the appliance and to replace any part of the control system and any gas control which has been under water.

IF THE UNIT IS EXPOSED TO THE FOLLOWING, DO NOT OPERATE HEATER UNTIL ALL CORRECTIVE STEPS HAVE BEEN MADE BY A QUALIFIED SERVICEMAN.

1. EXTERNAL FIRE.
2. DAMAGE.
3. FIRING WITHOUT WATER.
4. SOOTING

CHEMICAL VAPOR CORROSION



WARNING

CORROSION OF THE FLUEWAYS AND VENT SYSTEM MAY OCCUR IF AIR FOR COMBUSTION CONTAINS CERTAIN CHEMICAL VAPORS. SUCH CORROSION MAY RESULT IN FAILURE AND RISK OF ASPHYXIATION.

Spray can propellants, cleaning solvents, refrigerator and air conditioning refrigerants, swimming pool chemicals, calcium and sodium chloride (water softener salt), waxes, and process chemicals and typical compounds which are potentially corrosive. Do not store products of this sort near the heater. Also, air which is brought in contact with the heater should not contain any of these chemicals. If necessary, uncontaminated air should be obtained from remote or outside sources. The limited warranty is voided when failure of water heater is due to a corrosive atmosphere. (Refer to the limited warranty for complete terms and conditions.)

IMPROPER COMBUSTION



WARNING

ATTIC AND/OR EXHAUST FANS OPERATING ON THE PREMISES WITH A WATER HEATER CAN RESULT IN CARBON MONOXIDE POISONING AND DEATH.

OPERATION OF THESE FANS CAN PRODUCE A NEGATIVE DRAFT IN THE AREA OF THE WATER HEATER PREVENTING THE PRODUCTS OF COMBUSTION FROM EXHAUSTING THROUGH THE CHIMNEY OR VENT PIPE.

The venting of the water heater should be inspected by a qualified service technician at the time of installation and periodically thereafter to ensure a down-draft condition does not exist.

DO NOT OBSTRUCT THE FLOW OF COMBUSTION AND VENTILATING AIR. ADEQUATE AIR FOR COMBUSTION AND VENTILATION MUST BE PROVIDED FOR SAFE OPERATION.

LIQUID PETROLEUM MODELS

Water heaters for propane or liquefied petroleum gas (LPG) are different from natural gas models. A natural gas heater will not function safely on LP gas and no attempt should be made to convert a heater from natural gas to LP gas.

LP gas must be used with great caution. It is highly explosive and heavier than air. It collects first in the low areas making its odor difficult to detect at nose level. If LP gas is present or even suspected, do not attempt to find the cause yourself. Go to a neighbor's house, leaving your doors open to ventilate the house, then call your gas supplier or service agent. Keep area clear until a service call has been made.

At times you may not be able to smell an LP gas leak. One cause is odor fade, which is a loss of the chemical odorant that gives LP gas its distinctive smell. Another cause can be your

physical condition, such as having a cold or diminishing sense of smell with age. For these reasons, the use of a propane gas detector is recommended.

IF YOU EXPERIENCE AN OUT-OF-GAS SITUATION, DO NOT TRY TO RELIGHT APPLIANCES YOURSELF, Ask your LP delivery person to relight pilots for you. Only trained LP professionals should conduct the required safety checks in accordance with industry standards.

EXTENDED NON-USE PERIODS



WARNING

HYDROGEN GAS CAN BE PRODUCED IN A HOT WATER SYSTEM SERVED BY THIS HEATER THAT HAS NOT BEEN USED FOR A LONG PERIOD OF TIME (GENERALLY TWO WEEKS OR MORE). HYDROGEN GAS IS EXTREMELY FLAMMABLE. To reduce the risk of injury under these conditions, it is recommended that the hot water faucet be opened for several minutes at the kitchen sink before using any electrical appliance connected to the hot water system. If hydrogen is present, there will probably be an unusual sound such as air escaping through the pipe as the water begins to flow. THERE SHOULD BE NO SMOKING OR OPEN FLAME NEAR THE FAUCET AT THE TIME IT IS OPEN.

INSULATION BLANKETS

Insulation blankets available to the general public for external use on gas water heaters are not approved for use on your State water heater. The purpose of an insulation blanket is to reduce the standby heat loss encountered with storage tank water heaters. Your State water heater meets or exceeds the ASHRAE/IES 90.1b-1999 standards with respect to insulation and standby loss requirement making an insulation blanket unnecessary.



WARNING

Should you choose to apply an insulation blanket to this heater, you should follow these instructions. Failure to follow these instructions can result in fire, asphyxiation, serious personal injury or death.

- Do not apply insulation to the top of the water heater, as this will interfere with safe operation of drafthood.
- Do not cover the gas valve or temperature & pressure relief valve.
- Do not cover the instruction manual. Keep it on the side of the water heater or nearby for future reference.
- Do not allow insulation to come within 2" (5cm) of the burners, to prevent blockage of combustion air flow to the burners.
- Do not allow insulation to come within 9" (23cm) of floor, (within 2" (5cm) of bottom cover) to prevent blockage of combustion air flow to the burners.
- Do inspect the insulation blanket frequently to make sure it does not sag, thereby obstructing combustion air flow.
- Do obtain new labels from State for placement on the blanket directly over the existing labels.

HIGH ALTITUDE INSTALLATIONS



WARNING

INSTALLATIONS ABOVE 2000 FEET (610 METERS) REQUIRE REPLACEMENT OF THE BURNER ORIFICES IN ACCORDANCE WITH SECTION 8.1.2 OF THE NATIONAL FUEL GAS CODE (ANSI Z223.1). FOR CANADIAN INSTALLATIONS CONSULT CANADIAN INSTALLATIONS CODES AND CAN/CSA B149.1-00. FAILURE TO REPLACE THE ORIFICES WILL RESULT IN

IMPROPER AND INEFFICIENT OPERATION OF THE APPLIANCE RESULTING IN THE PRODUCTION OF INCREASED LEVELS OF CARBON MONOXIDE GAS IN EXCESS OF SAFE LIMITS WHICH COULD RESULT IN SERIOUS PERSONAL INJURY OR DEATH.

You should contact your gas supplier for any specific changes which may be required in your area.

As elevation above sea level is increased, there is less oxygen per cubic foot of air. Therefore, the heater input rate should be reduced at high altitudes for satisfactory operation with the reduced oxygen supply. Failure to make this reduction would result in an overfiring of the heater causing sooting, poor combustion and/or unsatisfactory heater performance.

U.S. REQUIREMENTS

Ratings specified by manufacturers for most appliances apply for elevations up to 2000 feet (610m). For elevations above 2000 feet (610), ratings must be reduced at the rate of 4% for each 1000 feet (305m) above sea level. For example, if a heater is rated at 120,000 Btuh (35 kWh) at sea level, to rate the heater at 4000 feet (1219m), you subtract 4 (once for each thousand feet) x .04 (4% input reduction) x 120,000 (original rating) from the original rating. Therefore, to calculate the input rating at 4,000 feet (121.9m): $4 \times .04 \times 120,000 = 19,200$ Btuh (5.6 kWh), $120,000 (35 \text{ kWh}) - 19,200 (5.6 \text{ kWh}) = 100,800$ Btuh (29.4 kWh). At 6000 feet (1829m) the correct input rating should be 91,200 Btuh (26.7 kWh).

CANADIAN REQUIREMENTS

Appliances with inputs up to and including 400,000 BTU (117.2 kW) must be factory equipped with orifices for operation at specific elevations. Standard (sea level) orifices permit operation up to 2000' (610m) elevation. For operation between 2000' (610m) and 4500' (1370m) specify "HIGH ALTITUDE OPERATION" when ordering the heater(s). For operation above 4500' (2370m) consult factory before ordering.

Field conversion for operation at altitudes other than that specified on the heater rating plate is not permitted.

The input reduction is primarily achieved by reducing the size of the main burner orifices. To do this, the main burner orifices require replacement with orifices sized for the particular installation elevation. Correct orifice sizing and parts may be obtained from State Water Heaters. When ordering, be sure to state the model number and the altitude of the location where the water heater is being installed.

Upon completion of derating of the heater, adjustment to the gas pressure regulator may be required. See CHECKING THE INPUT section in this manual for inlet and manifold pressure requirements.

Also due to the input rating reduction required at high altitudes, the output rating of the appliance is reduced and should be compensated for in the sizing of the equipment for application.

FEATURES

SELF-CLEANING HYDRO CANNON

These units include a self-cleaning hydro cannon installed in the front water inlet. See figure 2. The hydro cannon must be oriented correctly for proper function. There is a marked range

on the pipe nipple portion of the hydro cannon, that must be aligned with the top of the inlet spud. A label above the jacket hole has an arrow that will point to the marked portion of the pipe nipple if the orientation is correct. If the arrow does not point within the marked range on the pipe nipple, adjust the pipe nipple to correct. A pipe union is supplied with the hydro cannon to reduce the probability of misaligning the hydro cannon accidentally while tightening the connection to the inlet water supply line. Improper orientation of the hydro-cannon can cause poor performance of the heater and can significantly reduce outlet water temperatures during heavy draws.



NOTE: The inlet tube may have 1, 3 or 7 cross-tubes.

FIGURE 2

For proper function, the hydro cannon must be oriented correctly. There is a marked range on the pipe nipple that must be aligned with the top of the inlet spud (check for label on the appliance) to assure proper orientation. Please check to confirm that the marked range is in alignment with the top of the spud. A pipe union is supplied with the hydro cannon to help eliminate the possibility of changing the orientation by accidentally over-tightening the inlet supply line. Improper orientation of the hydro cannon may cause temperature build-up issues or spells of colder than usual water temperatures.

HIGH LIMIT SWITCH (E.C.O.)

The dual bulb controller (fig. 3) contains the high limit (energy cutoff) sensor. The high limit switch interrupts main burner gas flow should the water temperature reach 205°F (96°C).

In the event of high limit switch operation, the appliance cannot be restarted unless the water temperature is reduced by at least 20°F (11°C) and the high limit reset button on front of limit control (fig. 3) is depressed.

Continued manual resetting of high limit control, preceded by higher than usual water temperature is evidence of high limit switch operation. The following is a possible reason for high limit switch operation.

- A malfunction in the thermostatic controls would allow the gas valve to remain open causing water temperature to exceed the thermostat setting. The water temperature would continue to rise until high limit switch operation.

Contact your dealer or servicer if continued high limit switch operation occurs.

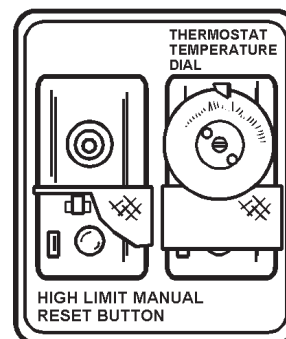

DUAL-BULB THERMOSTAT (COVER REMOVED)

FIGURE 3

Continued pilot outage preceded by higher than usual water temperature is evidence of high limit switch operation. Contact your dealer or servicer to determine the reason for operation.

ELECTRONIC IGNITION CONTROL

Each heater is equipped with a Honeywell ignition module. The solid state ignition control, fig. 4, ignites the pilot burner gas by creating a spark at the pilot assembly. Pilot gas is ignited and burns during each running cycle. The main burner and pilot gases are cut off during the OFF cycle. Pilot gas ignition is proven by the pilot sensor. Main burner ignition will not occur if the pilot sensor does not first sense pilot ignition.

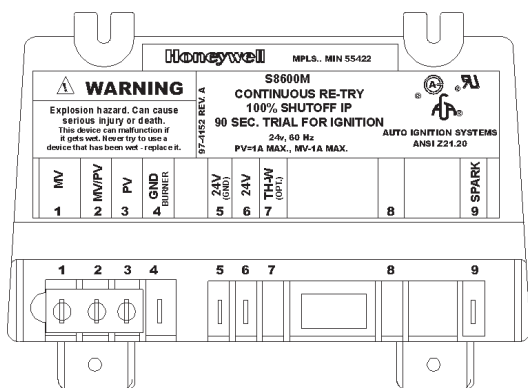

HONEYWELL IGNITION MODULE
S8600M Continuous Re-Try
FIGURE 4

AUTOMATIC FLUE DAMPER DEVICE

All units are equipped with an automatic flue damper that reduces heat loss during the OFF cycles. The automatic flue damper drive assembly is a field replaceable part and may be obtained by contacting State Water Heaters.

Each automatic flue damper drive assembly is equipped with a "Service Switch", as shown in figure 5.

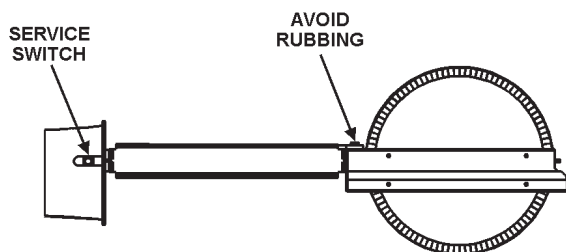

NOTE: DAMPER DISC SHOWN IN OPEN POSITION

FIGURE 5

The "Service Switch" has 2 positions: AUTOMATIC OPERATION and HOLD OPEN DAMPER. For normal operation the switch should be in the AUTOMATIC OPERATION position.

If there is a problem with the damper the "Service Switch" can be placed in the HOLD OPEN DAMPER position. When the switch is placed in the HOLD OPEN DAMPER position the damper disc will rotate to the open position and the heater may be used until vent assembly is repaired or replaced. DO NOT turn the damper disc manually; damage will occur to the drive assembly if operated manually. Refer to TESTING DAMPER OPERATION section of this manual for additional information.

CIRCULATING PUMP

A circulating pump is used when a system requires a circulating loop or there is a storage tank used in conjunction with the heater. Refer to the piping diagrams in this manual for electrical hookup information and install in accordance with the latest version of the National Electric Code ANSI/NFPA No. 70. For Canada refer to Canadian Code CSA C22.1.

Only all bronze circulators should be used with commercial water heaters.

Although circulators are oiled and operated by the manufacturer some circulators must be oiled again before operating. Please refer to manufacturer's instructions.

DISHWASHING MACHINE REQUIREMENT

These appliances meet the National Sanitation Foundation Standard for sanitary installations when used with the following leg kits, Part No's. 6570-0 and 6570-7.

All dishwashing machines meeting the National Sanitation Foundation requirements are designed to operate with water flow pressures between 15 and 25 psi (103 Kpa and 173 Kpa). Flow pressures above 25 psi (173 Kpa), or below 15 psi (103 Kpa), will result in improperly sanitized dishes. Where pressures are high, a water pressure reducing or flow regulating control valve should be used in 180°F (82°C) line to the dishwashing machine, and should be adjusted to deliver water between these limits.

The National Sanitation Foundation also recommends circulation of 180°F (82°C) water. Where this is done, the circulation should be very gentle so that it does not cause any unnecessary turbulence inside the water heater. The circulation should be just enough to provide 180°F (82°C) water at the point of take-off to the dishwashing machine. Adjust flow by means of the plug cock in the circulating line.

INSTALLATION INSTRUCTIONS

REQUIRED ABILITY

INSTALLATION OR SERVICE OF THIS WATER HEATER REQUIRES ABILITY EQUIVALENT TO THAT OF A LICENSED TRADESMAN IN THE FIELD INVOLVED. PLUMBING, AIR SUPPLY, VENTING, GAS SUPPLY AND ELECTRICAL WORK ARE REQUIRED.



FAILURE TO FOLLOW THESE INSTRUCTIONS CAN RESULT IN SERIOUS PERSONAL INJURY OR DEATH.

UNCRATING

The heater is shipped with the flue damper already installed. The wiring conduit runs from the thermostat to the damper drive cover. Before turning unit on, check to make sure the wiring conduit is securely plugged into damper drive.

LOCATING THE HEATER

When installing the heater, consideration must be given to proper location. Location selected should be as close to the stack or chimney as practicable, with adequate air supply and as centralized with the piping system as possible.

! WARNING

THERE IS A RISK IN USING FUEL BURNING APPLIANCES SUCH AS GAS WATER HEATERS IN ROOMS, GARAGES OR OTHER AREAS WHERE GASOLINE, OTHER FLAMMABLE LIQUIDS OR ENGINE DRIVEN EQUIPMENT OR VEHICLES ARE STORED, OPERATED OR REPAIRED. FLAMMABLE VAPORS ARE HEAVY AND TRAVEL ALONG THE FLOOR AND MAY BE IGNITED BY THE HEATER'S PILOT OR MAIN BURNER FLAMES CAUSING FIRE OR EXPLOSION. SOME LOCAL CODES PERMIT OPERATION OF GAS APPLIANCES IN SUCH AREAS IF THEY ARE INSTALLED 18" (.50m) OR MORE ABOVE THE FLOOR. THIS MAY REDUCE THE RISK IF LOCATION IN SUCH AN AREA CANNOT BE AVOIDED.

DO NOT INSTALL THIS WATER HEATER DIRECTLY ON A CARPETED FLOOR. A FIRE HAZARD MAY RESULT. Instead the water heater must be placed on a metal or wood panel extending beyond the full width and depth by at least 3 inches (7.6cm) in any direction. If the heater is installed in a carpeted alcove, the entire floor shall be covered by the panel. Also, see the DRAIN REQUIREMENTS.

THE HEATER SHALL BE LOCATED OR PROTECTED SO IT IS NOT SUBJECT TO PHYSICAL DAMAGE BY A MOVING VEHICLE.

! WARNING

FLAMMABLE ITEMS, PRESSURIZED CONTAINERS OR ANY OTHER POTENTIAL FIRE HAZARDOUS ARTICLES MUST NEVER BE PLACED ON OR ADJACENT TO THE HEATER. OPEN CONTAINERS OR FLAMMABLE MATERIAL SHOULD NOT BE STORED OR USED IN THE SAME ROOM WITH THE HEATER.

THE HEATER MUST NOT BE LOCATED IN AN AREA WHERE IT WILL BE SUBJECT TO FREEZING.

LOCATE IT NEAR A FLOOR DRAIN. THE HEATER SHOULD BE LOCATED IN AN AREA WHERE LEAKAGE FROM THE HEATER OR CONNECTIONS WILL NOT RESULT IN DAMAGE TO THE ADJACENT AREA OR TO LOWER FLOORS OF THE STRUCTURE.

WHEN SUCH LOCATIONS CANNOT BE AVOIDED, A SUITABLE DRAIN PAN SHOULD BE INSTALLED UNDER THE HEATER. Such pans should be fabricated with sides at least 2" (5cm) deep, with length and width at least 2" (5cm) greater than the diameter of the heater and must be piped to an adequate drain. The pan must not restrict combustion air flow.

For appliance installation locations with elevations above 2000 feet (610m), refer to HIGH ALTITUDE INSTALLATIONS section of this manual for input reduction procedure.

LEVELING

If the unit is not level, insert the bolts which were used in crating into the legs to correct this condition.

CLEARANCES

These heaters are approved for installation on combustible flooring in an alcove when the minimum clearance from any combustion construction are followed as indicated in figure 6 and Table 2.

The following units are approved for installation with side, rear and ceiling clearances as indicated below:

TABLE 2

	A (RIGHT SIDE)	B (LEFT SIDE)	C (BACK)	D (CEILING)
120	1" (2.54 cm)	1" (2.54 cm)	1" (2.54 cm)	12" (30.48 cm)
154	1" (2.54 cm)	1" (2.54 cm)	1" (2.54 cm)	12" (30.48 cm)
*180	1" (2.54 cm)	1" (2.54 cm)	1" (2.54 cm)	12" (30.48 cm)
*197	1" (2.54 cm)	1" (2.54 cm)	1" (2.54 cm)	12" (30.48 cm)
198	1" (2.54 cm)	1" (2.54 cm)	1" (2.54 cm)	12" (30.48 cm)
*199	1" (2.54 cm)	1" (2.54 cm)	1" (2.54 cm)	12" (30.48 cm)
200	1" (2.54 cm)	1" (2.54 cm)	1" (2.54 cm)	12" (30.48 cm)
250	2" (5.08 cm)	2" (5.08 cm)	2" (5.08 cm)	12" (30.48 cm)
251	2" (5.08 cm)	2" (5.08 cm)	2" (5.08 cm)	12" (30.48 cm)
275	2" (5.08 cm)	2" (5.08 cm)	2" (5.08 cm)	12" (30.48 cm)
305	2" (5.08 cm)	2" (5.08 cm)	2" (5.08 cm)	12" (30.48 cm)
**365	3" (7.75 cm)	3" (7.75 cm)	3" (7.75 cm)	12" (30.48 cm)
400	3" (7.75 cm)	3" (7.75 cm)	3" (7.75 cm)	12" (30.48 cm)
500	5" (12.7 cm)	5" (12.7 cm)	5" (12.7 cm)	20" (50.80 cm)

* The Canadian version has a 2" (5.08cm) to sides and rear.

** The Canadian version has a 4" (10.16cm) to sides and rear.

In all installations the minimum combustible clearances from any draft hood surface or vent piping shall be 6" (16cm). Vent piping passing through a combustible wall or ceiling must be a continuous run (no joints) and retain the 6" (16cm) clearance unless an approved reducing thimble is used.

A service clearance of 24" (61cm) should be maintained from serviceable parts, such as relief valves, flue baffles, flue damper devices, thermostats, cleanout openings or drain valves.

INSTALLATION ON COMBUSTIBLE FLOORING

The SBD85500NE is approved for installations on combustible flooring when installed with leg kit number 6570-194230-000.

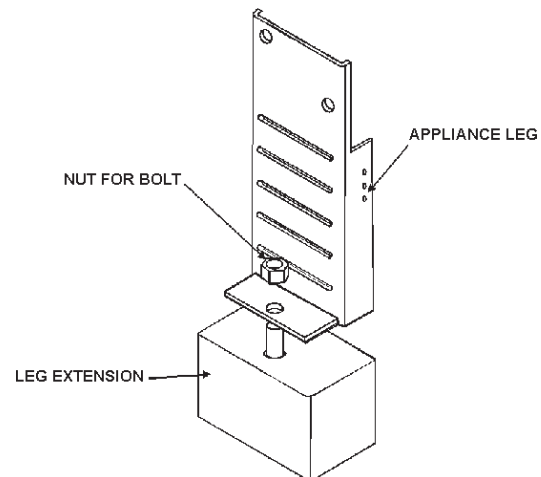

1. Unit needs to be lifted in a way not to damage unit or laid on it's side to access the bottom of the legs.
2. Slide leg extension under leg and the bolt up through the bottom hole located in the bottom of the leg.
3. Once in place, screw nut down and secure.
4. Front of leg should line up with front of leg extension as shown to make sure weight of unit is distributed through the leg extension.

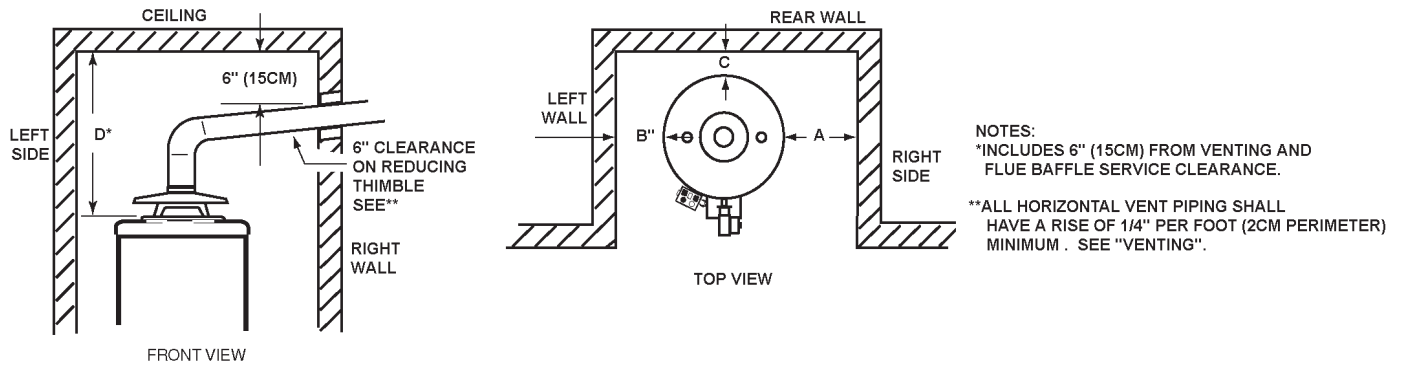

ILLUSTRATION OF MINIMUM COMBUSTIBLE CLEARANCES IN AN ALCOVE
FIGURE 6

HARD WATER

Where hard water conditions exist, water softening or the threshold type of water treatment is recommended. This will protect the dishwashers, coffee urns, water heaters, water piping and other equipment.

See MAINTENANCE section for details of tank cleanout procedure.

AIR REQUIREMENTS

REFER TO THE LATEST EDITION OF THE "NATIONAL FUEL GAS CODE" ANSI Z223.1/NFPA 54. FOR CANADA CONSULT CAN/CSA B149.1-00.

! WARNING

KEEP APPLIANCE AREA CLEAR AND FREE OF COMBUSTIBLE MATERIALS, GASOLINE AND OTHER FLAMMABLES, VAPORS AND LIQUIDS.

DO NOT OBSTRUCT THE FLOW OF COMBUSTION OR VENTILATING AIR.

! WARNING

FOR SAFE OPERATION PROVIDE ADEQUATE AIR FOR COMBUSTION AND VENTILATION. AN INSUFFICIENT SUPPLY OF AIR WILL CAUSE RECIRCULATION OF COMBUSTION PRODUCTS RESULTING IN AIR CONTAMINATION THAT MAY BE HAZARDOUS TO LIFE. SUCH A CONDITION OFTEN WILL RESULT IN A YELLOW, LUMINOUS BURNER FLAME, CAUSING CARBONING OR SOOTING OF THE COMBUSTION CHAMBER, BURNERS AND FLUE TUBES AND CREATES A RISK OF ASPHYXIATION.

Where an exhaust fan is supplied in the same room with a heater, sufficient openings for air must be provided in the walls. **UNDERSIZED OPENINGS WILL CAUSE AIR TO BE DRAWN INTO THE ROOM THROUGH THE CHIMNEY, CAUSING POOR COMBUSTION. SOOTING MAY RESULT IN SERIOUS DAMAGE TO THE HEATER AND RISK OF FIRE OR EXPLOSION.**

UNCONFINED SPACE

In buildings of conventional frame, brick, or stone construction, unconfined spaces may provide adequate air for combustion, ventilation and draft hood dilution.

If the unconfined space is within a building of tight construction (buildings using the following construction: weather stripping, heavy insulation, caulking, vapor barrier, etc.), air for combustion,

ventilation and draft hood dilution must be obtained from outdoors. The installation instructions for confined spaces in tightly constructed buildings must be followed to ensure adequate air supply.

CONFINED SPACE

When drawing combustion and dilution air from inside a conventionally constructed building to a confined space, such a space shall be provided with two permanent openings, ONE IN OR WITHIN 12 INCHES (30.5cm) OF THE ENCLOSURE TOP AND ONE IN OR WITHIN 12 INCHES (30.5cm) OF THE ENCLOSURE BOTTOM. Each opening shall have a free area of at least one square inch per 1000 Btuh (2,225mm²/kW) of the total input of all appliances in the enclosure, but not less than 100 square inches (645 square cm).

If the confined space is within a building of tight construction, air for combustion, ventilation, and draft hood dilution must be obtained from outdoors. When directly communicating with the outdoors or communicating with the outdoors through vertical ducts, two permanent openings, located in the above manner, shall be provided. Each opening shall have a free area of not less than one square inch per 4000 Btuh (8,900mm²/kW) of the total input of all appliances in the enclosure. If horizontal ducts are used, each opening shall have a free area of not less than one square inch per 2000 Btuh (4,450mm²/kW) of the total input of all appliances in the enclosure. For Canadian installations consult CAN/CSA B149.1-00.

VENT REDUCER

The SBD 250, 251, and 275 models are shipped with an 8" to 6" diameter flue outlet adapter. The SBD 120 models come with a 6" to 5" diameter flue outlet adapter. Each adapter fits on top of the installed flue damper. Use only vent reducers supplied with the unit. The venting must comply with the NATIONAL FUEL GAS CODE, ANSI Z223.1/NFPA 54 and for Canadian installations consult the Canadian Installation Code CAN/CSA B149.1-00.

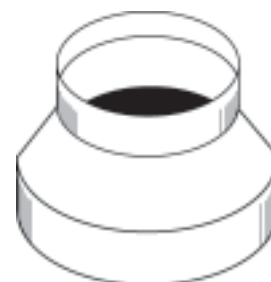

FIGURE 7

VENTING

WARNING

THE INSTRUCTIONS IN THIS SECTION ON VENTING MUST BE FOLLOWED TO AVOID CHOKED COMBUSTION OR RECIRCULATION OF FLUE GASES. SUCH CONDITIONS CAUSE SOOTING OR RISKS OF FIRE AND ASPHYXIATION.

Heater must be protected from freezing downdrafts.

Remove all soot or other obstructions from the chimney that will retard a free draft.

Type B venting is recommended with these heaters. See table 3 TECHNICAL DATA VENTING.

This water heater must be vented in compliance with all local codes, the current revision of the National Fuel Gas Code (ANSI-Z223.1) and with the Category I Venting Tables.

In Canada, venting shall conform to the requirements of the current CAN/CGA B149.1-00 installation code.

If any parts of the vent system are exposed to ambient temperatures below 35 degrees F (2 degrees C) they must be insulated to prevent condensation.

- Do not connect the heater to a common vent or chimney with solid fuel burning equipment. This practice is prohibited by many local building codes as is the practice of venting gas fired equipment to the duct work of ventilation systems.
- Where a separate vent connection is not available and the vent pipe from the heater must be connected to a common vent with an oil burning furnace, the vent pipe should enter the smaller common vent or chimney at a point above the large vent pipe.

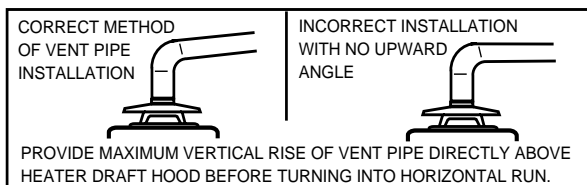

FIGURE 8

MULTIPLE HEATER MANIFOLD

Figure 9 and table 3 should be used for horizontally manifolded two or more heaters. Also see MULTIPLE-UNIT INSTALLATIONS of MECHANICAL VENTING section for induced draft applications.

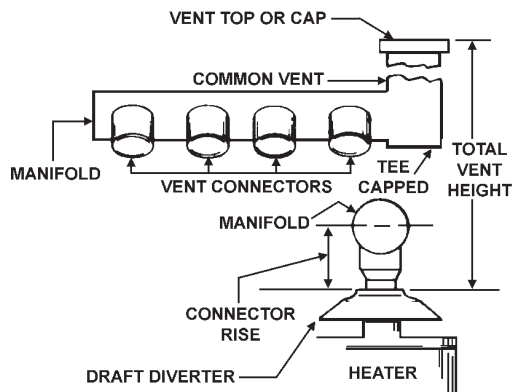

FIGURE 9

WATER LINE CONNECTIONS

This manual provides detailed installation diagrams (see pages 16-22 of this manual) for typical methods of application for the water heaters.

The water heater may be installed by itself, or with a separate storage tank, on both single and two-temperature systems. When used with a separate storage tank, the circulation may be either by gravity or by means of a circulating pump. When a circulating pump is used it is important to note that the flow rate should be slow so that there will be a minimum of turbulence inside the heater.

If a water heater is installed in a closed water system, contact the water supplier or local plumbing inspector on how to control this situation.

WATER (POTABLE) HEATING AND SPACE HEATING

1. All piping components connected to this unit for space heating applications shall be suitable for use with potable water.
2. Toxic chemicals, such as those used for boiler treatment, shall NEVER be introduced into this system.
3. This unit may NEVER be connected to any existing heating system or component(s) previously used with a non-potable water heating appliance.
4. When the system requires water for space heating at temperatures higher than required for domestic water purposes, a tempering valve must be installed. Please refer to installation diagrams on pages 16 through 22 in this manual for suggested piping arrangements.

CAUTION

A closed system will exist if a check valve (without bypass), pressure reducing valve (without bypass), or a water meter (without bypass) is installed in the cold water line between the water heater and street main (or well).

Excessive pressure may develop in such closed systems, causing premature tank failure or intermittent relief valve operation. This is not a warranty failure. An expansion tank or a similar device may be required in the inlet supply line between the appliance and the meter or valve to compensate for the thermal expansion of the water.

SYSTEM CONNECTIONS

The system installation must conform to these instructions and to the local code authority having jurisdiction. Good practice requires that all heavy piping be supported.

THERMOMETERS (Not Supplied)

Thermometers should be obtained and field installed as shown in the installation diagrams.

Thermometers are installed in the system as a means of detecting the temperature of the outlet water supply.

RELIEF VALVE

This water heater is equipped with a combination temperature-pressure relief valve that complies with the standard for relief valves and automatic gas shutoff devices for hot water supply system, ANSI Z21.22, for Canada see CAN/CSA 149.1-00. **FOR SAFE OPERATION OF THE WATER HEATER, THE RELIEF VALVE(S) MUST NOT BE REMOVED OR PLUGGED.**

TECHNICAL DATA VENTING, TABLE 3

TYPE B GAS VENT Multiple Gas Fired Tank-Type Heaters

When venting multiple tank type heaters using Type B vent pipe, follow the installation diagram (figure 8) and tables below which give sizing and data based upon NFPA 54/ANSI Z223. 1992.

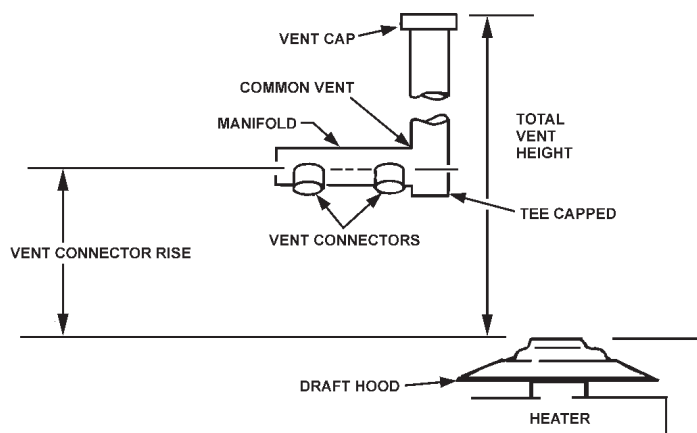

MODEL 120

Input: 120,00Btuh

Total Vent Height (Feet)

Draft Hood: 5"

		Total Vent Height (Feet)								
		Vent Connector Diameter (inches)								
		Manifold and Common Vent Diameter (In inches)								
	Input Btuh	Rise	6	8	10	15	20	30	50	100
	120,000	1 Ft.	7	7	7	6	6	6	6	6
	120,000	2 Ft.	6	6	6	6	6	6	6	5
	123,000	3 Ft.	6	6	6	6	6	5	5	5
Number of Heaters	Combined Input in Thousands of Btuh									
2	240	10	8	8	7	7	7	6	7	7
3	360	10	10	10	10	8	8	7	7	7
4	480	12	12	12	10	10	10	8	8	8

MODEL 154

Input: 154,000 Btuh

Total Vent Height (Feet)

Draft Hood: 6"

		Total Vent Height (Feet)								
		Vent Connector Diameter (in inches)								
		Manifold and Common Vent Diameter (in inches)								
	Input Btuh	Rise	6	8	10	15	20	30	50	100
	154,000	1 Ft.	8	8	7	7	7	7	7	7
	154,000	2 Ft.	7	7	7	7	7	6	6	6
	154,000	3 Ft.	7	7	7	6	6	6	6	6
Numbers of Heaters	Combined Input in Thousands of Btuh									
2	308	10	10	10	8	8	7	7	7	7
3	462	12	12	12	10	10	10	8	8	8
4	618	14	14	12	12	12	10	10	10	10

MODELS 180, 197, 198, 199, 200

Input: 180,000, 190,000, 199,000 Btuh

Total Vent Height (Feet)

Draft Hood: 6"

		Total Vent Height (Feet)								
		Vent Connector Diameter (in inches)								
		Manifold & Common Vent Diameter								
	Input Btuh	Rise	6	8	10	15	20	30	50	100
	180,000	1 Ft.	8	8	8	8	8	7	7	7
	190,000		-	8	8	8	8	8	7	7
	199,000		-	-	8	8	8	8	8	7
	180,000	2 Ft.	8	8	7	7	7	7	7	7
	190,000		8	8	8	7	7	7	7	7
	199,000		8	8	8	8	7	7	7	7
	179,000	3 Ft.	7	7	7	7	7	7	6	6
	190,000		8	7	7	7	7	7	6	6
	197,000		8	7	7	7	7	7	7	6
	199,000		8	8	7	7	7	7	7	6
Number of Heaters	Combined Input in Thousands of Btuh									
2	358	10	10	10	10	8	8	7	7	7
2	380	12	10	10	10	10	8	7	7	7
2	394/398	12	10	10	10	10	8	8	7	7
3	537	14	12	12	12	10	10	10	8	8
3	570	14	12	12	12	10	10	10	10	10
3	591/597	14	14	12	12	12	10	10	10	10
4	716	14	14	14	12	12	12	10	10	10
4	760	16	14	14	14	12	12	10	10	10
4	788/796	16	14	14	14	12	12	12	10	10

TECHNICAL DATA VENTING, TABLE 3 (Continued)

MODELS 250, 251			Total Vent Height (Feet)								
Input: 250,000, 251,000			6	8	10	15	20	30	50	100	
Draft Hood: 6"											
	Input Btuh	Rise	Vent Connector Diameter (in inches)								
		250/251,000	1 Ft.	-	-	-	-	-	-	8	8
		250/251,000		-	-	-	8	8	8	8	8
	250/251,000	3 Ft.	-	8	8	8	-	8	7	7	
Number of Heaters	Combined Input in Thousands of Btuh	Manifold and Common Vent Diameter (In inches)									
		14	12	12	10	10	10	8	8		
2	480										
	500/502		14	12	12	10	10	10	10	8	
3	720		14	14	14	12	12	12	10	10	
	750/753		16	14	14	14	12	12	10	10	
4	960/1000/1004		18	16	16	14	14	14	12	12	
MODEL 275			Total Vent Height (Feet)								
Input: 275,000 Btuh			6	8	10	15	20	30	50	100	
Draft Hood: 6"											
	Input Btuh	Rise	Vent Connector Diameter (in inches)								
		275,000	2 Ft.	-	-	-	-	-	8	8	8
		275,000	3 Ft.	-	-	-	8	8	8	8	8
Numbers of Heaters	Combined Input in Thousands of Btuh	Manifold and Common Vent Diameter (in inches)									
		-	-	-	12	10	10	10	10	10	
2	550										
3	825		-	-	-	14	14	12	12	12	
4	1100		-	-	-	16	14	14	12	12	
MODEL 305			Total Vent Height (Feet)								
Input: 305,000 Btuh			6	8	10	15	20	30	50	100	
Draft Hood: 8"											
	Input Btuh	Rise	Vent Connector Diameter (in inches)								
		315,000	1 Ft.	-	-	10	10	10	10	10	10
		305,000	2 Ft.	10	10	10	10	10	10	8	8
	365,000	3 Ft.	10	10	10	10	10	8	8	8	
Number of Heaters	Combined Input in Thousands of Btuh	Manifold & Common Vent Diameter									
		14	14	12	12	12	10	10	10	10	
2	610										
3	915		16	16	16	14	14	12	12	12	
4	1220		18	18	16	16	16	14	14	12	
MODEL 365, 400			Total Vent Height (Feet)								
Input: 365,000, 399,000			6	8	10	15	20	30	50	100	
Draft Hood: 8"											
	Input Btuh	Rise	Vent Connector Diameter (in inches)								
		365,000	1 Ft.	-	-	-	-	-	10	10	10
		400,000		-	-	-	-	-	-	10	10
		365,000	2 FT.	12	12	10	10	10	10	10	10
		400,000		12	12	12	12	10	10	10	10
		365,000	3 FT.	10	10	10	10	10	10	10	10
	400,000		12	10	10	10	10	10	10	10	
Number of Heaters	Combined Input in Thousands of Btuh	Manifold & Common Vent Diameter (inches)									
		14	14	14	12	12	12	10	10	10	
2	730										
	800		16	14	14	14	12	12	10	10	
3	1095		18	18	16	16	14	14	12	12	
	1200		18	18	18	16	16	14	14	12	
4	1460		20	20	18	18	16	16	14	12	
	1600		22	20	20	18	18	16	14	14	
MODEL 500			Total Vent Height (Feet)								
Input: 500,000 Btuh			6	8	10	15	20	30	50	100	
Draft Hood: 8"											
	Input Btuh	Rise	Vent Connector Diameter (in inches)								
		500,000	2 Ft.	-	12	12	12	12	12	12	12
		500,000	4 Ft.	12	12	12	12	12	12	10	10
	500,000	6 Ft.	N/A	12	12	12	12	12	10	10	
Number of Heaters	Combined Input in Thousands of Btuh	Manifold & Common Vent Diameter (inches)									
		18	16	16	14	14	14	12	12	12	
2	1000										
3	1500		22	20	20	18	16	16	14	12	
4	2000		24	22	22	20	20	18	16	14	

ASME ratings cover pressure relief capacities. A.G.A. ratings cover release rate with temperature actuation.

In addition to the appliance relief valve, each remote storage tank which may be used in conjunction with this appliance shall also be installed with a properly sized, rated and approved combination temperature (ANSI) and pressure (ASME) relief valve(s).

! WARNING

THE PURPOSE OF RELIEF VALVE IS TO AVOID EXCESSIVE PRESSURE OR TEMPERATURE INTO THE STEAM RANGE, WHICH MAY CAUSE SCALDING AT FIXTURES, TANK EXPLOSION, SYSTEM OR HEATER DAMAGE. NO VALVE IS TO BE PLACED BETWEEN THE RELIEF VALVE AND TANK.

Your local code authority may have other specific relief valve requirements.

A DRAIN LINE MUST BE CONNECTED TO THE RELIEF VALVE TO DIRECT DISCHARGE TO A SAFE LOCATION TO AVOID SCALDING OR WATER DAMAGE. THIS LINE MUST NOT BE REDUCED FROM THE SIZE OF THE VALVE OUTLET AND MUST NOT CONTAIN VALVES OR RESTRICTIONS NOR SHOULD IT BE LOCATED IN FREEZING AREAS. DO NOT THREAD OR CAP THE END OF THIS LINE. RESTRICTED OR BLOCKED DISCHARGE WILL DEFEAT THE PURPOSE OF THE VALVE AND IS UNSAFE. DISCHARGE LINE SHALL BE INSTALLED TO ALLOW COMPLETE DRAINAGE OF BOTH THE VALVE AND LINE.

See SERVICE INFORMATION section for procedure and precautions.

GAS PIPING

Contact your local gas service company to ensure that adequate gas service is available and to review applicable installation codes for your area.

Size the main gas line in accordance with Table 4. The figures shown are for straight lengths of pipe at 0.5 in. W.C. pressure drop, which is considered normal for low pressure systems. **Note: Fittings such as elbows, tees and line regulators will add to the pipe pressure drop. Also refer to the latest version of the National Fuel Gas Code. For Canadian installations consult Canadian Installation Code CAN/CSA B149.1-00.**

**TABLE 4 - GAS SUPPLY LINE SIZES (IN INCHES)*
MAXIMUM CAPACITY OF PIPE IN
CUBIC FEET PER HOUR**

LENGTH IN FEET	NOMINAL IRON PIPE SIZES (INCHES)									
	1/2"	3/4"	1"	1 1/4"	1 1/2"	2"	2 1/2"	3"	4"	
10	175	360	680	1400	2100	3960	6300	11000	23000	
20	120	250	465	950	1460	2750	4360	7700	15800	
30	97	200	375	770	1180	2200	3520	6250	12800	
40	82	170	320	660	990	1900	3000	5300	10900	
50	73	151	285	580	900	1680	2650	4750	9700	
60	66	138	260	530	810	1520	2400	4300	8800	
70	61	125	240	490	750	1400	2250	3900	8100	
80	57	118	220	460	690	1300	2050	3700	7500	
90	53	110	205	430	650	1220	1950	3450	7200	
100	50	103	195	400	620	1150	1850	3250	6700	
125	44	93	175	360	550	1020	1650	2950	6000	
150	40	84	160	325	500	950	1500	2650	5500	
175	37	77	145	300	460	850	1370	2450	5000	
200	35	72	135	280	430	800	1280	2280	4600	

! WARNING

THE HEATER IS NOT INTENDED FOR OPERATION AT HIGHER THAN 14.0" W.C.(3.48 Kpa) (1/2 POUND PER SQUARE INCH GAGE- 3.45 Kpa) SUPPLY GAS PRESSURE. EXPOSURE TO HIGHER SUPPLY PRESSURE MAY CAUSE DAMAGE TO THE GAS VALVE WHICH COULD RESULT IN FIRE OR EXPLOSION. IF OVERPRESSURE HAS OCCURRED SUCH AS THROUGH IMPROPER TESTING OF GAS LINES OR EMERGENCY MALFUNCTION OF THE SUPPLY SYSTEM, THE GAS VALVE MUST BE CHECKED FOR SAFE OPERATION. MAKE SURE THAT THE OUTSIDE VENTS ON THE SUPPLY REGULATORS AND THE SAFETY VENT VALVES ARE PROTECTED AGAINST BLOCKAGE. THESE ARE PARTS OF THE GAS SUPPLY SYSTEM, NOT THE HEATER. VENT BLOCKAGE MAY OCCUR DURING ICE STORMS.

IT IS IMPORTANT TO GUARD AGAINST GAS VALVE FOULING FROM CONTAMINANTS IN THE GAS WAYS. SUCH FOULING MAY CAUSE IMPROPER OPERATION, FIRE OR EXPLOSION.

IF COPPER SUPPLY LINES ARE USED THEY MUST BE INTERNALLY TINNED AND CERTIFIED FOR GAS SERVICE. BEFORE ATTACHING THE GAS LINE, BE SURE THAT ALL GAS PIPE IS CLEAN ON THE INSIDE.

TO TRAP ANY DIRT OR FOREIGN MATERIAL IN THE GAS SUPPLY LINE, A DIRT LEG (SOMETIMES CALLED SEDIMENT TRAP OR DRIP LEG) MUST BE INCORPORATED IN THE PIPING (SEE FIG. 10). THE DIRT LEG MUST BE READILY ACCESSIBLE AND NOT SUBJECT TO FREEZING CONDITIONS. INSTALL IN ACCORDANCE WITH RECOMMENDATIONS OF SERVING GAS SUPPLIERS. REFER TO THE LATEST VERSION OF THE NATIONAL FUEL GAS CODE. For Canadian installations consult Canadian Installation Code CAN/CSA B149.1-00.

To prevent damage, care must be taken not to apply too much torque when attaching gas supply pipe to gas valve inlet.

Apply joint compounds (pipe dope) sparingly and only to the male threads of pipe joints. Do not apply compounds to the first two threads. Use compounds resistant to the action of liquefied petroleum gases.

GAS PIPING AND DIRT LEG INSTALLATION

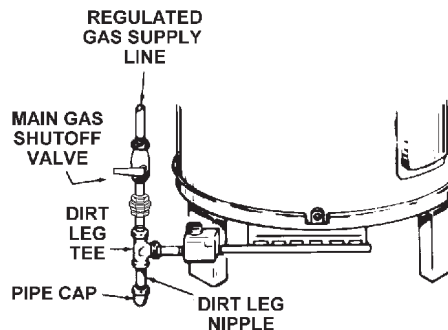

FIGURE 10

BEFORE PLACING THE HEATER IN OPERATION, CHECK FOR GAS LEAKAGE. Use soap and water solution or other material acceptable for the purpose in locating the leaks. **DO NOT USE MATCHES, CANDLES, FLAME OR OTHER SOURCES OF IGNITION FOR THIS PURPOSE.**

DISCONNECT THE HEATER AND ITS MANUAL GAS SHUTOFF VALVE FROM THE GAS SUPPLY PIPING SYSTEM DURING ANY SUPPLY PRESSURE TESTING EXCEEDING 1/2 PSIG (3.45 Kpa). GAS SUPPLY LINE MUST BE CAPPED WHEN DISCONNECTED FROM THE HEATER FOR TEST PRESSURES OF 1/2 PSIG (3.45 Kpa) OR LESS. THE APPLIANCE NEED NOT BE DISCONNECTED, BUT MUST BE ISOLATED FROM THE SUPPLY PRESSURE TEST BY CLOSING THE MANUAL GAS SHUTOFF VALVE.

not be less than 4.5" W.C. (1.12 Kpa) for natural gas and 11.0" W.C. (2.74 Kpa) for propane gas.

Do not subject the combination gas valve to inlet gas pressures of more than 14.0" W.C. (3.48 Kpa) - natural gas, 14.0" W.C. (3.48 Kpa) - propane gas. A service regulator is necessary if higher gas pressures are encountered.

Gas pressure specified in Table 5, refer to flow pressure taken at pressure tap of automatic gas valve while heater is operating.

GAS METER SIZE — NATURAL GASES ONLY

Be sure the gas meter has sufficient capacity to supply the full rated gas input of the water heater as well as the requirements of all other gas fired equipment supplied by the meter. If gas meter is too small, ask the gas company to install a larger meter having adequate capacity.

GROUNDING INSTRUCTIONS

This water heater must be connected to a grounded metal, permanent wiring system; or an equipment grounding conductor must be run with the circuit conductors and connected to the equipment grounding terminal or lead on the water heater.

GAS PRESSURE REGULATOR

The gas pressure regulator is built into the gas valve and is equipped to operate on the gas specified on model and rating plate. The regulator is factory adjusted to deliver gas to burner at correct water column pressure allowing for a nominal pressure drop through the controls.

HEATER WIRING

All electrical work must be installed in accordance with the latest version of the National Electrical Code ANSI/NFPA No. 70, and /or the CSA C22.1 Electrical Code, for Canada use Canadian Electrical Code CSA C22.1 and must conform to all local code authority having jurisdiction. **AN ELECTRICAL GROUND IS REQUIRED TO REDUCE RISK OF ELECTRICAL SHOCK OR POSSIBLE ELECTROCUTION.**

The minimum gas supply pressure for input adjustment must

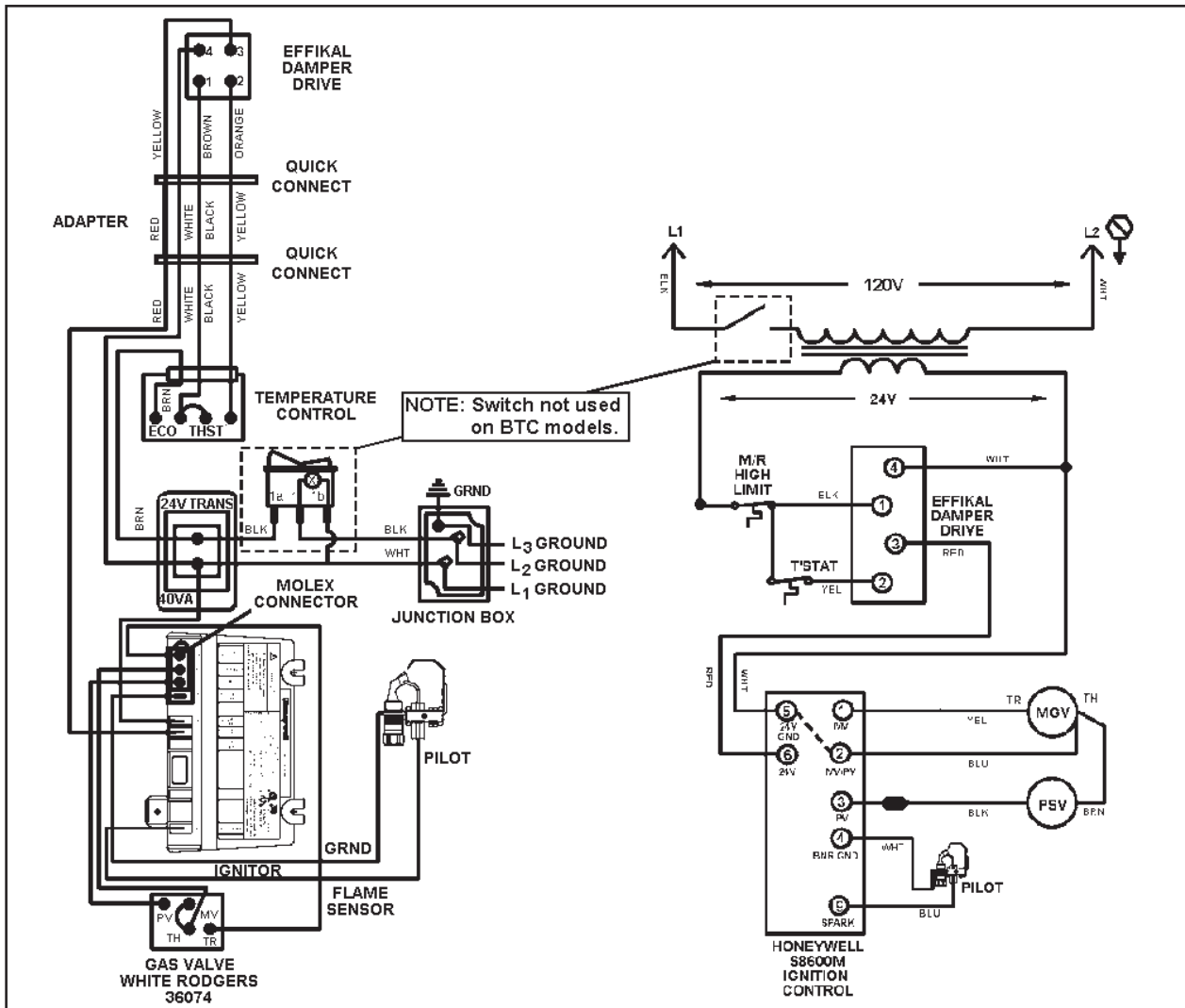

FIGURE 10 - SINGLE UNIT WIRING DIAGRAM SBD MODELS 120 THROUGH 500A

For Canadian installations the electrical connections and grounding shall be done in accordance with current Canadian Electrical Code CSA C22.1, Part 1 and/or local codes.

If any of the original wire as supplied with the appliance must be replaced, use only type 105°C thermoplastic or equivalent. 250°C type F must be used for the flame sensor leads and the spark ignition cable must be high voltage 250°C.

INSTALLATION DIAGRAMS-TOP INLET/OUTLET USAGE

GENERAL

The type, size and location of the relief valves must be in accordance with local codes. The locations of the relief valves shown in the installation diagrams are typical. The heater has a factory installed high temperature limit switch and temperature and pressure relief valve.

Cold water lines to heater should be installed as shown in order to minimize gravity circulation of hot water to building cold water lines.

A listed temperature and pressure relief valve of adequate capacity is installed on the heater. The locations shown in the installation diagrams on the following pages are typical.

The discharge opening of the temperature and pressure relief valve, located in front of the heater must be piped to an open drain and should not be subject to freezing temperatures.

Install in accordance with all local codes.

Use of the top inlet water connection requires installation of an inlet dip tube (refer to figure 12). The tube is supplied in the heater. Follow caution labels if applying heat to this fitting. Do not allow pipe dope to contact the plastic tube during installation.

CODE RESTRICTIONS

Use of the top inlet water connection is not permitted on installations in the state of North Carolina, due to the material of the tube (Polypropylene). Where such code restrictions exist, use only lower inlet tank connection. This may also require a

heat trap - check local codes. The "Top Outlet" connection may still be used on these applications. Plug or cap all unused openings in the tank before filling with water.



TEMPERATURE SETTING SHOULD NOT EXCEED SAFE USE TEMPERATURE AT FIXTURES. SEE WATER TEMPERATURE CONTROL WARNING ON PAGE 27. IF HIGHER PREHEAT TEMPERATURES ARE NECESSARY TO OBTAIN ADEQUATE BOOSTER OUTPUT, ADD AN ANTI-SCALD VALVE FOR HOT WATER SUPPLIED TO FIXTURES.

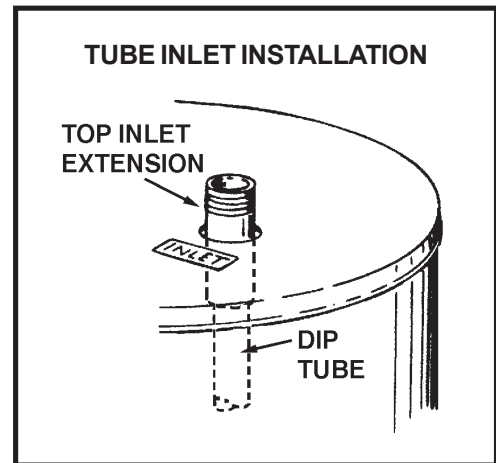
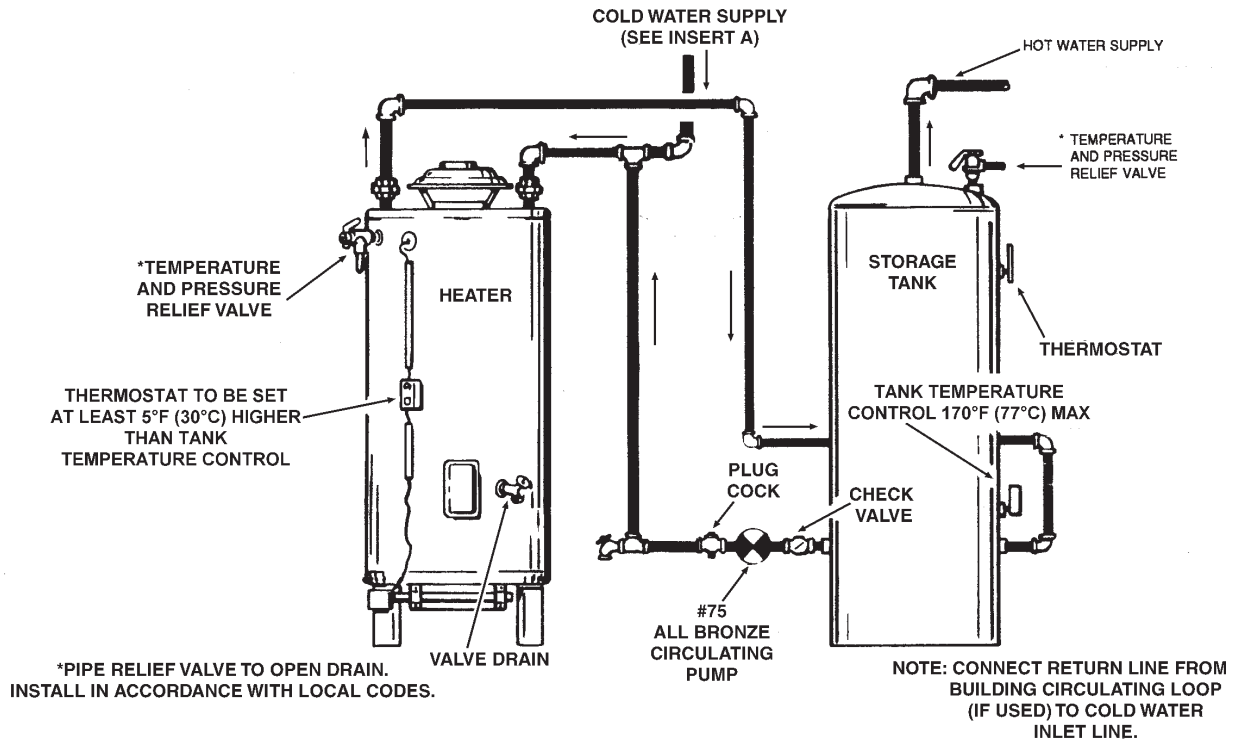

FIGURE 12

VERTICAL STORAGE TANK AND FORCED CIRCULATION



⚠ DANGER

TEMPERATURE SETTING SHOULD NOT EXCEED SAFE USE TEMPERATURE AT FIXTURES. SEE WATER TEMPERATURE CONTROL WARNING ON PAGE 27. IF HIGHER PREHEAT TEMPERATURES ARE NECESSARY TO OBTAIN ADEQUATE BOOSTER OUTPUT, ADD AN ANTI-SCALD VALVE FOR HOT WATER SUPPLIED TO FIXTURES.

HORIZONTAL STORAGE TANK AND FORCED CIRCULATION

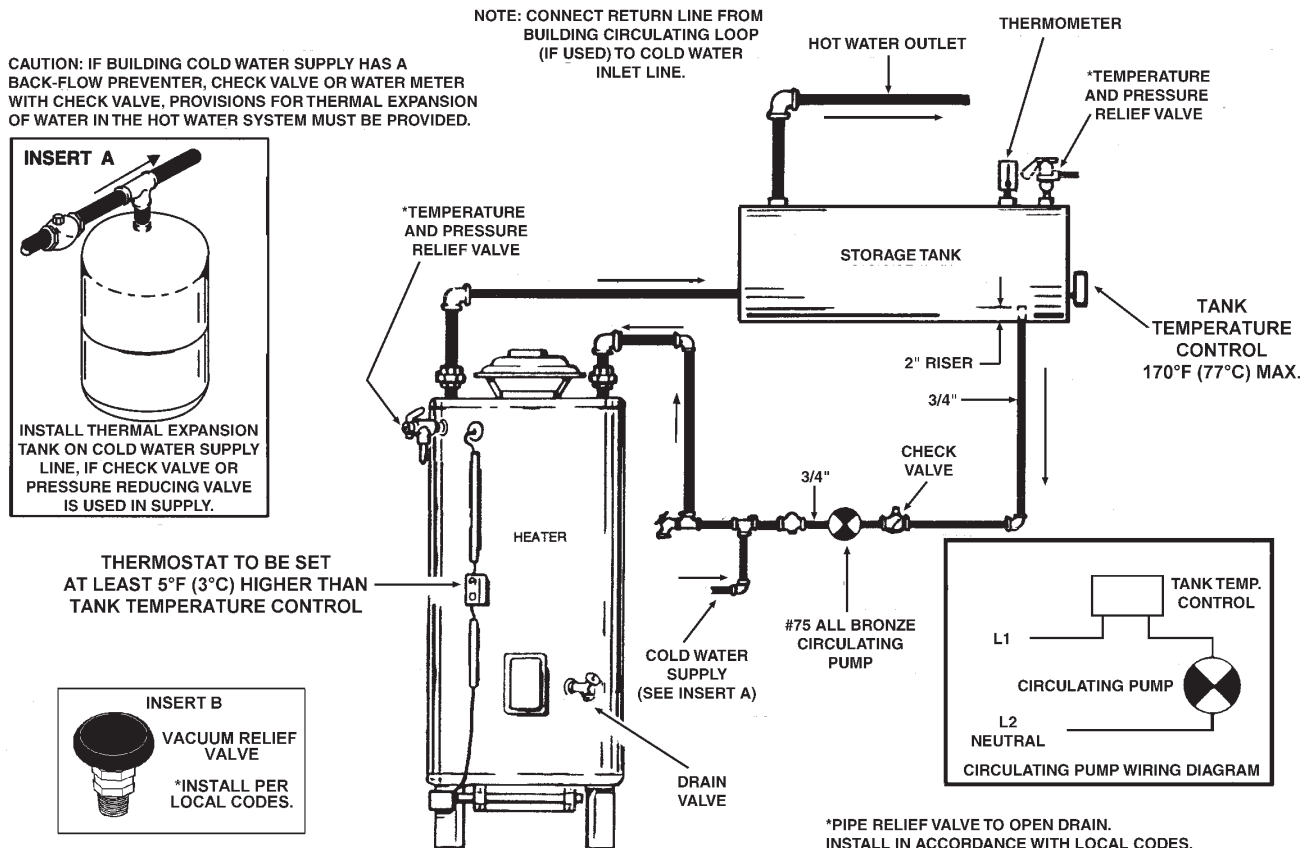

TWO TEMPERATURE - ONE HEATER HIGH TEMPERATURE STORAGE WITH RECIRCULATION OF SANITIZING LOOP

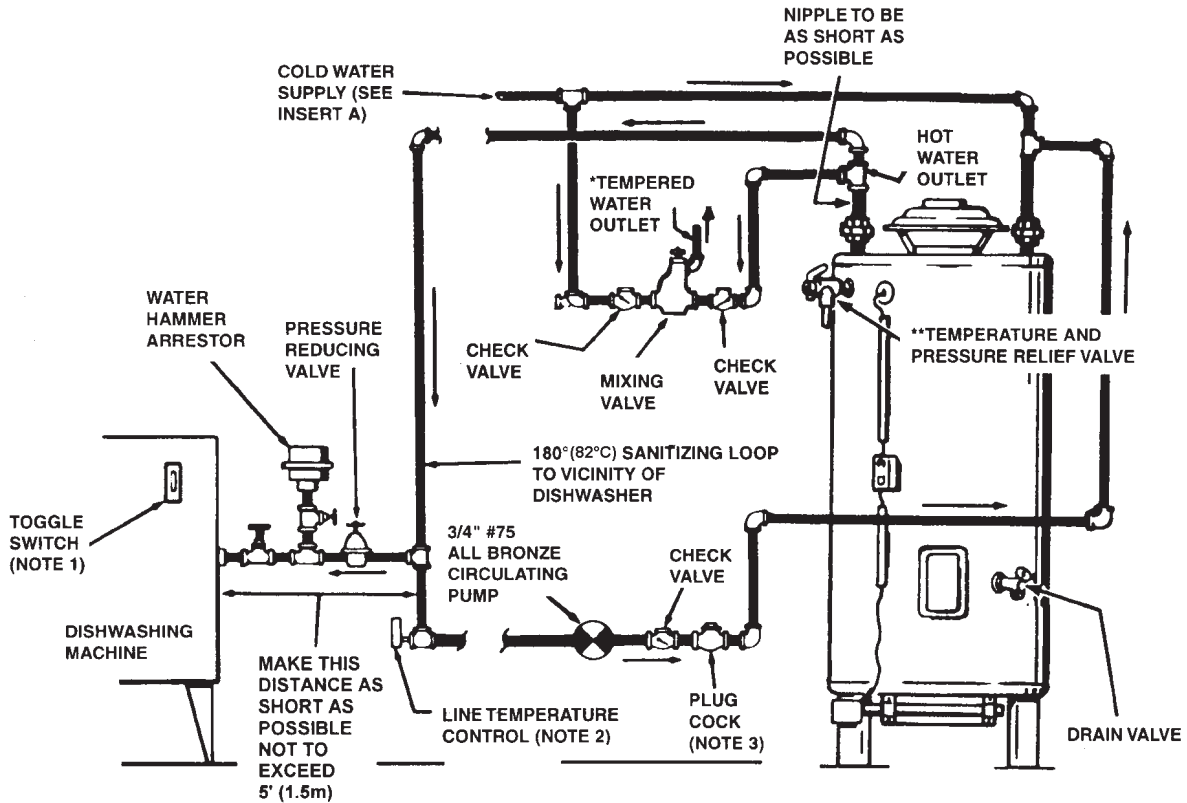

NOTE 1: TOGGLE SWITCH CONTROLS 180°F (82°C) WATER CIRCULATION. INSTALL ON OR CLOSE TO DISHWASHER MACHINE. TOGGLE SWITCH MUST BE CLOSED (ON) DURING THE RINSE OPERATION AND OPEN (OFF) WHEN DISHWASHER IS NOT OPERATING OR WHEN ON LONG STANDBY.

NOTE 2: INSTALL LINE TEMPERATURE CONTROL IN AN UNINSULATED TEE BEYOND THE DISHWASHER MACHINE TAKEOFF IN THE SANITIZING LOOP. CONTROL SHOULD BE SET AT 185°F (85°C).

NOTE 3: ADJUST PLUG COCK SO THE SANITIZING LOOP FLOW RATE DOES NOT CAUSE UNNECESSARY TURBULENCE IN THE TANK.

* TEMPERED WATER LOOP, IF USED, CONNECT TO POINT "A".

**PIPE RELIEF VALVE TO OPEN DRAIN.
INSTALL IN ACCORDANCE WITH LOCAL CODES.

CAUTION: IF BUILDING COLD WATER SUPPLY HAS A BACKFLOW PREVENTER, CHECK VALVE OR WATER METER WITH CHECK VALVE. PROVISIONS FOR THERMAL EXPANSION OF WATER IN THE HOT WATER SYSTEM MUST BE PROVIDED.

⚠ DANGER

TEMPERATURE SETTING SHOULD NOT EXCEED SAFE USE TEMPERATURE AT FIXTURES. SEE WATER TEMPERATURE CONTROL WARNING ON PAGE 27. IF HIGHER PREHEAT TEMPERATURES ARE NECESSARY TO OBTAIN ADEQUATE BOOSTER OUTPUT, ADD AN ANTI-SCALD VALVE FOR HOT WATER SUPPLIED TO FIXTURES.

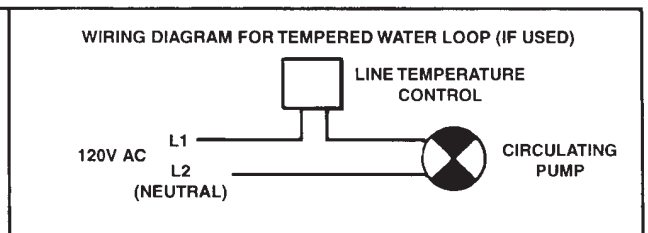
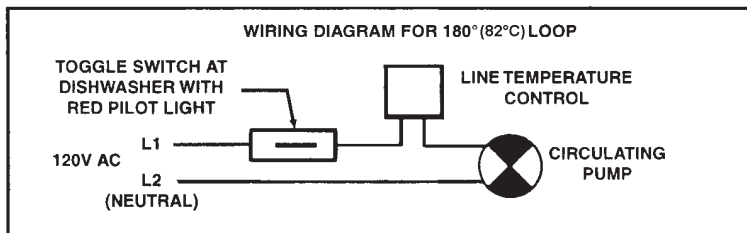
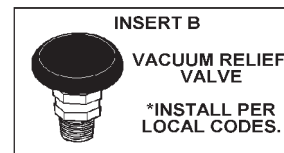
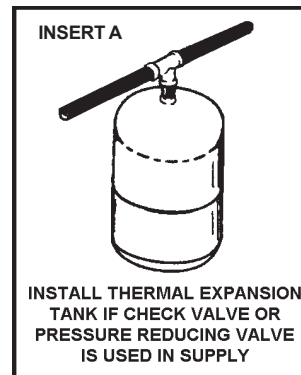

INSTALLATION DIAGRAMS-SIDE INLET/OUTLET USAGE

A listed temperature and pressure relief valve of adequate capacity is installed on the heater. The locations shown in the installation diagrams on the following pages are typical.

The discharge opening of the temperature and pressure relief valve must be piped to an open drain and should not be subject to freezing conditions. DO NOT REDUCE, BLOCK OR PLUG THE DISCHARGE OPENING OF THE VALVE.

TWO TEMPERATURE - TWO HEATERS, ONE PRE-HEATER/ONE - BOOSTER HEATER WITH OR WITHOUT BUILDING RECIRCULATION

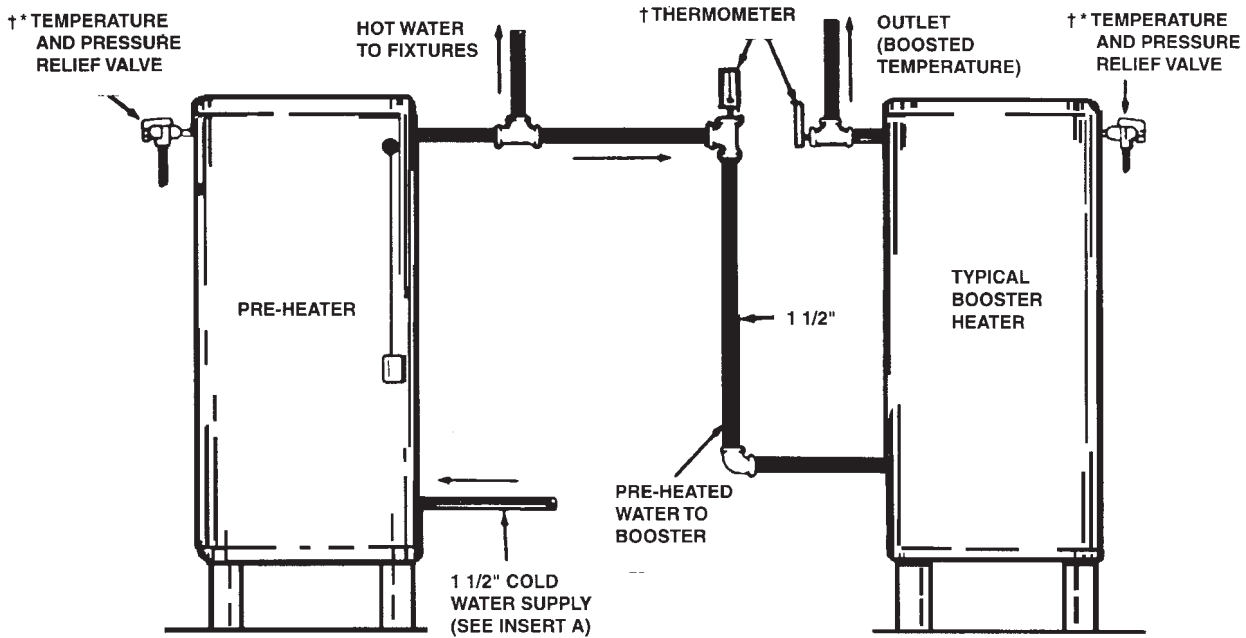

⚠ DANGER

TEMPERATURE SETTING SHOULD NOT EXCEED SAFE USE TEMPERATURE AT FIXTURES. SEE WATER TEMPERATURE CONTROL WARNING ON PAGE 27. IF HIGHER PREHEAT TEMPERATURES ARE NECESSARY TO OBTAIN ADEQUATE BOOSTER OUTPUT, ADD AN ANTI-SCALD VALVE FOR HOT WATER SUPPLIED TO FIXTURES.

CIRCULATING RETURN LINE CONNECTIONS

- FROM FIXTURE LOOP, IF USED, CONNECT TO PREHEATER INLET.
- FROM BOOSTED TEMPERATURE LOOP, IF USED CONNECT TO BOOSTER INLET.

†AVAILABLE FROM STATE WATER HEATERS.

*PIPE RELIEF VALVE TO OPEN DRAIN.

INSTALL IN ACCORDANCE WITH LOCAL CODES.

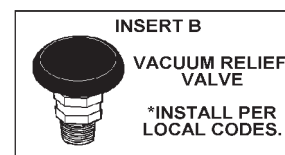
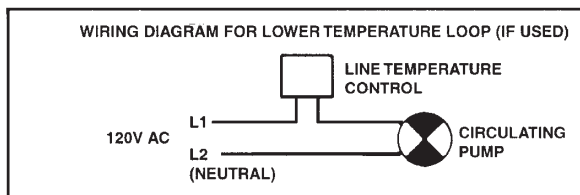
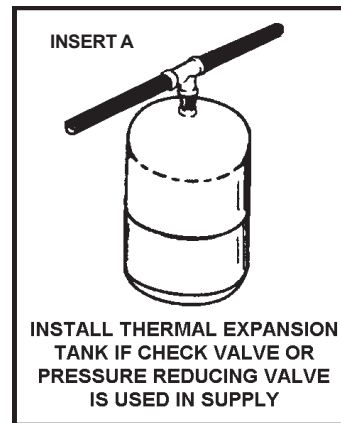

ONE OR TWO TEMPERATURE - ONE HEATER, HIGH TEMPERATURE STORAGE WITH OR WITHOUT RECIRCULATION

HEATER WITH OR WITHOUT MIXING VALVE

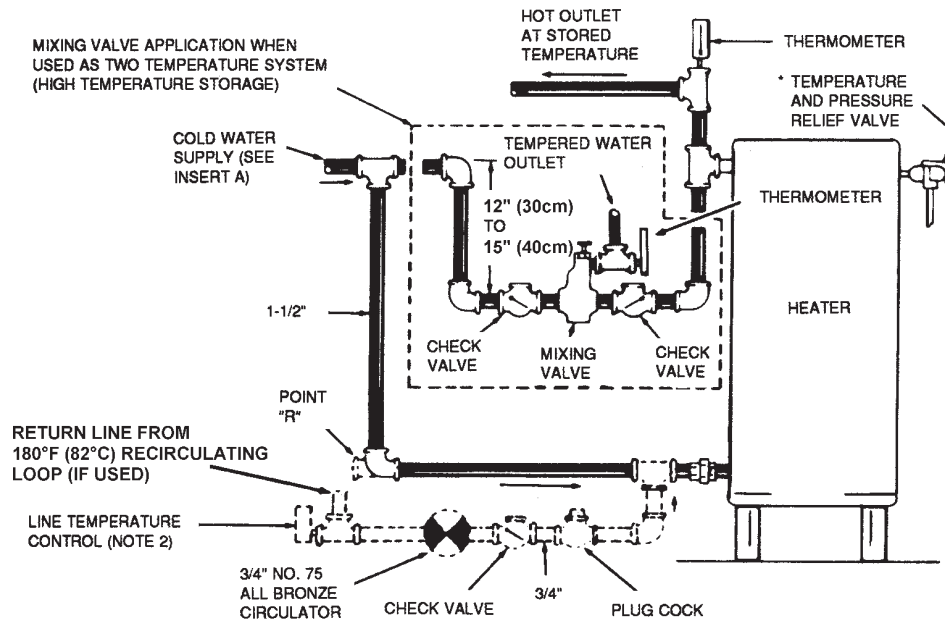

TEMPERATURE SETTING SHOULD NOT EXCEED SAFE USE TEMPERATURE AT FIXTURES. SEE WATER TEMPERATURE CONTROL WARNING ON PAGE 27. IF HIGHER PREHEAT TEMPERATURES ARE NECESSARY TO OBTAIN ADEQUATE BOOSTER OUTPUT, ADD AN ANTI-SCALD VALVE FOR HOT WATER SUPPLIED TO FIXTURES.

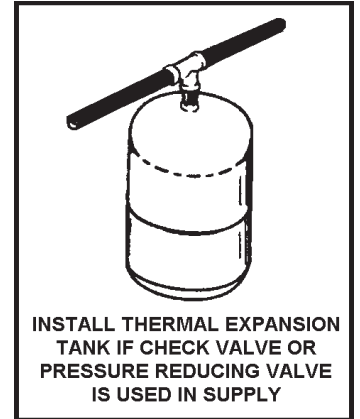

INSTALL THERMAL EXPANSION TANK IF CHECK VALVE OR PRESSURE REDUCING VALVE IS USED IN SUPPLY

HEATER WITH MIXING VALVE AND RECIRCULATED SANITIZING LOOP

- NOTE 1: TOGGLE SWITCH CONTROLS 180°F (82°C) WATER CIRCULATION. INSTALL ON OR CLOSE TO DISHWASHING MACHINE. TOGGLE SWITCH MUST BE CLOSED (ON) DURING THE RINSE OPERATION AND OPEN (OFF) WHEN DISHWASHER IS NOT OPERATING OR WHEN ON LONG STANDBY.
- NOTE 2: INSTALL LINE TEMPERATURE CONTROL IN AN UNINSULATED TEE BEYOND THE DISHWASHING MACHINE TAKEOFF IN THE SANITIZING LOOP. CONTROL SHOULD BE SET AT 185°F (85°C).
- NOTE 3: ADJUST PLUG COCK SO THE SANITIZING LOOP FLOW RATE DOES NOT CAUSE UNNECESSARY TURBULENCE IN THE TANK.
- * PIPE RELIEF VALVE TO OPEN DRAIN.
- INSTALL IN ACCORDANCE WITH LOCAL CODES.
- CIRCULATING RETURN LINE CONNECTIONS.
- TEMPERED WATER LOOP, IF USED, CONNECT TO POINT "R".
 - STORED TEMPERATURE WATER LOOP, IF USED, CONNECT TO COLD WATER INLET.

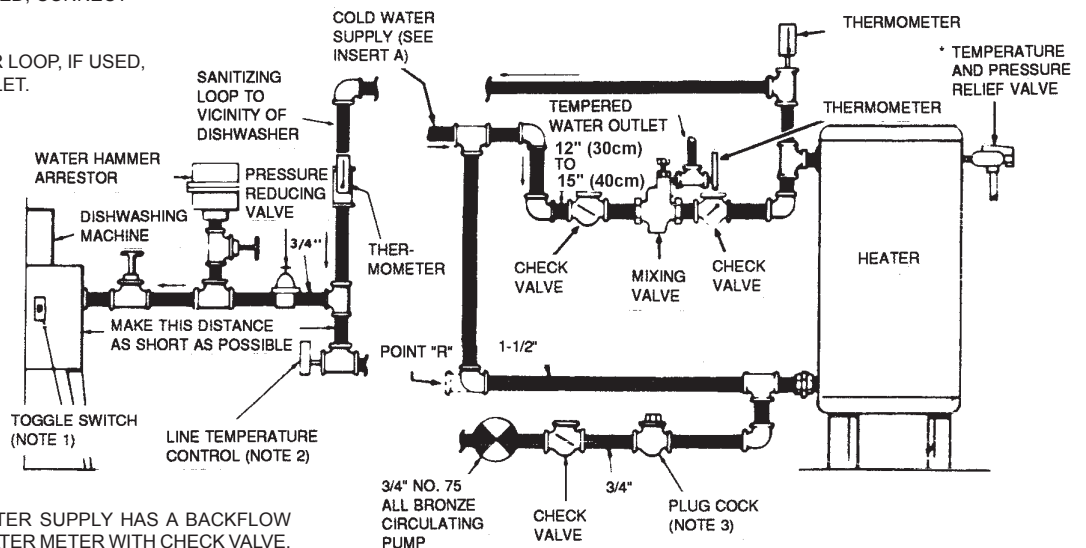
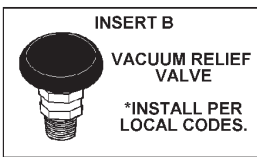

CAUTION: IF BUILDING COLD WATER SUPPLY HAS A BACKFLOW PREVENTER, CHECK VALVE OR WATER METER WITH CHECK VALVE. PROVISIONS FOR THERMAL EXPANSION OF WATER IN THE HOT WATER SYSTEM MUST BE PROVIDED.

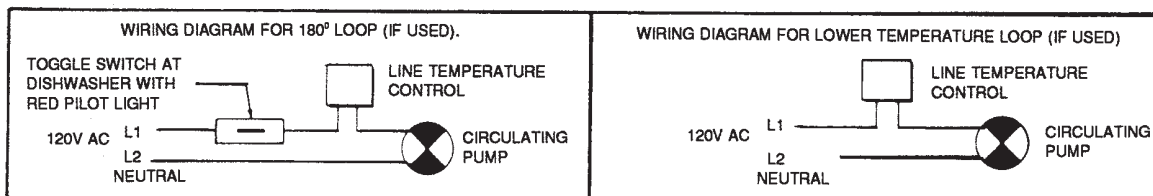

TWO TEMPERATURE - TWO PRE-HEATERS WITH MIXING VALVE OR BOOSTER HEATER WITH OR WITHOUT BUILDING RECIRCULATION

TWO PRE-HEATERS WITH MIXING VALVE

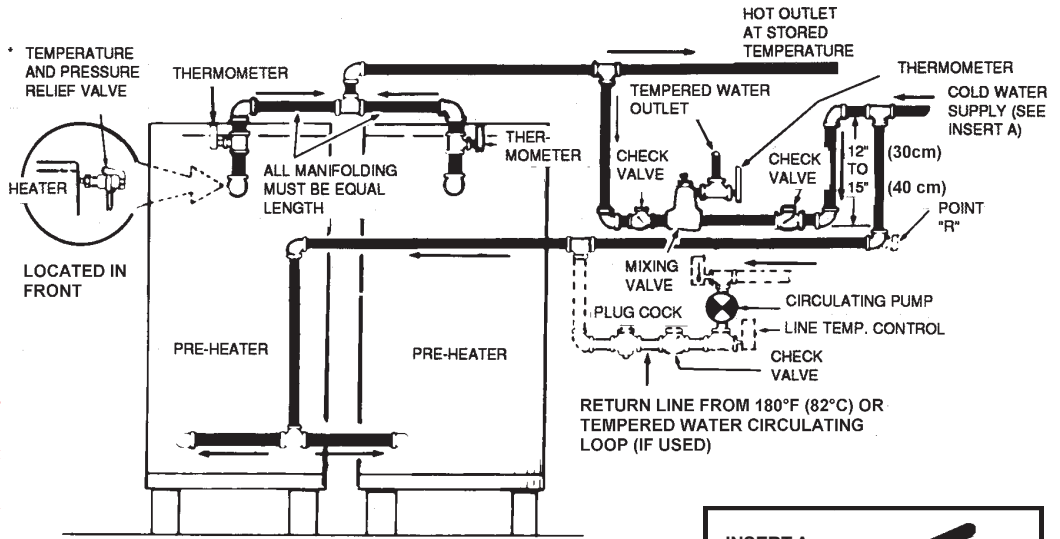
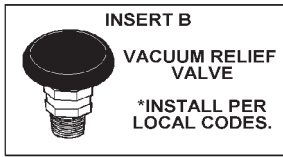

⚠ DANGER
 TEMPERATURE SETTING SHOULD NOT EXCEED SAFE USE TEMPERATURE AT FIXTURES. SEE WATER TEMPERATURE CONTROL WARNING ON PAGE 27. IF HIGHER PREHEAT TEMPERATURES ARE NECESSARY TO OBTAIN ADEQUATE BOOSTER OUTPUT, ADD AN ANTI-SCALD VALVE FOR HOT WATER SUPPLIED TO FIXTURES.

MUST BE IDENTICAL HEATERS
 CIRCULATING RETURN CONNECTIONS
 TEMPERED WATER LOOP, IF USED, CONNECT TO POINT "R"

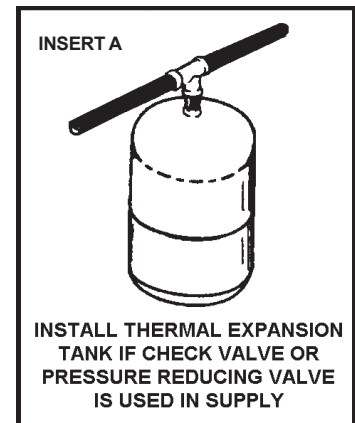

TWO PRE-HEATERS WITH BOOSTER HEATER

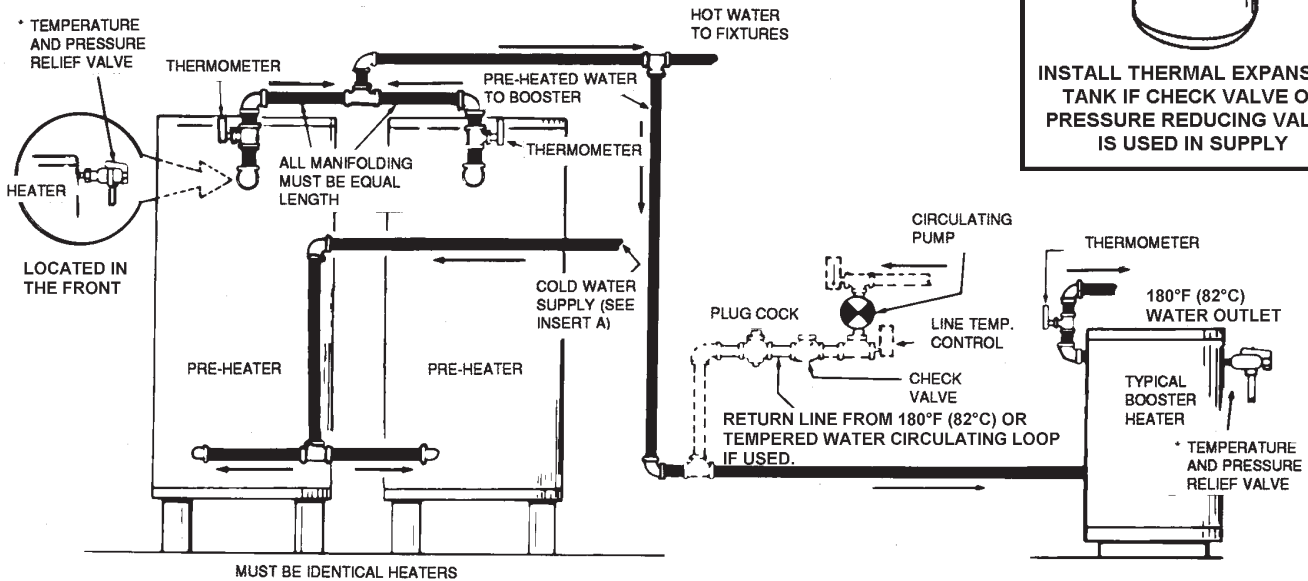

CAUTION: IF BUILDING COLD WATER SUPPLY HAS A BACKFLOW PREVENTER, CHECK VALVE OR WATER METER WITH CHECK VALVE, PROVISIONS FOR THERMAL EXPANSION OF WATER IN THE HOT WATER SYSTEM MUST BE PROVIDED.

INSTALL IN ACCORDANCE WITH LOCAL CODES.

CIRCULATING RETURN LINE CONNECTIONS.

- FOR PRE-HEATED WATER LOOP, IF USED CONNECT TO COLD WATER INLET OR PRE-HEATERS.

* PIPE RELIEF VALVE TO OPEN DRAIN.

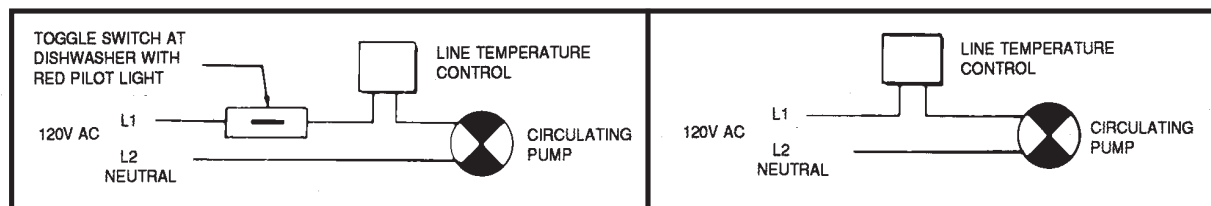

MEDIUM TEMPERATURE - ONE HEATER WITH AUXILIARY STORAGE TANK FORCED CIRCULATION WITH OR WITHOUT BUILDING RECIRCULATION

VERTICAL STORAGE TANK

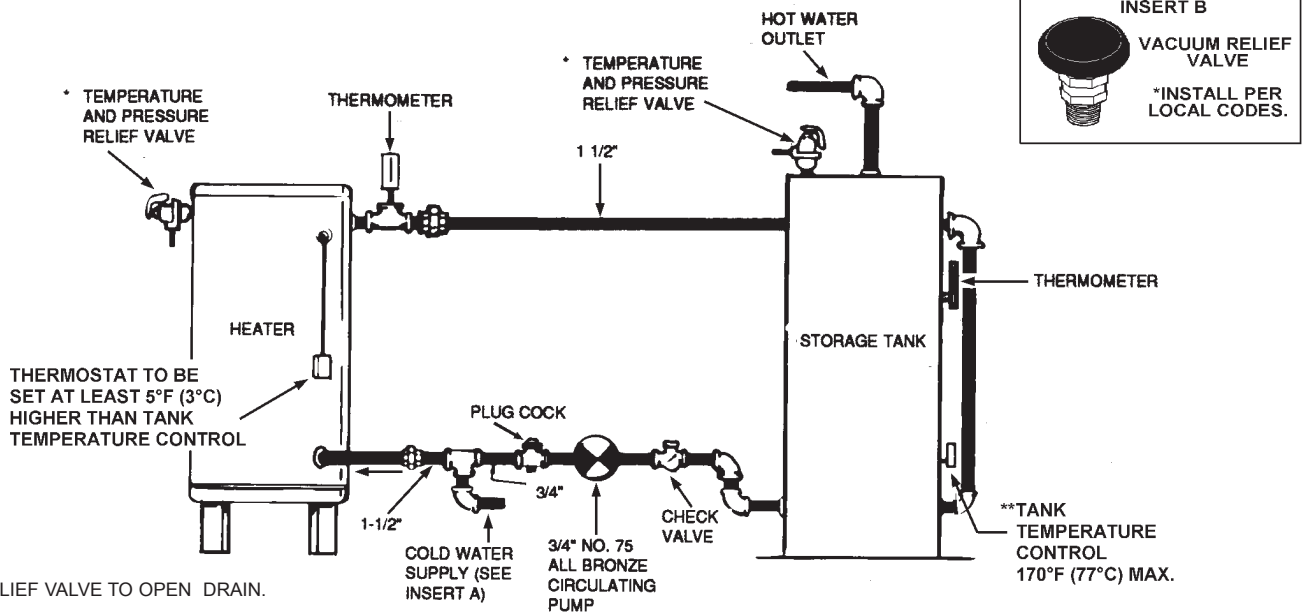

* PIPE RELIEF VALVE TO OPEN DRAIN.

**WHEN USING A STATE T-140, -200, -350 OR -400 STORAGE TANK, USE LOWER 3/4" OPENING FOR TANK TEMPERATURE CONTROL.

IF BUILDING CIRCULATING LOOP IS USED, CONNECT TO AN OPENING NEAR THE BOTTOM OF THE TANK.

HORIZONTAL STORAGE TANK

CAUTION: IF BUILDING COLD WATER SUPPLY HAS A BACKFLOW PREVENTER, CHECK VALVE OR WATER METER WITH CHECK VALVE, PROVISIONS FOR THERMAL EXPANSION OF WATER IN THE HOT WATER SYSTEM MUST BE PROVIDED.

*PIPE RELIEF VALVE TO OPEN DRAIN
INSTALL IN ACCORDANCE WITH LOCAL CODES.

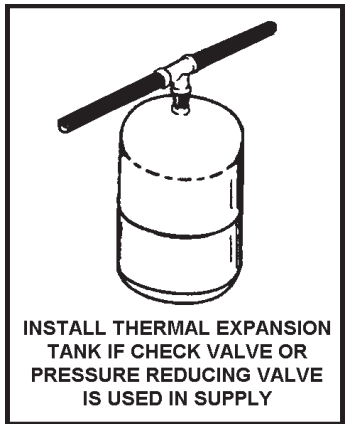
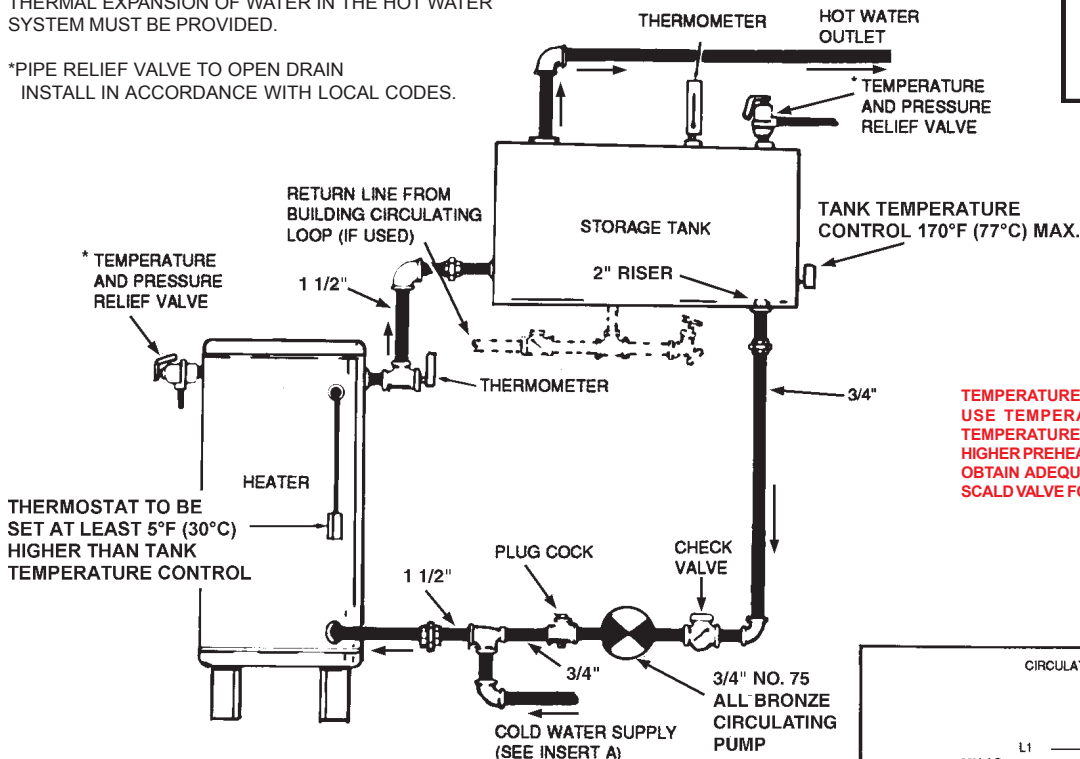

⚠ DANGER

TEMPERATURE SETTING SHOULD NOT EXCEED SAFE USE TEMPERATURE AT FIXTURES. SEE WATER TEMPERATURE CONTROL WARNING ON PAGE 27. IF HIGHER PREHEAT TEMPERATURES ARE NECESSARY TO OBTAIN ADEQUATE BOOSTER OUTPUT, ADD AN ANTISCALD VALVE FOR HOT WATER SUPPLIED TO FIXTURES.

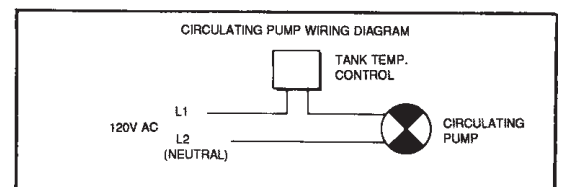

MANIFOLD KITS

TWO UNIT MANIFOLD KIT (PART NO. 78692)

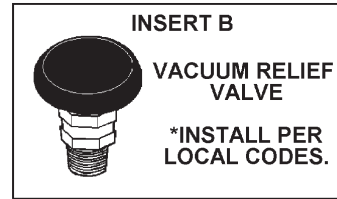
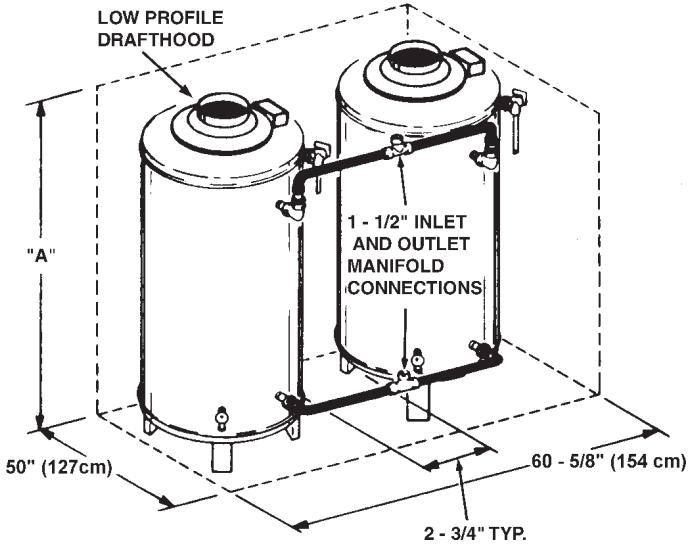

MODEL	DIMENSIONS "A" INCHES (CM)	
	LOW PROFILE VERTICAL HOOD "A"	
	SBD MODELS	SBD MODELS
120	69.75" (177cm)	69.75" (177cm)
154	73.00" (185cm)	73.00" (185cm)
180	67.50" (171cm)	70.50" (179cm)
197	75.00" (192cm)	81.50" (207cm)
198	75.00" (192cm)	N/A
199	67.50" (171cm)	70.50" (179cm)
200	72.00" (183cm)	72.00" (183cm)
250	72.00" (183cm)	72.00" (183cm)
251	75.00" (191cm)	75.00" (191cm)
275	72.00" (183cm)	72.00" (183cm)
305	75.00" (191cm)	75.00" (191cm)
365	79.50" (202cm)	75.00" (191cm)
400	75.50" (192cm)	75.50" (192cm)
500	82.25" (209cm)	82.25" (209cm)

THREE UNIT MANIFOLD KIT (PART NO. 78593)

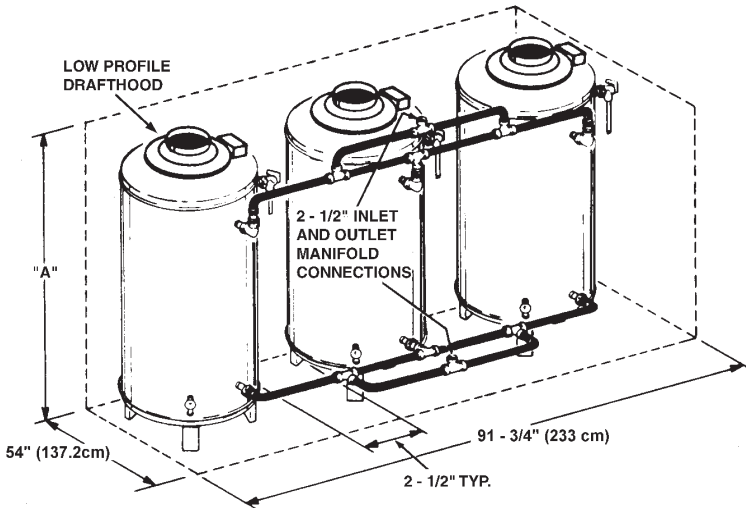

FOUR UNIT MANIFOLD KIT (PART NO. 78694)

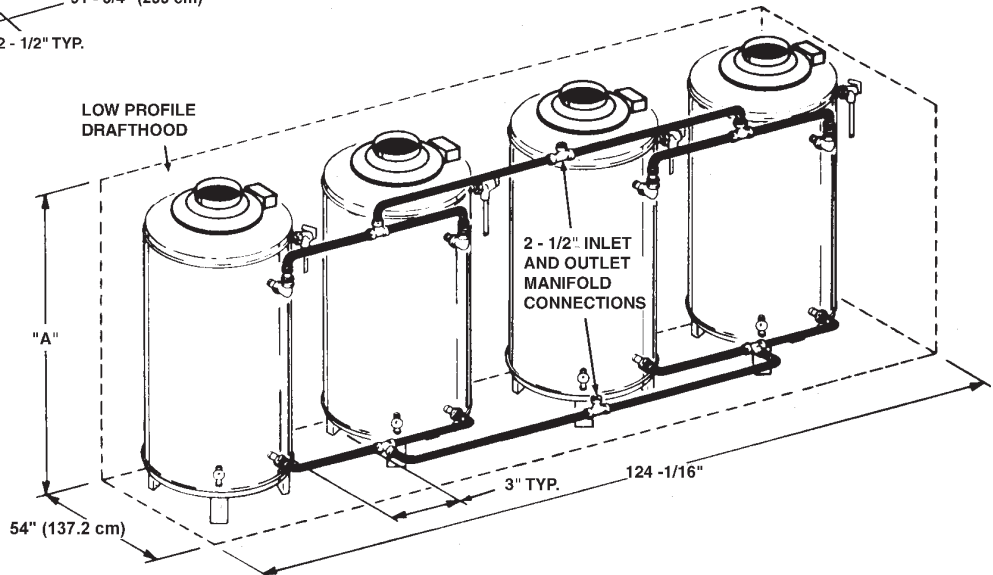

MECHANICAL VENTING

SINGLE UNIT INSTALLATION

When mechanical venting of these heaters is desired, the following kits are available.

SBD 120 through the SBD 200/A
State part number 193933

SBD 250/A through the SBD 500/A
State part number 193933-1

Where an approved power venter is to be installed to operate in conjunction with the water heater thermostat, the following codes must be adhered to. Field wiring should conform to the latest version of the National Electric Code ANSI/NFPA No. 70. For Canadian installations the electrical connections and grounding shall be done in accordance with the current Canadian Electrical Code CSA C22.1 Part 1 and/or local codes.

NOTE: The power venter must be installed downstream of the drafthood. See figure 13.

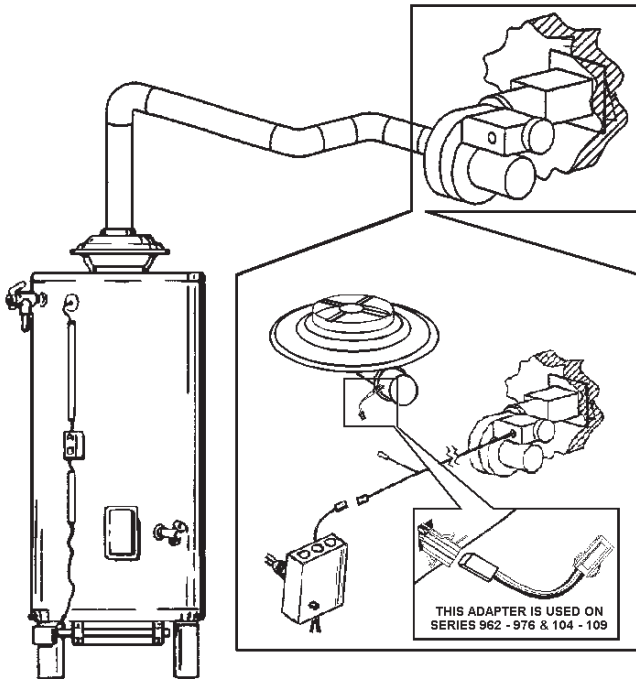

FIGURE 13

VENT INSTALLATION

Seal all joints between the power venter and the vent termination. This is to prevent leakage of exhaust products into the room(s) due to positive pressure of blower.

The "Sequence of Operation" description will be the same with mechanical venting except,

When the appliance thermostat calls for heat:

Thermostat contacts "Close" and the power venter blower (120 VAC) is energized. Sufficient draft must be established for the "Draft Prover Switch (N.O.)" to "Close". When the draft prover switch "Closes" the relay coil of the flue damper is energized.

See side wall vent kit installation manual for complete instructions.

MULTIPLE UNIT INSTALLATIONS

For multiple unit installations, contact State Water Heaters Technical Support Center at 1-800-527-1953.

**TABLE 5
MANIFOLD GAS PRESSURE IN INCHES
OF WATER COLUMN (ALL MODELS*)**

TYPE OF GAS	
NATURAL	PROPANE
3.5	10.0

Gas pressure specified in Table 5, refer to flow pressure taken at pressure tap of automatic gas valve while heater is operating.

**TABLE 6
APPROXIMATE TIME REQUIRED TO CONSUME
1 CU. FT. OF GAS AT FULL CAPACITY**

INPUT RATE (BTUH)	TYPE OF GAS	BTUH PER CU. FT.	TIME REQ'D TO CONSUME 1 CU. FT. OF GAS
120,000	NATURAL	1050	31.5 SEC.
	PROPANE	2500	75.0 SEC.
154,000	NATURAL	1050	24.5 SEC.
	PROPANE	2500	58.4 SEC.
180,000	NATURAL	1050	21.1 SEC.
	PROPANE	2500	50.3 SEC.
190,000	NATURAL	1050	19.9 SEC.
	PROPANE	2500	47.4 SEC.
199,000	NATURAL	1050	19.0 SEC.
	PROPANE	2500	47.4 SEC.
250,000	NATURAL	1050	15.1 SEC.
	PROPANE	2500	35.3 SEC.
251,000	NATURAL	1050	15.06 SEC.
	PROPANE	2500	35.1 SEC.
275,000	NATURAL	1050	13.75 SEC.
	PROPANE	2500	32.2 SEC.
305,000	NATURAL	1050	12.4 SEC.
	PROPANE	2500	29.5 SEC.
360,000	NATURAL	1050	11.4 SEC.
	PROPANE	2500	24.0 SEC.
365,000	NATURAL	1050	10.4 SEC.
	PROPANE	2500	24.7 SEC.
399,000	NATURAL	1050	9.5 SEC.
	PROPANE	2500	22.6 SEC.
500,000	NATURAL	1050	7.6 SEC.
	PROPANE	2500	18.0 SEC.

Figures shown are valid for 0-2000 ft.(0-610m) installations. See "HIGH ALTITUDE INSTALLATIONS" for deration requirements over 2000 ft.(610m).

**TABLE 7
PILOT BURNER INFORMATION**

MODEL	TYPE OF GAS	PILOT BURNER PART NUMBER (WITH ORIFICE)	RATED ORIFICE SIZE
ALL MODELS	NATURAL	193314-0	0.018
	PROPANE	193314-1	0.014

OPERATION

IMPORTANT

A qualified person must perform the initial firing of the heater. At this time the user should not hesitate to ask the individual any questions which they may have in regard to the operation and maintenance of the unit.

An Operational Checklist is included at the rear of this manual. By using this checklist the user may be able to make minor operational adjustments and avoid unnecessary service calls. However, the user should not attempt repairs which are not listed under the USER column.

GENERAL

NEVER OPERATE THE HEATER WITHOUT FIRST BEING CERTAIN IT IS FILLED WITH WATER AND A TEMPERATURE AND PRESSURE RELIEF VALVE IS INSTALLED IN THE RELIEF VALVE OPENING OF THE HEATER.

SHOULD OVERHEATING OCCUR OR THE GAS SUPPLY FAIL TO SHUT OFF, TURN OFF THE MANUAL GAS CONTROL VALVE TO THE APPLIANCE.

CAUTION

Before proceeding with the operation of the unit make sure the water heater and system are filled with water and all air is expelled.

FILLING

1. Close the heater drain valve by turning handle clockwise.
2. Open a nearby hot water faucet to permit the air in the system to escape.
3. Fully open the cold water inlet pipe valve allowing the heater and piping to be filled.
4. Close the hot water faucet as water starts to flow.
5. The heater is ready to be operated.

PURGING

Gas line purging is required with new piping or systems in which air has entered.

CAUTION

PURGING SHOULD BE PERFORMED BY PERSONS EXPERIENCED IN THIS TYPE GAS SERVICE. TO AVOID RISK OF FIRE OR EXPLOSION, PURGE DISCHARGE MUST NOT ENTER CONFINED AREAS OR SPACES WHERE IGNITION CAN OCCUR. THE AREA MUST BE WELL VENTILATED AND ALL SOURCES OF IGNITION MUST BE INACTIVATED OR REMOVED.

WARNING

THE GAS VALVE MUST HAVE BEEN IN THE OFF POSITION FOR AT LEAST 5 MINUTES. This waiting period is an important safety step. Its purpose is to permit gas that may have accumulated in the combustion chamber to clear. IF YOU DETECT GAS ODOR AT THE END OF THIS PERIOD DO NOT PROCEED WITH LIGHTING. RECOGNIZE THAT GAS EVEN IF IT SEEMS WEAK, MAY INDICATE PRESENCE OF ACCUMULATED GAS SOMEPLACE IN THE AREA WITH RISK OF FIRE OR EXPLOSION. SEE THE FRONT PAGE FOR STEPS TO BE TAKEN. All gas and water lines are to have been leak tested and open to the respective gas and water supplies.

With above conditions satisfied, light the unit in accordance with the instructions on the Operating label attached to the heater. If label instructions are not legible - determine which gas valve the appliance is equipped with and use the applicable OPERATING INSTRUCTIONS as follows:

IF PILOT FLAME GOES OUT - Main burners will extinguish and pilot will attempt reignition.

DAMPER MUST BE IN FULL OPEN POSITION FOR PILOT AND/OR MAIN BURNER IGNITION TO OCCUR - See SEQUENCE OF OPERATION for complete description.

Each heater is equipped with a Honeywell Ignition Module. This module will try to prove pilot for 90 seconds. If pilot is not proven within the 90 secs, the unit will retry after 5 minutes. This cycle will continue until pilot is proven.

If pilot does not ignite when system calls for heat, check for pilot ignition spark at pilot assembly. Refer to OPERATIONAL CHECKLIST and EFFIKAL RVGP-KSF SERIES FLUE DAMPER TROUBLESHOOTING GUIDE.

FOR YOUR SAFETY READ BEFORE OPERATING



WARNING: IF YOU DO NOT FOLLOW THESE INSTRUCTIONS EXACTLY A FIRE OR EXPLOSION MAY RESULT CAUSING PROPERTY DAMAGE, PERSONAL INJURY OR LOSS OF LIFE.



- | | |
|----------------------------------------------------------------------------------------------------------------------------------------------------------------------------------------------------------------------------------------------------------------------------------------------------------------------------------------------------------------------------------------------------------------------------------------------------------------------------------------------------------------------------------------------------------------------------------------------------------------------------------------------------------------------------------------------------------------------------|------------------------------------------------------------------------------------------------------------------------------------------------------------------------------------------------------------------------------------------------------------------------------------------------------------------------------------------------------------------------------------------------------------------------------------------------------------------------------------------------------------------------------------------------------------------------------------------------------------------------------------------------------------------|
| <p>A. THIS APPLIANCE IS EQUIPPED WITH AN IGNITION DEVICE WHICH AUTOMATICALLY LIGHTS THE PILOT. DO NOT TRY TO LIGHT THE PILOT BY HAND.</p> <p>B. BEFORE OPERATING SMELL ALL AROUND THE APPLIANCE AREA FOR GAS. BE SURE TO SMELL NEXT TO THE FLOOR BECAUSE SOME GAS IS HEAVIER THAN AIR AND WILL SETTLE ON THE FLOOR.</p> <p>WHAT TO DO IF YOU SMELL GAS</p> <ul style="list-style-type: none"> • DO NOT TRY TO LIGHT ANY APPLIANCE. • DO NOT TOUCH ANY ELECTRIC SWITCH DO NOT USE ANY PHONE IN YOUR BUILDING. • IMMEDIATELY CALL YOUR GAS SUPPLIER FROM A NEIGHBOR'S PHONE. FOLLOW THE GAS SUPPLIER'S INSTRUCTIONS. • IF YOU CANNOT REACH YOUR GAS SUPPLIER, | <p>C. CALL THE FIRE DEPARTMENT. USE ONLY YOUR HAND TO PUSH IN OR TURN THE GAS CONTROL KNOB. NEVER USE TOOLS. IF THE KNOB WILL NOT PUSH IN OR TURN BY HAND, DON'T TRY TO REPAIR IT. CALL A QUALIFIED SERVICE TECHNICIAN. FORCE OR ATTEMPTED REPAIR MAY RESULT IN A FIRE OR EXPLOSION.</p> <p>D. DO NOT USE THIS APPLIANCE IF ANY PART HAS BEEN UNDER WATER. IMMEDIATELY CALL A QUALIFIED SERVICE TECHNICIAN TO INSPECT THE APPLIANCE AND TO REPLACE ANY PART OF THE CONTROL SYSTEM AND ANY GAS CONTROL WHICH HAS BEEN UNDER WATER.</p> <p>E. DO NOT OPERATE APPLIANCE UNLESS UNIT IS FILLED WITH WATER AND INLET LINES AFTER FULLY OPEN.</p> |
|----------------------------------------------------------------------------------------------------------------------------------------------------------------------------------------------------------------------------------------------------------------------------------------------------------------------------------------------------------------------------------------------------------------------------------------------------------------------------------------------------------------------------------------------------------------------------------------------------------------------------------------------------------------------------------------------------------------------------|------------------------------------------------------------------------------------------------------------------------------------------------------------------------------------------------------------------------------------------------------------------------------------------------------------------------------------------------------------------------------------------------------------------------------------------------------------------------------------------------------------------------------------------------------------------------------------------------------------------------------------------------------------------|

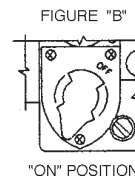
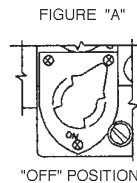
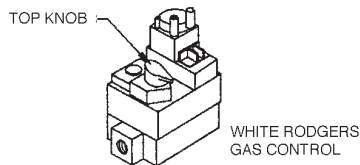

OPERATING

- | | |
|---------------------------------------------------------------------------------------------------------------------------------------------------------------------------------------------------------------------------------------------------------------------------------------------------------------------------------------------------------------------------------------------------------------------------------------------------------------------------------------------------------------------------------------------------------------------------------------------------------------------------------------------------------------------------------------------------------------------------------------------------------------------------------------------------------------------------------------------------------------------------------------------------------------------|--------------------------------------------------------------------------------------------------------------------------------------------------------------------------------------------------------------------------------------------------------------------------------------------------------------------------------------------------------------------------------------------------------------------------------------------------------------------------------------------------------------------------------------------------------------------------------------------------------------------|
| <ol style="list-style-type: none"> 1. STOP! READ THE SAFETY INFORMATION ON THIS LABEL. 2. TURN "OFF" ALL ELECTRICAL POWER TO THE APPLIANCE. THE FLUE DAMPER WILL AUTOMATICALLY SPRING TO "OPEN" POSITION 3. THIS APPLIANCE IS EQUIPPED WITH AN IGNITION DEVICE WHICH AUTOMATICALLY LIGHTS THE PILOT. DO NOT TRY TO LIGHT THE PILOT BY HAND. 4. REFER TO THE DIAGRAMS ABOVE. TURN TOP KNOB OF THE GAS CONTROL VALVE CLOCKWISE TO "OFF" POSITION (FIG. A). 5. REMOVE THERMOSTAT CONTROL COVER. ROTATE THERMOSTAT DIAL-BY HAND-COUNTERCLOCKWISE TO LOWEST SETTING. DO NOT FORCE DIAL OR MECHANICAL STOP. 6. WAIT FIVE (5) MINUTES TO CLEAR OUT ANY GAS. IF YOU THEN SMELL GAS: <ul style="list-style-type: none"> STOP! FOLLOW "B" IN THE SAFETY INFORMATION ABOVE IN THIS LABEL. IF YOU DON'T SMELL GAS. GO TO NEXT STEP. | <ol style="list-style-type: none"> 7. TURN GAS CONTROL TOP KNOB COUNTERCLOCKWISE TO "ON" POSITION, DO NOT FORCE KNOB. 8. TURN ON ALL ELECTRICAL POWER TO THE APPLIANCE. 9. ROTATE APPLIANCE THERMOSTAT DIAL BY HAND DESIRED SETTING. DO NOT FORCE. FLUE DAMPER WILL "OPEN" AND PILOT IGNITION WILL OCCUR. WHEN PILOT IGNITION IS SENSED, THE MAIN BURNER(S) WILL IGNITE. 10. REPLACE THERMOSTAT CONTROL COVER. 11. IF THE APPLIANCE WILL NOT OPERATE, FOLLOW THE INSTRUCTIONS "TO TURN OFF GAS TO APPLIANCE" AND CALL YOUR SERVICE TECHNICIAN OR GAS SUPPLIER. |
|---------------------------------------------------------------------------------------------------------------------------------------------------------------------------------------------------------------------------------------------------------------------------------------------------------------------------------------------------------------------------------------------------------------------------------------------------------------------------------------------------------------------------------------------------------------------------------------------------------------------------------------------------------------------------------------------------------------------------------------------------------------------------------------------------------------------------------------------------------------------------------------------------------------------|--------------------------------------------------------------------------------------------------------------------------------------------------------------------------------------------------------------------------------------------------------------------------------------------------------------------------------------------------------------------------------------------------------------------------------------------------------------------------------------------------------------------------------------------------------------------------------------------------------------------|

TO TURN OFF GAS TO APPLIANCE

1. ROTATE THERMOSTAT DIAL -BY HAND- COUNTERCLOCKWISE TO LOWEST SETTING. SEE STEP 5 ABOVE.
2. TURN OFF ALL ELECTRICAL POWER TO THE APPLIANCE IF SERVICE IS TO BE PERFORMED.
3. REMOVE CONTROL ACCESS PANEL.
4. TURN KNOB OF GAS CONTROL VALVE CLOCKWISE TO "OFF" POSITION. SEE STEP 4 ABOVE AND
5. REPLACE ACCESS COVERS (SEE STEP 10 ABOVE).

FOR YOUR SAFETY READ BEFORE OPERATING



WARNING: IF YOU DO NOT FOLLOW THESE INSTRUCTIONS EXACTLY A FIRE OR EXPLOSION MAY RESULT CAUSING PROPERTY DAMAGE, PERSONAL INJURY OR LOSS OF LIFE.



- | | |
|---------------------------------------------------------------------------------------------------------------------------------------------------------------------------------------------------------------------------------------------------------------------------------------------------------------------------------------------------------------------------------------------------------------------------------------------------------------------------------------------------------------------------------------------------------------------------------------------------------------------------------------------------------------------------------------------------------------|-----------------------------------------------------------------------------------------------------------------------------------------------------------------------------------------------------------------------------------------------------------------------------------------------------------------------------------------------------------------------------------------------------------------------------------------------------------------------------------------------------------------------------------------------------------------------------------------------------------------------------------------------------|
| <p>A. THIS APPLIANCE IS EQUIPPED WITH AN IGNITION DEVICE WHICH AUTOMATICALLY LIGHTS THE PILOT. DO NOT TRY TO LIGHT THE PILOT BY HAND.</p> <p>B. BEFORE OPERATING SMELL ALL AROUND THE APPLIANCE AREA FOR GAS . BE SURE TO SMELL NEXT TO THE FLOOR BECAUSE SOME GAS IS HEAVIER THAN AIR AND WILL SETTLE ON THE FLOOR.</p> <p>WHAT TO DO IF YOU SMELL GAS</p> <ul style="list-style-type: none"> • DO NOT TRY TO LIGHT ANY APPLIANCE. • DO NOT TOUCH ANY ELECTRIC SWITCH DO NOT USE ANY PHONE IN YOUR BUILDING. • IMMEDIATELY CALL YOUR GAS SUPPLIER FROM A NEIGHBOR'S PHONE. FOLLOW THE GAS SUPPLIER'S INSTRUCTIONS. • IF YOU CANNOT REACH YOUR GAS SUPPLIER, | <p>C. CALL THE FIRE DEPARTMENT.</p> <p>USE ONLY YOUR HAND TO PUSH IN OR TURN THE GAS CONTROL KNOB . NEVER USE TOOLS. IF THE KNOB WILL NOT PUSH IN OR TURN BY HAND, DON'T TRY TO REPAIR IT. CALL A QUALIFIED SERVICE TECHNICIAN. FORCE OR ATTEMPTED REPAIR MAY RESULT IN A FIRE OR EXPLOSION.</p> <p>D. DO NOT USE THIS APPLIANCE IF ANY PART HAS BEEN UNDER WATER. IMMEDIATELY CALL A QUALIFIED SERVICE TECHNICIAN TO INSPECT THE APPLIANCE AND TO REPLACE ANY PART OF THE CONTROL SYSTEM AND ANY GAS CONTROL WHICH HAS BEEN UNDER WATER.</p> <p>E. DO NOT OPERATE APPLIANCE UNLESS UNIT IS FILLED WITH WATER AND INLET LINES AFTER FULLY OPEN.</p> |
|---------------------------------------------------------------------------------------------------------------------------------------------------------------------------------------------------------------------------------------------------------------------------------------------------------------------------------------------------------------------------------------------------------------------------------------------------------------------------------------------------------------------------------------------------------------------------------------------------------------------------------------------------------------------------------------------------------------|-----------------------------------------------------------------------------------------------------------------------------------------------------------------------------------------------------------------------------------------------------------------------------------------------------------------------------------------------------------------------------------------------------------------------------------------------------------------------------------------------------------------------------------------------------------------------------------------------------------------------------------------------------|

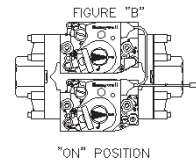
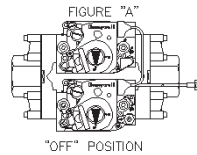
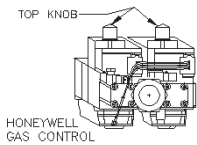

OPERATING

1. STOP! READ THE SAFETY INFORMATION ON THIS LABEL.
2. TURN "OFF" ALL ELECTRICAL POWER TO THE APPLIANCE. THE FLUE DAMPER WILL AUTOMATICALLY SPRING TO "OPEN" POSITION
3. THIS APPLIANCE IS EQUIPPED WITH AN IGNITION DEVICE WHICH AUTOMATICALLY LIGHTS THE PILOT. DO NOT TRY TO LIGHT THE PILOT BY HAND.
4. REFER TO THE DIAGRAMS ABOVE. TURN TOP KNOB OF THE GAS CONTROL VALVE CLOCKWISE TO "OFF" POSITION (FIG. A).
5. REMOVE THERMOSTAT CONTROL COVER. ROTATE THERMOSTAT DIAL-BY HAND-COUNTERCLOCKWISE TO LOWEST SETTING. DO NOT FORCE DIAL OR MECHANICAL STOP.
6. WAIT FIVE (5) MINUTES TO CLEAR OUT ANY GAS . IF YOU THEN SMELL GAS:

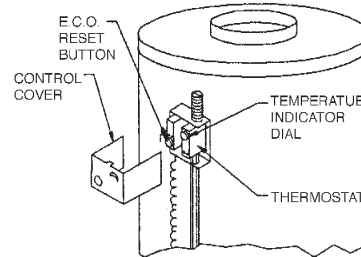

STOP! FOLLOW "B" IN THE SAFETY INFORMATION ABOVE IN THIS LABEL. IF YOU DON'T SMELL GAS. GO TO NEXT STEP.

7. TURN GAS CONTROL TOP KNOB COUNTERCLOCKWISE TO "ON" POSITION, DO NOT FORCE KNOB.
8. TURN ON ALL ELECTRICAL POWER TO THE APPLIANCE.
9. ROTATE APPLIANCE THERMOSTAT DIAL BY HAND DESIRED SETTING. DO NOT FORCE. FLUE DAMPER WILL "OPEN" AND PILOT IGNITION WILL OCCUR. WHEN PILOT IGNITION IS SENSED, THE MAIN BURNER(S) WILL IGNITE.
10. REPLACE THERMOSTAT CONTROL COVER.
11. IF THE APPLIANCE WILL NOT OPERATE. FOLLOW THE INSTRUCTIONS "TO TURN OFF GAS TO APPLIANCE" AND CALL YOUR SERVICE TECHNICIAN OR GAS SUPPLIER.

TO TURN OFF GAS TO APPLIANCE

1. ROTATE THERMOSTAT DIAL -BY HAND- COUNTERCLOCKWISE TO LOWEST SETTING. SEE STEP 5 ABOVE.
2. TURN OFF ALL ELECTRICAL POWER TO THE APPLIANCE IF SERVICE IS TO BE PERFORMED.
3. REMOVE CONTROL ACCESS PANEL.
4. TURN KNOB OF GAS CONTROL VALVE CLOCKWISE TO "OFF" POSITION. SEE STEP 4 ABOVE AND DIAGRAM.
5. REPLACE CONTROL ACCESS COVERS (SEE STEP 10 ABOVE).

ADJUSTMENTS

ON INITIAL STARTUP SOME ADJUSTMENTS ARE NECESSARY.

1. CHECK MANIFOLD AND INLET GAS PRESSURES.
2. TO ADJUST PILOT FLAME - FOLLOW "PILOT BURNER" PROCEDURE UNDER "PREVENTIVE MAINTENANCE".

WATER TEMPERATURE CONTROL

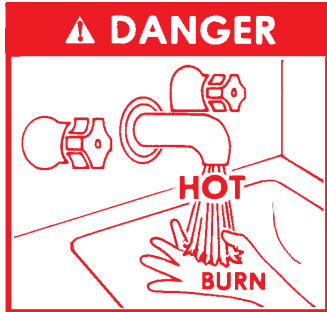

WARNING

THIS WATER HEATER IS EQUIPPED WITH AN ADJUSTABLE THERMOSTAT TO CONTROL WATER TEMPERATURE. HOT WATER TEMPERATURES REQUIRED FOR AUTOMATIC DISHWASHER AND LAUNDRY USE CAN CAUSE SCALD BURNS RESULTING IN SERIOUS PERSONAL INJURY AND/OR DEATH. THE TEMPERATURE AT WHICH INJURY OCCURS VARIES WITH THE PERSON'S AGE AND TIME OF EXPOSURE. THE SLOWER RESPONSE TIME OF CHILDREN, AGED OR HANDICAPPED PERSONS INCREASES THE HAZARDS TO THEM. NEVER ALLOW SMALL CHILDREN TO USE A HOT WATER TAP, OR DRAW THEIR OWN BATH WATER. NEVER LEAVE A CHILD OR DISABLED PERSON UNATTENDED IN A BATHTUB OR SHOWER.

THE WATER HEATER SHOULD BE LOCATED IN AN AREA WHERE THE GENERAL PUBLIC DOES NOT HAVE ACCESS TO SET TEMPERATURES.

SETTING THE WATER HEATER TEMPERATURE AT 120°F WILL REDUCE THE RISK OF SCALDS. Some states or provinces require settings at specific lower temperatures.

Below you will find listed the approximate time-of-burn relationship for normal adult skin. Short repeated heating cycles caused by small hot water uses can cause temperatures at the point of use to exceed the thermostat setting by up to 20°F (11°C).

If you experience this type of use, you should consider using lower temperature settings to reduce scald hazards.

Temperature Settings	Time to Produce 2nd & 3rd Degree Burns on Adult Skin
180°F (82°C)	Nearly Instantaneous
170°F (77°C)	Nearly Instantaneous
160°F (71°C)	About 1/2 Second
150°F (65°C)	About 1 - 1/2 Seconds
140°F (60°C)	Less than 5 Seconds
130°F (54°C)	About 30 Seconds
120°F (49°C)	More than 5 Minutes

Valves for reducing point-of-use temperature by mixing cold and hot water are available. Also available are inexpensive devices that attach to faucets to limit hot water temperatures. Contact a licensed plumber or the local plumbing authority.

The water temperature is controlled by a thermostat, Fig. 3, which has two sensing elements. One sensor is located near the top of the tank and the other is near the center. The thermostat is set in the lowest position before the heater leaves the factory.

The thermostat temperature dial, Fig. 3, is accessible by removing the control cover. The dial is adjustable and may be set for 120°F (49°C) to 180°F (82°C) water temperature, but 120°F (49°C) is the recommended starting point. It is suggested the dial be placed on the lowest setting which produces an acceptable hot water supply. This will always give the most energy efficient operation. The temperature control has a 4°F fixed differential.

TESTING DAMPER OPERATION

With the Service Switch in the AUTOMATIC OPERATION position, check the operation of the flue damper three (3) times with the water operating controls for proper operating sequence:

- The damper disc must be open (in the vertical position) before the ignition and combustion process begins.
- The damper disc must be in the open position when the main burner is firing.
- The gas valve must close and the main burner must have ceased firing before the damper disc begins its return to the closed (horizontal) position.

If during testing of the operation of the damper you find that there is a problem with the operation of the water heater when the Service Switch is in the AUTOMATIC OPERATION position: Reset the Service Switch to the HOLD OPEN DAMPER position and check operation again.

If the water heater does operate when placed in the HOLD OPEN DAMPER position:

- Refer to the EFFIKAL RVGP-FSF-SERIES TROUBLESHOOTING GUIDE at the end of this manual.

CAUTION

Do not force the damper disc manually or motor damage will occur.

If the water heater does not operate with the Service Switch in either position:

- Refer to the Troubleshooting Sections and Operational Checklist sections.

CHECKING VENTING

The following steps shall be followed with each appliance connected to the venting system placed in operation, while any other appliances connected to the venting system are in operation.

1. Seal any unused openings in the venting system.
2. Inspect the venting system for proper size and horizontal pitch, as required in the National Fuel Gas Code, ANSI Z223.1 or the CAN/CGA B149 Installation codes and these instructions. Determine that there is no blockage or restriction, leakage, corrosion and other deficiencies which could cause an unsafe condition.
3. So far as is practical, close all building doors and windows and all doors between the space in which the water heater(s) connected to the venting system are located and other spaces of the building. Turn on all appliances not connected to the venting system. Turn on all exhaust fans, such as range hoods and bathroom exhausts, so they shall operate at maximum speed. Close fireplace dampers.
4. Follow the lighting instruction. Place the water heater being inspected in operation. Adjust thermostat so appliance shall operate continuously.
5. Test for draft hood spillage at the relief opening after 5 minutes of main burner operation.
6. After it has been determined that each appliance connected to the venting system properly vents when tested as outlined above, return doors, windows, exhaust fans, fireplace dampers and any other gas burning appliance to their previous conditions of use.
7. If improper venting is observed during any of the above tests, the venting system must be corrected.

⚠ WARNING

FAILURE TO CORRECT BACK DRAFTS MAY CAUSE AIR CONTAMINATION AND UNSAFE CONDITIONS.

- If the back draft cannot be corrected by the normal method or if a suitable draft cannot be obtained, a blower type flue gas exhauster must be employed to assure proper venting and correct combustion.

PREVENTIVE MAINTENANCE

CHECK THE PILOT

At least once a year, check the pilot burner, fig. 15, and the main burner, fig. 16, for proper operation. Refer to the following pilot and main burner sections.

PILOT BURNER

For access to pilot, unfasten two screws to burner cover and remove. Locate the burner with pilot and remove screw holding burner to manifold. Unfasten pilot tubing from valve and slide out burner and pilot.

Servicing of the pilot burner includes keeping pilot free of lint, cleaning the burner head, the primary air opening and the orifice of the pilot burner.

Pilot burner flame is affected by:

1. Low gas pressure.
 - Adjust pilot flame by means of the pilot gas adjustment located on the gas valve. See fig. 17.

- The pilot flame should envelop sensing device with 5/8" (1.6cm) flame, fig. 15. Remove pilot adjustment cover screw, fig. 16. Turn inner adjustment screw clockwise to decrease, or counterclockwise to increase pilot flame. Be sure to replace cover screw on gas valve after adjustment to prevent possible gas leakage.
2. Clogged pilot burner orifice.
 - Clean or replace orifice. A clogged orifice will restrict gas flow.
 3. Incorrect orifice.
 - Replace. See Table 7, for correct orifice for type of gas used. Orifice size is stamped on the wrench flats.

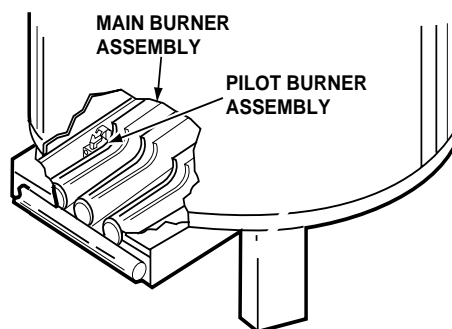

FIGURE 14

Pilot sensing device must sense a flame before sparking will stop. Loose wires or a draft may cause intermittent or abnormal sparking. To eliminate this condition, first correct loose wiring condition, and then, if necessary, increase pilot flame.

PILOT BURNER ASSEMBLY

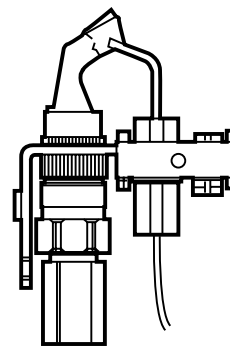

FIGURE 15

MAIN BURNER

The main burner, fig. 15, should display the following characteristics:

- Cause rapid ignition and carry over of flame across entire burner.
- Give reasonably quiet operation during ignition, burning and extinction.
- Cause no excessive lifting of flame from burner ports.

TYPICAL PILOT AND MAIN BURNER FLAMES

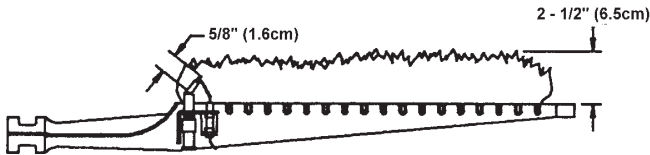

FIGURE 16

If the preceding burner characteristics are not evident, check for accumulation of lint or other foreign material that restricts or blocks the air openings to the burner or heater.

NOTE: Cleaning of main burners.

1. Remove main burners from unit.
2. Check that burner venturi and ports are free of foreign matter.
3. Clean burners with bristle brush and/or vacuum cleaner — DO NOT distort burner ports or pilot location.
4. Reinstall burners in unit. Make sure front and rear of burners are installed correctly in burner support brackets.

Also check for good flow of combustion and ventilating air to the unit. Maintain a clear area around the heater at all times.

GAS VALVES

Figure 16 shows the two types of combination gas control valves used on these heaters.

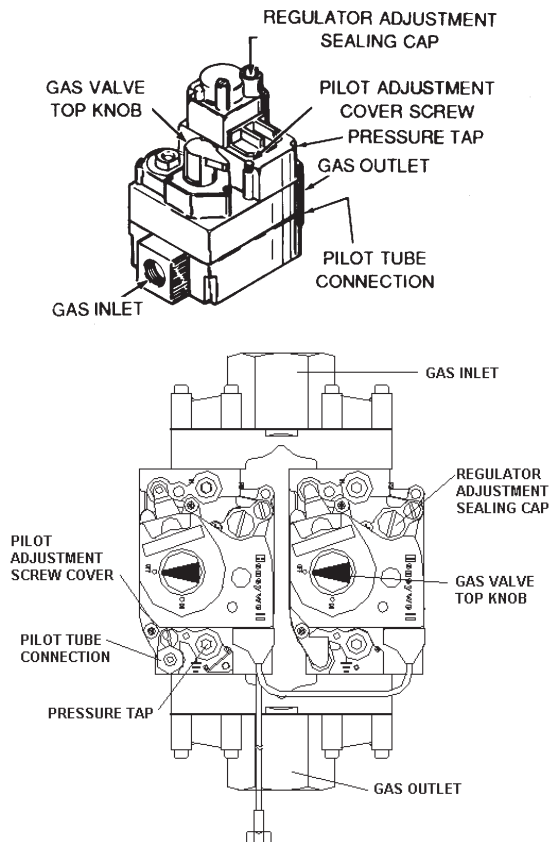

FIGURE 16

If the gas valve becomes defective, repairs should not be attempted. A new valve should be installed in place of the defective one.

CHECKING THE INPUT

For appliance installation locations with elevations above 2000 feet (610 m), refer to HIGH ALTITUDE INSTALLATIONS section of this manual for input reduction procedure.

1. Attach a pressure gauge or a manometer to the gauge port and refer to Table 5, for correct manifold pressure.
2. Use this formula to “clock” the meter. Be sure that other gas consuming appliances are not operating during this interval.

$$3600 \times H = \text{Btuh}$$

T

T = Time in seconds to burn one cubic foot of gas.

H = Btu's per cubic foot of gas.

Btuh = Actual heater input.

Example: (Using SBD-240 heater)

T = 15.8 seconds

H = 1050 Btu

Btuh = ?

$36.8 \times 1050 = 240,000 \text{ Btuh (70.3 kWh)}$ (Compare with 15.9 heater model and rating)

Should it be necessary to adjust the gas pressure to the burners to obtain the full input rate, the steps below should be followed:

3. Remove the regulator adjustment sealing cap, fig. 17, and adjust the pressure by turning the adjusting screw with a screwdriver.

 Clockwise to increase gas pressure and input rate.

 Counterclockwise to decrease gas pressure and input rate.

4. “Clock” the meter as in step 2 above.
5. Repeat steps 3 and 4 until the specified input rate is achieved.
6. Turn the gas control knob to PILOT. Remove the pressure gauge and replace the sealing cap and the allen wrench set screw in the pressure tap opening.

WARNING

UNDER NO CIRCUMSTANCES SHOULD THE GAS INPUT EXCEED THE INPUT SHOWN ON THE HEATER MODEL AND RATING PLATE. OVERFIRING COULD RESULT IN DAMAGE OR SOOTING OF THE HEATER.

When the heater is operating at full capacity, or full gas input, it should consume 1 cu. ft. of gas in time indicated on Table 6.

VENTING SYSTEM

Examine the venting system every six months for obstructions and/or deterioration of the vent piping.

Remove all soot or other obstructions from chimney which will retard free draft.

REMOTE STORAGE TANK TEMPERATURE CONTROL

The water temperature in the storage tank (if used) is controlled by the storage tank temperature control. The sensing element is mounted in the hot water storage tank, see page 17.

A change in water temperature in the storage tank lower than the tank temperature control setting will cause the sensor to activate the circulating pump. The pump then circulates the water through the heater where the thermostat senses the drop in water temperature and activates main burner operation of the appliance. If the storage tank temperature control is out of calibration, replace with new control.



WARNING

SHOULD OVERHEATING OCCUR OR THE GAS SUPPLY FAIL TO SHUT OFF, TURN OFF THE MANUAL GAS CONTROL VALVE TO THE APPLIANCE.

RELIEF VALVE

At least once a year, the temperature and pressure relief valve should be checked to ensure that it is in operating condition. Lift the lever at the top of the valve several times until the valve seats properly and operates freely.

If the appliance installation includes other relief valves, such as in "remote" storage tanks etc., check their relief valve operation with the same frequency.



WARNING

THE WATER PASSING OUT OF THE VALVE DURING THIS CHECKING OPERATION MAY BE EXTREMELY HOT. AVOID CONTACT AND DISCHARGE SAFELY TO PREVENT WATER DAMAGE.

If the temperature and pressure relief valve on the heater discharges periodically or continuously, a problem exists. This may be due to unusually high water temperatures or pressures in the system, or to a faulty relief valve. Contact your dealer or a qualified service technician to find the cause of the problem and to correct it. This may also be due to thermal expansion in a closed water supply system. Contact the water supplier or local plumbing inspector on how to correct this situation. **DO NOT PLUG THE TEMPERATURE AND PRESSURE RELIEF VALVE.**



WARNING

SHOULD OVERHEATING OCCUR OR THE GAS SUPPLY FAIL TO SHUT OFF, TURN OFF THE MANUAL GAS CONTROL VALVE TO THE APPLIANCE.

HOT WATER ODOR

On occasion, hot water may develop a strong odor. If this occurs drain the heater completely, flush thoroughly, and refill. If the problem persists, chlorination of the heater and replacement of

the factory installed magnesium anodes with aluminum anodes may correct the condition.

Occasionally water softener companies recommend removal of heater anodes for odor reasons.



CAUTION

Unauthorized removal of the anode(s) will void the warranty. For further information contact your dealer.

ANODE ROD INSPECTION

The heater tank is equipped with anode rods to provide corrosion control. At least once a year the anode rods should be checked to determine if replacement is necessary. Initially the anode rods are approximately 7/8" (22mm) in diameter with a 1/8" (3mm) diameter steel core wire running down the center of the anode material. THE ANODES SHOULD BE REPLACED when the 1/8" (3mm) diameter core wire is visible as this means that the anode material has been expended in the control of corrosion.

For models with top inlet and outlet, it is recommended that, before removing the inner cover for cleaning, inspection or removal of inner parts, you obtain two new nipple collars, part no. 74060. The nipple collars on the heater will usually be damaged when removed. New pipe collars will insure that the seal is such as to prevent leakage of flue products when properly installed.

NOTE: Anode rod inspection may need to be made more frequently in areas subject to acid rain that obtains their water supply from surface water as the low pH will accelerate anode activity.

CAUTION: Close cold water inlet valve serving heater and open nearby hot water faucet to relieve the pressure in the heater before attempting to remove anode(s) for inspection.

RECOMMENDED PROCEDURE FOR PERIODIC REMOVAL OF LIME DEPOSITS FROM TANK TYPE COMMERCIAL WATER HEATERS

The amount of calcium carbonate (lime) released from water is in direct proportion to water temperature and usage, see chart. The higher the water temperature or water usage, the more lime deposits are dropped out of the water. This is the lime scale which forms in pipes, heaters and on cooking utensils.

Lime accumulation not only reduces the life of the equipment but also reduces efficiency of the heater and increases fuel consumption.

The usage of water softening equipment greatly reduces the hardness of the water. However, this equipment does not always remove all of the hardness (lime). For this reason it is recommended that a regular schedule for deliming be maintained.

The time between cleaning will vary from weeks to months depending upon water conditions and usage.

Refer to State booklet, Form No. 4800, entitled "Why? When and How" for detailed description on tank inspection and cleanout.

UN•LIME® and the booklet may be obtained through your State dealer or distributor.

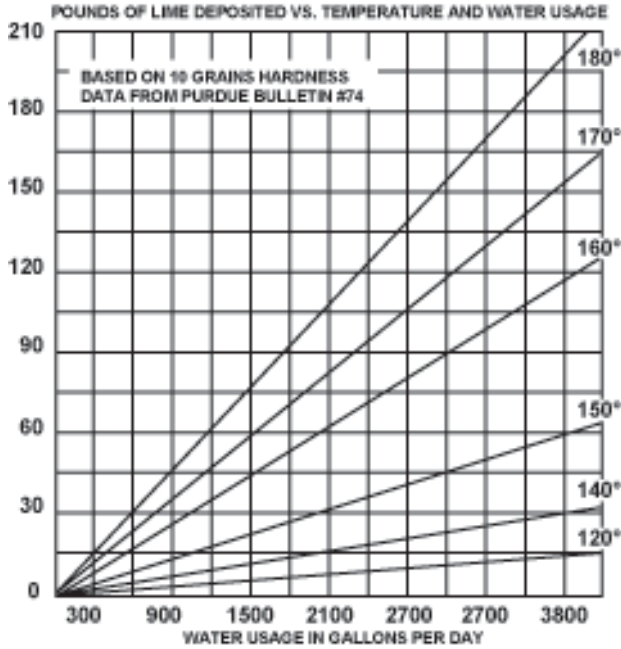

FIGURE 18

DELIMING SOLVENTS

State recommends the use of UN•LIME for deliming. UN•LIME is a patented food grade acid which is safe to handle and does not create the harmful fumes which are associated with other products.

UN•LIME may be obtained from your dealer, distributor or State Water Heaters. Order part no. 4763 (1 gal), packed 4 gallons per case or part no. 4813 (5 gallon container).

Hydrochloric base acids are not recommended for use on glass-lined tanks.



Observe handling instructions on label of product being used.

TANK CLEANOUT PROCEDURE

The following practices will ensure longer life and enable the unit to operate at its designed efficiency:

1. Once a month the heater should be flushed. Open the drain valve and allow two gallons of water to drain from the heater. Inlet water valve should remain open to maintain pressure in tank.
2. A cleanout opening is provided for periodic cleaning of the tank. Gas must be shut off and heater drained before opening cleanout.

To clean heater through cleanout opening, proceed as follows:

1. Drain heater.
2. Remove outer cover plate from lower side of heater jacket.

3. Remove six (6) hex head screws securing tank cleanout plate and remove plate.
4. Remove lime, scale, or sediment using care not to damage the glass lining.
5. Inspect cleanout plate gasket, if new gasket is required, replace with State part no. 99038.
6. Install cleanout plate. Be sure to draw plate up tight by tightening screws securely.
7. Replace outer jacket cover plate.

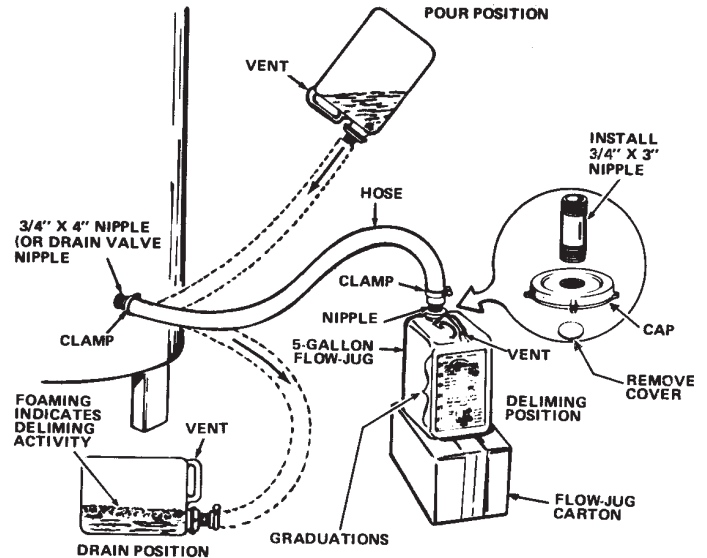

FIGURE 18

In some water areas the sediment might not be removed by this method and may result in the water heater making rumbling or boiling noises. To dissolve and remove these more stubborn mineral deposits, State UN•LIME Professional Delimer should be used.

DELIMING USING FLO-JUG METHOD

UN•LIME in the 5 gallon size is recommended for deliming of the SBD 120-500 models. UN•LIME with the necessary hoses and fittings to delime your heater is also available as a kit: Up-N-Down Transfer Kit. Contact your local State dealer or distributor:

Telephone: (800) 433-2545
 Fax: (800) 433-2515
 Website: www.hotwater.com

Prepare the Water Heater

To delime the water heater using the Flo-Jug method, first prepare the heater for deliming as described in the "Why? When? and How?" booklet, Form No. 4800. Then install the long plastic male adapter fitting into the drain valve opening of the water heater. Use teflon tape and hand tighten only. Do not overtighten.

Prepare the Up-N-Down Transfer Kit

The next step is the preparation on the Up-N-Down Transfer Kit, if you have not already done so:

1. With the 5 gallon Up-N-Down container in the vertical position, unscrew the plastic vent cap in the handle and pierce the plastic membrane over the vent boss under the cap to allow the container to vent.

Note: If your container does not have the vent cap and vent boss, drill a 3/16" hole in the handle. When you have finished deliming you will be able to plug this drilled vent with the stainless steel screw that is supplied with the kit.

2. Remove the container's cap and cut the plastic membrane located in the 3/4" IPT opening in the cap. Take care to not damage the threads.
3. Find the 3/4" male adapter, apply teflon tape to the threaded end and screw it into the 3/4" IPT opening in the cap.
4. Put cap with male adapter back on the container and slide 3/4" hose over end of male adapter and fasten in place using hose clamp provided.

Delime using Flo-Jug Method

5. Slide the hose clamp over end of hose and slide hose over the male adapter in the water heater drain opening and secure in place using hose clamp.
6. Lift container to the "Pour" Position, see Figure 9, being careful to keep the vent in the handle above the liquid level and pour the UN•LIME into the heater.
7. Lower container, you may have to place the container on its empty carton to prevent the UN•LIME from flowing back into the container.
8. Let UN•LIME remain in the heater for 5 minutes and then lower the container to the "Drain" Position, see Figure 9.
9. Deliming activity is indicated by foaming on the surface of the UN•LIME. If there is deliming activity, repeat steps 6 thru 8.

Normally, lime removal will be completed within one hour. Severe build-up of lime may take longer than an hour to complete descaling.

Note: To check UN•LIME for continued use, place some scale or white chalk in a glass with a small amount of UN•LIME. If the material is vigorously dissolved by the UN•LIME, it can be reused; if not, the UN•LIME should be replaced.

TROUBLESHOOTING IGNITION MODULE SYSTEM

Before calling your service agent, the following checklist should be examined to eliminate obvious problems from those requiring replacement or servicing.

- Check that "main manual gas shutoff valve" is fully open and that gas service has not been interrupted.
- Check that after following the appliance OPERATING INSTRUCTIONS, the "Top Knob" of the appliance gas valve is in "ON" position.
- Check electrical supply to the appliance for possible blown (or tripped) fusing or power interruption.
- Is the water temperature in tank below the thermostat dial setting on the appliance thermostat (calling for heat)?
- It is possible that the high limit (E.C.O.) has functioned to shut off the appliance. See FEATURES — Water Temperature Control for reset procedure. Contact your serviceman if limit continues to function to shut off appliance.

SERVICE

The installer may be able to observe and correct certain problems which may arise when the unit is put into operation. HOWEVER, it is recommended that only qualified servicemen, using appropriate test equipment, be allowed to service the heater.

As preliminary step, check wiring against diagram, check for grounded, broken or loose wires. Check all wire ends to be sure that they are making good contact.

ELECTRICAL SERVICING



LABEL ALL WIRES PRIOR TO DISCONNECTION WHEN SERVICING CONTROLS. WIRING ERRORS CAN CAUSE IMPROPER AND DANGEROUS OPERATION.

VERIFY PROPER OPERATION AFTER SERVICING.

REPLACEMENT PARTS

Replacement parts may be ordered through State dealers, authorized servicers or distributors. Refer to the Yellow Pages for where to call or contact the State Water Heaters. When ordering parts be sure to state the quantity, part number and description of the item(s) including the complete model and serial number as it appears on the product. Refer to the part's list for more information.

EFFIKAL RVGP-KSF-SERIES FLUE DAMPER TROUBLE SHOOTING GUIDE

Do not turn damper open manually or motor damage will result, use the service switch.
 All readings are taken from harness receptacle. Do not push meter leads into harness receptacle.
 This opens the pins and will create connection problems.

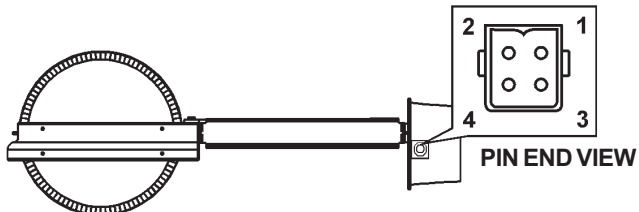

NOTE: DAMPER DISC SHOWN IN OPEN POSITION.

Effikal Pinouts & wire colors	Function	Adapter wire colors in*
1. Brown	24 VAC HOT	Black
2. Orange	Signal In	Yellow
3. Yellow	Signal Out	Red
4. Black	24 VAC Common	White

*See Connection Diagram, Figure 14.

24 V.A.C.	NORMAL SEQUENCE OF OPERATION	
A. FLUE DAMPER OPEN OR OPENING (Unit is calling for heat and damper disc should be in vertical position) VOLTAGE ACROSS:		
4 & 1	All Times that High Limit is closed	
4 & 2	Calling for Heat	Open or Opening
4 & 3	During Combustion	Damper Open
B. FLUE DAMPER CLOSED (Unit is not calling for heat and damper disc should be in horizontal position) NOTE: POSITION 4 IS COMMON AND POSITION 3 IS HOT 24VAC VOLTAGE ACROSS:		
4 & 1	All Times that High Limit is closed	
NO VOLTAGE ACROSS:		
4 & 3 or 4 & 2	1. Thermostat not calling for heat.	

⚠ WARNING
 Do not negate the action of any existing safety or operational controls.

ABNORMAL OPERATION	
A. NOTHING WORKING NO VOLTAGE ACROSS:	
4 & 1	1. High Limit has tripped and is OPEN. Determine reason for tripping of high limit 2. Bad Transformer 3. Loose or broken connections 4. Blown fuse or circuit breaker 5. Disconnect switch off 6. Harness not plugged into appliance receptacle
B. DAMPER HAS OPENED, NO COMBUSTION VOLTAGE ACROSS:	
4 & 1; 4 & 2; 4 & 3:	1. Check for power at ignition module terminals. If 24VAC power is present damper is working properly. 2. Defective component in appliance after the flue damper. 3. If 24 VAC is not present at the ignition module, look for loose or broken connections between damper and ignition module. 4. If the connections from damper to ignition module seem proper, replace damper assembly. If a damper assembly is not available, place the service switch in the hold open position. This should keep the damper in the open position and allow the customer to have automatic heat, until a replacement damper can be installed.
C. DAMPER ROTATES CONTINUOUSLY	
	Change the entire damper assembly.
D. DAMPER STICKS	
	1. Make sure no screws obstruct the damper blade. 2. Make sure damper pipe assembly is not egg shaped. 3. Make sure damper rod is not rubbing on pipe assembly.

IMPORTANT: DAMPER MUST BE OPEN BEFORE COMBUSTION TAKES PLACE. If all steps have been tried and damper problems persists call State Technical Center at 1-800-821-2017.

OPERATIONAL CHECKLIST

This checklist in conjunction with "TROUBLESHOOTING" and the "SEQUENCE OF OPERATION" should be used as an on-the-job troubleshooting guide to identify the cause of incorrect system operation and suggest a remedy for its correction. Because improper piping and wiring can result in unsatisfactory system performance, it is suggested that the installation be examined before using the checklist. Be sure to refer to the correct piping and wiring diagram for the type of system that is installed.

COMPLAINT	CAUSE	REMEDY	
		USER	SERVICEMAN
*Water not hot enough.	Thermostat set too low.	Set thermostat dial to a higher temperature.	
	Thermostat out of calibration.	Call serviceman.	Recalibrate thermostat. If thermostat cannot be recalibrated, replace.
*Insufficient hot water *See WATER TEMPERATURE WARNING (on page 27)	Thermostat set too low.	Set thermostat dial to a higher temperature.	
	Thermostat out of calibration.	Call serviceman.	Recalibrate thermostat. If thermostat cannot be recalibrated, replace.
	Main manual gas shutoff valve partially closed.	Open main manual gas shutoff valve to fullest extent.	
	Heater too small for demand.	Space usage to give heater time to restore water temperature.	
	Thermostat differential is too wide.	Call serviceman.	Replace dual bulb controller if differential is greater than 4°F.
	Heater recovery is slower.	Call serviceman.	Check gas input. If incorrect, adjust gas pressure or replace main burner orifice.
	Draft hood not installed or one or more flue baffles.	Call serviceman.	Install draft hood or baffles as furnished with unit.
Water temperature too hot.	Thermostat set too high.	Set thermostat to a lower setting.	
Heater makes sounds: sizzling.	Condensation on outside of tank - normal.		
Rumbling.	Sediment accumulation on bottom of tank.	Drain a quantity of water through drain valve. If rumbling persists, call a serviceman.	Delime heater.
Ticking or metallic sounds.	Expansion and contraction-normal.		
Pounding.	Air chambers in piping have become waterlogged.	Drain piping system and refill. Heater must be off while this is being done.	
Combustion noises.	Too much primary air.	Adjust shutters.	
	Overfired heater. Incorrect burners or orifice for types of gas used.	Call serviceman.	Check and correct as necessary.
Water leaks.	Drain valve not closed tightly.	If drain valve cannot be closed tightly, replace.	
	If leakage source cannot be corrected or identified, call serviceman.	Shut off gas supply to heater and close cold water inlet valve to heater.	Repair or in case of suspected tank leakage, be certain to confirm before replacing heater.
Gas odors.	Heater is overfired.	Shut off gas supply to heater and call serviceman.	Check for sooted flue passage.
			Check for obstructed vent line.
			Check backdraft or lack of draft.
			Draft hood may be improperly installed or not sized properly.
	Possible gas leaks.	Shut off gas supply to heater and call gas company at once.	



500 Lindahl Parkway, Ashland City, TN 37015
Phone: 800-821-2017 Fax: 800-644-9306
www.stateind.com

Free Manuals Download Website

<http://myh66.com>

<http://usermanuals.us>

<http://www.somanuals.com>

<http://www.4manuals.cc>

<http://www.manual-lib.com>

<http://www.404manual.com>

<http://www.luxmanual.com>

<http://aubethermostatmanual.com>

Golf course search by state

<http://golfingnear.com>

Email search by domain

<http://emailbydomain.com>

Auto manuals search

<http://auto.somanuals.com>

TV manuals search

<http://tv.somanuals.com>