

# MODELS SBN71120NE THRU SBN85390NE/A Series 108

## COMMERCIAL GAS, GLASS-LINED, TANK-TYPE WATER HEATER

- INSTALLATION • OPERATION • MAINTENANCE • LIMITED WARRANTY



Thank you for buying this energy efficient water heater from State Water Heaters. We appreciate your confidence in our products.

**WARNING:** If the information in these instructions is not followed exactly, a fire or explosion may result causing property damage, personal injury or death.

- Do not store or use gasoline or other flammable vapors and liquids in the vicinity of this or any other appliance.
- WHAT TO DO IF YOU SMELL GAS
  - Do not try to light any appliance.
  - Do not touch any electrical switch; do not use any phone in your building.
  - Immediately call your gas supplier from a neighbor's phone. Follow the gas supplier's instructions.
  - If you cannot reach your gas supplier, call the fire department.
- Installation and service must be performed by a qualified installer, service agency or the gas supplier.



### CAUTION

TEXT PRINTED OR OUTLINED IN RED CONTAINS INFORMATION RELATIVE TO YOUR SAFETY. PLEASE READ THOROUGHLY BEFORE INSTALLING AND USING THIS APPLIANCE.



500 LINDAHL PARKWAY  
ASHLAND CITY, TN 37015  
www.stateind.com

PLACE THESE INSTRUCTIONS ADJACENT TO HEATER  
AND NOTIFY OWNER TO KEEP FOR FUTURE REFERENCE.

# ROUGH-IN-DIMENSIONS

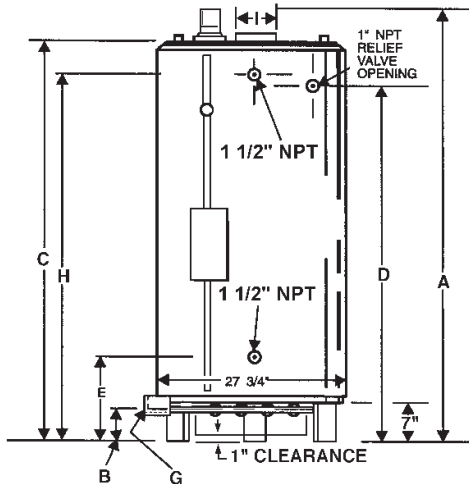

FRONT VIEW

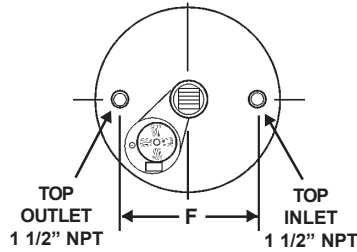

TOP VIEW

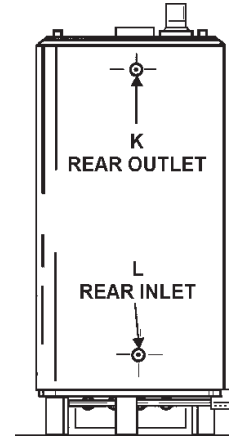

BACK VIEW

TABLE 1. ROUGH-IN-DIMENSIONS

Model Dim.	SBN71120NE		SBN81154NE		SBN100180NE		SBN100199NE		SBN100250NE		SBN100275NE		SBN85310NE		SBN85366NE		SBN85390NE	
	Inches	mm	Inches	mm	Inches	mm	Inches	mm	Inches	mm	Inches	mm	Inches	mm	Inches	mm	Inches	mm
A	63	1800	68	1727	72	1829	72	1829	72	1829	72	1829	73	1854	73	1854	73	1854
B	4 1/4	108	4 1/2	114	4 1/2	114	4 1/2	114	4 1/2	114	4 1/2	114	4 1/2	114	4 1/2	114	4 1/2	114
C	59 1/2	1511	62	1575	70	1778	70	1778	70	1778	70	1778	72	1829	72	1829	72	1829
D	50 7/8	1292	52 5/8	1362	61 5/8	1565	61 5/8	1565	61 5/8	1565	61 5/8	1565	62 1/2	1588	62 1/2	1588	62 1/2	1588
E	19 11/16	500	20 1/2	521	20 1/2	521	20 1/2	521	20 1/2	521	20 1/2	521	20 1/2	521	22 1/2	572	22 1/2	572
F	19	483	21	533	21	533	21	533	21	533	21	533	21	533	21	533	21	533
G (gas inlet)	1/2NPT		1/2NPT		1/2NPT		1/2NPT		1/2NPT		1/2NPT		1/2NPT		1/2NPT		1/2NPT	
H	51 7/8	1318	54 5/8	1387	61	1549	61	1549	61	1549	61	1549	63	1600	63	1600	63	1600
I (vent dia)	5	127	6	152	6	152	6	152	6	152	6	152	6	152	6	152	6	152
J	27 3/4	705	27 3/4	705	27 3/4	705	27 3/4	705	27 3/4	705	27 3/4	705	27 3/4	705	27 3/4	705	27 3/4	705
K	1 1/2NPT		1 1/2NPT		1 1/2NPT		1 1/2NPT		2NPT		2NPT		2NPT		1 1/2NPT		1 1/2NPT	
L	1 1/2NPT		1 1/2NPT		1 1/2NPT		1 1/2NPT		2NPT		2NPT		2NPT		2NPT		1 1/2NPT	
Approx. Shipping Weight STD.	400 lbs.	181 K.g	470 lbs.	213 K.g	603 lbs.	274 K.g	603 lbs.	274 K.g	603 lbs.	274 K.g	603 lbs.	274 K.g	725 lbs.	329 K.g	725 lbs.	329 K.g	725 lbs.	329 K.g
Approx. Shipping Weight ASME	-	-	-	-	-	-	686 lbs.	311 Kg.	686 lbs.	311 Kg.	686 lbs.	211 Kg.	833 lbs.	378 Kg.	833 lbs.	378 Kg.	833 lbs.	378 Kg.

TABLE 2. RECOVERY CAPACITIES, based on 80% efficiency

Model	Btuh	kW	TANK CAPACITY		APPROX EFF. %	U.S. Gallons/Hr. and Litres/Hr at TEMPERATURE RISE INDICATED																
			U.S. Gal.	Litres		F°																
						36F°	40F°	50F°	54F°	60F°	70F°	72F°	80F°	90F°	100F°	108F°	110F°	120F°	126F°	13F°	140F°	
SBN 71120NE	120,000		71	269	80	GPH	320	288	239	213	192	164	160	144	128	115	107	105	96	91	89	82
SBN 81154NE	154,000		81	307	80	LPH	1210	1089	871	807	726	622	605	545	484	436	403	396	363	346	335	311
SBN 100180NE	180,000		100	379	80	GPH	480	432	345	320	288	247	240	218	192	173	160	157	144	137	133	123
SBN 100199NE	199,000		100	379	80	LPH	1815	1634	1307	1210	1089	934	908	817	726	654	605	594	545	519	503	487
SBN 100250NE	250,000		100	379	80	GPH	530	477	382	353	318	273	265	239	212	191	177	174	159	151	147	136
SBN 100275NE	275,000		100	379	80	LPH	2007	1806	1445	1338	1204	1032	1004	903	803	723	669	657	602	573	556	516
SBN 85310NE	310,000		85	322	80	GPH	866	600	484	440	400	343	333	300	266	240	222	218	200	190	184	171
SBN 85366NE	366,000		85	322	80	LPH	2522	2269	1815	1881	1513	1297	1261	1135	1009	908	841	825	756	720	698	648
SBN 85390NE	390,000		85	322	80	GPH	733	659	528	488	440	377	366	330	293	264	244	240	220	209	203	188
						LPH	2774	2496	1997	1849	1664	1426	1387	1248	1109	999	925	908	832	792	768	713
						GPH	826	743	595	551	496	425	413	372	330	297	275	270	248	236	229	212
						LPH	3127	2814	2251	2084	1876	1808	1563	1407	1251	1126	1042	1023	938	893	866	804
						GPH	975	878	702	650	585	502	488	439	390	351	325	319	293	279	270	251
						LPH	3692	3322	2658	2461	2215	1898	1846	1661	1477	1329	1231	1208	1107	1055	1022	949
						GPH	1039	935	748	693	624	534	520	468	416	374	346	340	312	297	288	267
						LPH	3934	3540	2832	2622	2360	2023	1967	1770	1573	1416	1311	1287	1180	1124	1089	1011

TABLE 3. GAS AND ELECTRICAL CHARACTERISTICS

Model	Manifold Pressure			Volts/Hz	Amperes
	Type of Gas	Inches vs. W.C.	kPa		
SBN71120NE - SBN85390NE	Natural	3.5	0.87	120/60	< 5

# TABLE OF CONTENTS

	Page		Page
ROUGH-IN-DIMENSIONS .....	2	Gas Piping .....	21
FOREWORD .....	3	Purging .....	21
GENERAL SAFETY INFORMATION .....	4	Gas Pressure Regulator .....	21-22
Precautions .....	4	OPERATION .....	22
Grounding Instructions .....	4	General .....	22
Chemical Vapor Corrosion .....	4	Filling .....	22
Improper Combustion .....	4	SEQUENCE OF OPERATION .....	23
Extended non-use Periods .....	4	Lighting and Operation .....	24
Insulation Blankets .....	4	Water Temperature Control .....	25
High Altitude Installation .....	5	Checking Venting .....	25
FEATURES .....	5	PREVENTIVE MAINTENANCE .....	25
Self-Cleaning Hydro Cannon .....	5	Check The Ignitor Assembly .....	25
High Limit Switch .....	5	Ignitor Assembly .....	25-26
Electronic Ignition Control .....	5-6	Main Burner .....	26
Exhaust Inducer (Blower Assy.) .....	6	Gas Valves .....	26
Circulating Pump .....	6	Checking The Input .....	26
Dishwashing Machine Requirement .....	6	Venting System .....	27
INSTALLATION INSTRUCTIONS .....	6	Remote Storage Tank Temperature Control .....	27
Required Ability .....	6	Relief Valve .....	27
Uncrating .....	6	Hot Water Odor .....	27
Locating The Heater .....	6-7	Anode Rod Inspection .....	27
Levelling .....	7	Flushing .....	27
Clearances .....	7	Draining .....	27
Hard Water .....	8	Recommended Procedure For Periodic Removal of Lime Deposits From Tank Type Commercial Water Heaters .....	28
Air Requirements .....	8	Deliming Solvents .....	28
Venting .....	8	Tank Cleanout Procedures .....	28-29
Technical Data Venting .....	9-10	Ignition Module System .....	29
Multiple Heater Manifold .....	11	System Diagnostics .....	29
Water Line Connections .....	11	SERVICE .....	29
Water (Potable) Heating and Space Heating .....	11	Electrical Servicing .....	29
Thermometers (Not Supplied) .....	11	Replacement Parts, Service Handbooks and Training Aids .....	30
Relief Valve .....	11	Sequence of Operation Flow Chart .....	30
INSTALLATION DIAGRAMS-TOP		Operational Checklist .....	31
INLET/OUTLET USAGE .....	12	Limited Warranty .....	Insert
General .....	12		
Code Restrictions .....	12		
INSTALLATION DIAGRAMS .....	13-18		
MANIFOLD KITS .....	19		
Heater Wiring .....	20		

## FOREWORD

These designs comply with ANSI Z21.10.3 as an automatic circulating or automatic storage tank type water heater.

Heaters having an input of 310,000, 366,000, 390,000 Btuh with a recovery rating of 277.3 gph or more also comply with ANSI Z21.10.3 as an automatic instantaneous type heater.

Detailed installation diagrams are found in this manual. These diagrams will serve to provide the installer with a reference for the materials and methods of piping necessary. It is highly essential that all water, gas piping and wiring be installed as shown on the diagrams.

Particular attention should be given to the installation of thermometers at the locations indicated on the diagrams as these are necessary for checking the proper functioning of the heater.

The heater is designed to operate on natural gas only. If you have obtained this heater for use on propane-STOP. Do not

install this water heater. Immediately call your supplier to correct the situation.

These heaters may be installed on combustible floors.

In addition to these instructions, the equipment shall be installed in accordance with those installation regulations in force in the local area where the installation is to be made. These shall be carefully followed in all cases. Authorities having jurisdiction should be consulted before installations are made.

The installation must conform to these instructions and the local code authority having jurisdiction. In the absence of local codes, the installation must comply with the latest editions of the National Fuel Gas Code, ANSI Z223.1/NFPA 54 and the National Electrical Code, NFPA 70, documents are available from the National Fire Protection Association, 1 Batterymarch Park, Quincy, MA 02269.

# GENERAL SAFETY INFORMATION

## PRECAUTIONS

DO NOT USE THIS APPLIANCE IF ANY PART HAS BEEN UNDER WATER. Immediately call a qualified service technician to inspect the appliance and to replace any part of the control system and any gas control which has been under water.

IF THE UNIT IS EXPOSED TO THE FOLLOWING, DO NOT OPERATE HEATER UNTIL ALL CORRECTIVE STEPS HAVE BEEN MADE BY A QUALIFIED SERVICEMAN.

1. EXTERNAL FIRE.
2. DAMAGE.
3. FIRING WITHOUT WATER.
4. SOOTING

## GROUNDING INSTRUCTIONS

This water heater must be grounded in accordance with the National Electric Code and/or local codes. These must be followed in all cases.

This water heater must be connected to a grounded metal, permanent wiring system; or an equipment grounding conductor must be run with the circuit conductors and connected to the equipment grounding terminal or lead on the water heater, see Figure 9.

## CHEMICAL VAPOR CORROSION

### WARNING

CORROSION OF THE FLUEWAYS AND VENT SYSTEM MAY OCCUR IF AIR FOR COMBUSTION CONTAINS CERTAIN CHEMICAL VAPORS. SUCH CORROSION MAY RESULT IN FAILURE AND RISK OF ASPHYXIATION.

Spray can propellants, cleaning solvents, refrigerator and air conditioning refrigerants, swimming pool chemicals, calcium and sodium chloride (water softener salt), waxes, and process chemicals and typical compounds which are potentially corrosive. Do not store products of this sort near the heater. Also, air which is brought in contact with the heater should not contain any of these chemicals. If necessary, uncontaminated air should be obtained from remote or outside sources. The limited warranty is voided when failure of water heater is due to a corrosive atmosphere. (Refer to the limited warranty for complete terms and conditions).

## IMPROPER COMBUSTION

### WARNING

ATTIC AND/OR EXHAUST FANS OPERATING ON THE PREMISES WITH A WATER HEATER CAN RESULT IN CARBON MONOXIDE POISONING AND DEATH.

OPERATION OF THESE FANS CAN PRODUCE A NEGATIVE DRAFT IN THE AREA OF THE WATER HEATER PREVENTING THE PRODUCTS OF COMBUSTION FROM EXHAUSTING THROUGH THE CHIMNEY OR VENT PIPE.

The venting of the water heater should be inspected by a qualified service technician at the time of installation and periodically thereafter to ensure a down-draft condition does not exist.

DO NOT OBSTRUCT THE FLOW OF COMBUSTION AND VENTILATING AIR. ADEQUATE AIR FOR COMBUSTION AND VENTILATION MUST BE PROVIDED FOR SAFE OPERATION.

## EXTENDED NON-USE PERIODS

### WARNING

HYDROGEN GAS CAN BE PRODUCED IN A HOT WATER SYSTEM SERVED BY THIS HEATER THAT HAS NOT BEEN USED FOR A LONG PERIOD OF TIME (GENERALLY TWO WEEKS OR MORE). HYDROGEN GAS IS EXTREMELY FLAMMABLE. To reduce the risk of injury under these conditions, it is recommended that the hot water faucet be opened for several minutes at the kitchen sink before using any electrical appliance connected to the hot water system. If hydrogen is present, there will probably be an unusual sound such as air escaping through the pipe as the water begins to flow. THERE SHOULD BE NO SMOKING OR OPEN FLAME NEAR THE FAUCET AT THE TIME IT IS OPEN.

## INSULATION BLANKETS

Insulation blankets available to the general public for external use on gas water heaters are not approved for use on your State water heater. The purpose of an insulation blanket is to reduce the standby heat loss encountered with storage tank water heaters. Your State water heater meets or exceeds the ASHRAE/IES 90.1b-1992 standards with respect to insulation and standby loss requirement making an insulation blanket unnecessary.

### WARNING

Should you choose to apply an insulation blanket to this heater, you should follow these instructions. Failure to follow these instructions can result in fire, asphyxiation, serious personal injury or death.

- Do not apply insulation to the top of the water heater, as this will interfere with safe operation of exhaust inducer.
- Do not cover gas valve on the temperature & pressure relief valve.
- Do not cover the instruction manual. Keep it on the side of the water heater or nearby for future reference.
- Do not allow insulation to come within 2" (5cm) of the burner, to prevent blockage of combustion air flow to the burners.
- Do not allow insulation to come within 9" (23cm) of the floor, (within 2" (5cm) of bottom cover) to prevent blockage of combustion air flow to the burners.
- Do inspect the insulation blanket frequently to make sure it does not sag, thereby obstructing combustion air flow.
- Do obtain new labels from State for placement on the blanket directly over the existing labels.

## HIGH ALTITUDE INSTALLATIONS



### WARNING

INSTALLATIONS ABOVE 2000 FEET (610 METERS) REQUIRE REPLACEMENT OF THE BURNER ORIFICE IN ACCORDANCE WITH SECTION 8.1.2 OF THE NATIONAL FUEL GAS CODE (ANSI Z223.1). FAILURE TO REPLACE THE ORIFICE WILL RESULT IN IMPROPER AND INEFFICIENT OPERATION OF THE APPLIANCE RESULTING IN THE PRODUCTION OF INCREASED LEVELS OF CARBON MONOXIDE GAS IN EXCESS OF SAFE LIMITS WHICH COULD RESULT IN SERIOUS PERSONAL INJURY OR DEATH.

You should contact your gas supplier for any specific changes which may be required in your area.

As elevation above sea level is increased, there is less oxygen per cubic foot of air. Therefore, the heater input rate should be reduced at high altitudes for satisfactory operation with the reduced oxygen supply. Failure to make this reduction would result in an overfiring of the heater causing sooting, poor combustion and/or unsatisfactory heater performance.

### REQUIREMENTS

Ratings specified by manufacturers for most appliances apply for elevations up to 2000 feet. For elevations above 2000 feet, ratings must be reduced at the rate of 4% for each 1000 feet above sea level. For example, if a heater is rated at 120,000 Btuh at sea level, to rate the heater at 4000 feet, you subtract 4 (once for each thousand feet) x .04 (4% input reduction) x 120,000 Btuh (original rating) from the original rating. Therefore, to calculate the input rating at 4,000 feet:  $4 \times .04 \times 120,000 = 19,200$  Btuh,  $120,000 - 19,200 = 100,800$  Btuh. At 6000 feet the correct input rating should be 91,200 Btuh.

The input reduction is primarily achieved by reducing the size of the main burner orifices. To do this, the main burner orifices require replacement with orifices sized for the particular installation elevation. Correct orifice sizing and parts may be obtained from State Water Heaters. When ordering, be sure to state the model number and the altitude of the location where the water heater is being installed.

Upon completion of derating of the heater, adjustment to the gas pressure regulator may be required. See CHECKING THE INPUT section in this manual for inlet and manifold pressure requirements.

Also due to the input rating reduction required at high altitudes, the output rating of the appliance is also reduced and should be compensated for in the sizing of the equipment for application.

## FEATURES

### SELF-CLEANING HYDRO CANNON

These units include a self-cleaning hydro-cannon installed in the front water inlet. See figure 2. The hydro cannon must be oriented correctly for proper function. There is a marked range on the pipe nipple portion of the hydro cannon, that must be aligned with the top of the inlet spud. A label above the jacket hole has an arrow that will point to the marked portion of the pipe nipple if the orientation is correct. If the arrow does not point within the marked range on the pipe nipple, adjust the pipe nipple to correct. A pipe union is supplied with the hydro cannon to reduce the probability of misaligning the hydro cannon accidentally while tightening the connection to the inlet water

supply line. Improper orientation of the hydro cannon can cause poor performance of the heater and can significantly reduce outlet water temperatures during heavy draws.



**NOTE:** The inlet tube may have 1, 3 or 7 cross-tubes.

FIGURE 2

### HIGH LIMIT SWITCH

The digital thermostat (Fig. 3) contains the high limit (energy cutoff) sensor. The high limit switch interrupts main burner gas flow should the water temperature reach 203°F (95°C).

In the event of high limit switch operation, the appliance cannot be restarted unless the water temperature is reduced to approximately 120°F (49°C). The high limit reset button on the front of the control then needs to be depressed.

Continued manual resetting of high limit control, preceded by higher than usual water temperature is evidence of high limit switch operation. The following is a possible reason for high limit switch operation:

- A malfunction in the thermostatic controls would allow the gas valve to remain open causing water temperature to exceed the thermostat setting. The water temperature would continue to rise until high limit switch operation.

Contact your dealer or service agent if continued high limit switch operation occurs.

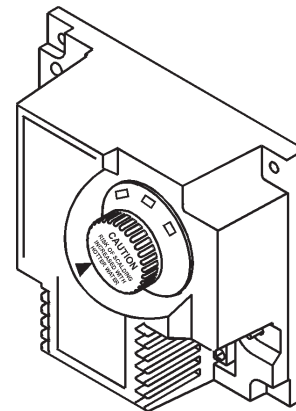

DIGITAL THERMOSTAT  
FIGURE 3

### ELECTRONIC IGNITION CONTROL

Each heater is equipped with an ignition module. The solid state ignition control (Fig. 4), ignites the main burner by utilizing a silicone nitride ignitor. The silicone nitride ignitor shuts off during the heating cycle and the main burner flame is sensed through a remote flame sensor integral to the silicone nitride ignitor assembly. The ignition control will try to ignite the main burner three times before lockout. Then it waits one hour before trying again to ignite the main burners. This is a continuous cycle.





any direction. If the heater is installed in a carpeted alcove, the entire floor shall be covered by the panel. Also, see the DRAINING requirements in MAINTENANCE Section.

**THE HEATER SHALL BE LOCATED OR PROTECTED SO IT IS NOT SUBJECT TO PHYSICAL DAMAGE BY A MOVING VEHICLE.**

**⚠ WARNING**

**FLAMMABLE ITEMS, PRESSURIZED CONTAINERS OR ANY OTHER POTENTIAL FIRE HAZARDOUS ARTICLES MUST NEVER BE PLACED ON OR ADJACENT TO THE HEATER. OPEN CONTAINERS OR FLAMMABLE MATERIAL SHOULD NOT BE STORED OR USED IN THE SAME ROOM WITH THE HEATER.**

**THE HEATER MUST NOT BE LOCATED IN AN AREA WHERE IT WILL BE SUBJECT TO FREEZING.**

**LOCATE IT NEAR A FLOOR DRAIN. THE HEATER SHOULD BE LOCATED IN AN AREA WHERE LEAKAGE FROM THE HEATER OR CONNECTIONS WILL NOT RESULT IN DAMAGE TO THE ADJACENT AREA OR TO LOWER FLOORS OF THE STRUCTURE.**

**WHEN SUCH LOCATIONS CANNOT BE AVOIDED, A SUITABLE DRAIN PAN SHOULD BE INSTALLED UNDER THE HEATER.** Such pans should be fabricated with sides at least 2" (50.8 mm) deep, with length and width at least 2" (50.8 mm) greater than the diameter of the heater and must be piped to an adequate drain. The pan must not restrict combustion air flow.

**LEVELING**

If the unit is not level, insert the bolts which were used in crating into the legs to correct this condition.

**CLEARANCES**

These heaters are approved for installation on combustible flooring (with Leg Kit #6570-7) in an alcove when the minimum clearance from any combustion construction are followed as indicated in figure 6 and Table 4.

In all installations the minimum combustible clearances from vent piping shall be 6" (152mm). Vent piping passing through a combustible wall or ceiling must be a continuous run (no joints) and retain the 6" (152mm) clearance unless an approved reducing thimble is used.

A service clearance of 24" (610mm) should be maintained from serviceable parts, such as relief valves, flue baffles, thermostats, cleanout openings or drain valves.

The units are approved for installation with side, rear and ceiling clearances as indicated below:

<b>MINIMUM CLEARANCES TO COMBUSTIBLES IN INCHES (mm)</b>				
<b>MODEL</b>	<b>"A" RIGHT SIDE</b>	<b>"B" LEFT SIDE</b>	<b>"C" BACK</b>	<b>"D" CEILING</b>
SBN71120NE	2" (51mm)	2" (51mm)	2" (51mm)	12" (305mm)
SBN81154NE	2" (51mm)	2" (51mm)	2" (51mm)	12" (305)
SBN100180NE	2" (51mm)	2" (51mm)	2" (51mm)	12" (305)
SBN100199NE	2" (51mm)	2" (51mm)	2" (51mm)	12" (305)
SBN100250NE	2" (51mm)	2" (51mm)	2" (51mm)	12" (305)
SBN100275NE	2" (51mm)	2" (51mm)	2" (51mm)	12" (305)
SBN85310NE	6" (152mm)	6" (152mm)	6" (152mm)	12" (305)
SBN85366NE	3" (76mm)	3" (76mm)	3" (76mm)	12" (305)
SBN85390NE	3" (76mm)	3" (76mm)	3" (76mm)	12" (305)

**TABLE 4**

<b>CLEARANCES TO NONCOMBUSTION CONSTRUCTION</b>				
<b>MODEL</b>	<b>"A" RIGHT SIDE</b>	<b>"B" LEFT SIDE</b>	<b>"C" BACK</b>	<b>"D" CEILING</b>
SBN71120NE	0	0	0	12" (305mm)
SBN81154NE	0	0	0	12" (305mm)
SBN100180NE	0	0	0	12" (305mm)
SBN100199NE	0	0	0	12" (305mm)
SBN100250NE	0	0	0	12" (305mm)
SBN100275NE	0	0	0	12" (305mm)
SBN85310NE	6" (152mm)	6" (152mm)	6" (152mm)	12" (305mm)
SBN85366NE	0	0	0	12" (305mm)
SBN85390NE	0	0	0	12" (305mm)

**TABLE 5**

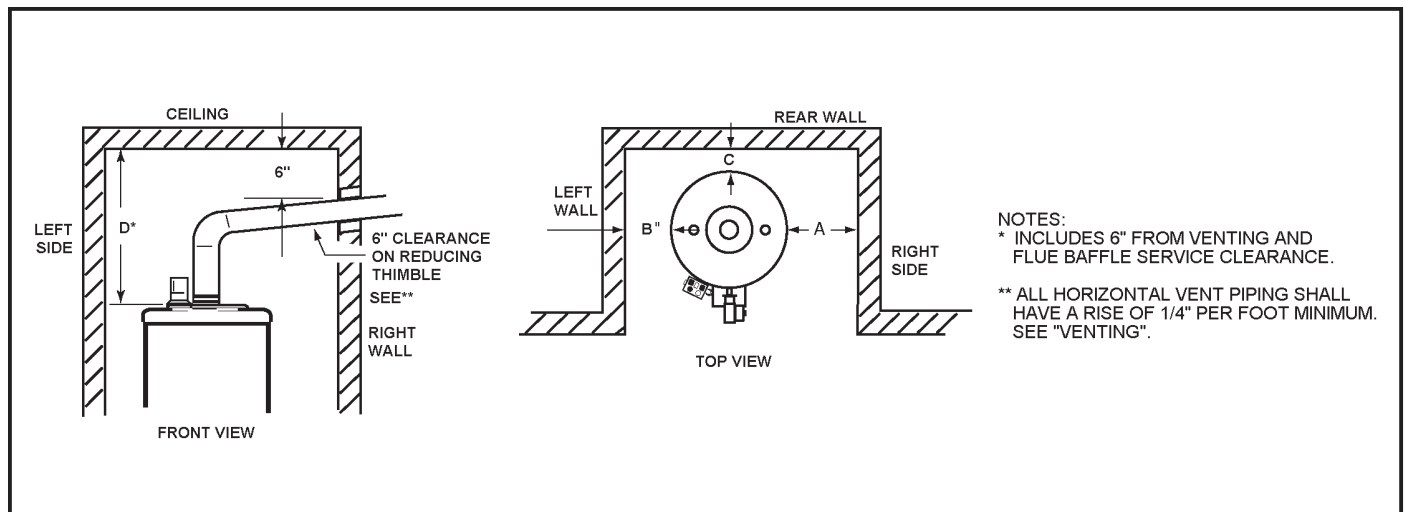

**ILLUSTRATION OF MINIMUM COMBUSTIBLE CLEARANCES IN AN ALCOVE - FIGURE 6**

## HARD WATER

Where hard water conditions exist, water softening or the threshold type of water treatment is recommended. This will protect the dishwashers, coffee urns, water heaters, water piping and other equipment.

See MAINTENANCE section for details of tank cleanout procedure.

## AIR REQUIREMENTS

REFER TO THE LATEST EDITION OF THE "NATIONAL FUEL GAS CODE" ANSI Z223.1/NFPA 54.

**KEEP APPLIANCE AREA CLEAR AND FREE OF COMBUSTIBLE MATERIALS, GASOLINE AND OTHER FLAMMABLES, VAPORS AND LIQUIDS.**

**DO NOT OBSTRUCT THE FLOW OF COMBUSTION OR VENTILATING AIR.**

### **! WARNING**

**FOR SAFE OPERATION PROVIDE ADEQUATE AIR FOR COMBUSTION AND VENTILATION. AN INSUFFICIENT SUPPLY OF AIR WILL CAUSE RECIRCULATION OF COMBUSTION PRODUCTS RESULTING IN AIR CONTAMINATION THAT MAY BE HAZARDOUS TO LIFE. SUCH A CONDITION OFTEN WILL RESULT IN A YELLOW, LUMINOUS BURNER FLAME, CAUSING CARBONING OR SOOTING OF THE COMBUSTION CHAMBER, BURNERS AND FLUE TUBES AND CREATES A RISK OF ASPHYXIATION.**

Where an exhaust fan is supplied in the same room with a heater, sufficient openings for air must be provided in the walls. **UNDERSIZED OPENINGS WILL CAUSE AIR TO BE DRAWN INTO THE ROOM THROUGH THE CHIMNEY, CAUSING POOR COMBUSTION. SOOTING MAY RESULT IN SERIOUS DAMAGE TO THE HEATER AND RISK OF FIRE OR EXPLOSION.**

## UNCONFINED SPACE

In buildings of conventional frame, brick, or stone construction, unconfined spaces may provide adequate air for combustion, ventilation and draft hood dilution.

If the unconfined space is within a building of tight construction (buildings using the following construction: weather stripping, heavy insulation, caulking, vapor barrier, etc.), air for combustion, ventilation and draft hood dilution must be obtained from outdoors. The installation instructions for confined spaces in tightly constructed buildings must be followed to ensure adequate air supply.

## CONFINED SPACE

When drawing combustion and dilution air from inside a conventionally constructed building to a confined space, such a space shall be provided with two permanent openings, ONE IN OR WITHIN 12 INCHES (30.5cm) OF THE ENCLOSURE TOP

AND ONE IN OR WITHIN 12 INCHES (30.5cm) OF THE ENCLOSURE BOTTOM. Each opening shall have a free area of at least one square inch per 1000 Btuh (2,225mm<sup>2</sup>/kW) of the total input of all appliances in the enclosure, but not less than 100 square inches (645 square cm).

If the confined space is within a building of tight construction, air for combustion, ventilation, and draft hood dilution must be obtained from outdoors. When directly communicating with the outdoors or communicating with the outdoors through vertical ducts, two permanent openings, located in the above manner, shall be provided. Each opening shall have a free area of not less than one square inch per 4000 Btuh (8,900mm<sup>2</sup>/kW) of the total input of all appliances in the enclosure. If horizontal ducts are used, each opening shall have a free area of not less than one square inch per 2000 Btuh (4,450mm<sup>2</sup>/kW) of the total input of all appliances in the enclosure.

## VENTING

### **! WARNING**

**THE INSTRUCTIONS IN THIS SECTION ON VENTING MUST BE FOLLOWED TO AVOID CHOKED COMBUSTION OR RECIRCULATION OF FLUE GASES. SUCH CONDITIONS CAUSE SOOTING OR RISKS OF FIRE AND ASPHYXIATION.**

Heater must be protected from freezing downdrafts.

Remove all soot or other obstructions from the chimney that will retard a free draft.

Type B venting is recommended with these heaters. For typical venting application see TECHNICAL DATA VENTING on pages 9 and 10.

This water heater must be vented in compliance with all local codes, the current revision of the National Fuel Gas Code (ANSI-Z223.1) and with the Category I Venting Tables.

If any part of the vent system are exposed to ambient temperatures below 40°F (4.4°C) it must be insulated to prevent condensation.

- Do not connect the heater to a common vent or chimney with solid fuel burning equipment. This practice is prohibited by many local building codes as is the practice of venting gas fired equipment to the duct work of ventilation systems.

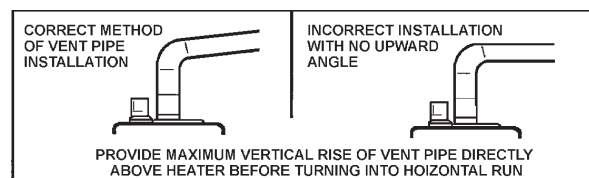

FIGURE 7

- Where a separate vent connection is not available and the vent pipe from the heater must be connected to a common vent with an oil burning furnace, the vent pipe should enter the smaller common vent or chimney at a point above the large vent pipe.



**TABLE 6. TECHNICAL DATA VENTING**

**TYPE B GAS VENT**  
**Multiple Gas Fired Tank-Type Heaters**

When venting multiple tank type heaters using Type B vent pipe, follow the installation diagram (figure 4) and tables below which give sizing and data based upon NFPA 54/ANSI Z223. 1992.

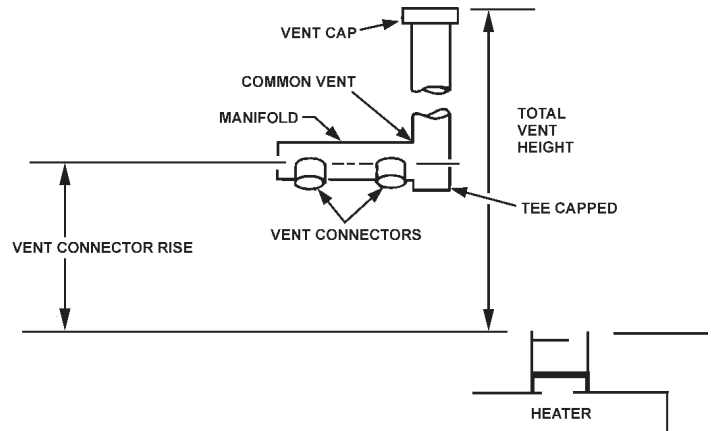

**MODEL - 120**

Input: 120,000 Btu/hr		Total Vent Height (Feet)									
Vent Connector Size: 5 inches		6   8   10   15   20   30   50   100									
	Input Btu/hr	Rise	Vent Connector Diameter (Inches)								
	120,000	1 Ft.	6	6	5	5	5	5	5	5	5
	120,000	2 Ft.	5	5	5	5	5	5	5	5	5
120,000	3 Ft.	5	5	5	5	5	5	5	5	5	
Number of 120 Heaters	Combined Input in Thousands of Btu/hr	Manifold and Common Vent Diameter (Inches)									
2	240,000	7	7	6	6	6	6	6	6	6	
3	360,000	8	8	7	7	7	6	6	6	6	
4	480,000	9	9	9	8	8	7	7	6	6	

**MODEL - 154**

Input: 154,000 Btu/hr		Total Vent Height (Feet)									
Vent Connector Size: 6 inches		6   8   10   15   20   30   50   100									
	Input Btu/hr	Rise	Vent Connector Diameter (Inches)								
	154,000	1 Ft.	6	6	6	6	6	6	6	6	6
	154,000	2 Ft.	6	6	6	6	6	6	6	6	6
154,000	3 Ft.	6	6	6	6	6	6	6	6	6	
Number of 154 Heaters	Combined Input in Thousands of Btu/hr	Manifold and Common Vent Diameter (Inches)									
2	308,000	7	7	6	6	6	6	6	6	6	
3	462,000	8	8	7	7	7	6	6	6	6	
4	616,000	9	9	9	8	8	7	7	6	6	

**MODEL - 180,199, 200**

Input: 180,000, 190,000 and 199,000 Btu/hr		Total Vent Height (Feet)									
Vent Connector Size: 6 inches		6   8   10   15   20   30   50   100									
	Input Btu/hr	Rise	Vent Connector Diameter (Inches)								
	180,000	1 Ft.	7	7	6	6	6	6	6	6	6
	190,000	1 Ft.	7	7	7	6	6	6	6	6	6
	199,000	1 Ft.	7	7	7	6	6	6	6	6	6
	180,000	2 Ft.	6	6	6	6	6	6	6	6	6
	190,000	2 Ft.	7	6	6	6	6	6	6	6	6
	199,000	2 Ft.	7	7	6	6	6	6	6	6	6
	180,000	3 Ft.	6	6	6	6	6	6	6	6	6
	190,000	3 Ft.	6	6	6	6	6	6	6	6	6
199,000	3 Ft.	6	6	6	6	6	6	6	6	6	
Number of Heaters	Combined Input in Thousands of Btu/hr	Manifold & Common Vent Diameter (Inches)									
2	360,000	7	7	6	6	6	6	6	6	6	
	380,000	7	7	7	6	6	6	6	6	6	
	398,000	6	7	7	6	6	6	6	6	6	
	540,000	7	6	6	6	6	6	6	6	6	
3	570,000	7	6	6	6	6	6	6	6	6	
	597,000	6	7	6	6	6	6	6	6	6	
	720,000	6	6	6	6	6	6	6	6	6	
4	760,000	6	6	6	6	6	6	6	6	6	
	796,000	6	6	6	6	6	6	6	6	6	

**TABLE 6. TECHNICAL DATA VENTING (Continued)**

<b>MODEL - 250</b>										
<b>Input: 250,000 Btu/hr</b>			<b>Total Vent Height (Feet)</b>							
<b>Vent Connector Size: 6 inches</b>			6	8	10	15	20	30	50	100
	<b>Input Btu/hr</b>	<b>Rise</b>	<b>Vent Connector Diameter (Inches)</b>							
	250,000	1 Ft	8	8	7	7	7	6	6	6
	250,000	2 Ft	7	7	7	7	6	6	6	6
	250,000	3 Ft	7	7	7	7	6	6	6	6
<b>Number of Heaters</b>	<b>Combined Input in Thousands of Btu/hr</b>	<b>Manifold and Common Vent Diameter (Inches)</b>								
2	500,000	9	9	9	8	8	7	7	7	
3	750,000	12	12	10	10	10	9	8	8	
4	1,000,000	14	14	12	12	10	10	9	9	
<b>MODEL - 275</b>										
<b>Input: 275,000 Btu/hr</b>			<b>Total Vent Height (Feet)</b>							
<b>Vent Connector Size: 6 inches</b>			6	8	10	15	20	30	50	100
	<b>Input Btu/hr</b>	<b>Rise</b>	<b>Vent Connector Diameter (Inches)</b>							
	275,000	1 Ft	8	8	7	7	6	6	6	6
	275,000	2 Ft	8	8	7	7	6	6	6	6
	275,000	3 Ft	7	7	7	7	6	6	6	6
<b>Number of Heaters</b>	<b>Combined Input in Thousands of Btu/hr</b>	<b>Manifold and Common Vent Diameter (Inches)</b>								
2	550,000	10	9	9	8	8	8	7	7	
3	825,000	12	12	12	10	9	9	8	8	
4	1,100,000	14	14	14	12	12	10	9	9	
<b>MODEL - 310</b>										
<b>Input: 310,000 Btu/hr</b>			<b>Total Vent Height (Feet)</b>							
<b>Vent Connector Size: 6 inches</b>			6	8	10	15	20	30	50	100
	<b>Input Btu/hr</b>	<b>Rise</b>	<b>Vent Connector Diameter (Inches)</b>							
	310,000	1 Ft	9	8	8	8	7	7	6	6
	310,000	2 Ft	8	8	8	7	7	7	6	6
	310,000	3 Ft	8	8	8	7	7	7	6	6
<b>Number of Heaters</b>	<b>Combined Input in Thousands of Btu/hr</b>	<b>Manifold &amp; Common Vent Diameter</b>								
2	620,000	10	10	9	9	8	8	7	7	
3	930,000	14	12	12	12	10	9	9	8	
4	1,240,000	14	14	14	12	12	12	10	9	
<b>MODEL - 366, 400</b>										
<b>Input: 366,000, 399,000 Btu/hr</b>			<b>Total Vent Height (Feet)</b>							
<b>Vent Connector Size: 6 inches</b>			6	8	10	15	20	30	50	100
	<b>Input Btu/hr</b>	<b>Rise</b>	<b>Vent Connector Diameter (Inches)</b>							
	366,000	1 Ft	9	9	9	8	8	8	8	8
	399,000	1 Ft	10	9	9	9	8	8	8	8
	366,000	2 Ft	9	9	8	8	8	8	8	8
	399,000	2 Ft	9	9	9	8	8	8	8	8
	366,000	3 Ft	9	8	8	8	8	8	8	8
	399,000	3 Ft	9	9	8	8	8	8	8	8
<b>Number of Heaters</b>	<b>Combined Input in Thousands of Btu/hr</b>	<b>Manifold &amp; Common Vent Diameter (Inches)</b>								
2	732,000	12	10	10	9	9	9	8	8	
	798,000	12	12	10	10	9	9	8	8	
3	1,098,000	14	14	14	12	12	10	9	9	
	1,197,000	14	14	14	12	12	10	10	9	
4	1,464,000	16	16	14	14	14	12	12	10	
	1,596,000	16	16	16	14	14	12	12	10	

## MULTIPLE HEATER MANIFOLD

Figure 8 and tables on pages 9 and 10 should be used for horizontally manifolding two or more heaters.

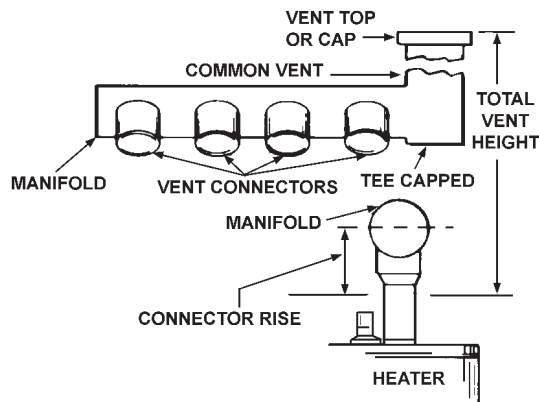

FIGURE 8

## WATER LINE CONNECTIONS

This manual provides detailed installation diagrams (see pages 13-19 of this manual) for typical methods of application for the water heater(s).

The water heater may be installed by itself, or with a separate storage tank, on both single and two-temperature systems. When used with a separate storage tank, the circulation may be either by gravity or by means of a circulating pump. When a circulating pump is used it is important to note that the flow rate should be slow so that there will be a minimum of turbulence inside the heater.

If a water heater is installed in a closed water system, provisions for the thermal expansion in the Hot Water System must be provided. Contact the water supplier or local plumbing inspector on how to control this situation.

## WATER (POTABLE) HEATING AND SPACE HEATING (See pages 13-19)

1. All piping components connected to this unit for space heating applications shall be suitable for use with potable water.
2. Toxic chemicals, such as those used for boiler treatment, shall NEVER be introduced into this system.
3. This unit may NEVER be connected to any existing heating system or component(s) previously used with a non-potable water heating appliance.
4. When the system requires water for space heating at temperatures higher than required for domestic water purposes, a tempering valve must be installed. Please refer to installation diagrams on pages 16 and 18 of this manual for suggested piping arrangements.

### CAUTION

A closed system will exist if a check valve (without bypass), pressure reducing valve (without bypass), or a water meter

(without bypass) is installed in the cold water line between the water heater and street main (or well).

Excessive pressure may develop in such closed systems, causing premature tank failure or intermittent relief valve operation. This is not a warranty failure. An expansion tank or a similar device may be required in the inlet supply line between the appliance and the meter or valve to compensate for the thermal expansion of the water.

## SYSTEM CONNECTIONS

The system installation must conform to these instructions and to the local code authority having jurisdiction. Good practice requires that all heavy piping be supported.

## THERMOMETERS (Not Supplied)

Thermometers should be obtained and field installed as shown in the installation diagrams.

Thermometers are installed in the system as a means of detecting the temperature of the outlet water supply.

## RELIEF VALVE

This water heater is equipped with a combination temperature-pressure relief valve that complies with the standard for relief valves and automatic gas shutoff devices for hot water supply system, ANSI Z21.22. **FOR SAFE OPERATION OF THE WATER HEATER, THE RELIEF VALVE(S) MUST NOT BE REMOVED OR PLUGGED.**

ASME ratings cover pressure relief capacities. A.G.A. ratings cover release rate with temperature actuation.

In addition to the appliance relief valve, each remote storage tank which may be used in conjunction with this appliance shall also be installed with a properly sized, rated and approved combination temperature (ANSI) and pressure (ASME) relief valve(s).

### WARNING

**THE PURPOSE OF RELIEF VALVE IS TO AVOID EXCESSIVE PRESSURE OR TEMPERATURE INTO THE STEAM RANGE, WHICH MAY CAUSE SCALDING AT FIXTURES, TANK EXPLOSION, SYSTEM OR HEATER DAMAGE. NO VALVE IS TO BE PLACED BETWEEN THE RELIEF VALVE AND TANK.**

Your local code authority may have other specific relief valve requirements.

**A DRAIN LINE MUST BE CONNECTED TO THE RELIEF VALVE TO DIRECT DISCHARGE TO A SAFE LOCATION TO AVOID SCALDING OR WATER DAMAGE. THIS LINE MUST NOT BE REDUCED FROM THE SIZE OF THE VALVE OUTLET AND MUST NOT CONTAIN VALVES, RESTRICTIONS NOR SHOULD IT BE LOCATED IN FREEZING AREAS. DO NOT THREAD OR CAP THE END OF THIS LINE. RESTRICTED OR BLOCKED DISCHARGE WILL DEFEAT THE PURPOSE OF THE VALVE AND IS UNSAFE. DISCHARGE LINE SHALL BE INSTALLED TO ALLOW COMPLETE DRAINAGE OF BOTH THE VALVE AND LINE.**

See SERVICE INFORMATION section for procedure and precautions.

# INSTALLATION DIAGRAMS-TOP INLET/OUTLET USAGE

## GENERAL

The type, size and location of the relief valves must be in accordance with local codes. The locations of the relief valves shown in the installation diagrams are typical. The heater has a factory installed high temperature limit switch and temperature and pressure relief valve.

Cold water lines to heater should be installed as shown in order to minimize gravity circulation of hot water to building cold water lines.

A listed temperature and pressure relief valve of adequate capacity is installed on the heater. The locations shown in the installation diagrams on the following pages are typical.

The discharge opening of the temperature and pressure relief valve, located in front of the heater must be piped to an open drain and should not be subject to freezing temperatures.

Install in accordance with all local codes.

Use of the top inlet water connection requires installation of an inlet dip tube (refer to figure 9). The tube is supplied in the heater. Follow caution labels if applying heat to this fitting. Do not allow pipe dope to contact the plastic tube during installation.

## CODE RESTRICTIONS

Use of the top inlet water connection is not permitted on installations in the state of North Carolina, due to the material of the tube (Polypropylene). Where such code restrictions exist, use only lower inlet tank connection. This may also require a heat trap - check local codes. The "Top Outlet" connection may still be used on these applications. Plug or cap all unused openings in the tank before filling with water.



**TEMPERATURE SETTING SHOULD NOT EXCEED SAFE USE TEMPERATURE AT FIXTURES. SEE WATER TEMPERATURE CONTROL WARNING ON PAGE 25. IF HIGHER PREHEAT TEMPERATURES ARE NECESSARY TO OBTAIN ADEQUATE BOOSTER OUTPUT, ADD AN ANTI-SCALD VALVE FOR HOT WATER SUPPLIED TO FIXTURES.**

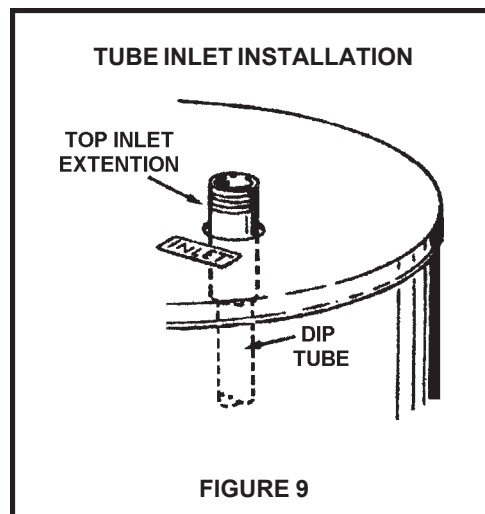

## VERTICAL STORAGE TANK AND FORCED CIRCULATION

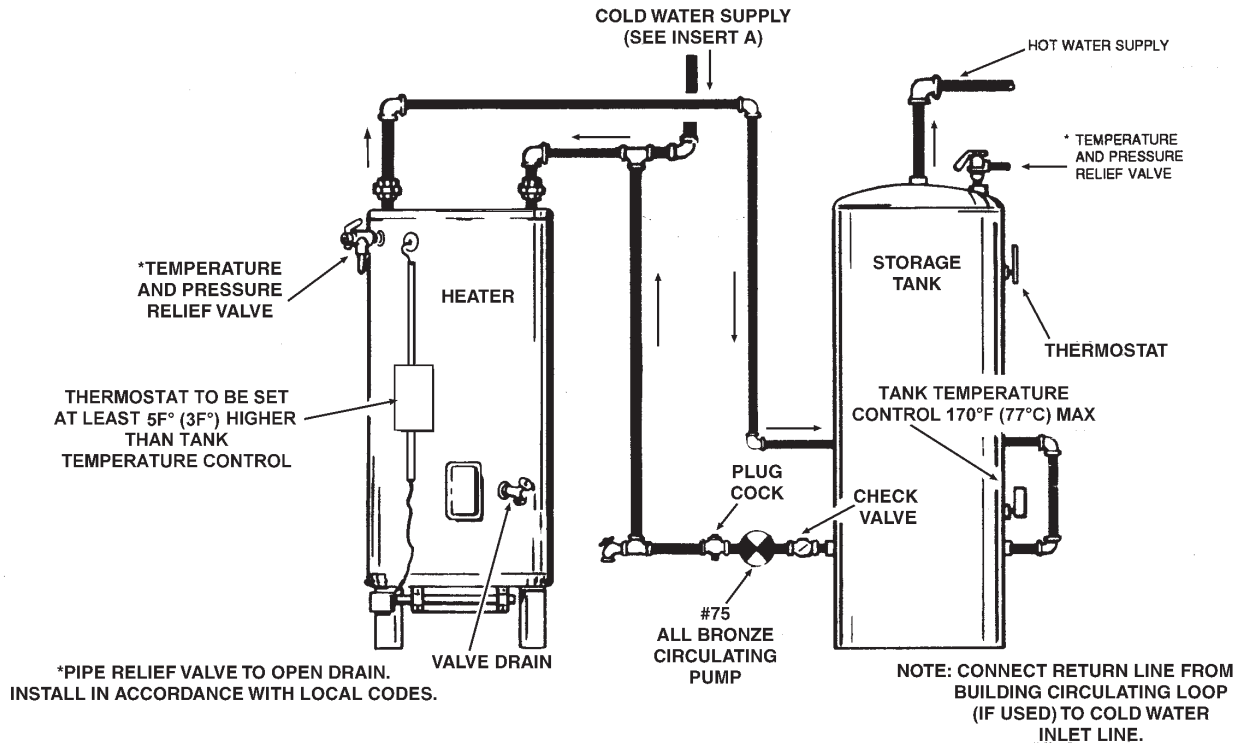

### ! DANGER

TEMPERATURE SETTING SHOULD NOT EXCEED SAFE USE TEMPERATURE AT FIXTURES. SEE WATER TEMPERATURE CONTROL WARNING ON PAGE 25. IF HIGHER PREHEAT TEMPERATURES ARE NECESSARY TO OBTAIN ADEQUATE BOOSTER OUTPUT, ADD AN ANTI-SCALD VALVE FOR HOT WATER SUPPLIED TO FIXTURES.

## HORIZONTAL STORAGE TANK AND FORCED CIRCULATION

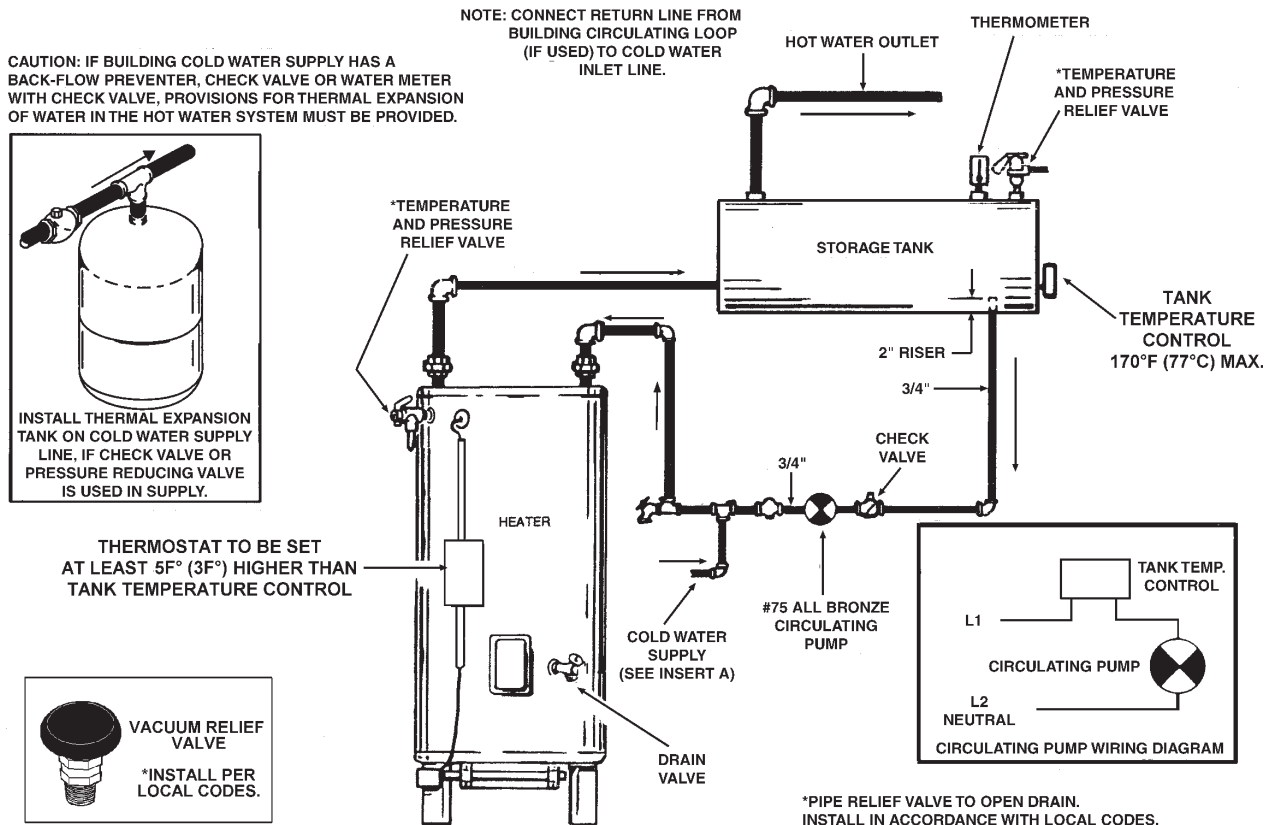



## TWO TEMPERATURE - ONE HEATER HIGH TEMPERATURE STORAGE WITH RECIRCULATION OF SANITIZING LOOP

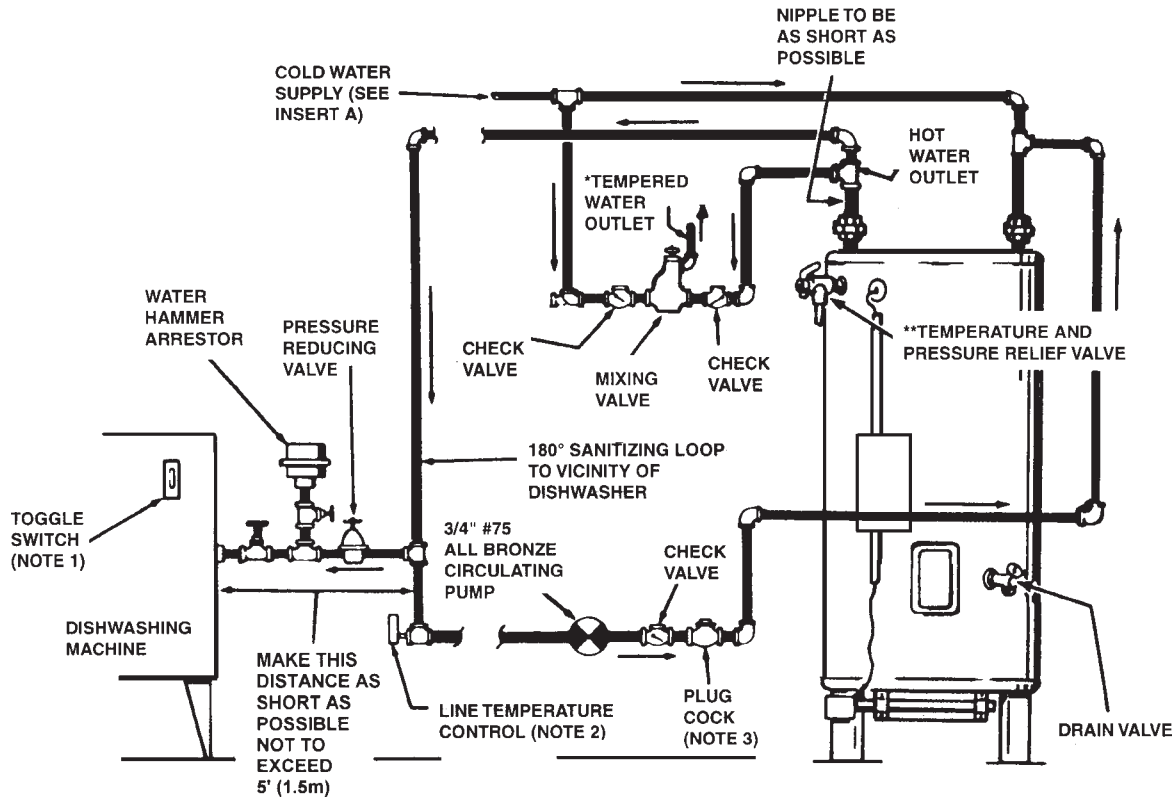

**NOTE 1:** TOGGLE SWITCH CONTROLS 180°F (82°C) WATER CIRCULATION. INSTALL ON OR CLOSE TO DISHWASHING MACHINE. TOGGLE SWITCH MUST BE CLOSED (ON) DURING THE RINSE OPERATION AND OPEN (OFF) WHEN DISHWASHER IS NOT OPERATING OR WHEN ON LONG STANDBY.

**NOTE 2:** INSTALL LINE TEMPERATURE CONTROL IN AN UNINSULATED TEE BEYOND THE DISHWASHING MACHINE TAKEOFF IN THE SANITIZING LOOP. CONTROL SHOULD BE SET AT 185°F (85°C).

**NOTE 3:** ADJUST PLUG COCK SO THE SANITIZING LOOP FLOW RATE DOES NOT CAUSE UNNECESSARY TURBULENCE IN THE TANK.

\* TEMPERED WATER LOOP, IF USED, CONNECT TO POINT "A".

\*\*PIPE RELIEF VALVE TO OPEN DRAIN. INSTALL IN ACCORDANCE WITH LOCAL CODES.

**CAUTION:** IF BUILDING COLD WATER SUPPLY HAS A BACKFLOW PREVENTER, CHECK VALVE OR WATER METER WITH CHECK VALVE. PROVISIONS FOR THERMAL EXPANSION OF WATER IN THE HOT WATER SYSTEM MUST BE PROVIDED.

### ! DANGER

TEMPERATURE SETTING SHOULD NOT EXCEED SAFE USE TEMPERATURE AT FIXTURES. SEE WATER TEMPERATURE CONTROL WARNING ON PAGE 25. IF HIGHER PREHEAT TEMPERATURES ARE NECESSARY TO OBTAIN ADEQUATE BOOSTER OUTPUT, ADD AN ANTI-SCALD VALVE FOR HOT WATER SUPPLIED TO FIXTURES.

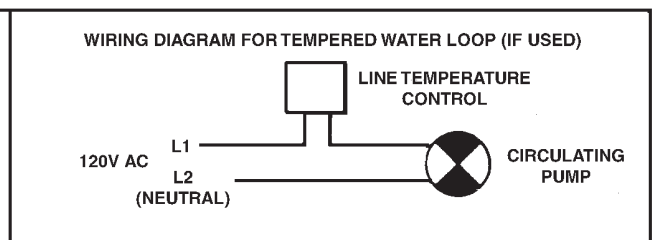
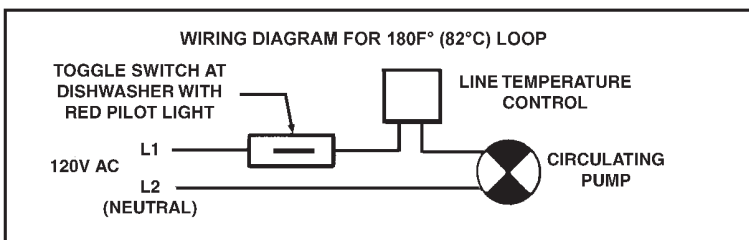
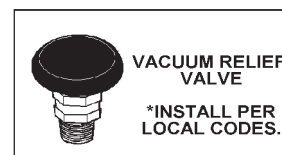
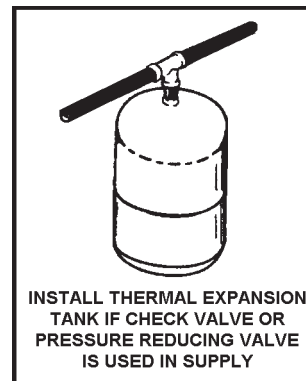

# INSTALLATION DIAGRAMS-SIDE INLET/OUTLET USAGE

A listed temperature and pressure relief valve of adequate capacity is installed on the heater. The locations shown in the installation diagrams on the following pages are typical.

The discharge opening of the temperature and pressure relief valve must be piped to an open drain and should not be subject to freezing conditions. DO NOT REDUCE, BLOCK OR PLUG THE DISCHARGE OPENING OF THE VALVE.

## TWO TEMPERATURE - TWO HEATERS, ONE PRE-HEATER/ONE - BOOSTER HEATER WITH OR WITHOUT BUILDING RECIRCULATION

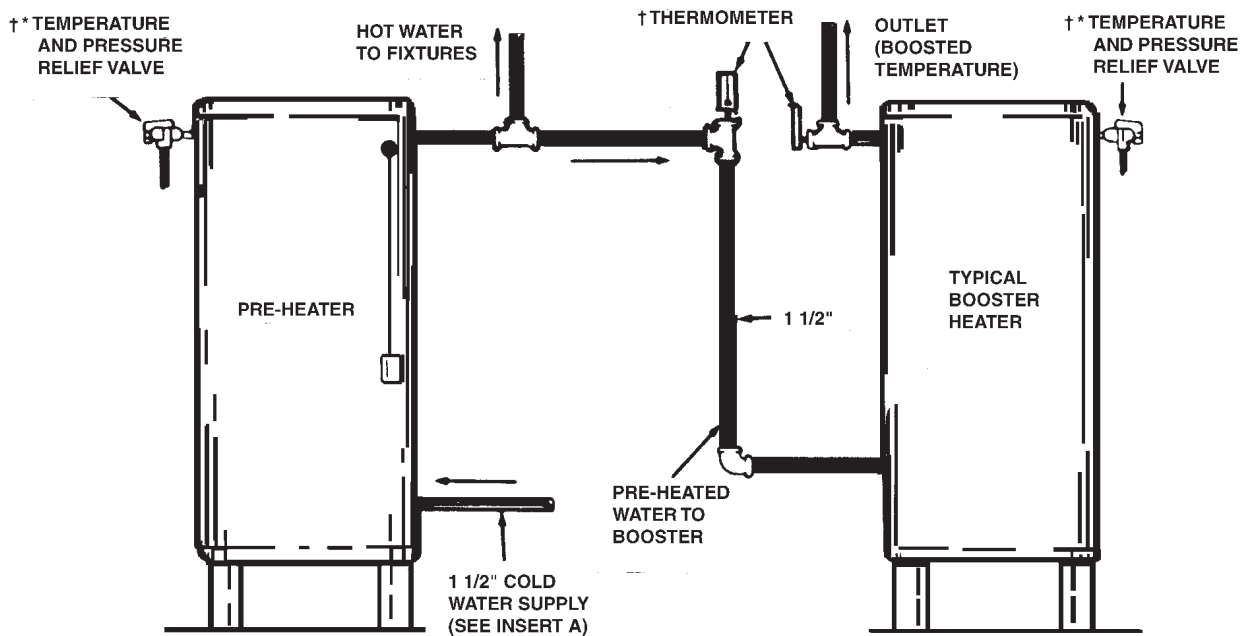

### DANGER

TEMPERATURE SETTING SHOULD NOT EXCEED SAFE USE TEMPERATURE AT FIXTURES. SEE WATER TEMPERATURE CONTROL WARNING ON PAGE 25. IF HIGHER PREHEAT TEMPERATURES ARE NECESSARY TO OBTAIN ADEQUATE BOOSTER OUTPUT, ADD AN ANTI-SCALD VALVE FOR HOT WATER SUPPLIED TO FIXTURES.

#### CIRCULATING RETURN LINE CONNECTION

- FROM FIXTURE LOOP, IF USED, CONNECT TO PRE-HEATER INLET.
  - FROM BOOSTED TEMPERATURE LOOP, IF USED CONNECT TO BOOSTER INLET.
- † AVAILABLE FROM STATE WATER HEATERS.  
\* PIPE RELIEF VALVE TO OPEN DRAIN.

INSTALL IN ACCORDANCE WITH LOCAL CODES.

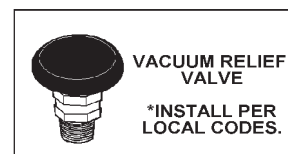
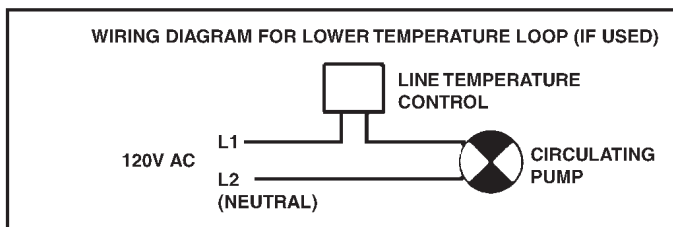
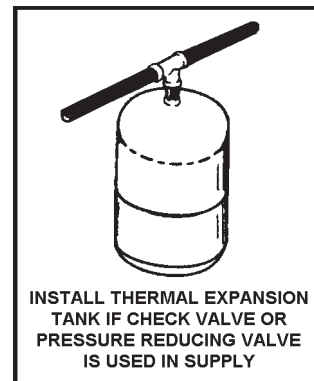

# ONE OR TWO TEMPERATURE - ONE HEATERS, HIGH TEMPERATURE STORAGE WITH OR WITHOUT RECIRCULATION

## HEATER WITH OR WITHOUT MIXING VALVE

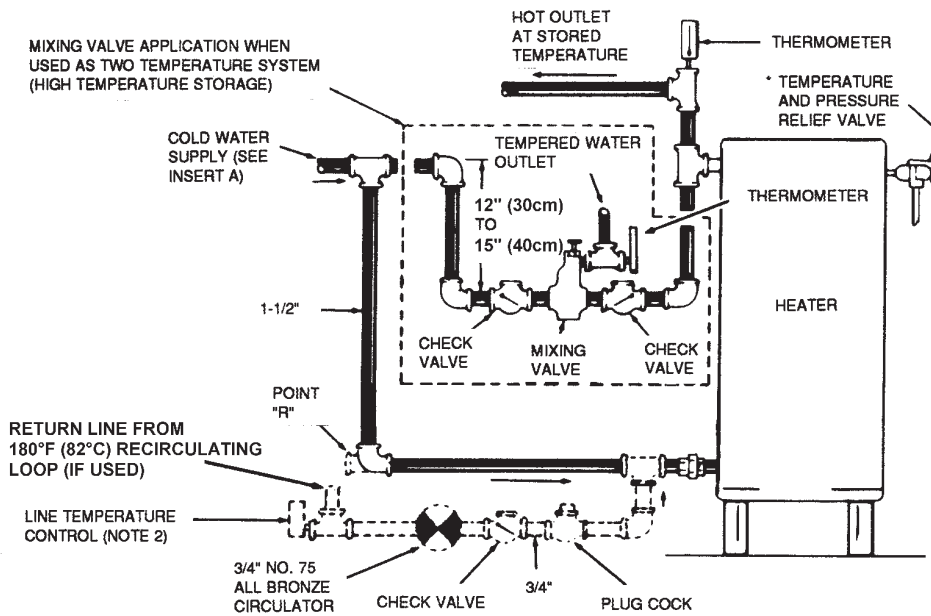

**TEMPERATURE SETTING SHOULD NOT EXCEED SAFE USE TEMPERATURE AT FIXTURES. SEE WATER TEMPERATURE CONTROL WARNING ON PAGE 25. IF HIGHER PREHEAT TEMPERATURES ARE NECESSARY TO OBTAIN ADEQUATE BOOSTER OUTPUT, ADD AN ANTI-SCALD VALVE FOR HOT WATER SUPPLIED TO FIXTURES.**

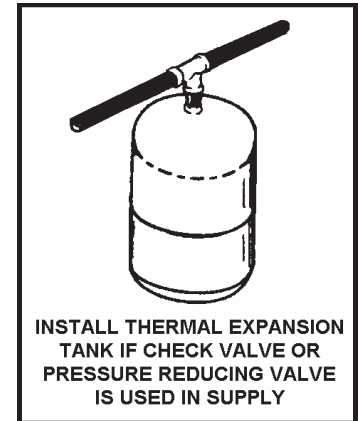

## HEATER WITH MIXING VALVE AND RECIRCULATED SANITIZING LOOP

- \* PIPE RELIEF VALVE TO OPEN DRAIN.
  - INSTALL IN ACCORDANCE WITH LOCAL CODES.
  - CIRCULATING RETURN LINE CONNECTIONS.
  - TEMPERED WATER LOOP, IF USED, CONNECT TO POINT "R".
  - STORED TEMPERATURE WATER LOOP, IF USED, CONNECT TO COLD WATER INLET.
- NOTE 1: TOGGLE SWITCH CONTROLS 180°F (82°C) WATER CIRCULATION. INSTALL ON OR CLOSE TO DISHWASHING MACHINE. TOGGLE SWITCH MUST BE CLOSED (ON) DURING THE RINSE OPERATION AND OPEN (OFF) WHEN DISHWASHER IS NOT OPERATING OR WHEN ON LONG STANDBY.
- NOTE 2: INSTALL LINE TEMPERATURE CONTROL IN AN UNINSULATED TEE BEYOND THE DISHWASHING MACHINE TAKEOFF IN THE SANITIZING LOOP. CONTROL SHOULD BE SET AT 185°F (85°C).
- NOTE 3: ADJUST PLUG COCK SO THE SANITIZING LOOP FLOW RATE DOES NOT CAUSE UNNECESSARY TURBULENCE IN THE TANK.

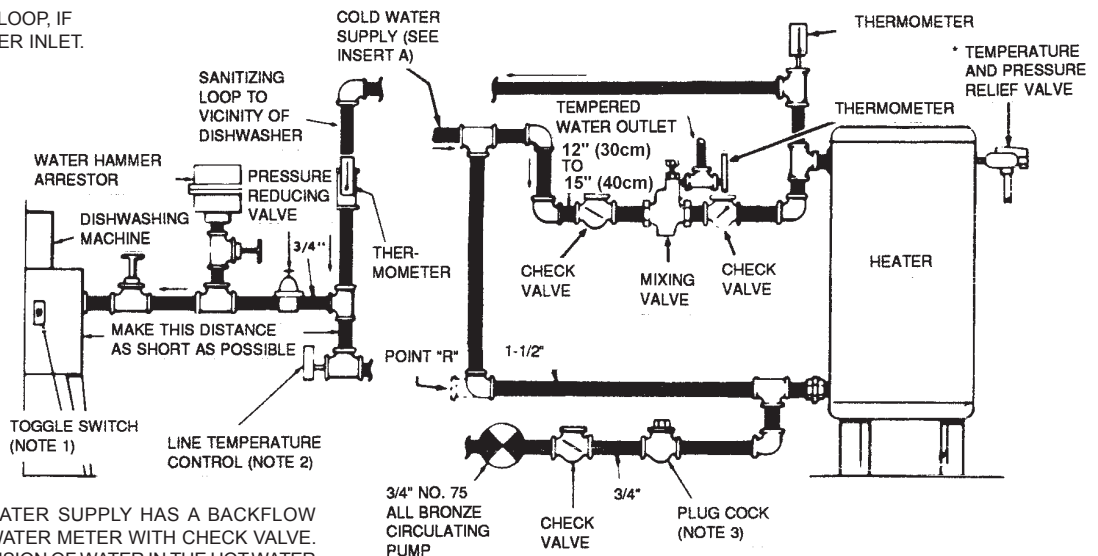
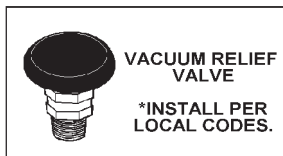

CAUTION: IF BUILDING COLD WATER SUPPLY HAS A BACKFLOW PREVENTER, CHECK VALVE OR WATER METER WITH CHECK VALVE. PROVISIONS FOR THERMAL EXPANSION OF WATER IN THE HOT WATER SYSTEM MUST BE PROVIDED.

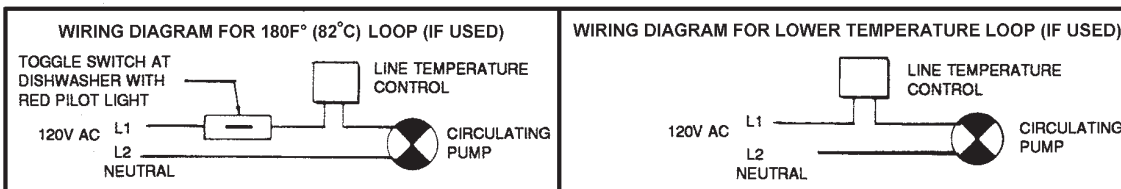

# TWO TEMPERATURE - TWO PRE-HEATERS WITH MIXING VALVE OR BOOSTER HEATER WITH OR WITHOUT BUILING RECIRCULATION

## TWO PRE-HEATERS WITH MIXING VALVE

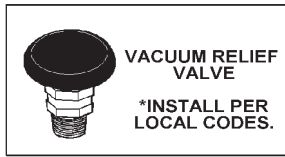

TEMPERATURE SETTING SHOULD NOT EXCEED SAFE USE TEMPERATURE AT FIXTURES. SEE WATER TEMPERATURE CONTROL WARNING ON PAGE 25. IF HIGHER PREHEAT TEMPERATURES ARE NECESSARY TO OBTAIN ADEQUATE BOOSTER OUTPUT, ADD AN ANTI-SCALD VALVE FOR HOT WATER SUPPLIED TO FIXTURES.

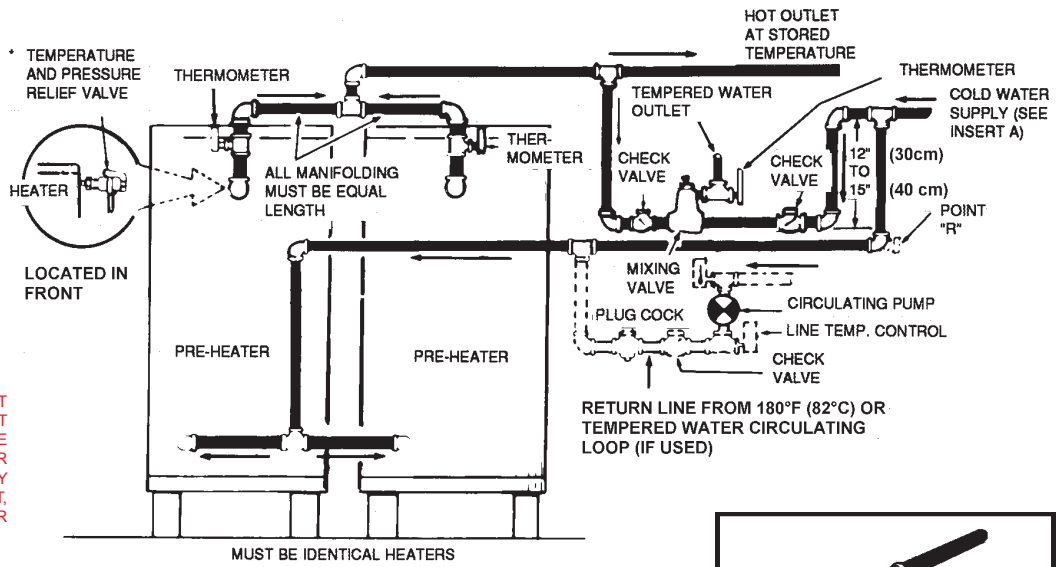

CIRCULATING RETURN CONNECTIONS  
TEMPERED WATER LOOP, IF USED, CONNECT TO POINT "R"

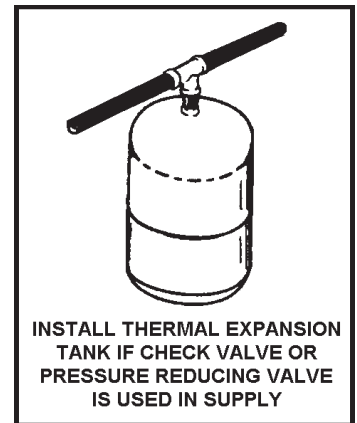

## TWO PRE-HEATERS WITH BOOSTER HEATER

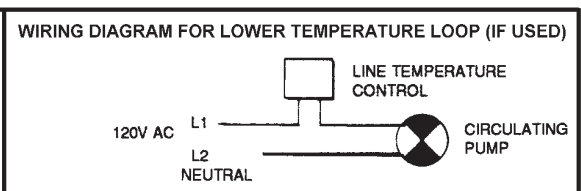
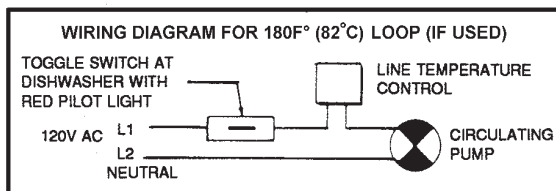
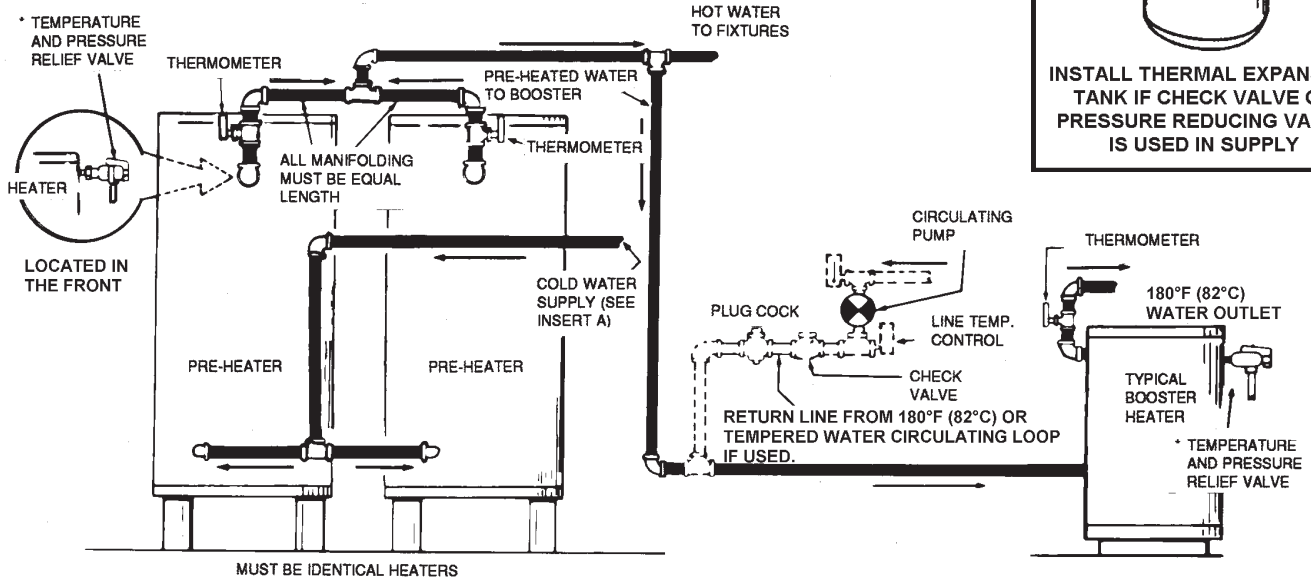

# MEDIUM TEMPERATURE - ONE HEATER WITH AUXILIARY STORAGE TANK FORCED CIRCULATION WITH OR WITHOUT BUILDING RECIRCULATION

## VERTICAL STORAGE TANK

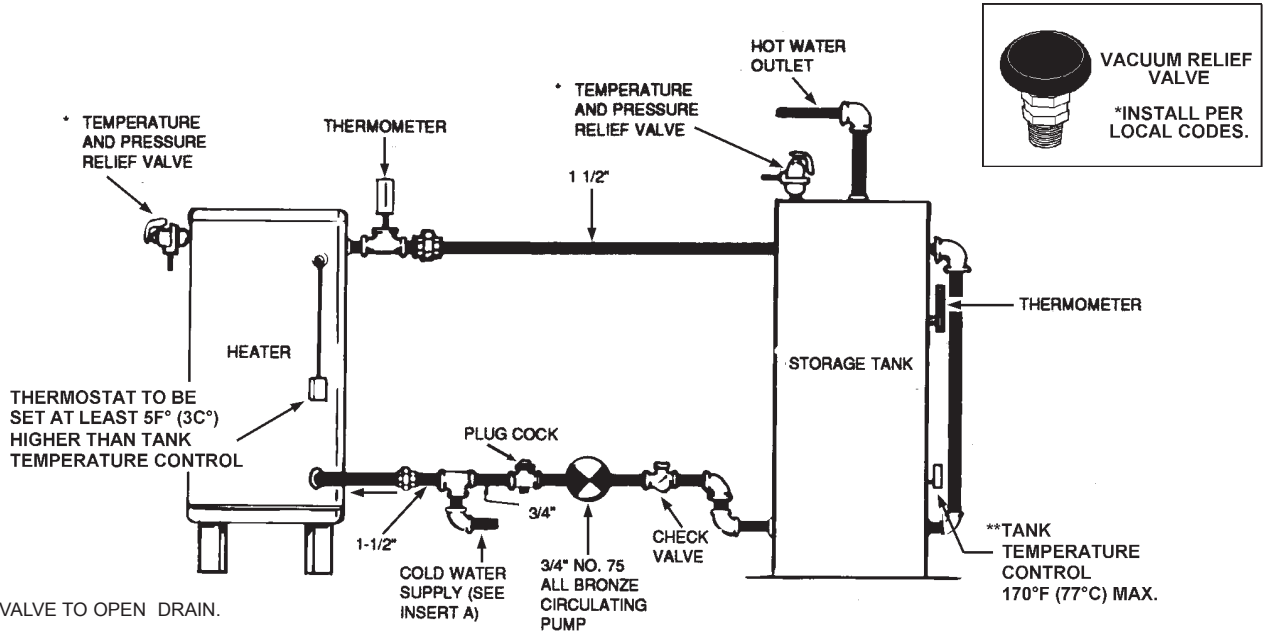

\* PIPE RELIEF VALVE TO OPEN DRAIN.

\*\*WHEN USING A STATE T-140, -200, -350 OR -400 STORAGE TANK, USE LOWER 3/4" OPENING FOR TANK TEMPERATURE CONTROL.

IF BUILDING CIRCULATING LOOP IS USED, CONNECT TO AN OPENING NEAR THE BOTTOM OF THE TANK.

## HORIZONTAL STORAGE TANK

CAUTION: IF BUILDING COLD WATER SUPPLY HAS A BACKFLOW PREVENTER, CHECK VALVE OR WATER METER WITH CHECK VALVE. PROVISIONS FOR THERMAL EXPANSION OF WATER IN THE HOT WATER SYSTEM MUST BE PROVIDED.

\*PIPE RELIEF VALVE TO OPEN DRAIN INSTALL IN ACCORDANCE WITH LOCAL CODES.

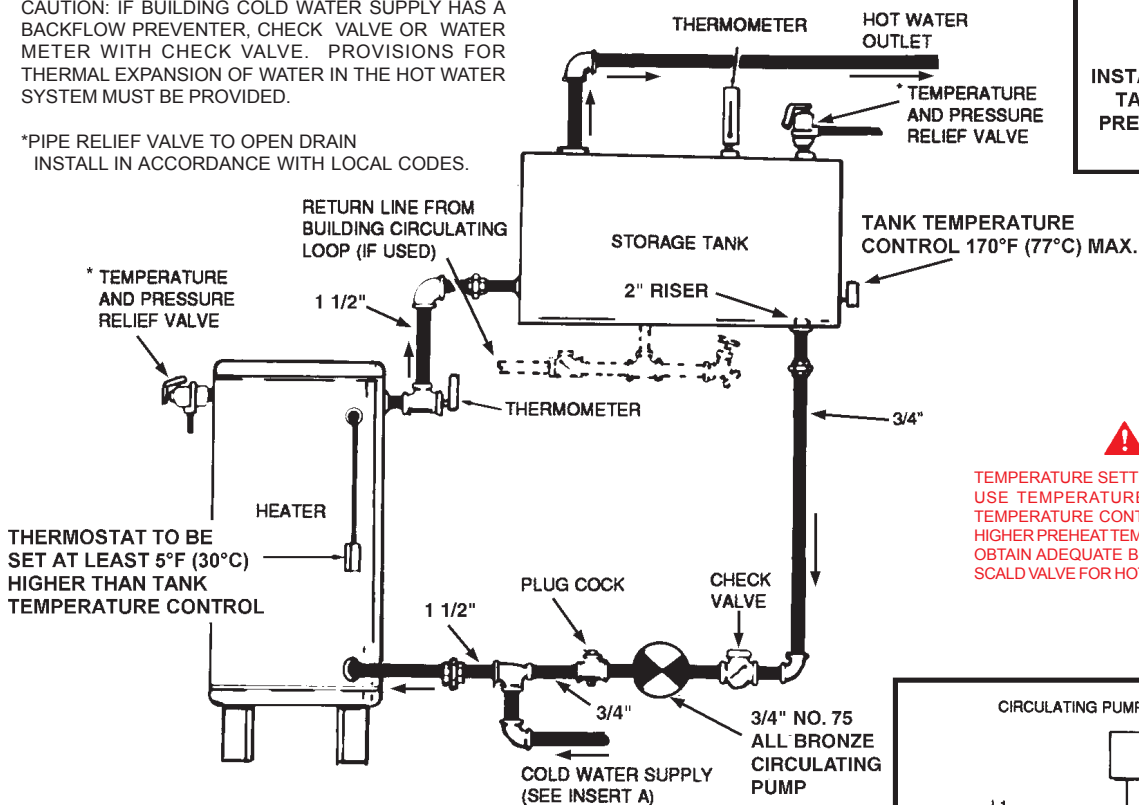

**⚠ DANGER**

TEMPERATURE SETTING SHOULD NOT EXCEED SAFE USE TEMPERATURE AT FIXTURES. SEE WATER TEMPERATURE CONTROL WARNING ON PAGE 25. IF HIGHER PREHEAT TEMPERATURES ARE NECESSARY TO OBTAIN ADEQUATE BOOSTER OUTPUT, ADD AN ANTI-SCALD VALVE FOR HOT WATER SUPPLIED TO FIXTURES.

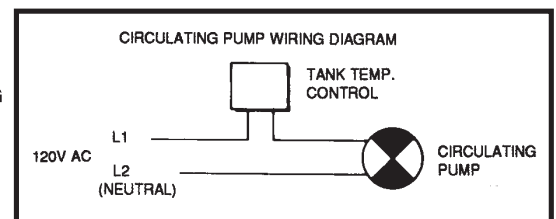



# MANIFOLD KITS

## TWO UNIT MANIFOLD KIT (PART NO. 78692)

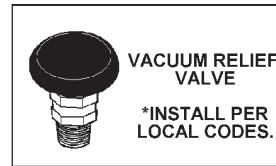
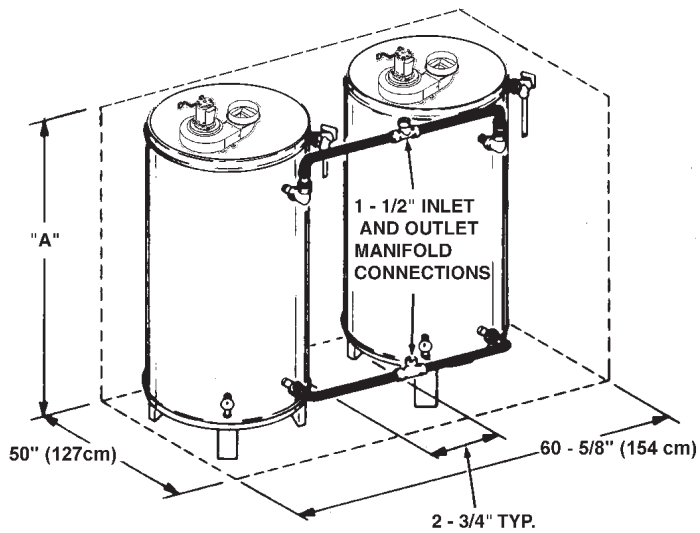

MODEL	DIMENSION "A"
SBN71120NE	63"
SBN81154NE	68"
SBN100180NE	72"
SBN100199NE	72"
SBN100250NE	72"
SBN100275NE	72"
SBN85310NE	73"
SBN85366NE	73"
SBN85390NE	73"

## THREE UNIT MANIFOLD KIT (PART NO. 78593)

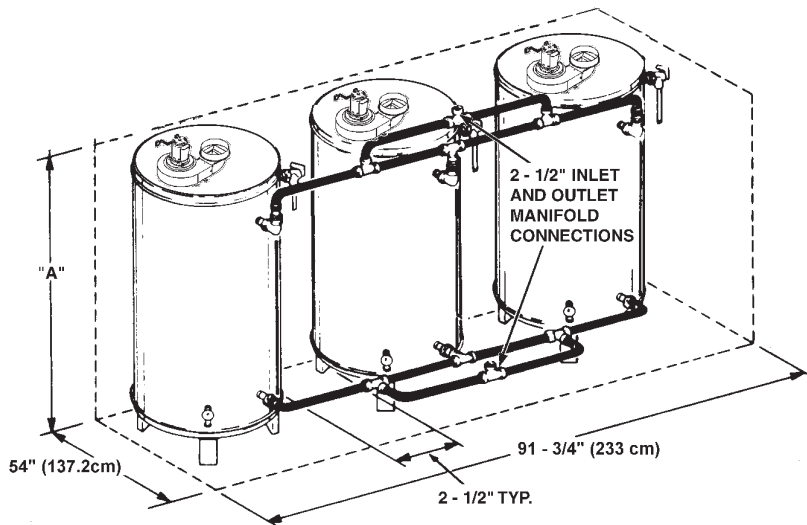

## FOUR UNIT MANIFOLD KIT (PART NO. 78694)

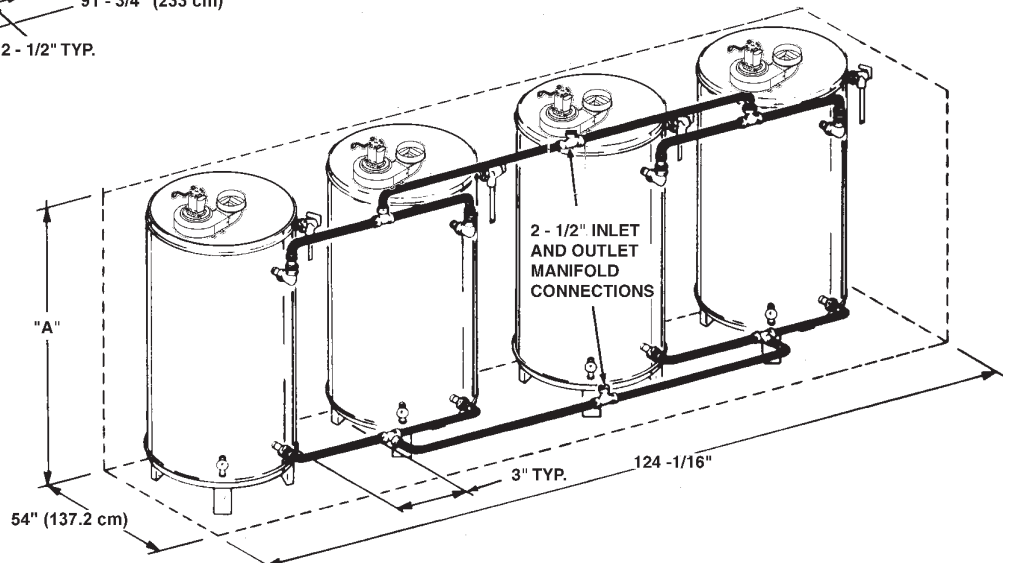

## HEATER WIRING

All electrical work must be installed in accordance with the latest version of the National Electrical Code ANSI/NFPA No. 70, must conform to all local code authority having jurisdiction. **AN ELECTRICAL GROUND IS REQUIRED TO REDUCE RISK OF ELECTRICAL SHOCK OR POSSIBLE ELECTROCUTION.**

If any of the original wire as supplied with the appliance must be replaced, use only type 105°C thermoplastic or equivalent. 250°C type F must be used for the flame sensor leads and the spark ignition cable must be high voltage 250°C.

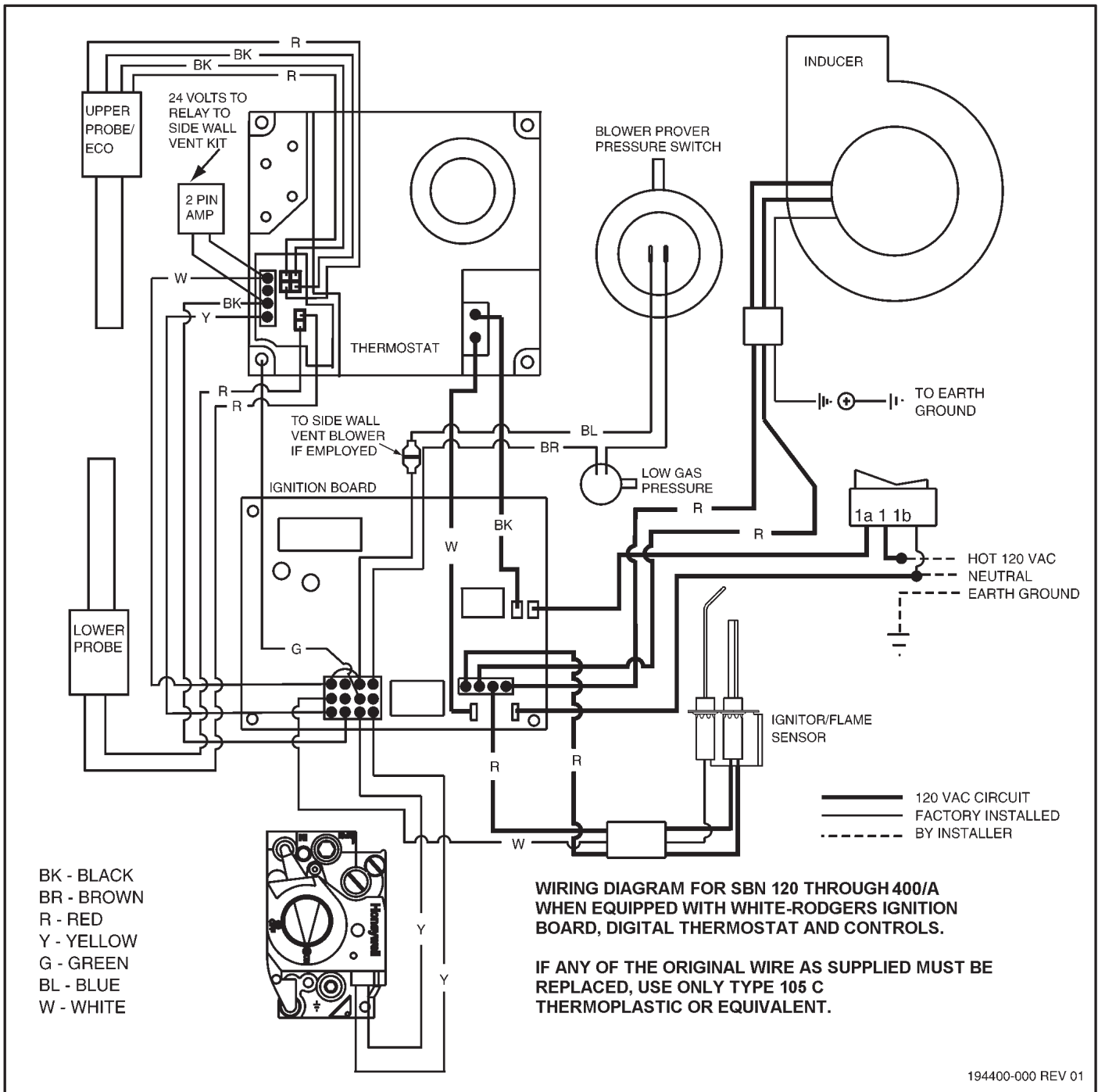

**FIGURE 10 - SINGLE UNIT WIRING DIAGRAM SBN-120 THROUGH 400A**

## GAS PIPING

Contact your local gas service company to ensure that adequate gas service is available and to review applicable installation codes for your area.

Size the main gas line in accordance with Table 7. The figures shown are for straight lengths of pipe at 0.5 in. W.C. pressure drop, which is considered normal for low pressure systems. Note: Fittings such as elbows, tees and line regulators will add to the pipe pressure drop. Also refer to the latest version of the National Fuel Gas Code.

### ! WARNING

THE HEATER IS NOT INTENDED FOR OPERATION AT HIGHER THAN 14.0" W.C.- NATURAL GAS, (1/2 POUND PER SQUARE INCH GAGE) SUPPLY GAS PRESSURE. EXPOSURE TO HIGHER SUPPLY PRESSURE MAY CAUSE DAMAGE TO THE GAS VALVE WHICH COULD RESULT IN FIRE OR EXPLOSION. IF OVERPRESSURE HAS OCCURRED SUCH AS THROUGH IMPROPER TESTING OF GAS LINES OR EMERGENCY MALFUNCTION OF THE SUPPLY SYSTEM, THE GAS VALVE MUST BE CHECKED FOR SAFE OPERATION. MAKE SURE THAT THE OUTSIDE VENTS ON THE SUPPLY REGULATORS AND THE SAFETY VENT VALVES ARE PROTECTED AGAINST BLOCKAGE. THESE ARE PARTS OF THE GAS SUPPLY SYSTEM, NOT THE HEATER. VENT BLOCKAGE MAY OCCUR DURING ICE STORMS.

**TABLE 7 - GAS SUPPLY LINE SIZES (IN INCHES)\*  
MAXIMUM CAPACITY OF PIPE IN  
CUBIC FEET PER HOUR**

LENGTH IN FEET	NOMINAL IRON PIPE SIZES (INCHES)								
	1/2"	3/4"	1"	1 1/4"	1 1/2"	2"	2 1/2"	3"	4"
10	175	360	680	1400	2100	3960	6300	11000	23000
20	120	250	465	950	1460	2750	4360	7700	15800
30	97	200	375	770	1180	2200	3520	6250	12800
40	82	170	320	660	990	1900	3000	5300	10900
50	73	151	285	580	900	1680	2650	4750	9700
60	66	138	260	530	810	1520	2400	4300	8800
70	61	125	240	490	750	1400	2250	3900	8100
80	57	118	220	460	690	1300	2050	3700	7500
90	53	110	205	430	650	1220	1950	3450	7200
100	50	103	195	400	620	1150	1850	3250	6700
125	44	93	175	360	550	1020	1650	2950	6000
150	40	84	160	325	500	950	1500	2650	5500
175	37	77	145	300	460	850	1370	2450	5000
200	35	72	135	280	430	800	1280	2280	4600

IT IS IMPORTANT TO GUARD AGAINST GAS VALVE FOULING FROM CONTAMINANTS IN THE GAS WAYS. SUCH FOULING MAY CAUSE IMPROPER OPERATION, FIRE OR EXPLOSION.

IF COPPER SUPPLY LINES ARE USED THEY MUST BE INTERNALLY TINNED AND CERTIFIED FOR GAS SERVICE. BEFORE ATTACHING THE GAS LINE, BE SURE THAT ALL GAS PIPE IS CLEAN ON THE INSIDE.

TO TRAP ANY DIRT OR FOREIGN MATERIAL IN THE GAS SUPPLY LINE, A DIRT LEG (SOMETIMES CALLED SEDIMENT TRAP OR DRIP LEG) MUST BE INCORPORATED IN THE PIPING (SEE FIG. 11). THE DIRT LEG MUST BE READILY ACCESSIBLE AND NOT SUBJECT TO FREEZING CONDITIONS. INSTALL IN ACCORDANCE WITH RECOMMENDATIONS OF SERVING GAS SUPPLIERS. REFER TO THE LATEST VERSION OF THE NATIONAL FUEL GAS CODE.

To prevent damage, care must be taken not to apply too much torque when attaching gas supply pipe to gas valve inlet.

Apply joint compounds (pipe dope) sparingly and only to the male threads of pipe joints. Do not apply compounds to the first two threads. Use compounds resistant to the action of liquefied petroleum gases.

**BEFORE PLACING THE HEATER IN OPERATION, CHECK FOR GAS LEAKAGE.** Use soap and water solution or other material acceptable for the purpose in locating the leaks. **DO NOT USE MATCHES, CANDLES, FLAME OR OTHER SOURCES OF IGNITION FOR THIS PURPOSE.**

**DISCONNECT THE HEATER AND ITS MANUAL GAS SHUTOFF VALVE FROM THE GAS SUPPLY PIPING SYSTEM DURING ANY SUPPLY PRESSURE TESTING EXCEEDING 1/2 PSIG. GAS SUPPLY LINE MUST BE CAPPED WHEN DISCONNECTED FROM THE HEATER FOR TEST PRESSURES OF 1/2 PSIG OR LESS. THE APPLIANCE NEED NOT BE DISCONNECTED, BUT MUST BE ISOLATED FROM THE SUPPLY PRESSURE TEST BY CLOSING THE MANUAL GAS SHUTOFF VALVE.**

### GAS PIPING AND DIRT LEG INSTALLATION

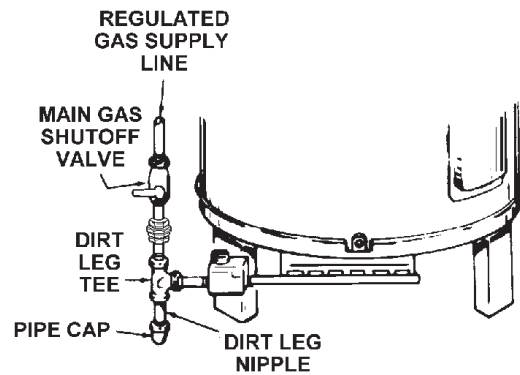

FIGURE 11

### PURGING

Gas line purging is required with new piping or systems in which air has entered.

### ! CAUTION

**PURGING SHOULD BE PERFORMED BY PERSONS EXPERIENCED IN THIS TYPE GAS SERVICE. TO AVOID RISK OF FIRE OR EXPLOSION, PURGE DISCHARGE MUST NOT ENTER CONFINED AREAS OR SPACES WHERE IGNITION CAN OCCUR. THE AREA MUST BE WELL VENTILATED AND ALL SOURCES OF IGNITION MUST BE INACTIVATED OR REMOVED.**

### GAS METER SIZE — NATURAL GASES ONLY

Be sure the gas meter has sufficient capacity to supply the full rated gas input of the water heater as well as the requirements of all other gas fired equipment supplied by the meter. If gas meter is too small, ask the gas company to install a larger meter having adequate capacity.

### GAS PRESSURE REGULATOR

The gas pressure regulator is built into the gas valve and is equipped to operate on the gas specified on model and rating plate. The regulator is factory adjusted to deliver gas to burner at

correct water column pressure allowing for a nominal pressure drop through the controls.

The minimum gas supply pressure for input adjustment must not be less than 4.5" w.c. (1.12 kPa) for natural gas.

Do not subject the combination gas valve to inlet gas pressures of more than 14.0" W.C. (3.48 kPa) - natural gas. A service regulator is necessary if higher gas pressures are encountered.

Gas pressure specified in Table 4, refer to flow pressure taken at pressure tap of automatic gas valve while heater is operating.

**TABLE 8  
MANIFOLD GAS PRESSURE IN INCHES  
OF WATER COLUMN (ALL MODELS\*)**

TYPE OF GAS
Natural
3.5 (0.87 kPa)

**TABLE 9  
APPROXIMATE TIME REQUIRED TO CONSUME  
1 CU. FT. OF GAS AT FULL CAPACITY**

INPUT RATE (BTUH)	TYPE OF GAS	BTUH PER 1 CU. FT.	TIME REQ'D TO CONSUME CU. FT. OF GAS
120,000	NATURAL	1050	31.5 SEC.
154,000	NATURAL	1050	24.5 SEC.
180,000	NATURAL	1050	21.1 SEC.
199,000	NATURAL	1050	19.0 SEC.
190,000	NATURAL	1050	20.1 SEC.
250,000	NATURAL	1050	15.1 SEC.
275,000	NATURAL	1050	13.75 SEC.
310,000	NATURAL	1050	12.4 SEC.
366,000	NATURAL	1050	10.4 SEC.
390,000	NATURAL	1050	9.5 SEC.

Figures shown are valid for 0-2000 ft. installations. See "HIGH ALTITUDE INSTALLATIONS" for deration requirements over 2000 ft.

## OPERATION

### IMPORTANT

A qualified person must perform the initial firing of the heater. At this time the user should not hesitate to ask the individual any questions which they may have in regard to the operation and maintenance of the unit.

An Operational Checklist is included at the rear of this manual. By using this checklist the user may be able to make minor operational adjustments and avoid unnecessary service calls. However, the user should not attempt repairs which are not listed under the USER column.

### GENERAL

NEVER OPERATE THE HEATER WITHOUT FIRST BEING CERTAIN IT IS FILLED WITH WATER AND A TEMPERATURE

AND PRESSURE RELIEF VALVE IS INSTALLED IN THE RELIEF VALVE OPENING OF THE HEATER.

SHOULD OVERHEATING OCCUR OR THE GAS SUPPLY FAIL TO SHUT OFF, TURN OFF THE MANUAL GAS CONTROL VALVE TO THE APPLIANCE.

### CAUTION

Before proceeding with the operation of the unit make sure the water heater and system are filled with water and all air is expelled.

### FILLING

1. Close the heater drain valve by turning handle clockwise.
2. Open a nearby hot water faucet to permit the air in the system to escape.
3. Fully open the cold water inlet pipe valve allowing the heater and piping to be filled.
4. Close the hot water faucet as water starts to flow.
5. The heater is ready to be operated.

### WARNING

THE GAS VALVE MUST HAVE BEEN IN THE OFF POSITION FOR AT LEAST 5 MINUTES. This waiting period is an important safety step. Its purpose is to permit gas that may have accumulated in the combustion chamber to clear. IF YOU DETECT GAS ODOR AT THE END OF THIS PERIOD DO NOT PROCEED WITH LIGHTING. RECOGNIZE THAT GAS EVEN IF IT SEEMS WEAK, MAY INDICATE PRESENCE OF ACCUMULATED GAS SOMEPLACE IN THE AREA WITH RISK OF FIRE OR EXPLOSION. SEE THE FRONT PAGE FOR STEPS TO BE TAKEN.

All gas and water lines leak tested and open.

Read **SEQUENCE OF OPERATION** section of this manual prior to lighting and operating this appliance.

With above conditions satisfied, start the unit in accordance with the instructions on the operating label attached to the heater. For your convenience a copy of the instructions are shown of page 24. Each heater is equipped with an ignition control board. The controller will try three times to light the main burner before going into lockout. After the controller tries three times, it will wait one hour before trying to light the unit again. This cycle will continue until the main burners are ignited or the unit is shut down.

### ADJUSTMENTS

ON INITIAL STARTUP SOME ADJUSTMENTS ARE NECESSARY.

1. CHECK MANIFOLD AND INLET GAS PRESSURES.
2. CYCLE CHECK - CHECK AT LEAST ONE BURNER OPERATION - WHEN THERMOSTAT IS SATISFIED, BURNER WILL SHUT OFF AND INDUCER WILL STOP RUNNING. ON CALL FOR HEAT - THE INDUCER WILL COME ON AND CLOSE THE PRESSURE SWITCH AND THE IGNITION SEQUENCE DESCRIBED ABOVE WILL BEGIN, SEE "SEQUENCE OF OPERATION".

# SEQUENCE OF OPERATION

---

The following information will describe the Sequence of Operation for this appliance.

1. Switch power on to unit.
2. Thermostat calls for heat.
3. Ignition Control Board performs diagnostic check on system components.
4. On completion of diagnostics check, the Ignition Control Board sends signal to Exhaust Inducer.
5. Exhaust Inducer begins drawing air through appliance closing the Prover Switch.
6. On completion of Prover Switch engagement, the Ignition Control Board begins the ignition cycle.
7. The Ignition Control Board provides power to the Silicon Nitride Ignitor.
8. The Silicon Nitride Ignitor heats up for approximately 17 to 20 seconds.
9. At the end of Silicon Nitride Ignitor's warm-up, the Ignition Control Board opens the Gas Valve.
10. From the time the Gas Valve opens, the Ignition Control Board waits 3 seconds and then shuts off power to the Silicon Nitride Ignitor.
11. From the time the Silicon Nitride Ignitor's power is shut off, the Ignition Control Board waits 3 more seconds to monitor the Flame Sensor.
12. If the Flame Sensor does not detect a strong enough flame, the Ignition Control Board shuts off the Gas Valve and allows the Exhaust Inducer to purge the unit for 20 seconds. At that time, the Ignition Control Board restarts with step 7. It will try and ignite the main burners 2 more times. If the unit does not light, the Ignition Control Board will wait one hour and then restart at step 3. This cycle will continue until the unit lights or the power is shutoff to the unit.
13. If the Flame Sensor detects a strong flame, the Ignition Control Board will allow the unit to operate until the thermostat is satisfied.
14. Once the unit is satisfied, the Ignition Control Board will shut off the Gas Valve and the unit will be in standby mode until another call for heat is initiated by the thermostat.

See the flow chart on page 31 for more information.



## LIGHTING AND OPERATION INSTRUCTIONS

### FOR YOUR SAFETY READ BEFORE OPERATING







**WARNING** IF YOU DO NOT FOLLOW THESE INSTRUCTIONS EXACTLY A FIRE OR EXPLOSION MAY RESULT CAUSING PROPERTY DAMAGE, PERSONAL INJURY OR LOSS OF LIFE.



- A. This appliance does not have a pilot. It is equipped with an ignition device which automatically lights the burner. Do not try to light the burner by hand.
- B. BEFORE OPERATING smell all around the appliance area for gas. Be sure to smell next to the floor because some gas is heavier than air and will settle on the floor.  
  
"WHAT TO DO IF YOU SMELL GAS"
  - Do not try to light any appliance.
  - Do not touch any electric switch; do not use any telephone in your building.
  - Immediately call your gas supplier from a neighbor's telephone. Follow the gas supplier's instructions.
- C. If you cannot reach your gas supplier, call the fire department.
- D. Use only your hand to push in or turn the gas control knob. Never use tools. If the knob will not push in or turn by hand, don't try to repair it, call a qualified service technician. Force or attempted repair may result in fire or explosion.
- E. Do not use this appliance if any part has been under water. Immediately call a qualified service technician to inspect the appliance and to replace any part of the control system and any gas control which has been under water.

### OPERATING INSTRUCTIONS

1.  STOP! Read the safety information above on this label.
2. Set thermostat to lowest setting.
3. Turn off all electric power to the appliance.
4. This appliance is equipped with an ignition device which automatically lights the burner. Do not try to light the burner by hand.
5. Push in gas control knob slightly and turn clockwise  to "OFF".
6. Wait five (5) minutes to clear out any gas. If you then smell gas,  STOP! Follow "B" in the safety information  above on this label. If you don't smell gas, go on to the next step.
7. Turn gas control knob counterclockwise  to "ON".
8. Turn on all electric power to the appliance.
9. Set thermostat to desired setting.
10. If the appliance will not operate, follow the instructions "To Turn Off Gas To Appliance" and call your service technician or gas supplier.

GAS CONTROL KNOB

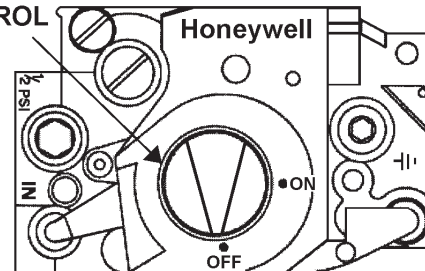

### FOR YOUR SAFETY READ BEFORE OPERATING

1. Set the thermostat to lowest setting.
2. Turn off all electric power to appliance if service is to be performed.
3. Push in gas control knob slightly and turn clockwise  to "OFF". Do not force.

## WATER TEMPERATURE CONTROL

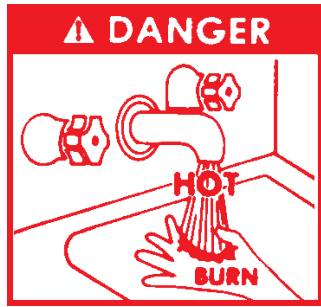

### **! DANGER**

THIS WATER HEATER IS EQUIPPED WITH AN ADJUSTABLE THERMOSTAT TO CONTROL WATER TEMPERATURE. HOT WATER TEMPERATURES REQUIRED FOR AUTOMATIC DISHWASHER AND LAUNDRY USE CAN CAUSE SCALD BURNS RESULTING IN SERIOUS PERSONAL INJURY AND/OR DEATH. THE TEMPERATURE AT WHICH INJURY OCCURS VARIES WITH THE PERSON'S AGE AND TIME OF EXPOSURE. THE SLOWER RESPONSE TIME OF CHILDREN, AGED OR DISABLED PERSONS INCREASES THE HAZARDS TO THEM. NEVER ALLOW SMALL CHILDREN TO USE A HOT WATER TAP, OR TO DRAW THEIR OWN BATH WATER. NEVER LEAVE A CHILD OR DISABLED PERSON UNATTENDED IN A BATHTUB OR SHOWER.

THE WATER HEATER SHOULD BE LOCATED IN AN AREA WHERE THE GENERAL PUBLIC DOES NOT HAVE ACCESS TO SET TEMPERATURES.

SETTING THE WATER HEATER TEMPERATURE AT 120°F (49°C) WILL REDUCE THE RISK OF SCALDS. Some states or provinces require settings at specific lower temperatures.

Below you will find listed the approximate time-to-burn relationship for normal adult skin. Short repeated heating cycles caused by small hot water uses can cause temperatures at the point of use to exceed the thermostat setting by up to 20F°. If you experience this type of use, you should consider using lower temperature settings to reduce scald hazards.

Temperature Setting	Time to Produce 2nd & 3rd Degree Burns on Adult
180°F (82°C)	Nearly instantaneous
170°F (77°C)	Nearly instantaneous
160°F (71°C)	About 1/2 second
150°F (66°C)	About 1-1/2 seconds
140°F (60°C)	Less than 5 seconds
130°F (54°C)	About 30 seconds
120°F (49°C)	More than 5 minutes

Valves for reducing point-of-use temperature by mixing cold and hot water are available. Also available are inexpensive devices that attach to faucets to limit hot water temperatures. Contact a licensed plumber or the local plumbing authority.

The water temperature is controlled by a thermostat, fig. 2, which has two sensing elements. One sensor is located near the top of the tank and the other is near the center. The thermostat is set in the lowest position before the heater leaves the factory.

The thermostat temperature dial, fig. 2, is accessible by removing the control cover. The dial is adjustable and may be set for 120° (49°C) to 180°F (82°C) water temperature, but 120°F (49°C) is the recommended starting point. It is suggested the dial be

placed on the lowest setting which produces an acceptable hot water supply. This will always give the most energy efficient operation. The temperature control has a 4°F fixed differential.

## CHECKING VENTING

The following steps shall be followed with each appliance connected to the venting system placed in operation, while any other appliances connected to the venting system are not in operation.

1. Seal any unused openings in the venting system.
2. Inspect the venting system for proper size and horizontal pitch, as required in the National Fuel Gas Code, ANSI Z223.1 or the CAN/CGA B149 Installation Codes and these instructions. Determine that there is no blockage or restriction, leakage, corrosion and other deficiencies which could cause an unsafe condition.
3. So far as is practical, close all building doors and windows and all doors between the space in which the water heater(s) connected to the venting system are located and other spaces of the building. Turn on all appliances not connected to the venting system. Turn on all exhaust fans, such as range hoods and bathroom exhausts, so they shall operate at maximum speed. Close fireplace dampers.
4. Follow the lighting instruction. Place the water heater being inspected in operation. Adjust thermostat so appliance shall operate continuously.
5. Test for spillage at the burner level after 5 minutes of main burner operation.
6. After it has been determined that each SBN connected to the venting system properly vents when tested as outlined above, return doors, windows, exhaust fans, fireplace dampers and any other gas burning appliance to their previous conditions of use.
7. If improper venting is observed during any of the above tests, the venting system must be corrected.

### **! WARNING**

FAILURE TO CORRECT BACK DRAFTS MAY CAUSE AIR CONTAMINATION AND UNSAFE CONDITIONS.

- If the back draft cannot be corrected by the normal method or if a suitable draft cannot be obtained, a blower type flue gas exhauster must be employed to assure proper venting and correct combustion.

## PREVENTIVE MAINTENANCE

### CHECK THE IGNITOR ASSEMBLY

At least once a year, check the ignitor assembly, Fig. 12, and the main burner, Fig. 13, for proper operation. Refer to the following ignitor assembly and main burner sections.

### IGNITOR ASSEMBLY

For access to ignitor assembly, unfasten two screws to burner cover and remove. Locate the burner with the ignitor assembly and remove screw holding burner to manifold. Slide burner out to access ignitor assembly.

Servicing of the ignitor assembly includes keeping the ignitor free of lint, scale or any other foreign debris.

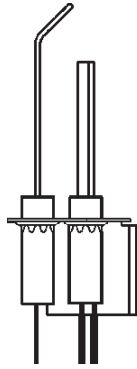

FIGURE 12,IGNITOR

## MAIN BURNER

The main burner, fig.13, should display the following characteristics:

- Cause rapid ignition and carry across entire burner.
- Give reasonably quiet operation during ignition, burning, and extinction.
- Cause no excessive lifting of flame from burner ports.

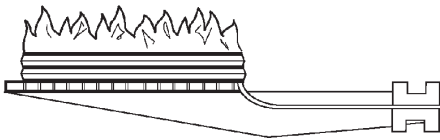

FIGURE 13

If the preceding burner characteristics are not evident, check for accumulation of lint, scale or other foreign debris that restricts or blocks the air openings to the burner or heater.

NOTE:

1. Remove main burners from unit.
2. Check that burner venturi and ports are free of foreign debris.
3. Clean burners with bristle brush and/or vacuum cleaner - DO NOT distort burner ports or pilot location.
4. Reinstall burners in unit. Make sure front and rear of burners are installed correctly in burner support brackets.
5. Check flame inserts. Make sure there is no bending or cracking and that they are free from lint, scale or any foreign material.

Also check for good flow of combustion and ventilating air to the unit. Maintain a clear area around the heater at all times.

## GAS VALVES

Figure 14 shows the type of combination manual gas control valve and regulator used on these heaters.

If the gas valve becomes defective, repairs should not be attempted. A new valve should be installed in place of the defective one.

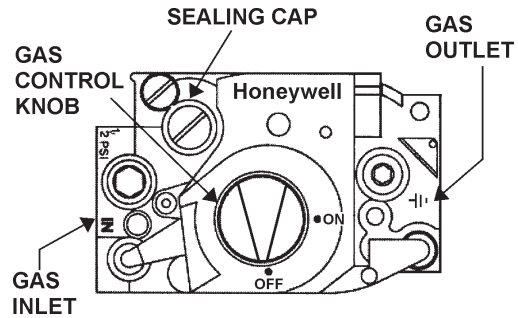

FIGURE 14

## CHECKING THE INPUT

For appliance installation locations with elevations above 2000 feet, refer to HIGH ALTITUDE INSTALLATIONS section of this manual for input reduction procedure.

1. Attach a pressure gauge or a manometer to the manifold pressure tap on the gas valve and refer to Table 3, for correct manifold pressure.
2. Use this formula to "clock" the meter. Be sure that other gas consuming appliances are not operating during this interval.

$$3600 \times \frac{H}{T} = \text{Btuh}$$

T = Time in seconds to burn one cubic foot of gas.

H = Btu's per cubic foot of gas.

Btuh = Actual heater input.

Example: (Using SBN-250 heater)

T = 15.1 seconds

H = 1050 Btu

Btuh = ?

$36.8 \times 1050 = 250,000 \text{ Btuh}$  (Compare with the SBN 250 model and rating.)

Should it be necessary to adjust the gas pressure to the burners to obtain the full input rate, the steps below should be followed:

3. Remove the regulator adjustment sealing cap, fig. 14, and adjust the pressure by turning the adjusting screw with a screwdriver.
  - ↻ Clockwise to increase gas pressure and input rate.
  - ↻ Counterclockwise to decrease gas pressure and input rate.
4. "Clock" the meter as in step 2 above.
5. Repeat steps 3 and 4 until the specified input rate is achieved.
6. Turn the gas control knob to PILOT. Remove the pressure gauge and replace the sealing cap and the allen wrench set screw in the pressure tap opening.



**WARNING**

**UNDER NO CIRCUMSTANCES SHOULD THE GAS INPUT EXCEED THE INPUT SHOWN ON THE HEATER MODEL AND RATING PLATE. OVERFIRING COULD RESULT IN DAMAGE OR SOOTING OF THE HEATER.**

When the heater is operating at full capacity, or full gas input, it should consume 1 cu. ft. of gas in time indicated on Table 9.

## VENTING SYSTEM

Examine the venting system every six months for obstructions and/or deterioration of the vent piping.

Remove all soot or other obstructions from chimney which will retard free draft.

## REMOTE STORAGE TANK TEMPERATURE CONTROL

The water temperature in the remote storage tank (if used) is controlled by the storage tank temperature control. The sensing element is mounted in the hot water storage tank, see page 13.

A change in water temperature in the storage tank lower than the tank temperature control setting will cause the sensor to activate the circulating pump. The pump then circulates the water through the heater where the thermostat senses the drop in water temperature and activates main burner operation of the appliance. If the storage tank temperature control is out of calibration, replace with new control.



### WARNING

SHOULD OVERHEATING OCCUR OR THE GAS SUPPLY FAIL TO SHUT OFF, TURN OFF THE MANUAL GAS CONTROL VALVE TO THE APPLIANCE.

## RELIEF VALVE

At least once a year, the temperature and pressure relief valve should be checked to ensure that it is in operating condition. Lift the lever at the top of the valve several times until the valve seats properly and operates freely.

If the appliance installation includes other relief valves, such as in "remote" storage tanks etc., check their relief valve operation with the same frequency.



### WARNING

THE WATER PASSING OUT OF THE VALVE DURING THIS CHECKING OPERATION MAY BE EXTREMELY HOT. AVOID CONTACT AND DISCHARGE SAFELY TO PREVENT WATER DAMAGE.

If the temperature and pressure relief valve on the heater discharges periodically or continuously, a problem exists. This may be due to unusually high water temperatures or pressures in the system, or to a faulty relief valve. Contact your dealer or a qualified service technician to find the cause of the problem and to correct it. This may also be due to thermal expansion in a closed water supply system. Contact the water supplier or local plumbing inspector on how to correct this situation. **DO NOT PLUG THE TEMPERATURE AND PRESSURE RELIEF VALVE.**



### WARNING

SHOULD OVERHEATING OCCUR OR THE GAS SUPPLY FAIL TO SHUT OFF, TURN OFF THE MANUAL GAS CONTROL VALVE TO THE APPLIANCE.

## HOT WATER ODOR

On occasion, hot water may develop a strong odor. If this occurs drain the heater completely, flush thoroughly, and refill. If the

problem persists, chlorination of the heater and replacement of the factory installed magnesium anodes with aluminum anodes may correct the condition.

Occasionally water softener companies recommend removal of heater anodes for odor reasons.



### CAUTION

Unauthorized removal of the anode(s) will void the warranty. For further information contact your dealer.

## ANODE ROD INSPECTION

The heater tank is equipped with anode rods to provide corrosion control. At least once a year the anode rods should be checked to determine if replacement is necessary. Initially the anode rods are approximately 7/8" in diameter with a 1/8" diameter steel core wire running down the center of the anode material. THE ANODES SHOULD BE REPLACED when the 1/8" diameter core wire is visible as this means that the anode material has been expended in the control of corrosion.

For models with top inlet and outlet, it is recommended that, before removing the inner cover for cleaning, inspection or removal of inner parts, you obtain two new nipple collars, part no. 74060. The nipple collars on the heater will usually be damaged when removed. New pipe collars will insure that the seal is such as to prevent leakage of flue products when properly installed.

**NOTE:** Anode rod inspection may need to be made more frequently in areas subject to acid rain that obtains their water supply from surface water as the low pH will accelerate anode activity.

**CAUTION:** Close cold water inlet valve serving heater and open nearby hot water faucet to relieve the pressure in the heater before attempting to remove anode(s) for inspection.

## FLUSHING

1. Turn off the heater electrical disconnect switch.
2. Open the drain valve and allow water to flow until it runs clean.
3. Close the drain valve when finished flushing.
4. Turn on the heater electrical disconnect switch.

## DRAINING

The heater must be drained if it is to be shut down and exposed to freezing temperatures. Maintenance and service procedures may also require draining the heater.

1. Turn off the heater electrical disconnect switch.
2. Close the cold water inlet valve to heater.
3. Open a nearby hot water faucet to vent the system.
4. Open the heater drain valve.
5. If the heater is being drained for an extended shutdown, it is suggested the drain valve be left open during this period.

- Follow FILLING instructions when restoring hot water service.

## RECOMMENDED PROCEDURE FOR PERIODIC REMOVAL OF LIME DEPOSITS FROM TANK TYPE COMMERCIAL WATER HEATERS

The amount of calcium carbonate (lime) released from water is in direct proportion to water temperature and usage, see chart. The higher the water temperature or water usage, the more lime deposits are dropped out of the water. This is the lime scale which forms in pipes, heaters and on cooking utensils.

Lime accumulation not only reduces the life of the equipment but also reduces efficiency of the heater and increases fuel consumption.

The usage of water softening equipment greatly reduces the hardness of the water. However, this equipment does not always remove all of the hardness (lime). For this reason it is recommended that a regular schedule for deliming be maintained.

The time between cleaning will vary from weeks to months depending upon water conditions and usage.

Refer to State booklet, Form No. 4800, entitled "Why? When and How" for detailed description on tank inspection and cleanout. UN•LIME® and the booklet may be obtained through your State dealer or distributor.

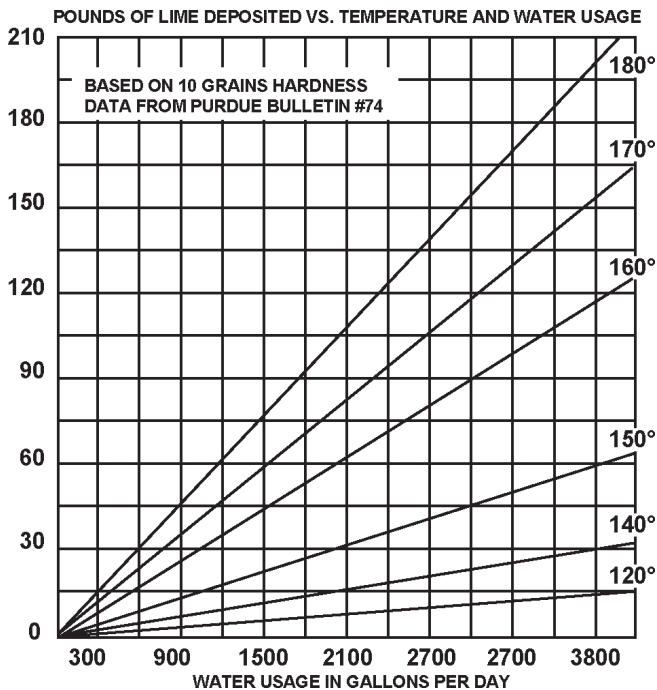

FIGURE 15

### DELIMING SOLVENTS

State recommends the use of UN•LIME for deliming. UN•LIME is a patented food grade acid which is safe to handle and does not create the harmful fumes which are associated with other products.

UN•LIME may be obtained from your dealer, distributor or State Water Heaters. Order Part Number 4763, 1 gallon, packed 4 gallons per case or Part Number 4813, 5 gallon container.

NOTE: UN•Lime is not available for use in Canada.

Hydrochloric base acids are not recommended for use on glass lined tanks.



Observe handling instructions on label of product being used.

### TANK CLEANOUT PROCEDURE

The following practices will ensure longer life and enable the unit to operate at its designed efficiency:

1. Once a month the heater should be flushed. Open the drain valve and allow two gallons of water to drain from the heater. Inlet water valve should remain open to maintain pressure in tank.
2. A cleanout opening is provided for periodic cleaning of the tank. Gas must be shut off and heater drained before opening cleanout.

To clean heater through cleanout opening, proceed as follows:

1. Drain heater.
2. Remove outer cover plate from lower side of heater jacket.
3. Remove six (6) hex head screws securing tank cleanout plate and remove plate.
4. Remove lime, scale, or sediment using care not to damage the glass lining.
5. Inspect cleanout plate gasket, if new gasket is required, replace with State part no. 99038.
6. Install cleanout plate. Be sure to draw plate up tight by tightening screws securely.
7. Replace outer jacket cover plate.

In some water areas the sediment might not be removed by this method and may result in the water heater making rumbling or boiling noises. To dissolve and remove these more stubborn mineral deposits, State UN•LIME Professional Delimer should be used.

### DELIMING USING FLO-JUG METHOD

UN•LIME in the 5 gallon size is recommended for deliming of the SBN-80 100 models. UN•LIME with the necessary hoses and fittings to delime your heater is also available as a kit: Up-N-Down Transfer Kit. Contact your local State dealer, distributor or State Water Heaters.

Prepare the Water Heater

To delime the water heater using the Flo-Jug method, first prepare the heater for deliming as described in the "Why? When? and How?" booklet, Form No. 4800. Then install the long plastic male adapter fitting into the drain valve opening of the water heater. Use teflon tape and hand tighten only. Do not overtighten.

Prepare the Up-N-Down Transfer Kit

The next step is the preparation on the Up-N-Down Transfer Kit, if you have not already done so:

1. With the 5 gallon Up-N-Down container in the vertical position, unscrew the plastic vent cap in the handle and pierce the plastic membrane over the vent boss under the cap to allow the container to vent.



**Note:** If your container does not have the vent cap and vent boss, drill a 3/16" hole in the handle. When you have finished deliming you will be able to plug this drilled vent with the stainless steel screw that is supplied with the kit.

- Remove the container's cap and cut the plastic membrane located in the 3/4" IPT opening in the cap. Take care to not damage the threads.
- Find the 3/4" male adapter, apply teflon tape to the threaded end and screw it into the 3/4" IPT opening in the cap.
- Put cap with male adapter back on the container and slide 3/4" hose over end of male adapter and fasten in place using hose clamp provided.

Delime using Flo-Jug Method

- Slide the hose clamp over end of hose and slide hose over the male adapter in the water heater drain opening and secure in place using hose clamp.
- Lift container to the "Pour" Position, see Figure 16, being careful to keep the vent in the handle above the liquid level and pour the UN•LIME into the heater.
- Lower container, you may have to place the container on its empty carton to prevent the UN•LIME from flowing back into the container.
- Let UN•LIME remain in the heater for 5 minutes and then lower the container to the "Drain" Position, see Figure 16.
- Deliming activity is indicated by foaming on the surface of the UN•LIME. If there is deliming activity, repeat steps 6 thru 8.

Normally, lime removal will be completed within one hour. Severe build-up of lime may take longer than an hour to complete descaling.

Note: To check UN•LIME for continued use, place some scale or white chalk in a glass with a small amount of UN•LIME. If the material is vigorously dissolved by the UN•LIME, it can be reused; if not, the UN•LIME should be replaced.

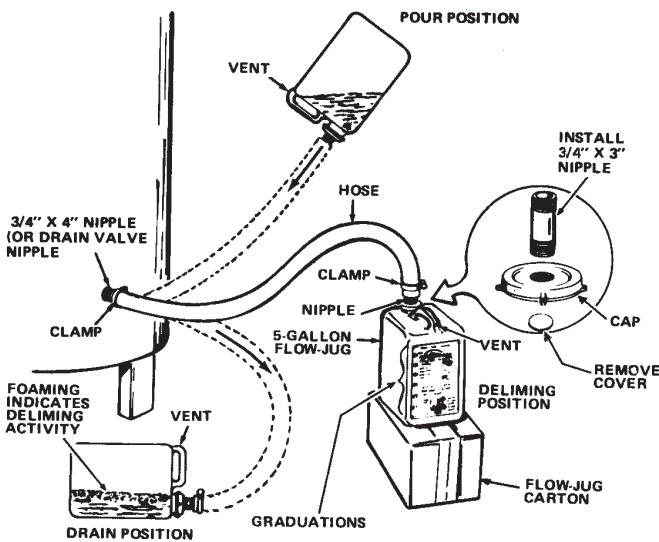

FIGURE 16

## IGNITION MODULE SYSTEM

Before calling your service agent, the following checklist should be examined to eliminate obvious problems from those requiring replacement or servicing.

- Check that "main manual gas shutoff valve" is fully open and that gas service has not been interrupted.
- Check that after following the appliance OPERATING INSTRUCTIONS, the "Top Knob" of the appliance gas valve is in "ON" position.
- Check electrical supply to the appliance for possible blown (or tripped) fusing or power interruption.
- Is the water temperature in tank below the thermostat dial setting on the appliance thermostat (calling for heat)?
- It is possible that the high limit (E.C.O.) has functioned to shut off the appliance. See FEATURES — Water Temperature Control for reset procedure. Contact your serviceman if limit continues to function to shut off appliance.

## SYSTEM DIAGNOSTICS

Your water heater is equipped with an ignition module that incorporates a diagnostic system to assist in troubleshooting the appliance. The indicator codes on the ignition module are as follows:

<b>1 flash</b>	System lockout (retries or cycles exceeded)
<b>2 flashes</b>	Pressure switch stuck close
<b>3 flashes</b>	Pressure switch stuck open
<b>4 flashes</b>	Open on high temperature limit switch (eco)
<b>6 flashes</b>	115 volt AC power reversed (check polarity)
<b>7 flashes</b>	Low flame sense signal (make sure flame sensor is in burner flame)
<b>8 flashes</b>	Check ignitor

Table 10.

continuous flash -> continuous flame sensed > 5 seconds without gas valve

continuous on -> internal control failure - replace ignition control module.

Use this diagnostic system in conjunction with the "OPERATIONAL CHECKLIST" and the "SEQUENCE OF OPERATION" to troubleshoot the appliance.

## SERVICE

The installer may be able to observe and correct certain problems which may arise when the unit is put into operation. HOWEVER, it is recommended that only qualified servicemen, using appropriate test equipment, be allowed to service the heater.

As preliminary step, check wiring against diagram, check for grounded, broken or loose wires. Check all wire ends to be sure that they are making good contact.

## ELECTRICAL SERVICING



**LABEL ALL WIRES PRIOR TO DISCONNECTION WHEN SERVICING CONTROLS. WIRING ERRORS CAN CAUSE IMPROPER AND DANGEROUS OPERATION.**

VERIFY PROPER OPERATION AFTER SERVICING.



## REPLACEMENT PARTS, SERVICE HANDBOOKS AND TRAINING AIDS

Replacement parts may be ordered through State dealers, authorized servicers or distributors. Refer to the Yellow Pages for where to call or contact the State Water Heaters, 500 Lindahl Parkway, Ashland City, TN 37015. When ordering parts be sure to state the quantity, part number and description of the item(s) including the complete model and serial number as it appears on the product. Refer to the parts list for more information.

### SEQUENCE OF OPERATION FLOW CHART

Description of this flow chart can be found in the "SEQUENCE OF OPERATION" section found on page 23.

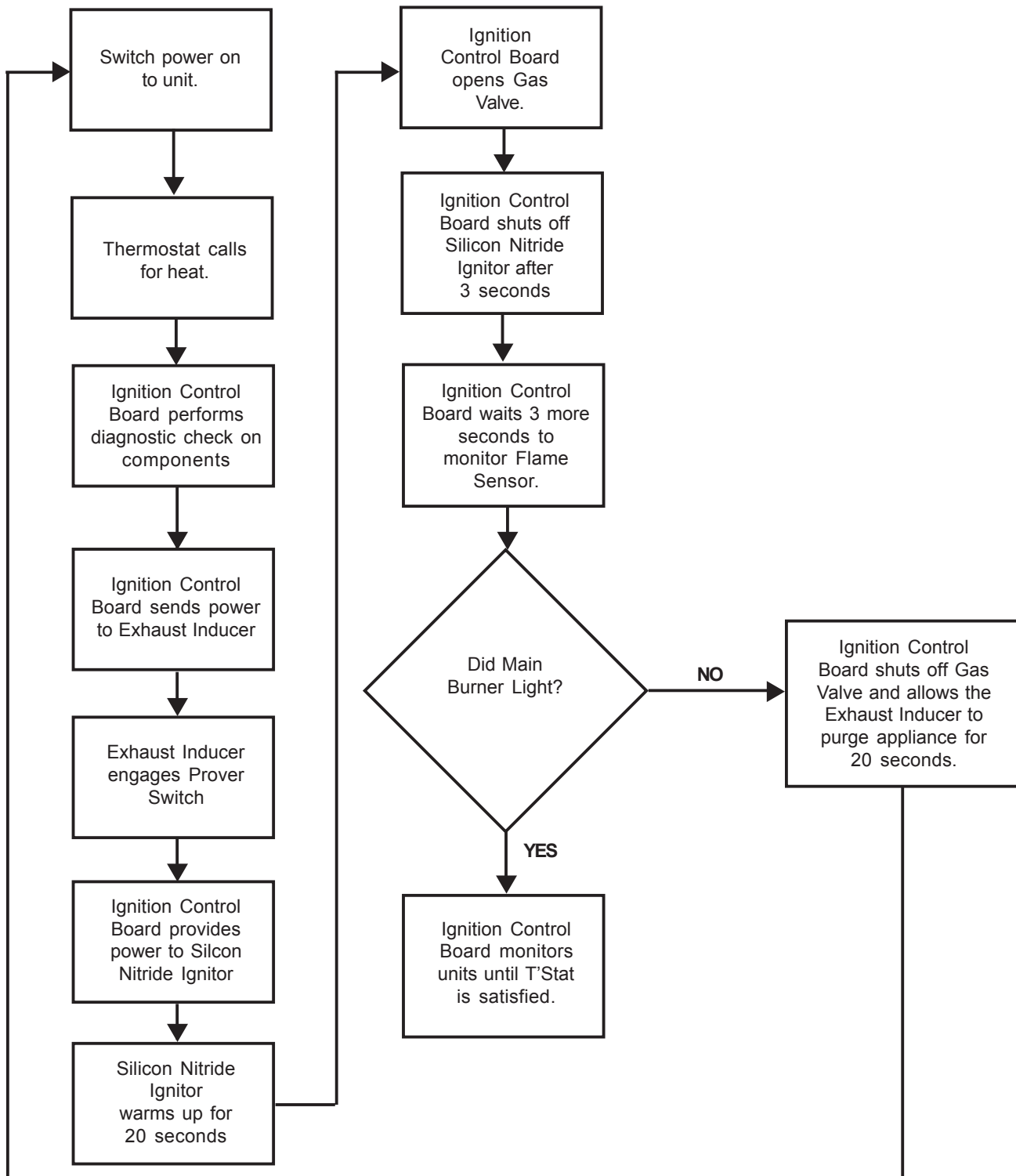

## OPERATIONAL CHECKLIST

This checklist in conjunction with "TROUBLESHOOTING" and the "SEQUENCE OF OPERATION" should be used as an on-the-job troubleshooting guide to identify the cause of incorrect system operation and suggest a remedy for its correction. Because improper piping and wiring can result in unsatisfactory system performance, it is suggested that the installation be examined before using the checklist. Be sure to refer to the correct piping and wiring diagram for the type of system that is installed.

The system should be filled with water, purged of air, valves properly set and utilities connected and ready to operate.

COMPLAINT	CAUSE	REMEDY	
		USER	SERVICEMAN
*Water not hot enough.	Thermostat set too low.	Set thermostat dial to a higher temperature.	
	Thermostat out of calibration.	Call serviceman	Recalibrate thermostat. If thermostat cannot be recalibrated, replace.
*Insufficient hot water *See WATER TEMPERATURE CONTROL WARNING (on Page 5).	Thermostat set too low.	Set thermostat dial to a higher temperature.	
	Thermostat out of calibration.	Call serviceman.	Recalibrate thermostat. If thermostat cannot be recalibrated, replace.
	Main manual gas shutoff valve partially closed.	Open main manual gas shutoff valve to fullest extent.	
	Heater too small for demand.	Space usage to give heater time to restore water temperature.	
	Thermostat differential is too wide.	Call serviceman.	Replace dual bulb controller if differential is greater than 4°F.
	Heater recovery is slower.	Call serviceman.	Check gas input. If incorrect, adjust gas pressure or replace main burner orifice.
	Drafthood not installed or one or more flue baffles.	Call serviceman.	Install drafthood or baffles as furnished with unit.
Water temperature too hot.	Thermostat set too high.	Set thermostat to a lower setting.	
Heater makes sounds: sizzling.	Condensation on outside of tank, normal.		
Rumbling.	Sediment accumulation on bottom of tank.	Drain a quantity of water through drain valve. If rumbling persists, call a serviceman.	Delime heater.
Ticking or metallic sounds.	Expansion and contraction-normal.		
Pounding.	Air chambers in piping have become waterlogged.	Drain piping system and refill. Heater must be off while this is being done.	
Combustion noises.	Too much primary air.	Adjust shutters.	
	Overfired heater; Incorrect burners or orifice for type of gas used.	Call serviceman.	Check and correct as necessary.
Water leaks.	Drain valve not closed tightly.	If drain valve cannot be closed tightly, replace.	
	If leakage source cannot be corrected or identified, call serviceman.	Shut off gas supply to heater and close cold water inlet valve to heater.	Repair or in case of suspected tank leakage, be certain to confirm before replacing heater.
Gas odors.	Heater is overfired.	Shut off gas supply to heater and call a serviceman.	Check for sooted flue passage.
			Check for obstructed vent line.
			Check backdraft or lack of draft.
Possible gas leaks.		Shut off gas supply to heater and call gas company at once.	



500 Lindahl Parkway  
Ashland City, TN 37015  
Phone: 800-821-2017 Fax: 800-644-9306  
[www.stateind.com](http://www.stateind.com)

## Free Manuals Download Website

<http://myh66.com>

<http://usermanuals.us>

<http://www.somanuals.com>

<http://www.4manuals.cc>

<http://www.manual-lib.com>

<http://www.404manual.com>

<http://www.luxmanual.com>

<http://aubethermostatmanual.com>

Golf course search by state

<http://golfingnear.com>

Email search by domain

<http://emailbydomain.com>

Auto manuals search

<http://auto.somanuals.com>

TV manuals search

<http://tv.somanuals.com>