

## Installation and Service Instructions for 1-056-X00\* Series (all revisions) Manual Adjust Brakes

\*This sheet includes Series 1-056,000; 1-056,100; 1-056,200; 1-056,300; 1-056,400; 1-056,500; 1-056,600 and 1-056,900.

For other series consult factory.

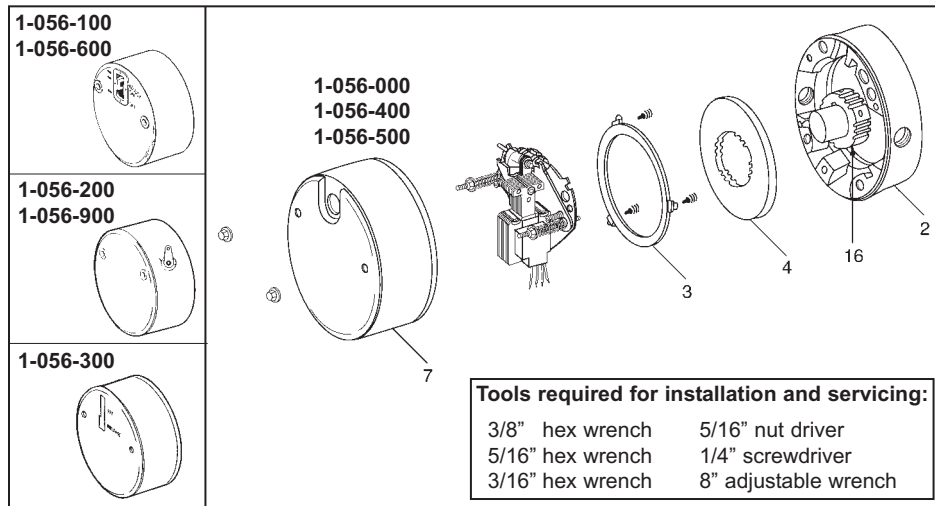

For replacement parts refer to sheets:

Series	Sheet Part No.
1-056-000	8-078-906-00
1-056-100	8-078-906-01
1-056-200	8-078-906-02
1-056-300	8-078-906-03
1-056-400	8-078-906-04
1-056-500	8-078-906-05
1-056-600	8-078-906-06
1-056-900	8-078-906-09

Also available at [www.rexnord.com](http://www.rexnord.com)

- Wear a filtered mask or a respirator while removing dust from the inside of a brake.
- Use a vacuum cleaner or a soft brush to remove dust from the brake. When brushing, avoid causing the dust to become airborne. Collect the dust in a container, such as a bag, which can be sealed off.

- Caution!** While the brake is equipped with a manual release to allow manual shaft rotation, the motor should not be run with the manual release engaged, to avoid overheating the friction disc(s).

### General Description

These series of brakes are spring-set, electrically released. They contain one or more rotating friction discs (4) driven by a hub (16) mounted on the motor or other shaft.

### Operating Principle

These series contain one or more friction discs (4) assembled alternately between the endplate (2) friction surface, stationary disc(s) (3) and pressure plate (also called stationary disc) (3). The stationary disc(s) are restrained from rotating by being keyed into the endplate. With the brake released, all disc pack components are free to slide axially and the friction disc(s) to rotate.

Brake release occurs when the solenoid coil is electrically energized, causing the solenoid plunger to travel a specified distance and through a lever system, overcoming the pressure spring force. This action releases the clamping force on the disc pack, thereby allowing the friction disc(s) and brake hub to rotate.

Brake sets and torque is produced when electric current to the solenoid coil is interrupted, thereby collapsing the solenoid magnetic field. The solenoid plunger returns to its original de-energized position allowing the lever arm to move forward by virtue of the compressed torque springs. This action compresses the disc pack components which applies a retarding torque to the brake hub and ultimately restores the brake to a spring-set static condition.

### Typical Nameplate

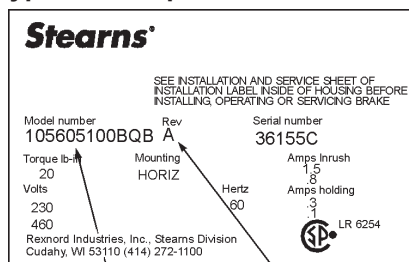

Note:

MODEL NUMBER will appear on brake nameplate.

REVISION CONTROL (if applicable) and brake serial number

### Important

Please read these instructions carefully before installing, operating, or servicing your Stearns Brake. Failure to comply with these instructions could cause injury to personnel and/or damage to property if the brake is installed or operated incorrectly. For definition of limited warranty/liability, contact Rexnord Industries, LLC, Stearns Division, 5150 S. International Dr., Cudahy, WI 53110, (414) 272-1100.

### Caution

- Installation and servicing must be made in compliance with all local safety codes including Occupational Safety and Health Act (OSHA). All wiring and electrical connections must comply with the National Electric Code (NEC) and local electric codes in effect.
- Do not operate the brake in atmospheres containing explosive gases or dusts.

- To prevent an electrical hazard, disconnect power source before working on the brake. If power disconnect point is out of sight, lock disconnect in the *off* position and tag to prevent accidental application of power.

- Make certain power source conforms to the requirements specified on the brake nameplate.
- Be careful when touching the exterior of an operating brake. Allow sufficient time for brake to cool before disassembly. Surfaces may be hot enough to be painful or cause injury.
- Do not operate brake with housing removed. All moving parts should be guarded.
- Installation and servicing should be performed only by qualified personnel familiar with the construction and operation of the brake.
- For proper performance and operation, only genuine Stearns parts should be used for repairs and replacements.

- After usage, the brake interior will contain burnt and degraded friction material dust. This dust must be removed before servicing or adjusting the brake.

DO NOT BLOW OFF DUST using an air hose. It is important to avoid dispersing dust into the air or inhaling it, as this may be dangerous to your health.

## BRAKE MOUNTING (Manual Adjust) 1-056-X00

**1** Place hub on motor shaft.

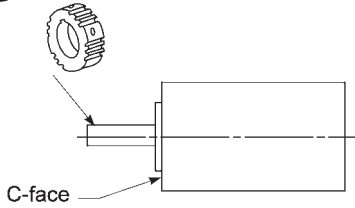

**2** Position hub on shaft as shown.

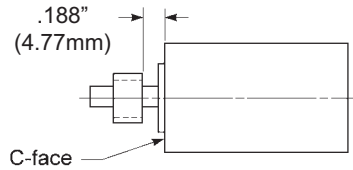

**3** Tighten set screws to motor shaft.

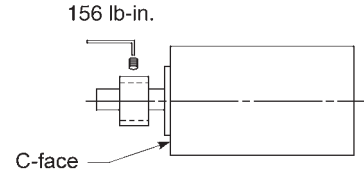

**4** Remove brake housing.  
Housings vary by series number.  
See page 1.

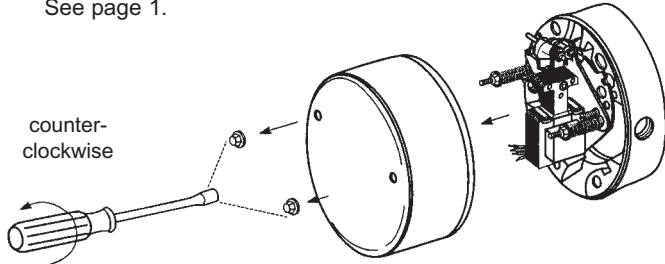

**5** Slide endplate over hub noting position of stabilizer clips, if used.  
(Refer to Friction Disc Replacement, view 3 and 3A.)  
Tighten mounting screws.

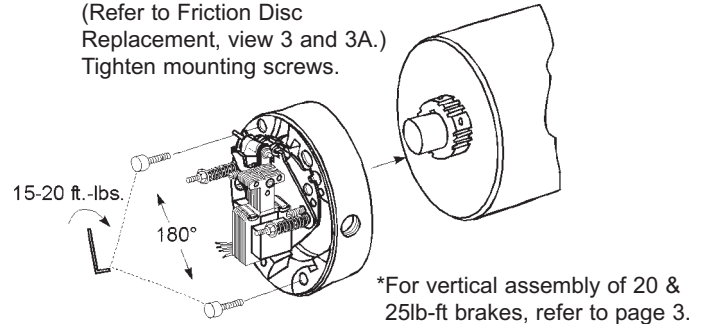

**6** Connect coil leadwires to power supply. Refer to nameplate for voltage rating.\*  
**Caution:** Keep wiring away from pinch points and moving components.

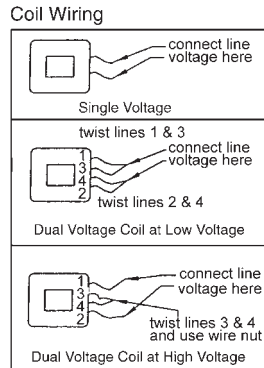

\* For DC voltages see sheet 8-078-950-00.

**7** Replace brake housing and tighten to torque specified below:

Brake series		Torque
1-056-000	1-056-300	8 lb-in
1-056-400	1-056-500	
1-056-100	1-056-200	12 lb-in
1-056-600	1-056-900	

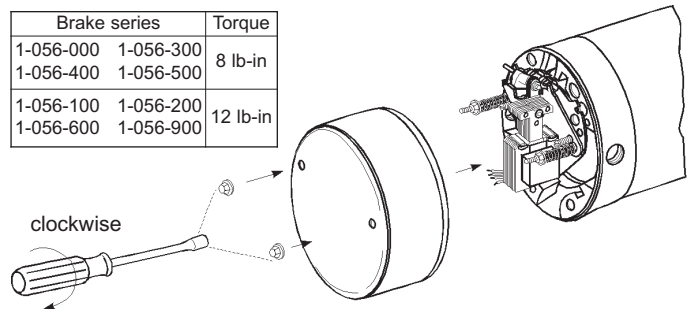

## FRICTION DISC REPLACEMENT SERIES 1-056-X00

**1** Remove support plate screws and lift support from brake

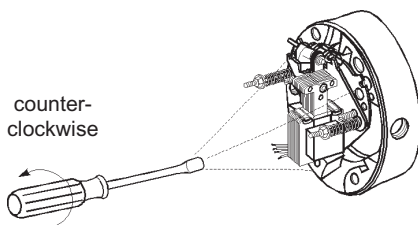

**2** Remove and discard old friction disc.

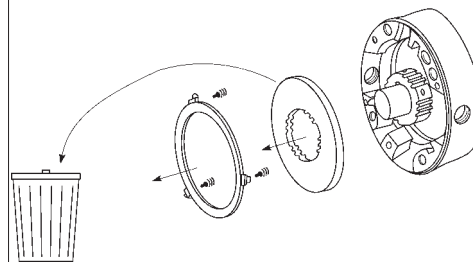

**3** Install new friction disc(s) and stationary disc(s) as shown.

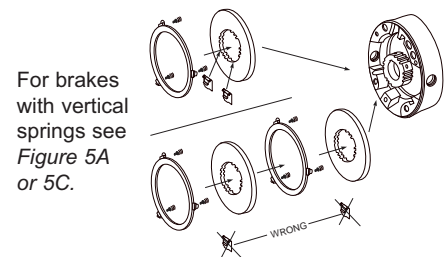

**3A**

\* Stabilizer clips are for use on single disc units only. Position clips opposite set screw holes.

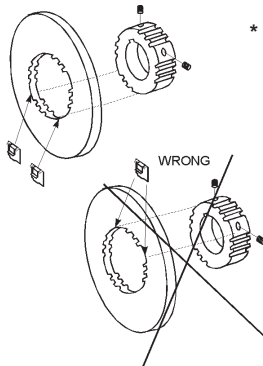

**Note:** Friction discs can wear to 1/2 their original thickness, or .093"

**4** Reposition support plate on endplate and tighten mounting screws to 55 lb-in.

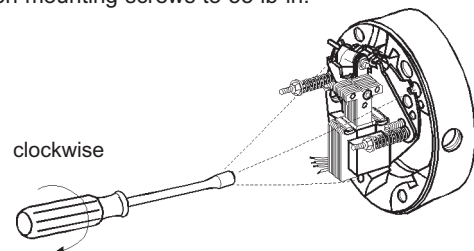

## AIR GAP ADJUSTMENT 1-056-X00

As friction disc wear the air gap will increase. When plunger gets to the reset position, the air gap must be adjusted.

- 1** To **increase** air gap, turn both adjusting screws (10) counterclockwise. Use 3/16 hex wrench, or flat screwdriver on older models.

### 56,X00 Series Air Gap\* (REV A & B)

Disc	Torque	Min/Max
1	1.5, 3 & 6	.38" ± .69"
2	10 & 15	.45" ± .69"
3	20 & 25	.50" ± .69"

\*±.30"

### 56,X00 Series Air Gap\* (REV C)

Disc	Torque	Min/Max
2	3, 6, 10 & 15	.45" ± .69"
3	20 & 25	.50" ± .69"

\*±.30"

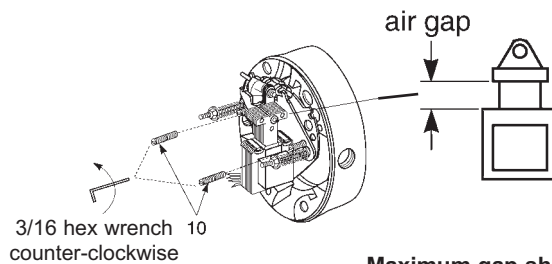

- 2** To **decrease** air gap, turn both adjusting screws (10) clockwise.

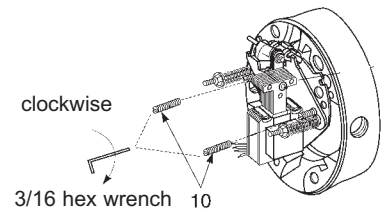

Maximum gap should never exceed .69"

## COIL REPLACEMENT SERIES 1-056-X00

Remove housing and disconnect power and wiring to coil.

- 1** Insert screwdriver between support plate and lever arm and pry forward.

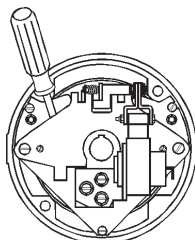

- 2** Lift plunger/solenoid lever assembly out of coil.

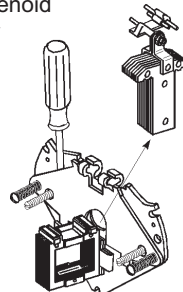

- 3** Remove plunger guide.

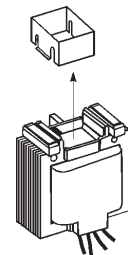

- 4** Discard coil.

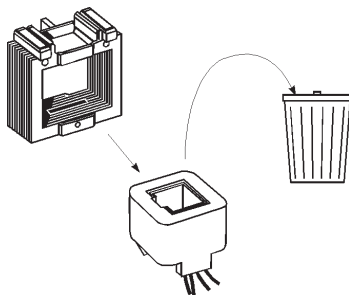

- 5** A) Insert new coil. (Lead wires in same position as old coil.)  
B) Insert plunger guide.

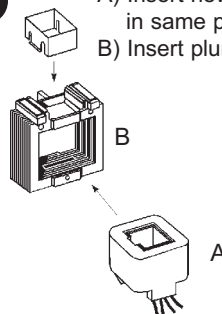

- 6** A) Re-insert plunger into coil; drop pivot pin into cradle of support plate.  
B) Remove screwdriver.

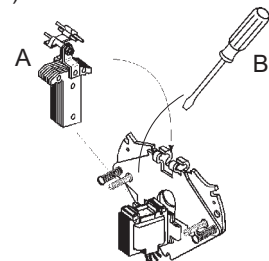

Reconnect coil and replace housing per installation instructions, page 2.

## VERTICAL SPRING ASSEMBLY 1-056-X00

### Vertical Brake Assembly

Single disc brakes (1.5, 3 & 6 lb-ft) are universal mount and do not require separator springs. Double disc brakes (10-15 lb-ft.) are universal mount but require separator springs which are preassembled to the stationary disc. These discs are inserted spring first into the brake. Refer to figure 5A below.

#### 2 Friction Disc

Vertical Above  
Vertical Below

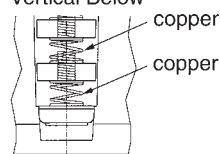

Figure 5A

**Installation Procedure for 20 and 25 lb-ft brakes if mounted vertical to motor shaft** (These brakes are factory assembled for horizontal operation.) Remove support plate by loosening the three mounting screws.

Remove stationary discs and friction discs. Using the spring kit provided with this brake, insert three springs of identical color into each stationary disc hole. Springs are inserted from the side opposite the indent mark (see Figure 5B). Stationary disc should be placed on a clean flat surface with a clearance hole to allow the tip of the spring to extend through the bottom side of the stationary plate. Using the 1/8" pin provided and a hammer, drive the spring until the large coil diameter bottoms out against the disc.

Reassemble the disc pack with the stationary discs in the proper arrangement shown in Figure 5C.

Mount support plate and torque screws evenly to 55 lb-in.

#### 1-1/2, 3, 6 lb-ft Universal 20, 25 lb-ft Horizontal

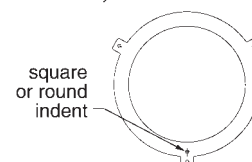

Figure 5B

#### 3 Friction Disc

Vertical Above  
Vertical Below

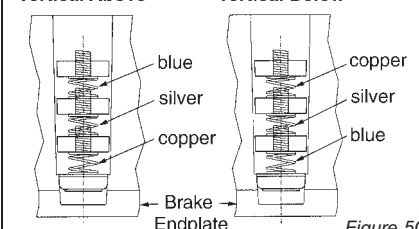

Figure 5C

# TORQUE ADJUSTMENT

## Torque Adjustment

Brake is factory set for nominal rated static torque which is maximum torque. Torque may be decreased up to 50% for increased stopping times up to 2 second stop time.

The torque on the 1-1/2 lb-ft brake may not be reduced.

Turn both spring adjustment screws (11), Figure 6, equal amounts counterclockwise to decrease torque. See Table A for torque reduction permissible amounts.

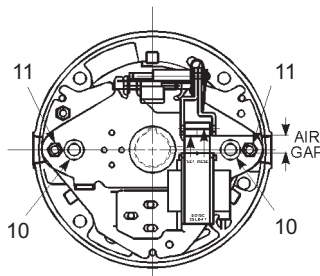

Figure 6

TABLE A

Nominal Static Torque (lb-ft)	Original Spring Height (inches)	Maximum Counterclockwise Turns	% Torque Reduction per Turn
1-1/2	1.56"	-	-
3	1.50"	5-1/2	9%
6	1.50"		
10	1.56"		
15	1.56"		
20	1.56"		
25	1.50"		

# TROUBLESHOOTING

COIL FAILURE		EXCESSIVE WEAR / OVERHEATING	
<b>SUPPLY VOLTAGE CAUSE</b>	<b>SUPPLY VOLTAGE CORRECTION</b>	<b>AIR GAP CAUSE</b>	<b>AIR GAP CORRECTION</b>
Line voltage >110% of coil rating	Reduce voltage or replace with proper rated coil	Low solenoid air gap	Reset air gap (refer to Air Gap Adjustment)
AC input on a DC coil	Replace rectifier or replace with proper rated coil.	Disc pack dragging	Inspect endplate, hub and discs for dirt, burrs, wiring and other sources of interference preventing disc "float"
Excessive voltage drop during inrush time	Increase current rating of power supply.	<b>CYCLE RATE CAUSE</b>	<b>CYCLE RATE CORRECTION</b>
<b>WIRING CAUSE</b>	<b>WIRING CORRECTION</b>	Brake "jogging" exceeding coil cycle rate	Reduce cycle rate or consider alternate control method
Leadwires interfering with plunger pull-in	Reroute wiring away from plunger and other moving components.	Thermal capacity is being exceeded	Reduce cycle rate, use alternate control method or increase brake size
Excessive voltage drop during inrush time	Increase leadwires size from power supply	<b>ALIGNMENT CAUSE</b>	<b>ALIGNMENT CORRECTION</b>
Coil leadwire shorted to ground	Replace coil or leadwire and protect with wire sleeving	Broke endplate not concentric to motor C-Face	Motor register must be within .004" on concentricity.
<b>SOLENOID ASSEMBLY CAUSE</b>	<b>SOLENOID ASSEMBLY CORRECTION</b>	Motor shaft runout is excessive	Must be within .002"; runout; consult motor manufacturer
Plunger not seating flush against solenoid frame	Loosen solenoid mounting screws and reposition frame to allow full face contact	Brake is being operated on a incline greater than 15° above or below horizontal	Vertical separator springs must be used to prevent discs from becoming cocked
Plunger cocked in coil preventing pull-in	Realign solenoid frame	<b>WORN PARTS CAUSE</b>	<b>WORN PARTS CORRECTION</b>
Excessive solenoid/plunger wear at mating surface	Replace solenoid assembly	Friction disc excessively worn (disc can wear to 1/2 original thickness or .093")	Replace friction discs.
Broken shading coils	Replace solenoid assembly	Endplate, stationary disc or pressure plate warped	Replace warped or worn component
<b>WORN PARTS CAUSE</b>	<b>WORN PARTS CORRECTION</b>	Linkages and/or pivot pins worn	Replace all worn components
Excessive wear of solenoid link arm and/or shoulder bolt	Replace link arm and link bolt; also inspect plunger thru-hole for elongation	Motor shaft endfloat excessive	Endfloat must not exceed .020"; consult motor manufacturer
Plunger guides worn down and interfering with plunger movement	Replace guides	<b>HUB CAUSE</b>	<b>HUB CORRECTION</b>
<b>APPLICATION CAUSE</b>	<b>APPLICATION CORRECTION</b>	Burr on hub interfering with disc "float"	File off burr
Machinery cycle rate is exceeding brake rating	Reduce brake cycle rate or use alternate control method	Set screw backed out and interfering with disc	Retighten set screw; use Loctite® 242 to help secure
High ambient temperature (>110%) and thermal load exceeding coil insulation rating	Use Class H rated coil and /or find alternate method of cooling brake	<b>MISCELLANEOUS</b>	<b>MISCELLANEOUS</b>
Brake coil wired with windings of an Inverter motor or other voltage/current limiting device	Wire coil to dedicated power source with instantaneous coil rated voltage	Solenoid plunger not pulling completely	Check line voltage (±10% of nameplate rating) or replace worn solenoid assembly
<b>MISCELLANEOUS CAUSE</b>	<b>MISCELLANEOUS CORRECTION</b>	Wiring is restricting disc pack movement	Reroute wiring
Wrong or over tightened torque	Replace with proper spring or refer to Installation section for proper spring height	Excessive stop time (2 seconds or greater)	Increase brake size/torque or use alternate control method
Excessive air gap	Reset, refer to Installation Section 4	High Ambient temperature (in excess of 110°F)	Reduce cycle rate or use alternate method of cooling

## Free Manuals Download Website

<http://myh66.com>

<http://usermanuals.us>

<http://www.somanuals.com>

<http://www.4manuals.cc>

<http://www.manual-lib.com>

<http://www.404manual.com>

<http://www.luxmanual.com>

<http://aubethermostatmanual.com>

Golf course search by state

<http://golfingnear.com>

Email search by domain

<http://emailbydomain.com>

Auto manuals search

<http://auto.somanuals.com>

TV manuals search

<http://tv.somanuals.com>