



---

# Continuous Loss-in-Weight Blenders

with  
Allen-Bradley SLC 5/04 Programmable Controller  
and  
PanelView 600 Touch Screen Interface

Part Number: 882.092698.00  
Bulletin Number: BF3-615  
Effective: 9/1/08

Write Down Your Serial Numbers Here For Future Reference:

_____	_____
_____	_____
_____	_____

We are committed to a continuing program of product improvement.  
Specifications, appearance, and dimensions described in this manual are subject to change without notice.

DCN No. \_\_\_\_\_  
© Copyright 2008  
All rights reserved.

# Shipping Information

---

## ***Unpacking and Inspection***

You should inspect your equipment for possible shipping damage. Thoroughly check the equipment for any damage that might have occurred in transit, such as broken or loose wiring and components, loose hardware and mounting screws, etc.

## ***In the Event of Shipping Damage***

According to the contract terms and conditions of the Carrier, the responsibility of the Shipper ends at the time and place of shipment.

Notify the transportation company's local agent if you discover damage

Hold the damaged goods and packing material for the examining agent's inspection. Do not return any goods before the transportation company's inspection and authorization.

File a claim with the transportation company. Substantiate the claim by referring to the agent's report. A certified copy of our invoice is available upon request. The original Bill of Lading is attached to our original invoice. If the shipment was prepaid, write us for a receipted transportation bill.

Advise customer service regarding your wish for assistance and to obtain an RMA (return material authorization) number.

## ***If the Shipment is Not Complete***

Check the packing list as back-ordered items are noted on the packing list. In addition to the equipment itself, you should have:

- Bill of lading
- Packing list
- Operating and Installation packet
- Electrical schematic and panel layout drawings
- Component instruction manuals (if applicable)

Re-inspect the container and packing material to see if you missed any smaller items during unpacking.

## ***If the Shipment is Not Correct***

If the shipment is not what you ordered, **contact the Parts and Service Department immediately**. Have the order number and item number available.

*Hold the items until you receive an RMA number# and shipping instructions.*

## ***Returns***

Do not return any damaged or incorrect items until you receive shipping instructions from the shipping department.

### **Credit Returns**

Prior to the return of any material, **authorization** must be given by **the manufacturer**. A RMA number will be assigned for the equipment to be returned.

Reason for requesting the return must be given.

ALL returned material purchased from **the manufacturer** returned is subject to 15% (\$75.00 minimum) restocking charge.

ALL returns are to be shipped prepaid.

The invoice number and date or purchase order number and date must be supplied.

No credit will be issued for material that is not within the manufacturer's warranty period and/or in new and unused condition, suitable for resale.

### **Warranty Returns**

Prior to the return of any material, authorization must be given by **the manufacturer**. A RMA number will be assigned for the equipment to be returned.

Reason for requesting the return must be given.

All returns are to be shipped prepaid.

The invoice number and date or purchase order number and date must be supplied.

After inspecting the material, a replacement or credit will be given at **the manufacturer's** discretion. If the item is found to be defective in materials or workmanship, and it was manufactured by our company, purchased components are covered under their specific warranty terms.

# Table of Contents

---

<b>CHAPTER 1: SAFETY .....</b>	<b>6</b>
1-1 How to use this manual .....	6
<i>Safety symbols used in this manual</i> .....	6
1-2 Warnings and precautions .....	8
1-3 Responsibility .....	9
<i>General responsibility</i> .....	9
<i>Operator responsibility</i> .....	10
<i>Maintenance responsibility</i> .....	11
<i>Reporting a safety defect</i> .....	11
<b>CHAPTER 2: FUNCTIONAL DESCRIPTION.....</b>	<b>12</b>
2-1 Models covered in this manual .....	12
2-2 General description .....	12
<i>Accessories</i> .....	12
<i>Customer service</i> .....	12
2-3 Typical features & components .....	13
<i>Mechanical features</i> .....	13
<i>Controller features</i> .....	13
<i>Electrical features</i> .....	13
<i>Blender system component description</i> .....	14
2-4 Options .....	19
2-5 Safety devices and interlocks .....	20
<b>CHAPTER 3: INSTALLATION .....</b>	<b>22</b>
3-1 Uncrating the equipment .....	22
3-2 Rigging and placing the unit .....	22
<i>Site requirements</i> .....	23
<i>Mounting configuration</i> .....	23
3-3 Electrical installation .....	26
3-4 Pneumatic installation .....	27
3-5 Overall installation (summary) .....	28
3-6 Set-up .....	29
<i>Load cell adjustment</i> .....	29
<i>Final connections</i> .....	30
<i>Controller setup</i> .....	31
<i>Scale calibration</i> .....	31
.....	44
<b>CHAPTER 4: OPERATION .....</b>	<b>47</b>
4-1 Start-up.....	47
<i>General operation</i> .....	47
4-2 Controller description & operation .....	49
<i>Display description</i> .....	49
<i>Setting a recipe</i> .....	51

<b>MAINTENANCE.....</b>	<b>52</b>
Preventative maintenance schedule .....	52
<b>APPENDIX.....</b>	<b>54</b>
6-1 Warranty and spare parts .....	54
Annex B information.....	55
6-2 Addendum (Service supervisor information).....	55
<i>Programmable settings</i> .....	56
6-3 Technical assistance .....	63

# Chapter 1: Safety

---

## 1-1 How to Use This Manual

Use this manual as a guide and reference for installing, operating, and maintaining your Continuous Loss-in-weight Blender. The purpose is to assist you in applying efficient, proven techniques that enhance equipment productivity.

This manual covers only light corrective maintenance. No other maintenance should be undertaken without first contacting a service engineer.

The Functional Description section outlines models covered, standard features, and safety features. Additional sections within the manual provide instructions for installation, pre-operational procedures, operation, preventive maintenance, and corrective maintenance.

The Installation chapter includes required data for receiving, unpacking, inspecting, and setup of the blender. We can also provide the assistance of a factory-trained technician to help train your operator(s) for a nominal charge. This section includes instructions, checks, and adjustments that should be followed before commencing with operation of the Continuous Loss-in-Weight Blender. These instructions are intended to supplement standard shop procedures performed at shift, daily, and weekly intervals.

The Operation chapter includes a description of electrical and mechanical controls, in addition to information for operating the unit safely and efficiently.

The Maintenance chapter is intended to serve as a source of detailed assembly and disassembly instructions for those areas of the equipment requiring service. Preventive maintenance sections are included to ensure that your Continuous Loss-in-Weight Blender provides excellent, long service.

The Troubleshooting chapter serves as a guide for identification of most common problems. Potential problems are listed, along with possible causes and related solutions.

The Appendix contains technical specifications, drawings, schematics, parts lists, and available options. A spare parts list with part numbers specific to your machine is provided with your shipping paperwork package. Refer to this section for a listing of spare parts for purchase. Have your serial number and model number ready when ordering.

### **Safety Symbols Used in this Manual**









The following safety alert symbols are used to alert you to potential personal injury hazards. Obey all safety messages that follow these symbols to avoid possible injury or death.

**DANGER!** *DANGER indicates an imminently hazardous situation that, if not avoided, will result in death or serious injury.*

**WARNING!** *WARNING indicates a potentially hazardous situation or practice that, if not avoided, could result in death or serious injury.*

**Caution!** *CAUTION indicates a potentially hazardous situation or practice that, if not avoided, may result in minor or moderate injury or in property damage.*

### Continuous Loss-in-Weight Blender Safety Tags

Tag	Description	Tag	Description
	Pinch Point - Slide Gate		Read Operation & Installation Manual
	Shear Point - Rotating Mixer or Agitator		Earth Ground
	High Voltage Inside Enclosure		Protected Earth Ground
	Shear Hazard - Rotating Auger		Lifting Point

## 1-2 Warnings and Precautions

Our equipment is designed to provide safe and reliable operation when installed and operated within design specifications, following pertinent local and national codes. This may include, but is not limited to OSHA, NEC, NFPA, CSA, UL, CE, SPI, and any other local, national and international regulations.

To avoid possible personal injury or equipment damage when installing, operating, or maintaining this equipment, use good judgment and follow these safe practices:

- ☑ **Read and follow these operation and installation instructions when installing, operating, and maintaining this equipment. If these instructions become damaged or unreadable, additional copies are available from the manufacturer.**
- ☑ Follow all **SAFETY CODES**.
- ☑ Keep fingers away from slide gates, augers, clean-outs, and calibration hatches. Automatic operation may start unexpectedly, **A PINCH HAZARD CAPABLE OF CAUSING BODILY INJURY EXISTS ANY TIME THE POWER IS ON.**
- ☑ Wear **SAFETY GLASSES** and **WORK GLOVES**.
- ☑ Work only with approved tools and devices.
- ☑ Disconnect and/or lock out power and compressed air before servicing or maintaining the equipment.
- ☑ Use care when **LOADING, UNLOADING, RIGGING, or MOVING** this equipment.
- ☑ Operate this equipment within design specifications.
- ☑ **OPEN, TAG, and LOCK ALL DISCONNECTS** before working on equipment. You should remove the fuses and carry them with you.
- ☑ **NEVER PUT FINGERS OR TOOLS IN AN AUGER OR SLIDE GATE AREA.**
- ☑ Make sure the equipment and components are properly **GROUND** before you switch on power.
- ☑ Do not restore power until you remove all tools, test equipment, etc., and the equipment and related components are fully reassembled.
- ☑ Only **PROPERLY TRAINED** personnel familiar with the information in this manual should work on this equipment.

We have long recognized the importance of safety and have designed and manufactured our equipment with operator safety as a prime consideration. We expect you, as a user, to abide by the foregoing recommendations in order to make operator safety a reality.



## 1-3 Responsibility

These machines are constructed for maximum operator safety when used under standard operating conditions and when recommended instructions are followed in the maintenance and operation of the machine.

All personnel engaged in the use of the machine should become familiar with its operation as described in this manual.

Proper operation of the machine promotes safety for the operator and all workers in its vicinity.

Each individual must take responsibility for observing the prescribed safety rules as outlined. All warning and danger signs must be observed and obeyed. All actual or potential danger areas must be reported to your immediate supervisor.

### ***General Responsibility***

No matter who you are, safety is important. Owners, operators and maintenance personnel must realize that safety is always a vital part of their jobs.

If your main concern is loss of productivity, remember that production is always affected in a negative way following an accident. The following are some of the ways that accidents can affect your production:

- Loss of a skilled operator (temporarily or permanently)
- Breakdown of shop morale
- Costly damage to equipment
- Downtime

An effective safety program is responsible and economically sound.

Organize a safety committee or group, and hold regular meetings. Promote this group from the management level. Through this group, the safety program can be continually reviewed, maintained, and improved. Keep minutes or a record of the meetings.

Hold daily equipment inspections in addition to regular maintenance checks. You will keep your equipment safe for production and exhibit your commitment to safety.

Please read and use this manual as a guide to equipment safety. This manual contains safety warnings throughout, specific to each function and point of operation.

## ***Operator Responsibility***

The operator's responsibility does not end with efficient production. The operator usually has the most daily contact with the equipment and intimately knows its capabilities and limitations.

Plant and personnel safety is sometimes forgotten in the desire to meet incentive rates, or through a casual attitude toward machinery formed over a period of months or years. Your employer probably has established a set of safety rules in your workplace. Those rules, this manual, or any other safety information will not keep you from being injured while operating your equipment.

Learn and always use safe operation. Cooperate with co-workers to promote safe practices. Immediately report any potentially dangerous situation to your supervisor or appropriate person.

### **REMEMBER:**

- **NEVER** place your hands or any part of your body in any dangerous location.
- **NEVER** operate, service, or adjust the blender without appropriate training and first reading and understanding this manual.
- **NEVER** try to pull material out of the blender with your hands while it is running!
- Before you start the blender check the following:
  - Remove all tools from the unit;
  - Be sure no objects (tools, nuts, bolts, clamps, bars) are laying in the metering or mixing area;
- If your blender has been inoperative or unattended, check all settings before starting the unit.
- At the beginning of your shift and after breaks, verify that the controls and other auxiliary equipment are functioning properly.
- Keep all safety guards in place and in good repair. **NEVER** attempt to bypass, modify, or remove safety guards. Such alteration is not only unsafe, but will void the warranty on your equipment.
- When changing control settings to perform a different mode of operation, be sure selector switches are correctly positioned. Locking selector switches should only be adjusted by authorized personnel and the keys removed after setting.
- Report the following occurrences **IMMEDIATELY**:
  - unsafe operation or condition
  - unusual blender action
  - leakage
  - improper maintenance
- **NEVER** stand or sit where you could slip or stumble into the blender while working on it.
- **DO NOT** wear loose clothing or jewelry, which can be caught while working on a blender. In addition, cover or tie back long hair.

- Clean the blender and surrounding area **DAILY**, and inspect the machine for loose, missing or broken parts.
- Shut off power to the blender when it is not in use. Turn the switch to the **OFF** position, or unplug it from the power source.

### ***Maintenance Responsibility***

Proper maintenance is essential to safety. If you are a maintenance worker, you must make safety a priority to effectively repair and maintain equipment.

Before removing, adjusting, or replacing parts on a machine, remember to turn off all electric supplies and all accessory equipment at the machine, and disconnect and lockout electrical power. Attach warning tags to the disconnect switch.

When you need to perform maintenance or repair work on a blender above floor level, use a solid platform or a hydraulic elevator. If there is a permanently installed catwalk around your blender, use it. The work platform should have secure footing and a place for tools and parts. **DO NOT** climb on unit, machines, or work from ladders.

If you need to repair a large component, use appropriate handling equipment. Before you use handling equipment (portable “A” frames, electric boom trucks, fork trucks, overhead cranes) be sure the load does not exceed the capacity of the handling equipment or cause it to become unstable.

Carefully test the condition of lifting cables, chains, ropes, slings, and hooks before using them to lift a load.

Be sure that all non-current carrying parts are correctly connected to earth ground with an electrical conductor that complies with current codes. Install in accordance with national and local codes.

When you have completed the repair or maintenance procedure, check your work and remove your tools, rigging, and handling equipment.

Do not restore power to the blender until all persons are clear of the area. **DO NOT** start and run the unit until you are sure all parts are functioning correctly.

**BEFORE** you turn the blender over to the operator for production, verify all enclosure panels, guards and safety devices are in place and functioning properly.

### ***Reporting a Safety Defect***

If you believe that your equipment has a defect that could cause injury, you should immediately discontinue its use and inform the manufacturer.

The principle factors that can result in injury are failure to follow proper operating procedures (i.e. lockout/tagout), or failure to maintain a clean and safe working environment.

# Chapter 2: Functional Description

## 2-1 Models Covered in This Manual

This manual provides operation, installation, and maintenance instructions for continuous loss-in-weight blenders of various blending rates and specifications. See Figure 1 below for a list of available models and specifications.

**Figure 1: Models Covered by this Manual (√ - Denotes Availability)**

Model		015	060	100
Blending Capability	2 components	√	√	√
	3 components	√	√	√
	4 components	√	√	√
	5 components	√	√	√
	6 components	√	√	√
Maximum blending rate in lbs./hr (kgs./hr) †		750 (340)	3000 (1360)	5000 (2270)

† Actual rates will vary. Consult the factory for guaranteed blending rates.

Model numbers are listed on the serial tag. Make sure you know the model and serial number of your equipment before contacting the manufacturer for parts or service.

Blending systems are as varied as the applications they are designed for. All continuous loss-in-weight blenders are sized to meet the specific requirements stated by the customer at the time of purchase, and future changes may require a modification to the original system.

## 2-2 General Description

All blenders are designed to blend plastic pellets and regrind, and supply the blended material to the extruder. The standard system is not designed to blend powder or any other non-free-flowing materials. **Consult the factory if your future process requirements require the addition of these materials.**

### Accessories

The manufacturer offers a variety of options for these blending systems, including mezzanine stands, agitated regrind supply and weigh hoppers, etc. All accessories are designed and manufactured to ensure proper results for your application.

### Customer Service

The intent of this manual is to familiarize the operator and maintenance personnel with these blenders and help your organization get the maximum service from your equipment. If you have any questions regarding installation, service, repair, custom equipment, or applications, please do not hesitate to contact us for the information required. Prices for additional equipment, accessories, or repair parts will be furnished promptly upon request.

**Note:** *If you desire to use a blender for an application other than that for which it was purchased, please contact your sales representative or our factory to verify compatibility of the equipment with the new process. Misapplication of the equipment could result in injury to the operator or damage to the equipment.*

## 2-3 Typical Features & Components

### ***Mechanical Features***

- Blender automatically adjusts individual feeders to match learned extruder rate at the ratio required.
- Upper material supply hoppers with conical re-fill valves and dust boots.
- Individual ingredient weigh hoppers with clear side walls.
- Cast aluminum feeder housings with drains.
- Lower mass flow weigh hopper assembly with clear side wall.
- Cascading mixing section.
- Precision 1/10% span accurate cantilever load cell weighing system
- Yasakawa GPD 205 variable frequency drive (VFD) system with ¼ hp inverter-duty (brushless) AC motors
- Motor drive panel – NEMA enclosure
- Machine-mount spool flange with drain
- Hopper lids arranged for manufacturer and non-manufacturer receivers and loaders

### ***Controller Features***

- Color Allen-Bradley PanelView 600 color touch screen
  - Easy menu-driven format
  - Serial printer port
  - Recipe storage book
  - Inventory and material usage information
  - **OPTIONAL** Ethernet communications module
- Manual operation capabilities, for emergency use in case of processor failure

### ***Electrical Features***

- Inductive proximity switch for extruder speed (you may also write extruder speed through Ethernet in lieu of using the proximity switch)
- 115/1/50 or 60 supply voltage

### **Blender System Component Description**

This section describes the various components of the continuous blending system. The continuous blending system is made up of the following components (See Figure 2 below):

- Ingredient supply/re-fill hoppers
- Ingredient weigh hoppers
- Ingredient metering auger assemblies
- Cascade material chute
- Lower mass flow weigh hopper
- Control panel
- Motor drive panel
- **OPTIONAL** “Quick color change” kit

**Figure 2: Continuous Blender Assembly**

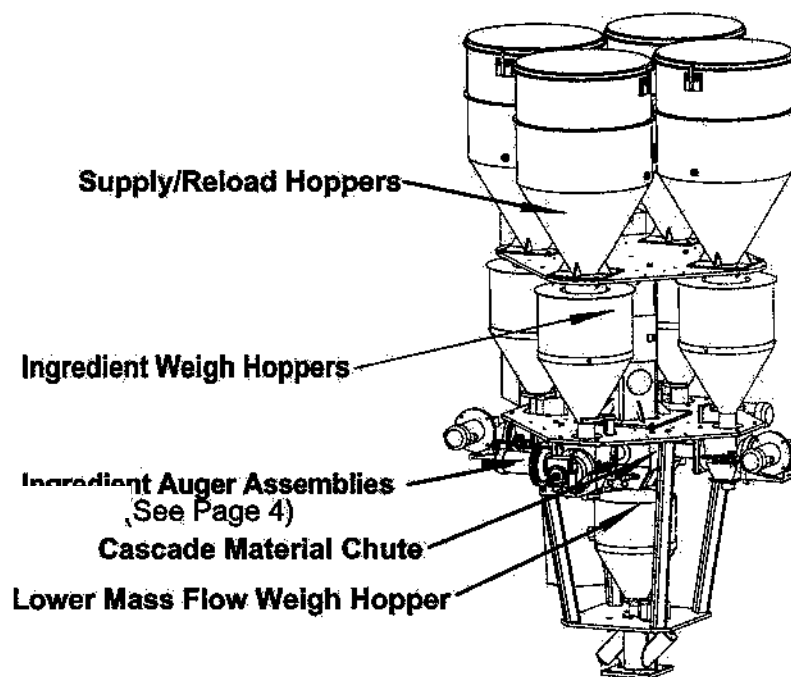

**(Motor Drive Panel not shown)**

#### **Ingredient Supply/Re-fill Hoppers**

The ingredient supply/re-fill hoppers are located on top of the blender frame. Their purpose is to provide a supply of material to the individual ingredient weigh hoppers on demand. The hoppers are equipped with an air-operated discharge valve that is opened by the PLC when a respective weigh hopper needs a re-fill of material. These hoppers are sized to handle the percentage requirements of the ingredients. Optional level sensors which might exist in these

hoppers are not controlled nor read by the blender. Their existence is solely for the use of a low level alarm to be wired into a separate controller. These would not be present on a standard blender.

The hoppers may be equipped with a polycarbonate sight glass. This is mounted in the upper cone section of the hopper. This is useful for a quick reference of the material level in each hopper.

The supply/re-fill hoppers should be vented to the atmosphere through the louver located on the lid of each hopper. This louver is required to prevent the loading system from creating a vacuum in the hopper, which would prevent material from flowing out properly. This situation could be caused by a leaking discharge seal on the vacuum receiver.

### **Ingredient Weigh Hoppers**

Each ingredient weigh hopper assembly consists of a conical mass flow weigh hopper, a precision load cell and a discharge tube disc seal. A mass flow weigh hopper is a steep degree conical hopper with vertical side walls with a discharge tube on the bottom. Each weigh hopper is sized to the blender ingredient metering requirements. This assembly is responsible for weighing the material ingredients as they are metered out by the metering auger assemblies located below each weigh hopper. The manufacturer believes this is the best way to weigh free flowing pelletized materials. This design allows the hopper to weigh only the material and nothing else, unlike other systems that weigh the heavy auger assemblies. This design eliminates extra variables, such as auger drive vibrations, etc. from the weighing system and increases the load cell resolution. Each weigh hopper will be refilled periodically as material reaches the preprogrammed low weight setpoint for that hopper. Clear hopper side walls or sight glasses are provided on each on the weigh hoppers to allow the operator to monitor the levels.

### Ingredient Metering/Transport Auger Assemblies

Each metering auger assembly consists of a:

- Cast aluminum motor mount
- Cast aluminum feeder body
- Aluminum feeder tube
- Gearbox
- Inverter-duty AC drive motor
- Machined metering auger

The metering auger assembly accurately meters the material from the ingredient weigh hopper at the calculated rate.

The mass flow weigh hopper design allows more range of the load cell to be used for actually weighing the material and eliminates dynamic drive movement and vibrations from affecting the load cell readings.

**Figure 3: Metering Auger Components**

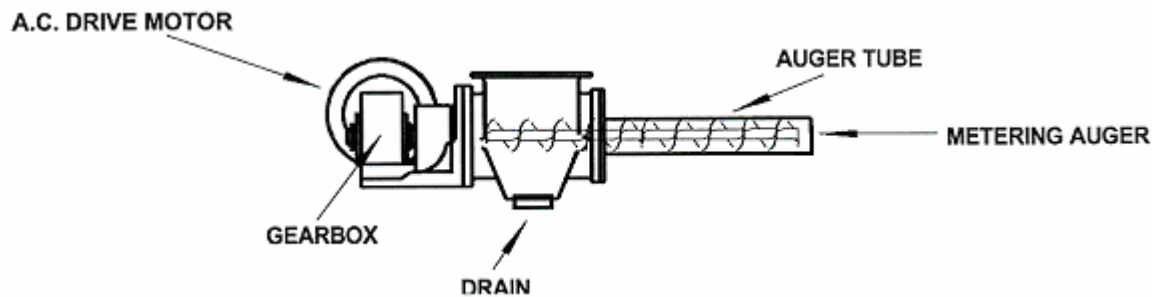

### Cascade Material Chute

The cascade material chute is a rectangular conduit in which all the metering augers discharge. The materials are cascaded together and directed vertically down into the lower mass flow weigh hopper. A clean out door is provided on the chute above the augers, so that any dust can be blown out if it has collected.



### Lower Mass Flow Weigh Hopper Assembly

The lower mass flow weigh hopper, otherwise known as the weighed common hopper, is used to determine the actual processing rate of the processing machine so that the blender can be slaved in to run at the learned rate. The hopper is constructed of spun aluminum and is of the mass flow type (See the glossary in the Appendix). It is supported by a load cell, and will carry a weight of material depending on how much is flowing into the hopper from the metering augers, and how much is flowing out of the hopper, dictated by the processing rate of the processing machine.

The computer uses the mass flow hopper flow rate (the differential rate), along with the known total rate from the weight loss feeders to determine the actual processing rate of the processing machine. The blender output rate is then adjusted to match the learned processing rate. This method of operation provides very accurate slave in of the blender to the processing rate, and eliminates the need for a mixing hopper.

The lower common weigh hopper is also equipped with a high level proximity level sensor to allow manually adjusted volumetric operation of the blender in the event of computer failure.

Figure 4: Weigh Hopper Assembly

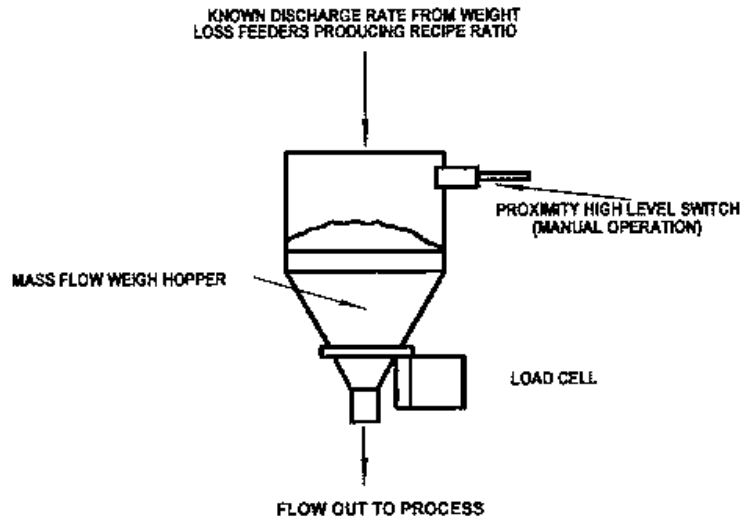

*Note: The lower or common mass flow weigh hopper uses the change in weight over time, of material contained in the hopper over time to calculate its discharge rate (differential rate). This learned discharge rate is then summed with the known total metering rates of the blender feeders to learn the actual processing rate of the processing machine. The blender output rate is then adjusted to match the learned processing rate, eliminating the need for a blender mixer.*

### “Fixed Rate” mode

The lower mass flow weigh hopper may be replaced by a collection hopper with “high” and “low” level switches on higher capacity blenders. This configuration controls the blending system rate based on material level rather than material weight.

### **PLC Control Panel**

The PLC control panel may be mounted on the side of the blender frame, or remote mounted near the blender. It uses an Allen-Bradley SLC 5/04 programmable controller with standard 24 vdc input output cards. This design provides excellent blender performance along with easily replaceable off-the-shelf parts in case of any electronic component failure.

### **Touch Screen Interface**

The PanelView 600 color touch screen display can be mounted up to 50 feet (15 m) from the PLC control panel. It is very user friendly after installation and setup, simply enter in the proper recipe and start the blender.

If it is desired to have a local display and control of the blender at the operator station, an optional PanelView 600 can be installed.

### **Motor Drive Panel**

The auger motor drive panel is mounted on the blender frame adjacent to the PLC control panel in most applications. The motor drive panel is permanently wired on the blender. The standard panel contains Yaskawa GPD 205 variable frequency motor drives, a power supply and manual volumetric backup system wiring components.

The motor drives on the blender are standard, off the shelf drives and are readily available from Yaskawa distributors and the manufacturer.

Power cords to each drive motor are equipped with plugs to facilitate auger removal and motor replacement, if necessary.

### **Optional “Quick Color Change” Kit**

The optional “QCC” quick color changeover kit allows the virgin material to be gravity fed so the processing machine can be operated, while a color change is being done.

The virgin material auger metering assembly is equipped with a lower slide gate and discharge tube. A flexible hose connects the discharge tube with a cast aluminum flange below the blender that is equipped with an angled inlet tube stub. When the slide gate is opened, virgin pellets will gravity feed to the bottom of the blender and bypass the blender augers and the lower mass flow weigh hopper, allowing the extruder to be operated.

The blender augers can then be removed and the colors changed without the processing machine having to be “re-strung”, and the product having to be re-gauged.

## 2-4 Options

The following is a list of options, which your blender may have been equipped with:

- **Mezzanine stand with slide gate and 4" tube stub.**
- **Low-level proximity switches.** Detects material supply shortages for each supply hopper before blender runs out (Requires a separate, remote mount alarm panel with its own lights, horn and silence button).
- **Supply hopper lids for non-ACS supplied vacuum receivers & loaders.**
- **Agitated, straight wall regrind supply & weigh hoppers for regrind material.**
- **Compressed air loader for low percentage additives.**
- **Ethernet communication module**
- 

### ***Remote Display***

Allows control of blender from a second location up to 50 feet (15 meters) away. The remote display can be located in another location to allow the blender to be operated from that position. The additional remote PanelView 600 operates identically to the main display.

## 2-5 Safety Devices and Interlocks

This section includes information on safety devices and procedures that are inherent to the continuous loss-in-weight blender. This manual is not intended to supersede or alter safety standards established by the user of this equipment. Instead, the material contained in this section is recommended to supplement these procedures in order to provide a safer working environment.

At the completion of this section, the operator and maintenance personnel will be able to do the following:

- Identify and locate specific safety devices.
- Understand the proper use of the safety devices provided.
- Describe the function of the safety device.

### ***Safety Circuit Standards***

Safety circuits used in industrial systems protect the operator and maintenance personnel from dangerous energy. They also provide a means of locking out or isolating the energy for servicing equipment.

Various agencies have contributed to the establishment of safety standards that apply to the design and manufacture of automated equipment. The Occupational Safety and Health Administration (OSHA) and the Joint Industrial Council (JIC) are just a few of the organizations that have joined with the plastics industry to develop safety standards.

Every effort has been made to incorporate these standards into the design of the continuous loss-in-weight blender; however, it is the responsibility of the personnel operating and maintaining the equipment to familiarize themselves with the safety procedures and the proper use of any safety devices.

### ***Fail Safe Operation***

If a safety device or circuit should fail, the design must be such that the failure causes a "Safe" condition. As an example, a safety switch must be a normally open switch. The switch must be held closed with the device it is to protect. If the switch fails, it will go to the open condition, tripping out the safety circuit.

**At no time should the safety device fail and allow the operation to continue.** For example, if a safety switch is guarding a motor, and the safety switch fails, the motor should not be run.

### **Safety Device Lock-Outs**

Some safety devices disconnect electrical energy from a circuit. The safety devices that are used on the continuous loss-in-weight blenders are primarily concerned with electrical power disconnection and the disabling of moving parts that may need to be accessed during the normal operation of the machine.

Some of the safety devices utilize a manual activator. This is the method of initiating the safety lock out. This may be in the form of a plug, disconnect plug, lever or a handle. Within this lockable handle, there may be a location for a padlock. A padlock should be placed in the lockout handle by personnel servicing the equipment.

**WARNING!** *At no time should anyone other than the person who installed the lockout or unplugged a twist plug, remove the lockout, or reconnect the twist plug.*

### **Pluggable Line Cord**

This line power cord allows the operator or maintenance personnel to unplug the blending system from its power source and tag it out. This plug may be tagged with any number of approved electrical lockout tags. These tags are available at most electrical supply stores.

### **Amphenol quick connect Plug Connected to Each Auger Motor**

The plug must be unlatched and the female end of the cord removed from the motor plug. This disables the motor from turning while the auger unit is being serviced or cleaned. The motor cords are cut to length so they must be disconnected before the auger can be removed from the housing.

**Note:** *Disconnect both of the items listed above before cleaning or servicing equipment.*

**Figure 5: Plug**

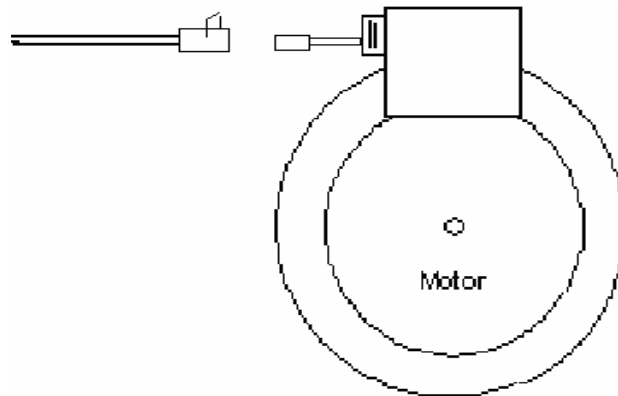

**Caution!** *Disconnect the electrical power and compressed air source before working on the equipment!*

# Chapter 3: Installation

## 3-1 Uncrating the Equipment

Continuous loss-in-weight blenders are shipped bolted on a skid, enclosed in plastic wrap, and contained in a wood crate.

1. Remove the crate from around blender.
2. Secure strap of proper lifting capacity to the lifting lugs installed in the holes provided.

**Caution!**



*Use approved safety straps or chains to lift the blender from the eyebolts on the top plate (See figure 6 below for eyebolt positioning).*

**Figure 6: Lifting Eyebolt Position on Blender**

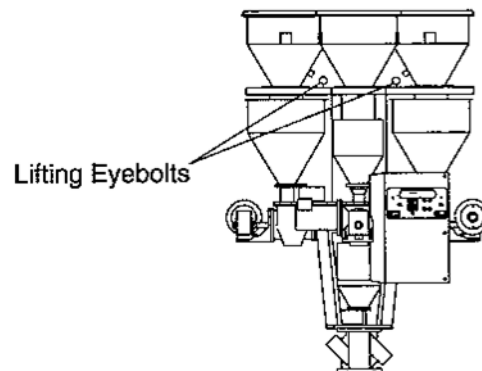

**Caution!** *Remove hoppers if necessary to prevent damage.*

3. Lift blender until strap is taut.
4. Remove bolts attaching bottom of blender to shipping skid.
5. Raise the blender slowly.

## 3-2 Rigging and Placing the Unit

It is the intent of this section to familiarize the reader with the proper site requirements and installation procedures of the continuous loss-in-weight blending system. The information in this section is NOT meant to replace or supersede an established local or company implemented procedures. It is meant to enhance them.

**Note:** *The manufacturer assumes NO responsibility for any damages resulting from improper installation, or improper handling during the installation process.*

## **Site Requirements**

This section describes site requirements in detail. These requirements are broken down into mechanical mounting, electrical connections and pneumatic connections. Since the continuous loss-in-weight blender is available in several different mounting arrangements, it is necessary for the reader to become familiar with the different arrangements.

## **Mounting Configuration**

The continuous loss-in-weight blender is available in (3) three basic mounting arrangements. They are:

- Machine Mount
- Mezzanine Mount
- Floor Mount

### **Machine Mount**

In a machine mounting application of the continuous loss-in-weight unit, there are a few items to review *before* placement and mounting of the blending system begins.

First, verify the machine flange dimensions match the continuous loss-in-weight blender flange or the optionally provided adapter flange dimensions.

Verify that the machine material inlet flange is mechanically capable of supporting the weight of the continuous loss-in-weight blender with a full load of material and the loading system installed.

*Note: While in operation, the continuous loss-in-weight blender applies horizontal and vertical pressures to the mounting flange. The vacuum system will cause some shaking due to the dynamics of the conveying operation.*

*Note: If there is a question as to the mechanical stability of a mounting flange, the appropriate reinforcements and lateral supports must be provided to ensure a safe installation. Check to ensure that the unit is braced to prevent swaying if necessary. Contact the manufacturer.*

Verify all clearances on the top and beside the processing machine. This is to insure that all motors, hoppers, control panels, etc. have adequate room for proper operation and servicing.

*Note: Allow at least 24" clearance around auger assembly to provide adequate room for cleaning, servicing, etc.*

Using proper lifting equipment, lift the blender into place above the machine throat and secure the flange bolts. Check to ensure that the unit is properly oriented, and that there is adequate access around the blender for operating and servicing of the panels and cleaning of the feeder units. A work platform with OSHA approved handrails is recommended.

Take care to insure proper orientation with adequate access to operator controls, mix chamber, and metering units.

***Note: Never weld on the blender's frame, machine or mezzanine without first removing the control panel and verifying that the blender's power is disconnected.***

### **Mezzanine Mount**

In a mezzanine mount application, review the following items before installation begins. First, verify the blender mounting locations match the mezzanine supports. Verify that the mezzanine is capable of supporting the blender with a full load of material and loading equipment installed. If the unit is unstable in the vertical or horizontal plane, additional bracing of the mezzanine floor or blender side bracing will be required. **Remember that this is a precision weighing system. It is only as accurate as the base it is mounted on.**

If a blender is moving due to vibration, the weigh hoppers will tend to remain stationary due to the laws of physics dealing with inertia. This causes the load cells to output erroneous weight signals.

***Note: While in operation, the blender applies both horizontal and vertical pressures to the mezzanine mount location.***

Second, verify ALL clearances to other equipment and structures. Insure motors, hoppers, and control panels have proper clearance for operation, cleaning and maintenance.

***Note: Auger assemblies require a minimum of 24 inches for proper cleaning and maintenance.***

Ensure that the blender, if feeding the extruder from an offset (not exactly over the center of the extruder throat), is mounted with the gravity discharge tube at least at a 60 degree angle (See figure 7 below). This must be more than the angle of repose of the material or bridging in the discharge tube will occur and the extruder could starve. The material connection should be made with rigid tubing, if possible.

**Figure 7: Offset Mezzanine Mount Position**

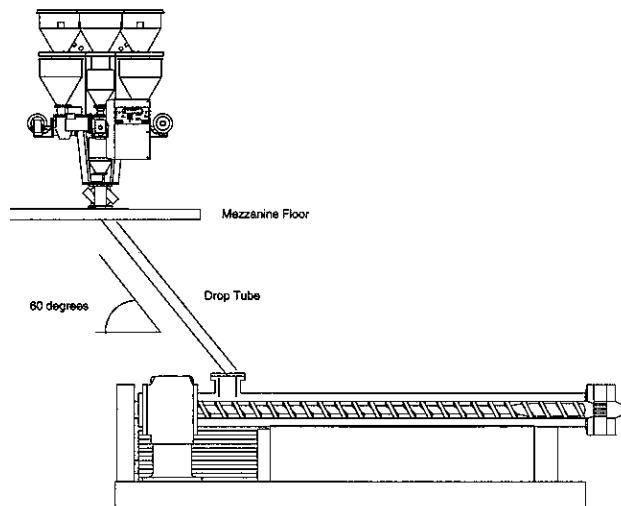



*Note: Ensure that the feed tube angle is steep enough (60 degrees is recommended).*

*Note: Some mezzanine mount applications will require the blending system's lower mass flow hopper be mounted on the extruder throat. The metering section will be mounted on a small stand on the mezzanine directly above the extruder with a 4" tube stub for gravity metered flow.*

*Note: This arrangement will be similar to the floor mounted configuration, discussed in the following section, less the blower assembly.*

Using the proper lifting equipment, lift the blender into place. Take care to ensure the proper orientation of the blender and operator controls.

*Note: The manufacturer assumes NO responsibility for any damages resulting from improper installation or improper handling during the installation process.*

Once properly positioned, securely fasten the blending system to the floor.

### **Floor Mount**

In a floor mounting application, ensure adequate clearance for all blender operations and maintenance. The operator and maintenance personnel must have access to all parts of the blender. If necessary, it is the customer's responsibility to provide adequate, safe work platforms around the blender to meet state and local safety codes. For specific dimensions, refer to the assembly diagram provided with each blender.

*Note: Auger assemblies require a minimum of 24 inches of clearance for proper servicing and cleaning.*

Insure the chosen location for the blending system is adequately away from high traffic aisles. Insure that normal day to day operations will not place the blending system at risk of damage.

Once a proper location has been chosen, securely fasten the blender floor stand frame to the floor.

*Note: The blending system MUST BE SECURELY LAGGED TO THE FLOOR before operating the unit.*

The floor mounted version has a blower and venturi that continually conveys the metered blend to the processing machine mounted mass flow weigh hopper. The blower unit can be placed in any position around the venturi and connected with a flexible hose. It is provided for a straight hook up from the factory, but this can easily be field changed to any convenient location, with additional tubing and a longer wiring conduit. These blenders have been installed with the blower remote from the blender and connected with rigid aluminum tubing, bends and Morris couplers. This is the customer's preference. **All conveying tubing is to be provided by the customer and is not included with the blender pricing.**

If the remote mass flow weigh hopper is located more than 25 feet from the blender control panel, a load cell amplifier module may be required.

*Note: The manufacturer assumes NO responsibility for any damages resulting from improper installation or improper handling during the installation process.*

**Figure 8: Typical Layout for a floor mounted blender**

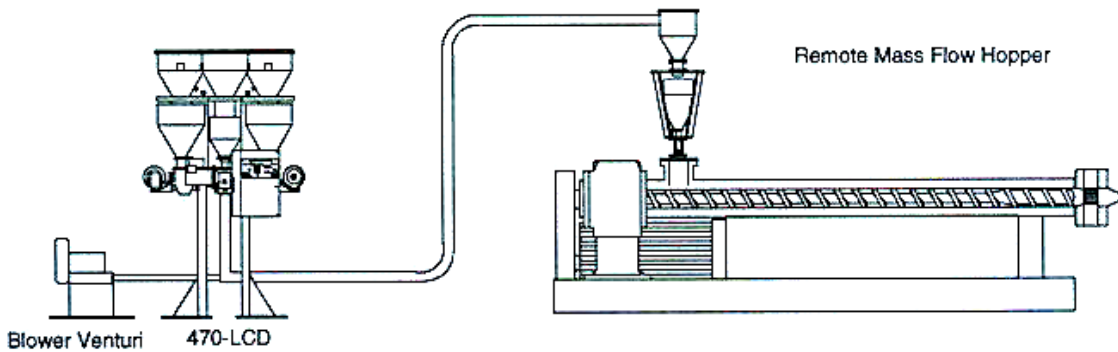

### 3-3 Electrical Installation

The continuous loss-in-weight blending system is designed to operate on 115 volt, single phase, 50 or 60 hertz AC power. The power requirements will vary with the blender's size and throughput rating. For exact current requirements, check the blender serial number tag, located on the blender motor control panel.

As an added option, the manufacturer may provide a voltage transformer for special supply voltage. If supplied, they are rated for the load required by the blending system - no other equipment should be connected to the transformer. The additional equipment may induce noise into the power circuit to the blender, as well as possibly overload the transformer.

The power transformer wiring and mounting is the responsibility of the customer. If company or local codes require fusing or disconnects, these items must be supplied, wired, and mounted by the customer.

Each blending system **MUST** be connected to a separate source of power. Do not connect extra equipment on the same line, with or without use of the transformer.

It is the customer's responsibility to ensure that the power requirements of the blending system are satisfied.

### 3-4 Pneumatic Installation

The blending system utilizes air pneumatics to perform the re-fill function on the ingredient weigh hoppers.

The manufacturer provides all pneumatic plumbing to a single ¼” standard pipe thread fitting. The blender requires a maximum of 60 PSI of compressed air.

It is the customer’s responsibility to ensure that the air is CLEAN, DRY & LUBRICATED. Any component failures due to airborne contaminants will not be subject to warranty consideration.

The working range of the air pressure is from 40-60 PSI. PSI lower than 40 may result in shutoff valve failure. PSI greater than 60 may result in damage to the plunger cones in the re-fill hoppers. A 5 micron filter is recommended.

**Note:** *It is the customer’s responsibility to provide proper air pressure regulation, filtration, and lubrication devices.*

**Figure 9: Pneumatic Air System**

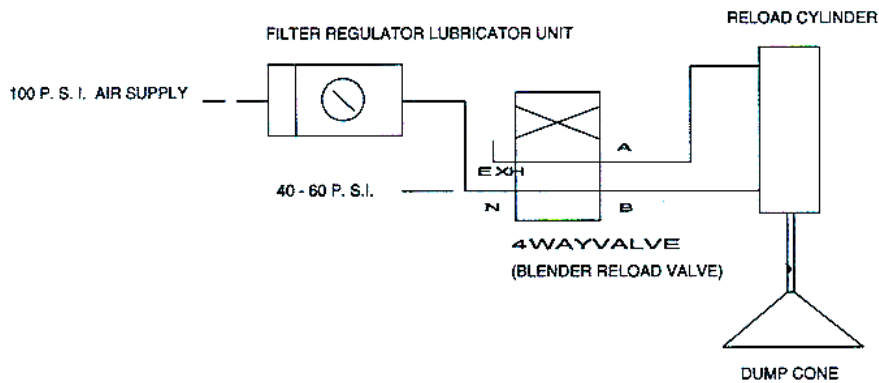

### 3-5 Overall Installation (Summary)

This installation procedure should be used as a **general** guideline for the proper installation steps required to install the continuous loss-in-weight blending system.

1. Visually inspect the extruder or blender mounting location for obstructions.
2. Remove the material supply hopper on the extruder flange.
3. Carefully lift blender into place above the mounting flange on the extruder and fasten the blender to the flange using the extruder flange bolts.

**Note:** *Always lift the blender from the eyebolts on the top plate.*

4. Mount the weigh hoppers that were shipped in boxes on the crate, to their respective load cells (Don't forget the plastic dust cover on the bottom of the weigh hopper). Align the discharge tube on the weigh hopper to be centered in the lower frame opening over the feeder assembly. Use caution in tightening the bolts. Adjust the gap to 0.040".
5. Hook the manual mode level sensor bracket over the lower mass flow weigh hopper on the bottom of the blender. Ensure that the cord is not binding on anything that would affect the accuracy of the weigh hopper.
6. Check the wiring from the load cells to the control panel.
7. Ensure that the motor power cords are connected to each of the metering unit motors.

**Note:** *Ensure that the augers on the blender metering units are not bent or damaged in shipping before starting the unit.*

8. Connect the control power to the motor control panel.
9. Connect the compressed air piping to the inlet fitting on the top of the blender top frame. Ensure that the air supply is regulated to a maximum of 60 PSI.

**Note:** *Ensure that the compressed air is regulated to 60 PSI max.*

### 3-6 Set-up

This section will discuss the mechanical setup and control system setup of the continuous loss-in-weight blending system. After reading this section, you should be familiar with the mechanical setup and the electronic control setup of the blending system.

#### **Load Cell Adjustment**

The mechanical setup of the continuous loss-in-weight blending system involves the adjustment of the weigh hopper load cells (Please refer to the figure below). This figure illustrates the proper adjustment of the load cell mechanical stop bolt. The setting for the positive stop is necessary to prevent the load cell from being “over-ranged” by excessive loading on the weigh hopper. The setting for the load cell stop is forty thousandths of an inch maximum (.040”). This should be set by a feeler thickness gauge with the weigh hopper empty.

If a feeler gauge is not available, the weigh hopper should be filled with the material that is to be blended, and the stop adjusted so there is just a very small gap (a couple of sheets of notebook paper) between the load cell, and the blender base stop. This will allow the load cell to operate without mechanical restrictions and provide an overload safety. To adjust the stop, adjust the screw located on the bottom of the load cell. Adjust the screw up to increase the gap and down to decrease the gap.

**Note:** *THE WEIGH HOPPER ASSEMBLY MUST BE FREE FROM FRICTION, WITH NO MECHANICAL OBSTRUCTIONS OTHER THAN THE LOAD CELL ITSELF.*

**Figure 10: Load Cell Mechanical Stop Adjustment**

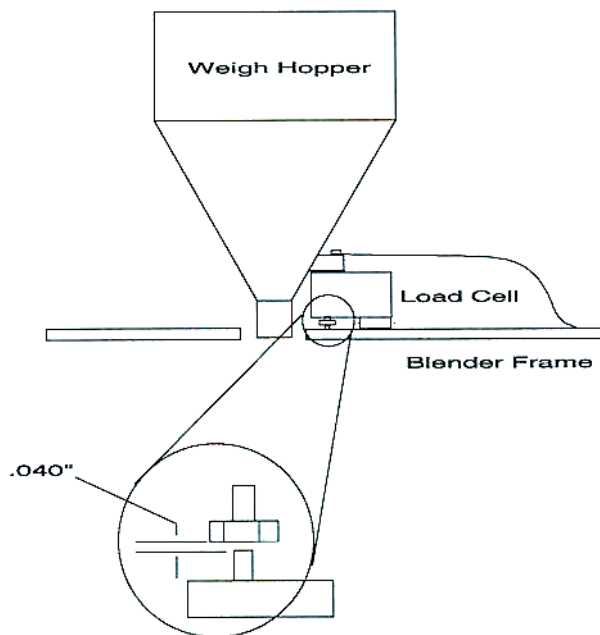

### **Final Connections**

1. Connect the blender to the appropriate power source.
2. Connect the compressed air piping, ensuring that a 5-micron air filter is installed, along with the proper water trap, and lubrication unit, if required. Verify that 60 psi (4.14 bar) of clean, dry compressed air is supplied to the blender.

**Note:** *Again, make sure that proper air supply connections are made to the blender, as dirty, contaminated, wet air can damage blender components and can quickly cause poor performance and accuracy!*

**Note:** *Make sure that the blender is supplied with clean, dry, 60 psi (4.14 bar) compressed air.*

## **Controller Setup**

This section describes the proper setup of the continuous loss-in-weight blending system control parameters. These parameters are operator changeable; however, these items should only require setup during the initial installation. Only authorized personnel should change them. For security reasons, the menu that is used to access these parameters is password protected.

Many of the variables and setup parameters have been preset at the factory and do not need to be changed. However, this section of the manual will address all of the blender setup parameters that were available at the time of printing. The purpose of this is to familiarize the reader with all the setup parameters and their usage.

The following parameters will be discussed:

- ✓ **Changing Recipes**
  - View Recipe
  - Change Recipe
  - Recipe Book
- ✓ **Hopper Setup**
  - Set Hopper Size
- ✓ **Calibration**
  - Scale (Hoppers)
  - Feeder
- ✓ **Password**
  - User
  - Service
  - ACS Only
- ✓ **Units**
  - Metric or Standard
- ✓ **FIFO Diagnostics**
  - Mass Flow
  - Feeder
- ✓ **Network Information**
- ✓ **Alarm log**
- ✓ **Alarm Setup**

## **Scale Calibration**

The heart of the blending system is the load cells. They monitor the weight in each of the ingredient weigh hoppers and the lower mass flow weigh hopper. As the load cells are reading the actual material weight loss that is removed from the weigh hoppers by the feeders or the extruder, the proper calibration of these load cells is essential for the correct operation of the blender. This calibration must be performed upon initial installation and startup of the blender. They should also be rechecked periodically with a calibration weight to ensure that they have not been damaged in the normal routine of cleaning, color changes, etc.

The calibration of each load cell is done by using two points on the output of the load cell scale. The first of these points is known as the "Tare Weight". This is the weight of the empty hopper assembly on the load cell. This is also known as the zero weight point (starting point) of the scale. This zero or starting point must be initialized with an empty weigh hopper. There must be no binding or leverage put on the load cell.

The second weight point that will be used in the load cell calibration procedure is a known amount of weight for the weigh hopper. Provided with the blending system is a calibration weight. The calibration weight is stamped with its actual weight on top. If this is not available, any object with a known accurate weight to the nearest 1/100<sup>th</sup> of a lb. in the 5 – 10 lb. range

will suffice. The weight will be in pounds, unless the blender is provided for metric display operation (kilograms).

Given the two weight points on the load cell scale, the controller will be able to determine any other weight on the load cell span. This is limited to the maximum capacity of the load cell. The standard load cell used on these blenders have a span accuracy of 1/10<sup>th</sup> %.

The maximum capacity of each load cell is clearly marked on the fixed top of the load cell. This value will be indicated in kgs. (2.2 lbs. = 1 kg.)

**Figure 11: Blender Calibration Weight**

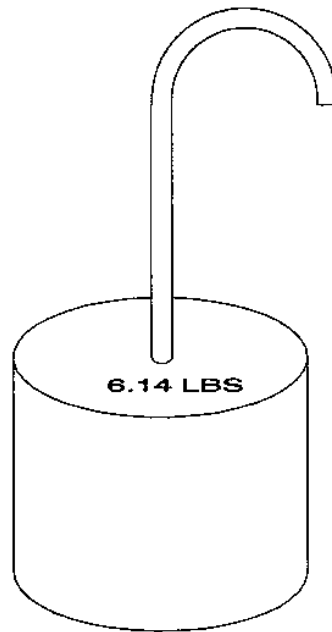

### **Scale Calibration**

During the initial setup of the blenders, the feeder units will need to be setup. Most of these items should have been setup at the factory before the unit shipped.

To calibrate the scales on each of the feeder units, follow the instructions below:



Touch the “ACS Group” logo in the upper left hand corner. You will be prompted to enter a password - it is “5413”.

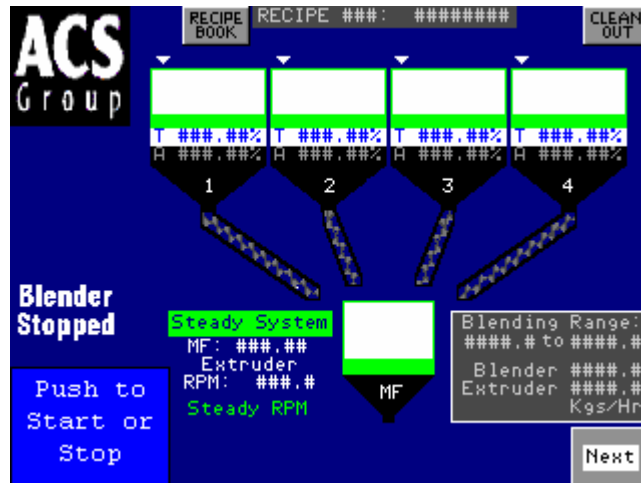

You will see the “Password Accepted” screen, now press “OK”.

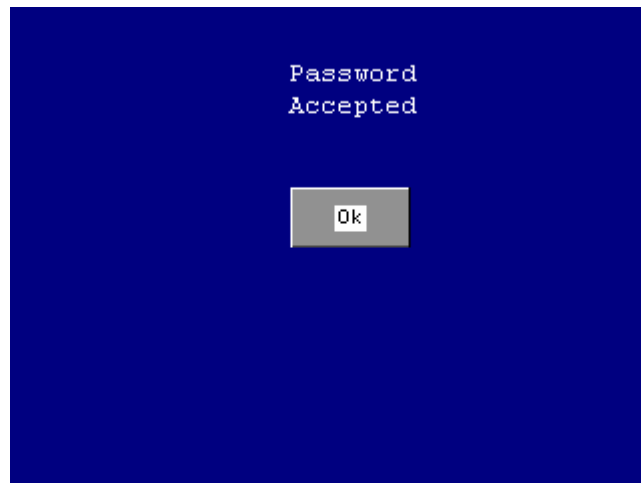

Touch the “Calibration” button.



Touch “Scale” button

Find your calibration weight that shipped with the blender and locate the Weight information stamped on the weight proceed as follows.

1. Enter weight value stamped on the weight in **Cal Wt Box**.
2. Make sure weigh hopper is empty then touch **Set Zero**.
3. Hang Calibration weight on weigh hopper and touch **Set Cal Wt**.
4. Repeat for all Hoppers including Mass Flow.
5. Touch done when complete

You can also check the calibration by looking at the **in LBS** box and hanging your calibration weight on the weigh hopper to be checked.

SCALE CAL	Zero Bits	Set Zero	Cal Bits	Set Cal Wt	in LBS
1	Cal Wt	Set	Set	1:###.### ##### bits	
2	Set	Set	2:###.### ##### bits		
3	Set	Set	3:###.### ##### bits		
4	Set	Set	4:###.### ##### bits		
5	Set	Set	5:###.### ##### bits		
6	Set	Set	6:###.### ##### bits		
MF	Set	Set	mf:###.### ##### bits		
					DONE

### Feeder Calibration

This section will explain how to calibrate the feeders on your OL blender. This must be done on initial startup and whenever material is change and bulk density varies greatly. You must make sure that the feeder to be calibrated has resin available. **\*\*\*\*Also note that resin will be dispensed into the Mass Flow hopper during this procedure.\*\*\*\***

Touch the “ACS Group” Logo. Then enter password “5413”.

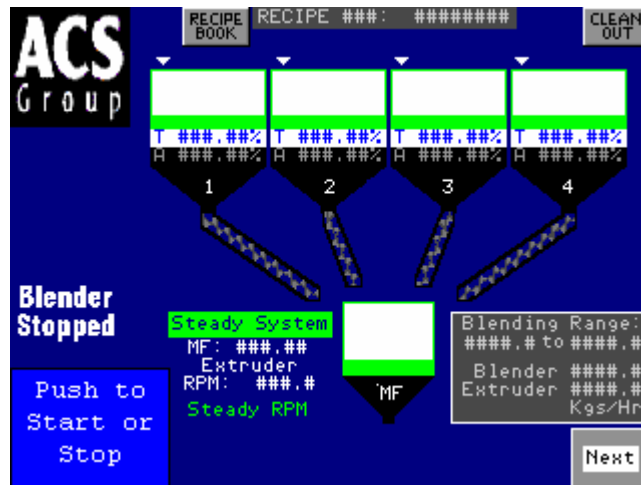

Touch the “OK” button.

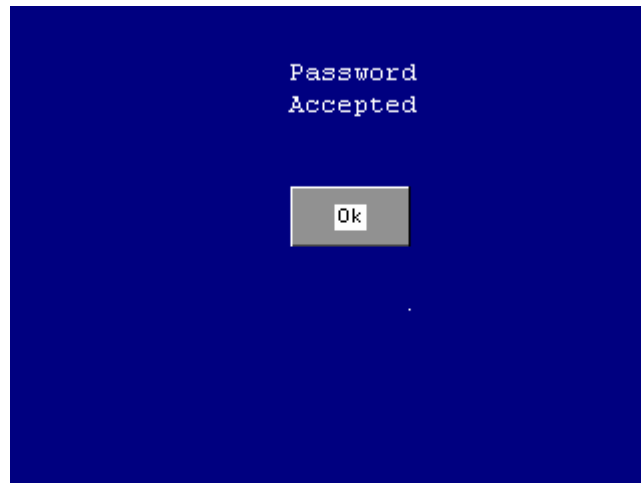

Touch the “Calibration” button.

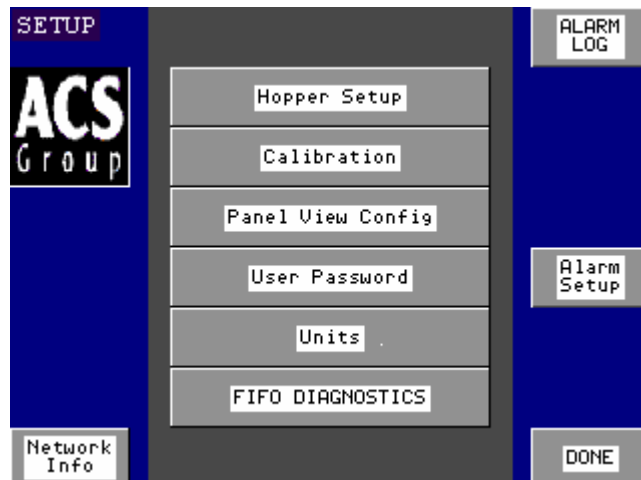

Touch “Feeder” button

Feeder Calibration is carried out as follows:

1. Select the feeder you want to calibrate and enter the value in **Feeder#** by touching the adjacent box.
2. Determine the calibration weight and enter it in the box for **Cal Wt.** (This should be about 10% of the hopper size.)
3. Enter the Calibration speed by touching the box adjacent to **Cal Spd.** (This should be 60)
4. Touch the **Press Here to Begin Box.** The selected feeder will now start dispensing resin until it reaches the calibration weight entered above.
5. Pressing **Abort** will stop the calibration if you have a problem.
6. Repeat this process for all feeders.

It is possible to forgo calibration after the initial calibration is complete if you note down the calibration values listed in the **CAL VALUES** box. If you are changing back to a calibrated resin simply touch the box under **Cal Values** and enter the appropriate number.

The screenshot displays a control interface for feeder calibration. On the left, under the heading "FEEDER CALIBRATION", there are input fields for "Feeder #:" (containing "#"), "Cal Wt:" (containing "#####"), "Cal Spd:" (containing "####"), and "Current Wt" (containing "##.###"). Below these are two buttons: "Press Here to Begin" and "Abort". A status bar at the bottom left shows "Please Wait... Filling Flights" and a "Range:###.# to #####.#" field. On the right, under the heading "CAL VALUES", there is a vertical list of six feeders, each with a corresponding calibration value field containing "#####". A "DONE" button is located at the bottom right of the interface.

### Setting Hopper Size

As the blenders are provided in several sizes and output ranges, the system will need to know what size all of the weigh hoppers are on the blender.

The following is a reference guide for setting the hopper sizes. The hopper size can change based upon the material’s bulk density. After a weight has been assigned to the hopper, it should be monitored the first time it is filled to check the level. The hopper size can be adjusted, depending upon whether the level in the hopper is too high or too low. Keep the hopper level full at least 2 to 3 inches below the upper surge hopper refill valve.

**Figure 12: Hopper Sizes**

Hopper Diameter (inches)	Approximate Hopper Capacity (@35 lbs. / cu. ft.)
9	7
12	14
14	18
20	40
24	60

Above lists standard sizes and can vary depending on the blender requirements and rates to be blended. Larger hopper sizes are available on custom order.

**Setting hopper size**

Touch the “ACS Group” logo and enter password “5413”.

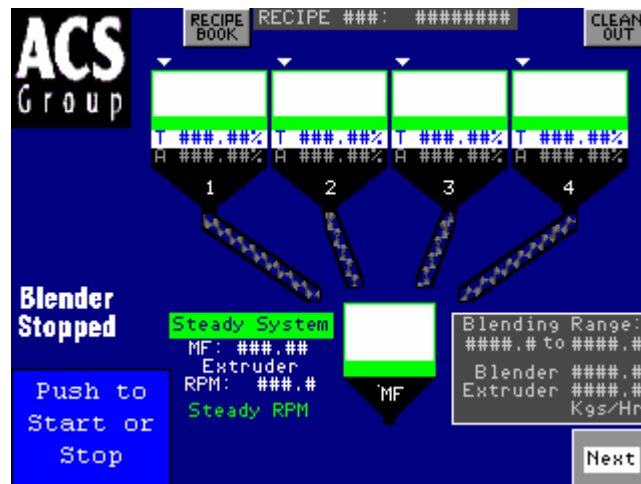

Touch the "OK" button.

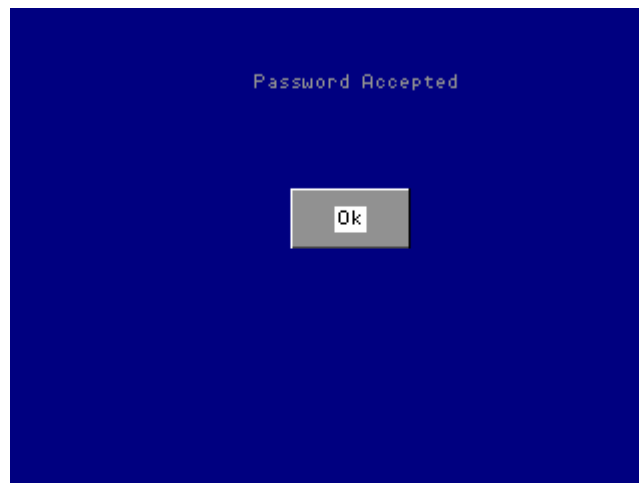

Touch “Hopper Setup”



Touch the box next to the hopper number that you want to change and enter weight value.



### Setting Passwords

There are three levels of password security for the control system.

- **User** (factory set to “5413”)
- **Service**
- **ACS only** (cannot be changed factory set to “3145348”)

To change a password proceed as follows:

Touch the “ACS Group” logo.

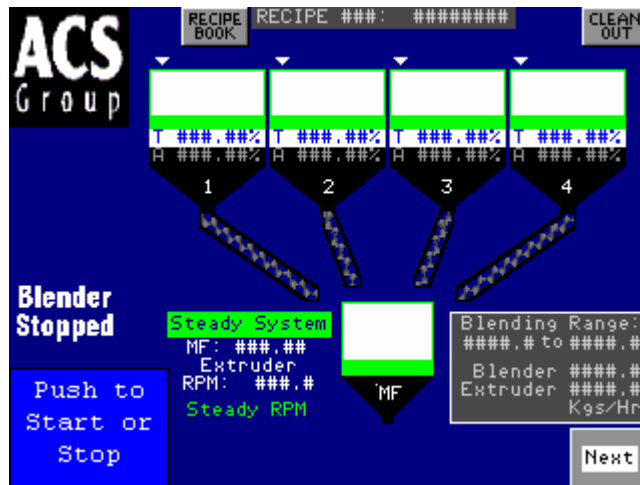

Enter password and touch “OK”.

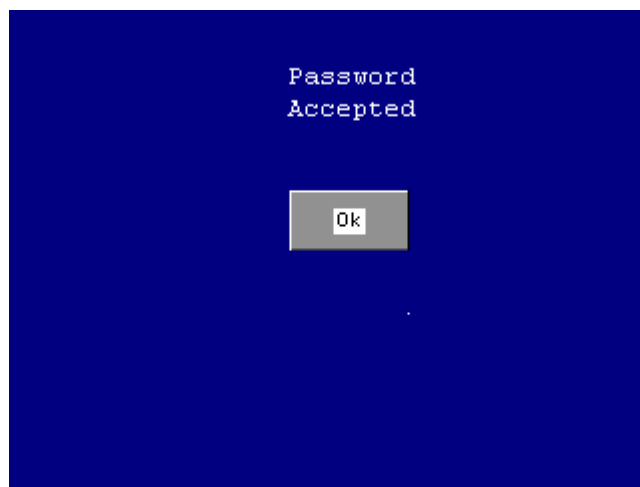

Touch “User Password”



- Enter original password.
- Touch box next to select operator until you see the level you want to set. (operator, service)
- Touch **New Password** and enter your new password
- Touch **Verify Password** and verify you new password



### Alarm Setup

There are several alarms in the blender control they are as follows:

- No Flow* - No weight loss is being detected on the feeder in question. This would indicate a faulty load cell, a material bridge in the re-fill hopper or something obstructing load cell movement.
- Re-fill too long* - Weigh hopper is not being re-filled in the allotted time. This would be caused by the supply hoppers not be kept full. Check the loading system.
- No material* - This means the weigh hopper is empty.
- Load cell Failure* - The controller is not properly reading the load cell. Check the load cell.
- Load cell over max* - The maximum weight limit on the load cell is exceeded. Check weigh hopper size and material bulk density.
- Extruder No Flow* - No weight-loss is being detected in the Mass Flow hopper. Make sure there is no material bridge above the extruder throat, or interference with the Mass Flow load cell.
- Blender Cannot keep up* - The extruder is running faster than the augers will allow the blender to run.

There are several options to set for the above listed alarms. The following explains the options and how to set them up.



First you must get to the Alarm Setup Page. To do this;  
Touch the “ACS Group” logo.

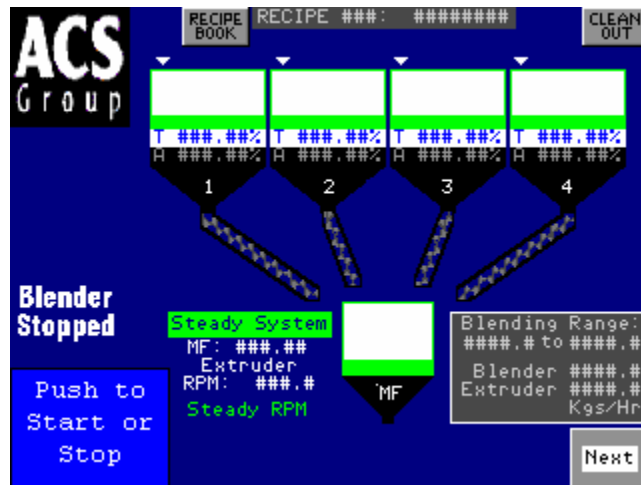

Enter the password and touch “OK”

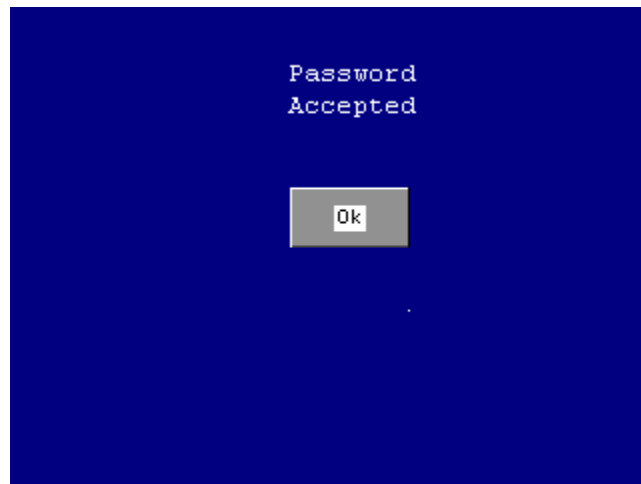

Touch “Alarm Setup”.

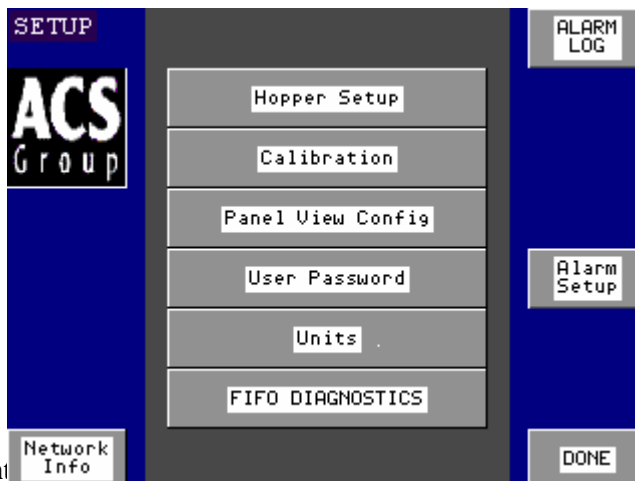

All alarm parameters are selectable.

If you do not want to use an alarm for a feeder, ensure the corresponding box has an “N” in it. To be enabled, the box must have a “Y” in it.

You can also decide to let the Blender continue to Run or Stop if an alarm is active. To do this, select “Stop” or “Run” in the boxes on the right.

“Pop-ups enabled” means the alarms will be shown on the screen. Select “Pop-ups disabled” if you don’t want to see the alarms on the screen.

“Extruder flow alarm” and “Blender cannot keep up alarm” can be enabled or disabled according to customer requirements.

ALARM SETUP		Select Y to enable alarm						MF	Popups Enabled
		1	2	3	4	5	6		
No Flow ALARM:		N	N	N	N	N	N	N	Stop
Reload Too Long ALARM:		N	N	N	N	N	N		
No Material ALARM:		N	N	N	N	N	N	N	Stop
Loadcell Failure ALARM:		N	N	N	N	N	N	N	Stop
Loadcell Over Max ALARM:		N	N	N	N	N	N	N	Stop
Extruder Flow ALARM	Disabled	Select Stop to Pause blender until problem is resolved							
Blender Cannot Keep Up ALARM	Disabled								DONE

## Communications

All Allen-Bradley Loss-in-weight blenders can be setup to communicate to a host via Ethernet, an optional Ethernet module must be purchased to allow communications. This can be used for loss-in-weight extrusion control or for data monitoring. The window below shows how to set up the 1761ENI Ethernet module.

```

NETWORK INFORMATION

TO MODIFY THE IP ADDRESS YOU WILL NEED:
-1761-CBL-PMO2 CABLE
-ALLEN BRADLEY ENI UTILITY

OPEN THE ENI UTILITY...
-connect the cable to PC
-click "load from ENI"
-uncheck "Obtain via BootIP"
-program the "ENI IP Address"
-click "Save to ENI ROM"
    
```

Done

## Setting Blender for English or Metric

Touch the “ACS Group” logo.

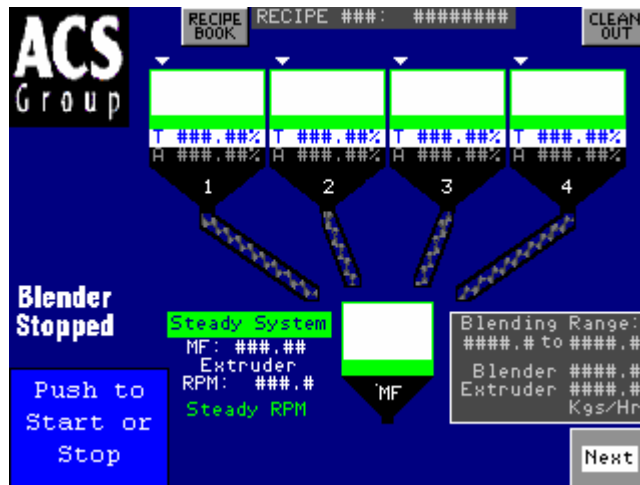

Enter the password and touch “OK”.

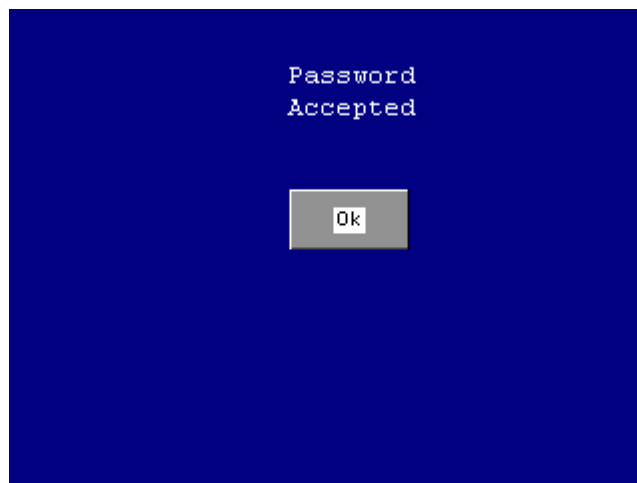

Touch “Units”.



Touch the box that says “**English Units**” to toggle between **English** and **Metric** \*\*\*\**Note, you must re-calibrate the blender and reset the inventory values if you change this value.*\*\*\*

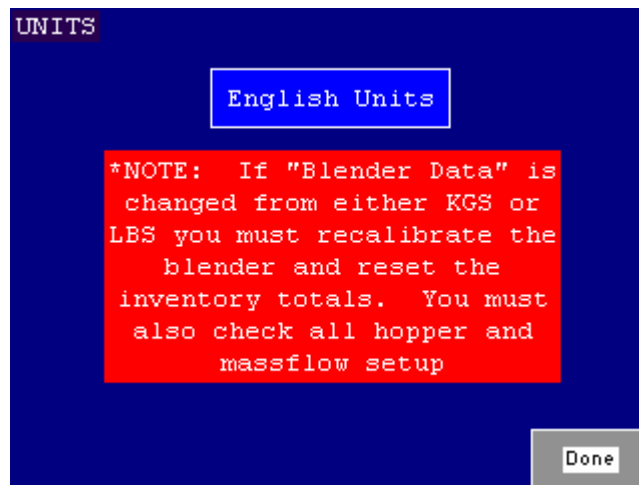

### How to use FIFO Diagnostics

First you must get to the FIFO screen.

Touch the “**ACS Group**” logo.

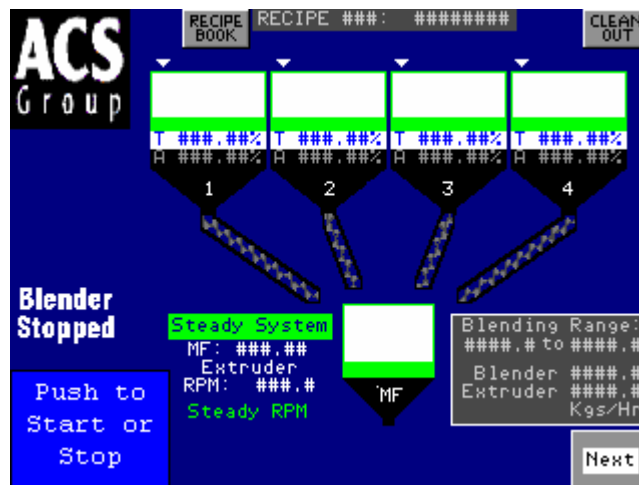

Enter the Password and touch **“OK”**

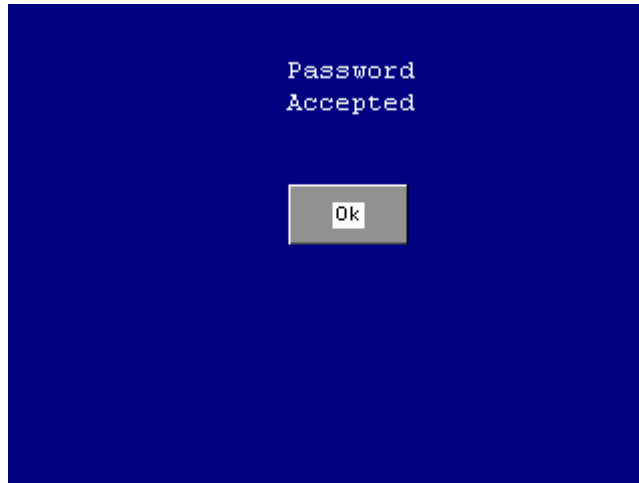

Touch **“FIFO Diagnostics”**



Select **“Mass Flow FIFO Data”** or **“Feeder FIFO Data”**

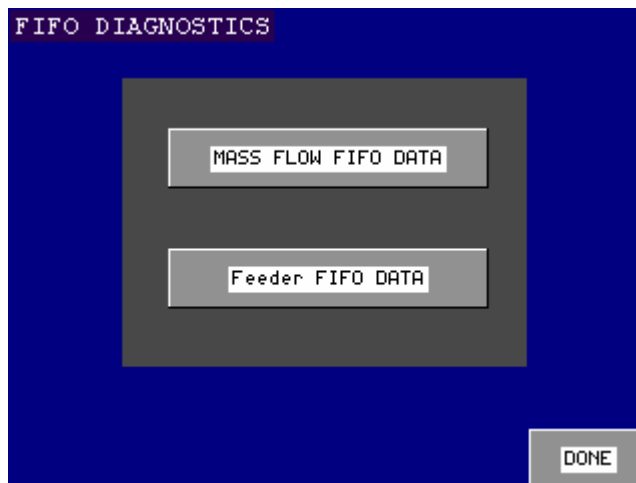

The Following screens will appear. This data is provided for trouble shooting blender stability problems. If you are not getting a steady system indication or if you are getting an unstable system alarm you can check here for the problem. This is a first in first in first out table. It takes an average and gives you a percent differential. If the steady flag is a "1", the hopper is steady. If it is a "0", it is not steady. This means that the percent differential is greater than what the value is set to on the advanced hopper page. The mass flow FIFO works the same way, only you have to calculate the % differentially manually.

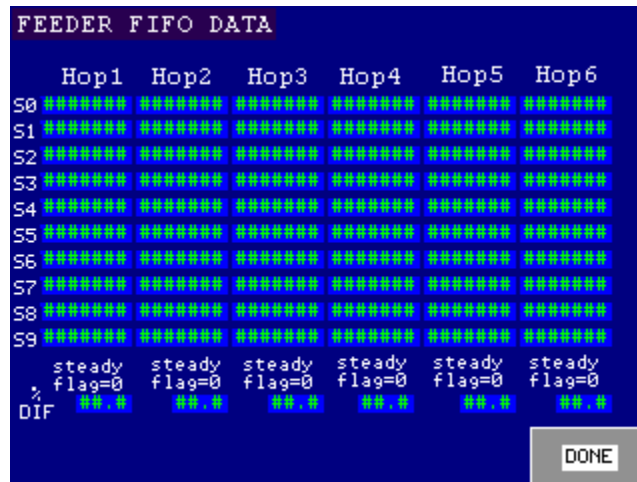
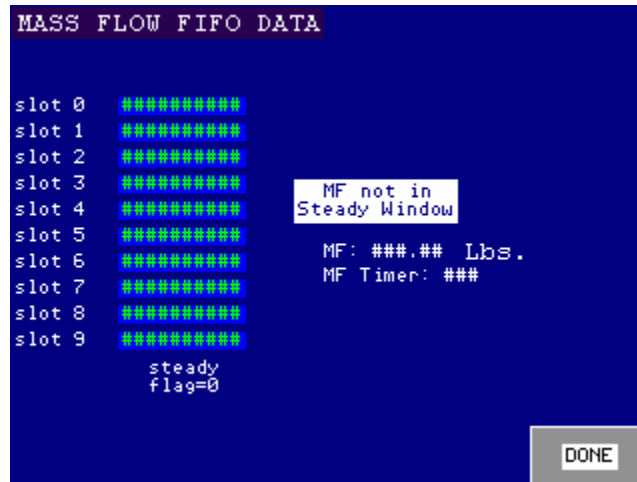

# Chapter 4: Operation

---

## 4-1 Start-up

The objective of this chapter is to familiarize the reader with the blender's recipe menu, run mode operation and displays. Upon completion of this chapter, the reader will be familiar with the recipe and run mode displays that are available on the continuous blending system.

The various sections within this chapter will be:

- General Operation
- Run Mode Display
- Recipe Menu

All personnel operating the blending system should read this section of the manual **BEFORE** operating the blending system.

### **General Operation**

The general operation of the Continuous blending system is as follows: Once the system is properly installed and set up, the system will be ready for operation. Please see the Installation and Setup chapter in this manual for further information.

Using the recipe menu, enter a valid recipe. After entering a recipe, the operator will startup the blending system. This will begin the general operation of the blending system.

**Note:** *Before starting the blending system, each ingredient hopper in the recipe MUST contain material.*

Once the operator initiates the run mode of operation, the blending system controller will start the metering devices. The metering units will start out at the maximum metering rate at speeds based on the feeder calibrations that were learned during the prior setup of the blender. The blender will output the maximum rate that is achievable with the feeder sizes, and the recipe percentage that is entered in the current recipe. Each metering unit will meter its material out of its respective weigh hopper at the correct rate to achieve the programmed blend ratio, and discharge it into the cascade material chute above the lower mass flow weigh hopper.

The metered ingredients cascade together into the weighed common hopper. The PLC looks at the weight change in the weighed common hopper over time, and learns "The discharge rate from the common weigh hopper to the processing machine." This "Discharge rate from the common hopper to the processing machine" is the learned rate that occurs internally within the weighed common hopper, and is the difference between the rate of material entering into the top of the common hopper and the rate of material flowing out of the bottom of the common hopper. The learned "Discharge rate from the common hopper to the processing machine", is added to the known total discharge rate from the blender weigh hoppers. The sum of these two rates calculates the actual flow rate out of the bottom of the blender. This is the processing rate of the processing machine that the blender is mounted on.

The blender will blend at a maximum rate when the lower mass flow weigh hopper has a very low weight of material. As the weight of material increases in the mass flow weigh hopper, the controller will adjust the blender feeders output to match the calculated processing machine rate. The blender will adjust in so that it is running a very closely matched rate to the extruder and readjust the ingredient hopper outputs accordingly.

The processing rate and the blending rate displayed on the blender control will not match exactly for any extended period of time as the dynamics of the extrusion process produces a continuously changing rate for the extruder. The blender will follow this dynamic changing rate very closely. The learned processing rate is accurate enough for mono-layer extrusion yield control or co-extrusion layer thickness control.

If the extruder is slowed or stopped suddenly, the blender will reach the high weight point in the lower mass flow hopper, slow down, and stop the metering devices so the weigh hopper will not overflow.

### **Manual Backup Control System**

Every continuous blender is equipped with a secondary manual backup control system. This allows the blender to be switched over to manual operation. In this mode, the feeder speeds are adjusted manually, and the blender will run, blending volumetrically. The lower mass flow weigh hopper is equipped with a proximity sensor mounted on the upper level of the hopper. This is for the manual operation to cycle the metering augers if the level of material in the weigh hopper reaches a high level.

This secondary control will allow the blender to be operated to provide production in the event of a control failure. After correction, the blender can be switched back into automatic operation.

When the blender is running in steady automatic mode, simply check the motor voltages (or) frequency readouts and record them. Then the drives can simply be “dialed in” for emergency volumetric operation.



## 4-2 Controller Description & Operation

### Display Description

The controller on the continuous loss-in-weight blender, utilizes a LCD touch screen display.

Figure 14: Typical Controller Display

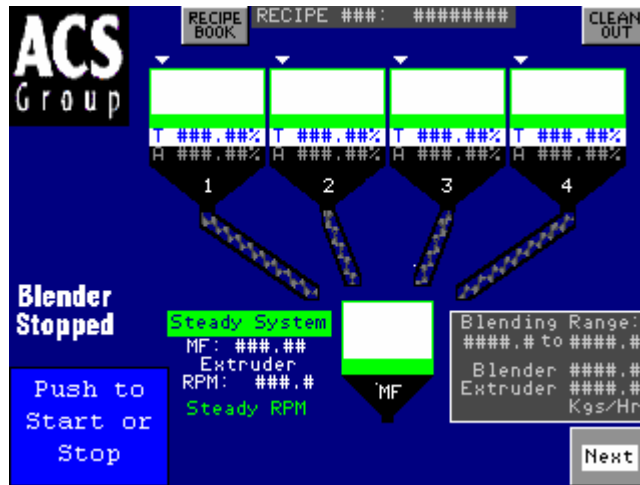

A typical menu entry is shown in the figure above.

Please refer to the blender menu structure shown in Figure 13 on the next page. This figure shows a standard menu structure for the blending system.

**Figure 15: Blender Menu Structure (Standard Unit)**

**Continuous Loss-in-weight Blender Control System Menu Structure**

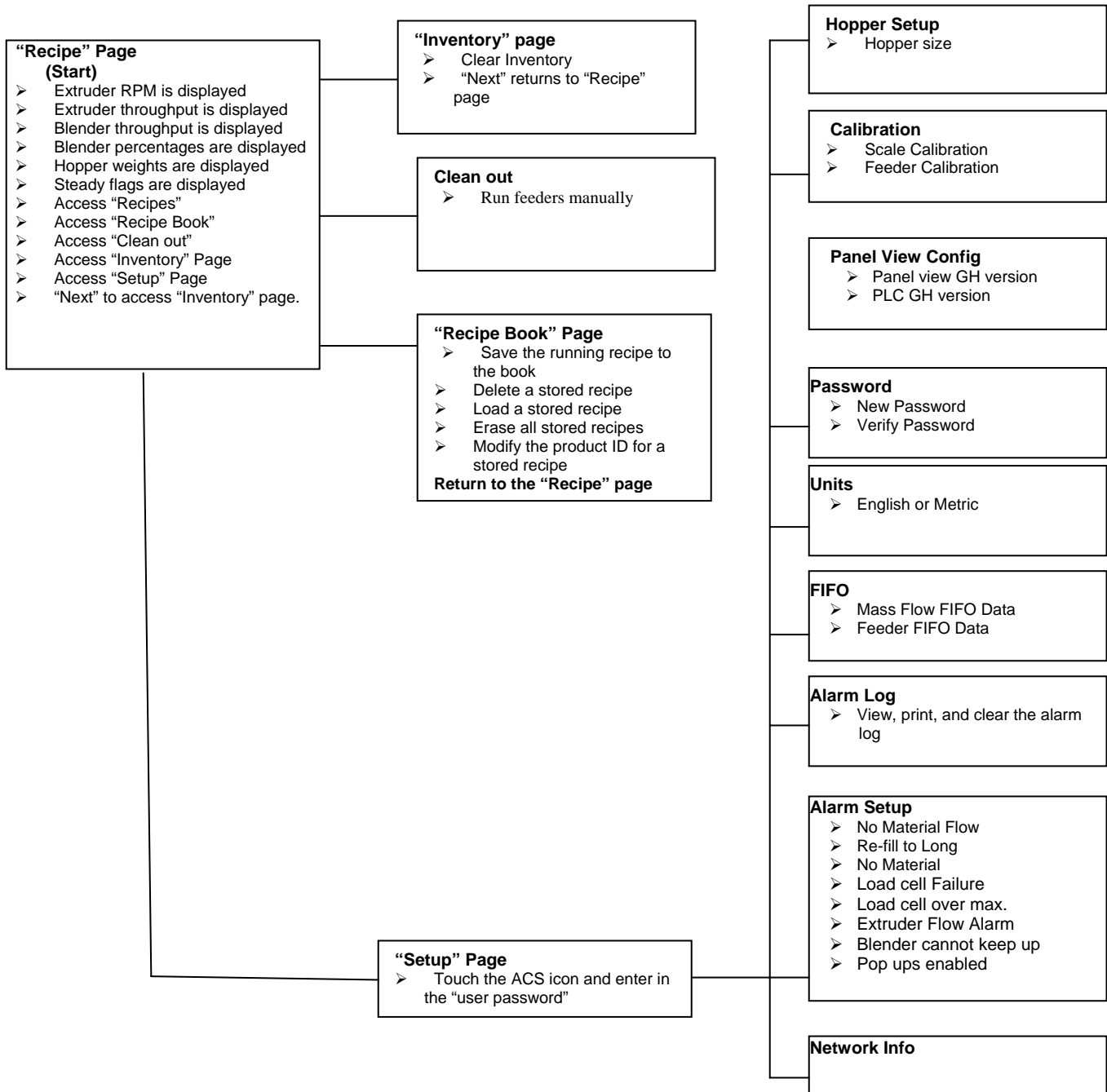

### Setting a Recipe

- To set a recipe, touch the hopper you want to change, a keypad will pop up, enter the desired percentage for the hopper.

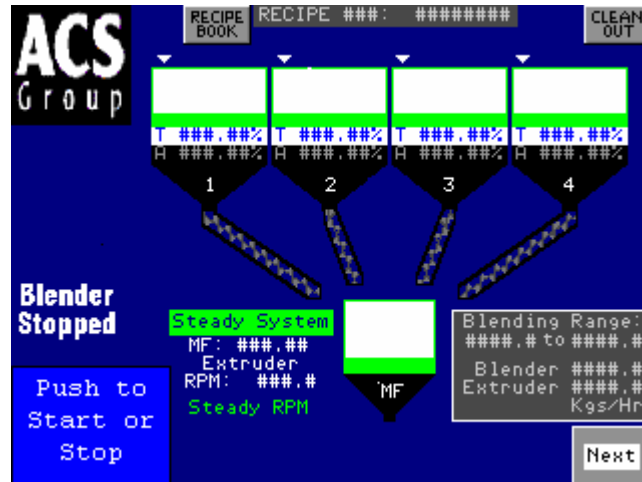

### Clean Out

- Touching the "Clean Out" button will take you to the page to manually run the motors.

# Chapter 5: Maintenance

## 5-1 Preventative Maintenance Schedule

The mechanical design of the blender is simple and little maintenance is required. The only moving parts are the re-fill valves, optional regrind agitators, metering augers, and optional discharge slide gates. The checklist below contains a list of items which should be inspected and/or replaced to keep your blender operating at peak efficiency. Perform each inspection at the regular intervals listed below.

**Figure 52: Sample Preventative Maintenance Schedule**

System model #						Serial #							
Daily	Date/By	Date/By	Date/By	Date/By	Date/By	Date/By	Date/By	Date/By	Date/By	Date/By	Date/By	Date/By	Date/By
Inspect all hoppers for any loose parts - tighten them immediately.													
Verify quality of compressed air supply.													
Inspect all weigh hoppers for obstructions.													

Every week	Date/By	Date/By	Date/By	Date/By	Date/By	Date/By	Date/By	Date/By	Date/By	Date/By	Date/By	Date/By	Date/By
Verify the blender is properly calibrated.													
Check to make sure that all hose connections are air tight.													

Every month	Jan	Feb	Mar	Apr	May	Jun	Jul	Aug	Sep	Oct	Nov	Dec
Inspect air regulator and air safety circuits, if equipped.												
Recalibrate if necessary.												

**Photocopy this page for your maintenance records**

**Note: Other service problems or questions can be answered by contacting the Service Department.**

# Chapter 6: Appendix

## 6-1 Spare Parts

### Typical Blender Parts List

#	DESCRIPTION	015	060	100
1	Lid (0.2 to 1.6 cu. ft. vacuum receivers)	08223-1	08278A	08412-1
	Lid (3.0 and 6.0 cu. ft. vacuum receivers)	N/A	N/A	A0770325
2	1/8" NPT fitting	35085K and 35086K		
3	1/4" NPT fitting	35154 and 35155		
4	Bulkhead	35146		
5	Brass elbow	35118		
6	24V DC Solenoid	33128		
7	Dump cone	15370	15237	
8	Air cylinder	33126	33073	33011G

### Typical Weigh Hopper Assembly Parts List

	7 kgs.	10 kgs.	15 kgs.	30 kgs.	150 kgs.
Load cells	724.00835.00	724.00836.00	724.00832.00	724.00839.00	61-1250-150KG

### Figure 64: Typical Allen-Bradley Controller Main Parts List

#	Description	ALL MODELS
1	Allen-Bradley SLC 500, CPU	A0555198
2	24 VDC power supply	A0563932
3	12 VDC power supply	739.00027.00
4	Alarm light - Yellow strobe 24 VDC	A0565889
5	Glass fuse – 3.0 amp (115 volt)	A0542207
6	Ethernet module (optional)	A0563939
7	Ethernet module cable	700.00278.00
8	120 volt light bulb (power switch)	715.01034.02

### Figure 65: Typical Allen-Bradley Display Main Parts List

#	Description	All MODELS
1	Allen-Bradley PanelView Display <i>ONLY</i>	A0563571
2	Allen-Bradley PanelView flash memory card	CONSULT FACTORY
3	PanelView 600 display – Connection cable	A0565856

## **Annex B Information**

The following design information is provided for your reference:

1. No modifications are allowed to this equipment that could alter the CE compliance
2. Ambient temperature: 40 degrees Celsius (104 degrees Fahrenheit) – Maximum
3. Humidity range: 50% relative humidity
4. Altitude: Sea level
5. Environment: Clean, dust-free and non-explosive
6. Radiation: None
7. Vibration: Minimal, i.e. machine mounting
8. Special installation requirements: Clean, dry compressed air 1 cfm @ 60 psi  
(1.7 m<sup>3</sup>/hr @ 4.14 bar)
9. Allowable voltage fluctuation: +/- 10%
10. Allowable frequency fluctuation: Continuous +/- 1%  
Intermittent +/- 2%
11. Nominal supply voltage: 120/1/60 or 220/1/50 or 60 (Verify on serial number tag)
12. Earth ground type: TN (system has one point directly earthed through a protective conductor)
13. Power supply should include a neutral power connection.
14. Over-current protection is supplied in the blender control panel, but additional protection should be supplied by the user.
15. The plug on the power cord serves as the electrical disconnect device.
16. Unit is equipped with three-phase motors (driven by single phase motor drive cards).
17. Functional identification
18. Cable support may be required for power cord, depending on final installation.
19. No one is required to be in the interior of the electrical enclosure during the normal operation of the unit. Only skilled electricians should be inside the enclosure for maintenance.
20. Doors can be opened with a screwdriver, but no keys are required.
21. Two-hand control is not required, or provided.
22. All hoppers should be moved around and set in place with a lift truck or equivalent.
23. There are no frequent repetitive cycles that require manual control—repetitive functions are automatic while the blender is operating.
24. An inspection report detailing the functional test is included with the OL blender.
25. The machine is not equipped with cableless controls.
26. Color-coded (harmonized) power cord is sufficient for proper installation.

## 6-2 Addendum (Service Supervisor Information)

**Note:** Personnel not extremely familiar with this blender controller should not use this section of the manual, or program can be compromised!

**Note:** Hidden, programmable features and hidden menu pages should not be made available to floor operators. These pages also include the Service Supervisor Information addendum located in this section. Unauthorized changes to these factory settings by inexperienced operators may prevent the unit from operating properly, and may void part or all of the warranty.

**Caution!** *After all selections are made: Keep pressing the “Done” key until the unit returns to the Recipe menu.*

**Note:** Inexperienced operators or plant personnel should not access programmable features. Unauthorized changes may prevent the blender from operating properly and may void part or all of the warranty.

**Note:** Call the Service Department for assistance or for further explanation of these or any other programmable features, which may or may not be shown in this manual.

**Note:** Information included in this manual is subject to change without notice.

### Passwords

- User Password “5413”
- Maintenance Password “3145348”

**Caution!** *Maintenance password should only be supplied to qualified personnel! The program can be compromised.*

### Programmable Settings

The Blender software program has been designed to allow some customizing to achieve certain desired operating parameters. The following is a listing of the selections that are “field” programmable, followed by the procedure for doing so.

Pressing the manufacturer’s icon when in the “Setup” Directory Screen menu accesses this menu.



Once you access the Engineering Menu you will see the following.

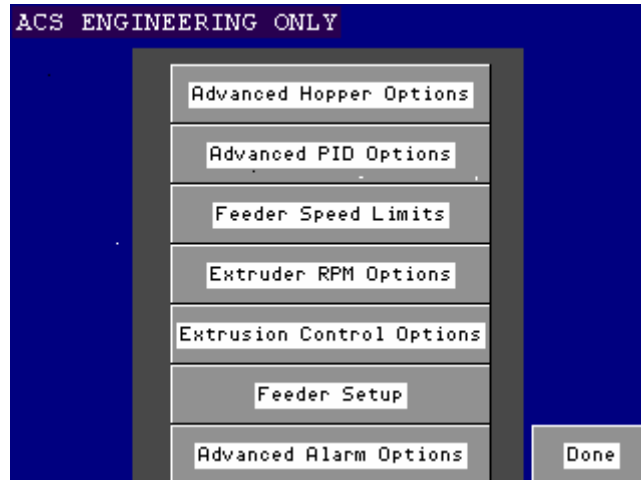

This is where you make adjustments to fine tune the blender's performance. You will need to assess the FIFO page previously mentioned in the manually to decide what changes need to be made.

The following pages will show you the setup parameters and how to adjust them.

### Advanced Hopper Options

	Feed Factor Filter	Steady Feed Factor	Max WTP/RPM	Reload %	Learn %
1	##	####	##	##.#	##.#
2	##	####	##	##.#	##.#
3	##	####	##	##.#	##.#
4	##	####	##	##.#	##.#
5	##	####	##	##.#	##.#
6	##	####	##	##.#	##.#
MF	##	####	##	##.#	

Done

### **Feed Factor Filter**

This filter allows you to set the number of snapshots that the FIFO page looks at to find the average deviation. Making this number bigger will cause the feeder to make changes slowly, and decreasing the number will make changes faster. You may want to make this number smaller on a feeder with a low feed rate.

### **Steady Feed Factor**

This is the parameter that sets the percent deviation allowed for the feeder to give a stable flag. The lower the percentage the more accurate the feed. With hard to feed materials or materials that vary in bulk density you may have to increase this number. Also if a lot of vibration is occurring that cannot be resolved you may have to increase this.

### **Max WTP/RPM**

This is the maximum weight through put per RPM allowed. This is settable in case you have a very large auger that you are trying to run at a low feed rate. This will help to keep the auger from making rapid adjustments.

### **Re-fill Percentage**

This is the level the hopper will go down to before re-filling.

### **Learn Percentage**

This is the size of the snapshot previously mentioned. Increasing this gives you better stability with materials that vary in bulk density or do not flow consistently. Decreasing this gives you faster updates on the FIFO page for materials that are relatively uniform.

### **Summary**

When adjusting the above parameters you will want to look at the FIFO page and analyze the information given. You should be able to determine from the percent deviation what changes to make. For example if an additive takes a long time to give a steady flag you may want to lower the Feed Factor Filter or Lower the learn percentage. When making changes do make them one at a time and observe the FIFO page for results. Another common example is you are running regrind through a feeder and your not getting a steady flag because your percent deviation is too high. You may want to increase the Steady Feed Factor or you could increase the Learn Percentage. A larger Learn Percentage is usually more stable than a small percentage.

## Advance PID Options (mass flow setup)

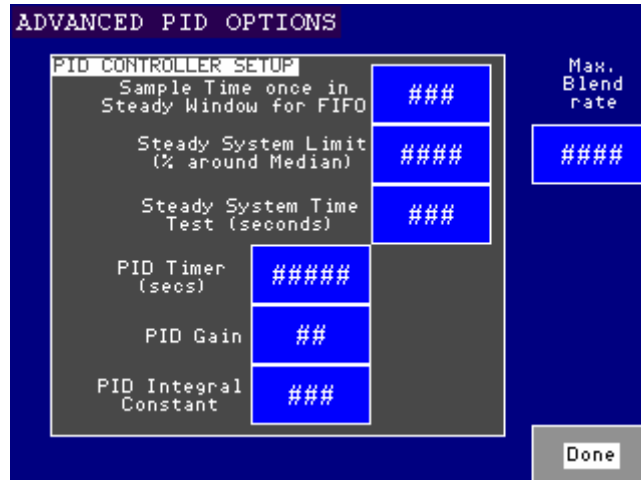

### Sample Time once in Steady Window for FIFO

This is how often the control takes snap shots of the mass flow hopper and enters the number in the FIFO table. For quicker FIFO updates you would decrease this number. For a more stable process you would increase this number.

### Steady System Limit

This is the allowable percent deviation around the median. The median will be half way between the re-fill set point and the hopper size set point. For material that varies in bulk density or does not flow consistently you may have to increase the limit.

### Steady System Time Test

This timer is used to determine whether or not to show the Steady System flag on the main control screen. Rather than going in and out of stable, the process must remain stable for the set time and then the Steady System will be shown.

### PID Timer

This is the amount of time that the blender will run without making a change to the auger speeds to adjust the blender though put i.e. pounds per hour.

### PID Gain

The gain increase or decreases the size and speed of the adjustments made to the PID. A smaller number makes slower adjustments. A bigger number makes faster adjustments.

### PID Integral Constant

Works the same as the Gain.

### Feeder Speed Limits

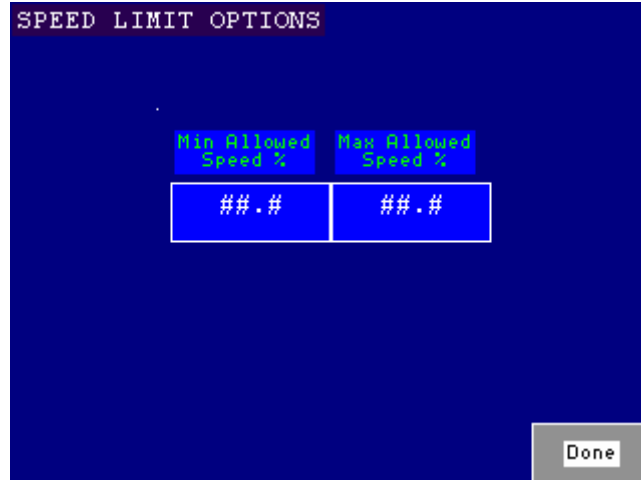

This allows you to set the minimum and maximum speed for the motor drives as a percentage. The drives are not supposed to be run at less than 8 hertz and should not be run above 115 hertz.

### Extruder RPM Options

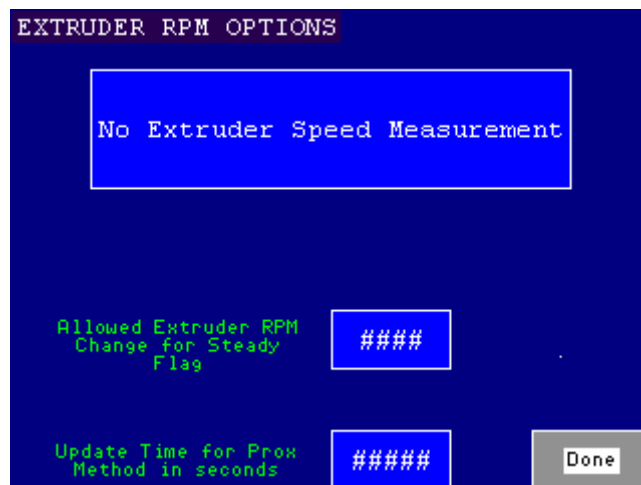

This gives you the option of having no extruder speed input, writing the extruder speed to the blender through the Ethernet, or using a proximity sensor on the end of the extruder screw.

### Allowed Extruder RPM Change for Steady Flag

This is how much the extruder RPM can vary and still be considered steady. With no extruder measurement the control always assumes a steady RPM.

### Update Time for Prox Method in seconds

This is how often the extruder speed updates from the prox.

### Extrusion Control Options



### Feeder Setup



This screen allows you to enter the maximum auger speed in Hertz.

## Advanced Alarm Options

	No Flow Timer	No Flow Bits	System Unstable Alarm Time
1	###	###	####
2	###	###	
3	###	###	
4	###	###	
5	###	###	
6	###	###	
NF	###	###	

Done

This alarm is for no material flow through a auger, this could be caused by a blockage stopped motor etc.

### No Flow Timer

This is the amount of time used to measure the bit flow (weight loss) through a hopper, to determine if an alarm is warranted.

### No Flow Bits

This is the amount of weight loss in a set amount of time (No Flow Timer) to sound an alarm.

*Please contact the ACS Service Department with any other questions.*

## 6-3 Technical Assistance

### ***Parts Department***

Call toll-free 7 am–5 pm CST 800.423.3183 or call 262.641.8610 Fax 262.641.8653

The ACS Customer Service Group will provide your company with genuine OEM quality parts manufactured to engineering design specifications, which will maximize your equipment's performance and efficiency. To assist in expediting your phone or fax order, please have the model and serial number of your unit when you contact us. A customer replacement parts list is included in this manual for your convenience. ACS welcomes inquiries on all your parts needs and is dedicated to providing excellent customer service.

### ***Service Department***

Call toll-free 8 am–5 pm CST 800.423.3183 or call 262.641.8610  
Emergencies after 5 pm CST, call 847.439.5655

We have a qualified Service Department ready to help. Service contracts are also available for most of our products. See [www.acscustomerservice.com](http://www.acscustomerservice.com)

### ***Sales Department***

Call 262.641.8610 Monday–Friday, 8 am–5 pm CST

Our products are sold by a world-wide network of independent sales representatives. Contact our Sales Department for the name of the sales representative nearest you.

### ***Contracting Department***

Call 262.641.8610 Monday–Friday, 8 am–5 pm CST

Let us install your system. The Contracting Department offers any or all of these services: project planning; system packages including drawings; equipment, labor, and construction materials; and union or non-union installations

## Free Manuals Download Website

<http://myh66.com>

<http://usermanuals.us>

<http://www.somanuals.com>

<http://www.4manuals.cc>

<http://www.manual-lib.com>

<http://www.404manual.com>

<http://www.luxmanual.com>

<http://aubethermostatmanual.com>

Golf course search by state

<http://golfingnear.com>

Email search by domain

<http://emailbydomain.com>

Auto manuals search

<http://auto.somanuals.com>

TV manuals search

<http://tv.somanuals.com>