



SDAA 25-100 Small Dryer With AP-1 Controls

Part Number: 882.00294.00
Bulletin Number: DH1-610-2
Effective: 05/15/06

Write Down Your Serial Numbers Here For Future Reference:

_____	_____
_____	_____
_____	_____

We are committed to a continuing program of product improvement.
Specifications, appearance, and dimensions described in this manual are subject to change without notice.

DCN No. _____
© Copyright 2006
All rights reserved.

Shipping Information

Unpacking and Inspection

You should inspect your portable drying/conveying system for possible shipping damage.

Thoroughly check the equipment for any damage that might have occurred in transit, such as broken or loose wiring and components, loose hardware and mounting screws, etc.

In the Event of Shipping Damage

According to the contract terms and conditions of the Carrier, the responsibility of the Shipper ends at the time and place of shipment.

Notify the transportation company's local agent if you discover damage.

Hold the damaged goods and packing material for the examining agent's inspection. **Do not return any goods before the transportation company's inspection and authorization.**

File a claim with the transportation company. Substantiate the claim by referring to the agent's report. A certified copy of our invoice is available upon request. The original Bill of Lading is attached to our original invoice. If the shipment was prepaid, write us for a receipted transportation bill.

Advise customer service regarding your wish for assistance and to obtain an RMA (return material authorization) number.

If the Shipment is Not Complete

Check the packing list as back-ordered items are noted on it. You should have:

- Portable drying/conveying system
- Bill of lading
- Packing list
- Operating and Installation packet
- Electrical schematic and panel layout drawings
- Component instruction manuals

Re-inspect the container and packing material to see if you missed any smaller items during unpacking.

If the Shipment is Not Correct

If the shipment is not what you ordered, **contact the shipping department immediately**. For shipments in the United States and Canada, call 1 (800) 233-4819; for all other countries, call our international desk at (630) 475-7491. Have the order number and item number available. *Hold the items until you receive shipping instructions.*

Returns

Do not return any damaged or incorrect items until you receive shipping instructions from the shipping department.

Table of Contents

CHAPTER 1: SAFETY	6
1-1 How to Use This Manual	6
Safety Symbols Used in this Manual	6
1-2 Safety Tag Information	7
Dryer Safety Tags	7
1-3 Warnings and Precautions	7
1-4 Responsibility	8
General Responsibility	8
Operator Responsibility	9
Maintenance Responsibility	10
Reporting a Safety Defect	10
CHAPTER 2: FUNCTIONAL DESCRIPTION.....	11
2-1 Models Covered in This Manual	11
2-2 General Description.....	11
The Drying System	11
What is Desiccant.....	11
The Process/Regeneration Cycle.....	11
2-3 Standard Features.....	12
Mechanical Features	12
Electrical Features.....	12
Controller Features.....	12
2-4 Options	13
2-5 Safety Devices and Interlocks	13
Safety Circuit Standards.....	13
Fail Safe Operation	14
Safety Device Lock-Outs	14
CHAPTER 3: INSTALLATION	15
3-1 Uncrating the Equipment.....	15
3-2 Rigging and Placing the Dryer.....	15
3-3 Electrical Connections	17
3-4 Setup Procedures.....	18
Checking for Proper Blower Rotation	18
Drying Hopper Air Trap Considerations (If Equipped)	18
Installing the Optional Aftercooler.....	18
3-5 Initial Start-up	19
Pre-Startup Checks	19
Starting Up the Dryer.....	19
Auto-Tuning the Dryer	19
Shutting Down the Dryer	20
CHAPTER 4: OPERATION	21
4-1 Controller Description and Operation	21
Identifying Control Panel Components for the AP-1 Controller	21

Disconnect Switch	21
Control Power Switch	21
Touch Screen	21
Alarm Horn & Light	21
Process Air Temperature Controller	22
Startup Screen	22
Main Menu Screen	23
Dryer Status Screen	23
Start Button	24
Dryer Menu Screen	25
Dryer Status	25
Dryer Setup	25
Dryer Setup (Screen 1 of 3) Process Temperature High&Low ALarm	25
Dryer Setup (Screen 2 of 3) Choosing Degree F or Degree C	26
Dryer Setup (Screen 3 of 3) Process return air temperature	26
Overdry Protection Setup	26
Screen 1 of 2 (Enable or Disable the feature)	26
Screen 2 of 2 (Overdry Protection Parameter Settings)	27
Alarms	28
Auto Tune	28
Dew Pt Setup	29
Auto Start	29
Main Menu	30
Help Menu	30
System Menu	31
System Setup	31
Set Clock	32
Set Auto Start Clock	32
Set Alarm Clock	33
Hour Meters	33
Input Status	34
Output Status	34
System Setting	34
Service Menu	35
Alarm Screens	35
Redundant Safety Controller Display	36
Setting the Redundant Safety Controller	36
Restoring the WATLOW Redundant Safety Controller to Factory Setup	37
4-2 System Operation Procedures	38
4-3 Shutting Down the Dryer	39

CHAPTER 5: MAINTENANCE 40

5-1 Preventative Maintenance Schedule	40
5-2 Preventative Maintenance	41
Servicing Process Air Filters	41
Servicing the Dew Point Monitor	42
5-3 Corrective Maintenance	43
Symptoms of Worn Desiccant	43
Replacing Worn Desiccant	43
Replacing the Regeneration Heater	45

Replacing the Process Heater.....	45
Replacing/Cleaning the Cooling Coils	46
CHAPTER 6: TROUBLESHOOTING	48
6-1 Introduction.....	48
6-2 Determining Temperature Controller Errors or Sensor Errors.....	54
Using a Thermocouple	54
CHAPTER 7: APPENDIX	55
7-1 Warranty.....	55
Warranty Specifications.....	55
Warranty Restrictions	55
Warranty Liabilities	55
Customer Responsibilities	56
7-2 Optional Components.....	56
7-3 Technical Specifications.....	56
Annex B Information	56
Aftercooler Design Specifications.....	57
7-4 Drawings and Diagrams	57
7-5 Spare Parts List.....	60
7-6 Returned Material Policy	62
Credit Returns	62
Warranty Returns	62
7-7 Dryer Identification (Serial Number) Tag.....	62
7-8 Technical Assistance.....	63
Parts Department	63
Service Department.....	63
Sales Department.....	63
Contract Department	63

Chapter 1: Safety

1-1 How to Use This Manual

Use this manual as a guide and reference for installing, operating, and maintaining your drying system. The purpose is to assist you in applying efficient, proven techniques that enhance equipment productivity.

This manual covers only light corrective maintenance. No other maintenance should be undertaken without first contacting a service engineer.

The Functional Description section outlines models covered, standard features, and safety features. Additional sections within the manual provide instructions for installation, pre-operational procedures, operation, preventive maintenance, and corrective maintenance.

The Installation chapter includes required data for receiving, unpacking, inspecting, and setup of the drying system. We can also provide the assistance of a factory-trained technician to help train your operator(s) for a nominal charge. This section includes instructions, checks, and adjustments that should be followed before commencing with operation of the drying system. These instructions are intended to supplement standard shop procedures performed at shift, daily, and weekly intervals.

The Operation chapter includes a description of electrical and mechanical controls, in addition to information for operating the dryer safely and efficiently.

The Maintenance chapter is intended to serve as a source of detailed assembly and disassembly instructions for those areas of the equipment requiring service. Preventive maintenance sections are included to ensure that your drying system provides excellent, long service.

The Troubleshooting chapter serves as a guide for identification of most common problems. Potential problems are listed, along with possible causes and related solutions.

The Appendix contains technical specifications, drawings, schematics, parts lists, and available options. A spare parts list with part numbers specific to your machine is provided with your shipping paperwork package. Refer to this section for a listing of spare parts for purchase. Have your serial number and model number ready when ordering.

Safety Symbols Used in this Manual

The following safety alert symbols are used to alert you to potential personal injury hazards. Obey all safety messages that follow these symbols to avoid possible injury or death.

DANGER! *DANGER indicates an imminently hazardous situation that, if not avoided, will result in death or serious injury.*

WARNING! *WARNING indicates a potentially hazardous situation or practice that, if not avoided, could result in death or serious injury.*

Caution! *CAUTION indicates a potentially hazardous situation or practice that, if not avoided, may result in minor or moderate injury or in property damage.*

1-2 Safety Tag Information

Dryer Safety Tags



Hot!



**Read Operation
and Installation
Manual**



**High Voltage
Inside Enclosure**



Earth Ground



Lifting Point



**Protected Earth
Ground**

1-3 Warnings and Precautions

Our equipment is designed to provide safe and reliable operation when installed and operated within design specifications, following national and local safety codes. This may include, but is not limited to OSHA, NEC, CSA, SPI, and any other local, national and international regulations.

To avoid possible personal injury or equipment damage when installing, operating, or maintaining this equipment, use good judgment and follow these safe practices:

- Read and follow these operation and installation instructions when installing, operating, and maintaining this equipment. If these instructions become damaged or unreadable, additional copies are available from the manufacturer.**
- Follow all **SAFETY CODES**.
- Wear **SAFETY GLASSES** and **WORK GLOVES**.
- Work only with approved tools and devices.
- Disconnect and/or lock out power before servicing or maintaining the equipment.
- Use care when **LOADING, UNLOADING, RIGGING, or MOVING** this equipment.
- Operate this equipment within design specifications.
- OPEN, TAG, and LOCK ALL DISCONNECTS** before working on equipment. You should remove the fuses and carry them with you.
- Make sure the equipment and components are properly **GROUND** before you switch on power.
- Use **EXTEREME CAUTION** when working with dryer. **HIGH HEAT** can be dangerous. Keep body parts, tools, clothing, and debris away from dryer.

- ☑ When welding or brazing in or around this equipment, make sure **VENTILATION** is **ADEQUATE. PROTECT** adjacent materials from flame or sparks by shielding with sheet metal. An approved **FIRE EXTINGUISHER** should be close at hand and ready for use if needed.
- ☑ Do not restore power until you remove all tools, test equipment, etc., and the equipment and related components are fully reassembled.
- ☑ Only **PROPERLY TRAINED** personnel familiar with the information in this manual should work on this equipment.

We have long recognized the importance of safety and have designed and manufactured our equipment with operator safety as a prime consideration. We expect you, as a user, to abide by the foregoing recommendations in order to make operator safety a reality.

1-4 Responsibility

These machines are constructed for maximum operator safety when used under standard operating conditions and when recommended instructions are followed in the maintenance and operation of the machine.

All personnel engaged in the use of the machine should become familiar with its operation as described in this manual.

Proper operation of the machine promotes safety for the operator and all workers in its vicinity.

Each individual must take responsibility for observing the prescribed safety rules as outlined. All warning and danger signs must be observed and obeyed. All actual or potential danger areas must be reported to your immediate supervisor.

General Responsibility

No matter who you are, safety is important. Owners, operators and maintenance personnel must realize that every day, safety is a vital part of their jobs.

If your main concern is loss of productivity, remember that production is always affected in a negative way following an accident. The following are some of the ways that accidents can affect your production:

- Loss of a skilled operator (temporarily or permanently)
- Breakdown of shop morale
- Costly damage to equipment
- Downtime

An effective safety program is responsible and economically sound.

Organize a safety committee or group, and hold regular meetings. Promote this group from the management level. Through this group, the safety program can be continually reviewed, maintained, and improved. Keep minutes or a record of the meetings.

Hold daily equipment inspections in addition to regular maintenance checks. You will keep your equipment safe for production and exhibit your commitment to safety.

Please read and use this manual as a guide to equipment safety. This manual contains safety warnings throughout, specific to each function and point of operation.

Operator Responsibility

The operator's responsibility does not end with efficient production. The operator usually has the most daily contact with the equipment and intimately knows its capabilities and limitations.

Plant and personnel safety is sometimes forgotten in the desire to meet incentive rates, or through a casual attitude toward machinery formed over a period of months or years. Your employer probably has established a set of safety rules in your workplace. Those rules, this manual, or any other safety information will not keep you from being injured while operating your equipment.

Learn and always use safe operation. Cooperate with co-workers to promote safe practices. Immediately report any potentially dangerous situation to your supervisor or appropriate person.

REMEMBER:

- **NEVER** place your hands or any part of your body in any dangerous location.
- **NEVER** operate, service, or adjust the equipment without appropriate training and first reading and understanding this manual.
- **NEVER** try to pull material out of the equipment with your hands while it is running!
- Before you start the portable drying/conveying system check the following:
 - Remove all tools from the equipment;
 - Be sure no objects (tools, nuts, bolts, clamps, bars) are laying in the hopper area;
- If your portable drying/conveying system has been inoperative or unattended, check all settings before starting the unit.
- At the beginning of your shift and after breaks, verify that the controls and other auxiliary equipment are functioning properly.
- Keep all safety guards in place and in good repair. **NEVER** attempt to bypass, modify, or remove safety guards. Such alteration is not only unsafe, but will void the warranty on your equipment.
- When changing control settings to perform a different mode of operation, be sure selector switches are correctly positioned. Locking selector switches should only be adjusted by authorized personnel and the keys removed after setting.
- Report the following occurrences **IMMEDIATELY**:
 - unsafe operation or condition
 - unusual dryer/conveying system action
 - leakage
 - improper maintenance

- **NEVER** stand or sit where you could slip or stumble into the equipment while working on it.
- **DO NOT** wear loose clothing or jewelry, which can be caught while working on the equipment. In addition, cover or tie back long hair.
- Clean the equipment and surrounding area **DAILY**, and inspect the machine for loose, missing or broken parts.
- Shut off power to the equipment when it is not in use. Turn the switch to the **OFF** position, or unplug it from the power source.

Maintenance Responsibility

Proper maintenance is essential to safety. If you are a maintenance worker, you must make safety a priority to effectively repair and maintain equipment.

Before removing, adjusting, or replacing parts on a machine, remember to turn off all electric supplies and all accessory equipment at the machine, and disconnect and lockout electrical power. Attach warning tags to the disconnect switch.

When you need to perform maintenance or repair work on equipment above floor level, use a solid platform or a hydraulic elevator. If there is a permanently installed catwalk on your equipment, use it. The work platform should have secure footing and a place for tools and parts. **DO NOT** climb on machines or work from ladders.

If you need to repair a large component, use appropriate handling equipment. Before you use handling equipment (portable “A” frames, electric boom trucks, fork trucks, overhead cranes) be sure the load does not exceed the capacity of the handling equipment or cause it to become unstable.

Carefully test the condition of lifting cables, chains, ropes, slings, and hooks before using them to lift a load.

Be sure that all non-current carrying parts are correctly connected to earth ground with an electrical conductor that complies with current codes. Install in accordance with national and local codes.

When you have completed the repair or maintenance procedure, check your work and remove your tools, rigging, and handling equipment.

Do not restore power to the equipment until all persons are clear of the area. **DO NOT** start and run the machine until you are sure all parts are functioning correctly.

BEFORE you turn the machine to the operator for production, verify all equipment enclosure panels, guards and safety devices are in place and functioning properly.

Reporting a Safety Defect

If you believe that your equipment has a defect that could cause injury, you should immediately discontinue its use and inform the manufacturer.

The principle factors that can result in injury are failure to follow proper operating procedures (i.e. lockout/tag out), or failure to maintain a clean and safe working environment.

Chapter 2: Functional Description

2-1 Models Covered in This Manual

This manual provides operation, installation, and maintenance instructions for 15, 30 or 60 cfm dehumidifying dryers. Model numbers are listed on the serial tag. Make sure you know the model and serial number of your equipment before contacting the manufacturer for parts or service.

Our dehumidifying mini dryers are designed to generate heated dehumidified air (at a very low dew point) at carefully controlled temperatures for use in plastic drying systems. The dryer circulates hot dehumidified air through a column of plastic resin in the large drying hopper. The resin in the hopper is discharged through a slide gate in a “first in, first out” manner.

2-2 General Description

The Drying System

Dehumidifying dryers are used to generate very low dew point air heated to a controlled temperature for drying plastic pellets and regrind.

Our dryers force hot, dry air through resin in a drying hopper, where air picks up moisture from the material and draws it back to the dryer. In the dryer, a desiccant bed strips moisture from the air. The dried process air is then re-heated and delivered back into the drying hopper for more moisture removal.

Portion of the low dew point process air is directed to the desiccant tank that is off process. This air is heated to approximately 450°F (232°C) before entering the bed that is in regeneration. The moisture is then forced from the desiccant before being exhausted into the atmosphere. A small amount of ambient air is introduced into the process return air filter to make up for the air lost during the bed regeneration. To compensate for the humidity content in the air, this dryer is supplied with the proper amount of desiccant.

What is desiccant?

Desiccant is a material that attracts and holds (absorbs) water from the air. The desiccant our dryers use is a synthetic crystalline metal aluminosilicate blended with a clay binder and formed into beads.

The Process/Regeneration Cycle

Our dryers have two desiccant beds. While one bed is on-line in the process air loop, the other is off-line, being regenerated.

When a desiccant bed is on-line, it absorbs moisture from the process air. In time, the bed becomes saturated with moisture and needs to be regenerated. The dryer automatically redirects the process airflow to the second bed, and starts the regeneration cycle on the first bed.

During regeneration, the dryer system heats the very low dew point air and forces it through the desiccant bed. The moisture driven off the bed bleeds to the atmosphere.

2-3 Standard Features

Mechanical Features

- Rugged compact cart with handles and sturdy 4" (10 cm) casters.
- Dual desiccant beds
- Electrically-motorized air valve
- 13X Molecular Sieve
- Single regenerative process blower
- Drying temperature range of 180°F to 250°F (82°C to 121°C)
- 2.5" hose connections

Electrical Features

- Process thermocouple to be connected to drying hopper air inlet.
- Nema 12 control enclosure
- NFPA79 machinery electrical standards
 - Non-fused electrical disconnect
 - Branch fusing
 - Solid State process heater contactor
 - Regeneration temperature control
 - Process high temperature alarm light
 - Dirty filter indicator
 - Process/regeneration heater box
 - Dew Point Monitor.
 - Material saver/over dry protection
 - High temperature safety system (Process/Regeneration)
 - 7 day timer/auto start

Controller Features

- Mitsubishi programmable relay controller
- Display of process temperature set point and actual settings
- Display of process air dew point

2-4 Options

Options marked with “*” indicate options that can be factory installed or retrofitted in the field.

- * Process temperature up to 400°F (204° C), including aftercooler with dryer and silicone insulated delivery hose.

Note: For below 180°F (82°C), cooler needs to cool the air coming out of the desiccant tank prior to entering the process heater box.

- * If the dryer is a central dry air generator, it will not have a process heater box.
- * Plasticizer trap (with cooling coil) in lieu of standard aftercooler (mounts outside on back of dryer).
- * Drawer magnet, stainless steel construction.
- * Casters, two (2) fixed and two (2) swivels.
- * Machine mount adapter to accommodate a dryer and corresponding hopper.
- * Low temperature operation below 180°F (82°C), includes an internal cooler.
- * Redundant high temperature safety circuit.
- * Cart with caster with hopper mounting place.
- * Low level indicator(s).
- * Insulated air hose for air delivery.
- * RPV for drying hopper

2-5 Safety Devices and Interlocks

This section includes information on safety devices and procedures that are inherent to the drying system. This manual is not intended to supersede or alter safety standards established by the user of this equipment. Instead, the material contained in this section is recommended to supplement these procedures in order to provide a safer working environment.

At the completion of this section, the operator and maintenance personnel will be able to do the following:

- Identify and locate specific safety devices.
- Understand the proper use of the safety devices provided.
- Describe the function of the safety device.

Safety Circuit Standards

Safety circuits used in industrial systems protect the operator and maintenance personnel from dangerous energy. They also provide a means of locking out or isolating the energy for servicing equipment.

Various agencies have contributed to the establishment of safety standards that apply to the design and manufacture of automated equipment. The Occupational Safety and Health Administration (OSHA) and the Joint Industrial Council (JIC) are just a few of the organizations that have joined with the plastics industry to develop safety standards.

Every effort has been made to incorporate these standards into the design of the drying system; however, it is the responsibility of the personnel operating and maintaining the equipment to familiarize themselves with the safety procedures and the proper use of any safety devices.

Fail Safe Operation

If a safety device or circuit should fail, the design must be such that the failure causes a “Safe” condition. As an example, a safety switch must be a normally open switch. The switch must be held closed with the device it is to protect. If the switch fails, it will go to the open condition, tripping out the safety circuit.

At no time should the safety device fail and allow the operation to continue. For example, if a safety switch is guarding a motor, and the safety switch fails, the motor should not be able to run.

Safety Device Lock-Outs

Some safety devices disconnect electrical energy from a circuit. The safety devices that are used on this equipment are primarily concerned with electrical power disconnection and the disabling of moving parts that may need to be accessed during the normal operation of the machine.

Some of the safety devices utilize a manual activator. This is the method of initiating the safety lock out. This may be in the form of a plug, lever or a handle. Within this lockable handle, there may be a location for a padlock. Personnel servicing the equipment should place a padlock in the lockout handle.

In addition to the safety devices listed above, these dryers are equipped with a line cord plug. This allows the operator or maintenance personnel to unplug the dryer from its power source and tag it out. The plug can then be tagged with any number of approved electrical lockout tags available at most electrical supply stores.

WARNING! Always disconnect and lockout all electrical power and pneumatic (i.e. compressed air) sources prior to servicing or cleaning this equipment. Failure to do so may result in serious injury. No one but the person who installed the lockout may remove it.



Chapter 3: Installation

3-1 Uncrating the Equipment

Portable Drying/Conveying Systems are shipped mounted on a skid, enclosed in a plastic wrapper, and contained in a cardboard box.

1. Pry the crating away from the skid.

Note: Remove the nails holding the box to the skid and lift the box off carefully; avoiding staples in the 1' x 4' wood supports. Cut the steel banding.

2. Use a pry bar to remove the blocks securing the unit to the skid.
3. Lift unit from sides. Use a pry bar if necessary to carefully remove the skid from the unit.
4. Lower slowly.

3-2 Rigging and Placing the Dryer

Take care when rigging and placing the drying and conveying system. Figure 1 below shows a suggested safe rigging diagram. It lets you lift the dryer/hopper unit vertically using a fork truck.

Caution!



If you are mounting a machine-mount dryer with a magnet or transition adaptor on the machine throat, you must provide additional support to hold the dryer securely on the machine.

Be aware that off-center static and dynamic hopper loading can occur with machine vibration. Again, provide additional support to hold the dryer securely on the machine.

For 60 cfm dryer units, you must provide additional support to stabilize these units and to protect personnel when installing on machine throats.

Use caution and observe safety rules when lifting and placing your dryer!

Figure 1: Suggested Lift Rigging for Cart Mount Dryers

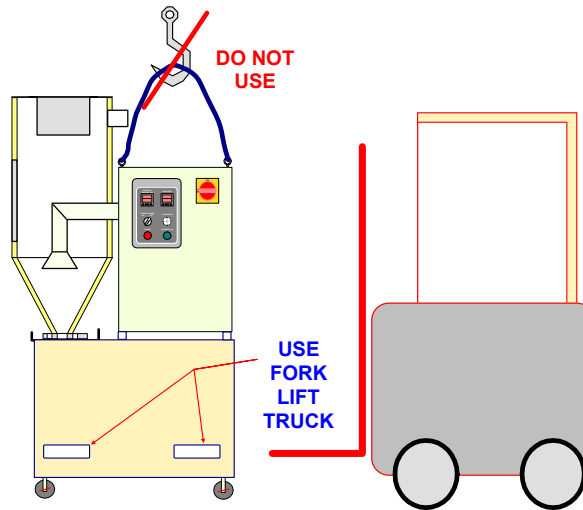

Caution! *Do not use a hoist to move or rig your Drying/Conveying System when it is mounted on a cart! Moving the unit with a hoist will cause it to become unstable and may cause damage to the equipment and/or injury to personnel!*

Figure 2: Suggested Lift Rigging for Cart Mounted Dryers

Note: Floor Mounted Dryers can be lifted by hoist or fork lift.

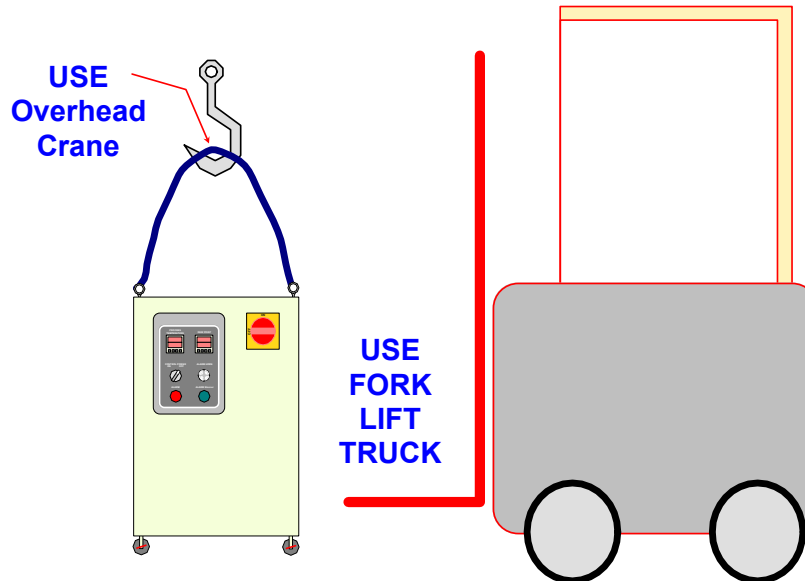
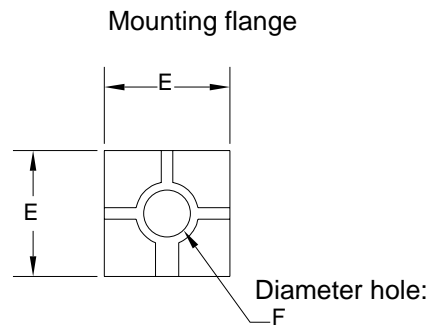
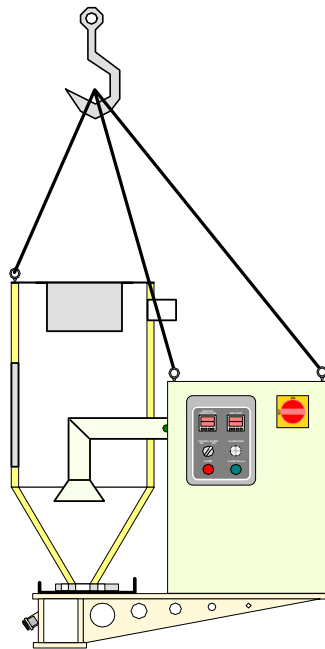

Figure 3: Suggested Lift Rigging for Cart Mounted Dryers



Notes: Hopper mounting flanges on 0.75 and 1.5 cu. ft. (20 & 40 liter) hoppers are supplied blank so the customer can drill to match existing machine throat.

3.0 cu. ft. (80 liter) hoppers and larger **are not supplied with a cast flange** (as shown).

Caution! *When using a hoist to move a machine mounted dryer, ALWAYS attach chains to the three (3) locations/lifting points on the unit! Moving the Dryer without the chains attached to all of the lifting points will cause the unit to become unstable and may cause damage to the Dryer and/or injury to personnel!*

3-3 Electrical Connections

When making electrical connections to your unit, ensure that you take into consideration and make arrangements for the following:

- A qualified electrician should make all electrical connections.
- Fulfill all national, state, and local safety and electrical code requirements.
- The serial tag lists voltage, phase, and amp draw information:
 - Line voltage must be within plus or minus ten percent ($\pm 10\%$) of the voltage listed on the serial tag, or damage may occur. Phase imbalance must be less than two percent (2%).
- Connect main power to the dryer at the disconnect or terminals in the upper right corner of the control enclosure.
- Install a fused disconnect with a lockout feature in the power main leading to the dryer.
- The power drop must include a ground wire.
- Make sure all electrical connections are tight.

3-4 Setup Procedures

This section provides the procedures necessary for configuring your portable drying/conveying system.

Configuration of your unit includes checking for proper blower rotation and installing the optional aftercooler (on 60 cfm models). We recommend that you carry out these procedures in the order given here.

Note: *Before carrying out these procedures, install all equipment as described in this section.*

Checking for Proper Blower Rotation

Three-Phase Models



Caution!

In three-phase models, incorrect phasing of power leads can cause backward rotation of blower motors and CONTAMINATION OF THE DESICCANT!

Always check blower rotation before putting material in the drying hopper!

The blower is rotating properly when air flows from the delivery outlet.

Note: *Holding your hand in front of the air return will also indicate if the blower rotates in the proper direction (by feeling suction).*

If the three-phase blower rotates improperly, reverse any two wires at the fused disconnect outside the dryer or at the disconnect/terminal in the control enclosure. This assures that the blower rotates in the proper direction.

Drying Hopper Air Trap Considerations (If Equipped)

Our exclusive air trap assembly on the top of the drying hopper prevents ambient air from contaminating the material being dried. To ensure that your unit will operate at peak efficiency, do the following:

- Keep the material level at the mid point of the air trap

This can be achieved by utilizing a hopper loader or vacuum conveying system to supply material to the drying system.

Installing the Optional Aftercooler

Water-cooled 15/30/60 cfm models use a water-to-air heat exchanger as an aftercooler. Cooling water is required for this design (3 gpm at 85°F or lower). Return air from the hopper passes through the air filter to trap fines and dust before entering the heat exchanger.

Installing Water Lines

(Hose and Hose Clamp)

When installing the water lines, ensure that the aftercooler utilizes either tower, chilled or city water as warm as 85°F (29°C). Recommended flow rate is three (3 gpm) gallons per minute (11 liters per minute).

NOTE: If the Aftercooler is used as a plasticizer trap, the water temperature of 50°F or lower is recommended.

3-5 Initial Start-up

Pre-Startup Checks

- Check the process and return hoses for tight connections.
- Check all companion equipment, such as the drying hopper; verify that the loading system is ready for operation.
- Verify that all dryer electrical connections are tight.
- Verify that the thermocouple is properly installed at the hopper inlet.

Starting Up the Dryer

1. Turn on (energize) the disconnect switch in your power drop, then turn on the disconnect switch on the dryer.
2. Turn the system **ON/OFF** switch to **ON** to energize the display panel.
3. Check the display for the proper temperature scale (°F or °C).
4. Close the slide gate at the bottom of the drying hopper.
Make sure that the blowers turn in the right direction.
5. Fill the drying hopper with material.
6. Press the **START** button on the Touch Screen to start the dryer.

The process blower starts.

7. If your dryer has a water-cooled aftercooler, make sure that sufficient cooling water (3gpm at 85°F or lower) flows properly through the coil and that you have bled any trapped air from the system.
8. Set the process set point on the touch screen.
9. After the proper pre-drying time for the initial hopper fill has elapsed, fully open the drying hopper slide gate.

Note: To allow proper residence time during continuous processing, maintain the material level in the hopper at the midpoint of the air trap assembly.

Auto-Tuning the Dryer (Requires Supervisory Password)

From the “Dryer Status” screen, press “D-Menu” and select Auto Tune to gain access to this screen.

Figure 2: Process Autotune Screen

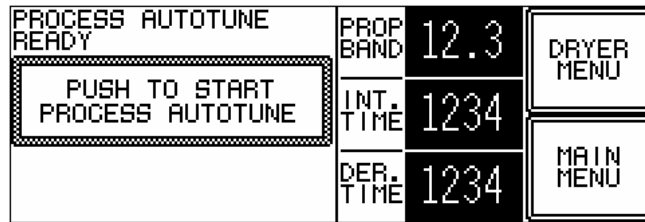

1. The autotune feature can be enabled by pressing the **START/STOP** button located in the center of the screen.
2. **AUTOTUNE IN PROGRESS** or **PROCESS NOT ACTIVE** will inform the operator of the current status of this feature.
3. At this point the operator can return back to the **DRYER MENU** or **MAIN MENU** by touching the appropriate button on the screen.

Shutting Down the Dryer

1. Turn off the conveying system supplying the drying hopper and/or machine. Press the shutdown button for the dryer to complete its cycle.
2. When processing is complete, close the hopper slide gate and shut down any in-line companion equipment, such as the aftercooler.
3. If the dryer is shut down using the shutdown button on the dryer status screen, the process heater will shut off and the bed regeneration process will be completed. When the dryer is started at a later date the process air will be directed through the bed that was regenerated last.
4. If the dryer control switch is turned off without using the dryer shutdown feature, the dryer will stop immediately. When the dryer is started at a later date, the process air will be directed through the last bed that was being used when the dryer control switch was turned off. If a bed was being regenerated when the dryer control switch was turned off, the regeneration process would begin over again on that same bed.

Chapter 4: Operation

4-1 Controller Description and Operation

Identifying Control Panel Components for the AP-1 Controller

Disconnect Switch

The **Disconnect Switch** is located in the front upper right hand corner of the control enclosure. It allows the user to disconnect power to the dryer for emergency shutdown, service or long periods of inactivity.

Control Power Switch

The **Control Power Switch** is located on the front of the control enclosure below the touch screen. The switch energizes the control circuit (PLC, touch screen, relays, etc.) within the control enclosure.

Touch Screen

The **Touch Screen** is located in the center of the control enclosure. Once the disconnect is on and the control circuit is energized, the machine can be started and parameters can be adjusted through the touch screen.

Alarm Horn & Light

The **Alarm Horn** is located in the center of the control enclosure, next to the Control Power Switch. The **Alarm Light** is located on the top of the enclosure. These devices give an audible and visual indication that there is a malfunction with the system.

Figure 3: Typical Control Panel



Process Air Temperature Controller

Control package use a PLC with a touch screen interface to control the operation of the dryer and the optional conveying system. This section of the manual will address those parameters that allow the user to optimize the drying/conveying system for specific applications.

Figure 4: Dryer Status Screen on Touch Screen Controller

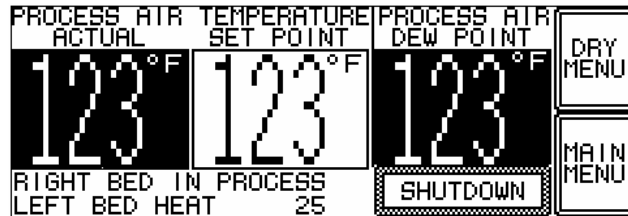

Startup Screen



The screen shown above provides the operator with the following information:

- Dryer Model Number
- Temperature view (In Celsius or Fahrenheit)
- Copyright Information
- PLC Version
- Display Version

After approximately 10-12 seconds the controller will flash to the Dryer Status Screen shown in Figure 10 above.

Main Menu Screen

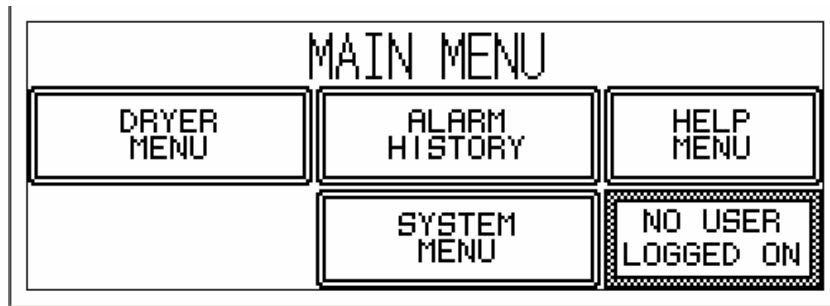

The **MAIN MENU** provides information on the following drying/conveying system parameters:

- DRYER MENU (some submenus are password protected)
- ALARM HISTORY
- HELP MENU
- SYSTEM MENU
- NO USERS LOGGED ON

This section of the manual will focus on the dryer features portion of the controller at this time.

Press the **DRYER MENU** button to return to the next section of dryer functions.

Dryer Status Screen

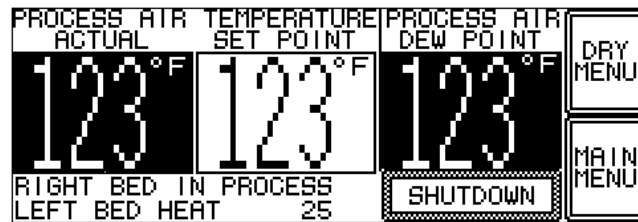

(Shown at Controller Power Up)

Note: Looking at the screen from Left to Right

Dryer Process

The **SETPOINT** button allows the operator to set the process air temperature. The **ACTUAL** button will give you a reading of what the actual process air temperature is entering the drying hopper.

Machine Status

The area in the lower left portion of the touch screen conveys two lines of information relating to the overall operation of the dryer. The following is a list of typical machine/dryer summary status line text messages:

1. Left Bed In Process
2. Right Bed In Process
3. Process Offline
4. Valve Changing Position
5. Auto start Timer Enabled
6. Autotune in Progress
7. Dryer Offline
8. Left Bed Heat
9. Left Bed Cool
10. Left Bed Ready
11. Right Bed Heat
12. Right Bed Cool
13. Right Bed Ready
14. Over-dry Protect Active

Start Button

The **START BUTTON** allows the user to stop and start the dryer manually. When the start button is pressed, the dryer begins to operate. The text in the button will change from **START** to **SHUTDOWN**. The next time the button is pressed, the dryer will go into a sequence shutdown and the button text will change to **RESTART**. The process heater will shut off, the current bed regeneration will be completed and then the blower will stop. If sequence shutdown is not desired, turning the **POWER SWITCH** off will turn off all components of the dryer immediately and the optional conveying system will be turned off also.

Setting Values

By pressing and holding the numbers in the **SETPOINT** button, the following screen will be displayed:

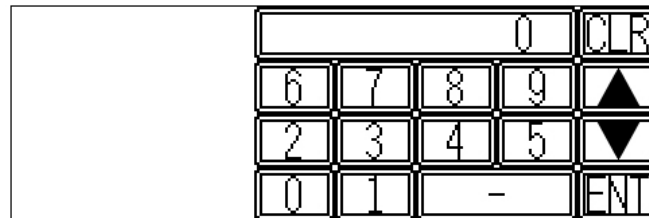

Enter the values you would like to set in the screen by pressing the number keys. Press **ENT** (Enter) when you are finished to set the new values or **CLR** (Clear) to erase the current values and reenter new ones. To set the values in the next field, press ENT (Enter) to close the screen shown above. Then select the next number field to enter new values.

Dryer Menu

Pressing this button will take the user to another screen where more machine parameters can be viewed and adjusted.

Dryer Menu Screen

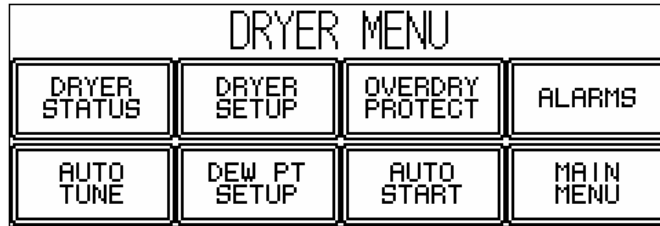

The screen shown above will allow the operator to set/review operating parameters for the following:

- DRYER STATUS
- DRYER SETUP (requires supervisory password)
- OVERDRY PROTECT (requires supervisory password)
- ALARMS
- AUTO TUNE (requires supervisory password)
- DEW PT SETUP (Dew Point Setup)
- AUTO START (requires supervisory password)
- MAIN MENU

DRYER STATUS

Pressing the **STATUS** button will take the operator back to the original status screen shown on page 27. Pressing **MENU** will return you back to the menu screen.

DRYER SETUP

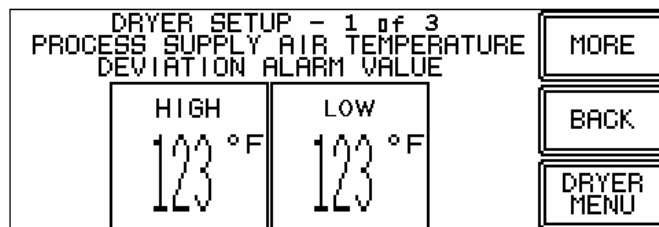

By pressing the **LOW** or **HIGH** alarm buttons, the operator can enter the desired values to enable the alarm to go off at a specific **deviation** from set point (on the high or low side).

When these settings have been made, the operator now has a choice of returning to the **DRYER MENU**, **BACK** (takes you back to the **DRYER MENU**) or pressing **MORE** to take you to screen 2 of 3 of the **DRYER SETUP** screen.

By pressing the **MORE** screen, you can choose for the temperatures to display in degrees **F** or degree **C**. (Note: Changing the temperature scale, requires adjusting the alarm values.)

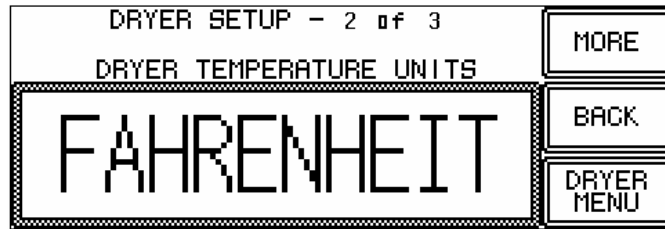

When these settings have been made, the operator now has a choice of returning to the **DRYER MENU**, **BACK** (takes you back to the **DRYER SETUP 1 of 3**) or pressing **MORE** to take you to screen 3 of 3 of the **DRYER SETUP** screen.

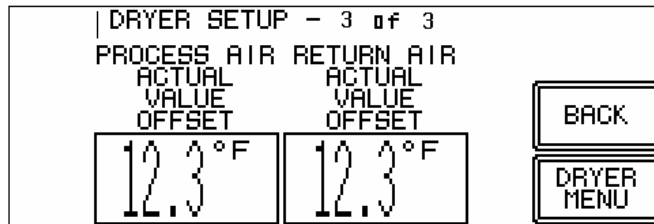

NOTE: At this display, before you change any of the settings, you need to test the thermocouple readings in Ice water (32°F at sea level, and boiling water 212°F at sea level). Then you may change these settings accordingly to make sure the controller is displaying the correct temperature.

Setting Values

By pressing and holding the numbers in the **LOW TEMP ALARM** or the **HIGH TEMP ALARM** buttons, the following screen will be displayed:

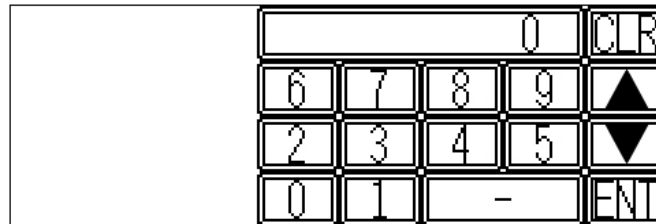

Enter the values you would like to set in the screen by pressing the number keys. Press **ENT** (Enter) when you are finished to set the new values or **CLR** (Clear) to erase the current values and reenter new ones. To set the values in the next field, press ENT (Enter) to close the screen shown above. Then select the next number field to enter new values.

Over-Drying Protection



The **PROCESS RETURN AIR TEMPERATURE** displays the air temperature as it leaves the drying hopper. If this temperature is above 150°F, an aftercooler is required.

By pressing the **DISABLE** or **ENABLE** the operator disable or enable this feature of the dryer.

This feature is used to prevent the over drying of the plastic resin in the drying hopper.

At this point the operator has the choice of pressing **MAIN MENU**, **DRYER MENU**, or **MORE** to access the screen 2 of 2 of the **OVERDY PROTECTION** for adjusting values.

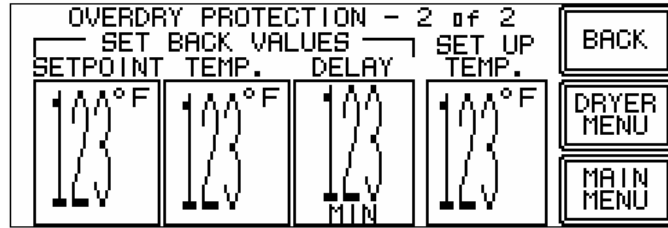

SET BACK VALUES;

The **SETPOINT** is the secondary drying temperature set point. This is the temperature at which the drying temperature will be reduced to after a certain delay time and when the return air temperature has exceeded its set point..

The **TEMP** is the set point for the return air temperature of the drying hopper. When the return air temperature exceeds this value, after a certain delay time, the process temperature will be reduced to its secondary value (SETPOINT) to eliminate over drying of the plastic material.

The **DELAY** is the time which will take for the dryer to switch the drying temperature set point from primary drying temperature to secondary drying temperature or back to the primary drying temperature set point.

SET UP TEMP;

The **SETUP TEMP** is the secondary temperature setting for the return air temperature. When the return air temperature of the drying is lower than this set point, after a certain delay time, the process temperature set point will switch back to the primary drying temperature set point.

Once the parameters have been set for the drying process, the operator can return to the **DRYER MENU**, **MAIN MENU**, or **BACK** to the screen 1 of 2 of the **OVERDRY PROTECTION**.

Setting Values

By pressing and holding the numbers in the **SET BACK DELAY** button, the following screen will be displayed:

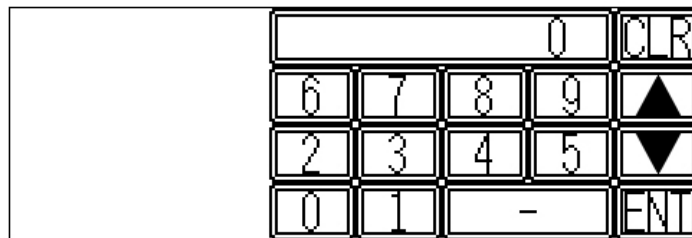

Enter the values you would like to set in the screen by pressing the number keys. Press **ENT** (Enter) when you are finished to set the new values or **CLR** (Clear) to erase the current values and reenter new ones.

The next feature in the **DRYER MENU** is the **ALARMS** button/screen.

Alarms (Retains 100 of the most recent alarms)



This screen allows the operator to review the number and type of issues that the Dryer has encountered during its operation. The “Alarm History” screen is NOT reset-able.

Problems can be viewed by **Date, Hour, and Comment.**

Because of the size of the screen, only three (3) comments/alarms can be viewed at a time. To view alarms not visible on the screen, press the **DOWN** button. To return to a particular alarm, press the **UP** button to scroll upward in the alarm history.

Pressing **CNV** (Convey) in this screen will take the operator to the **CONVEY STATUS** of the system. You will only get **CNV** alarms when conveying options are enabled (Nomad only).

At this point the operator can return back to the **DRYER MENU** or **MAIN MENU** by touching the appropriate button on the screen.

Auto Tune

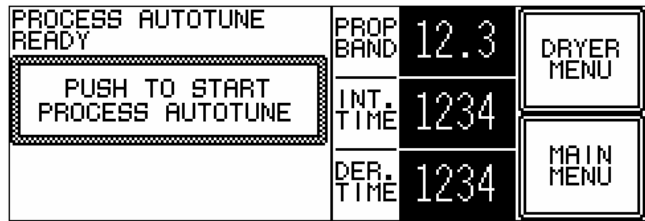

This screen allows the operator to automatically tune the process air temperature control algorithm to a specific drying application. The autotune sequence should be initiated if the user feels there are unacceptable fluctuations in the process air temperature. The calculated **P, I, and D** variables will be shown in the lower left hand portion of the screen for reference purposes.

The autotune feature can be enabled by pressing the **PUSH TO START PROCESS AUTOTUNE** button.

AUTOTUNE IN PROGRESS or **PROCESS NOT ACTIVE** will inform the operator of the current status of this feature.

At this point the operator can return back to the **DRYER MENU** or **MAIN MENU** by touching the appropriate button on the screen.

Dew Pt Setup

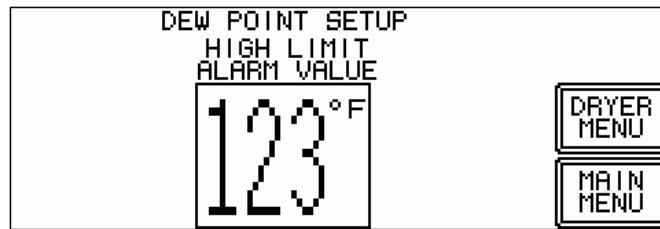

This screen allows the operator to set the dew point alarm value.

The **HIGH LIMIT ALARM VALUE** is an audible/visual alarm which will sound when the process air dew point rises to this value. Values can be set for degrees Fahrenheit between - 40 through +15 degrees and degrees Celsius between -40 through -10 degrees.

Setting Values

By pressing and holding the numbers in the **HIGH DEW PT ALARM**, the **ALARM STARTUP DELAY** or the **ALARM BED SW DELAY** buttons, the following screen will be displayed:

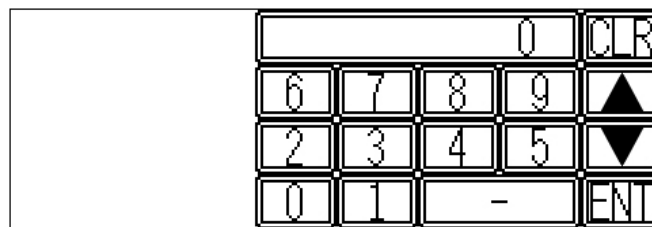

Enter the values you would like to set in the screen by pressing the number keys. Press **ENT** (Enter) when you are finished to set the new values or **CLR** (Clear) to erase the current values and reenter new ones. To set the values in the next field, press ENT (Enter) to close the screen shown above. Then select the next number field to enter new values.

Once this feature has been set, the operator can return back to the **DRYER MENU** or **MAIN MENU** by touching the appropriate button on the screen.

Auto Start

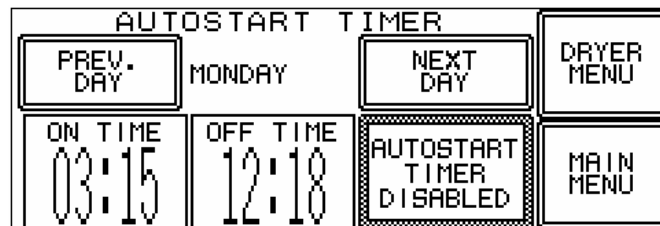

This screen allows the operator to set the time and day that the dryer will start **automatically**. Reference page 32, Make sure the clock is set to current date and time.

Pressing **NEXT DAY** allows the operator to scroll forward through the days of the week to select the day they desire the dryer to start. Pressing **PREV DAY** allows the operator to scroll backward through the days of the week to select the day they desire the dryer to start.

By touching the **ON TIME** and **OFF TIME** sections on the screen, the operator can enter the values for the time they wish the dryer to turn on and off. See the next page for instructions on setting values for this feature.

Pressing the **AUTOSTART TIMER DISABLED** button will activate this dryer feature. Pressing **AUTOSTART TIMER ENABLED** will deactivate this feature.

Once this feature has been set, the operator can return back to the **DRYER MENU** or **MAIN MENU** by touching the appropriate button on the screen.

Setting Values

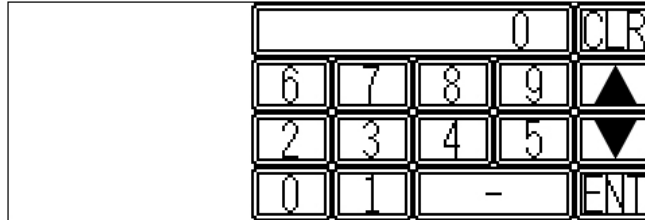

Enter the values you would like to set in the screen by pressing the number keys. Press **ENT** (Enter) when you are finished to set the new values or **CLR** (Clear) to erase the current values and reenter new ones. To set the values in the next field, press ENT (Enter) to close the screen shown above. Then select the next number field to enter new values.

Main Menu

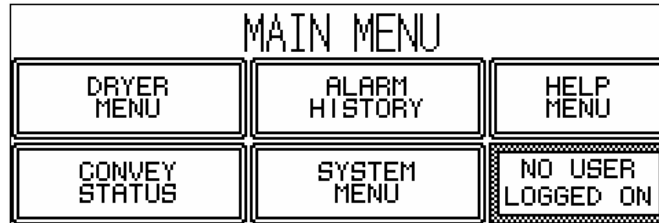

This screen allows you to jump to the different areas of the controller to set, monitor, and operate different features of the Drying/Conveying System. Conveying screens are used only with Nomad dryers.

NO USER LOGGED ON, indicates that the password to access certain features of the dryer is not entered. USER LOGGED ON, indicates that the password to access certain features of the dryer is still active and these features can be accessed and changed.

Help Menu

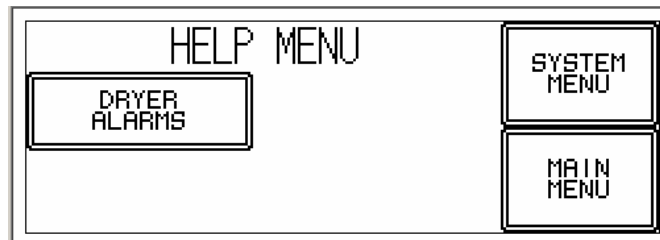

System Menu

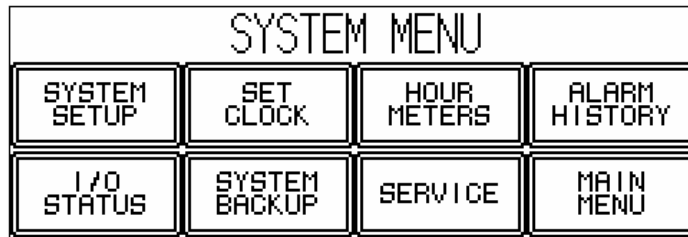

The screen shown above will allow the operator to set/review operating parameters for the following:

The above screen will allow the operator to set/review operating parameters;

- SYSTEM SETUP
- SET CLOCK
- HOUR METERS
- ALARM HISTORY
- I / O STATUTUS (Input and output status)
- SYSTEM BACKUP
- SERVICE
- MAIN MENU

SYSTEM SETUP

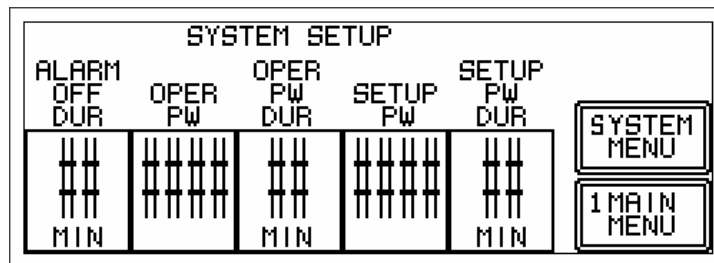

This screen allows the operator to set alarm and password features.

ALARM OFF DUR is the amount of time (0-99 minutes) that the alarm and horn will stay off after the alarm silence button is pushed. (When this function is set to 0, this feature will never turn off. When it is set to 99, it will stay off until another alarm occurs.)

OPER PW is the four (4) digit number that allows access to the station and pump status screen and the station operator screen. (When this feature is set to 0000 these screens **are not** password protected.)

OPER PW DUR is the amount of time (5-99 minutes) the password will allow access to the associated screens. The screen changes to the station status screen when the time expires.

SETUP PW is the four (4) digit number that allows access to the setup screens. (When this is set to 0000 there is no password protection.). Store password in a secure location.

SETUP PW DUR is the amount of time (5-99) the password will allow access to the associated screens. When the time expires, the screen changes to the station status screen.

Note: If password(s) feature is enabled, please write down your passwords and file them in a secure location.

At this point the operator can return back to the **MAIN MENU** or **SYSTEM MENU** by touching the appropriate button on the screen.

Set Clock



This menu allows the operator to set the **AUTOSTART CLOCK** and the **ALARM CLOCK**.

Press the **SET AUTOSTART CLOCK** or the **SET ALARM CLOCK** buttons to set the times and dates on these features.

Set Auto Start Clock

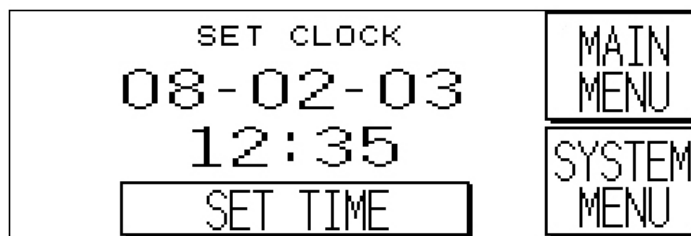

This screen allows the user to set the 7-day timer which can be programmed for daily or weekly (over midnight) on/off operation. An internal battery backup holds the settings in memory when the dryer is de-energized.

Setting Values

By pressing the numbers (Month, Day, Year, Hours and Minutes) under Set Clock on the previous screen shown above, the following screen will appear:

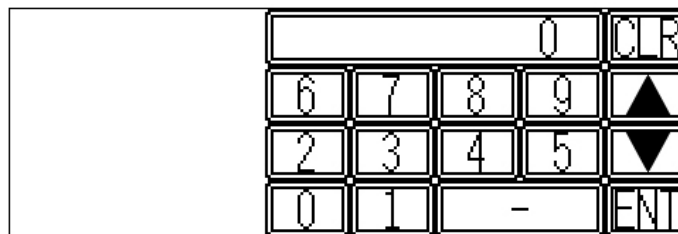

Enter the values you would like to set in the screen by pressing the number keys. Press **ENT** (Enter) when you are finished to set the new values or **CLR** (Clear) to erase the current values and reenter new ones. To set the values in the next field, press ENT (Enter) to close the screen shown above. Then select the next number field to enter new values.

Pressing the **SET TIME** button will enter the new information into the controller.

When the new information has been entered into the controller, the operator can return back to the **MAIN MENU** or **SYSTEM MENU** by touching the appropriate button on the screen.

Set Alarm Clock

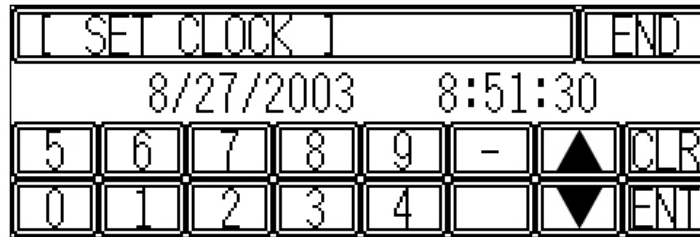

In this screen the user can set the variables which are used to time and date stamp alarms. This feature works in conjunction with the ALARM screen (See page 31) to notify the user of issues which the Dryer had encountered during its operation.

Setting Values

Pressing the individual numbers in the second row of the screen shown above, the operator can select the field (Month, Day, Year, Hours and Minutes) he wishes to change.

Enter the values you would like to set by pressing the number keys. Press **ENT** (Enter) when you are finished to set the new values or **CLR** (Clear) to erase the current values and reenter new ones. Press **END** to return back to the **CLOCK MENU** screen.

Press the **SYSTEM MENU** button in the CLOCK MENU SCREEN to return back to the system menu screen and the next set of programmable features.

Hour Meters

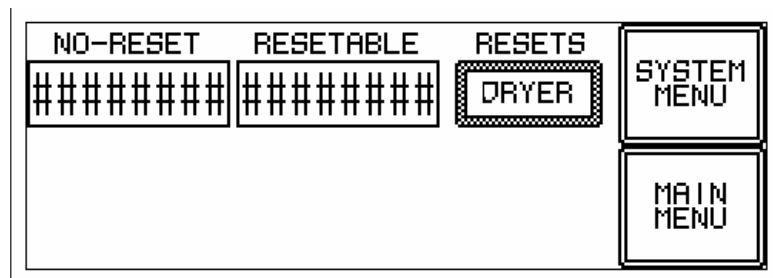

This screen monitors the number of hours that the dryer, machine blower, and dryer blower have operated.

In addition to monitoring the total number of hours of equipment operation, it also has resettable fields which allow the operator to set the counter back to zero. This is useful for monitoring hours between equipment maintenance periods.

Press the **DRYER RESET** button, **MB RESET** button, and/or **DB RESET** button to reset the counters.

When and if the counters have been reset on the controller, the operator can return back to the **MAIN MENU** or **SYSTEM MENU** by touching the appropriate button on the screen.

Input Status (UPDATE)

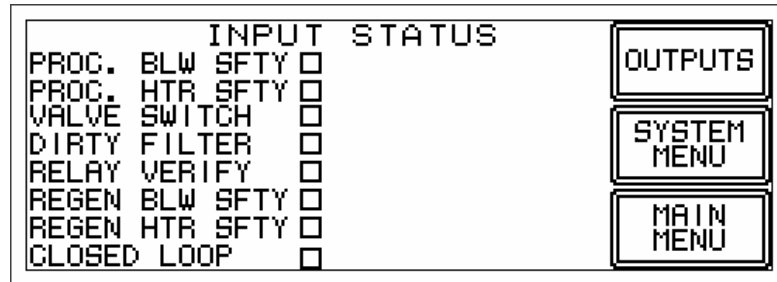

This screen allows the operator to view the status of the variables contributing to the input of material into the drying system. It also is useful in troubleshooting system issues (i.e. a dirty filter or low material level in a hopper).

At this point the operator may choose the **SYSTEM MENU** button to go back to the system menu, or **MAIN MENU** to return to main menu, or press **OUTPUTS** to access the output screen.

Output Status (UPDATE)

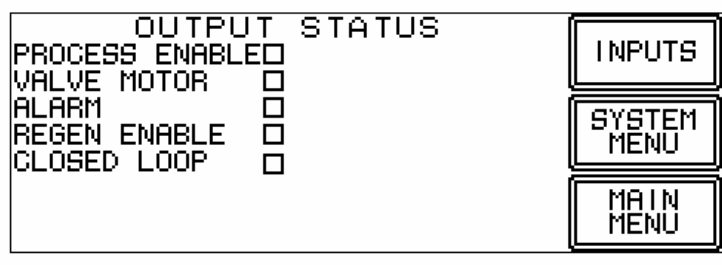

This screen allows the operator to view the status of variables contributing to the disbursement of material from the drying system to the molding machine.

At this point the operator may choose the **SYSTEM MENU** button to go back to the system menu, or **MAIN MENU** to return to main menu, or press **OUTPUTS** to access the output screen.

SYSTEM SETTINGS

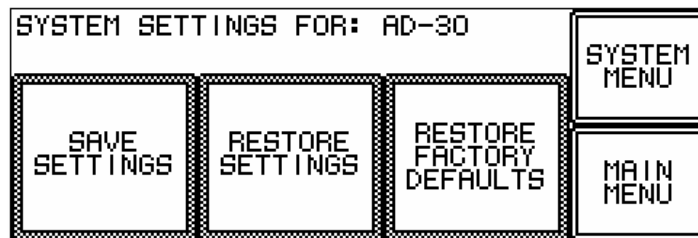

The **SAVE SETTING** button will save the current dryer parameter settings.

The **RESTORE SETTINGS** button will restore the dryer parameter settings that were saved previously.

The **RESTOR FACTORY DEFAULTS** button will restore the initial dryer parameter settings as the dryer was shipped from the factory.

At this point the operator may choose to return to the **SYSTEM MENU** or **MAIN MENU** by pressing the appropriate buttons.

Service Menu

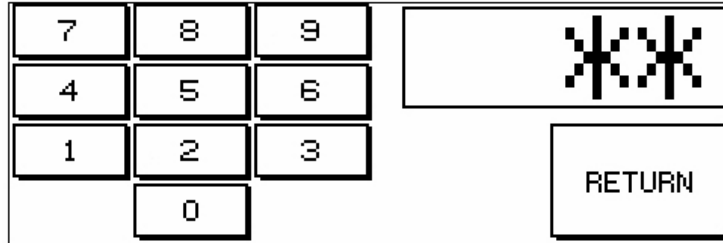

This service menu screen is **PASSWORD PROTECTED** and meant for manufacturer personnel use only.

Press the **RETURN** key to go back to the **SYSTEM MENU**.

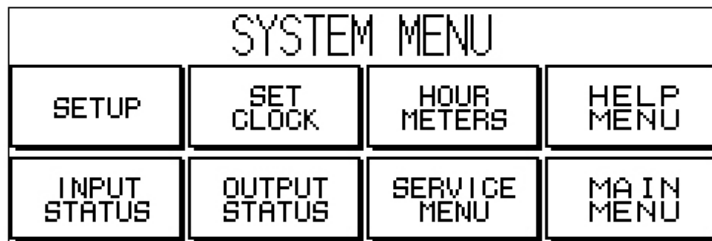

Touching the **MAIN MENU** button in the **SYSTEM MENU** screen, will return the operator back to the overall menu screen.

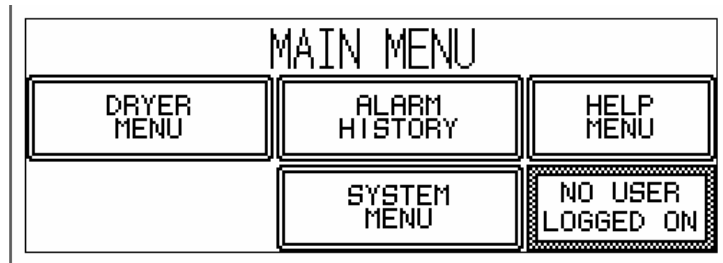

Alarm Screens



This screen allows the operator to review the number and type of issues that the Drying/Conveying System has encountered during its operation.

Problems can be viewed by **Date, Hour, and Comment**.

Because of the size of the screen, only three (3) comments/alarms can be viewed at a time. To view alarms not visible on the screen, press the **DOWN** button. To return to a particular alarm, press the **UP** button to scroll upward in the alarm history.

Pressing **CNV** (Convey) in this screen will take the operator to the **CONVEY STATUS** of the system. You will only get **CNV** alarms with a Nomad dryer.

At this point the operator can return back to the **DRYER MENU** or **MAIN MENU** by touching the appropriate button on the screen.

Alarm Screen Example

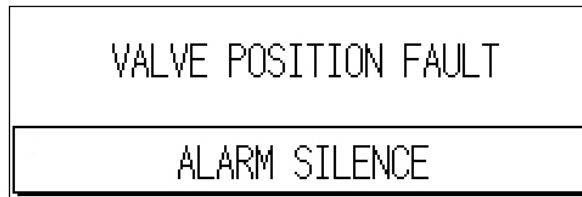

This is an example of what a typical Alarm screen looks like. The user will see the message causing the alarm in the top half of the display with an **ALARM SILENCE** button in the lower half.

To turn off the alarm, the user must press the **ALARM SILENCE** button. This will cancel the alarm.

Redundant Safety Controller Display Optional

The Redundant Safety Controller limits the process air temperature from exceeding specific temperatures in case of a catastrophic failure of the primary PLC process air temperature control system. The controller is a modular, self-contained unit removable from the mounting housing. All parameters are factory set and adjusted; normally, no field adjustment to the internal controls are necessary.

Figure5: Typical Redundant Safety Controller Display



Setting the Redundant Safety Controller

The Redundant Safety Controller alarm setting is changed by pressing the up and down keys to input the alarm value. The upper display reading indicates the Process Value, while the

lower display indicates the High Point Setting alarm value. The factory setting for the High Point Alarm Value (**LI-hi**) is 150°F (-23°C).

Restoring the WATLOW Redundant Safety Controller to Factory Setup

If the preset parameters on the controller have been tampered with and it no longer functions properly, call the Service Department.

Note: This controller is not meant to be modified.

WATLOW Operating Parameters

The WATLOW controller has only one mode selection; ALARM.

The factory has set the security level to protect the critical parameters from being accidentally changed. Below is an explanation of the modes you will have access to and the manufacturer default settings.

Entering Operating Parameters to Select Modes

To enter the display:





1. Press both the Up  and Down  keys for three seconds from the home page. The word **SEE** will appear in the upper display and **PAGE** will appear in the lower display.
2. Press the Advance Key  to move through the parameter prompts.
3. Press the Up  or Down  keys to change the parameter value.
4. Press the RESET Key at any time to return to the Home Page display.

Figure 6: Setting List for Redundant Safety Controller (WATLOW), Part No. A0568961

Mode	Parameter	Setting range	Default	Manuf. setting
SEn	Sensor Type	0-3	0	-
Lin	Thermocouple Linearization	0-10	0	H (1)
C-F	Temperature Units	Fahrenheit / Celsius	F	-
S.dEC	Temp. Decimal Places	0 – 0.0	0	-
IS.En	INFOSENSE™	Yes / No	No	-
Sc.Lo	Process Scale Low	4.00 to 20.00 mA 1.00 to 10.00V	4.00 mA 1.00V	0
Sc.hi	Process Scale High	4.00 to 20.00 mA 1.00 to 10.00V	20.00 mA 5.00 V	400
CAL	Calibration Offset	-999 to 999	0	-
Ftr.E	Input Filter	Off, DiSP, Cont, both	OFF	-
Ot 1	Output 1 Function	Limit (2)	(2)	-
LSd1	Output 1 Limit Sides	Both, High, Low	Both	High
hyS1	Limit 1 Hysteresis	0.0 to 999.0	1.0	-
Ot2	Output 2 Function	Off / Process Alarm / Limit (2)	OFF	-
LSd2	Output 2 Sides	Both / high / low	Both	-

UdSP	Upper Display Look	None, Process Value, Limit 1 Low Set, Limit 1 High Set, Limit 2 Low Set, Limit 2 High Set, Alarm 2 Low Set, Alarm 2 High Set, Limit 3 Low Set, Limit 3 High Set, Alarm 3 Low Set, Alarm 3 High Set	Process	-
LdSP	Lower Display Look	None, Process Value, Limit 1 Low Set, Limit 1 High Set, Limit 2 Low Set, Limit 2 High Set, Alarm 2 Low Set, Alarm 2 High Set, Limit 3 Low Set, Limit 3 High Set, Alarm 3 Low Set, Alarm 3 High Set	Limit 1 High Set	-
LOC	Lockout	(0) no lockout, (1) Programming and Setup Page Locked, (2) Limit Set Points are the only Operation Page parameters accesible, (3) Full Lockout.	0	2

4-2 System Operation Procedures

1. Turn the disconnect switch on the control panel to the **ON** position. Power is applied to the voltage line fuses and line side of the control power switch.
2. Turn the control power switch to the **ON** position. Power is applied to the PLC and touch screen. Push the start button on the PLC and the valve will move to the start position as follows:
 - a. The valve motor rotates until the cam switch makes 2 transitions.
 - b. If the cam switch does not make a transition within 10 seconds, a valve motor fault alarm is generated. The alarm horn and light are activated. The valve motor, heaters, and blower shut off. Pressing the **ALARM SILENCE** pushbutton will deactivate the alarm horn and light.

Note: Cycle control power to restart the dryer.
 - c. The valve will normally complete one full cycle (revolution). If sequence shutdown is not initiated (in 10 Seconds) and control power switch or disconnect are turned off:
 1. The bed in process at power-down will remain in process.
 2. The bed in regeneration at power-down will remain in regeneration.
 3. The regeneration timing cycle will restart from the beginning.
3. Once the control power is on and no fault conditions exist, turning the **Off-On** switch to the **ON** position and pressing the **START** button on the touch screen will start the dryer as follows:
 - a. The process heater is turned on and controlled by the PLC.
 - b. The process/regen blower is started.
 - c. The regen heater is turned on and the regeneration timing sequence is initiated. The regen heater is controlled by the PLC.

4. If either the left or right bed safety temperature switch opens, a **REGEN TEM SAFETY** is generated. The alarm horn and light are activated. The process heater, regen heater, and process/regen blower are turned off. Pressing the **ALARM SILENCE** button on the touch screen will deactivate the alarm horn and light.
5. Turn the **Off-On** switch to the **ON** position and push the touch screen **START** button to restart the dryer. If the switch is still open, the dryer will not restart.
6. If the PLC/touch screen faults, the optional redundant high temperature safety device opens, or the process heater safety switch opens, a process heater fault is generated. The alarm horn and light are activated. The process heater, regen heater, and process/regen blower are turned off. Pressing the **ALARM SILENCE** pushbutton will deactivate the alarm horn and light.
7. Turn the **Off-On** switch to the **ON** position and push the **START** button to restart the dryer. If the fault condition still exists, the dryer will not restart.
8. If the process blower overloads trips, a **PROCESS BLOWER FAIL** is generated. The alarm horn and light are activated. The process heater, regen heater, and process/regen blower are turned off. Pressing the **ALARM SILENCE** button will deactivate the alarm horn and light.
9. Reset the motor overload and turn the **Off-On** switch to the **ON** position and push the **START** button on the touch screen to restart the dryer.
10. The valve position limit switch enables the right bed heater and provides an input signal to the PLC when actuated by the cam lobe. Each heater is controlled by the PLC.
11. Upon completion of the **HEAT** portion of the regeneration sequence, the regen heaters are disabled by the PLC and the **COOL** time begins.
12. Once the **COOL** time has expired, the valve motor is turned on until the cam switch makes a transition. Upon making a transition, the timing sequence is restarted for the new bed.
13. When a **HIGH DEW POINT** alarm is generated by the dew point controller, the alarm horn and light will activate. Press **ALARM SILENCE** to deactivate the alarm until the next **HIGH DEW POINT** alarm occurs.
14. The dryer is shut off by pushing the **SHUTDOWN** button on the PLC or turning the control power **On/Off** switch to the **OFF** position.
15. Refer to the schematic drawing enclosed in the control enclosure.

4-3 Shutting Down the Dryer

- 1 Turn off the conveying system supplying the drying hopper and/or machine. Press the **SHUTDOWN** button for the dryer to complete its cycle.
- 2 When processing is complete, close the hopper slide gate and shut down any in-line companion equipment, such as the aftercooler.
- 3 If the dryer is shut down using the **SHUTDOWN** button on the dryer status screen, the process heater will shut off and the bed regeneration process will be completed. When the dryer is started at a later date the process air will be directed through the bed that was regenerated last.
- 4 If the dryer control switch is turned off without using the dryer shutdown feature, the dryer and the on board conveying system will stop immediately. When the dryer is started at a later date, the process air will be directed through the last bed that was being used when the dryer control switch was turned off. If a bed was being regenerated when the dryer control switch was turned off, the regeneration process would begin over again on that same bed.

Chapter 5: Maintenance

5-1 Preventative Maintenance Schedule

The checklist below contains a list of items which should be inspected and/or replaced to keep your Portable Drying/Conveying System operating at peak efficiency. Perform each inspection at the regular intervals listed below.

System model #						Serial #							
Every Day	Date/By	Date/By	Date/By	Date/By	Date/By	Date/By	Date/By	Date/By	Date/By	Date/By	Date/By	Date/By	Date/By
Inspect all filters for wear, replace/clean if dirty or worn.													

Every week	Date/By	Date/By	Date/By	Date/By	Date/By	Date/By	Date/By	Date/By	Date/By	Date/By	Date/By	Date/By
Check to make sure that all hose connections are air tight.												

Every month	Jan	Feb	Mar	Apr	May	Jun	Jul	Aug	Sep	Oct	Nov	Dec
Lock out electrical power and inspect electrical wiring for integrity.												
Lock out electrical power and check heater elements for continuity using an ohmmeter.												
Check dew point and temperature tracking with an external dew point monitor and pyrometer.												
Visually inspect the shifting of the airflow valve during one cycle.												

Every year	Next scheduled inspection	Actual inspection Date/By	Next scheduled inspection	Actual inspection Date/By
Inspect desiccant. Replace if brown or broken.				

Every two years	Scheduled replacement date	Actual replacement Date/Work done by	Scheduled replacement date	Actual replacement Date/Work done by
Replace desiccant.				

- Photocopy this page for your maintenance records -

5-2 Preventative Maintenance

This section describes maintenance procedures which will increase the longevity and efficiency of your Portable Drying/Conveying System. Perform them at the regular intervals listed on the checklist on the previous page.

Servicing Process Air Filters

Caution! *Operating the dryer without the process air filter installed voids your warranty!*

Filter cleaning is an important part of your dryer maintenance program.

Dehumidifying dryers have a single cartridge canister-type filter in the process air loop. The filter protects blowers from plastic fines drawn in from the drying hopper and prevents the desiccant from being contaminated. Regular filter cleaning is essential to keep your dryer operating at peak efficiency.

You can blow or vacuum the dirt out of the filter with compressed air, but remember, it could become damaged from high-pressure blowing.

Recommendations for Cleaning and Replacing Filters

- Turn off and/or lock out electrical power to the dryer.
- Remove the threaded fastener securing the filter access cover, then remove the cover.
- Remove the nut on the center retaining rod to remove the filter cartridge.

Figure7: Air Filter Location and Disassembly

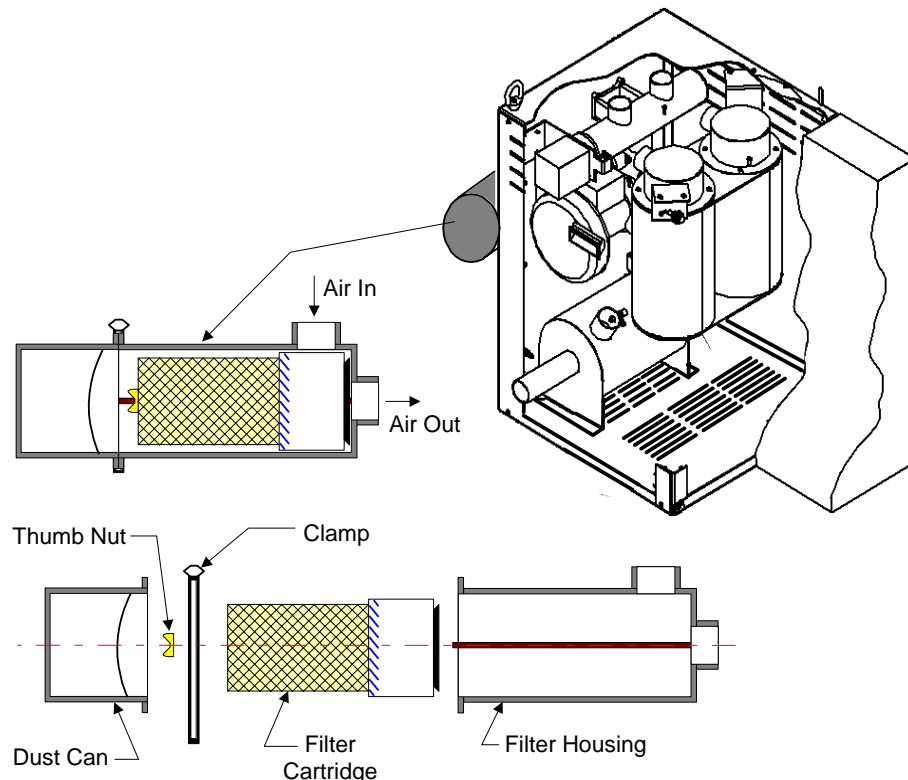

Vacuuming

Try vacuum-cleaning a soiled filter first. Vacuuming removes most large particles and surface contaminants, and may suffice for the first time you clean a filter. Use a commercial-duty (recommended) or household vacuum cleaner. Vacuum the filter from the air intake (dirty) side only.

Cleaning with Compressed Air

Blow clean, dry compressed air up and down the pleats, blowing out the filter from the inside out. Remove loose dirt from the filter with compressed air or vacuum from the outside.



Caution! *DO NOT clean/wash filter with water!*

After each cleaning:

- Inspect the filter element. *Briefly* hold a light bulb behind the element and look for any **fatigued paper** or residual dirt. Inspect for holes and tears by looking through the filter toward a bright light. Check for damaged gaskets or dented metal parts. Do not re-use a damaged filter!
- Check the gasket for damage. A damaged gasket allows contaminants into the process. Replace as needed.

Servicing the Dew Point Monitor

The accuracy of the dew point monitor on mini dryer systems depends on proper operation of the dew point sensor and the control board. The dew point sensor is in the process air stream and is therefore susceptible to contamination.

Dew point sensor life depends on:

- Air temperature and flow passing over the sensor.
- The amount of fines (dust) in the process air.
- The amount of plasticizer vapor in the process air.

Once every six months, the dryer operator should monitor the initial dew point sensor readings and establish a periodic replacement schedule as needed.

Caution! *Do not attempt to check the continuity or resistance of the dew point sensor. The sensor will be destroyed!*



5-3 Corrective Maintenance

This section provides you with the information necessary to correct or repair any issues which might appear during the normal operation of your dehumidifying dryer. Although we have listed how to perform these procedures, it is recommended that you call the Service Department to have any in-depth maintenance performed.

Symptoms of Worn Desiccant

The moisture absorption capacity of the desiccant used in your dehumidifying dryer degrades after an indefinite period of time. Useful life depends on variables such as the condition of the process filter, how much dust and fines have been passed through the filter and got into the desiccant chamber, and plasticizer vapors in the return air.

WARNING!



Handling desiccant material is HAZARDOUS.

Wear an N-100 type safety filter mask or equivalent to avoid prolonged breathing of desiccant dust. Wear safety goggles and gloves to avoid contact with eyes and skin.

- *Handle with adequate ventilation.*
- *Wash hands thoroughly after handling.*

+ FIRST AID +

In case of eye contact, immediately flush eyes with plenty of water for at least 15 minutes.

SEE A PHYSICIAN IMMEDIATELY IF IRRITATION PERSISTS.

Replacing Worn Desiccant

Caution!

DESICCANT BEDS ARE HOT DURING OPERATION.



To avoid burn hazard, make sure desiccant beds are sufficiently cool before replacing worn desiccant.

To access the Desiccant Bed:

1. Disconnect electrical power to the dryer.
2. Using a 1/8" Allen wrench, remove the four (4) 10-32 button head screws holding the Desiccant Cap to the Regeneration Heater.
3. Remove the Desiccant Cap.
4. With a shop vacuum, carefully remove all desiccant from each tower.

Figure 8: Desiccant Bed Location and Disassembly

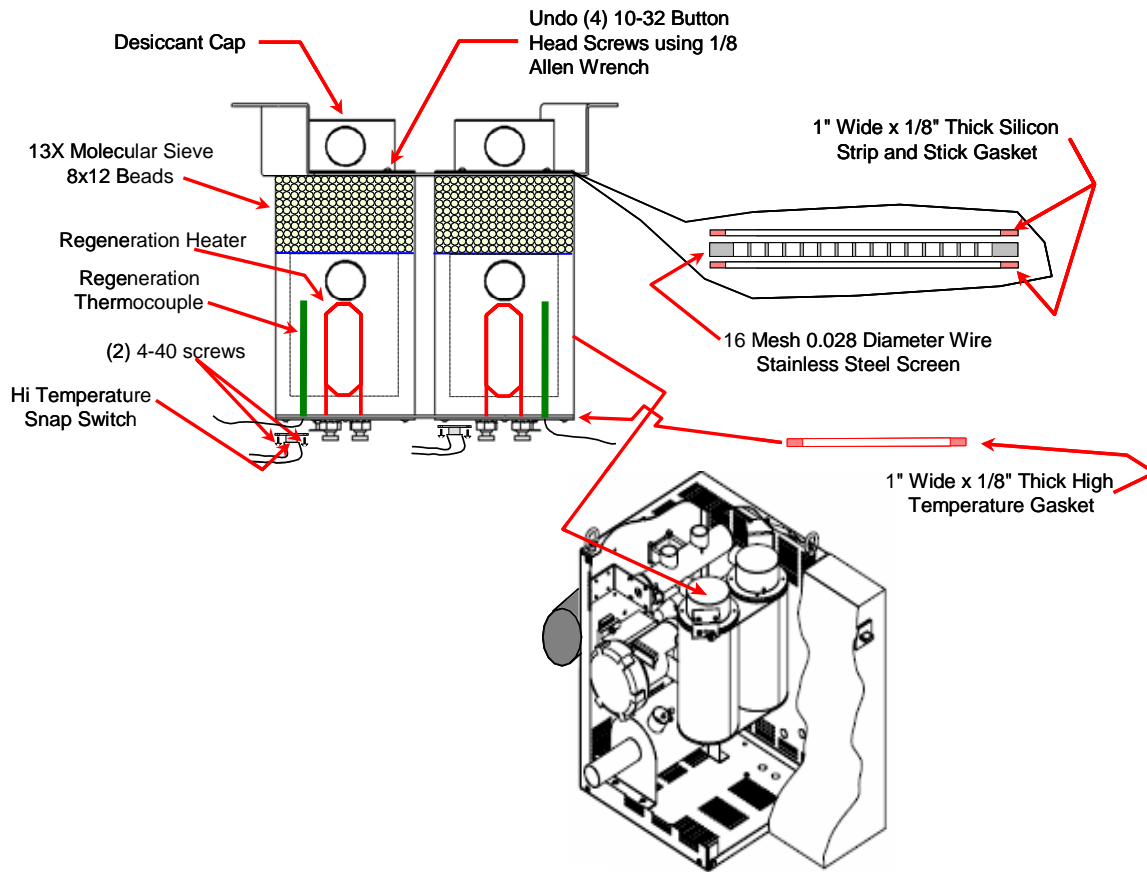

Caution! *You should properly dispose of any discarded desiccant.
Consult local disposal regulations for more information.*

Inspect each lower desiccant screen for tears or holes where desiccant burned-through. Replace as needed.

1. After cleaning each chamber, add the full amount of bead desiccant specified per bed. Amounts are listed in the Desiccant Amounts Table below. Smooth the top level, and finally add another layer of the remaining bead desiccant to the top. Make sure this layer is level and smooth. **Tap the chambers with a rubber melet gently for one or two minutes to make sure the desiccant is packed tight. Add more desiccant if required.**
2. Repeat the previous step for the other bed.
3. Inspect the gaskets and replace if necessary. Place the screen in between the desiccant tank and the cap.
4. Reconnect all the hoses and panels when done.

Figure 9: Required Desiccant Amounts

Dryer model	8 x 12 bead Total		
	Part no.	lbs.	Kg
15 cfm	W00018051	7.0	3.25
30 cfm		15.75	7.25
60 cfm		37.5	17.0

Replacing the regeneration heaters

Procedures (see figure 8).

1. Sketch the heater wiring configuration so you can properly re-wire the heater.
- 5 Remove the ceramic nuts and wires to the heater plate assembly being removed or replaced.
- 6 Remove the six (6) 10-32 button head screws securing the process heater plate using a 1/8" Allen wrench and slide out the assembly.
- 7 Remove the heater(s) from the mounting plate by removing the large brass nuts and washers.
- 8 Re-install the heater(s) and heater plate assemblies in reverse order. Install new heater gaskets and securely tighten all fasteners.

Caution! *Heater loops should not touch each other.
 "Hot spots" lead to premature heater failure!*

2. Reinstall the wires based on the sketch you made earlier.
 Reinstall the ceramic nuts to each heater terminal.

Replacing the Process Heater

The dehumidifying dryers utilize a single-phase Calrod-type heater element. This heater element is mounted in the center compartment below the desiccant beds. Although the replacement procedure is the same for each heater, the wattage varies by model, voltage, temperature range, etc.

WARNING! *Hazardous electrical current present.
 Disconnect and lock out power before you replace heater elements!*



Figure 10: Process Heater Location and Disassembly

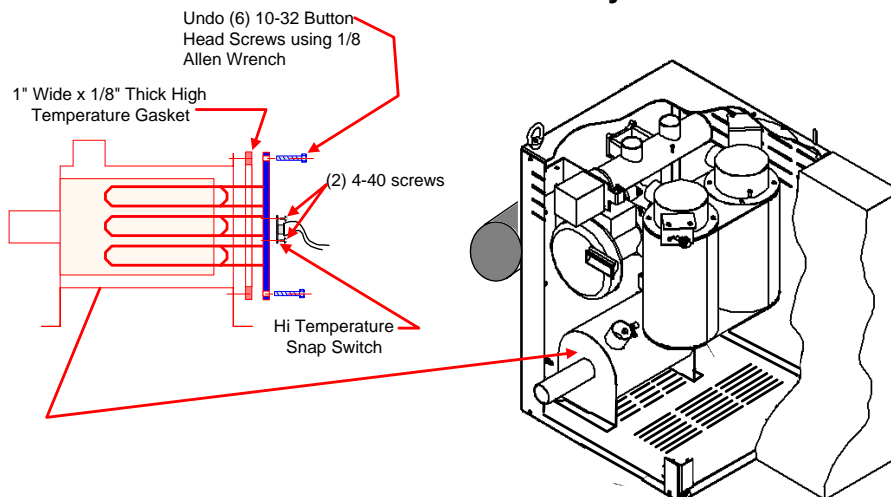

Procedures

1. Sketch the heater wiring configuration so you can properly re-wire the heater.
2. Remove the ceramic nuts and wires to the heater plate assembly being removed or replaced.
3. Remove the six (6) 10-32 button head screws securing the process heater plate using a 1/8" Allen wrench and slide out the assembly.
4. Remove the heater(s) from the mounting plate by removing the large brass nuts and washers.
5. Re-install the heater(s) and heater plate assemblies in reverse order. Install new heater gaskets and securely tighten all fasteners.

Caution! *Heater loops should not touch each other.*

“Hot spots” lead to premature heater failure!

6. Reinstall the wires based on the sketch you made earlier.
7. Reinstall the ceramic nuts to each heater terminal.

Replacing/Cleaning the Cooling Coils



WARNING! *Hazardous electrical current present.*

Disconnect and lock out power before you replace heater elements!

Figure 11: Cooling Coil Location and Disassembly

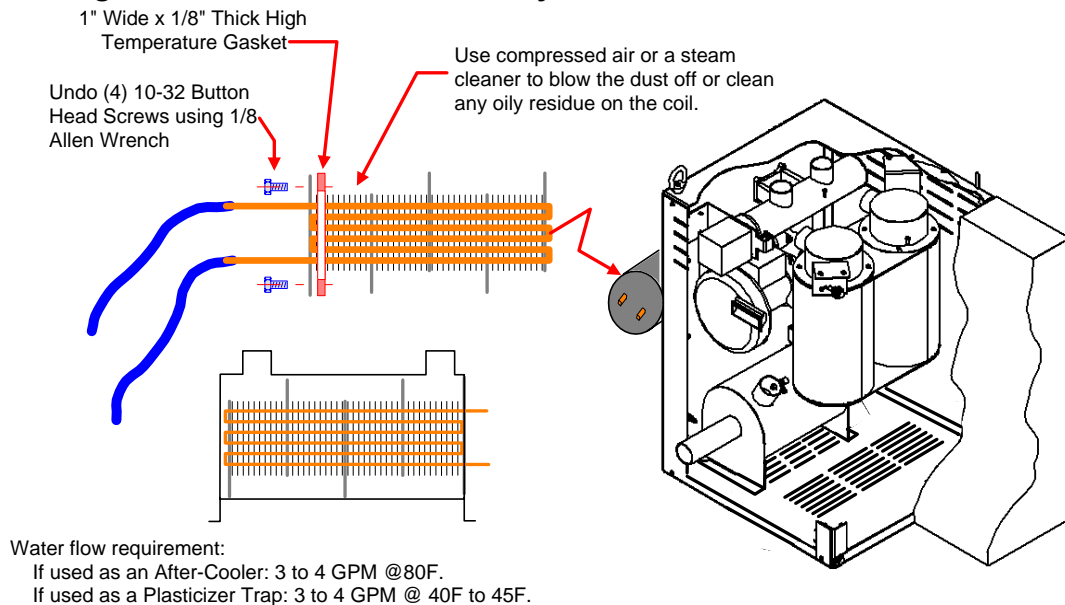

Note: *To clean the cooling coil, use compressed air or a steam cleaner to blow the dust off or clean any oily residue on the coil.*

Replacement Procedures

1. Shut down the dryer, tag out and lock out the controls if necessary.
2. Shut the water off to the cooling coil.
3. Remove the four 10-32 bolts.
4. Gently slide the cooling coil out.
5. Visually inspect the coil for leaks, dirt, and any sign of volatiles.
6. Blow the dust out, or if the coil is covered with plasticizer, steam clean it.
7. Place the coil back in its housing. Make sure the gasket is OK, replace if necessary.
8. Inset the four 10-32 bolts back in place.
9. Turn the water to the cooling coil back on.

Chapter 6: Troubleshooting

6-1 Introduction

The utmost in safety precautions should be observed at all times when working on or around the machine and the electrical components. All normal trouble-shooting must be accomplished with the power off, line fuses removed, and with the machine tagged as out of service.

The use of good quality test equipment cannot be over-emphasized when troubleshooting is indicated. Use a good ammeter that can measure at least twice the AC and DC current that can be encountered for the machine. Be sure that the voltmeter has at least minimum impedance of 5,000 OHMS-per-volt on AC and 20,000 OHMS-per-volt on DC scales. Popular combination meters, VOM and VTVM can be selected to provide the necessary functions.

Before making haphazard substitutions and repairs when defective electrical components are malfunctioning, we recommend that you check the associated circuitry and assemblies for other defective devices. It is common to replace the obviously damaged component without actually locating the real cause of the trouble. Such hasty substitutions will only destroy the new component. Refer to wiring diagrams and schematics.

Locating mechanical problems, should they occur, is relatively straightforward. When necessary, refer to the parts catalog section.

Alarm Message	Cause	Corrective Action	Dryer Status
VALVE POSITION FAULT	The limit switch on the valve may not have been wired correctly.	The switch is indicating the incorrect desiccant tank is in regeneration. Check the wiring of the switch against the wiring diagram. Make sure all the wire connections are tight.	- Dryer Shuts down: - Process blower OFF. - Process heaters OFF. - Regen heaters OFF. - Alarm light is ON - Alarm horn is ON.
VALVE MOTOR OVERRIDE	The valve has made enough rotations and the correct position of the valve was not detected.	Limit switch may be out of position. Re-adjust the switch to make sure it trips when it is at the high position, and it does not touch the cam when it is at the low position.	- Dryer Shuts down: - Process blower OFF. - Process heaters OFF. - Regen heaters OFF. - Alarm light is ON - Alarm horn is ON.
		Limit switch may be faulty. Replace the switch and make sure the wires are connected correctly.	

Alarm Message	Cause	Corrective Action	Dryer Status
PROCESS SENSOR FAIL	The process temperature thermocouple is open.	The process temperature thermocouple is not connected to the temperature controller. Make sure the connections are correct and tight.	<ul style="list-style-type: none"> - Dryer Shuts Down: - Process blower OFF. - Process heaters OFF. - Regen heaters OFF. - Alarm light is ON - Alarm horn is ON.
		The process temperature thermocouple is damaged. Replace the thermocouple.	
REGEN SENSOR FAIL	The Regeneration temperature thermocouple is open.	The regeneration temperature thermocouple is not connected to the temperature controller. Make sure the connections are correct and tight.	<ul style="list-style-type: none"> - Dryer Shuts Down: - Process blower OFF. - Process heaters OFF. - Regen heaters OFF. - Alarm light is ON - Alarm horn is ON.
		The regeneration temperature thermocouple is damaged. Replace the thermocouple.	
PROCESS HIGH TEMP	The process temperature has exceeded the alarm set point.	Make sure the process filter is clean. Clean or replace if necessary.	<ul style="list-style-type: none"> - Dryer Shuts Down: - Process blower OFF. - Process heaters OFF. - Regen heaters OFF. - Alarm light is ON - Alarm horn is ON
		Double check the alarm set point. 35°F	
		Check the positioning of the thermocouple inside the air inlet of the drying hopper. The tip of the thermocouple should be centered to the tube, and not touching any metal part of the tube.	
		The drying temperature set point is lower than dryer capabilities. Check the dryer specs.	
		Make sure all the hose connections are tight.	
		Make sure the regeneration timing cycle matches the specs. If not contact Service department.	

Alarm Message	Cause	Corrective Action	Dryer Status
PROCESS SENSOR FAIL	The process temperature thermocouple is open.	The process temperature thermocouple is not connected to the temperature controller. Make sure the connections are correct and tight.	<ul style="list-style-type: none"> - Dryer Shuts Down: - Process blower OFF. - Process heaters OFF. - Regen heaters OFF. - Alarm light is ON - Alarm horn is ON.
		The process temperature thermocouple is damaged. Replace the thermocouple.	
REGEN SENSOR FAIL	The Regeneration temperature thermocouple is open.	The regeneration temperature thermocouple is not connected to the temperature controller. Make sure the connections are correct and tight.	<ul style="list-style-type: none"> - Dryer Shuts Down: - Process blower OFF. - Process heaters OFF. - Regen heaters OFF. - Alarm light is ON - Alarm horn is ON.
		The regeneration temperature thermocouple is damaged. Replace the thermocouple.	
PROCESS HIGH TEMP	The process temperature has exceeded the alarm set point.	Make sure the process filter is clean. Clean or replace if necessary.	<ul style="list-style-type: none"> - Dryer Shuts Down: - Process blower OFF. - Process heaters OFF. - Regen heaters OFF. - Alarm light is ON - Alarm horn is ON
		Double check the alarm set point. 35°F	
		Check the positioning of the thermocouple inside the air inlet of the drying hopper. The tip of the thermocouple should be centered to the tube, and not touching any metal part of the tube.	
		The drying temperature set point is lower than dryer capabilities. Check the dryer specs.	
		Make sure all the hose connections are tight.	
		Make sure the regeneration timing cycle matches the specs. If not contact Service department.	

Alarm Message	Cause	Corrective Action	Dryer Status
REGEN LOW TEMP	The regeneration temperature did not get within the alarm set point.	Make sure all the hose connections inside the dryer are tight.	<ul style="list-style-type: none"> - Dryer Normal : - Process blower ON. - Process heaters ON. - Regen heaters ON. - Alarm Message ON. - Alarm horn is OFF.
		Check the regeneration heater fuses. Replace if necessary.	
		Check the heater contactors. Replace if necessary.	
		Check the heaters. Replace if necessary.	
		Check incoming voltage to the dryer specs.	
PROCESS LOOP BREAK	The process drying air temperature has not made any improvement toward the drying temperature set point for more than 480 seconds.	Check the positioning of the thermocouple inside the air inlet of the drying hopper. The tip of the thermocouple should be centered to the tube, and not touching any metal part of the tube.	<ul style="list-style-type: none"> - Dryer Shuts Down : - Process blower OFF. - Process heaters OFF. - Regen heaters OFF. - Alarm Message ON. - Alarm horn is ON.
		Make sure all the hose connections are tight.	
		For drying temperature of 250°F or higher, delivery air hose should be insulated.	
		Check the heater contactors. Replace if necessary.	
		Check the heaters. Replace if necessary.	
		Check incoming voltage to the dryer specs.	
HIGH DEW POINT	The dew point reading has exceeded the dew point alarm set point.	Make sure the process air filter is clean. Clean or replace if necessary.	<ul style="list-style-type: none"> - Dryer Normal : - Process blower ON. - Process heaters ON. - Regen heaters ON. - Alarm Message ON. - Alarm horn is OFF.
		Make sure all the hose connections and all the components of the dryer have proper seals on them (desiccant tanks, heater box, filters, after-cooler ...). Tighten the connections and replace any damaged seals.	
		Make sure the regeneration timing cycle matches the specs. If not contact Service department.	
		Desiccant may be contaminated and blocking the air flow. Check desiccant, replace if necessary.	

Alarm Message	Cause	Corrective Action	Dryer Status
PROCESS BLOWER FAIL	The process blower pressure switch did not detect enough pressure.	Make sure the process air filter is clean. Clean or replace if necessary.	<ul style="list-style-type: none"> - Dryer Shuts Down : - Process blower OFF. - Process heaters OFF. - Regen heaters OFF. - Alarm Message ON. - Alarm horn is ON.
		Check the rotation of the blower.	
		Check the pressure switch hose connection. Replace hoses or the pressure switch.	
	Process blower overload has tripped.	Check the over load rating against the wiring diagram. Adjust accordingly.	
	Process blower motor has failed.	Check the wiring of the blower. Make sure it is wired for the proper voltage.	
		Check the process blower fuses for any fault. Replace if necessary.	
		Check the blower motor starter. Replace if necessary.	
		Check the blower motor. Replace if necessary.	
		Check the incoming voltage against the name plate of the dryer.	
PROCESS HEATER FAIL	The process heater safety contactor is not responding.	Check the heater fuses, replace if necessary.	<ul style="list-style-type: none"> - Dryer Shuts Down : - Process blower OFF. - Process heaters OFF. - Regen heaters OFF. - Alarm Message ON. - Alarm horn is ON.
		Make sure the wiring is correct and wire connections are tight.	
		Check the process heater safety contactor. Replace if necessary.	
DIRTY FILTER	The filter pressure differential switch has tripped.	Make sure the process air filter is clean. Clean or replace if necessary	<ul style="list-style-type: none"> - Dryer Normal : - Process blower ON. - Process heaters ON. - Regen heaters ON. - Alarm Message ON. - Alarm horn is OFF.
		Make sure the filter housing is installed correctly, and the connections are tight.	
		Check the hoses to the filter pressure differential switch is connected correctly, are not damaged, and all the connections are tight. Replace the hoses if necessary.	
		Check the wiring connections to filter pressure differential switch against the print. Tighten the connections.	

Alarm Message	Cause	Corrective Action	Dryer Status
DIRTY FILTER	The filter pressure differential switch has tripped.	Check the pressure setting of the filter pressure differential switch against the print. Adjust accordingly.	<ul style="list-style-type: none"> - Dryer Normal : - Process blower ON. - Process heaters ON. - Regen heaters ON. - Alarm Message ON. - Alarm horn is OFF.
		Check the filter pressure differential switch to make sure it is functioning. Replace is necessary.	
VALVE MOTOR FAIL	The limit switch on the valve may not have been wired correctly.	The switch is indicating the incorrect desiccant tank is in regeneration. Check the wiring of the switch against the wiring diagram. Make sure all the wire connections are tight.	<ul style="list-style-type: none"> - Dryer Shuts Down : - Process blower OFF. - Process heaters OFF. - Regen heaters OFF. - Alarm Message ON. - Alarm horn is ON.
P RETURN SENSOR FAIL	The return air temperature thermocouple is open or failed.	The return air temperature thermocouple is not connected to the temperature controller. Make sure the connections are correct and tight.	<ul style="list-style-type: none"> - Dryer Normal : - Process blower ON. - Process heaters ON. - Regen heaters ON. - Alarm Message ON. - Alarm horn is OFF.
		The return air temperature thermocouple is damaged. Replace the thermocouple.	
PROCESS TEMP SAFETY	The high temperature snap switch of the process heater box has tripped.	Make sure the process air filter is clean. Clean or replace if necessary.	<ul style="list-style-type: none"> - Dryer Shuts Down : - Process blower OFF. - Process heaters OFF. - Regen heaters OFF. - Alarm Message ON. - Alarm horn is ON.
		Make sure all the hose connections are tight.	
		The process heater contactor has failed in the closed position. Check heater contactor, replace if necessary.	
		Check the high temperature snap switch, replace if necessary.	
REGEN TEMP SAFETY	The high temperature snap switch on of the regeneration heater boxes has tripped	Make sure the process air filter is clean. Clean or replace if necessary.	<ul style="list-style-type: none"> - Dryer Shuts Down : - Process blower OFF. - Process heaters OFF. - Regen heaters OFF. - Alarm Message ON. - Alarm horn is ON.
		Make sure all the hose connections are tight.	
		The Regeneration heater contactor has failed in the closed position. Check heater contactor, replace if necessary.	
		Check the high temperature snap switches, replace if necessary.	

6-2 Determining Temperature Controller Errors or Sensor Errors

Using a Thermocouple

If the controller displays a temperature that is close to room temperature (70°F/21°C) when you short-circuit controller input terminals, the controller is normal and the sensor is probably broken, short-circuited, or incorrectly wired.

Other service problems or questions can be answered by contacting the Service Department.

Chapter 7: Appendix

7-1 Warranty

Unless otherwise specified, this product includes a Standard ONE YEAR PARTS.

Warranty Specifications

The manufacturer hereby expressly warrants all equipment manufactured by it to be free from defects in workmanship and material when used under recommended conditions, as set forth in the operating manuals for such equipment. THE FOREGOING EXPRESS WARRANTY IS EXCLUSIVE AND IN LIEU OF ALL OTHER WARRANTIES, GUARANTEES, AGREEMENTS, AND SIMILAR OBLIGATIONS OF THE COMPANY AND/OR MANUFACTURER (UNLESS OTHERWISE SPECIFIED IN THE SPECIFIC PRICE PAGE OR LIMITED BY THE MANUFACTURERS' WARRANTY FOR PARTS). The Company's obligation is limited to repair or replace FOB the factory any parts that are returned, prepaid, within one year of equipment shipment to the original purchaser, and which in the Company's opinion, are defective. Any replacement part assumes the unused portion of this warranty.

Warranty Restrictions

This parts warranty does not cover any labor charges for replacement of parts, adjustment repairs, or any other work. This warranty does not apply to any equipment which, in the Company's opinion, has been subjected to misuse, negligence, or operation in excess of recommended limits, including freezing or which has been repaired or altered without the Company's express authorization. If the serial number has been defaced or removed from the component, the warranty on that component is void. Defective parts become the property of the warrantor and are to be returned immediately, without any further use or handling.

Warranty Liabilities

THE COMPANY EXPRESSLY DISCLAIMS ANY AND ALL LIABILITY FOR ANY SPECIAL, CONSEQUENTIAL OR INCIDENTAL DAMAGES OR EXPENSES THAT RESULT FROM THE USE OF THIS PRODUCT. Some states do not allow the exclusion or limitation of special, consequential or incidental damages, so the above limitation may not apply to you. The Company's obligation for parts not furnished as components of its manufactured equipment is limited to the warranty of the manufacturers of said parts. The company neither assumes nor authorizes any other persons to assume for it any liability in connection with the sale of its equipment not expressed in this warranty. No person, agent, manufacturer, distributor, dealer, installer or company is authorized to change, modify or extend the terms of this warranty in any manner whatsoever.

The time within which an action must be commenced to enforce any obligation of the Company's arising under this warranty, or under any statute or law of the United States or any state thereof, is hereby limited to the duration of this warranty. Some states do not permit this limitation, so the above may not apply to you. This warranty gives you specific legal rights and you may also have other rights which vary from state to state. For transactions involving the potential applicability of international law or that of a foreign country, this warranty policy and the procedures hereunder shall be governed by

applicable federal and state law, but not by the United Nations Convention on Contracts for the Sale of Goods.

Customer Responsibilities

Any sales, use, or other tax incident to the replacement of parts under this warranty is the responsibility of the purchaser.

7-2 Optional Components

The following is a list of options which your Portable Drying/Conveying System may have been equipped with:

- **High Temperature Option (with Aftercooler)**
- **Casters.**

7-3 Technical Specifications

Annex B Information

The following design information is provided for your reference:

1. No modifications are allowed to this equipment that could alter the CE compliance
2. Ambient temperature: 40 degrees Celsius – Maximum (104 degrees Fahrenheit)
3. Humidity range: 50% relative humidity
4. Altitude: Sea level
5. Environment: Clean, dust-free and non-explosive
6. Radiation: None
7. Vibration: Minimal, i.e. machine mounting
8. Allowable voltage fluctuation: +/- 10%
9. Allowable frequency fluctuation: Continuous +/- 1%
Intermittent +/- 2%
10. Nominal supply voltage: 460/3/60 (Verify on serial number tag)
11. Earth ground type: TN (system has one point directly earthed through a protective conductor)
12. Power supply should include a ground connection.
13. Over-current protection is supplied in the dryer and conveying system, but additional protection should be supplied by the user.
14. The door-mounted disconnect serves as the electrical disconnect device.
15. Dryer and conveying system are not equipped with local lighting.
16. Functional identification
17. Dryer and conveying system are equipped with a CE mark
18. Dryer and conveying system are supplied with an operating manual in the language of the destination country.
19. Cable support may be required for power cord, depending on final installation.
20. No one is required to be in the interior of the electrical enclosure during the normal operation of the unit. Only skilled electricians should be inside the enclosure for maintenance.
21. Doors can be opened with a screwdriver, but no keys are required.

22. Two-hand control is not required or provided.
23. All dryers and conveying equipment should be moved around and set in a place with a lift truck or equivalent.
24. There are no frequent repetitive cycles that require manual control—repetitive functions are automatic while the drying and conveying system is operating.
25. An inspection report detailing the functional test is included with the dryer and conveying system.
26. The machine is not equipped with cable less controls.
27. Color-coded (harmonized) power cord is sufficient for proper installation.

Aftercooler Design Specifications

Entering water temp.	
°F	°C
85°F	29°C
50°F (If used as Plasticizer trap)	10°C (If used as Plasticizer trap)

7-4 Drawings and Diagrams

Figure 12: Standard Model (180°F to 250°F) Air Flow Schematic

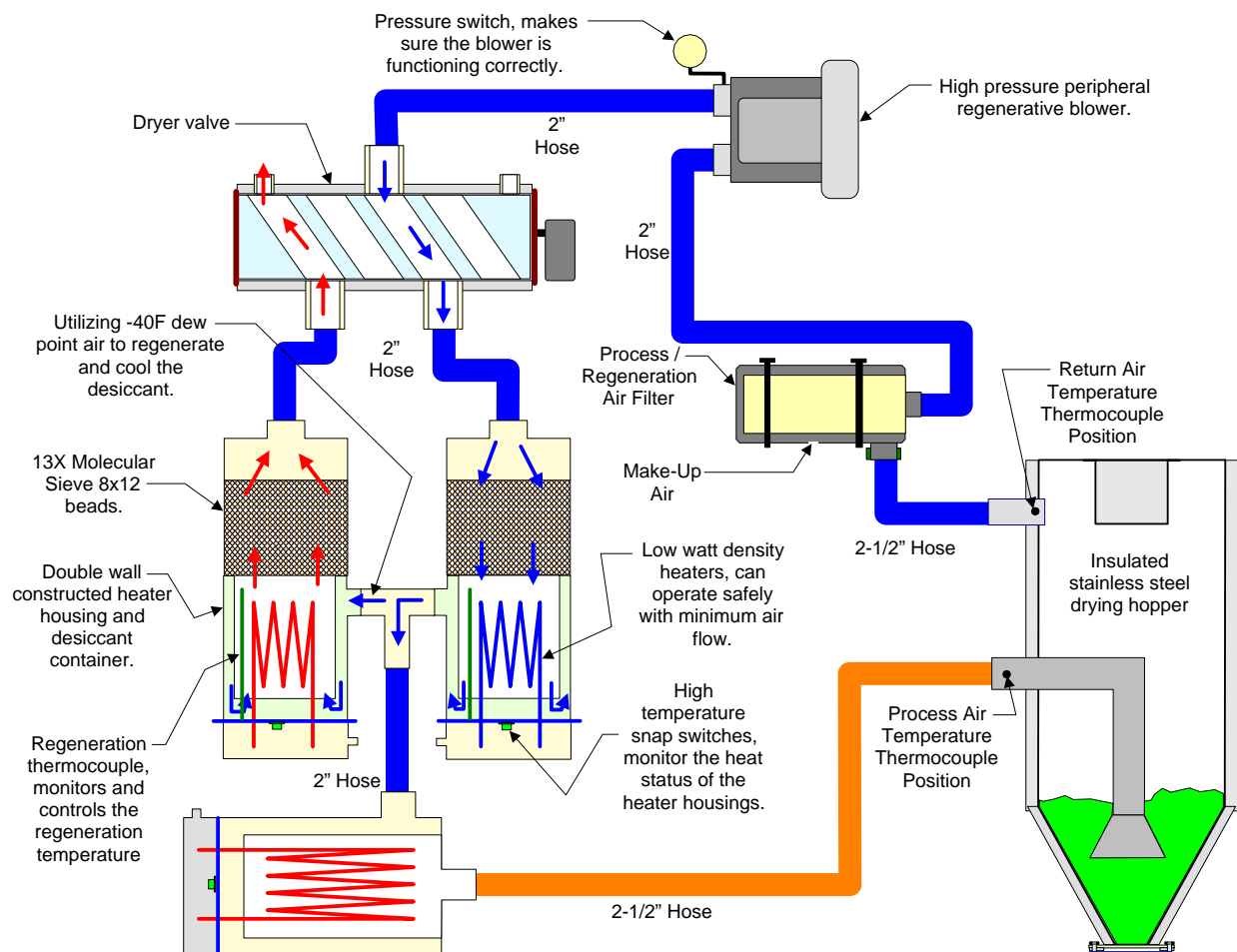

Figure 13: High Heat Model (180°F to 400°F) Air Flow Schematic

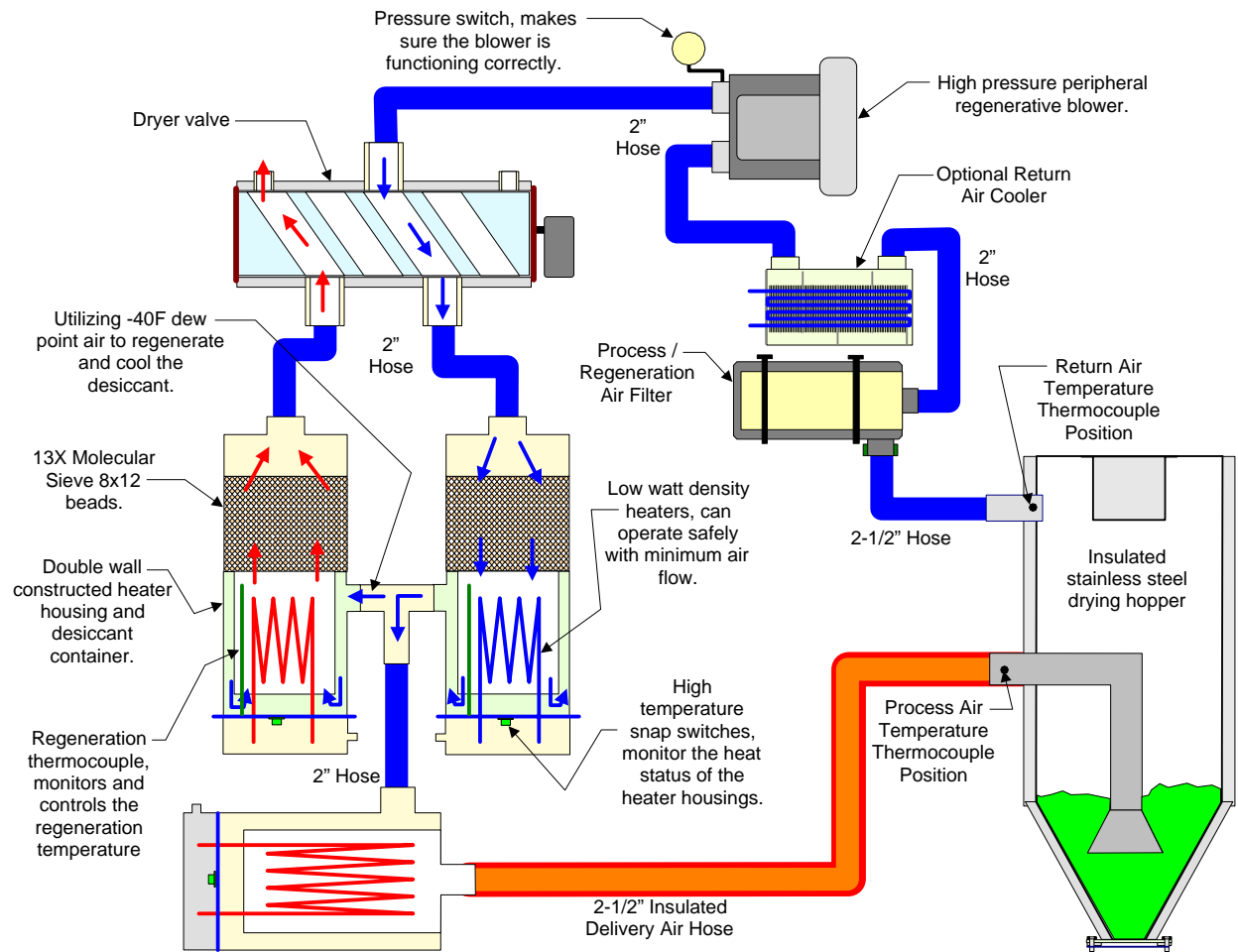
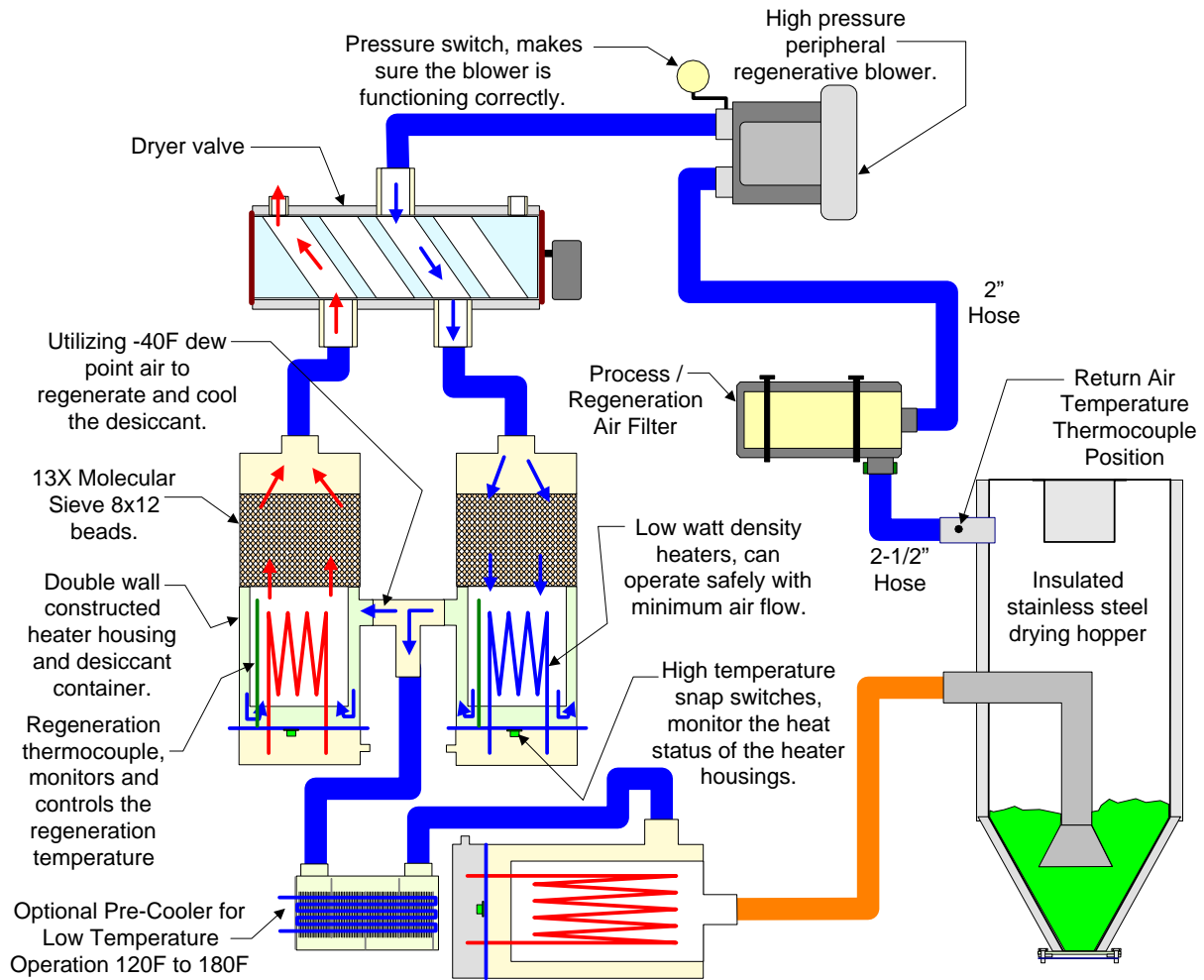

Figure 14: Low Heat Model (120°F to 250°F) Air Flow Schematic



7-6 Returned Material Policy

Credit Returns

Prior to the return of any material **authorization** must be given by **the manufacturer**. A RMA number will be assigned for the equipment to be returned.

Reason for requesting the return must be given.

ALL returned material purchased from **the manufacturer** returned is subject to 15% (\$75.00 minimum) restocking charge.

ALL returns are to be shipped prepaid.

The invoice number and date or purchase order number and date must be supplied.

No credit will be issued for material that is not within the manufacturer's warranty period and/or in new and unused condition, suitable for resale.

Warranty Returns

Prior to the return of any material, authorization must be given by **the manufacturer**. A RMA number will be assigned for the equipment to be returned.

Reason for requesting the return must be given.

All returns are to be shipped prepaid.

The invoice number and date or purchase order number and date must be supplied.

After inspecting the material, a replacement or credit will be given, at **the manufacturer's** discretion. If the item is found to be defective in materials or workmanship, and it was manufactured by our company, purchased components are covered under their specific warranty terms.

7-7 Dryer Identification (Serial Number) Tag

(Located on back of Dryer)

Company Logo	
	XXX Series Dryer Model Number XXX-15
Max Drying Capacity HR	
460V	Serial Number 060701R
1Ø	Date of Manufacture 06/2003
4.5A	
Over-current Protection Device (s) 4.5A Total	
Frequency 50/60Hz	
Compressed air supply None	
Dryer Mass 400 lbs/(180 KG)	
Electrical Diagrams & Pneumatic Diagram	<input type="text"/>
Street Address	City, State Zip Code
Telephone Number	

7-8 Technical Assistance

Parts Department

Call toll-free 7am–5pm CST [800] 423-3183 or call [630] 595-1060, Fax [630] 475-7005

The ACS Customer Service Group will provide your company with genuine OEM quality parts manufactured to engineering design specifications, which will maximize your equipment's performance and efficiency. To assist in expediting your phone or fax order, please have the model and serial number of your unit when you contact us. A customer replacement parts list is included in this manual for your convenience. ACS welcomes inquiries on all your parts needs and is dedicated to providing excellent customer service.

Service Department

Call toll-free 8am–5pm CST [800] 233-4819 or call [630] 595-1060

Emergencies after 5pm CST, call [847] 439-5655

We have a qualified service department ready to help. Service contracts are available for most products.

Sales Department

Call [630] 595-1060 Monday–Friday, 8am–5pm CST

Our products are sold by a world-wide network of independent sales representatives. Contact our Sales Department for the name of the sales representative nearest you.

Contract Department

Call [630] 595-1060 Monday–Friday, 8am–5pm CST

Let us install your system. The Contract Department offers any or all of these services: project planning; system packages including drawings; equipment, labor, and construction materials; and union or non-union installations.

Free Manuals Download Website

<http://myh66.com>

<http://usermanuals.us>

<http://www.somanuals.com>

<http://www.4manuals.cc>

<http://www.manual-lib.com>

<http://www.404manual.com>

<http://www.luxmanual.com>

<http://aubethermostatmanual.com>

Golf course search by state

<http://golfingnear.com>

Email search by domain

<http://emailbydomain.com>

Auto manuals search

<http://auto.somanuals.com>

TV manuals search

<http://tv.somanuals.com>