



# SDAP Nomad Dryer with AP1 Control

## Reference Manual (PN: 882.00281.00) for Complete Operation and Installation Instructions

(Available online at [www.sterco.com](http://www.sterco.com))

### Quick Start Pre-Startup Checklist

1. Check the process and return hoses for tight connections.
2. Check all companion equipment, such as the drying hopper; verify the loading system is ready for operation.
3. Verify all dryer electrical connections are tight.
4. Verify the thermocouple is properly installed at the hopper inlet.
5. Verify temperature unit/scale (°F or °C).

### Quick Startup Checklist

1. Turn **ON** the power disconnect switch in your power drop, then turn **ON** the power disconnect switch on the dryer.
2. Turn the dryer **ON/OFF** switch to **ON** to energize the display panel.
3. Check the display for the proper temperature scale (°F or °C).
4. Close the slide gate at the bottom of the drying hopper.
5. Fill the drying hopper with material.
6. Press the **START** button on the touch screen to start the dryer (Display will change to **SHUTDOWN**). The process blower starts.
  - a. Make sure the blower turns in the correct direction.
  - b. Disconnect the hose from drying hopper to the filter.
  - c. Quickly turn the **ON/OFF** switch to **OFF**. You should feel a suction at the inlet of the filter. (Secure the hose back in place).

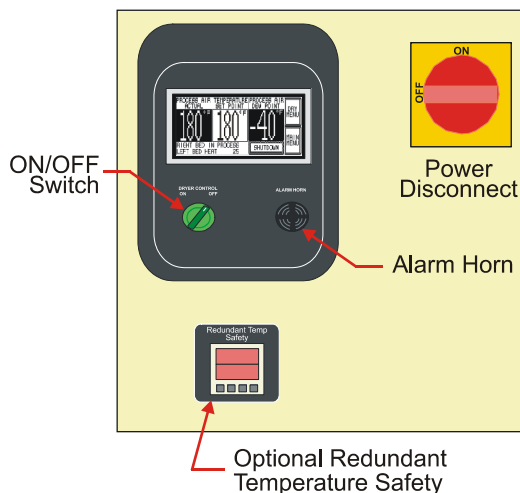

### Setting the Process Air Temperature

1. Press and hold the **SET POINT** Display until a number key pad appears.
2. Enter the values you would like to set in the screen by pressing the number keys.
3. Press **ENT** (Enter) when you are finished.

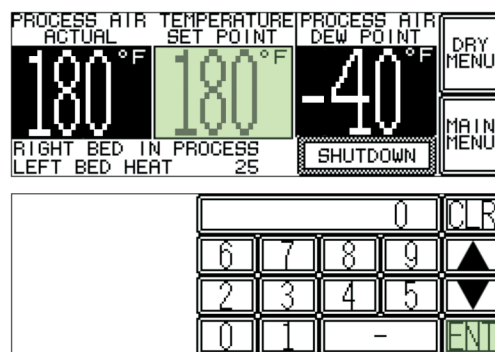

### Auto-Tuning the Dryer

1. From the "Dryer Status" screen, press "Dry Menu".
2. Select Auto Tune to gain access to this screen. The **Access Code** into the Auto Tune screen is: **1234**.

**Note:** The auto tune feature can be enabled by pressing the **PUSH TO START** button. **AUTOTUNE IN PROGRESS** or **PROCESS NOT ACTIVE** will inform the operator of the current status of this feature.

3. At this point, the operator can return back to the **DRYER MENU** or **MAIN MENU** by touching the appropriate button on the screen.

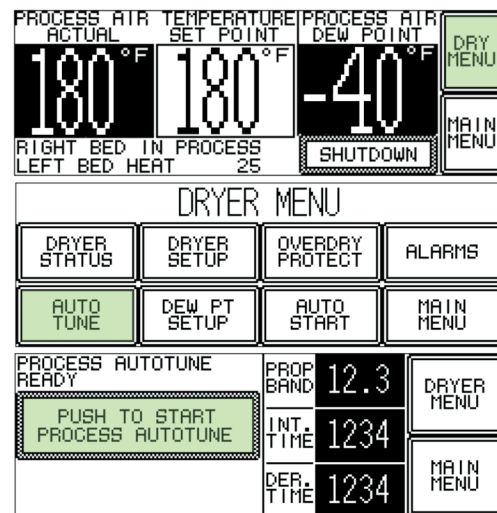

### Setting the Redundant Safety Controller

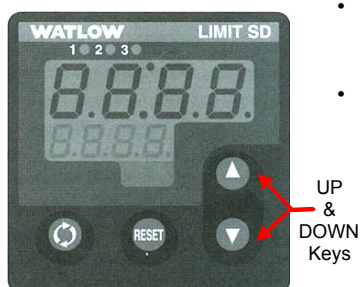

- The Redundant Safety Controller alarm setting is changed by pressing the up and down keys, which inputs the alarm value.
- The upper display reading indicates the Process Value, while the lower display indicates the High Point Setting alarm value.



**SDAP Nomad Dryer with AP1 Control**  
**Reference Manual (PN: 882.00281.00) for**  
**Complete Operation and Installation Instructions**  
 (Available online at [www.sterco.com](http://www.sterco.com))

**Start & Stop Conveying Feature**

- From Dryer status screen, press **MAIN MENU**. From the **MAIN MENU** screen, press **CONVEY STATUS**.
- This screen provides the operator with the current status of **M1** (Machine Hopper 1), **M2** (Machine Hopper 2), **DH** (Drying Hopper), **MB** (Machine Blower), and the **HB** (Hopper Blower). Within this screen, the operator can access different variables in the conveying system and **START** or **STOP** the process.
- Momentarily pressing the **M1**, **M2**, **DH**, **MB**, or **HB** icons on the screen will darken or turn them black. **This indicates they are active in the conveying system.**
- To access the **Operator Screens** for the hoppers, press and hold the **M1**, **M2**, or **DH** icons on the screen.
- To get back to the **DRYER STATUS** screen, press the **MAIN MENU** button, then press the **DRYER STATUS** button on the **DRYER MENU**.

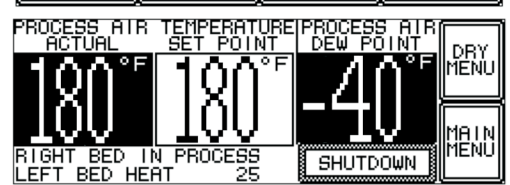
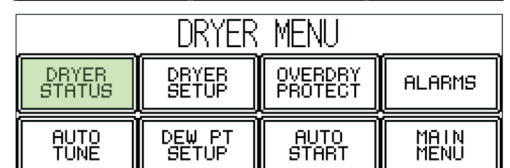
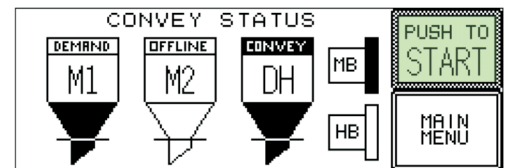
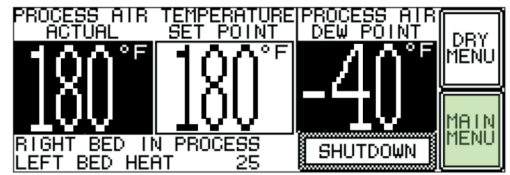

**NOMAD II – AD Dryer (Seven Configurations)**

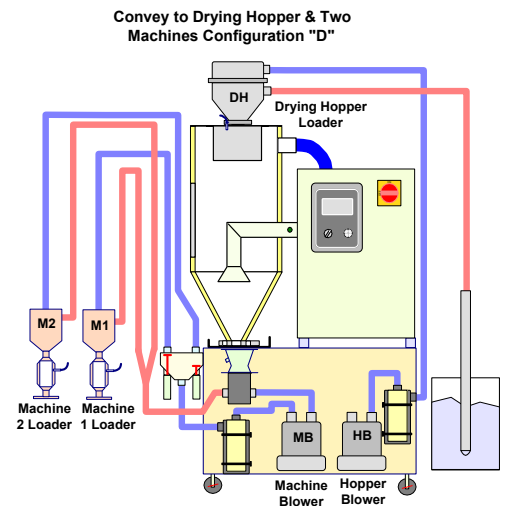
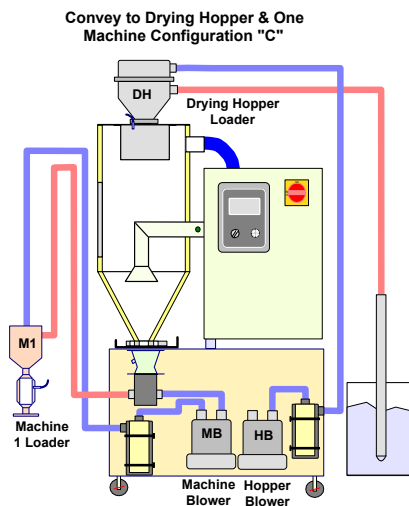
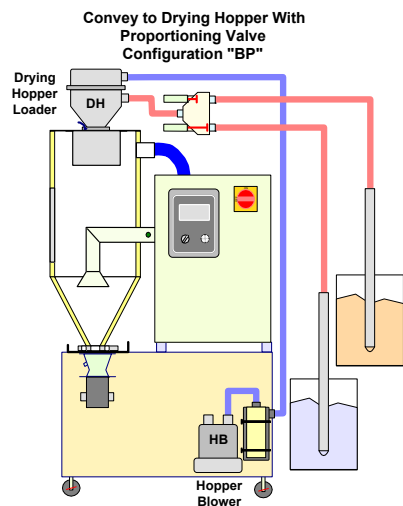
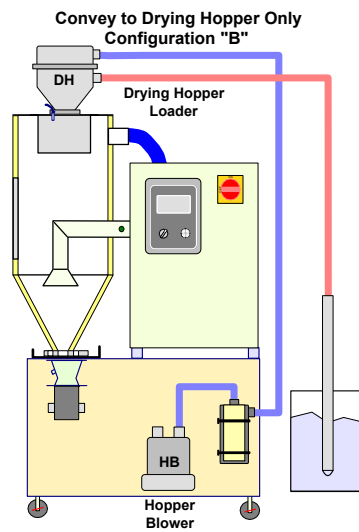
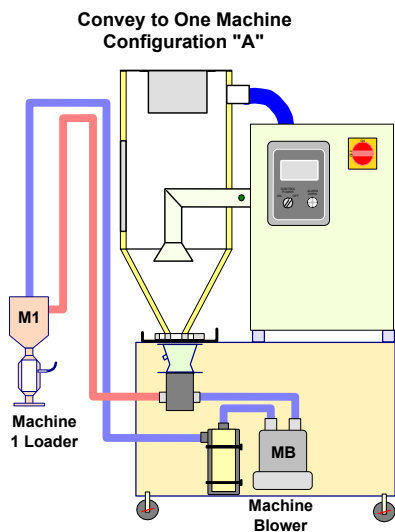



# SDAP Nomad Dryer with AP1 Control

Reference Manual (PN: 882.00281.00) for  
Complete Operation and Installation Instructions  
(Available online at [www.sterco.com](http://www.sterco.com))

Convey to Drying Hopper With Proportioning Valve & Two Machines, Configuration "DP"

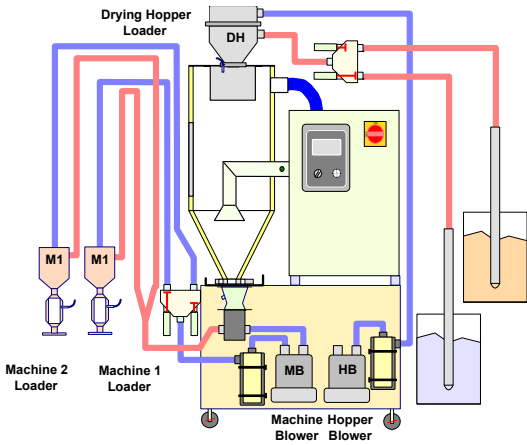

Convey to Drying Hopper With Proportioning Valve & Two Machines, Configuration "CP"

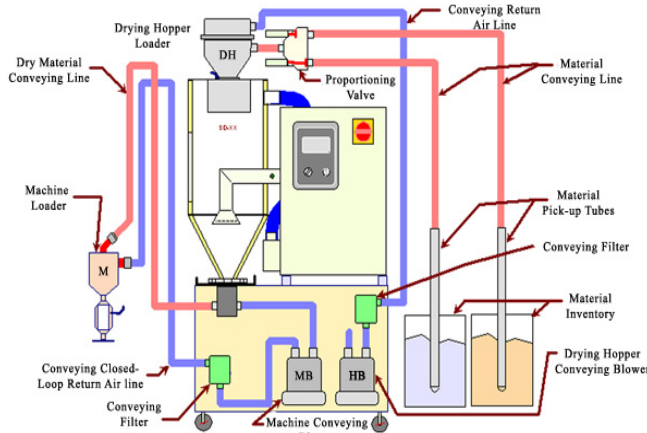

(Air Flow Schematic)

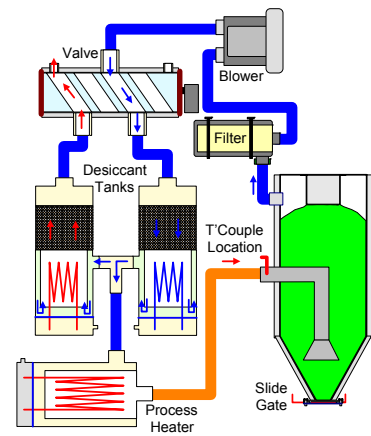

## Maintenance

### Filters: Recommendations for Cleaning and Replacing

1. Turn off and/or lock out electrical power to the dryer.
2. Loosen the clamp, and remove the dust can.
3. Remove the thumb nut, on the center retaining rod, to remove the filter cartridge.
4. Pull the filter cartridge out.

### Vacuuming

- Try vacuum-cleaning a soiled filter first. Vacuuming removes most large particles and surface contaminants, and may suffice for the first time you clean a filter.
- Use a commercial-duty (recommended) or household vacuum cleaner. Vacuum the filter from the air intake (dirty) side only.

### Cleaning with Compressed Air

1. Blow clean, dry, compressed air up and down the pleats, blowing out the filter from the inside out.
2. Remove loose dirt from the filter with compressed air or vacuum from the outside.
3. Inspect the filter element. Briefly hold a light bulb behind the element and look for any fatigued paper or residual dirt. Inspect for holes and tears by looking through the filter toward a bright light. Check for damaged gaskets or dented metal parts.

**Note: Do not re-use a damaged filter!**

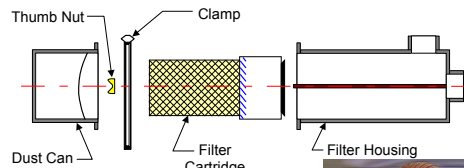
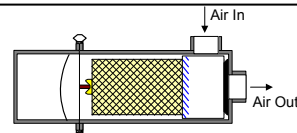

(Return Air Filter)



### Cooling Coils: Cleaning and Replacement Procedures

1. Shut down the dryer, tag out and lock out the controls if necessary.
2. Shut the water off to the cooling coil.
3. Remove the four 10-32 bolts.
4. Gently slide the cooling coil out.
5. Visually inspect the coil for leaks, dirt, and any sign of contaminants.
6. Blow the dust out, or if the coil is covered with plasticizer, steam clean it.
7. Place the coil back in its housing. Make sure the gasket is undamaged; replace if necessary.
8. Inset the four 10-32 bolts back in place.
9. Turn the water to the cooling coil back on.

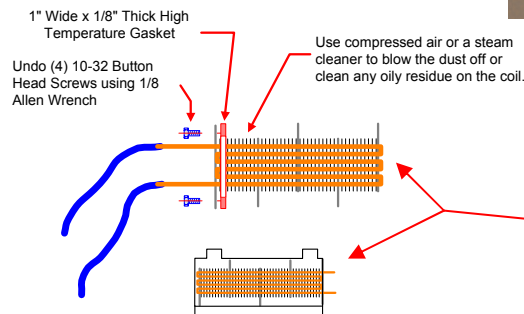

(Cooling Coil)

Water flow requirement:  
If used as an After-Cooler: 3 to 4 GPM @80°F.  
If used as a Plasticizer Trap: 3 to 4 GPM @ 40°F to 45°F.



**SDAP Nomad Dryer with AP1 Control**  
**Reference Manual (PN: 882.00281.00) for**  
**Complete Operation and Installation Instructions**  
 (Available online at [www.sterlco.com](http://www.sterlco.com))

**Spare Parts List**

Model	Filter	Desiccant Replacement Beads	Regeneration Thermocouple	Process Thermocouple	Gasket
SDAP 25/50/100	Standard Temperature – Part # W00052474 High Temperature – Part # 161.00194.00	13 X Beads – Part # W00018051	25 ONLY – 96" Long – Part # A0568474 50/100 ONLY – 96" Long – Part # A0543758	15' Long (Braided Design) – Part # A0568466 72" Long (Braided Design) – Part # A0568473	Standard and High Temperature – Part # A0566839

**Note: Refer to the main manual and wiring diagram for a complete Spare Parts List**

**Troubleshooting - Quick Guide**

Alarm Message	Cause	Corrective Action	Dryer Status
High Dew Point	The dew point reading has exceeded the dew point alarm set point.	Make sure the process air filter is clean. Clean or replace if necessary.	<b>Dryer Normal:</b> - Process blower ON. - Process heaters ON. - Regen heaters ON. - Alarm Message ON. - Alarm horn is OFF.
		Make sure all the hose connections and all the components of the dryer have proper seals on them (i.e. desiccant tanks, heater box, filters, after-cooler). Tighten the connections and replace any damaged seals.	
		Make sure the regeneration timing cycle matches the specs. If not, contact the Service Department.	
		Desiccant may be contaminated and blocking the air flow. Check desiccant, replace if necessary.	
Process High Temp	The process temperature has exceeded the alarm set point.	Make sure the process filter is clean. Clean or replace if necessary.	<b>Dryer Shuts Down:</b> - Process blower OFF. - Process heaters OFF. - Regen heaters OFF. - Alarm light is ON. - Alarm horn is ON.
		Double check the alarm set point is at 35° F.	
		Check the positioning of the thermocouple inside the air inlet of the drying hopper. The tip of the thermocouple should be centered in the tube, and not touching any metal part of the tube.	
		The drying temperature set point is lower than dryer capabilities. Check the dryer specs.	
		Make sure all the hose connections are tight.	
Valve Positioning Fault	The limit switch on the valve may not have been wired correctly.	The switch is indicating the incorrect desiccant tank is in regeneration. Check the wiring of the switch against the wiring diagram. Make sure all the wire connections are tight.	<b>Dryer Shuts Down:</b> - Process blower OFF. - Process heaters OFF. - Regen heaters OFF. - Alarm light is ON. - Alarm horn is ON.
		Limit switch may be out of position. Re-adjust the switch so it trips when it is at the high position, and avoids touching the cam when it is at the low position.	
Valve Motor Override	The valve has made enough rotations and the correct position of the valve was not detected.	Limit switch may be faulty. Replace the switch and make sure the wires are connected correctly.	

## Free Manuals Download Website

<http://myh66.com>

<http://usermanuals.us>

<http://www.somanuals.com>

<http://www.4manuals.cc>

<http://www.manual-lib.com>

<http://www.404manual.com>

<http://www.luxmanual.com>

<http://aubethermostatmanual.com>

Golf course search by state

<http://golfingnear.com>

Email search by domain

<http://emailbydomain.com>

Auto manuals search

<http://auto.somanuals.com>

TV manuals search

<http://tv.somanuals.com>