

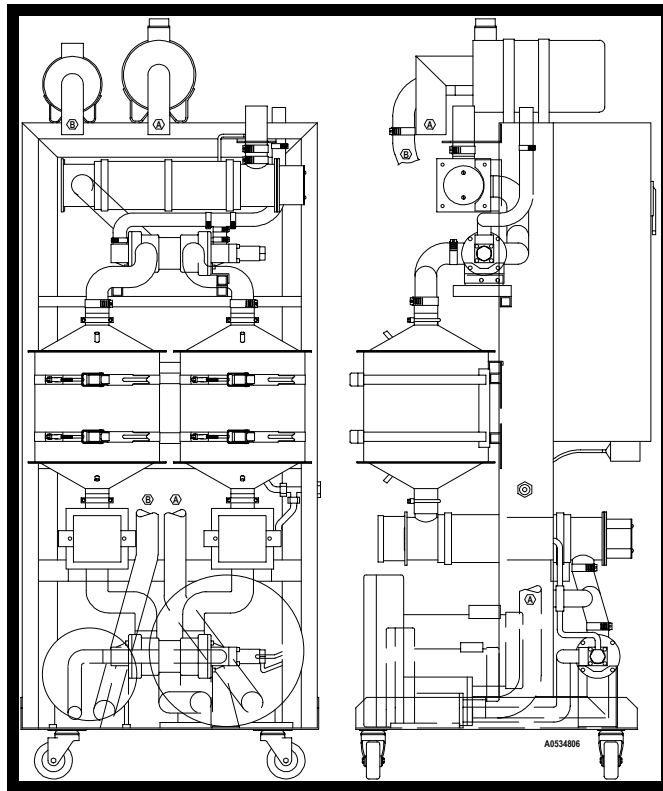

Operation and Installation Manual

SDA 150-380 (90-225 CFM) Cabinet Series Dehumidifying Dryers

Important! Read Carefully Before Attempting to Install or Operate



Part No: 882.00282.00 Effective: 12/01/05 Bulletin No: DH1-630

Performance figures stated in this manual are based on a standard atmosphere of 59°F (15°C) at 29.92" Hg (1,014 millibars) at sea level, using 60 hz power. Altitude is an important consideration when specifying drying and conveying systems. The manufacturer can advise you on proper selection and sizing of systems for your operating environment.

We are committed to a continuing program of product improvement. Specifications, appearance, and dimensions described in this manual are subject to change without notice.

© Copyright 2005

All rights reserved.
Part No. 882.00029.00

Effective 12/9/2005
Bulletin No. WH1-606

Table of Contents

CHAPTER 1: SAFETY	6
1-1 How to Use This Manual.....	6
<i>Safety Symbols Used in this Manual</i>	6
1-2 Warnings and Precautions.....	7
1-3 Responsibility.....	8
<i>General Responsibility</i>	8
<i>Operator Responsibility</i>	8
<i>Maintenance Responsibility</i>	9
<i>Reporting a Safety Defect</i>	10
CHAPTER 2: GENERAL INFORMATION	11
2-1 Models Covered.....	11
2-2 Equipment Function.....	11
2-3 Necessary Documents.....	11
2-4 Standard Features.....	11
2-5 Options.....	11
2-6 The Closed Loop Drying System.....	12
2-7 What is Desiccant?.....	13
2-8 The Process/Regeneration Cycle.....	13
2-9 Specifying a Drying/Conveying System.....	13
CHAPTER 3: INSTALLATION	14
3-1 Positioning Your Dryer.....	14
3-2 Making Electrical Connections.....	14
3-3 Connecting Compressed Air.....	14
3-4 Checking for Proper Blower Rotation.....	14
<i>Three Phase Models</i>	14
3-5 Process Air Connections Between the Dryer and the Drying Hopper.....	15
3-6 Connecting Cooling Water to the Optional Aftercooler.....	15
<i>Installing Water Lines</i>	15
3-7 Drying Hopper.....	15
<i>Removing the Rust Inhibitor</i>	15
<i>Air Trap Considerations</i>	15
CHAPTER 4: CONTROLS	16
4-1 Control Panel Indicator Lights and Switches.....	16
<i>Rocker Switches</i>	16
<i>Indicating Lights</i>	16
4-2 Process Air Dew Point Display.....	19
4-3 Process Air Temperature Controller.....	19
4-4 Identifying Temperature Controller LED Indicators.....	19
4-5 Identifying Temperature Controller Buttons.....	20
<i>E5CK Operating Parameters</i>	21
<i>Available E5CK Modes</i>	21

4-6	Setting the Process Air Temperature	22
4-7	PLC Controller	22
	<i>PLC LED Indicators</i>	23
	<i>Output LED Indicators</i>	24
	<i>Status LED Indicators</i>	24
4-8	Setting the Shift on Dew Point	28
4-9	Entering Operating Parameters to Select Modes	28
4-10	Setting the High Dew Point Alarm	28
4-11	Optional Seven-Day Timer	29
	<i>Programming the Optional Times</i>	30
	<i>Checking the Set Time</i>	31
	<i>Day Override</i>	32
	<i>Canceling the Settings</i>	32
CHAPTER 5: OPERATION.....		34
5-1	Pre-Startup Checks	34
5-2	Startup	34
5-3	Shutdown	34
CHAPTER 6: MAINTENANCE.....		36
6-1	Work Rules	36
6-2	Servicing Process Air Filters	36
	<i>Recommendations for Cleaning and Replacing Filters</i>	37
6-3	Servicing the Dew Point Monitor	39
6-4	Symptoms of Worn Desiccant	39
6-5	Replacing Worn Desiccant	40
6-6	Replacing the Process Heater	41
6-7	Replacing the Regeneration Heater	42
	<i>Changing the Controller Security Level</i>	42
	<i>Restoring Factory Defaults on the Process Temperature Controller</i>	42
	<i>Restoring Factory Defaults on the Dew Point Controller</i>	46
6-8	Restoring the E5CK Temperature Controller and Dew Point Meter to Factory Setup	47
CHAPTER 7: TROUBLESHOOTING.....		48
CHAPTER 8: APPENDIX.....		52
8-1	Contact Information	52
8-2	Technical Specifications	52

Charts and Figures

1	<i>Dryer Air Flow Diagram</i>	12
2	<i>Typical Dryer Interface Panel</i>	18
3	<i>Typical Dryer Temperature Controller</i>	20
4	<i>Display Readout for Mode Settings and Available Security Levels</i>	22
5	<i>Typical Subpanel Layout</i>	25
6	<i>Typical Cabinet Dryer Electrical Schematic, Drawings 1 and 2</i>	26-27
7	<i>Required Desiccant Amounts Per Bed</i>	41
8	<i>Setting List for Process Temperature Controller, Part No. A0548565</i>	43
9	<i>Setting List for Dew Point Controller, Part No. A0548565</i>	46

Chapter 1: Safety

1-1 How to Use This Manual

Use this manual as a guide and reference for installing, operating, and maintaining the large dehumidifying dryer. The purpose is to assist you in applying efficient, proven techniques that enhance equipment productivity.

This manual covers only light corrective maintenance. No other maintenance should be undertaken without first contacting a service engineer.

The General Information section outlines models covered, standard features, and safety features. Additional sections within the manual provide instructions for installation, pre-operational procedures, operation, preventive maintenance, and corrective maintenance.

The Installation chapter includes required data for receiving, unpacking, inspecting, and setup of the large dehumidifying dryer. We can also provide the assistance of a factory-trained technician to help train your operator(s) for a nominal charge. This section includes instructions, checks, and adjustments that should be followed before commencing with operation of the dryer. These instructions are intended to supplement standard shop procedures performed at shift, daily, and weekly intervals.

The Controls and Operations chapters include a description of electrical and mechanical controls, in addition to information for operating the dryer safely and efficiently.

The Maintenance chapter is intended to serve as a source of detailed assembly and disassembly instructions for those areas of the equipment requiring service. Preventive maintenance sections are included to ensure that the dehumidifying dryer provides excellent, long service.

The Troubleshooting chapter serves as a guide for identification of most common problems. Potential problems are listed, along with possible causes and related solutions.

The Appendix contains technical specifications, drawings, schematics, parts lists, and available options. A spare parts list with part numbers specific to your machine is provided with your shipping paperwork package. Refer to this section for a listing of spare parts for purchase. Have your serial number and model number ready when ordering.

Safety Symbols Used in this Manual







The following safety alert symbols are used to alert you to potential personal injury hazards. Obey all safety messages that follow these symbols to avoid possible injury or death.

DANGER! DANGER indicates an imminently hazardous situation that, if not avoided, will result in death or serious injury.

WARNING! WARNING indicates a potentially hazardous situation or practice that, if not avoided, could result in death or serious injury.

Caution! CAUTION indicates a potentially hazardous situation or practice that, if not avoided, may result in minor or moderate injury or in property damage.

Dryer Safety Tags

Tag	Description	Tag	Description
	Read Operation & Installation Manual		High Voltage Inside Enclosure
	Hot!		Lifting Point
	Protected Earth Ground		Earth Ground

1-2 Warnings and Precautions

Our equipment is designed to provide safe and reliable operation when installed and operated within design specifications, following national and local safety codes. This may include, but is not limited to OSHA, NEC, CSA, SPI, and any other local, national and international regulations.

To avoid possible personal injury or equipment damage when installing, operating, or maintaining this equipment, use good judgment and follow these safe practices:

- Read and follow these operation and installation instructions when installing, operating, and maintaining this equipment. If these instructions become damaged or unreadable, additional copies are available from the manufacturer.**
- Follow all **SAFETY CODES**.
- Wear **SAFETY GLASSES** and **WORK GLOVES**.
- Work only with approved tools and devices.
- Disconnect and/or lock out power before servicing or maintaining the equipment.
- Use care when **LOADING, UNLOADING, RIGGING, or MOVING** this equipment.
- Operate this equipment within design specifications.
- OPEN, TAG, and LOCK ALL DISCONNECTS** before working on equipment. You should remove the fuses and carry them with you.
- Make sure the equipment and components are properly **GROUND** before you switch on power.
- When welding or brazing in or around this equipment, make sure **VENTILATION is ADEQUATE. PROTECT** adjacent materials from flame or sparks by shielding with sheet metal. An approved **FIRE EXTINGUISHER** should be nearby and ready for use if needed.
- Do not restore power until you remove all tools, test equipment, etc., and the equipment and related components are fully reassembled.
- Only **PROPERLY TRAINED** personnel familiar with the information in this manual should work on this equipment.

We have long recognized the importance of safety and have designed and manufactured our equipment with operator safety as a prime consideration. We expect you, as a user, to abide by the foregoing recommendations in order to make operator safety a reality.

1-3 Responsibility

These machines are constructed for maximum operator safety when used under standard operating conditions and when recommended instructions are followed in the maintenance and operation of the machine.

All personnel engaged in the use of the machines should become familiar with their operation as described in this manual.

Proper operation of the machine promotes safety for the operator and all workers in its vicinity.

Each individual must take responsibility for observing the prescribed safety rules as outlined. All warning and danger signs must be observed and obeyed. All actual or potential danger areas must be reported to your immediate supervisor.

General Responsibility

No matter who you are, safety is important. Owners, operators and maintenance personnel must realize that every day, safety is a vital part of their jobs.

If your main concern is loss of productivity, remember that production is always affected in a negative way following an accident. The following are some of the ways that accidents can affect your production:

- Loss of a skilled operator (temporarily or permanently)
- Breakdown of shop morale
- Costly damage to equipment
- Downtime

An effective safety program is responsible and economically sound.

Organize a safety committee or group, and hold regular meetings. Promote this group from the management level. Through this group, the safety program can be continually reviewed, maintained, and improved. Keep minutes or a record of the meetings.

Hold daily equipment inspections in addition to regular maintenance checks. You will keep your equipment safe for production and exhibit your commitment to safety.

Please read and use this manual as a guide to equipment safety. This manual contains safety warnings throughout, specific to each function and point of operation.

Operator Responsibility

The operator's responsibility does not end with efficient production. The operator usually has the most daily contact with the equipment and intimately knows its capabilities and limitations.

Plant and personnel safety is sometimes forgotten in the desire to meet incentive rates, or through a casual attitude toward machinery formed over a period of months or years. Your employer probably has established a set of safety rules in your workplace. Those rules, this manual, or any other safety information will not keep you from being injured while operating your equipment.

Learn and always use safe operation. Cooperate with co-workers to promote safe practices. Immediately report any potentially dangerous situation to your supervisor.

- **NEVER** place your hands or any part of your body in any dangerous location.
- **NEVER** operate, service, or adjust the dryer without appropriate training and first reading and understanding this manual.
- **NEVER** try to pull material out of the dryer with your hands while it is running!
- Before you start the dehumidifying dryer, check the following:
 - Remove all tools from the dryer;
 - Be sure no objects (tools, nuts, bolts, clamps, bars) are laying in the area;
- If your dryer has been inoperative or unattended, check all settings before starting.
- At the beginning of your shift and after breaks, verify that the controls and other auxiliary equipment are functioning properly.
- Keep all safety guards in place and in good repair. **NEVER** attempt to bypass, modify, or remove safety guards. Such alteration is not only unsafe, but will void the warranty on your equipment.
- When changing control settings to perform a different mode of operation, be sure selector switches are correctly positioned. Locking selector switches should only be adjusted by authorized personnel and the keys removed after setting.
- Report the following occurrences **IMMEDIATELY**:
 - unsafe operation or condition
 - unusual dryer action
 - leakage
 - improper maintenance
 - **NEVER** stand or sit where you could slip or stumble into the dehumidifying dryer while working on it.
- **DO NOT** wear loose clothing or jewelry, which can be caught while working on the dryer. In addition, cover or tie back long hair.
- Clean the dehumidifying dryer and surrounding area **DAILY**, and inspect the machine for loose, missing or broken parts.
- Shut off power to the dryer when it is not in use. Turn the switch to the **OFF** position, or unplug it from the power source.

Maintenance Responsibility

Proper maintenance is essential to safety. If you are a maintenance worker, you must make safety a priority to effectively repair and maintain equipment.

Before removing, adjusting, or replacing parts on a machine, remember to turn off all electric supplies and all accessory equipment at the machine, and disconnect and lockout electrical and pneumatic power. Attach warning tags to the disconnect switch and air shutoff valve.

When you need to perform maintenance or repair work on a dehumidifying dryer above floor level, use a solid platform or a hydraulic elevator. If there is a permanently installed catwalk on your dryer, use it. The work platform should have secure footing and a place for tools and parts. **DO NOT** climb on the dehumidifying dryer, machines, or work from ladders.

If you need to repair a large component, use appropriate handling equipment. Before you use handling equipment (portable “A” frames, electric boom trucks, fork trucks, overhead cranes) be sure the load does not exceed the capacity of the handling equipment or cause it to become unstable.

Carefully test the condition of lifting cables, chains, ropes, slings, and hooks before using them to lift a load.

Be sure that all non-current carrying parts are correctly connected to earth ground with an electrical conductor that complies with current codes. Install in accordance with national and local codes.

When you have completed the repair or maintenance procedure, check your work and remove your tools, rigging, and handling equipment.

Do not restore power to the dehumidifying dryer until all persons are clear of the area. **DO NOT** start and run the dryer until you are sure all parts are functioning correctly.

BEFORE you turn the dehumidifying dryer over to the operator for production, verify all enclosure panels, guards and safety devices are in place and functioning properly.

Reporting a Safety Defect

If you believe that your equipment has a defect that could cause injury, you should immediately discontinue its use and inform the manufacturer.

The principle factors that can result in injury are failure to follow proper operating procedures (i.e. lockout/tagout), or failure to maintain a clean and safe working environment.

Chapter 2: General Information

2-1 Models Covered

This manual provides instructions for installing and operating 90, 100, 150, and 225 CFM cabinet-style dehumidifying dryers.

2-2 Equipment Function

Our dehumidifying dryers are designed to generate heated, dehumidified air at carefully controlled temperatures for use in closed-loop plastic drying systems. Moisture removal from hygroscopic (moisture attracting) plastic pellets is an essential step in the manufacture of high-quality plastic products. Our dehumidifying dryers are used to generate very low dew point air heated to a controlled temperature for drying plastic pellets and regrind.

2-3 Necessary Documents

The documents listed below are necessary for the operation, installation, and maintenance of Cabinet Series dehumidifying dryers. You can obtain additional copies from the manufacturer. **Make sure that the appropriate personnel are familiar with these documents:**

- This manual.
- The schematic and assembly drawings included in the customer information packet.
- The Customer Parts List included in the information packet.
- Operation and installation manuals for any optional controls or auxiliary equipment in the drying system.

2-4 Standard Features

- Rugged compact frame with handle and sturdy 4" (10 cm) casters.
- Dual blower dryer with dual desiccant beds and 4-way compressed air operated valves.
- Up to 400°F (204°C) drying temperature range.
- Cartridge type (two stage) air filters for all blowers.
- Integral Control Center for dryer options.
- Electrical disconnect with all wiring to a common terminal point.
- PLC microprocessor control of the drying and conveying stations.
- Digital Dew Point monitor indicates dryer efficiency.
- Sequence shutdown of the dryer.

2-5 Options

Options can tailor your dehumidifying dryer system to meet the exact requirements of the drying task being performed.

- 13X desiccant.
- Aftercoolers for high and low temperature applications.
- Seven-day timer to allow programmable dryer startup.

- ☑ Audible/visual critical alarm.
- ☑ Fusing for blowers and heaters.
- ☑ Dirty Filter indicator for each individual blower.

2-6 The Closed Loop Drying System

Dehumidifying dryers force hot, dry air through the resin in the drying hopper where the air picks up moisture from the material and is drawn back to the dryer.

In the dryer, a desiccant bed strips moisture from the air. The dryer then re-heats dried process air, and sends it back into the drying hopper to dry material again.

This system is a closed loop, because ambient (outside) air is never introduced into the process air. See Figure 2. Our dehumidifying dryers use the closed loop system, because the process air is typically much drier than ambient air, even after carrying moisture out of the plastic resin. Recycling process air maintains drying efficiency at a consistently high level.

Figure 1-Dryer Air Flow Diagram

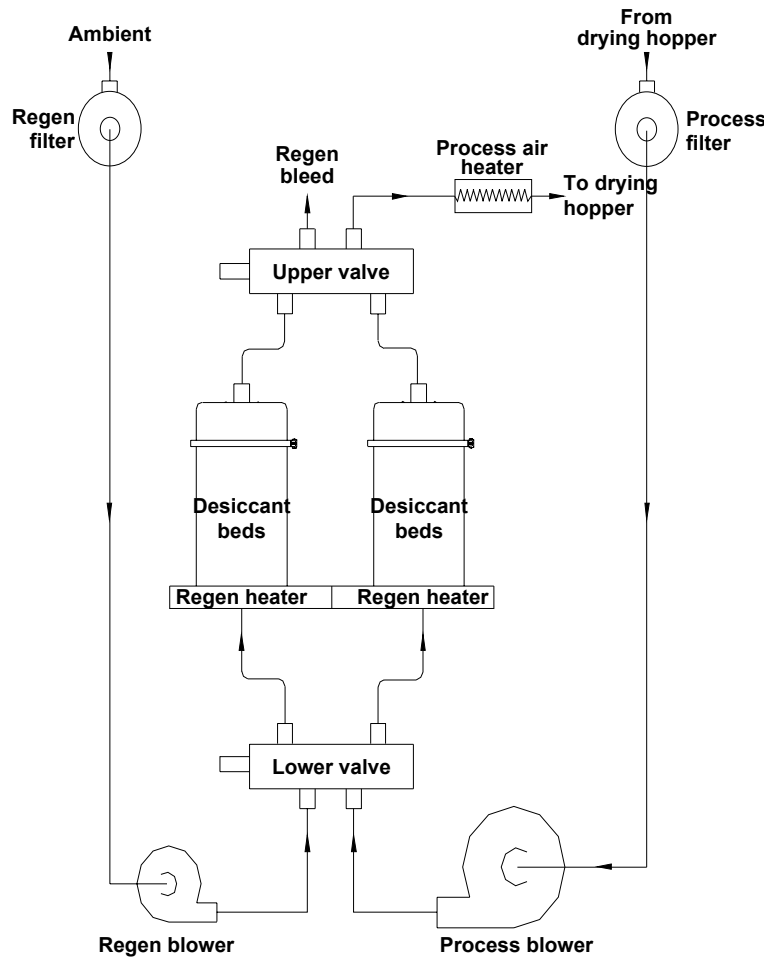

2-7 What is Desiccant?

Desiccant is a material which attracts and holds (absorbs) water from the air. Our dehumidifying dryers use a synthetic crystalline metal aluminosilicate desiccant blended with a clay binder and formed beads.

Absorbed water is driven from saturated desiccant by heating it to a high temperature (reducing desiccant capacity to hold water) and forcing air through it. This moisture removal process is called *regeneration*.

2-8 The Process/Regeneration Cycle

Our dehumidifying dryers have two desiccant beds. While one bed is on-line in the process air loop, the other is off-line being regenerated.

When a desiccant bed is on-line, it absorbs moisture from the process air. In time, the bed becomes saturated with moisture and needs to be regenerated. The dryer automatically redirects the process airflow to the second bed and starts the regeneration cycle on the first bed.

During regeneration, the dryer heats air to over 500°F (260°C) and forces it through the desiccant bed. Moisture driven off the bed bleeds to the atmosphere.

If you measure the temperature of the air bled to the atmosphere (bleed temperature), you should observe a rise after a period of time. This condition, *bed breakthrough*, indicates that the bed is dry. At bed breakthrough, the bleed air temperature peaks between 350°F (176°C) and 400°F (204°C).

The Dew Point meter measures the dew point of the process air. A properly regenerated bed produces process air dew point of -40°F (-40°C). This ultra-low humidity level is more than adequate to dry plastics to as little as .003% moisture, depending on the process and material.

2-9 Specifying a Drying/Conveying System

Many variables were considered in the selection of your drying system, including type of materials, residence time, throughput of the extruder or injection molding machine, ambient air moisture and temperature, and the altitude at the processing site. If your operating environment changes, the manufacturer can advise you on necessary equipment and process time and temperature modifications required for your system.

Chapter 3: Installation

3-1 Positioning Your Dryer

The dehumidifying dryer system was designed to be wheeled into place. The entire assembly is mounted on a rugged, compact frame and is equipped with sturdy, 4" (10 cm) heavy-duty casters, two locking and two swivel.

Caution! Use caution and observe safety rules when placing your dryer!

3-2 Making Electrical Connections

- ☑ Fulfill all national, state, and local safety and electrical code requirements.
- ☑ Connections should be made by a qualified electrician.
- ☑ Make sure all electrical connections are tight.
- ☑ Connect main power to the dryer at the disconnect or terminals in the upper right corner of the control enclosure.
- ☑ Install a fused disconnect with a lockout feature in the power main leading to the dryer.
- ☑ The power drop must include a ground wire.

WARNING! Proper grounding of the main power line is critical!

3-3 Connecting Compressed Air

Connect compressed air to the dryer before operation.

Caution! Excessive air pressure damages the neoprene components of the air distribution valve.

Connect the air supply, using a 1/4" NPT fitting, to a clean, dry, lightly lubricated source of 80 psi (551 kPa/5.51 bars) compressed air. A pressure gauge and regulator are recommended components of your plant air supply.

The compressed air indicator switch prevents the dryer from starting without an 80 psi (551 kPa/5.51 bars) air supply. If the air supply drops to below 60 psi (413 kPa/ 4.13bars) during operation, the dryer shuts down until at least 80 psi (551 kPa/5.51 bars) is restored.

3-4 Checking for Proper Blower Rotation

Three-Phase Models

The blower rotates properly when air flows from the delivery outlet and a vacuum is felt on the blower inlet.

Caution! In three-phase models, incorrect phasing of power leads can cause backward rotation of blower motors and **CONTAMINATION OF THE DESICCANT!** Always check blower rotation before putting material in the drying hopper!

If the three-phase blower rotates improperly, reverse any two wires at the fused disconnect outside the dryer or at the disconnect/terminal in the control enclosure. This assures that the blower rotates in the proper direction.

3-5 Process Air Connections Between the Dryer and Drying Hopper

- ☑ Remove the cap plugs from the inlet, discharge and bleed tubes before operation.
- ☑ Use high-temperature flexible dryer hose to connect the dryer to the drying hopper.
- ☑ Keep the delivery hose as short as possible to minimize heat loss. Insulated dryer hose is available for maximum energy savings.
- ☑ Do not shorten the return hose.
- ☑ Make sure the hoses are not kinked.
- ☑ Drying hopper air inlet and outlet locations vary from one drying hopper model to another, but always connect the hoses so the dry process air from the dryer enters the bottom of the drying hopper and flows out the top to return to the dryer inlet.

3-6 Connecting Cooling Water to the Optional Aftercooler

High temperature applications (300°F to 400°F / 148°C to 204°C) require aftercoolers to cool moist air returning to the dryer from the drying hopper. An aftercooler cools the return air by 100°F (38°C); this maintains dryer efficiency and condenses unwanted plasticizers from the airstream. Aftercoolers are also required in extremely low temperature applications.

Installing Water Lines

- Use the ½" (about 13 mm) brass pipe nipples for water line connections. Inlet and outlet line positions do not matter.
- Make sure you grip the nipple tightly when attaching a fitting. Doing so prevents damage to the soft copper coils. You should make connections with flexible hose to allow removing the coil assembly for cleaning.
- The aftercooler is designed to utilize either tower or city water as warm as 85°F (29°C). Recommended flow rate is one to three (1 to 3) gallons per minute (4 to 11 liters per minute).

3-7 Drying Hopper

Removing the Rust Inhibitor

Rust preventative has been applied to internal unfinished surfaces. **Remove rust inhibitor before** using the drying hopper.

Using a non-water based degreasing agent, clean all inside surfaces of the drying hopper. Allow components to dry **thoroughly**.

Inspect the inside of the drying hopper for loose connections, foreign objects, or a blocked diffuser.

Air Trap Considerations

The air trap assembly in the top of the drying hopper prevents ambient air from contaminating the material being dried.

- ☑ Keep the material level at the mid point of the air trap for maximum efficiency.
- ☑ Use a hopper loader or vacuum conveying system to maintain the proper material level.

Chapter 4: Controls

4-1 Control Panel Indicator Lights and Switches

Rocker Switches

System ON/OFF Rocker Switch

Used to de-energize control power to the indicator panel, allowing separate control of the dryer and conveying systems.







Dryer ON/Sequence Shutdown Rocker Switch

Used to start the dryer. Move this switch to the Sequence Shutdown position to turn off the process heaters, finish the regeneration cycle and then turn off the dryer.

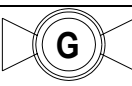
Optional Alarm Silence Rocker Switch

Press the **Alarm Silence** switch to silence the horn when a high temperature alarm activates. The alarm repeats every five minutes until the problem causing the alarm condition is cleared.

Indicating Lights

Indicator	Name	Description
	Regen Blower On Light	The Regen Blower On indicator lights when the regeneration blower energizes.
	Left Bed In Regen Light	The Left Bed In Regen LED lights when the left bed is in regeneration.
	Left Bed Heater Light	The Left Bed Heater indicator lights when the left bed regenerates and is in the heat-up portion of the regeneration cycle.
	Right Bed In Regen Light	The Right Bed In Regen LED lights when the right bed is in regeneration.
	Right Bed Heater Light	The Right Bed Heater indicator lights when the right bed regenerates and is in the heat-up portion of the regeneration cycle.
	Process Blower On Light	The Process Blower On indicator lights when the process blower energizes.
	Process Heater On Light	The Process Heater On indicator lights when the process air heater is energized.
	Low Compressed Air Light	The Low Compressed Air alarm indicator lights when the dryer compressed air supply drops below 60 psi (413kPa/ 4.13 bars). Upon loss of





Indicator	Name	Description
		compressed air, the pressure switch opens and sends a signal to the PLC controller to shut down dryer operation. Dryer operation automatically resumes when 80 psi (551 kPa/ 5.51 bars) air is restored.
	High Temp Process Air Light	<p>The High Temp Process Air alarm indicator lights when the temperature at the process air thermocouple is above the high alarm set value. Upon high temperature alarm condition the process heaters turn off, the process blower remain on.</p> <p>The alarm mode and value are factory-set to track 25° above the process set point. The alarm value is an upper-limit deviation above the process set point. When the temperature at the process thermocouple returns to within the acceptable range, the alarm output de-energizes and all heaters turn on again automatically.</p>
	High Temp Regen Air Light	<p>The High Temperature Regen Air alarm indicator lights when the thermostat above the regeneration heater assembly senses an abnormally high temperature.</p> <p>The regeneration heaters shut down until the temperature falls below the alarm point. The regeneration blower continues to run for cooling the heaters and desiccant bed. The alarm condition clears when the temperature drops below the thermostat setpoint. The heaters re-energize automatically.</p>
	High Dew Point Light	The High Dew Point alarm indicator lights when the process air delivery dew point exceeds a dew point of -10°F (-23°C).
	Material Loading Light	The Material Loading indicator lights when material is being conveyed.
	Optional Dirty Filter Light	If installed, the Dirty Filter alarm indicator lights when the pressure differential across the process, regeneration and conveying air return filter exceeds the pressure switch setting. Service the filter when this indicator lights. The indicator and the alarm condition clears after you service and reinstall the filter.

Figure 2-Typical Dyer Interface Panel



4-2 Process Air Dew Point Display

The Dew Point display indicates the current process air delivery moisture content. The display uses a microprocessor-based controller for reading dew point air temperature. The controller is a modular, self-contained removable unit in the mounting housing. All parameters are factory-set and adjusted; no field adjustment to the internal controls is necessary. The high dew point alarm is also factory adjusted.

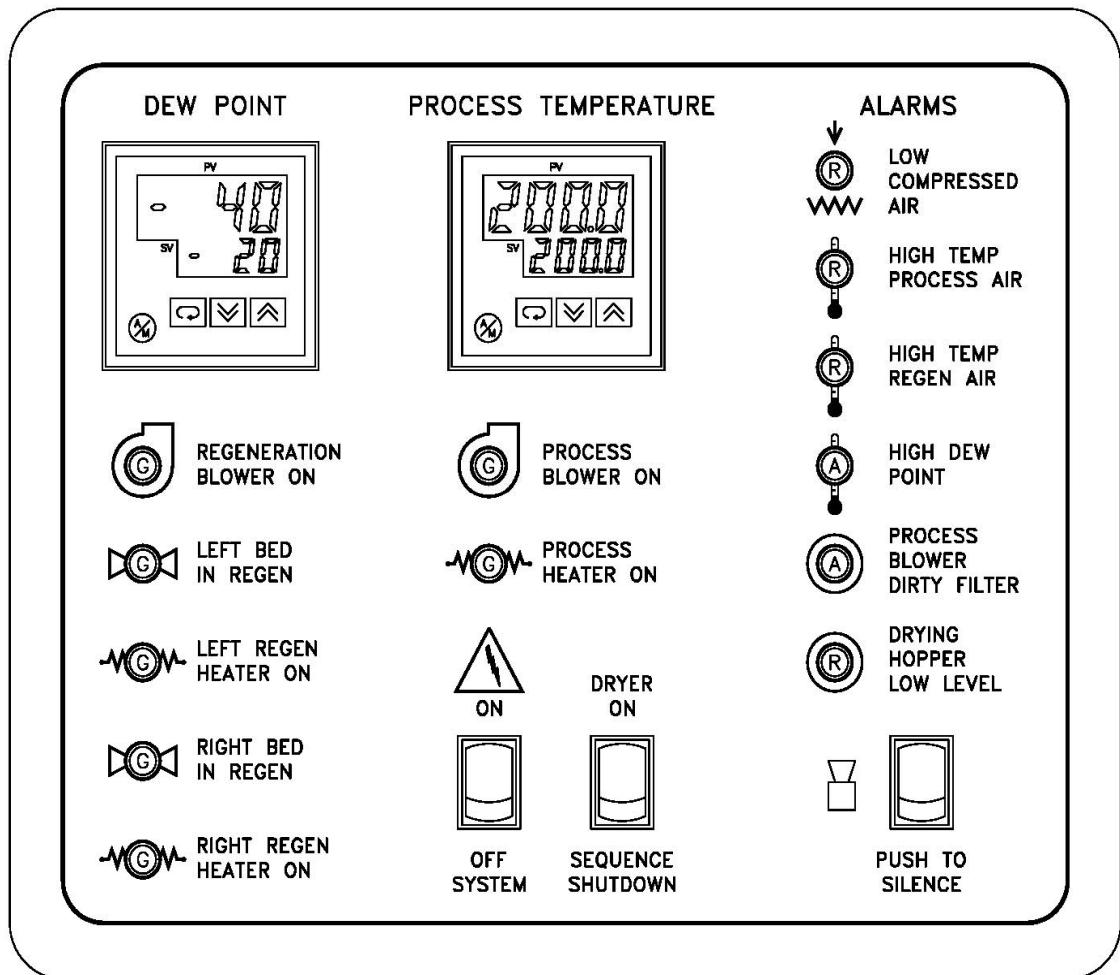
4-3 Process Air Temperature Controller

Our dehumidifying dryers use a microprocessor-based PID temperature controller for maintaining process air temperature. The controller is a modular, self-contained unit you can remove from the mounting housing. All parameters except for the process air set point is factory set and adjusted; no field adjustment to the internal controls is necessary.

4-4 Identifying Temperature Controller LED Indicators

LED Indicator	Description
Process Value Numerical LED	During normal operation, the process value (PV) numeric LED indicator displays the process temperature at the To Process thermocouple. It also lists parameters during setup and error messages if any errors occur.
Set Value Numeric LED	During normal operation, the set value (SV) numeric LED indicator displays the process set point you selected for the dryer. The dryer then maintains this set point temperature. This LED indicator also displays parameter and pre-set function values during setup.
OUT1	Lit when control output 1 turns on. The Out indicator lights when the controller signals the process heaters to be energized.
OUT2	Lit when control output 2 turns on. Not used in this application.
MANU	Lit when the manual operation mode is being used.
STOP	Lit when control operation has been stopped. Not used in this application.
RMT	Lit during remote operation. Not used in this application.
AT	Flashes during auto-tuning.
SUB1	Lit when the output function assigned to auxiliary output 1 turns on.

4-5 Identifying Temperature Controller Buttons



Display Button

This button shifts the display to the next set of parameters. Then, the menu screen displays.



Down Arrow Button

The Down Arrow button lets you lower the process air set point temperature. During setup, it lets you decrease the value of the parameter displayed on the set point LED readout.



Up Arrow Button

The Up Arrow button lets you raise the process air set point temperature. During setup, it lets you increase the value of the parameter displayed on the set point LED readout.



Auto-Tune Button

Hold down for two seconds to initiate auto-tune. Repeat to cancel.

Figure 3:

Typical Dryer Temperature Controller

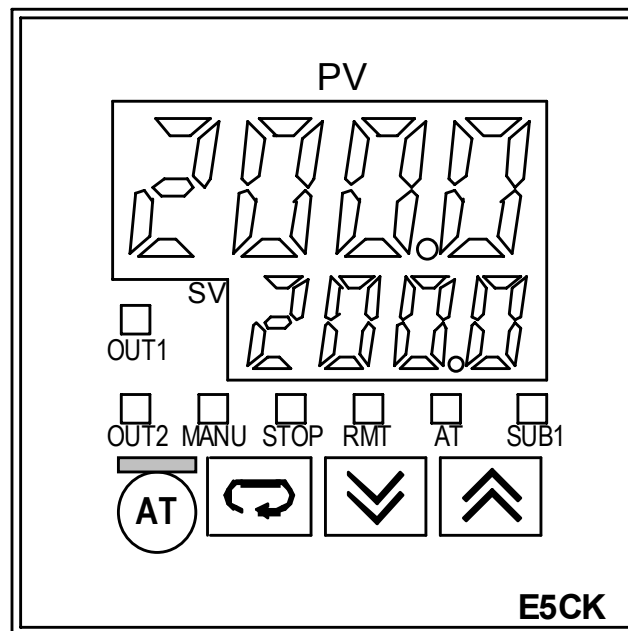

E5CK Operating Parameters

The E5CK has several mode selections. Within each mode are numerous parameters that can be set. The setting is different for the temperature control unit and the dew point display.

Before you can access the several modes of operating parameters, you must change the security lock-out of the controller. The factory sets the security level to protect the parameters from being accidentally changed. Below is an explanation of the operating modes, how to change out the security level and the factory default settings.

Available E5CK Modes

Menu Display

Level 0 Mode

For normal operation. Execute AT auto-tuning, change to manual mode.

Level 1 Mode

For adjusting primary control parameters. Execute: Set alarm values; set the control period; set PID parameters.

Level 2 Mode

For adjusting secondary control parameters. The dehumidifying dryer uses E5CK default settings.

Setup Mode

For setting the basic specifications. Set parameters for input type, scaling, output assignments and direct/reverse operation.

Expansion Mode

For setting expanded functions. Set: ST (self-tuning), SP setting limiter. Select: advance PID or **ON/OFF** control.

Option Mode

This mode is only accessible when an option board is installed.

Calibration Mode

For calibrating communication unit E53-CKF. Not used.

Manual Mode

Sets the controller to manual operation mode. Not used on dehumidifying dryers.

Figure 4:

Display Readout for Mode Settings

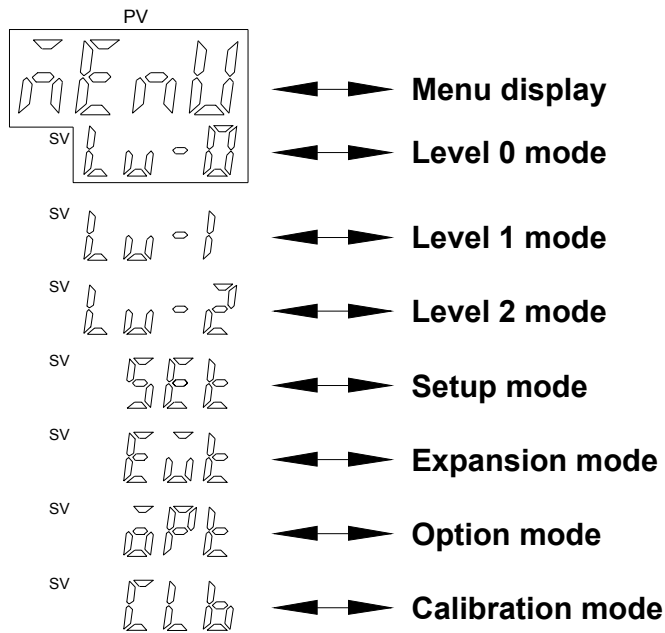

4-6 Setting the Process Air Temperature

To change the process air temperature set point with the dryer running:

- Press the Up Arrow button to increase the set point to the temperature you want.
- Press the Down Arrow button to lower the set point to the temperature you want.
- Press the Auto-tune button to initiate auto-tuning.

4-7 PLC Controller

The PLC controller uses an Allen-Bradley programmable logic controller (PLC). This “brick”-type controller has 32 I/O points: twenty (20) inputs and twelve (12) outputs, all inputs and outputs are 115 VAC.

All programming and logic is factory-installed on an EEPROM chip and cannot be modified. A battery backup retains programming if power fails. Battery life is five (5) years at room temperature.

If the alarm indicator blinks intermittently, replace the battery within one week.

PLC LED Indicators

The following indicators are located inside the dryer cabinet. See Figures 5, 6, and 7.

Name	Description
System Start/Sequence Shutdown (I/0)	When ON, activates the operation of the dryer portion.
Compressed Air Input (I/1)	When ON, confirms that compressed air is present.
Process Blower Enable (I/2)	When ON, Confirms the operation of the process blower.
Bed Switch Set Point Input (I/4)	When ON, indicates that dewpoint is above bed switching set point.
High Regen Temp Alarm, Right Bed (I/5)	When OFF, indicates a situation of a temperature exceeding the set level in the right regen bed.
High Regen Temp Alarm, Left Bed (I/6)	When OFF, indicates a situation of a temperature exceeding the set level in the right regen bed.
Compressed Air Alarm Input (I/7)	When ON, it indicates loss of compressed air.
High Process Temp Alarm (I/8)	When ON, sends the information to the PLC to be used later in forming alarm procedure.
Push To Silence (I/9) (Optional)	When the existing rocker switch is pressed, the audible horn will be silenced and flashing strobe will be turned off. Also, it serves as an alarm acknowledgment.

Output LED Indicators

Name	Description
Blower On (O/0)	The Blower On indicator lights when the blower energizes.
Process Heater Enable (O/2)	The Process Heater Enable activates the process heater. The indicator lights when the process heater is energized. This condition occurs when no blower failures or high temperature conditions exist.
Left/Right Regen Heater Output (O/3, O/4)	The Regen Heater Output indicator lights when the indicated bed regeneration heater energizes.
Right Bed Regeneration Output (O/5)	The right Bed Regeneration Output activates the right bed regeneration indicator lights when the right bed regenerates. When this indicator is off, the left bed is energized.
High Regen Temp Alarm (O/6)	When ON, indicates a high regen temp condition in either the left or right bed.
Alarm Horn Output (O/7) <i>Optional</i>	The Alarm Horn Strobe Output indicates a high process temperature condition and optional critical low level at the drying hopper.

Status LED Indicators

Name	Description
Power	The Power indicator lights when the PLC receives 115V control power.
Run	The Run indicator lights when the PLC executes the program in normal conditions.
Fault	The Fault indicator lights when the PLC program has a problem or failure condition.
Force	The Force indicator is not used.

Figure 5:
Typical Subpanel Layout

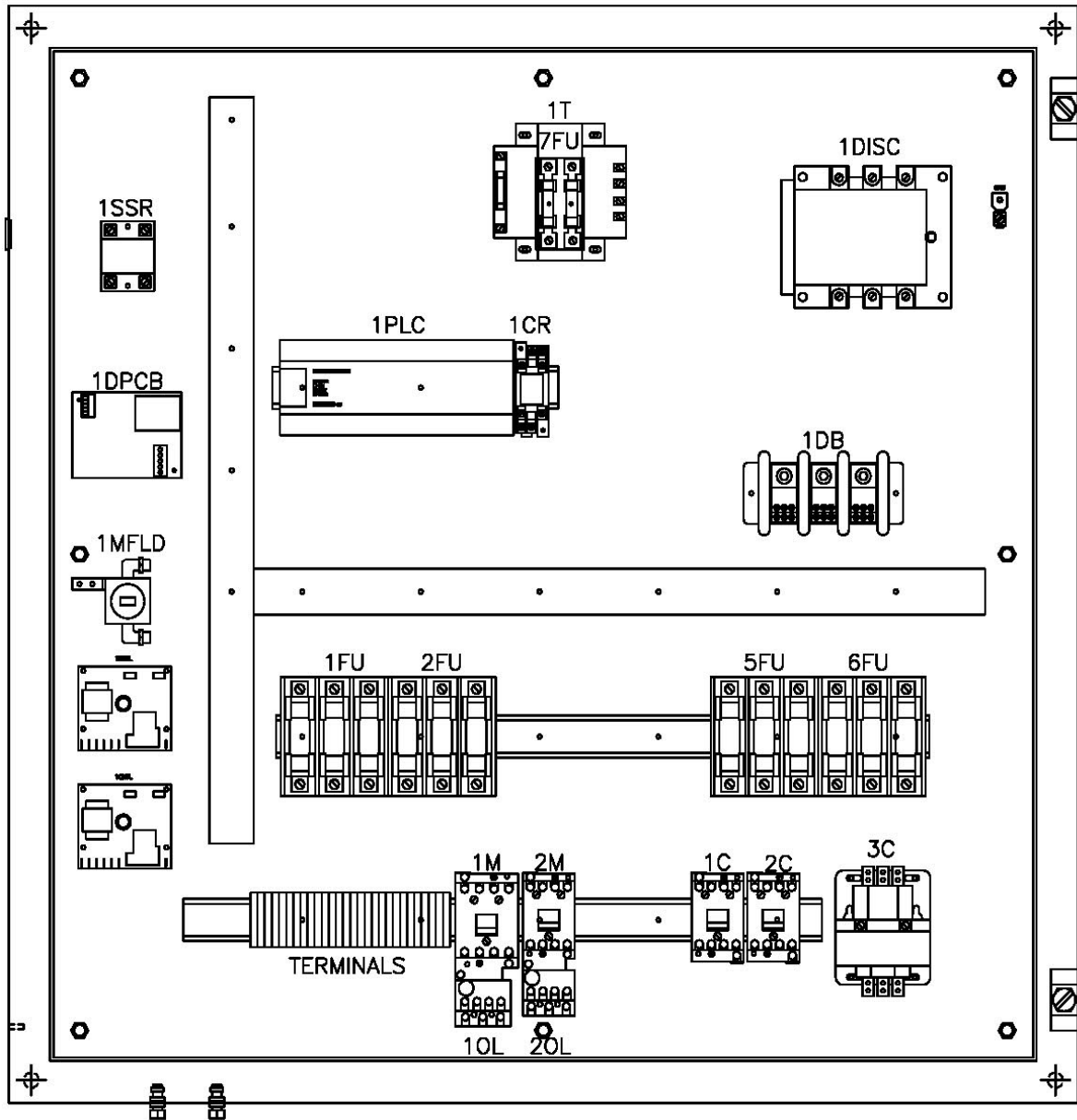

Figure 6:
Typical Cabinet Dryer Electrical Schematic, Drawing 1

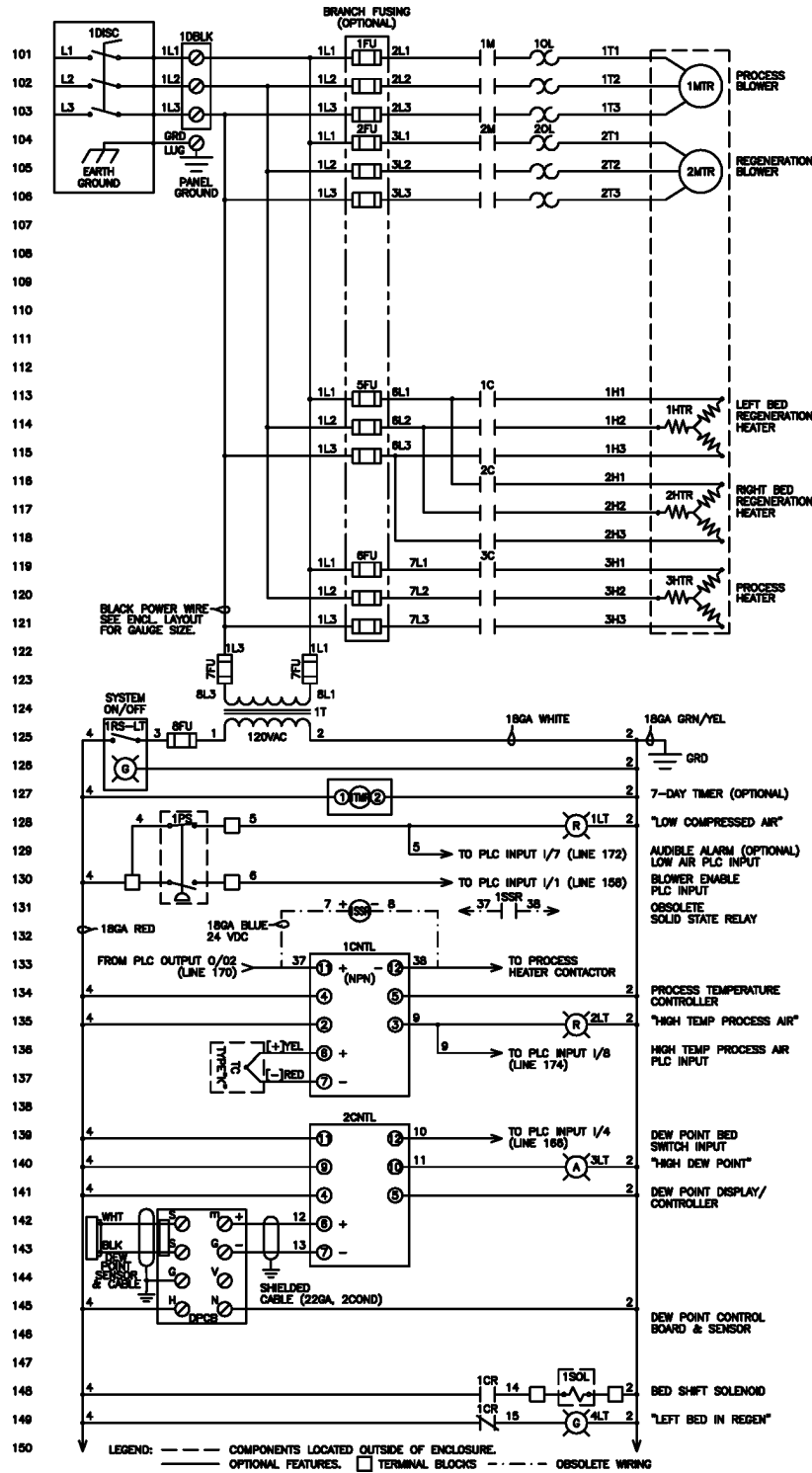
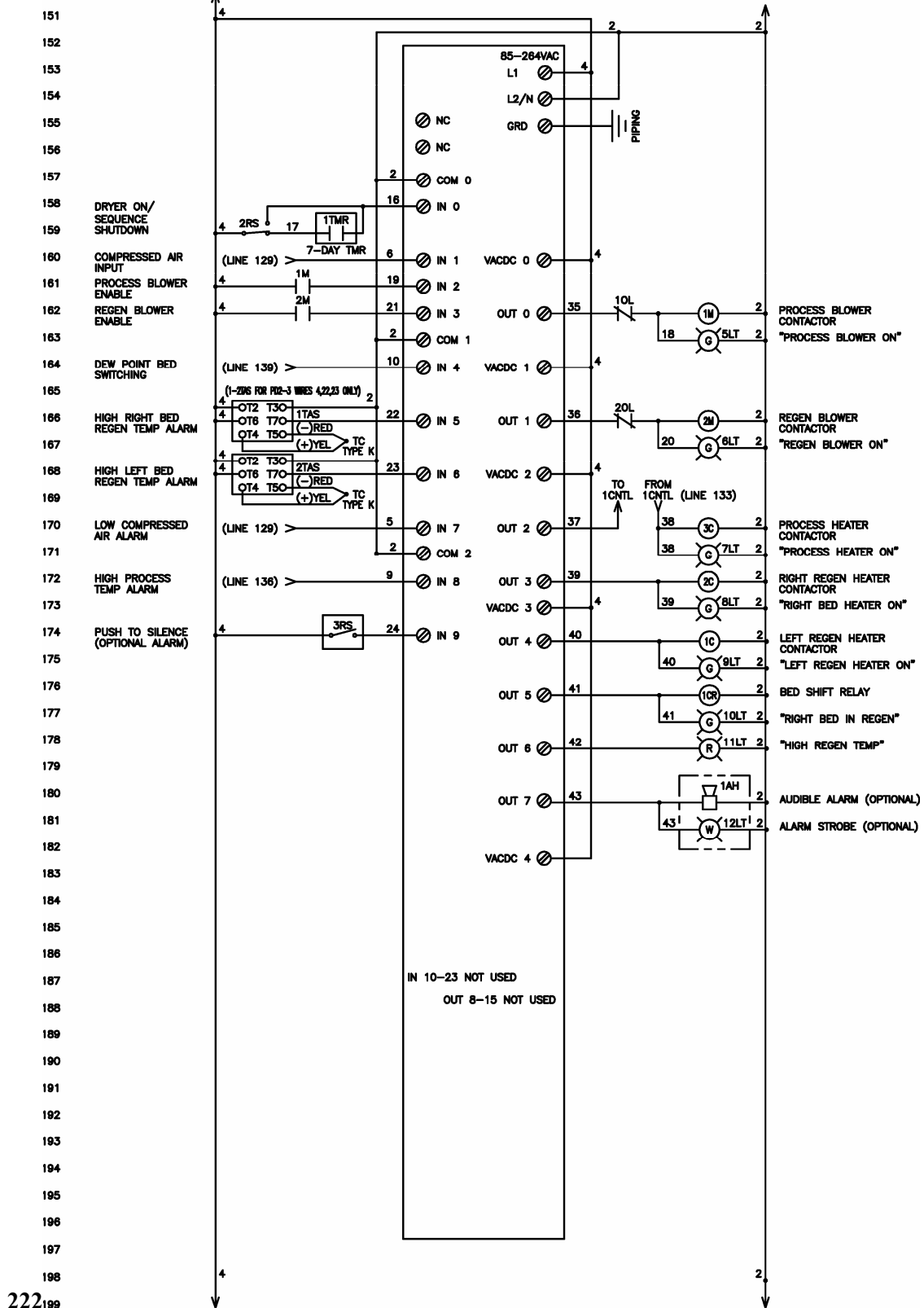

Figure 6:
Typical Cabinet Dryer Electrical Schematic, Drawing 2



4-8 Setting the Shift on Dew Point

Our dehumidifying dryers shift air flow from the on-line desiccant bed to the regenerated desiccant bed, based on actual dew point demand, not fixed time cycles. After the off-line bed regenerates, the PLC controller waits for a high dew point signal from the process air dew point controller before switching beds. The PLC controller has a four (4) -hour timer override if it does not receive a signal from the dew point control.

- Set the shift on dew point set point to the highest process air moisture content you want to allow before the dryer shifts air flow to the regenerated desiccant bed. The dew point controller is set at the factory for -20°F (-29°C).
- To change the dew point setting, press the Up Arrow and Down Arrow buttons to the shift point you want.

4-9 Entering Operating Parameters to Select Modes

To enter the menu display:

1. Press the Display button for one second (keep the pressure on the button for about 1.5 to 2 seconds).

The screen displays .

2. Press the Up Arrow button to toggle through the different modes.
The **SV** readout displays the mode you selected.
3. To switch parameters within a mode, press the Display button once more for about one and a half to two (1.5 to 2) seconds.
The **PV** readout displays the different parameters within each mode.
4. Use short presses on the Display button to display each parameter within a mode.
The **SV** readout displays the different values for the parameter within a mode.
5. Press Up Arrow and Down Arrow buttons to set the higher or lower the values of a parameter.
6. Press Display button for about one and a half to two (1.5 to 2) seconds to move up a level back into the different modes.
7. Press Down Arrow button until Level 0 displays. Press the Display button for about one to one and a half (1 to 1.5) seconds to go to Operating mode.

4-10 Setting the High Dew Point Alarm

The high dew point alarm is factory set for -10°F (-23°C). The high dew point alarm will energize the “High Dew Point” light. Entering the Level 1 operating parameter changes the high dew point alarm setting. Use the following procedure to set the high dew point alarm:

1. Press and hold the Display button to access Level 0. The controller displays Level 0.
2. Press Up Arrow button to display Level 1. Lu-1 displays.
3. Press the Display button to select Level 1.
4. Press the Display button until the controller displays AL-1.

5. Use the Up and Down Arrow buttons to set the higher or lower value for the high dew point alarm. Hold the Display button to save the value and return to Level One.
6. Press the Down Arrow button until the controller displays Level 0.
7. Press and hold the Display button to return to Operating mode.

Note: *The E5CK controller has several levels of securities to lock out access to parameters and menu settings. If the controller will not allow you to change settings, see Section 6-8 on Page 60 to set the E5CK security to access the function you need.*

4-11 Optional Seven Day Timer

The seven-day timer can be programmed for daily or weekly (over midnight) on/off operation. An internal battery back up holds the settings in memory when the dryer is de-energized.

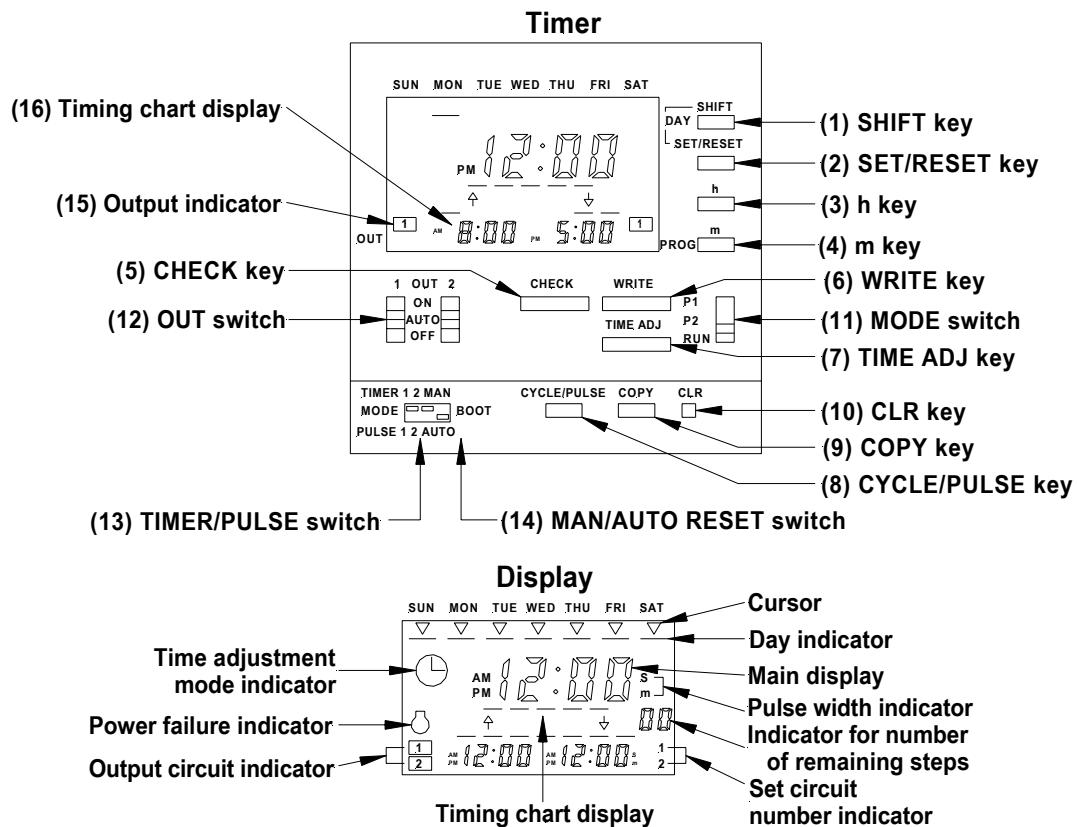

No.	Function
1	Shifts the cursor (▽) specifying a day to the right.
2	Sets or cancels (reset) a specified day.
3, 4	Sets a time or ON/OFF time width. (hours, minutes)
5	Monitors the parameters set for an operation during an operation.
6	Sets parameters. (Write)
7	Sets a time adjustment mode.
8	Specifies a cyclic operation, or sets a pulse width. (Not used)
9	Specifies a day substitution operation. (Copy)
10	Cancels the parameters set for each circuit, or a day substitution operation.
11	P1: Circuit 1 programming mode. P2: Circuit 2 programming mode. Run: Run mode.
12	ON: Turns on the output regardless of the program AUTO: Executes according to the program. OFF: Turns off the output regardless of the program.
13	TIMER: Executes an ordinary timer or cyclic operation. PULSE: Executes a pulse-output operation.
14	Specifies automatic or manual operation following a power failure.
15	The Output indicator will light when the timer output is energized. (Dryer On)
16	Displays the time at which the next operation will be preformed.

*Note: For timer operation, the **System Power** rocker switch must be in the **ON** position and the **Dryer/on Sequence Shutdown** rocker switch must be in the **SEQUENCE SHUTDOWN** position.*

- The **OUT** switch (#12) should be set to **AUTO**.
- The **P1-P2 RUN** mode switch (#11) should be set to **RUN** for normal 7-day timer operation, set to **P1** for changing times; **P2** is not used. Open the front cover; the **MODE** switch (#13) must have Mode 1 set to **TIMER** (up); **2** is not used, **BOOT** (#14) is set to **AUTO** (down).
- Program 1 is operational; Program 2 is **not used**.

*Note: To bypass the 7-day timer operation, turn the 7-day timer **OUT** switch (#12) to off. Turn the **Dryer/On Sequence Shutdown** rocker switch located on the dryer control panel to **DRYER ON**.*

Programming the Optional Timer

Setting the Current Day of the Week, Hour, and Minute

1. Apply main power to the dryer.
2. The 7-Day timer **MODE** selector switch (#11) should be in the **RUN** position.
3. Hold the **TIME ADJ** key (#7) for 1 second or longer.
4. Press the **SHIFT** key (#1) to move the cursor (▽) to the desired day position. Holding down this key advances the day.
5. Press the **SET** key (#2). The bar mark will turn on under the chosen day.
6. Press the **h** key (#3) to adjust the hours. Holding the key will rapidly advance the hour.
7. Press the **m** key (#4) to adjust the minutes.

8. Press the **WRITE** key (#6) to store the correct time.
9. The time and day can be adjusted or changed while the timer is operating.

Daily Timer Operation

Daily time is typically set to operate from 8:00 AM and to stop at 5:00 PM from Monday through Friday.

1. Set the **MODE** switch (#11) to **P1**.
2. Press the **SHIFT** key (#1) to move the cursor to the desired day of the week. Or select several days at once by using the **SHIFT** (#1) and **SET** keys (#2). The bar mark will turn on under the chosen days.
3. Press the **SET** key (#2).
4. Set the desired start time by pressing the **h** key (#3) to adjust the hour. Holding this key will rapidly advance the hour.
5. Press the **m** key (#4) to adjust the minutes.
6. Press the **WRITE** key (#6) to store the start time in the timer memory.
7. Next, set the stop time by using the **h** and **m** keys, then press **WRITE**.
8. Turn the **MODE** switch (#11) to run.

Multiple-Day Operation

Multiple day operation will start the dryer on one day and run continuously for several days before stopping the dryer.

1. Turn the **MODE** switch (#11) to **P1**.
2. Select the desired start day with the **SHIFT** (#1) and **SET** keys (#2).
3. Set the start time with the **h** and **m** keys.
4. Press the **WRITE** key (#6) to store the dryer startup hour in the timer memory.
5. Next cancel the day that was just set by using the **RESET** key (#2).
6. Now select the stop day by using the **SHIFT** (#1) and **SET** key (#2).
7. Set the stop time with the **h** and **m** keys.
8. Press the **WRITE** key (#6).
9. Turn the **MODE** switch (#11) to **RUN**.

Checking the Set Time

The set times can be checked in the sequence the timer is to operate.

1. Press the **CHECK** key (#5). Each time the key is pressed the operation schedule is displayed in the time sequence.
2. If the time switch is left untouched for 20 seconds during check, the display automatically returns to **RUN** mode.

If a holiday occurs during the weekly operation, the off time for Sunday can be executed for the holidays. The override will execute for one week only, then the timer will automatically go back to the previous program.

1. Hold the **COPY** key (#9) for one (1) second or longer. Make sure that the mode selector switch is in **RUN** mode.
2. Select the day(s) you want with the **SHIFT** (#1) and **SET** keys (#2). If a previous override had been set, this will show up when you first hold the **COPY** key. To clear a previous override, press the **CLR** key (#10).
3. Press the **WRITE** key (#6).
4. Select Sunday (or another shutdown day) with the **SHIFT** (#1) and **SET** keys (#2).
5. Press the **WRITE** key (#6).

Day Override

If a holiday occurs during the weekly operation, the off time for Sunday can be executed for the holidays. The override will execute for one week only, then the timer will automatically go back to the previous program.

1. Hold the **COPY** key (#9) for one (1) second or longer. Make sure that the mode selector switch is in **RUN** mode.
2. Select the day(s) you want with the **SHIFT** (#1) and **SET** keys (#2). If a previous override had been set, this will show up when you first hold the **COPY** key. To clear a previous override, press the **CLR** key (#10).
3. Press the **WRITE** key (#6).
4. Select Sunday (or another shutdown day) with the **SHIFT** (#1) and **SET** keys (#2).
5. Press the **WRITE** key (#6).

Canceling the Settings

All the operations can be cancelled.

1. Set **MODE** selector switch (#11) to **P1**.
2. Press the **CLR** key (#10).

Note: *The 7-day timer cycle and pulse output are not used for dryer applications.*

- Notes -

Chapter 5: Operation

5-1 Pre-Startup Checks

1. Verify that the drying hopper is clean of rust-prohibitive oil or any foreign objects.
2. Verify that process and return hose connections are tight.
3. If your dryer has a water-cooled aftercooler, make sure that sufficient cooling water flows properly through the coil and that you have bled any trapped air from the system. Make sure that the aftercooler has the proper supply water temperature.
4. Check all companion equipment, such as the sight glass loader and drying hopper loader; verify that all convey tubing is in place and the loading system is ready for operation.
5. Verify that all electrical connection are **tight** and the unit is properly grounded.
6. With main power on, turn the dryer on until the process blower starts, verify blower rotation.

Important! *Clean the rust-preventing oil from inside the drying hopper. Failure to clean the hopper fouls the desiccant and voids your warranty!*

5-2 Startup

1. Turn on (energize) the disconnect switch in your power drop.
2. Turn the system **ON/OFF** switch to **ON** to energize the display panel.
3. Close the slidegate at the bottom of the drying hopper.
4. On three-phase models, make sure that the blowers turn in the right direction.
5. Fill the drying hopper with material.
6. Turn the **DRYER ON/SEQUENCE SHUTDOWN** switch to **ON** to start the dryer.
7. The process blower will start.
8. Set the process set point on the temperature controller to the recommend drying temperature provided by the resin manufacturer. Press and hold the Auto-Tune key on the process temperature controller for two (2) seconds to initiate the auto-tune function.
9. After the proper pre-drying time for the initial hopper fill has elapsed, fully open the drying hopper slide gate.

Note: *To allow proper residence time during continuous processing, maintain the material level in the hopper at the midpoint of the air trap assembly.*

5-3 Shutdown

1. Turn off the conveying system supplying the drying hopper.
2. When processing is complete, close the hopper slide gate and shut down any in-line companion equipment, such as the aftercooler.
3. Turn the **dryer ON/OFF** selector switch to the **SEQUENCE SHUTDOWN** position. The sequence shutdown operation turns off process heaters and keeps the process blower on for

twenty minutes to cool down the process. The regeneration cycle of the off-line bed completes the cycle before the dryer shuts down completely.

4. To override the sequence shutdown turn the system **ON/OFF** switch to **OFF**.
5. To completely shut off the unit after sequence shutdown has completed, turn the system **ON/OFF** switch to **OFF**.
6. If needed, empty the drying hopper.
7. For maintenance or a long term shutdown, open (de-energize) the electrical disconnects at the dryer and at the power drop.

Chapter 6: Maintenance

6-1 Work Rules

The installation, operation, and maintenance of this equipment is to be conducted in accordance with all applicable work and safety codes for the installation location. This may include, but is not limited to, OSHA, NEC, CSA, and any other local, national, and international regulations.

In addition, you must observe the following specific work rules:

- Keep these operating instructions on hand and follow them when installing, operating, or maintaining your dryer.
- If these instructions become damaged or unreadable, you can obtain additional copies from the manufacturer.
- Only qualified personnel familiar with this equipment should work on or with this unit.
- Work only with approved tools and devices.

Disconnect power before servicing your dryer. If the disconnect switch you installed has a lockout, lock it in the **OFF** position before you perform any maintenance or service.

6-2 Servicing Process Air Filters

Important! *Operating the dryer without the process air filter installed voids your warranty! Filter cleaning is an important part of your dryer maintenance program.*

Our dehumidifying dryers have a single cartridge canister-type filter in the process and conveying air loop. The process filter is mounted above the process blower on the rear of the dryer. The conveying filters are located under the drying hopper next to the conveying blowers. These filters protect the blowers from plastic fines drawn in from the drying hopper. Regular filter cleaning is essential to keep your dryer operating at peak efficiency.

You can wash or blow out the filters, but remember, you reduce dirt holding capacity with each washing. The risk of dirt reaching the clean side of the filter during cleaning, plus possible filter damage from high pressure washing or blowing, makes washing a gamble.

You can carefully clean or wash the filter when airflow becomes restricted. Do **not** wash filters more than six (6) times or use them for more than a year, whichever comes first.

Use a detergent that won't damage filter media. Such a detergent permits easy removal of dirt particles through flushing and rinsing. An effective detergent removes the fine particles from the pores of the filter media.

The filter manufacturer recommends FM 1400 washing compound. It is formulated specifically for air filter element cleaning. It is non-sudsing and works in hot or cold water. FM 1400 contains biodegradable synthetic detergents and is non-phosphate, non-NTA. For more information, contact Filter Service Corporation, 2603 A West Main, Farmington, NM, 1-505-326-1127.

Recommendations for Cleaning and Replacing Filters

- Turn off and/or lock out electrical power to the dryer.
- Remove the threaded fastener securing the filter access cover, and then remove the cover.
- Remove the nut on the center retaining rod to remove the filter cartridge.

Vacuuming

Try vacuum-cleaning a soiled filter first. Vacuuming removes most large particles and surface contaminants, and may suffice for the first time you clean a filter. Use a commercial-duty (recommended) or household vacuum cleaner. Vacuum the filter from the air intake (dirty) side only.

Cleaning with Compressed Air

Blow clean, dry compressed air up and down the pleats, blowing out the filter from the clean side. Remove loose dirt from the filter with compressed air or a water hose. Compressed air should be less than 100 psi (689.5 kPa/6.89 bars). Use a 1/8" (3 mm) dia. nozzle at least 2" (5 cm) away from the filter. Don't shoot the air in a crisscross motion against the grain of the pleats—you may damage it.



Washing

As a last resort, wash the filter. However, do so only if the pressure drop is too high from fine dirt embedded in the filter, or if oily mist is present near the intake air location. Soak in a solution of FM 1400 or comparable detergent and warm water from five to ten minutes, then gently agitate for several minutes.



Rinse thoroughly with clean water to remove all detergent.

Caution! *Let the filter dry completely before returning it to service! A damp filter can contaminate the closed loop system of the dryer.*

Do not use a light bulb to dry the filter. You should get satisfactory filtration after second or third washings; however, dirt-holding capacity of the filter **decreases** after each washing.

After each cleaning:

- Inspect the filter element. Briefly hold a light bulb behind the element and look for any fatigued paper or residual dirt. Inspect for holes and tears by looking through the filter toward a bright light. Check for damaged gaskets or dented metal parts. Do not re-use a damaged filter!
- Inspect the end plates. Any damage here can allow air to bypass the filter.
- Look for rust on the end plates and metal core. Rust particles can flake off and contaminate the dryer and resin.
- Check the gasket for damage. A damaged gasket allows contaminants into the process. Replace as needed.
- Allow the filter to dry before re-using. Circulate warm air at less than 160°F (71°C). Do not use a light bulb to dry the filter.

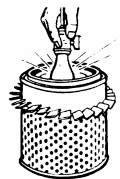

Preventative Maintenance Checklist

Dehumidifying Dryer Systems

System model #						Serial #							
Every week	Date/By	Date/By	Date/By	Date/By	Date/By	Date/By	Date/By	Date/By	Date/By	Date/By	Date/By	Date/By	Date/By
Inspect all filters for wear, replace/clean if dirty or worn.													
Check air regulator to make sure pressure is 60-80 psi (413.7 to 551.6 kPa /4.1 to 5.5 bars). (If applicable)													

Every month	Jan	Feb	Mar	Apr	May	Jun	Jul	Aug	Sep	Oct	Nov	Dec
Lock out electrical power and inspect electrical wiring for integrity.												
Lock out electrical power and check heater elements for continuity using an ohmmeter.												
Check dew point and temperature tracking with an external dew point monitor and pyrometer.												
Visually inspect the shifting of the airflow valve during one cycle.												

Every year	Next scheduled inspection	Actual inspection Date/By	Next scheduled inspection	Actual inspection Date/By
Inspect desiccant. Replace if brown or broken.				

Every two years	Scheduled replacement date	Actual replacement Date/Work done by	Scheduled replacement date	Actual replacement Date/Work done by
Replace desiccant.				

- Photocopy this page for your maintenance records -

6-3 Servicing the Dew Point Monitor

The accuracy of the dew point monitor on dehumidifying dryer systems depends on proper operation of the dew point sensor and the control board. The dew point sensor is in the process air stream and is therefore susceptible to contamination.

Dew point sensor life depends on:

Air temperature and flow passing over the sensor.

The amount of fines (dust) in the process air.

The amount of plasticizer vapor in the process air.

The dryer operator should monitor the initial dew point sensor readings and establish a periodic replacement schedule as needed.

Caution! *Do not attempt to check the continuity or resistance of the dew point sensor. The sensor will be destroyed!*

6-4 Symptoms of Worn Desiccant

The moisture absorption capacity of the desiccant used in your dehumidifying dryer degrades after an indefinite period of time. Useful life depends on variables such as material moisture content, plasticizer vapors in the return air, and number of regeneration cycles.

Your dehumidifying dryer may need new desiccant if it exhibits any of the following symptoms:

- Plastic material is not being dried sufficiently (high scrap/reject rate).
- Air temperature at the top of the regenerating desiccant bed rapidly climbs to 350°F (177°C) or more shortly after the start of regeneration, even though a saturated bed has just started heating.
- The process air dew point measured with a portable dew point monitor is higher than -10°F (-23°C) throughout the process drying cycle.
- Smoke or dust blows out of the process air outlet.
- Noticeable amounts of desiccant in the beds is a medium-brown color or darker.

If you notice any of these signs, replace the desiccant in the desiccant beds. Desiccant replacement kits are available from the manufacturer's parts department. If you want, a service technician can repack desiccant beds at your site.

WARNING!

Desiccant material causes eye irritation!

Breathing may be harmful and may cause skin irritation!

- **Do not get in eyes.**
- **Avoid prolonged contact with skin.**
- **Use with adequate ventilation.**
- **Wash thoroughly after handling.**

First Aid:

In case of eye contact, immediately flush eyes with plenty of water for at least 15 minutes. If irritation persists, see a physician.

6-5 Replacing Worn Desiccant

Caution! *Make sure desiccant beds are sufficiently cool before replacing worn desiccant.*

1. Disconnect the electrical and compressed air supply.
2. Remove the rear and side shrouds to expose the desiccant beds.
3. Free the bed covers by removing the hex nuts on the retaining rods and remove the upper screens from both beds.
4. Remove the desiccant in one of the following ways:
 - Vacuum out the desiccant.
 - Remove the entire bed from the frame and dump it out. To do this, remove the hose connections, unclamp the beds, and unbolt from the regen heater assembly.

Make sure the bed interiors are clean.

Important! *You should properly dispose of any discarded desiccant. Consult local disposal regulations for more information.*

Before re-packing the beds, determine the proper amount of desiccant for the dryer being serviced. See Figure 14 on the following page for more information. Pre-measured desiccant kits are available from the manufacturer's parts department.

Attach the beds to the frame for Steps 5 through 9.

5. Carefully place half of the large bead in the bottom of the beds, in an even layer, on the bottom screen. Place the small bead on top of it, in an even layer. Carefully place an even layer of the remaining large beads over the small beads.
6. Install the top screen, making sure that the edge is in contact with the sides of the bed all the way around. Install the washers and nuts and tighten down. Gently tap the around the sides of the desiccant canister with a rubber mallet to settle the desiccant. As settling occurs, re-tighten the nuts. Repeat the tapping and tightening process until little additional settling occurs.
7. Install the covers and gaskets on the beds, making sure they are tight and sealed. Replace desiccant bed gasket if necessary.
8. Re-connect any hoses that were disconnected.
9. Re-install the rear and side shrouds. Re-connect the compressed air supply and electrical power.

Figure 7:

Required Desiccant Amounts per Bed; Type 4X Desiccant (2 beds per unit)

Dryer CFM	Large bead (Type 4X)			Small bead (Type 4X)			Total per bed	
	Part no.	lbs.	Kg	Part no.	lbs.	Kg	lbs.	Kg
90	W00000892	3.0	1.362	W00000893	21.0	9.534	24.0	10.896
100		3.0	1.362		21.0	9.534	24.0	10.896
150		9.0	4.086		30.0	13.620	39.0	17.706
225		9.0	4.086		30.0	13.620	39.0	17.706

Type 13X Desiccant

Dryer CFM	Large bead (Type 13X)			Small bead (Type 13X)			Total per bed	
	Part no.	lbs.	Kg	Part no.	lbs.	Kg	lbs.	Kg
90	W00018050	3.0	1.362	W00018051	21.0	9.534	24.0	10.896
100		3.0	1.362		21.0	9.534	24.0	10.896
150		9.0	4.086		30.0	13.620	39.0	17.706
225		9.0	4.086		30.0	13.620	39.0	17.706

6-6 Replacing the Process Heater

Our dehumidifying dryers use Calrod-type heater elements mounted in a heater tube located in the top rear of the cabinet. The wattage of the heater varies with model, voltage, temperature range, etc., but the replacement procedure is the same.

If the process heater is mounted to the hopper, contact the manufacturer for the appropriate replacement procedure.

WARNING!

Disconnect and lock out power before you replace heater elements!

Use the following procedure to replace the process heater:

1. Remove the bolts securing the process heater access cover.
2. Sketch the heater wiring configuration so you can properly re-wire the heater.
3. Remove the wires to the heater plate assembly being removed or replaced.
4. Remove the bolts securing the heater plate assembly, and slide out the assembly.
5. Remove the heater from the mounting plate by removing the large brass nuts and washers.
6. Re-install the heater and heater plate assemblies in reverse order. Install new heater gaskets and securely tighten all fasteners.

Caution! *Heater loops should not touch each other. "Hot Spots" lead to premature heater failure!*

7. Reinstall the wires based on the sketch you made earlier.
8. Secure the heater access cover.

6-7 Replacing the Regeneration Heater

The dehumidifying dryers use heater elements located below each desiccant bed.

WARNING!

Disconnect and lock out power before you replace heater elements!

1. Remove the cover plate secured by bolts.
2. Sketch the heater wiring configuration so you can properly re-assemble the heaters.
3. Remove the wiring for the heater being removed or replaced.
4. Remove the bolts securing each heater mounting plate. Slide out the heater.
5. Re-install the new heaters in reverse order. Install new heater gaskets and securely tighten all fasteners.

Caution! *Heater loops should not touch each other. "Hot Spots" lead to premature heater failure!*

6. Re-install the wiring based on the sketch you made earlier.
7. Secure the heater access cover.

Changing the Controller Security Level

1. To access protect mode, press and hold the **AT** button and the Display button for more than one and a half to two (1.5 to 2) seconds.
2. The display should read **SECR** for security mode. If you press the Display button for short presses you will toggle between (**SECR**) and (**KEYP**) for AT protect.
3. With the display reading **SECR**, set the security levels by the arrow up and down keys. Change the security level to 1 to make changes to the operating parameters. The temperature controller is factory set to Security Level 5, the dew point indicator is factory set to Security Level 3.

Available Security Levels

Mode	Security level						
	0	1	2	3	4	5	6
Calibration	X						
Option	X	X					
Expansion	X	X					
Setup	X	X					
Level 2	X	X	X				
Level 1	X	X	X	X			
Level 0	X	X	X	X	X	X	

Any mode marked with an X is displayed in the Security Level indicated. To return to the main display (run mode), press and hold the AT and display key for 1.5 to 2 seconds.

Restoring Factory Defaults on the Process Temperature Controller

1. Remove controller from housing and check for output board number E53-QR4R (Pulse NPN/Relay).

2. Make sure jumper setting for input type is set for thermocouple **TC-PT**, middle jumper.
3. Return controller to housing.
4. Press the Display button for one (1) second to enter Menu Display.
5. Press the Up Arrow button to get to Setup mode.
6. To switch parameters within Setup mode, press the Display button.

Figure 8:

Setting List for Process Temperature Controller, Part No. A0548565

Mode	Parameter	Setting range	Default	Factory setting
Protect	SECr Security	0 to 6	1	5
Protect	YEYP A/M Key Protect	ON/OFF	OFF	ON
Manual	Manual MV	-5.0 to 105.0%	0.0	Default

Mode	Parameter	Setting range	Default	Factory setting
Level 0	SP Set Point	SP Lower Limit to Upper Limit EU	0	Default
Level 0	r-S Run/Stop	Run/Stop	Run	Default
Level 1	SP-0 Set Point 0	SP Lower to Upper EU	0	Default
Level 1	SP-1 Set Point 1	SP Lower to Upper EU	0	Default
Level 1	AL-1 Alarm Value 1	-1999 to 9999 EU	0	25.0
Level 1	AL-2 Alarm Value 2	-1999 to 9999 EU	0	25.0
Level 1	AL-3 Alarm Value 3	-1999 to 9999 EU	0	Default
Level 1	P Proportional Band	0.1 to 999.9% FS	10.0	4.4
Level 1	I Integral Time	0 to 3999 SEC	233	84
Level 1	d Derivative Timer	0 to 3999 SEC	40	13
Level 1	C-SC Cooling Coefficient	0.01 to 99.99	1.00	Default
Level 1	C-db Dead Band	-19.99 to 99.99%FS	0.00	Default
Level 1	6F-r Manual Reset Value	0.0 to 100.0%	50.0	Default
Level 1	HYS Hysteresis (Heat)	0.01 to 99.99%FS	0.10	Default
Level 1	CHYS Hysteresis (Cool)	0.01 to 99.99%FS	0.10	Default
Level 1	CP Control Period (Heat)	1 to 99 SEC	20	Default
Level 1	C-CP Control Period (Cool)	1 to 99 SEC	20	Default

Mode	Parameter	Setting range	Default	Factory setting
Level 0	SP Set Point	SP Lower Limit to Upper Limit EU	0	Default
Level 0	r-S Run/Stop	Run/Stop	Run	Default
Level 1	SP-0 Set Point 0	SP Lower to Upper EU	0	Default
Level 1	SP-1 Set Point 1	SP Lower to Upper EU	0	Default
Level 1	AL-1 Alarm Value 1	-1999 to 9999 EU	0	25.0

Level 1	AL-2 Alarm Value 2	-1999 to 9999 EU	0	25.0
Level 1	AL-3 Alarm Value 3	-1999 to 9999 EU	0	Default
Level 1	P Proportional Band	0.1 to 999.9% FS	10.0	4.4
Level 1	I Integral Time	0 to 3999 SEC	233	84
Level 1	d Derivative Timer	0 to 3999 SEC	40	13
Level 1	C-SC Cooling Coefficient	0.01 to 99.99	1.00	Default
Level 1	C-db Dead Band	-19.99 to 99.99%FS	0.00	Default
Level 1	6F-r Manual Reset Value	0.0 to 100.0%	50.0	Default
Level 1	HYS Hysteresis (Heat)	0.01 to 99.99%FS	0.10	Default
Level 1	CHYS Hysteresis (Cool)	0.01 to 99.99%FS	0.10	Default
Level 1	CP Control Period (Heat)	1 to 99 SEC	20	Default
Level 1	C-CP Control Period (Cool)	1 to 99 SEC	20	Default

Mode	Parameter	Setting range	Default	Factory setting
Level 2	r-L Remote/Local	RMT/LCL	LCL	Default
Level 2	SPrU Sp Ramp Time Unit	M(Minutes)/H(Hours)	M	Default
Level 2	SPrE Sp Ramp Set Value	0 to 9999 EU	0	Default
Level 2	LbA LBA Detection Time	0 to 9999 SEC	0	Default
Level 2	Au-5 MV at Stop	-5.0 to 105.0%	0.0	Default
Level 2	Au-E MV at PV Error	-5.0 to 105.0%	0.0	Default
Level 2	6L-L MV Upper Limit	MV Lower Limit +0.1 to 105.0%	105.0	Default
Level 2	6L-L MV Lower Limit	-5.0 to MV Upper Limit -0.1%	-5.0	Default
Level 2	6rL MV Change Rate Limit	0.0 to 100.0%/SEC	0.0	Default
Level 2	CnF Input Digital Filter	0 to 9999 SEC	0	Default
Level 2	ALH1 Alarm 1 Hysteresis	0.01 to 99.99%	0.02	Default
Level 2	ALH2 Alarm 2 Hysteresis	0.01 to 99.99%	0.02	Default
Level 2	ALH3 Alarm 3 Hysteresis	0.01 to 99.99%	0.02	Default
Level 2	Cn5H Input Shift Upper Limit	-199.9 to 999.9 °C	0.0	Default
Level 2	Cn5L Input Shift Lower Limit	-999.9 to 999.9 °C	0.0	Default

Mode	Parameter	Setting range	Default	Factory setting
Setup	Cn-E Input Type	0 to 21	2	3
Setup	Cn-H Scaling Upper Limit	Scaling Lower Limit +1 to 9999 EU	-100	Default
Setup	Cn-L Scaling Lower Limit	-1999 to SP Setting Upper Limit -0.1 EU	0	Default
Setup	dP Decimal Point	0 to 3	0	Default
Setup	d-U °C/F Selection	°C/F	°C	°F
Setup	CnCE Parameter	Yes/No	No	Default

	Initialize			
Setup	6UE1 Control Output 1 Assignment	Heat/Cool/Alarm 1/Alarm 2/Alarm 3/LBA	Heat	Default
Setup	6UE2 Control Output 2 Assignment	Heat/Cool/Alarm 1/Alarm 2/Alarm 3/LBA	AL-1	Default
Setup	Sub 1 Auxiliary Output 1 Assignment	Alarm 1/Alm 2/Alm 3/LBA/S.ERR/E333	AL-1	Default
Setup	ALE1 Alarm 1 Type	0 to 11	2	Default
Setup	AL1n Alarm 1 open in alarm	NO/NC	NO	Default
Setup	ALE2 Alarm 2 Type	0 to 11	2	Default
Setup	AL2n Alarm 2 open in alarm	NO/NC	NO	Default
Setup	ALE3 Alarm Type	0 to 11	2	Default
Setup	AL3n Alarm 3 open in alarm	NO/NC	NO	Default
Setup	6rEu Direct/Reverse Operation	OR-R/OR-D	OR-R	Default

Mode	Parameter	Setting range	Default	Factory setting
Expansion	SL-H Set Point Upper Limit	SP Lower Limit +1 to Scaling Upper Limit	1300	400.0
Expansion	SL-L Set Point Lower Limit	Scaling Upper Limit to SP Lower Limit	-200	0
Expansion	CnEL PID/ON/OFF	PID/ON/OFF	PID	Default
Expansion	SE ST Adaptive Tuning (Fuzzy)	OFF/ON	OFF	Default
Expansion	SE-b ST Stable Range	0.1 to 999.9 °C/F	15	Default
Expansion	ALFA α	0.01 to 1.00	0.65	Default
Expansion	AE-G AT Calculated Gain	0.1 to 10.0	1.0	Default
Expansion	rESE Standby Sequence Reset Setting Method	0/1	0	Default
Expansion	rEE Automatic Return of Display Mode	0 to 99 SEC	0	Default
Expansion	AE-H AT Hysteresis	0.1 to 9.9% FS	0.2	Default
Expansion	LbAb LBA Detection Width	0.0 to 999.9% FS	0.2	Default

Option Boards

Available Option Boards

Option Type	RE232C	RS-485	Event Input	Transfer Output
Board Number	E53-CK01	E53-CK03	E53-CKB	E53-CKF

Mode	Parameter	Setting range	Default	Factory setting
Option	Eu-A Multi-SP Function	0/1	0	Default
Option	Eu-1 Event Input Assign 1	STOP/MAN	STOP	Default
Option	SbCE Communication Stop Bit	½ BITS	2	Default
Option	Len Comm. Data Length	7/8 BITS	7	Default
Option	PrEY Commication Parity	None/Even/Odd	Even	Default
Option	6PS Comm. Baud Rate	1.2/2.4/4.8/9.6/19.2	9.6 kbps	Default
Option	U-n6 Comm. Unit No.	0 to 99	0	Default
Option	Er-E Transfer Output Type	SP/SP-M/PV/O/C-O	SP	Default
Option	Er-H Xfer Output Upper Limit	5	5	Default
Option	Er-L Xfer Output Lower Limit	5	5	Default

Restoring Factory Defaults on the Dew Point Controller

1. Make sure jumper setting for input type is set for Current Input (I), right jumper.
2. Return controller to housing.
3. Press the Display button for one (1) second to enter Menu Display.
4. Press the Arrow Up button to switch between menus.
5. To switch parameters within a menu, press Up Arrow button.

Figure 9

Setting List for Dew Point Controller, Part No. A0548567

Mode	Parameter	Setting range	Default	Factory setting
Protect	SECr Security	0 to 6	1	3
Protect	YEYP A/M Key Protect	ON/OFF	OFF	ON
Manual	Manual MV	-5.0 to 105.0 %	0.0	Default
Level 0	SP Set Point	SP lower limit to upper limit EU	0	Default
Level 0	r-S Run/Stop	Run/Stop	Run	Default
Level 1	AL-1 Alarm Value 1	-1999 to 9999 EU	0	-10.0°F/-23°C
Level 1	AL-2 Alarm Value 2	-1999 to 9999 EU	0	-10.0°F/-23°C
Level 1	C-db Dead Band	-19.99 to 99.99%FS	0.00	Default
Level 1	HYS Hysteresis (Heat)	0.01 to 99.99% FS	0.10	Default
Level 1	CHYS Hysteresis (Cool)	0.01 to 99.99 FS	0.10	Default
Level 2	SPrU Sp Ramp Time Unit	M(Minutes)/H(Hours)	M	Default
Level 2	SPrt Sp Ramp Set Value	0 to 9999 EU	0	Default
Level 2	CnF Input Digital Filter	0 to 9999 SEC	0	Default
Level 2	ALH1 Alarm 1 Hysteresis	0.01 to 99.99%	0.02	Default
Level 2	ALH2 Alarm 2 Hysteresis	0.01 to 99.99%	0.02	Default
Level 2	Cn5H input shift upper limit	-199.9 to 999.9°C	0.0	Default

Level 2	Cn5L input shift lower limit	-999.9 to 999.9°C	0.0	Default
---------	------------------------------	-------------------	-----	---------

Mode	Parameter	Setting range	Default	Factory setting
Setup	Cn-t Input Type	0 to 21	2	17
Setup	Cn-H Scaling Upper Limit	Scaling Lower Limit +1 to 9999 EU	-100	15°F/-9C
Setup	Cn-L Scaling Lower Limit	-1999 to SP Setting Upper Limit -0.1 EU	0	-40°F/-40C
Setup	dP Decimal Point	0 to 3	0	Default
Setup	CnCE Parameter Initialize	Yes/No	No	Default
Setup	6Ut1 Control Output 1 Assignment	Heat/Cool/Alarm 1/Alarm 2/ Alarm 3/LBA	Heat	COOL
Setup	6Ut2 Control Output 2 Assignment	Heat/Cool/Alarm 1/Alarm 2/ Alarm 3/LBA	AL-1	Default
SetUp	Sub 1 Auxiliary Output 1 Assignment	Alarm 1/Alm 2/Alm 3/LBA/S. ERR/E333	AL-2	Default
Setup	ALt1 Alarm 1 Type	0 to 11	2	8
Setup	AL1n Alarm 1 open in alarm	NO/NC	NO	Default
Setup	ALt2 Alarm 2 Type	0 to 11	2	8
Setup	AL2n Alarm 2 open in alarm	NO/NC	NO	Default
Setup	6rEU Direct/Reverse Operation	OR-R/OR-D	OR-R	Default
Expansion	SL-H Set Point Upper Limit	SP Lower Limit +1 to Scaling Upper Limit	1300	15°F/-9C
Expansion	SL-L Set Point Lower Limit	Scaling Upper Limit to Sp Lower Limit	-200	-40°F/-40C
Expansion	CntL PID/ON/OFF	PID/ON-OFF	PID	ON-OFF
Expansion	rEst Standby Sequence Reset Setting Method	0/1	0	Default
Expansion	rEt Automatic Return of Display Mode	0 to 99 SEC	0	Default

6-8 Restoring the E5CK Temperature Controller and Dew Point Meter to Factory Setup

If preset parameters on the controller have been tampered with and it no longer properly controls temperature and displays dew point, you can restore the controller to factory setup.

- Notes -

Chapter 7: Troubleshooting

Problem	Possible cause	Corrective action
Little or no air coming from the process delivery tube.	Dirty filter.	Clean or replace filter.
	Desiccant beds are contaminated by material or plasticizer leaking into the system.	Replace desiccant.
	Blower overload has tripped.	Fix the problem and reset the overload.
	Blower fins filled with dust or contaminants.	Remove blower side plate, clean baffles, replace.
Suction in delivery tube, pressure from the return tube.	Phase is reversed on power drop coming into the dryer.	<p>Stop the dryer.</p> <p>If the dryer was connected to the drying hopper, check to see if the desiccant and process air heater has been contaminated with resin.</p> <p>If so, replace the desiccant and remove any resin carry-over. Otherwise, change the phase of two legs of the three-phase power drop.</p>
Loss or reduction of process air temperature.	Process heaters are faulty.	Check for open heaters. Replace if required.
	Solid-state temperature controller faulty.	Replace.
	Process temperature was adjusted in error by plant personnel.	Make sure that plant personnel are aware of the proper temperature set point. A sign posted next to the controller is helpful.
Loss or reduction in drying capacity.	Process heaters are faulty.	Replace.
	Desiccant beds are contaminated.	Replace desiccant.
	Material being dried differs from material specified at the time of purchase.	Drying systems are designed for the material which was originally specified. Different materials may need a longer residence time or different drying temperature.
	Break in flex hose to/from drying hopper.	Inspect for air leaks; replace if necessary.

Problem	Possible cause	Corrective action
Loss or reduction in drying capacity. (Cont'd.)	Airflow valve sticking or failing to shift.	Check for proper operation of valve actuators. Repair or replace if necessary.
	Blower fins filled with dust or contaminants.	Remove blower side plate, clean baffles, replace. Replace filter elements.
PLC Regeneration Bed LED indicators both off.	Insufficient power to PLC (Power LED is off).	Check power supply and power wiring to PLC.
	Faulty PLC (PLC Power light is on, Run light is off, and/or Error light is on).	Replace PLC.
PLC Regeneration Heater Left/Right output indicators both off.	Regenerating bed cool down.	None.
	Blower Input indicator is off.	Verify that blower contactor is on. Check input wiring to PLC.
	Process air in high-temperature condition.	None.
	Insufficient power to PLC (Power light is off).	Check power supply and power wiring to PLC.
	Faulty PLC (PLC Power light is on, Run light is off, and/or Error light is on).	Replace PLC.
Material in drying hopper cakes, or meltdown occurs.	Process temperature set too high due to operator error.	Check resin manufacturer's data sheet for proper drying temperature. Make sure plant personnel are aware of the correct process temperature set point.
	High temperature alarm not set properly.	Reset high temperature alarm.
	Process set point is out of acceptable range.	Restore temperature controller to factory pre-sets.
	Function set for degrees Celsius (°C), set point at degrees Fahrenheit (°F).	Verify correct Celsius or Fahrenheit settings.
Poor dew point performance.	Burned out regeneration heater.	Repair or replace.
	Contaminated or worn out desiccant.	Replace.
	Leaking process air hoses.	Repair or replace.
	Dryer operates beyond its capacity.	Check dryer and drying hopper sizing.
	Bad dew point sensor.	Replace.
	Fouled dew point sensor manifold.	Clear obstruction. Air should flow freely through sensor.

Problem	Possible cause	Corrective action
Nothing displays when the controller is turned on.	The internal mechanism is not inserted properly into the housing.	Properly insert the internal mechanism into the housing.
	The power supply is not connected to its terminals properly.	Properly connect the power supply to the power supply terminals.
	No power is supplied, or the supplied power is not within the specified range.	Supply a voltage of 85 to 125 VAC to the power supply terminals of the controller.
	Disconnect switch or Control Power switch not set to ON . Control Power fuse blown.	Check control power fuse for continuity. Turn disconnect switch and control power switch ON .
Process value is abnormal or not obtained.	Input polarity on thermocouple is wrong or connection is wrong.	Properly wire the terminals.
	No compensating lead wires used for extension of the thermocouple.	Use proper compensating lead wires and terminals.
	Thermocouple and controller are connected by wires other than proper lead wires.	Use a dedicated thermocouple connector. If a connector is a metal different from the thermocouple and controller, a temperature error may result.
	Sensor is broken or short-circuited.	Replace with a good sensor.
	The controller is influenced by noise or other induction.	Separate input wires as far as possible from the origin of the noise.
	Celsius temperatures used instead of Fahrenheit or vice versa.	Setup mode level 2 display d-U. S-V display shows setting.

Determining Temperature Controller Errors or Sensor Errors

Using a Thermocouple

If the controller displays a temperature that is close to room temperature (70°F/21°C) when you short-circuit controller input terminals, the controller is normal and the sensor is probably broken, short-circuited, or incorrectly wired.

Using a Platinum Resistance Thermometer

If the controller displays a temperature of about 0.0°C (32°F) when you insert a 100-ohm resistor between terminals **A** and **-B** of the controller, and you short-circuit controller terminals **+B** and **-B**, the controller is normal and the sensor is probably broken, short-circuited, or incorrectly wired.

CHAPTER 8: APPENDIX

8-1 Technical Assistance

Parts Department

Call toll-free 7am–5pm CST [800] 783-7835 or call [262] 641-8600, Fax [262] 641-8653

The ACS Customer Service Group will provide your company with genuine OEM quality parts manufactured to engineering design specifications, which will maximize your equipment's performance and efficiency. To assist in expediting your phone or fax order, please have the model and serial number of your unit when you contact us. A customer replacement parts list is included in this manual for your convenience. ACS welcomes inquiries on all your parts needs and is dedicated to providing excellent customer service.

Service Department

Call toll-free 8am–5pm CST [800] 783-7835 or call [262] 641-8600

Emergencies after 5pm CST, call [847] 439-5655

We have a qualified service department ready to help. Service contracts are available for most products.

Sales Department

Call [262] 641-8600 Monday–Friday, 8am–5pm CST

Our products are sold by a world-wide network of independent sales representatives. Contact our Sales Department for the name of the sales representative nearest you.

Contract Department

Call [262] 641-8600 Monday–Friday, 8am–5pm CST

Let us install your system. The Contract Department offers any or all of these services: project planning; system packages including drawings; equipment, labor, and construction materials; and union or non-union installations.

8-2 Technical Specifications

Process air flow		Hose conn. dia.		Output temperature range ①		Amps 460/3/60 (name-plate)	Process blower power	Regen. blower	Dimensions						Approx. shipping weight			
cfm	cmh	in.	mm	°F	°C		hp	kW	hp	kW	inches			cm			lbs.	Kg
											L	W	H	L	W	H		
90	153	2½"	63.5	140°-400°	60°-204°	20	1.00	0.75	0.25	0.19	27	27	68	69	69	173	440	200
100	②170	2"	50.8	185°-400°	85°-204°	23	4.00	3.00	0.25	0.19	27	27	68	69	69	173	475	216
150	255	2½"	63.5	160°-400°	71°-204°	34	4.00	3.00	0.33	0.25	37	37	79	94	94	239	750	341
225	382	4"	101.6	160°-400°	71°-204°	45	5.00	3.75	0.33	0.25	37	37	87	94	94	239	850	386

① Aftercooler required above 250°F (121°C) operation.

② 100 CFM operation below 185°F (85°C) requires a precooler.

Free Manuals Download Website

<http://myh66.com>

<http://usermanuals.us>

<http://www.somanuals.com>

<http://www.4manuals.cc>

<http://www.manual-lib.com>

<http://www.404manual.com>

<http://www.luxmanual.com>

<http://aubethermostatmanual.com>

Golf course search by state

<http://golfingnear.com>

Email search by domain

<http://emailbydomain.com>

Auto manuals search

<http://auto.somanuals.com>

TV manuals search

<http://tv.somanuals.com>