



SDA Series 25-100
(15-60 cfm)
Compact Dehumidifying Dryers

Part Number: 882.00291.00
Bulletin Number: DH1-635.2
Effective: 12/1/05

Write Down Your Serial Numbers Here For Future Reference:

_____	_____
_____	_____
_____	_____

We are committed to a continuing program of product improvement.
Specifications, appearance, and dimensions described in this manual are subject to change without notice.

DCN No. _____
© Copyright 2006

Shipping Information

Unpacking and Inspection

You should inspect your dryer for possible shipping damage.

Thoroughly check the equipment for any damage that might have occurred in transit, such as broken or loose wiring and components, loose hardware and mounting screws, etc.

In the Event of Shipping Damage

According to the contract terms and conditions of the Carrier, the responsibility of the Shipper ends at the time and place of shipment.

Notify the transportation company's local agent if you discover damage.

Hold the damaged goods and packing material for the examining agent's inspection. **Do not return any goods before the transportation company's inspection and authorization.**

File a claim with the transportation company. Substantiate the claim by referring to the agent's report. A certified copy of our invoice is available upon request. The original Bill of Lading is attached to our original invoice. If the shipment was prepaid, write us for a receipted transportation bill.

Advise customer service regarding your wish for assistance and to obtain an RMA (return material authorization) number.

If the Shipment is Not Complete

Check the packing list as back-ordered items are noted on it. You should have:

- Dehumidifying Dryer
- Bill of lading
- Packing list
- Operating and Installation packet
- Electrical schematic and panel layout drawings
- Component instruction manuals

Re-inspect the container and packing material to see if you missed any smaller items during unpacking.

If the Shipment is Not Correct

If the shipment is not what you ordered, **contact the shipping department immediately**. For shipments in the United States and Canada, call 1 (800) 233-4819; for all other countries, call our international desk at (630) 475-7491. Have the order number and item number available. *Hold the items until you receive shipping instructions.*

Table of Contents

CHAPTER 1: SAFETY	5
1-1 How to Use This Manual	5
Safety Symbols Used in this Manual	5
1-2 <i>Safety Tag Information</i>	6
1-3 Warnings and Precautions	6
1-4 Responsibility	7
General Responsibility	7
Operator Responsibility	7
Maintenance Responsibility	9
Reporting a Safety Defect	9
CHAPTER 2: FUNCTIONAL DESCRIPTION	10
2-1 Models Covered in This Manual	10
2-2 General Description	10
The drying system	10
What is desiccant?	10
The Process/Regeneration Cycle	10
2-3 Standard Features	11
Mechanical Features	11
Electrical Features	11
Controller Features	12
2-4 Options	12
2-5 Safety Devices and Interlocks	12
CHAPTER 3: INSTALLATION	14
3-1 Uncrating the Equipment	14
3-2 Rigging and Placing the Dryer	14
3-3 Electrical Connections	16
3-4 Setup Procedures	17
Checking for Proper Blower Rotation	17
Making Dryer/Drying Hopper Process Air Connections	17
Drying Hopper Air Trap Considerations	18
Optional Aftercooler	18
3-5 Initial Start-up	18
Pre-Startup Checks	18
Starting Up the Dryer	18
Auto-Tuning the Dryer	19
Shutting Down the Dryer	19
CHAPTER 4: OPERATION	20
4-1 Controller Description and Operation	20
Identifying Control Panel Indicator Lights and Switches	20
Process Air Temperature Controller	21
Setting the Process Air Temperature	23
Restoring the Process Air Temperature Controller (E5CN) to Factory Settings...23	

	Process Air Dew Point Display	25
	Setting the High Dew Point Alarm	25
	Restoring the Process Air Dew Point Meter (E5CK) to Factory Setup	25
4-2	Dryer Operation Procedures	26
	Controller Operation	26
	Alarm Display Messages	27
CHAPTER 5: MAINTENANCE		29
5-1	Preventative Maintenance Schedule	29
5-2	Preventative Maintenance	30
	Servicing Process Air Filters	30
	Servicing the Dew Point Monitor	31
5-3	Corrective Maintenance	31
	Symptoms of Worn Desiccant	31
	Replacing Worn Desiccant	32
	Replacing the Process/Regeneration Heater	34
	Replacing/Cleaning Cooling Coil	35
CHAPTER 6: TROUBLESHOOTING		37
6-1	Introduction	37
6-2	Determining Temperature Controller Errors or Sensor Errors	39
	Using a Thermocouple	39
CHAPTER 7: APPENDIX		40
7-1	Warranty Specification	40
7-2	Technical Specifications	41
7-3	Drawings and Diagrams	42
7-4	Spare Parts	44
7-5	Returned Material Policy	49
	Credit Returnst	49
	Warranty Returns	50
7-6	Dryer Identification (Serial Number) Tag	50
7-7	Technical Assistance	50
	Parts Department	50
	Sales Department	50
	Contract Department	51

Chapter 1: Safety

1-1 How to Use This Manual

Use this manual as a guide and reference for installing, operating, and maintaining your drying system. The purpose is to assist you in applying efficient, proven techniques that enhance equipment productivity.

This manual covers only light corrective maintenance. No other maintenance should be undertaken without first contacting a service engineer.

The Functional Description section outlines models covered, standard features, and safety features. Additional sections within the manual provide instructions for installation, pre-operational procedures, operation, preventive maintenance, and corrective maintenance.

The Installation chapter includes required data for receiving, unpacking, inspecting, and setup of the drying system. We can also provide the assistance of a factory-trained technician to help train your operator(s) for a nominal charge. This section includes instructions, checks, and adjustments that should be followed before commencing with operation of the drying system. These instructions are intended to supplement standard shop procedures performed at shift, daily, and weekly intervals.

The Operation chapter includes a description of electrical and mechanical controls, in addition to information for operating the dryer safely and efficiently.

The Maintenance chapter is intended to serve as a source of detailed assembly and disassembly instructions for those areas of the equipment requiring service. Preventive maintenance sections are included to ensure that your drying system provides excellent, long service.

The Troubleshooting chapter serves as a guide for identification of most common problems. Potential problems are listed, along with possible causes and related solutions.

The Appendix contains technical specifications, drawings, schematics, parts lists, and available options. A spare parts list with part numbers specific to your machine is provided with your shipping paperwork package. Refer to this section for a listing of spare parts for purchase. Have your serial number and model number ready when ordering.

Safety Symbols Used in this Manual

The following safety alert symbols are used to alert you to potential personal injury hazards. Obey all safety messages that follow these symbols to avoid possible injury or death.

DANGER! *DANGER indicates an imminently hazardous situation that, if not avoided, will result in death or serious injury.*

WARNING! *WARNING indicates a potentially hazardous situation or practice that, if not avoided, could result in death or serious injury.*

Caution! *CAUTION indicates a potentially hazardous situation or practice that, if not avoided, may result in minor or moderate injury or in property damage.*

1-2 Safety Tag Information

Dryer Safety Tags



Hot!



**Read Operation
and Installation
Manual**



**High Voltage
Inside Enclosure**



Earth Ground



Lifting Point



**Protected Earth
Ground**

1-3 Warnings and Precautions

Our equipment is designed to provide safe and reliable operation when installed and operated within design specifications, following national and local safety codes. This may include, but is not limited to OSHA, NEC, CSA, SPI, and any other local, national and international regulations.

To avoid possible personal injury or equipment damage when installing, operating, or maintaining this equipment, use good judgment and follow these safe practices:

- Read and follow these operation and installation instructions when installing, operating, and maintaining this equipment. If these instructions become damaged or unreadable, additional copies are available from the manufacturer.**
- Follow all **SAFETY CODES**.
- Wear **SAFETY GLASSES** and **WORK GLOVES**.
- Work only with approved tools and devices.
- Disconnect and/or lock out power before servicing or maintaining the equipment.
- Use care when **LOADING, UNLOADING, RIGGING, or MOVING** this equipment.
- Operate this equipment within design specifications.
- OPEN, TAG, and LOCK ALL DISCONNECTS** before working on equipment. You should remove the fuses and carry them with you.
- Make sure the equipment and components are properly **GROUNDING** before you switch on power.
- Use **EXTEREME CAUTION** when working with dryer. **HIGH HEAT** can be dangerous. Keep body parts, tools, clothing, and debris away from dryer.

- ☑ When welding or brazing in or around this equipment, make sure **VENTILATION** is **ADEQUATE. PROTECT** adjacent materials from flame or sparks by shielding with sheet metal. An approved **FIRE EXTINGUISHER** should be close at hand and ready for use if needed.
- ☑ Do not restore power until you remove all tools, test equipment, etc., and the equipment and related components are fully reassembled.
- ☑ Only **PROPERLY TRAINED** personnel familiar with the information in this manual should work on this equipment.

We have long recognized the importance of safety and have designed and manufactured our equipment with operator safety as a prime consideration. We expect you, as a user, to abide by the foregoing recommendations in order to make operator safety a reality.

1-4 Responsibility

These machines are constructed for maximum operator safety when used under standard operating conditions and when recommended instructions are followed in the maintenance and operation of the machine.

All personnel engaged in the use of the machine should become familiar with its operation as described in this manual.

Proper operation of the machine promotes safety for the operator and all workers in its vicinity.

Each individual must take responsibility for observing the prescribed safety rules as outlined. All warning and danger signs must be observed and obeyed. All actual or potential danger areas must be reported to your immediate supervisor.

General Responsibility

No matter who you are, safety is important. Owners, operators and maintenance personnel must realize that every day, safety is a vital part of their jobs.

If your main concern is loss of productivity, remember that production is always affected in a negative way following an accident. The following are some of the ways that accidents can affect your production:

- Loss of a skilled operator (temporarily or permanently)
- Breakdown of shop morale
- Costly damage to equipment
- Downtime

An effective safety program is responsible and economically sound.

Organize a safety committee or group, and hold regular meetings. Promote this group from the management level. Through this group, the safety program can be continually reviewed, maintained, and improved. Keep minutes or a record of the meetings.

Hold daily equipment inspections in addition to regular maintenance checks. You will keep your equipment safe for production and exhibit your commitment to safety.

Please read and use this manual as a guide to equipment safety. This manual contains safety warnings throughout, specific to each function and point of operation.

Operator Responsibility

The operator's responsibility does not end with efficient production. The operator usually has the most daily contact with the equipment and intimately knows its capabilities and limitations.

Plant and personnel safety is sometimes forgotten in the desire to meet incentive rates, or through a casual attitude toward machinery formed over a period of months or years. Your employer probably has established a set of safety rules in your workplace. Those rules, this manual, or any other safety information will not keep you from being injured while operating your equipment.

Learn and always use safe operation. Cooperate with co-workers to promote safe practices. Immediately report any potentially dangerous situation to your supervisor or appropriate person.

REMEMBER:

- **NEVER** place your hands or any part of your body in any dangerous location.
- **NEVER** operate, service, or adjust the dryer without appropriate training and first reading and understanding this manual.
- **NEVER** try to pull material out of the dryer with your hands while it is running!
- Before you start the dryer check the following:
 - Remove all tools from the dryer;
 - Be sure no objects (tools, nuts, bolts, clamps, bars) are laying in the hopper area;
- If your dryer has been inoperative or unattended, check all settings before starting the unit.
- At the beginning of your shift and after breaks, verify that the controls and other auxiliary equipment are functioning properly.
- Keep all safety guards in place and in good repair. **NEVER** attempt to bypass, modify, or remove safety guards. Such alteration is not only unsafe, but will void the warranty on your equipment.
- When changing control settings to perform a different mode of operation, be sure selector switches are correctly positioned. Locking selector switches should only be adjusted by authorized personnel and the keys removed after setting.
- Report the following occurrences **IMMEDIATELY**:
 - unsafe operation or condition
 - unusual dryer action
 - leakage
 - improper maintenance
 - **NEVER** stand or sit where you could slip or stumble into the dryer while working on it.
- **DO NOT** wear loose clothing or jewelry, which can be caught while working on a dryer. In addition, cover or tie back long hair.
- Clean the dryer and surrounding area **DAILY**, and inspect the machine for loose, missing or broken parts.

- Shut off power to the dryer when it is not in use. Turn the switch to the **OFF** position, or unplug it from the power source.

Maintenance Responsibility

Proper maintenance is essential to safety. If you are a maintenance worker, you must make safety a priority to effectively repair and maintain equipment.

Before removing, adjusting, or replacing parts on a machine, remember to turn off all electric supplies and all accessory equipment at the machine, and disconnect and lockout electrical power. Attach warning tags to the disconnect switch.

When you need to perform maintenance or repair work on a dryer above floor level, use a solid platform or a hydraulic elevator. If there is a permanently installed catwalk on your equipment, use it. The work platform should have secure footing and a place for tools and parts. **DO NOT** climb on dryers, machines, or work from ladders.

If you need to repair a large component, use appropriate handling equipment. Before you use handling equipment (portable “A” frames, electric boom trucks, fork trucks, overhead cranes) be sure the load does not exceed the capacity of the handling equipment or cause it to become unstable.

Carefully test the condition of lifting cables, chains, ropes, slings, and hooks before using them to lift a load.

Be sure that all non-current carrying parts are correctly connected to earth ground with an electrical conductor that complies with current codes. Install in accordance with national and local codes.

When you have completed the repair or maintenance procedure, check your work and remove your tools, rigging, and handling equipment.

Do not restore power to the dryer until all persons are clear of the area. **DO NOT** start and run the dryer until you are sure all parts are functioning correctly.

BEFORE you turn the dryer over to the operator for production, verify all dryer enclosure panels, guards and safety devices are in place and functioning properly.

Reporting a Safety Defect

If you believe that your equipment has a defect that could cause injury, you should immediately discontinue its use and inform the manufacturer.

The principle factors that can result in injury are failure to follow proper operating procedures (i.e. lockout/tag out), or failure to maintain a clean and safe working environment.

Chapter 2: Functional Description

2-1 Models Covered in This Manual

This manual provides operation, installation, and maintenance instructions for 15, 30 and 60 cfm dehumidifying dryers. Model numbers are listed on the serial tag. Make sure you know the model and serial number of your equipment before contacting the manufacturer for parts or service.

Our dehumidifying mini dryers are designed to generate heated dehumidified air (at a very low dew point) at carefully controlled temperatures for use in plastic drying systems. The dryer circulates hot air through a column of plastic resin in the large drying hopper. The resin in the hopper is discharged through a slide gate in a “first in, first out” manner.

2-2 General Description

The Drying System

Dehumidifying dryers are used to generate very low dew point air heated to a controlled temperature for drying plastic pellets and regrind.

Our dryers force hot, dry air through resin in a drying hopper, where air picks up moisture from the material and draws it back to the dryer. In the dryer, a desiccant bed strips moisture from the air. The dried process air is then re-heated and delivered back into the drying hopper for more moisture removal.

Portion of the low dew point process air is directed to the desiccant tank that is off process. This air is heated to approximately 450°F (232°C) before entering the bed that is in regeneration. The moisture is then forced from the desiccant before being exhausted into the atmosphere. A small amount of ambient air is introduced into the process return air filter to make up for the air lost during the bed regeneration. To compensate for the humidity content in the air, this dryer is supplied with the proper amount of desiccant.

What is desiccant?

Desiccant is a material that attracts and holds (absorbs) water from the air. The desiccant our dryers use is a synthetic crystalline metal aluminosilicate blended with a clay binder and formed into beads.

The Process/Regeneration Cycle

Our dryers have two desiccant beds. While one bed is on-line in the process air loop, the other is off-line, being regenerated.

When a desiccant bed is on-line, it absorbs moisture from the process air. In time, the bed becomes saturated with moisture and needs to be regenerated. The dryer automatically redirects the process airflow to the second bed, and starts the regeneration cycle on the first bed.

During regeneration, the dryer system heats the very low dew point air and forces it through the desiccant bed. The moisture driven off the bed bleeds to the atmosphere.

Figure 1: Typical Dryer Air Flow Schematic

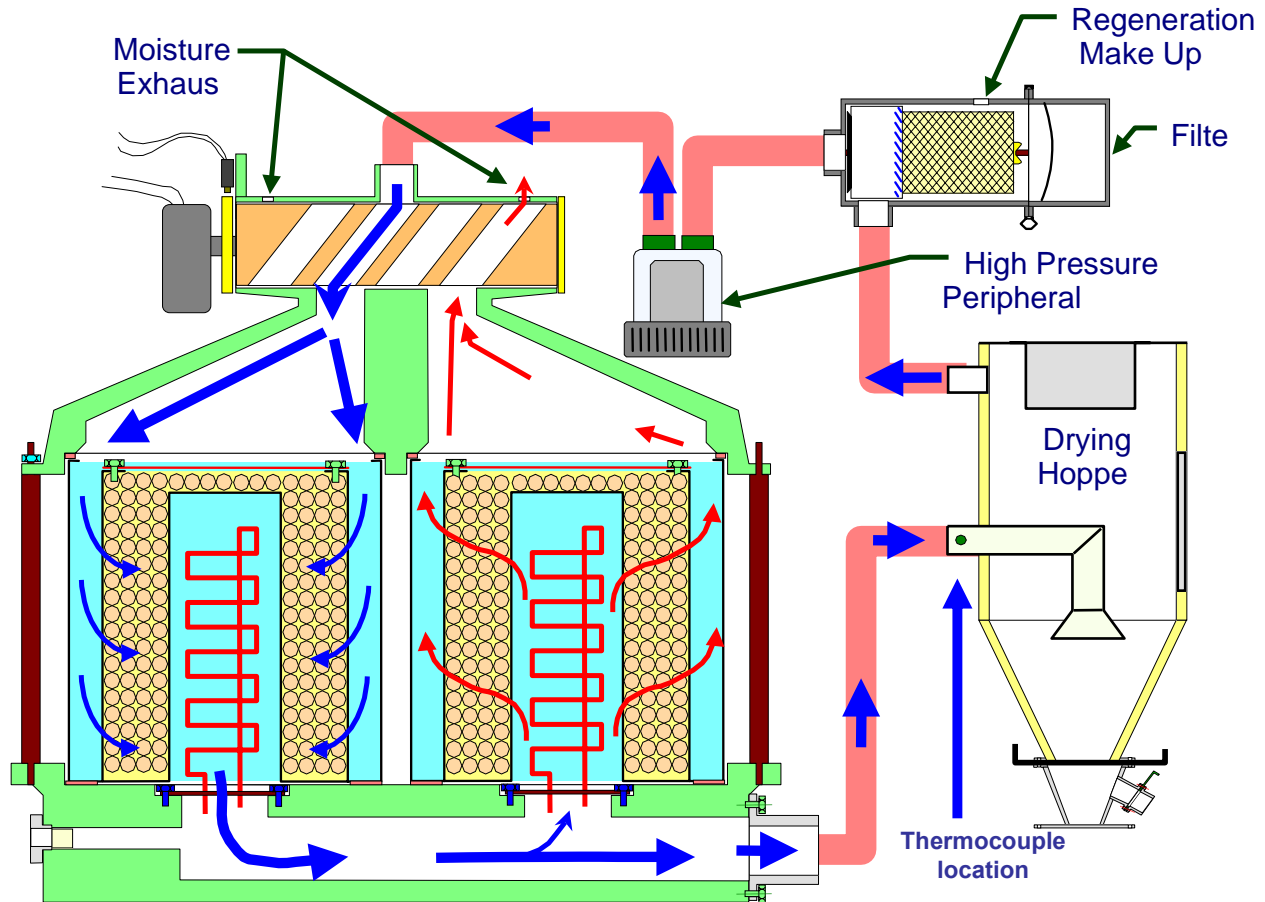

2-3 Standard Features

Mechanical Features

- Dual desiccant beds
- Electrically-actuated air valve
- 13X Molecular Sieve
- Single regenerative process blower
- Drying temperature range of 180°F to 230°F (82°C to 110°C).
- 2.5" hose connections

Electrical Features

- Process thermocouple to be connected to drying hopper air inlet.
- Nema 12 control enclosure
- NFPA79 machinery electrical standards
 - Non-fused electrical disconnect (3 phase models only)
 - Branch fusing

- Mercury process heater contactor
- Process high temperature alarm light
- Process/regeneration heater box
- High temperature safety system (Process/Regeneration)

Controller Features

- Mitsubishi programmable relay controller
- Display of process temperature set point and actual settings

2-4 Options

Options marked with “*” indicate options that can be factory installed or retrofitted in the field.

- * Process temperature up to 400°F (204° C) or below 180°F (82°C), including aftercooler with dryer and silicone insulated delivery hose.

Note: For below 180°F (82°C), cooler needs to cool the residual heat coming out of the desiccant tank prior to entering the process heater box.

- * If the dryer is a central dry air generator, it will not have a process heater box.
- * Plasticizer trap (with cooling coil) in lieu of standard aftercooler (mounts outside on back of dryer)
- * Drawer magnet, stainless steel construction.
- * Casters, two (2) fixed and two (2) swivels.
- * Machine mount adapter to accommodate a dryer and corresponding hopper.
- * Low temperature operation below 180°F (82°C), includes an internal cooler.
- * Redundant high temperature safety circuit.
- * Cart with caster with hopper mounting place.
- * Insulated air hose for air delivery.
- * Audible alarm.
- * Dew Point monitor with digital read-out.

2-5 Safety Devices and Interlocks

This section includes information on safety devices and procedures that are inherent to the Dryer. This manual is not intended to supersede or alter safety standards established by the user of this equipment. Instead, the material contained in this section is recommended to supplement these procedures in order to provide a safer working environment.

At the completion of this section, the operator and maintenance personnel will be able to do the following:

- Identify and locate specific safety devices.
- Understand the proper use of the safety devices provided.
- Describe the function of the safety device.

Safety Circuit Standards

Safety circuits used in industrial systems protect the operator and maintenance personnel from dangerous energy. They also provide a means of locking out or isolating the energy for servicing equipment.

Various agencies have contributed to the establishment of safety standards that apply to the design and manufacture of automated equipment. The Occupational Safety and Health Administration (OSHA) and the Joint Industrial Council (JIC) are just a few of the organizations that have joined with the plastics industry to develop safety standards.

Every effort has been made to incorporate these standards into the design of the drying system; however, it is the responsibility of the personnel operating and maintaining the equipment to familiarize themselves with the safety procedures and the proper use of any safety devices.

Fail Safe Operation

If a safety device or circuit should fail, the design must be such that the failure causes a "Safe" condition. As an example, a safety switch must be a normally open switch. The switch must be held closed with the device it is to protect. If the switch fails, it will go to the open condition, tripping out the safety circuit.

At no time should the safety device fail and allow the operation to continue. For example, if a safety switch is guarding a motor, and the safety switch fails, the motor should not be able to run.

Safety Device Lock-Outs

Some safety devices disconnect electrical energy from a circuit. The safety devices that are used on these dryers are primarily concerned with electrical power disconnection and the disabling of moving parts that may need to be accessed during the normal operation of the machine.

Some of the safety devices utilize a manual activator. This is the method of initiating the safety lock out. This may be in the form of a plug, lever or a handle. Within this lockable handle, there may be a location for a padlock. Personnel servicing the equipment should place a padlock in the lockout handle.

In addition to the safety devices listed above, these dryers are equipped with a line cord plug. This allows the operator or maintenance personnel to unplug the dryer from its power source and tag it out. The plug can then be tagged with any number of approved electrical lockout tags available at most electrical supply stores.

WARNING! *Always disconnect and lockout all electrical power and pneumatic (i.e. compressed air) sources prior to servicing or cleaning the dryer. Failure to do so may result in serious injury. No one but the person who installed the lockout may remove it.*



Chapter 3: Installation

3-1 Uncrating the Equipment

Dehumidifying Dryers are shipped mounted on a skid, enclosed in a plastic wrapper, and contained in a cardboard box.

1. Pry the crating away from the skid.

Note: *Remove the nails holding the box to the skid and lift the box off carefully; avoiding staples in the 1' x 4' wood supports. Cut the steel banding.*

2. Use a pry bar to remove the blocks securing the unit to the skid.
3. Lift unit from sides. Use a pry bar if necessary to carefully remove the skid from the unit.
4. Lower slowly.

3-2 Rigging and Placing the Dryer

Take care when rigging and placing the dryer. Figures 1, 2 and 3 on the following pages show a suggested safe rigging diagram. It lets you lift the dryer/hopper unit vertically for installation on the machine throat. Adjust chain lengths at the center sling bracket before you lift the unit. Your dryer has built-in lifting lugs.

Caution!



If you are mounting a machine-mount dryer with a magnet or transition adaptor on the machine throat, you must provide additional support to hold the dryer securely on the machine.

Be aware that off-center static and dynamic hopper loading can occur with machine vibration. Again, provide additional support to hold the dryer securely on the machine.

Use caution and observe safety rules when lifting and placing your dryer!

Figure 2: Suggested Lift Rigging for Cart Mount Dryers

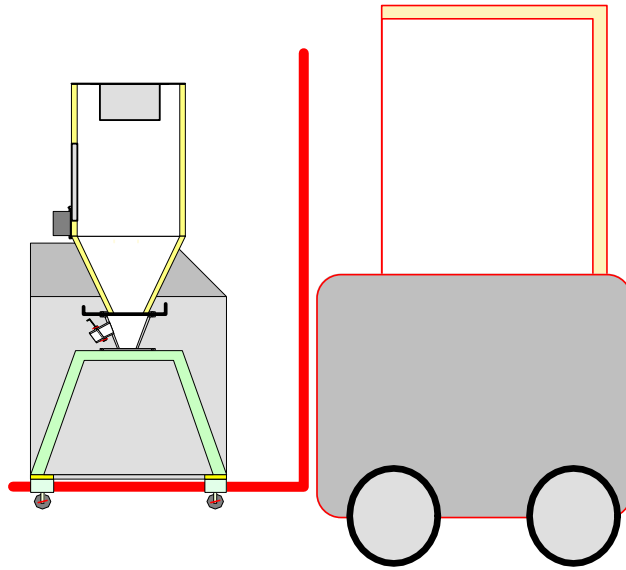

Caution! *Do not use a hoist to move or rig your Drying/Conveying System when it is mounted on a cart! Moving the unit with a hoist will cause it to become unstable and may cause damage to the equipment and/or injury to personnel!*

Figure 3: Suggested Lift Rigging for Floor Mounted Dryers

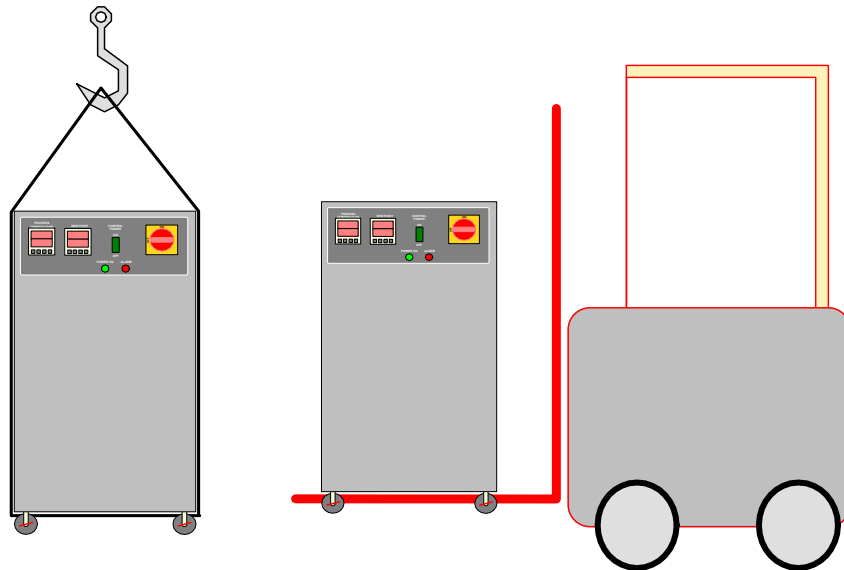

Note: *Floor Mounted Dryers can be lifted by hoist or fork lift.*

Figure 4: Suggested Lift Rigging for Machine Mounted Dryers

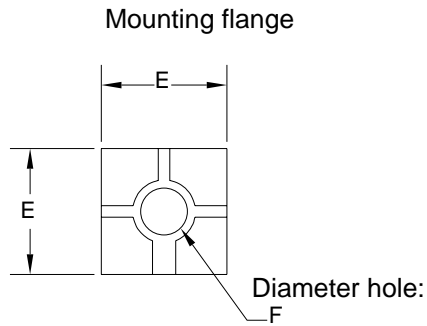
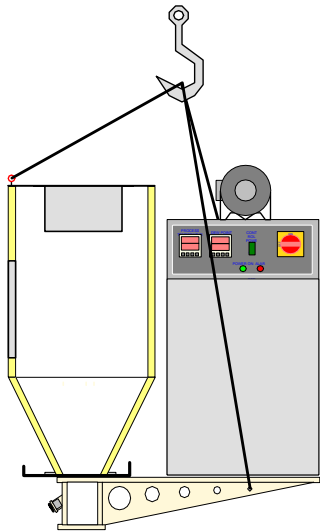

Notes: Hopper mounting flanges on 0.75 and 1.5 cu. ft. (20 & 40 liter) hoppers are supplied blank so the customer can drill to match existing machine throat.

3.0 cu. ft. (80 liter) hoppers and larger **are not supplied with a cast flange** (as shown).

Caution! *When using a hoist to move a machine mounted dryer, ALWAYS attach chains to the three (3) locations/lifting points on the unit! Moving the Dryer without the chains attached to all of the lifting points will cause the unit to become unstable and may cause damage to the Dryer and/or injury to personnel!*

3-3 Electrical Connections

When making electrical connections to your dryer, ensure that you take into consideration and make arrangements for the following:

- A qualified electrician should make all electrical connections.
- Fulfill all national, state, and local safety and electrical code requirements.
- The serial tag lists voltage, phase, and amp draw information:
 - Line voltage must be within plus or minus ten percent ($\pm 10\%$) of the voltage listed on the serial tag, or damage may occur. Phase imbalance must be less than two percent (2%).
- Connect main power to the dryer at the disconnect or terminals in the upper right corner of the control enclosure.
- Install a fused disconnect with a lockout feature in the power main leading to the dryer.
- The power drop must include a ground wire.
- Make sure all electrical connections are tight.

3-4 Setup Procedures

This section provides the procedures necessary for configuring your Dehumidifying Dryer.

Configuration of your dryer includes checking for proper blower rotation, making dryer/drying hopper process air connections and the optional aftercooler (on 15 and 30 cfm models). We recommend that you carry out these procedures in the order given here.

Note: *Before carrying out these procedures, install all equipment as described in this section.*

Checking for Proper Blower Rotation

Three-Phase Models



Caution!

In three-phase models, incorrect phasing of power leads can cause backward rotation of blower motors and CONTAMINATION OF THE DESICCANT!

Always check blower rotation before putting material in the drying hopper!

The blower is rotating properly when air flows from the delivery outlet.

Note: *Holding your hand in front of the air return will also indicate if the blower rotates in the proper direction.*

If the three-phase blower rotates improperly, reverse any two wires at the fused disconnect outside the dryer or at the disconnect/terminal in the control enclosure. This assures that the blower rotates in the proper direction.

Making Dryer/Drying Hopper Process Air Connections

Floor Mount Models

When making process air connections to your floor mounted dryer, ensure that you take into consideration and make arrangements for the following:

- Use high-temperature flexible dryer hose or rigid tubing to connect the dryer to the drying hopper.
- Keep the delivery hose to the drying hopper as short as possible to minimize heat loss. We strongly recommend insulated hose for maximum energy savings.
- Do not use insulated hose on the return from the drying hopper.
- The return air to the blower must be 150°F (66°C) or below. If the return air temperature is not below this point, you should purchase and install the optional aftercooler to remove excessive heat. Consult the manufacturer for more information. Aftercooler considerations also apply to machine-mount models.
- Make sure that hoses are not kinked or collapsed.
- Drying hopper air inlet and outlet locations vary, but always connect hoses so the dry process air from the dryer enters the bottom of the drying hopper and flows out the top to return to the dryer inlet.
- Thermocouple is to be installed at drying hopper's delivery tube.

Drying Hopper Air Trap Considerations

Our exclusive air trap assembly on the top of the drying hopper prevents ambient air from contaminating the material being dried. To ensure that your unit will operate at peak efficiency, do the following:

- Keep the material level at the mid point of the air trap

This can be achieved by utilizing a hopper loader or vacuum conveying system to supply material to the drying system.

Optional Aftercooler

Water-cooled 15 and 30 cfm models use a water-to-air heat exchanger as an aftercooler. Cooling water is required for this design (3 gpm at 85°F or lower). Return air from the hopper passes through the air filter to trap fines and dust before entering the heat exchanger.

Installing Water Lines

(Hose and Hose Clamp)

When installing the water lines, ensure that the aftercooler utilizes either tower, chilled or city water up to 85°F (29°C). Recommended flow rate is three (3 gpm) gallons per minute (11 liters per minute).

3-5 Initial Start-up

Pre-Startup Checks

- Check the process and return hoses for tight connections.
- Check all companion equipment, such as the drying hopper; verify that the loading system is ready for operation.
- Verify that all dryer electrical connections are tight.

Caution! *Clean the rust-preventing oil from inside the drying hopper.*

Failure to clean the hopper fouls the desiccant and voids your warranty!

- Verify that the dryer's thermocouple is properly connected in the center of the drying hopper's delivery tube.
- Verify that the temperature control has been configured for your specified scale (°F or °C).

Starting Up the Dryer

1. Turn on (energize) the disconnect switch in your power drop, then turn on the disconnect switch on the dryer (3 phase only).
2. Turn the system **ON/OFF** switch to **ON** to start the dryer.
3. Close the slidegate at the bottom of the drying hopper.
Make sure that the blowers turn in the right direction.
4. Fill the drying hopper with material. Dryer performance is compromised if hopper is not full!
5. If your dryer has a water-cooled aftercooler, make sure that sufficient cooling water (3gpm at 85°F or lower) flows properly through the coil and that you have bled any

trapped air from the system. Make sure the aftercooler has the proper supply water temperature.

6. Set the process set point on the temperature controller.
7. After the proper pre-drying time for the initial hopper fill has elapsed, fully open the drying hopper slide gate.

Note: *To allow proper residence time during continuous processing, maintain the material level in the hopper at the midpoint of the air trap assembly.*

Auto-Tuning the Dryer

1. For Auto-tuning, press the Level Key once. The **AT** screen will show with the setting **OFF**.
2. Press UP arrow to change the setting to **ON**.
3. Press the Level Key again to the Temperature Screen. Your actual temperature will start to flash for about 10-20 minutes with the temperature fluctuating up and down during that period. After the flashing stops, it means auto-tuning has finished.

Shutting Down the Dryer

1. Turn off the conveying system supplying the drying hopper.
2. When processing is complete, close the hopper slide gate and shut down any in-line companion equipment, such as the aftercooler.
3. Turn the Dryer **ON/OFF** selector switch to **OFF**.
4. Turn the system **ON/OFF** switch to **OFF**.
5. If needed, empty the drying hopper.
6. For maintenance or a long term shutdown, open (de-energize) the electrical disconnects at the dryer and at the power drop.

Chapter 4: Operation

4-1 Controller Description and Operation

Identifying Control Panel Indicator Lights and Switches for the Standard Controller

Switches

Main Power. This switch allows the dryer to receive power from the main power supply (3 phase only).

Dryer Control ON/OFF Switch. This switch energizes or de-energizes control power to the indicator panel and starts the dryer. (The controller cannot be energized without the dryer running.)

Indicator Lights

Alarm Light. This feature warns the operator of a high bed safety temperature, a regeneration heater fault, or a blower failure.

Power On. This light illuminates when the main power switch is on telling the user the dryer is energized.

Dryer Operating: Indicates the process air blower is on.

Figure 5: Dryer Control Panels

Standard Controller – Standard Single Phase Control Panel shown with Optional Dew Point Monitor



Optional Controller – Optional Three Phase Control Panel shown with Optional Dew Point Monitor



Process Air Temperature Controller

Our dryers use a microprocessor-based PID temperature controller for maintaining process air temperature. The controller is a modular, self-contained unit you can remove from the mounting housing. All parameters except for the process air set point are factory set and adjusted; normally, no field adjustment to the internal controls is necessary.

Figure 6: Typical Process Air Temperature Controller

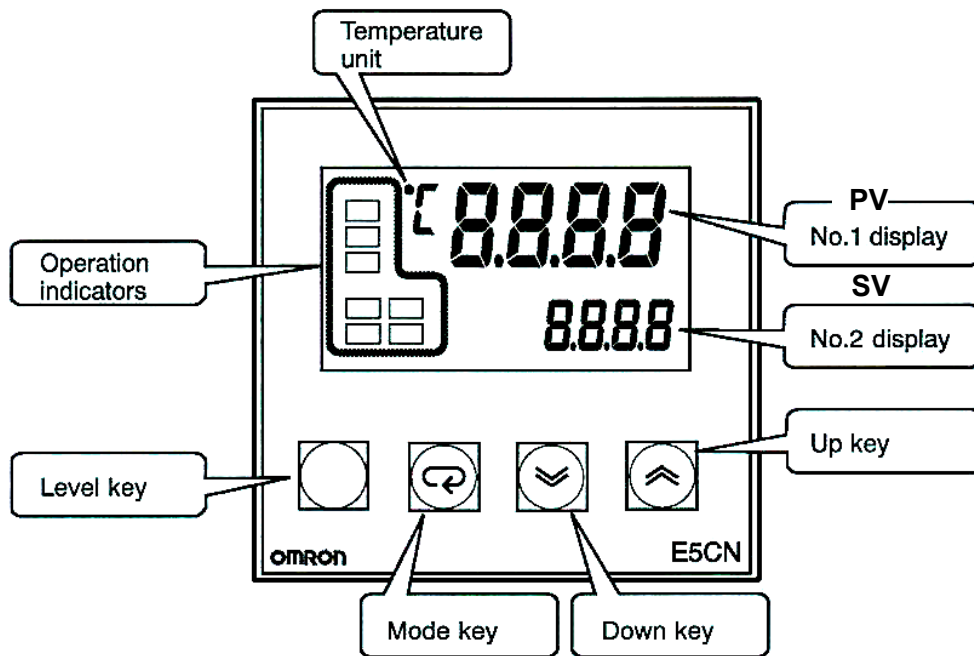

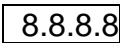
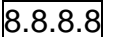

Identifying Process Air Temperature Controller LED Indicators

Indicator	Name	Description
PV 	Process Value Numeric LED	During normal operation, the process value (PV) numeric LED indicator displays the process temperature at the To Process thermocouple. It also lists parameters during setup and error messages if any errors occur.
SV 	Set Value Numeric LED	During normal operation, the set value (SV) numeric LED indicator displays the process set point temperature selected for the dryer. The dryer then maintains this set point temperature. This LED indicator also displays parameter and pre-set function values during configuration setup.
OUT1	Out 1 LED	Lit when Control Output 1 is on. The Out1 indicator lights when the controller signals the process heaters to be energized.
OUT2	Out 2 LED	Lit when Control Output 2 is on. Not used in this application.
AT	AT LED	Flashes during auto-tuning in process value (PV) screen.

Indicator	Name	Description
ALARM1	ALARM 1 LED	Lights in the Operation Indicator Section when the output function assigned to auxiliary output 1 turns on. The ALARM1 indicator lights when the process temperature exceeds the set point temperature by more than the alarm deviation value.



Identifying Temperature Controller Keys

Indicator	Name	Description
	Mode Key	Press the Mode key to shift the display to the next set of parameters. The menu screen displays.
	Down Key	Press the Down arrow key to lower the process air set point temperature. During setup, it lets you decrease the value of the parameter displayed on the set point LED readout.
	Up Key	Press the Up arrow key to raise the process air set point temperature. During setup, it lets you increase the value of the parameter displayed on the set point LED readout.

Setting the Process Air Temperature

When setting the process air temperature, consult with the resin manufacture for the recommended drying temperature.

To change the process air temperature set point with the dryer running:

- Press  to raise the set point to the temperature you want.
- Press  to lower the set point to the temperature you want.

Restoring the Process Air Temperature Controller (E5CN) to Factory Settings

If the preset parameters on the controller have been tampered with and it no longer properly controls temperature, you can restore the controllers to the factory setup. *Call the Service Department for detailed instructions.*

E5CN Operating Parameters

The E5CN controller has several mode selections. Within each mode are numerous parameters that can be set.



The factory has set the security level to protect the critical parameters from being accidentally changed. Below is an explanation of the operating modes you will have access to and on the following page are the manufacturers' default settings.

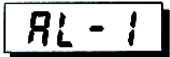

Available E5CN Modes

Operation Level

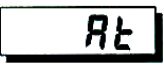
Indicator	Name	Description
	Run/Stop Mode (r-S)	When "RUN" is selected, the control is running. When "STOP" is selected, the control is stopped. When the control is stopped, the STOP display lights. The default is set to "RUN."
	Alarm Value 1 Mode (AL-1) (35°F)	This setting is used to indicate how many degrees the process temperature will be allowed to exceed the set point temperature. An alarm output will de-energize the heaters and blower.

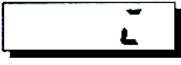

Adjustment Level

Indicator	Name	Description
	Auto-Tune Mode (At)	See Page 19 of Chapter 3 for instructions on how to Auto-Tune your dryer. Note: <i>Although the controller is calibrated at the factory, the manufacturer recommends that the unit be Auto-Tuned prior to dryer startup.</i>
	Temperature Input Shift Mode (TnS)	This setting is used to offset an error between the set point and the actual temperature. The entire input range is shifted by a set figure

Indicator	Name	Description
		preprogrammed by the operator.
	Proportional Band Mode (P)	This setting controls the amount in which the manipulated variable (MV) is proportionate to the deviated value or controller error.
	Integral Time Mode (I)	Setting this feature, gives the control an action that is proportionate to the time integral of the control error. By using this setting, proportional action is used in combination with integral action to offset the control error and the set point will begin to match the control temperature (PV or process value).
	Derivative Time Mode (d)	Setting the derivative control provides the controller with the ability to correct for a future error in the previously set process output.

Entering Operating Parameters to Select Modes

To enter the display:

1. Press the  Mode Display key to view the Run/Stop & Alarm 1 Modes.
2. Press  and  to set the higher or lower the values of the parameter or turn that function On or Off.

The **SV** readout displays the different values for the parameter within a mode.

3. To switch modes within a level, press and hold the  Level Display key for one (1) second.

The **PV** readout will display the different parameters within each mode.

4. Use short presses on the  Mode Display key to display each parameter within a mode.

The **SV** readout displays the different values for the parameter within a mode.



5. Press  and  to set the higher or lower the values of a parameter or turn that function On or Off.
6. Press  Level Key once to return to the Process Temperature Setting.

Figure 7: Settings for Process Temperature Controller (E5CN), Part No. A0567917

Mode	Parameter	Setting range	Default	Manuf. setting
Operation	Run/Stop	Run/Stop	Run	-
	Alarm value 1	-1999 to 9999	0	25

Mode	Parameter	Setting range	Default	Manuf. setting
Adjustment	AT execute/cancel	ON, OFF	OFF	Various
	Temperature input shift	-199.9 to 999.9	0.0	-
	Proportional Band	0.1 to 999.9	8.0	Various
	Integral Time	0 to 3999	233	Various
	Derivative Time	0 to 3999	40	Various

**Process Air Dew Point Display
Optional**

The Process Air Dew Point meter indicates the current process air delivery moisture content. Standard dryers use a microprocessor-based controller for displaying dew point air temperature. The controller is a modular, self-contained unit removable from the mounting housing. All parameters are factory set and adjusted; normally, no field adjustment to the internal controls are necessary.

Figure 8: Typical Dew Point Display Monitor – Part No. A0555757

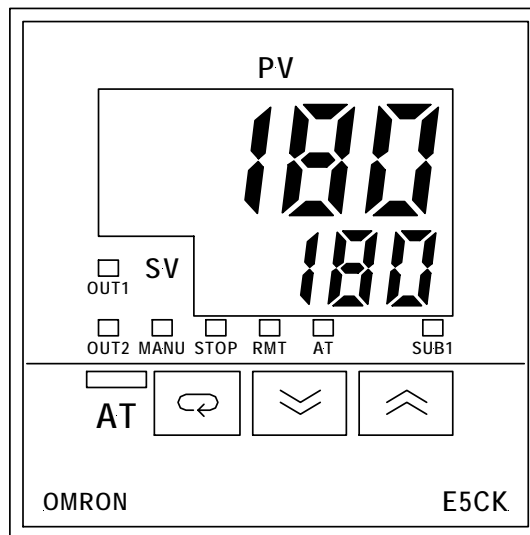

Note: No field adjustment is required. The dew point meter is meant for moisture indication only!

Setting the High Dew Point Alarm

The high dew point alarm setting is changed by pressing the up and down keys to input the alarm value. The factory setting for Alarm Value 1 (**AL-1**) is -10°F (-23°C).

Restoring the Process Air Dew Point Meter (E5CK) to Factory Setup

If the preset parameters on the controller have been tampered with and it no longer functions properly, call the Service Department. **This controller is not meant to be modified.**

Note: The dew point alarm monitors and indicates a deviation from the set point.

4-2 Dryer Operation Procedures

Controller Operation

1. Turn the disconnect (if applicable) on the control panel to the **ON** position. Power is applied to the voltage line fuses, line side of the control power switch.
2. Turn the control power switch to the **ON** position. Power is applied to the temperature control, programmable relay and dew point controller. The valve will move to the start position as follows:
 - a. The valve motor rotates until the cam switch makes 2 transitions.
 - b. If the cam switch does not make a transition within 10 seconds, a valve motor fault is generated. “**VALVE MTR**” is displayed on the relay screen, the alarm light is activated. The valve motor, heaters, and blower shut off.

To restart the dryer, cycle control power to deactivate the alarm light and restart the valve motor sequence.

Note: The relay screen which contains the Alarm Display Messages is located inside the controller enclosure. For a list of Alarm Display Messages, see Page 32.

WARNING!



Do not attempt to check the Alarms on the Controller located within the unit enclosure unless you are a qualified electrician!

- c. The valve will normally complete one full cycle (revolution).

If the drying process shuts down due to an alarm, the dryer has been setup to have the following operational features:

 - The bed in process at power-down will remain in process.
 - The bed in regeneration at power-down will remain in regeneration.
 - The regeneration timing cycle will restart from the beginning.
3. Once the control power is on and no fault conditions exist, the dryer will start as follows:
 - a. The process/regen blower is started.
 - b. The process heater is turned on and controlled by the E5CN controller.
 - c. The regen heater is turned on and the regeneration timing sequence is initiated. For default timing settings for regeneration, see the table below.

Model	Heating	Cooling
15 cfm	15	50
30 cfm		
60 cfm	15	50

4. If either the left or right bed safety temperature switch opens, a regen heater fault is generated. **“HIGH TEMP”** is displayed on the relay screen. The alarm light is activated.
5. If the process temperature controller faults or the process heater safety switch opens, a heater fault is generated. **“HIGH TEMP”** is displayed on the relay screen. The alarm light is activated. The process heater, regen heater, and process/regen blower are turned off. (Requires turning the dryer OFF).
6. If the process blower overloads trips, a process blower fault is generated. **“PROC BLWR”** is displayed on the relay screen. The alarm light is activated. The process heater, regen heater, and process/regen blower are turned off (3 phase only).
7. The valve position limit switch enables the right bed heater and provides an input signal to the programmable relay when actuated by the cam lobe. When the cam verifies position is high, the right bed is activated. When the cam verifies position is low, the left bed is activated. Each heater is ON-OFF controlled.
8. Upon completion of the HEAT portion of the regeneration sequence, the regen heaters are disabled by the programmable relay and the COOL time begins.
9. Once the Cool time has expired, the valve motor is turned on until the cam switch makes a transition. Upon making a transition, the timing sequence is restarted for the new bed.
10. When no fault conditions exist, the display reads **“SYSTEM NORMAL”**.
11. The top 2 lines of the display show the HEAT and COOL times (in minutes) for the regeneration sequence. Changes to these times can be made by the operator as follows:
 - a. Press the up or down arrow until the cursor is positioned at the number to be changed.
 - b. Press the “+” key to increment the number, or the “-“ key to decrement the number.
 - c. Press the “OK” key to accept the value and write to the relay memory.

OR

 - d. Press the “ESC” key to cancel the changes.

Note: *A change will NOT take effect until step 12-c is done.*

12. The dryer is shut off by turning the control power switch to the OFF position.
13. Refer to Schematic drawing enclosed in the control enclosure.

Alarm Display Messages

Note: *The relay screen which contains the Alarm Display Messages is located inside the controller enclosure.*

WARNING!



Do not attempt to check the Alarms on the Controller located within the unit enclosure unless you are a qualified electrician!

The following is a list of Alarm Display Messages which can be found on the relay screen:

**Temperature Controller Alarm and/or
Regen Heater Temp Switch and/or
Process Heater Temp Switch and/or
Redundant Temp Safety**

HIGH TEMP

Valve Motor Time-Out

VALVE MTR

Blower Overload

PROC BLWR

No Alarms

**HEAT 15
COOL 50
SYSTEM
NORMAL**

Chapter 5: Maintenance

5-1 Preventative Maintenance Schedule

The checklist below contains a list of items which should be inspected and/or replaced to keep your Portable Drying/Conveying System operating at peak efficiency. Perform each inspection at the regular intervals listed below.

System model #						Serial #							
Every Day	Date/By	Date/By	Date/By	Date/By	Date/By	Date/By	Date/By	Date/By	Date/By	Date/By	Date/By	Date/By	Date/By
Inspect all filters for wear, replace/clean if dirty or worn.													

Every week	Date/By	Date/By	Date/By	Date/By	Date/By	Date/By	Date/By	Date/By	Date/By	Date/By	Date/By	Date/By
Check to make sure that all hose connections are air tight.												

Every month	Jan	Feb	Mar	Apr	May	Jun	Jul	Aug	Sep	Oct	Nov	Dec
Lock out electrical power and inspect electrical wiring for integrity.												
Lock out electrical power and check heater elements for continuity using an ohmmeter.												
Check dew point and temperature tracking with an external dew point monitor and pyrometer.												
Visually inspect the shifting of the airflow valve during one cycle.												

Every year	Next scheduled inspection	Actual inspection Date/By	Next scheduled inspection	Actual inspection Date/By
Inspect desiccant. Replace if brown or broken.				

Every two years	Scheduled replacement date	Actual replacement Date/Work done by	Scheduled replacement date	Actual replacement Date/Work done by
Replace desiccant.				

- Photocopy this page for your maintenance records -

5-2 Preventative Maintenance

This section describes maintenance procedures which will increase the longevity and efficiency of your dehumidifying dryer. Perform them at the regular intervals listed on the dryer checklist on the previous page.

Servicing Process Air Filters

Caution! *Operating the dryer without the process air filter installed voids your warranty!*

Filter cleaning is an important part of your dryer maintenance program.

Dehumidifying dryers have a single cartridge canister-type filter in the process air loop. The filter protects blowers from plastic fines drawn in from the drying hopper and prevents the desiccant from being contaminated. Regular filter cleaning is essential to keep your dryer operating at peak efficiency.

You can blow or vacuum the dirt out of the filter with compressed air, but remember, it could become damaged from high-pressure blowing.

Recommendations for Cleaning and Replacing Filters

- Turn off and/or lock out electrical power to the dryer.
- Remove the threaded fastener securing the filter access cover, then remove the cover.
- Remove the nut on the center retaining rod to remove the filter cartridge.

Figure 9: Air Filter Location and Disassembly

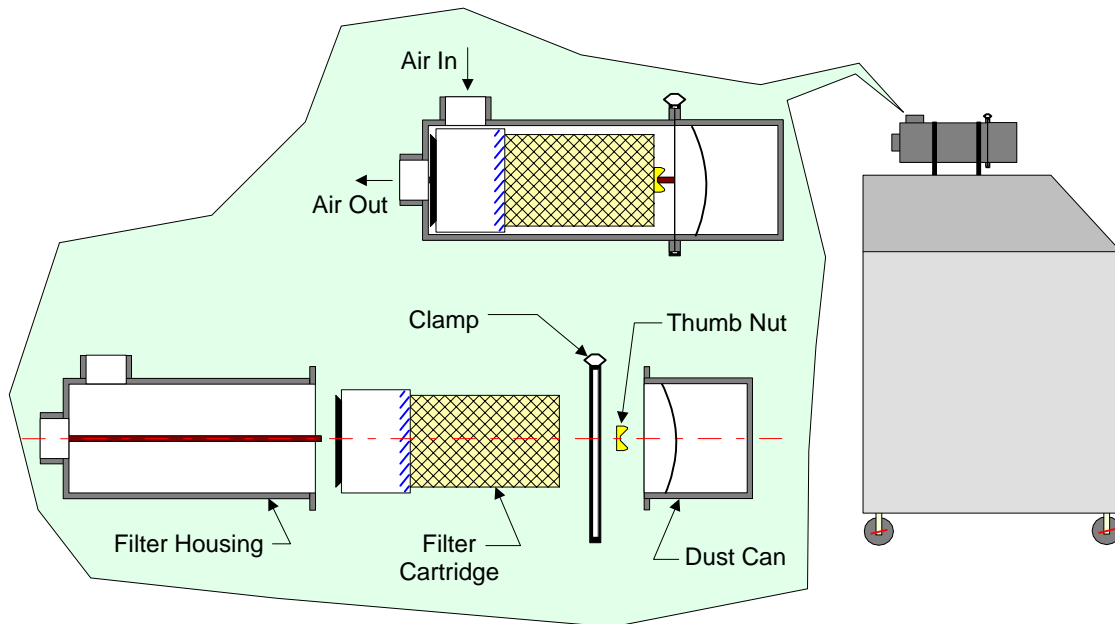

Vacuuming

Try vacuum-cleaning a soiled filter first. Vacuuming removes most large particles and surface contaminants, and may suffice for the first time you clean a filter. Use a commercial-duty (recommended) or household vacuum cleaner. Vacuum the filter from the air intake (dirty) side only.

Cleaning with Compressed Air

Blow clean, dry compressed air up and down the pleats, blowing out the filter from the inside out. Remove loose dirt from the filter with compressed air or vacuum from the outside.



Caution! *DO NOT clean/wash filter with water!*

After each cleaning:

- Inspect the filter element. *Briefly* hold a light bulb behind the element and look for any **fatigued paper** or residual dirt. Inspect for holes and tears by looking through the filter toward a bright light. Check for damaged gaskets or dented metal parts. Do not re-use a damaged filter!
- Check the gasket for damage. A damaged gasket allows contaminants into the process. Replace as needed.

Servicing the Dew Point Monitor

The accuracy of the dew point monitor on mini dryer systems depends on proper operation of the dew point sensor and the control board. The dew point sensor is in the process air stream and is therefore susceptible to contamination.

Dew point sensor life depends on:

- Air temperature and flow passing over the sensor.
- The amount of fines (dust) in the process air.
- The amount of plasticizer vapor in the process air.

Once every six months, the dryer operator should monitor the initial dew point sensor readings and establish a periodic replacement schedule as needed.

Caution! *Do not attempt to check the continuity or resistance of the dew point sensor.*



5-3 Corrective Maintenance

This section provides you with the information necessary to correct or repair any issues which might appear during the normal operation of your dehumidifying dryer. Although we have listed how to perform these procedures, it is recommended that you call the Service Department to have any in-depth maintenance performed.

Symptoms of Worn Desiccant

The moisture absorption capacity of the desiccant used in your dehumidifying dryer degrades after an indefinite period of time. Useful life depends on variables such as the condition of the process filter, how much dust and fines have been passed through the filter and got into the desiccant chamber, and plasticizer vapors in the return air.

WARNING! Handling desiccant material is **HAZARDOUS**.



Wear an N-100 type safety filter mask or equivalent to avoid prolonged breathing of desiccant dust. Wear safety goggles and gloves to avoid contact with eyes and skin.

- *Handle with adequate ventilation.*
- *Wash hands thoroughly after handling.*

+ FIRST AID +

In case of eye contact, immediately flush eyes with plenty of water for at least 15 minutes.

SEE A PHYSICIAN IMMEDIATELY IF IRRITATION PERSISTS.

Replacing Worn Desiccant

Caution! *DESICCANT BEDS ARE HOT DURING OPERATION.*



To avoid burn hazard, make sure desiccant beds are sufficiently cool before replacing worn desiccant.

To access the Desiccant Bed:

1. Disconnect electrical power to the dryer.
2. Using a 1/8" Allen wrench, remove the 10-24 button head screws holding the top, back and side panels to the frame and back of the dryer.
3. Disconnect the three (3) plugs for the valve motor, switch, and blower (15 cfm only)
4. Remove four (4) nuts at each corner of the top casting.
5. Disconnect all hoses and dew point air lines.
6. Pickup and place the top casting in a safe place.
7. Using a 1/8" Allen wrench, remove the four (4) 10-32 button screws holding the desiccant cover to the canister.
8. Remove the cover.
9. Pickup the desiccant can and turn it upside down over an empty container to remove all desiccant.
10. Dispose of properly using MSDS sheet.

Figure 10: Desiccant Bed Location and Disassembly

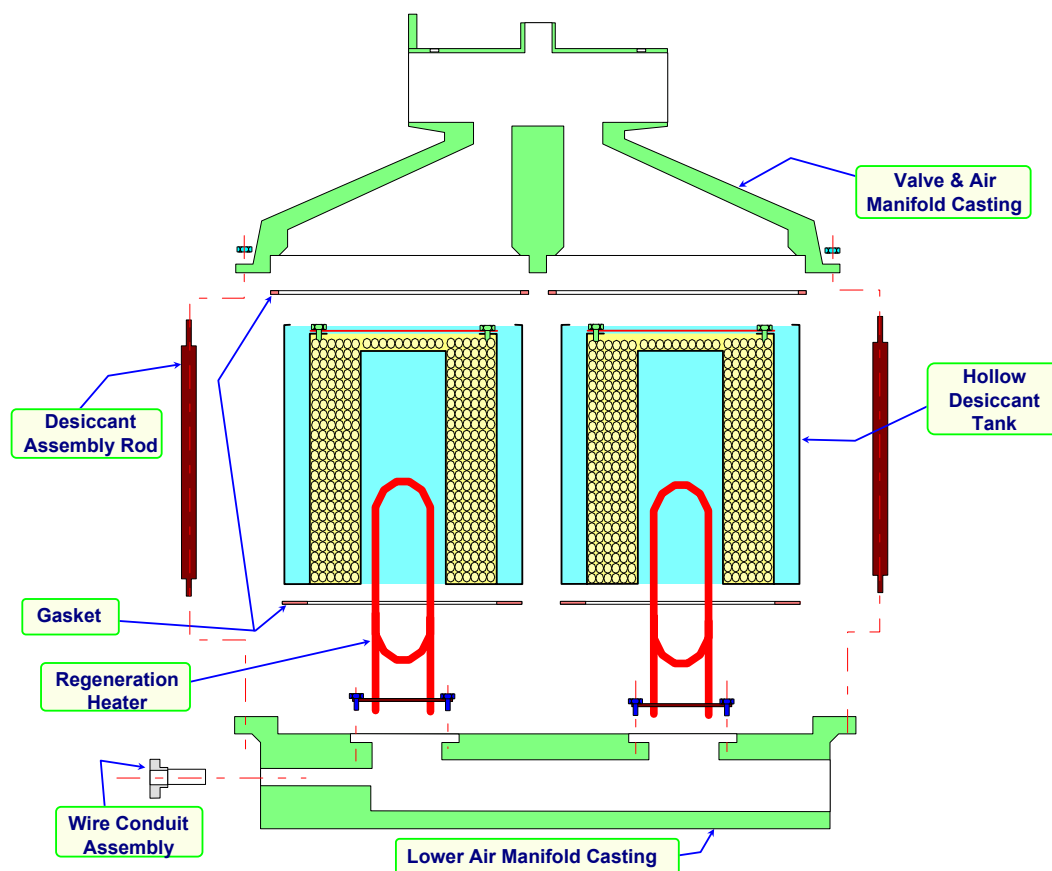

Caution! *You should properly dispose of any discarded desiccant. Consult local disposal regulations for more information.*

11. Inspect each desiccant screen for tears or holes where desiccant burned-through. Replace desiccant can if needed.
12. After cleaning each chamber add the full amount of bead desiccant specified per bed. Amounts are listed in the Desiccant Amounts Table below. Tap on side of tank to settle desiccant. Smooth the top level, and finally add another layer of the remaining bead desiccant to the top. Make sure this layer is level and smooth.
13. Repeat the previous step for the other bed.
14. Inspect the gaskets. Replace if necessary.
15. Re-install all components and reconnect all of the wiring and hoses.

Figure 11: Required Desiccant Amounts (13X Type)

Dryer Model	8 x 12 bead Total		
	Part no.	lbs.	Kg
15	W00018051	6.5	2.9
30		9.7	4.4
60		13.5	6.1

Replacing the Process/Regeneration Heater

The dehumidifying dryers utilize a single-phase Calrod-type heater element. This heater element is mounted in the center compartment in the desiccant beds. Although the replacement procedure is the same for each heater, the wattage varies by model, voltage, temperature range, etc.

WARNING! *Hazardous electrical current present.*



Disconnect and lock out power before you replace heater elements!

Figure 12: Process/Regeneration Heater Location and Disassembly

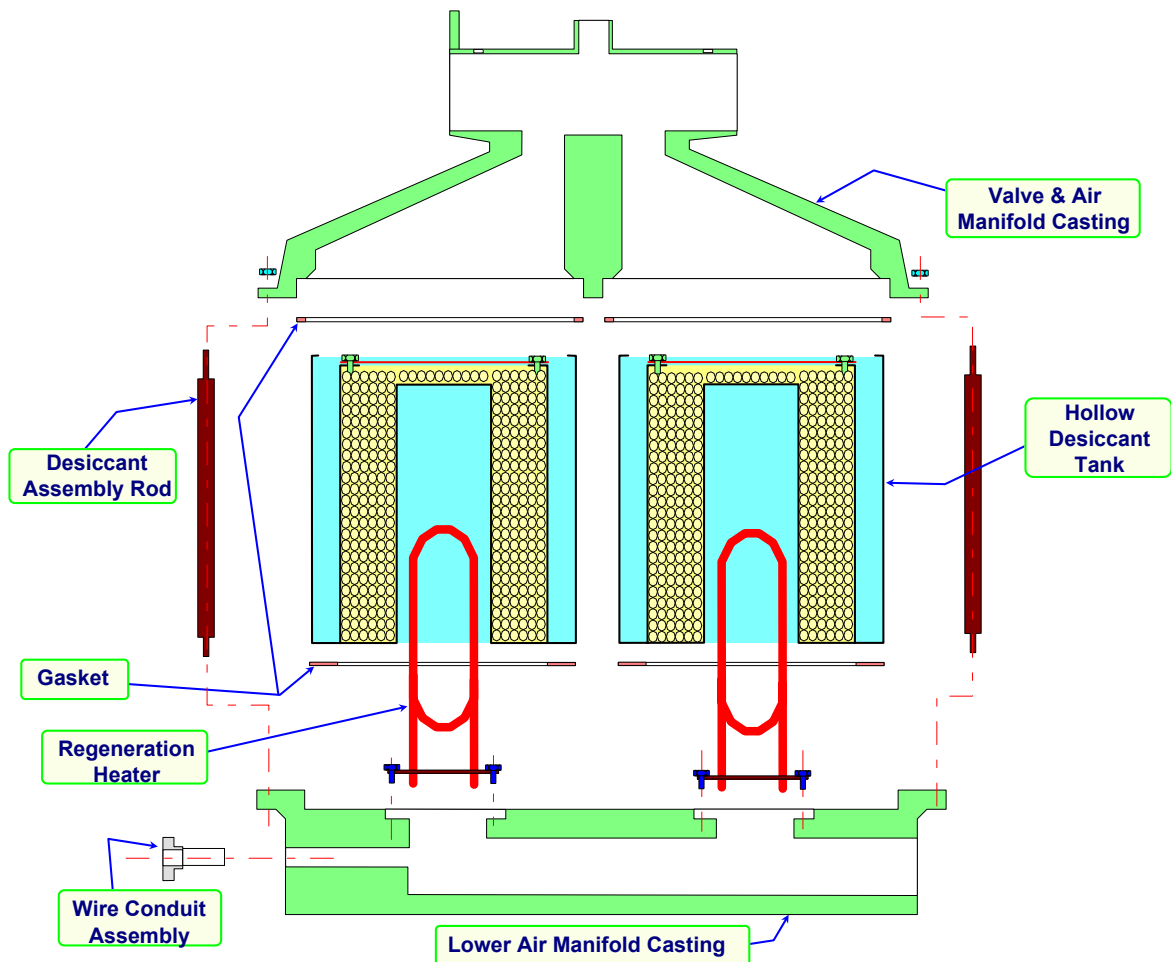

Procedures

1. Disconnect electrical power to the dryer.
2. Using a 1/8" Allen wrench, remove the 10-24 button head screws holding the top, back and side panels to the dryer frame.
3. Disconnect the plug for the valve motor, valve switch, and blower (15 only).
4. Remove the four (4) nuts at each corner of the top casting.

5. Disconnect heater thermostat safety.
6. Pickup and place the top casting in a safe place.
7. Pickup the desiccant can to reveal the heater.
8. Using a 1/8" Allen wrench, remove the four (4) 10-32 screws on the heater plate.
9. Remove the wires to the heater plate assembly being removed or replaced.
10. Remove the two (2) 4-40 screws for the temperature switch.
11. Inspect temperature switch with voltmeter. (Normally closed, ohms). Replace if faulty.
12. Re-install the heater and heater plate assemblies in reverse order. Install new heater gaskets and securely tighten all fasteners.

Caution! *Heater loops should not touch each other.
"Hot spots" lead to premature heater failure!*

Replacing/Cleaning the Cooling Coil

Figure 13: Cooling Coil Location and Disassembly

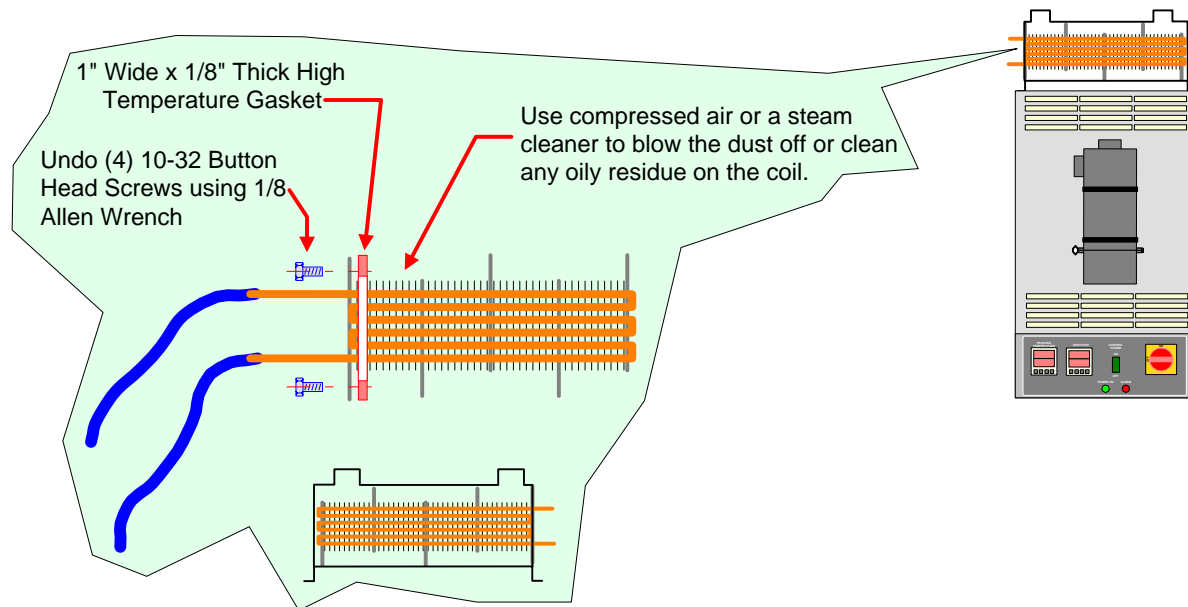

To clean the cooling coil, use compressed air or a steam cleaner to blow the dust off or clean any oily residue on the coil.

Water flow requirement:

If used as an after-Cooler: 3 to 4 GPM @ 85°F.

If used as a Plasticizer trap: 3 to 4 GPM @ 40°F to 45°F.

Replacement Procedures

1. Shut down the dryer, tag out and lock out the controls if necessary.
2. Shut the water off to the cooling coil.
3. Remove the four 10-32 bolts.
4. Gently slide the cooling coil out.

5. Visually inspect the coil for leaks, dirt, and any sign of volatiles.
6. Blow the dust out, or if the coil is covered with plasticizer, steam clean it.
7. Place the coil back in its housing. Make sure the gasket is OK, replace if necessary.
8. Inset the four 10-32 bolts back in place.
9. Turn the water to the cooling coil back on.

Chapter 6: Troubleshooting

6-1 Introduction

The utmost in safety precautions should be observed at all times when working on or around the machine and the electrical components. All normal trouble-shooting must be accomplished with the power off, line fuses removed, and with the machine tagged as out of service.

The use of good quality test equipment cannot be over-emphasized when troubleshooting is indicated. Use a good ammeter that can measure at least twice the AC and DC current that can be encountered for the machine. Be sure that the voltmeter has at least minimum impedance of 5,000 OHMS-per-volt on AC and 20,000 OHMS-per-volt on DC scales. Popular combination meters, VOM and VTVM can be selected to provide the necessary functions.

Before making haphazard substitutions and repairs when defective electrical components are malfunctioning, we recommend that you check the associated circuitry and assemblies for other defective devices. It is common to replace the obviously damaged component without actually locating the real cause of the trouble. Such hasty substitutions will only destroy the new component. Refer to wiring diagrams and schematics.

Locating mechanical problems, should they occur, is relatively straightforward. When necessary, refer to the parts catalog section.

Alarm Message	Cause	Corrective Action	Dryer Status
HIGH TEMP	The process temperature has exceeded the alarm set point.	Make sure the process filter is clean. Clean or replace if necessary.	<ul style="list-style-type: none"> - Dryer Shuts down: - Process blower OFF. - Process heaters OFF. - Regen heaters OFF. - Alarm light is ON - Alarm horn is ON.
	The high temperature snap switch of the process heater box has tripped.	Double check the alarm set point. Check the positioning of the thermocouple inside the air inlet of the drying hopper.	
	The high temperature snap switch on of the regeneration heater boxes has tripped	The tip of the thermocouple should be centered to the tube, and not touching any metal part of the tube.	
		The drying temperature set point is lower than dryer capabilities. Check the dryer specs.	
		Make sure all the hose connections are tight.	
		Make sure the regeneration timing cycle matches the specs. If not contact Service department.	

Alarm Message	Cause	Corrective Action	Dryer Status
HIGH TEMP	The process temperature has exceeded the alarm set point.	The process heater contactor has failed in the closed position. Check heater contactor, replace if necessary.	<ul style="list-style-type: none"> - Dryer Shuts down: - Process blower OFF. - Process heaters OFF. - Regen heaters OFF. - Alarm light is ON - Alarm horn is ON.
	The high temperature snap switch of the process heater box has tripped.	Check the Process Heater box high temperature snap switch, replace if necessary	
	The high temperature snap switch on of the regeneration heater boxes has tripped	The Regeneration heater contactor has failed in the closed position. Check heater contactor, replace if necessary.	
		Check the high temperature snap switches on the regeneration heater mounting plates, replace if necessary.	
PROC BLWR	The process blower pressure switch did not detect enough pressure. Process blower overload has tripped. Process blower motor has failed.	Make sure the process air filter is clean. Clean or replace if necessary.	
		Check the rotation of the blower.	
		Check the pressure switch hose connection. Replace hoses or the pressure switch.	
		Check the over load rating against the wiring diagram. Adjust accordingly.	
		Check the wiring of the blower. Make sure it is wired for the proper voltage.	
		Check the process blower fuses for any fault. Replace if necessary.	
		Check the blower motor starter. Replace if necessary.	
		Check the blower motor. Replace if necessary.	
		Check the incoming voltage against the name plate of the dryer.	

Alarm Message	Cause	Corrective Action	Dryer Status
VALVE MTR	The limit switch on the valve may not have been wired correctly. The valve has made enough rotations and the correct position of the valve was not detected.	Limit switch may be out of position. Re-adjust the switch to make sure it trips when it is at the high position, and it does not touch the cam when it is at the low position.	<ul style="list-style-type: none"> - Dryer Shuts down: - Process blower OFF. - Process heaters OFF. - Regen heaters OFF. - Alarm light is ON - Alarm horn is ON.
		<p>The switch is indicating the incorrect desiccant tank is in regeneration. Check the wiring of the switch against the wiring diagram. Make sure all the wire connections are tight.</p> <p>Limit switch may be faulty. Replace the switch and make sure the wires are connected correctly.</p>	

6-2 Determining Temperature Controller Errors or Sensor Errors

Using a Thermocouple

If the controller displays a temperature that is close to room temperature (70°F/21°C) when you short-circuit controller input terminals, the controller is normal and the sensor is probably broken, short-circuited, or incorrectly wired.

Other service problems or questions can be answered by contacting the Service Department.

Chapter 7: Appendix

7-1 Warranty

Unless otherwise specified, this product includes a Standard ONE YEAR PARTS WARRANTY.

Warranty Specifications

The manufacturer hereby expressly warrants all equipment manufactured by it to be free from defects in workmanship and material when used under recommended conditions, as set forth in the operating manuals for such equipment. THE FOREGOING EXPRESS WARRANTY IS EXCLUSIVE AND IN LIEU OF ALL OTHER WARRANTIES, GUARANTEES, AGREEMENTS, AND SIMILAR OBLIGATIONS OF THE COMPANY AND/OR MANUFACTURER (UNLESS OTHERWISE SPECIFIED IN THE SPECIFIC PRICE PAGE OR LIMITED BY THE MANUFACTURERS' WARRANTY FOR PARTS). The Company's obligation is limited to repair or replace FOB the factory any parts that are returned, prepaid, within one year of equipment shipment to the original purchaser, and which in the Company's opinion, are defective. Any replacement part assumes the unused portion of this warranty.

Warranty Restrictions

This parts warranty does not cover any labor charges for replacement of parts, adjustment repairs, or any other work. This warranty does not apply to any equipment which, in the Company's opinion, has been subjected to misuse, negligence, or operation in excess of recommended limits, including freezing or which has been repaired or altered without the Company's express authorization. If the serial number has been defaced or removed from the component, the warranty on that component is void. Defective parts become the property of the warrantor and are to be returned immediately, without any further use or handling.

Warranty Liabilities

THE COMPANY EXPRESSLY DISCLAIMS ANY AND ALL LIABILITY FOR ANY SPECIAL, CONSEQUENTIAL OR INCIDENTAL DAMAGES OR EXPENSES THAT RESULT FROM THE USE OF THIS PRODUCT. Some states do not allow the exclusion or limitation of special, consequential or incidental damages, so the above limitation may not apply to you. The Company's obligation for parts not furnished as components of its manufactured equipment is limited to the warranty of the manufacturers of said parts. The company neither assumes nor authorizes any other persons to assume for it any liability in connection with the sale of its equipment not expressed in this warranty. No person, agent, manufacturer, distributor, dealer, installer or company is authorized to change, modify or extend the terms of this warranty in any manner whatsoever.

The time within which an action must be commenced to enforce any obligation of the Company's arising under this warranty, or under any statute or law of the United States or any state thereof, is hereby limited to the duration of this warranty. Some states do not permit this limitation, so the above may not apply to you. This warranty gives you specific legal rights and you may also have other rights which vary from state to state. For transactions involving the potential applicability of international law or that of a foreign country, this warranty policy and the procedures hereunder shall be governed by

applicable federal and state law, but not by the United Nations Convention on Contracts for the Sale of Goods.

Customer Responsibilities

Any sales, use, or other tax incident to the replacement of parts under this warranty is the responsibility of the purchaser.

7-2 Technical Specifications

Annex B Information

The following design information is provided for your reference:

1. No modifications are allowed to this equipment that could alter the CE compliance
2. Ambient temperature: 0 degrees Celsius – Maximum (104 degrees Fahrenheit)
3. Humidity range: 50% relative humidity
4. Altitude: Sea level
5. Environment: Clean, dust-free and non-explosive
6. Radiation: None
7. Vibration: Minimal, i.e. machine mounting
8. Allowable voltage fluctuation: +/- 10%
9. Allowable frequency fluctuation: Continuous +/- 1%
Intermittent +/- 2%
10. Nominal supply voltage: 460/3/60 (Verify on serial number tag)
11. Earth ground type: TN (system has one point directly earthed through a protective conductor)
12. Power supply should include a ground connection.
13. Over-current protection is supplied in the dryer, but additional protection should be supplied by the user.
14. The door-mounted disconnect serves as the electrical disconnect device.
15. Dryer is not equipped with local lighting.
16. Functional identification
17. Dryer is equipped with a CE mark
18. Cable support may be required for power cord, depending on final installation.
19. No one is required to be in the interior of the electrical enclosure during the normal operation of the unit. Only skilled electricians should be inside the enclosure for maintenance.
20. Doors can be opened with a screwdriver, but no keys are required.
21. Two-hand control is not required or provided.
22. All dryers should be moved around and set in a place with a lift truck or equivalent.
23. There are no frequent repetitive cycles that require manual control—repetitive functions are automatic while the dryer is operating.
24. The machine is not equipped with cable less controls.
25. Color-coded (harmonized) power cord is sufficient for proper installation.

Aftercooler Design Specifications

Entering water temp.	
°F	°C
85°F	29°C
50°F (If used as Plasticizer trap)	10°C (If used as Plasticizer trap)

7-3 Drawings and Diagrams

Figure 14: Standard Model (180°F to 230°F) Air Flow Schematic

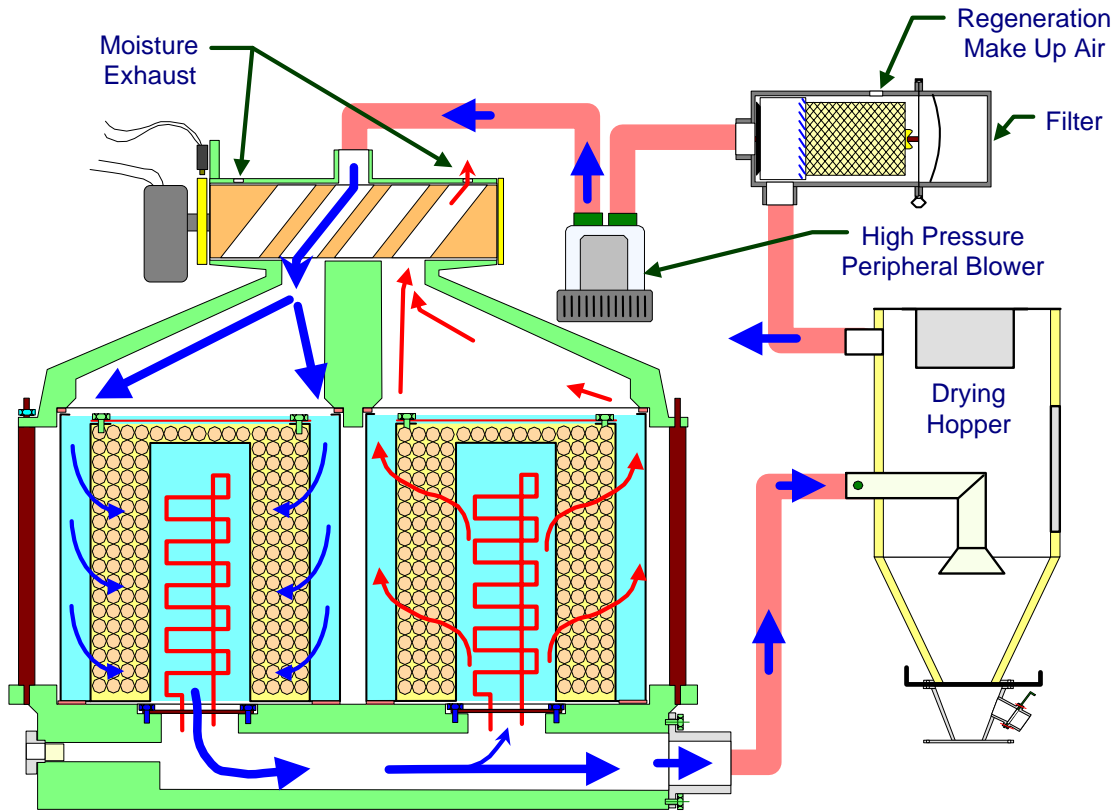

Figure 15: High Heat Model (180°F to 400°F) Air Flow Schematic

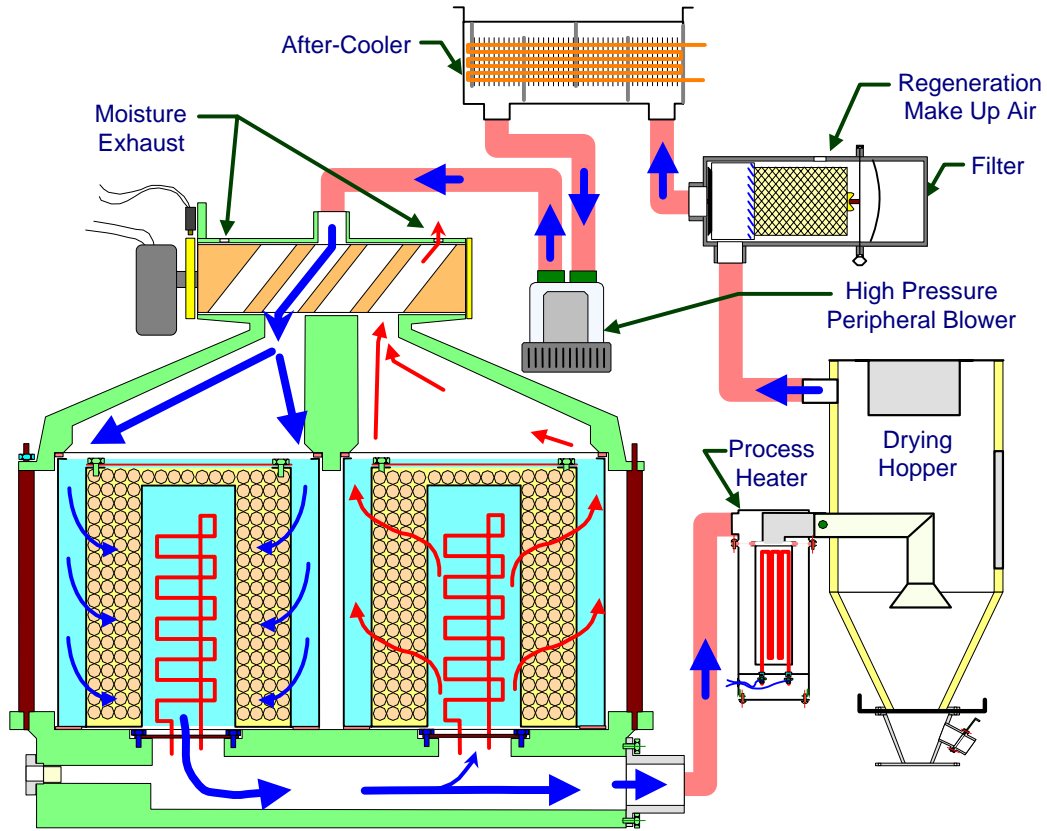
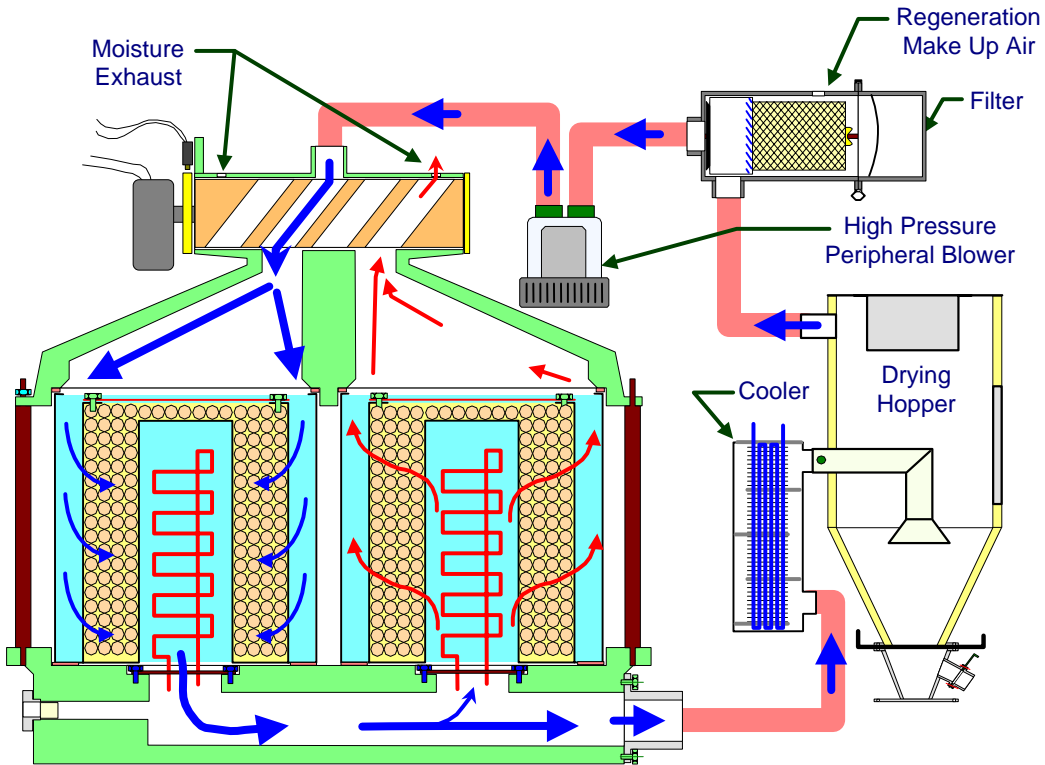

Figure 16: Low Heat Model (120°F to 250°F) Air Flow



HI-CORE DESICCANT DRYER 15/30/60 CFM UNITS

15 CFM			
Item	Qty	Part #	Description
21	1	A0571669	SCHEMATIC, 15 CFM POWER
120 VAC 1			
25	1	A0566840	GRAPHIC, ASD CONTROL, 1Ø
26	1	A0571672	COMMON PARTS, 120VAC CONTROL
27	1	A0534258	FUSE BLOCK, 2P 30A CC
28	1	A0538062	FUSE, PROC BLOWER, LP-CC-5
220VAC 1 Ø			
25	1	A0566840	GRAPHIC, ASD CONTROL, 1Ø
26	1	A0571673	COMMON PARTS, 220VAC CONTROL
27	1	A0534258	FUSE BLOCK, 2P 30A CC
28	1	A0550577	FUSE, PROC BLOWER, LP-CC-3
208VAC 3Ø			
24	1	A0571675	COMMON PARTS, 3Ø POWER
28	1	A0538062	FUSE, XFMR SECONDARY, LP-CC-6
31	1	A0558201	TRANSFORMER, 208-230/460X120 PSF
32	2	A0538002	FUSE, XFMR PRIMARY, FNQ-R-3.5
220VAC 3Ø			
24	1	A0571675	COMMON PARTS, 3Ø POWER
28	1	A0538062	FUSE, XFMR SECONDARY, LP-CC-6
31	1	A0558201	TRANSFORMER, 208-230/460X120 PSF
32	2	A0538001	FUSE, XFMR PRIMARY, FNQ-R-3.2
230VAC 3Ø			
24	1	A0571675	COMMON PARTS, 3Ø POWER
28	1	A0538062	FUSE, XFMR SECONDARY, LP-CC-6
31	1	A0558201	TRANSFORMER, 208-230/460X120 PSF
32	2	A0538001	FUSE, XFMR PRIMARY, FNQ-R-3.2
400VAC 3Ø			
24	1	A0571675	COMMON PARTS, 3Ø POWER
28	1	A0538062	FUSE, XFMR SECONDARY, LP-CC-6
31	1	A0558187	TRANSFORMER, 400X120 PSF
32	2	A053895	FUSE, XFMR PRIMARY, FNQ-R-1.8
460VAC 3Ø			
24	1	A0571675	COMMON PARTS, 3Ø POWER
28	1	A0538062	FUSE, XFMR SECONDARY, LP-CC-6
31	1	A0558201	TRANSFORMER, 208-230/460X120 PSF
32	2	A0536894	FUSE, XFMR PRIMARY, FNQ-R-1.6
575VAC 3Ø			
24	1	A0571675	COMMON PARTS, 3Ø POWER
28	1	A0538062	FUSE, XFMR SECONDARY, LP-CC-6
31	1	A0558194	TRANSFORMER, 575X120 PSF
32	2	A0536892	FUSE, XFMR PRIMARY, FNQ-R-1.25
33	1	A0534049	120VAC 1Ø LOW HEAT FUSE, HEATERS, KTK-R-20
33	1	A0534051	120VAC 1Ø HIGH HEAT FUSE, HEATERS, KTK-R-30
33	1	A0568935	220VAC 1Ø LOW HEAT FUSE, HEATERS, KTK-R-9
33	1	A0534049	220VAC 1Ø HIGH HEAT FUSE, HEATERS, KTK-R-20
33	3	A0534046	208VAC 3Ø LOW HEAT FUSE, HEATERS, KTK-R-10
33	3	A0534049	208VAC 3Ø HIGH HEAT FUSE, HEATERS, KTK-R-20
33	3	A0568935	220VAC 3Ø LOW HEAT FUSE, HEATERS, KTK-R-9
33	3	A0534049	220VAC 3Ø HIGH HEAT FUSE, HEATERS, KTK-R-20
33	3	A0534049	230VAC 3Ø LOW HEAT

33	3	A0568935	FUSE, HEATERS, KTK-R-9 230VAC 3Ø HIGH HEAT
33	3	A0534048	FUSE, HEATERS, KTK-R-15 400VAC 3Ø LOW HEAT
33	3	A0534041	FUSE, HEATERS, KTK-R-5 400VAC 3Ø HIGH HEAT
33	3	A0568935	FUSE, HEATERS, KTK-R-9 460VAC 3Ø LOW HEAT
33	3	A0534041	FUSE, HEATERS, KTK-R-5 460VAC 3Ø HIGH HEAT
33	3	A0534044	FUSE, HEATERS, KTK-R-8 575VAC 3Ø LOW HEAT
33	3	A0534039	FUSE, HEATERS, KTK-R-3.5 575VAC 3Ø HIGH HEAT
33	3	A0534042	FUSE, HEATERS, KTK-R-6

30 CFM			
Item	Qty.	Part #	Description
21	1	A0571670	SCHEMATIC, 30 CFM POWER
120VAC 1Ø			
25	1	A0566840	GRAPHIC, ASD CONTROL, 1Ø
26	1	A0571672	COMMON PARTS, 120VAC CONTROL
27	1	A0534258	FUSE BLOCK, 2P 30A CC
28	1	A0538069	FUSE, PROC BLOWER, LP-CC-5
220VAC 1Ø			
25	1	A0566840	GRAPHIC, ASD CONTROL, 1Ø
26	1	A0571673	COMMON PARTS, 220VAC CONTROL
27	1	A0534258	FUSE BLOCK, 2P 30A CC
28	1	A0568922	FUSE, PROC BLOWER, LP-CC-6.25
208VAC 3Ø			
24	1	A0571675	COMMON PARTS, 3Ø POWER
28	1	A0538060	FUSE, XFMR SECONDARY, LP-CC-5
31	1	A0558199	TRANSFORMER, 208-230/460X120 PSF
32	2	A0536893	FUSE, XFMR, PRIMARY, FNQ-R-1.4
40	1	A0558000	CONTACTOR, IEC, 9A, 120VAC COIL
41	1	A0558079	RELAY, OVERLOAD, IEC, 1-2.9A
220VAC 3Ø			
24	1	A0571675	COMMON PARTS, 3Ø POWER
28	1	A0568921	FUSE, XFMR SECONDARY, LP-CC-4.5
31	1	A0558199	TRANSFORMER, 208-230/460X120 PSF
32	2	A0536892	FUSE, XFMR, PRIMARY, FNQ-R-1.25
40	1	A0558000	CONTACTOR, IEC, 9A, 120VAC COIL
41	1	A0558079	RELAY, OVERLOAD, IEC, 1-2.9A
230VAC 3Ø			
24	1	A0571675	COMMON PARTS, 3Ø POWER
28	1	A0568921	FUSE, XFMR SECONDARY, LP-CC-4.5
31	1	A0558199	TRANSFORMER, 208-230/460X120 PSF
32	2	A0536892	FUSE, XFMR, PRIMARY, FNQ-R-1.25
40	1	A0558000	CONTACTOR, IEC, 9A, 120VAC COIL
41	1	A0558079	RELAY, OVERLOAD, IEC, 1-2.9A
400VAC 3Ø			
24	1	A057165	COMMON PARTS, 3Ø POWER
28	1	A0538062	FUSE, XFMR SECONDARY, LP-CC-2.5
31	1	A0558185	TRANSFORMER, 400X120 PSF
32	2	A0536889	FUSE, XFMR, PRIMARY, FNQ-R-0.5
40	1	A0558000	CONTACTOR, IEC, 9A, 120VAC COIL
41	1	A0558078	RELAY, OVERLOAD, IEC, .32-1A
460VAC 3Ø			
24	1	A0571675	COMMON PARTS, 3Ø POWER
28	1	A0568915	FUSE, XFMR SECONDARY, LP-CC-2.5
31	1	A0558199	TRANSFORMER, 400X120 PSF
32	2	A053889	FUSE, XFMR, PRIMARY, FNQ-R-0.5
40	1	A0558000	CONTACTOR, IEC, 9A, 120VAC COIL
41	1	A0558078	RELAY, OVERLOAD, IEC, .32-1A
575VAC 3Ø			
24	1	A0571675	COMMON PARTS, 3Ø POWER
28	1	A0568915	FUSE, XFMR SECONDARY, LP-CC-1.8
31	1	A0558192	TRANSFORMER, 575X120 PSF
32	2	A0534800	FUSE, XFMR, PRIMARY, FNQ-R-0.5

40	1	A0558000	CONTACTOR, IEC, 9A, 120VAC COIL
41	1	A0558078	RELAY, OVERLOAD, IEC, .32-1A
33	1	A0568936	FUSE, HEATERS, KTK-R-25
33	1	A0534047	220VAC 1Ø LOW HEAT FUSE, HEATERS, KTK-R-12
33	1	A0534051	220VAC 1Ø HIGH HEAT FUSE, HEATERS, KTK-R-30
33	3	A0534048	208VAC 3Ø LOW HEAT FUSE, HEATERS, KTK-R-15
33	3	A0534051	208VAC 3Ø HIGH HEAT FUSE, HEATERS, KTK-R-30
33	3	A0534047	220VAC 3Ø LOW HEAT FUSE, HEATERS, KTK-R-12
33	3	A0534051	220VAC 3Ø HIGH HEAT FUSE, HEATERS, KTK-R-30
33	3	A0534047	230VAC 3Ø LOW HEAT FUSE, HEATERS, KTK-R-12
33	3	A0568936	230VAC 3Ø HIGH HEAT FUSE, HEATERS, KTK-R-25
33	3	A0534043	400VAC 3Ø HIGH HEAT FUSE, HEATERS, KTK-R-7
33	3	A0534048	400VAC 3Ø LOW HEAT FUSE, HEATERS, KTK-R-15
33	3	A0534042	460VAC 3Ø HIGH HEAT FUSE, HEATERS, KTK-R-6
33	3	A0534048	460VAC 3Ø LOW HEAT FUSE, HEATERS, KTK-R-15
33	3	A0534041	575VAC 3Ø HIGH HEAT FUSE, HEATERS, KTK-R-5
33	3	A0534046	575VAC 3Ø LOW HEAT FUSE, HEATERS, KTK-R-10

60 CFM			
Item	Qty.	Part #	Description
20	1	A0571659	SCHEMATIC, 60 CFM POWER
24	1	A0571675	208VAC 3Ø COMMON PARTS, 3Ø POWER
28	1		FUSE, XFMR SECONDARY, LP-CC-10
31	1		TRANSFORMER, 208-230/460X120 PSF
32	2		FUSE, XFMR, PRIMARY, FNQ-R-1.4
40	1		CONTACTOR, IEC, 9A, 120VAC COIL
41	1		RELAY, OVERLOAD, IEC, 1.6-5A
24	1	A0571675	220VAC 3Ø COMMON PARTS, 3Ø POWER
28	1	A0538067	FUSE, XFMR SECONDARY, LP-CC-9
31	1	A0558199	TRANSFORMER, 208-230/460X120 PSF
32	2	A0536892	FUSE, XFMR, PRIMARY, FNQ-R-1.25
40	1	A0558000	CONTACTOR, IEC, 9A, 120VAC COIL
41	1	A0558082	RELAY, OVERLOAD, IEC, 1.6-5A
24	1	A0571675	230VAC 3Ø COMMON PARTS, 3Ø POWER
28	1	A0538067	FUSE, XFMR SECONDARY, LP-CC-9
31	1	A0558199	TRANSFORMER, 208-230/460X120 PSF
32	2	A0536892	FUSE, XFMR, PRIMARY, FNQ-R-1.25
40	1	A0558000	CONTACTOR, IEC, 9A, 120VAC COIL
41	1	A0558082	RELAY, OVERLOAD, IEC, 1.6-5A
24	1	A0571675	400VAC 3Ø COMMON PARTS, 3Ø POWER
28	1	A0538060	FUSE, XFMR SECONDARY, LP-CC-5
31	1	A0558185	TRANSFORMER, 400X120 PSF
32	2	A0536889	FUSE, XFMR, PRIMARY, FNQ-R-0.6
40	1	A0558000	CONTACTOR, IEC, 9A, 120VAC COIL
41	1	A0558079	RELAY, OVERLOAD, IEC, 1-2.9A
24	1	A0571675	460VAC 3Ø COMMON PARTS, 3Ø POWER
28	1	A0568921	FUSE, XFMR SECONDARY, LP-CC-4.5
31	1	A0558199	TRANSFORMER, 208-230/460X120 PSF
32	2	A0536889	FUSE, XFMR, PRIMARY, FNQ-R-0.6

40	1	A0558000	CONTACTOR, IEC, 9A, 120VAC COIL
41	1	A0558079	RELAY, OVERLOAD, IEC, 1-2.9A
<hr/>			
575VAC 3Ø			
24	1	A0571675	COMMON PARTS, 3Ø POWER
28	1	A0534802	FUSE, XFMR SECONDARY, LP-CC-3.5
31	1	A0558192	TRANSFORMER, 575X120 PSF
32	2	A0534800	FUSE, XFMR, PRIMARY, FNQ-R-0.5
40	1	A0558000	CONTACTOR, IEC, 9A, 120VAC COIL
41	1	A0558079	RELAY, OVERLOAD, IEC, 1-2.9A
33	3	A0534049	208VAC 3Ø LOW HEAT FUSE, HEATERS, KTK-R-20
33	3	A0534049	220VAC 3Ø LOW HEAT FUSE, HEATERS, KTK-R-20
33	3	A0534049	230VAC 3Ø LOW HEAT FUSE, HEATERS, KTK-R-20
33	3	A0534046	400VAC 3Ø LOW HEAT FUSE, HEATERS, KTK-R-10
33	3	A0568936	400VAC 3Ø HIGH HEAT FUSE, HEATERS, KTK-R-25
33	3	A0568935	460VAC 3Ø LOW HEAT FUSE, HEATERS, KTK-R-9
33	3	A0534049	460VAC 3Ø HIGH HEAT FUSE, HEATERS, KTK-R-20
33	3	A0534043	575VAC 3Ø LOW HEAT FUSE, HEATERS, KTK-R-7
33	3	A0534048	575VAC 3Ø HIGH HEAT FUSE, HEATERS, KTK-R-15

A0571672 120V CONTROL COMMON PARTS			
Item	Qty	Part #	Description
1	1	A0571676	SUBPANEL, 16.75X9.75
2	1	A0570597	CONTROL PANEL, 5.7X12
3			
4	1	A0540927	SWITCH, ROCKER, ILLUM, 120VAC, GRN
5	1	A0541659	LITE, 3MM, 120 VAC, RED
6	1	A0541658	LITE, 3MM, 120VAC, GRN
7	2	A0555748	CONTACTOR, MERCURY 2P 30A
8	1	A0503765	RELAY, DPDT, 120 VAC, 10A
9	1	A0505589	SOCKET, RELAY, DPDT
10	11	A0552362	TERM, 12-22AG GRY
11	1	A0552364	TERM, END BARRIER
12	2	A0552365	TERM, ANCHOR
13	1	A0567917	CONTROLLER, E5CN
14	1	A0003293	LUG, GROUND 14-4AWG COPPER
15	2	A0552367	TB JUMPER, 3P
16	1	A0566096	RELAY, PROGRAMMABLE, ALPHA AL -10MR-A
17	1	A0571671	ELECTRICAL 120VAC CONTROL SCHEMATIC
18	1	A0552373	TERM, 12-22 AWG, GND

A0571673 220V CONTROL COMMON PARTS			
ITEM	QTY	PART #	DESCRIPTION
1	1	A0571676	SUBPANEL, 16.75X9.75
2	1	A0570597	CONTROL PANEL, 5.7X12
3			
4	1	A0541669	SWITCH, ROCKER, ILLUM, 220VAC, GRN
5	1	A0563801	LITE, 3MM, 220 VAC, RED
6	1	A0541660	LITE, 3MM, 120VAC, GRN
7	2	A0571685	CONTACTOR, MERCURY 2P 30A
8	1	A0541290	RELAY, DPDT, 220 VAC, 10A
9	1	A0505589	SOCKET, RELAY, DPDT
10	11	A0552362	TERM, 12-22AG GRY
11	1	A0552364	TERM, END BARRIER
12	2	A0552365	TERM, ANCHOR
13	1	A0567917	CONTROLLER, E5CN
14	1	A0003293	LUG, GROUND 14-4AWG COPPER
15	2	A0552367	TB JUMPER, 3P
16	1	A0566096	RELAY, PROGRAMMABLE, ALPHA AL -10MR-A
17	1	A0571684	ELECTRICAL 120VAC CONTROL SCHEMATIC
18	1	A0552373	TERM, 12-22 AWG, GND

A0571675 3 Ø COMMON PARTS			
ITEM	QTY	PART #	DESCRIPTION
25	1	A0566841	GRAPHIC, ASD CONTROL, 3Ø
26	1	A057172	COMMON PARTS, 120VAC CONTROL
27	1	A0534259	FUSE BLOCK, 3P 30A CC
29	1	A0555166	DISCONNECT, 25A UL508 PANEL MT.
30	1	A0555165	HANDLE, DISCONNECT

DEWPOINT OPTION			
ITEM	QTY	PART #	DESCRIPTION
35	1	A0558065	CONTROLLER, OMRON E5CK-AA1-302
36	1	A0566068	BRACKET, DEW PT CIRCUIT BOARD
37	1	A0548555	CIRCUIT BOARD, DEW POINT
38	4	A0530780	STANDOFF, 6-32 X .5"

NO DEWPOINT OPTION			
ITEM	QTY	PART #	DESCRIPTION
39	1	A0555767	PLATE, BLANK OFF

HIGH HEAT OPTION 120V CONTROL			
ITEM	QTY	PART #	DESCRIPTION
34	1	A0555749	CONTACTOR, MERCURY 2P 30A, 120 VAC COIL

HIGH HEAT OPTION 220 V CONTROL			
ITEM	QTY	PART #	DESCRIPTION
34	1	A0571685	CONTACTOR, MERCURY 2P 30A, 220VAC COIL

7-5 Returned Material Policy

Credit Returns

Prior to the return of any material **authorization** must be given by **the manufacturer**. A RMA number will be assigned for the equipment to be returned.

Reason for requesting the return must be given.

ALL returned material purchased from **the manufacturer** returned is subject to 15% (\$75.00 minimum) restocking charge.

ALL returns are to be shipped prepaid.

The invoice number and date or purchase order number and date must be supplied.

No credit will be issued for material that is not within the manufacturer's warranty period and/or in new and unused condition, suitable for resale.

Warranty Returns

Prior to the return of any material, authorization must be given by **the manufacturer**. A RMA number will be assigned for the equipment to be returned.

Reason for requesting the return must be given.

All returns are to be shipped prepaid.

The invoice number and date or purchase order number and date must be supplied.

After inspecting the material, a replacement or credit will be given, at **the manufacturer's** discretion. If the item is found to be defective in materials or workmanship, and it was manufactured by our company, purchased components are covered under their specific warranty terms.

7-6 Dryer Identification (Serial Number) Tag

(Located on back of Dryer)

Company Logo	
	XXX Series Dryer Model Number XXX-15
Max Drying Capacity HR	
460V	Serial Number 060701R
1Ø	Date of Manufacture 06/2003
4.5A	
Over-current Protection Device (s) 4.5A Total	
Frequency 50/60Hz	
Compressed air supply None	
Dryer Mass 400 lbs/(180 KG)	
Electrical Diagrams & Pneumatic Diagram	<input type="text"/>
Street Address	City, State Zip Code
Telephone Number	

7-7 Technical Assistance

Parts Department

Call toll-free 7am–5pm CST [800] 423-3183 or call [630] 595-1060, Fax [630] 475-7005

The ACS Customer Service Group will provide your company with genuine OEM quality parts manufactured to engineering design specifications, which will maximize your equipment's performance and efficiency. To assist in expediting your phone or fax order, please have the model and serial number of your unit when you contact us. A customer replacement parts list is included in this manual for your convenience. ACS welcomes inquiries on all your parts needs and is dedicated to providing excellent customer service.

Service Department

Call toll-free 8am–5pm CST [800] 233-4819 or call [630] 595-1060

Emergencies after 5pm CST, call [847] 439-5655

We have a qualified service department ready to help. Service contracts are available for most products.

Sales Department

Call [630] 595-1060 Monday–Friday, 8am–5pm CST

Our products are sold by a world-wide network of independent sales representatives. Contact our Sales Department for the name of the sales representative nearest you.

Contract Department

Call [630] 595-1060 Monday–Friday, 8am–5pm CST

Let us install your system. The Contract Department offers any or all of these services: project planning; system packages including drawings; equipment, labor, and construction materials; and union or non-union installations.

Free Manuals Download Website

<http://myh66.com>

<http://usermanuals.us>

<http://www.somanuals.com>

<http://www.4manuals.cc>

<http://www.manual-lib.com>

<http://www.404manual.com>

<http://www.luxmanual.com>

<http://aubethermostatmanual.com>

Golf course search by state

<http://golfingnear.com>

Email search by domain

<http://emailbydomain.com>

Auto manuals search

<http://auto.somanuals.com>

TV manuals search

<http://tv.somanuals.com>