



SDAA 25-100 (15-60 cfm) Dehumidifying Dryers

Part Number: 882.00290.00

Bulletin Number: DH1-640

Effective: 12/06/05

Write Down Your Serial Numbers Here For Future Reference:

_____	_____
_____	_____
_____	_____

We are committed to a continuing program of product improvement.
Specifications, appearance, and dimensions described in this manual are subject to change without notice.

DCN No. _____

© Copyright 2005

All rights reserved.

Shipping Information

Unpacking and Inspection

You should inspect your dryer for possible shipping damage.

Thoroughly check the equipment for any damage that might have occurred in transit, such as broken or loose wiring and components, loose hardware and mounting screws, etc.

In the Event of Shipping Damage

According to the contract terms and conditions of the Carrier, the responsibility of the Shipper ends at the time and place of shipment.

Notify the transportation company's local agent if you discover damage.

Hold the damaged goods and packing material for the examining agent's inspection. **Do not return any goods before the transportation company's inspection and authorization.**

File a claim with the transportation company. Substantiate the claim by referring to the agent's report. A certified copy of our invoice is available upon request. The original Bill of Lading is attached to our original invoice. If the shipment was prepaid, write us for a receipted transportation bill.

Advise customer service regarding your wish for assistance and to obtain an RMA (return material authorization) number.

If the Shipment is Not Complete

Check the packing list as back-ordered items are noted on it. You should have:

- Dehumidifying Dryer
- Bill of lading
- Packing list
- Operating and Installation packet
- Electrical schematic and panel layout drawings
- Component instruction manuals

Re-inspect the container and packing material to see if you missed any smaller items during unpacking.

If the Shipment is Not Correct

If the shipment is not what you ordered, **contact the shipping department immediately**. For shipments in the United States and Canada, call 1 (800) 233-4819; for all other countries, call our international desk at (630) 475-7491. Have the order number and item number available. *Hold the items until you receive shipping instructions.*

Returns

Do not return any damaged or incorrect items until you receive shipping instructions from the shipping department.

Table of Contents

CHAPTER 1: SAFETY	V
1-1 How to Use This Manual	v
<i>Safety Symbols Used in this Manual</i>	v
1-2 Warnings and Precautions	vi
1-3 Responsibility	vii
<i>General Responsibility</i>	vii
<i>Operator Responsibility</i>	viii
<i>Maintenance Responsibility</i>	ix
<i>Reporting a Safety Defect</i>	ix
CHAPTER 2: FUNCTIONAL DESCRIPTION	11
2-1 Models Covered in This Manual.....	11
2-2 General Description.....	11
<i>What is desiccant?</i>	12
<i>The Process/Regeneration Cycle</i>	12
2-3 Standard Features.....	12
<i>Mechanical Features</i>	12
<i>Electrical Features</i>	12
<i>Controller Features</i>	13
2-4 Options.....	13
2-5 Safety Devices and Interlocks	13
CHAPTER 3: INSTALLATION	15
3-1 Uncrating the Equipment.....	15
3-2 Rigging and Placing the Dryer.....	15
<i>Recommended Dryer Lifting Hardware</i>	18
3-3 Electrical Connections.....	19
3-4 Setup Procedures.....	20
<i>Checking for Proper Blower Rotation</i>	20
<i>Making Dryer/Drying Hopper Process Air Connections</i>	20
<i>Drying Hopper Air Trap Considerations</i>	21
<i>Optional Aftercooler</i>	21
3-5 Initial Start-up	22
<i>Pre-Startup Checks</i>	22
<i>Starting Up the Dryer</i>	22
<i>Auto-Tuning the Dryer</i>	22
<i>Shutting Down the Dryer</i>	23
CHAPTER 4: OPERATION	24
4-1 Start-up.....	24
4-2 Controller Description and Operation	25
<i>Identifying Control Panel Indicator Lights and Switches for the Standard</i> <i>Controller</i>	25
<i>Process Air Temperature Controller</i>	26
<i>Setting the Process Air Temperature</i>	27

	<i>Restoring the Process Air Temperature Controller (E5CN) to Factory Settings..</i>	28
	<i>Process Air Dew Point Display</i>	31
	<i>Setting the High Dew Point Alarm</i>	31
	<i>Restoring the Process Air Dew Point Meter (E5CK) to Factory Setup</i>	31
	<i>Redundant Safety Controller Display</i>	32
	<i>Setting the Redundant Safety Controller</i>	32
	<i>Restoring the WATLOW Redundant Safety Controller to Factory Setup</i>	32
4-3	Dryer Operation Procedures	34
	<i>Controller Operation (Without Optional Alarm Horn & Reset Button)</i>	34
	<i>Controller Operation (With Optional Alarm Horn & Reset Button)</i>	37
	<i>Alarm Display Messages</i>	39
4-4	Auto-Tuning the Dryer	40
4-5	Shutting Down the Dryer	40
CHAPTER 5: MAINTENANCE		41
5-1	Preventative Maintenance Schedule	41
5-2	Preventative Maintenance	42
	<i> Servicing Process Air Filters</i>	42
	<i> Servicing the Dew Point Monitor</i>	43
5-3	Corrective Maintenance	44
	<i> Symptoms of Worn Desiccant</i>	44
	<i> Replacing Worn Desiccant</i>	45
	<i> Replacing the Process Heater</i>	47
CHAPTER 6: TROUBLESHOOTING		48
6-1	Introduction	48
6-2	Determining Temperature Controller Errors or Sensor Errors	51
	<i> Using a Thermocouple</i>	51
	<i> Using a Platinum Resistance Thermometer</i>	51
CHAPTER 7: APPENDIX		52
7-1	Warranty	52
	<i> Warranty Specifications</i>	52
	<i> Warranty Restrictions</i>	52
	<i> Warranty Liabilities</i>	53
	<i> Customer Responsibilities</i>	53
7-2	Optional Components	53
7-3	Technical Specifications	54
	<i> Annex B Information</i>	54
	<i> Aftercooler Design Specifications</i>	55
7-4	Drawings and Diagrams	55
7-5	Spare Parts List	55
7-6	Returned Material Policy	57
	<i> Credit Returns</i>	57
	<i> Warranty Returns</i>	57
7-7	Safety Tag Information	57
	<i> Dryer Safety Tags</i>	57
7-8	Dryer Identification (Serial Number) Tag	58
7-9	Technical Assistance	59
	<i> Parts Department</i>	59

Service Department..... 59
Sales Department..... 59
Contract Department..... 59

Chapter 1: Safety

1-1 How to Use This Manual

Use this manual as a guide and reference for installing, operating, and maintaining your dehumidifying dryer. The purpose is to assist you in applying efficient, proven techniques that enhance equipment productivity.

This manual covers only light corrective maintenance. No other maintenance should be undertaken without first contacting a service engineer.

The Functional Description section outlines models covered, standard features, and safety features. Additional sections within the manual provide instructions for installation, pre-operational procedures, operation, preventive maintenance, and corrective maintenance.

The Installation chapter includes required data for receiving, unpacking, inspecting, and setup of the dehumidifying dryer. We can also provide the assistance of a factory-trained technician to help train your operator(s) for a nominal charge. This section includes instructions, checks, and adjustments that should be followed before commencing with operation of the dehumidifying dryer. These instructions are intended to supplement standard shop procedures performed at shift, daily, and weekly intervals.

The Operation chapter includes a description of electrical and mechanical controls, in addition to information for operating the dryer safely and efficiently.

The Maintenance chapter is intended to serve as a source of detailed assembly and disassembly instructions for those areas of the equipment requiring service. Preventive maintenance sections are included to ensure that your dehumidifying dryer provides excellent, long service.

The Troubleshooting chapter serves as a guide for identification of most common problems. Potential problems are listed, along with possible causes and related solutions.

The Appendix contains technical specifications, drawings, schematics, parts lists, and available options. A spare parts list with part numbers specific to your machine is provided with your shipping paperwork package. Refer to this section for a listing of spare parts for purchase. Have your serial number and model number ready when ordering.

Safety Symbols Used in this Manual

The following safety alert symbols are used to alert you to potential personal injury hazards. Obey all safety messages that follow these symbols to avoid possible injury or death.

DANGER! *DANGER indicates an imminently hazardous situation that, if not avoided, will result in death or serious injury.*

WARNING! *WARNING indicates a potentially hazardous situation or practice that, if not avoided, could result in death or serious injury.*

Caution! *CAUTION indicates a potentially hazardous situation or practice that, if not avoided, may result in minor or moderate injury or in property damage.*

1-2 Warnings and Precautions

Our equipment is designed to provide safe and reliable operation when installed and operated within design specifications, following national and local safety codes. This may include, but is not limited to OSHA, NEC, CSA, SPI, and any other local, national and international regulations.

To avoid possible personal injury or equipment damage when installing, operating, or maintaining this equipment, use good judgment and follow these safe practices:

- ☑ **Read and follow these operation and installation instructions when installing, operating, and maintaining this equipment. If these instructions become damaged or unreadable, additional copies are available from the manufacturer.**
- ☑ Follow all **SAFETY CODES**.
- ☑ Wear **SAFETY GLASSES** and **WORK GLOVES**.
- ☑ Work only with approved tools and devices.
- ☑ Disconnect and/or lock out power before servicing or maintaining the equipment.
- ☑ Use care when **LOADING, UNLOADING, RIGGING, or MOVING** this equipment.
- ☑ Operate this equipment within design specifications.
- ☑ **OPEN, TAG, and LOCK ALL DISCONNECTS** before working on equipment. You should remove the fuses and carry them with you.
- ☑ Make sure the equipment and components are properly **GROUNDING** before you switch on power.
- ☑ Use **EXTREME CAUTION** when working with dryer. **HIGH HEAT** can be dangerous. Keep body parts, tools, clothing, and debris away from dryer.
- ☑ When welding or brazing in or around this equipment, make sure **VENTILATION** is **ADEQUATE. PROTECT** adjacent materials from flame or sparks by shielding with sheet metal. An approved **FIRE EXTINGUISHER** should be close at hand and ready for use if needed.
- ☑ Do not restore power until you remove all tools, test equipment, etc., and the equipment and related components are fully reassembled.
- ☑ Only **PROPERLY TRAINED** personnel familiar with the information in this manual should work on this equipment.

We have long recognized the importance of safety and have designed and manufactured our equipment with operator safety as a prime consideration. We expect you, as a user, to abide by the foregoing recommendations in order to make operator safety a reality.

1-3 Responsibility

These machines are constructed for maximum operator safety when used under standard operating conditions and when recommended instructions are followed in the maintenance and operation of the machine.

All personnel engaged in the use of the machine should become familiar with its operation as described in this manual.

Proper operation of the machine promotes safety for the operator and all workers in its vicinity.

Each individual must take responsibility for observing the prescribed safety rules as outlined. All warning and danger signs must be observed and obeyed. All actual or potential danger areas must be reported to your immediate supervisor.

General Responsibility

No matter who you are, safety is important. Owners, operators and maintenance personnel must realize that every day, safety is a vital part of their jobs.

If your main concern is loss of productivity, remember that production is always affected in a negative way following an accident. The following are some of the ways that accidents can affect your production:

- Loss of a skilled operator (temporarily or permanently)
- Breakdown of shop morale
- Costly damage to equipment
- Downtime

An effective safety program is responsible and economically sound.

Organize a safety committee or group, and hold regular meetings. Promote this group from the management level. Through this group, the safety program can be continually reviewed, maintained, and improved. Keep minutes or a record of the meetings.

Hold daily equipment inspections in addition to regular maintenance checks. You will keep your equipment safe for production and exhibit your commitment to safety.

Please read and use this manual as a guide to equipment safety. This manual contains safety warnings throughout, specific to each function and point of operation.

Operator Responsibility

The operator's responsibility does not end with efficient production. The operator usually has the most daily contact with the equipment and intimately knows its capabilities and limitations.

Plant and personnel safety is sometimes forgotten in the desire to meet incentive rates, or through a casual attitude toward machinery formed over a period of months or years. Your employer probably has established a set of safety rules in your workplace. Those rules, this manual, or any other safety information will not keep you from being injured while operating your equipment.

Learn and always use safe operation. Cooperate with co-workers to promote safe practices. Immediately report any potentially dangerous situation to your supervisor or appropriate person.

REMEMBER:

- **NEVER** place your hands or any part of your body in any dangerous location.
- **NEVER** operate, service, or adjust the dryer without appropriate training and first reading and understanding this manual.
- **NEVER** try to pull material out of the dryer with your hands while it is running!
- Before you start the dryer check the following:
 - Remove all tools from the dryer;
 - Be sure no objects (tools, nuts, bolts, clamps, bars) are laying in the hopper area;
- If your dryer has been inoperative or unattended, check all settings before starting the unit.
- At the beginning of your shift and after breaks, verify that the controls and other auxiliary equipment are functioning properly.
- Keep all safety guards in place and in good repair. **NEVER** attempt to bypass, modify, or remove safety guards. Such alteration is not only unsafe, but will void the warranty on your equipment.
- When changing control settings to perform a different mode of operation, be sure selector switches are correctly positioned. Locking selector switches should only be adjusted by authorized personnel and the keys removed after setting.
- Report the following occurrences **IMMEDIATELY**:
 - unsafe operation or condition
 - unusual dryer action
 - leakage
 - improper maintenance
 - **NEVER** stand or sit where you could slip or stumble into the dryer while working on it.
- **DO NOT** wear loose clothing or jewelry, which can be caught while working on a dryer. In addition, cover or tie back long hair.

- Clean the dryer and surrounding area **DAILY**, and inspect the machine for loose, missing or broken parts.
- Shut off power to the dryer when it is not in use. Turn the switch to the **OFF** position, or unplug it from the power source.

Maintenance Responsibility

Proper maintenance is essential to safety. If you are a maintenance worker, you must make safety a priority to effectively repair and maintain equipment.

Before removing, adjusting, or replacing parts on a machine, remember to turn off all electric supplies and all accessory equipment at the machine, and disconnect and lockout electrical power. Attach warning tags to the disconnect switch.

When you need to perform maintenance or repair work on a dryer above floor level, use a solid platform or a hydraulic elevator. If there is a permanently installed catwalk on your dryer, use it. The work platform should have secure footing and a place for tools and parts. **DO NOT** climb on dryers, machines, or work from ladders.

If you need to repair a large component, use appropriate handling equipment. Before you use handling equipment (portable “A” frames, electric boom trucks, fork trucks, overhead cranes) be sure the load does not exceed the capacity of the handling equipment or cause it to become unstable.

Carefully test the condition of lifting cables, chains, ropes, slings, and hooks before using them to lift a load.

Be sure that all non-current carrying parts are correctly connected to earth ground with an electrical conductor that complies with current codes. Install in accordance with national and local codes.

When you have completed the repair or maintenance procedure, check your work and remove your tools, rigging, and handling equipment.

Do not restore power to the dryer until all persons are clear of the area. **DO NOT** start and run the dryer until you are sure all parts are functioning correctly.

BEFORE you turn the dryer over to the operator for production, verify all dryer enclosure panels, guards and safety devices are in place and functioning properly.

Reporting a Safety Defect

If you believe that your equipment has a defect that could cause injury, you should immediately discontinue its use and inform the manufacturer.

The principle factors that can result in injury are failure to follow proper operating procedures (i.e. lockout/tagout), or failure to maintain a clean and safe working environment.

Chapter 2: Functional Description

2-1 Models Covered in This Manual

This manual provides operation, installation, and maintenance instructions for 15, 30, and 60 cfm dehumidifying dryers. Model numbers are listed on the serial tag. Make sure you know the model and serial number of your equipment before contacting the manufacturer for parts or service.

Our dehumidifying mini dryers are designed to generate heated dehumidified air at carefully controlled temperatures for use in plastic drying systems. Drying systems are sized to meet the specific requirements stated by the Customer at the time of purchase.

2-2 General Description

Dehumidifying dryers are used to generate very low dew point air heated to a controlled temperature for drying plastic pellets and regrind.

Our dryers force hot, dry air through resin in a drying hopper, where air picks up moisture from the material and draws it back to the dryer. In the dryer, a desiccant bed strips moisture from the air. The dried process air is then re-heated and delivered back into the drying hopper to continue to remove moisture.

Figure 15: Typical Dryer Air Flow Schematic

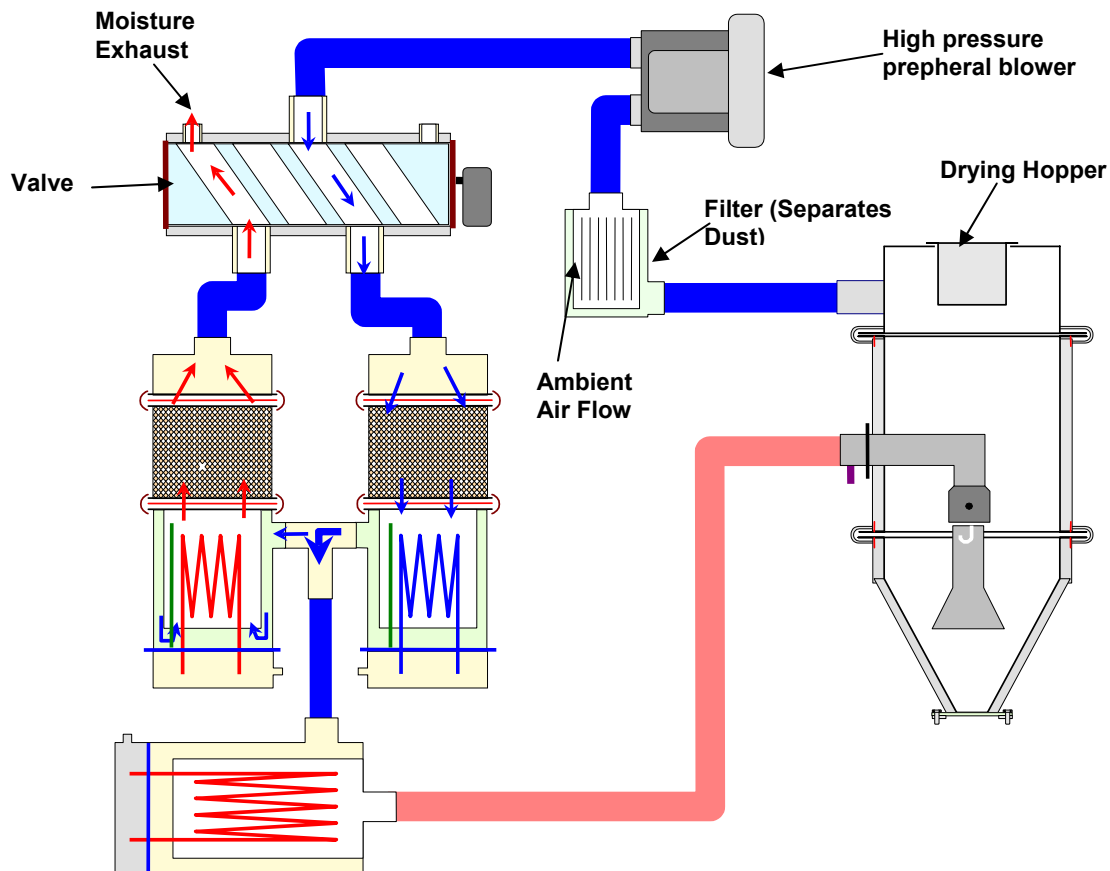

A small amount of ambient air is introduced into the process air stream to make up for the air lost during the bed regeneration. Because the process air is typically much drier than the ambient air, the air mixture maintains drying efficiency at a consistently high level. This air is heated to 500° F (260° C) before entering the bed that is on regeneration forcing moisture from the desiccant before exhausting. To compensate for the humidity content in the air, this dryer is supplied with the proper amount of desiccant.

What is desiccant?

Desiccant is a material that attracts and holds (absorbs) water from the air. The desiccant our dryers use is a synthetic crystalline metal aluminosilicate blended with a clay binder and formed into beads.

The Process/Regeneration Cycle

Our dryers have two desiccant beds. While one bed is on-line in the process air loop, the other is off-line, being regenerated.

When a desiccant bed is on-line, it absorbs moisture from the process air. In time, the bed becomes saturated with moisture and needs to be regenerated. The dryer automatically redirects the process airflow to the second bed, and starts the regeneration cycle on the first bed.

During regeneration, the dryer system heats air and forces it through the desiccant bed. The moisture driven off the bed bleeds to the atmosphere.

2-3 Standard Features

Mechanical Features

- Dual desiccant beds
- Electrically-actuated air valve
- 13X Molecular Sieve
- Single regenerative process blower
- Drying temperature range of 180°F to 250°F (71° C to 121° C).
- 2.5" hose connections

Electrical Features

- Process thermocouple to be connected to drying hopper air inlet.
- Nema 12 control enclosure

- NFPA79 machinery electrical standards
 - Non-fused electrical disconnect
 - Branch fusing
 - Mercury process heater contactor
 - Regeneration temperature control
 - Process high temperature alarm light
 - Process/regeneration heater box
 - High temperature safety system (Process/Regeneration)
 - Dew point monitor with digital read-out

Controller Features

- Mitsubishi programmable relay controller
- Display of process temperature set point and actual settings

2-4 Options

Options marked with “*” indicate options that can be factory installed or retrofitted in the field.

- * Process temperature 180°F to 400° F, including aftercooler inside dryer and silicone insulated delivery hose.
- * Process temperature 120° F to 250° F, includes precooler on back of dryer.
- * If the dryer is a central dry air generator, it will not have a process heater box.
- * Plasticizer trap (with cooling coil) in lieu of optional aftercooler (mounts outside on back of dryer).
- * Machine mount adapter to accommodate a dryer and corresponding hopper.
- * Drawer magnet, stainless steel construction.
- * Casters, two (2) fixed and two (2) swivel.
- * Cart with caster with hopper mounting place.
- * Redundant high temp safety control.
- * Audible alarm
- * Insulated air hose for air delivery

2-5 Safety Devices and Interlocks

This section includes information on safety devices and procedures that are inherent to the Dryer. This manual is not intended to supersede or alter safety standards established by the user of this equipment. Instead, the material contained in this section is recommended to supplement these procedures in order to provide a safer working environment.

At the completion of this section, the operator and maintenance personnel will be able to do the following:

- Identify and locate specific safety devices.
- Understand the proper use of the safety devices provided.
- Describe the function of the safety device.

Safety Circuit Standards

Safety circuits used in industrial systems protect the operator and maintenance personnel from dangerous energy. They also provide a means of locking out or isolating the energy for servicing equipment.

Various agencies have contributed to the establishment of safety standards that apply to the design and manufacture of automated equipment. The Occupational Safety and Health Administration (OSHA) and the Joint Industrial Council (JIC) are just a few of the organizations that have joined with the plastics industry to develop safety standards.

Every effort has been made to incorporate these standards into the design of the dryer; however, it is the responsibility of the personnel operating and maintaining the equipment to familiarize themselves with the safety procedures and the proper use of any safety devices.

Fail Safe Operation

If a safety device or circuit should fail, the design must be such that the failure causes a “Safe” condition. As an example, a safety switch must be a normally open switch. The switch must be held closed with the device it is to protect. If the switch fails, it will go to the open condition, tripping out the safety circuit.

At no time should the safety device fail and allow the operation to continue. For example, if a safety switch is guarding a motor, and the safety switch fails, the motor should not be able to run.

Safety Device Lock-Outs

Some safety devices disconnect electrical energy from a circuit. The safety devices that are used on these dryers are primarily concerned with electrical power disconnection and the disabling of moving parts that may need to be accessed during the normal operation of the machine.

Some of the safety devices utilize a manual activator. This is the method of initiating the safety lock out. This may be in the form of a plug, lever or a handle. Within this lockable handle, there may be a location for a padlock. Personnel servicing the equipment should place a padlock in the lockout handle.

In addition to the safety devices listed above, these dryers are equipped with a line cord plug. This allows the operator or maintenance personnel to unplug the dryer from its power source and tag it out. The plug can then be tagged with any number of approved electrical lockout tags available at most electrical supply stores.

WARNING! *Always disconnect and lockout all electrical power and pneumatic (i.e. compressed air) sources prior to servicing or cleaning the dryer. Failure to do so may result in serious injury. No one but the person who installed the lockout may remove it.*



Chapter 3: Installation

3-1 Uncrating the Equipment

Dehumidifying Dryers are shipped mounted on a skid, enclosed in a plastic wrapper, and contained in a cardboard box.

1. Pry the crating away from the skid.

Note: *Remove the nails holding the box to the skid and lift the box off carefully; avoiding staples in the 1' x 4' wood supports. Cut the steel banding.*

2. Use a pry bar to remove the blocks securing the unit to the skid.
3. Lift unit from sides. Use a pry bar if necessary to carefully remove the skid from the unit.
4. Lower slowly.

3-2 Rigging and Placing the Dryer

Take care when rigging and placing the dryer. Figures 1, 2 and 3 on the following pages show a suggested safe rigging diagram. It lets you lift the dryer/hopper unit vertically for installation on the machine throat. Adjust chain lengths at the center sling bracket before you lift the unit. Your dryer has built-in lifting lugs.

Caution! *If you are mounting a machine-mount dryer with a magnet or transition adaptor on the machine throat, you must provide additional support to hold the dryer securely on the machine.*



Be aware that off-center static and dynamic hopper loading can occur with machine vibration. Again, provide additional support to hold the dryer securely on the machine.

For 60 cfm dryer units, you must provide additional support to stabilize these units and to protect personnel when installing on machine throats.

Use caution and observe safety rules when lifting and placing your dryer!

Figure 16: Machine-Mount Dryer Dimensions

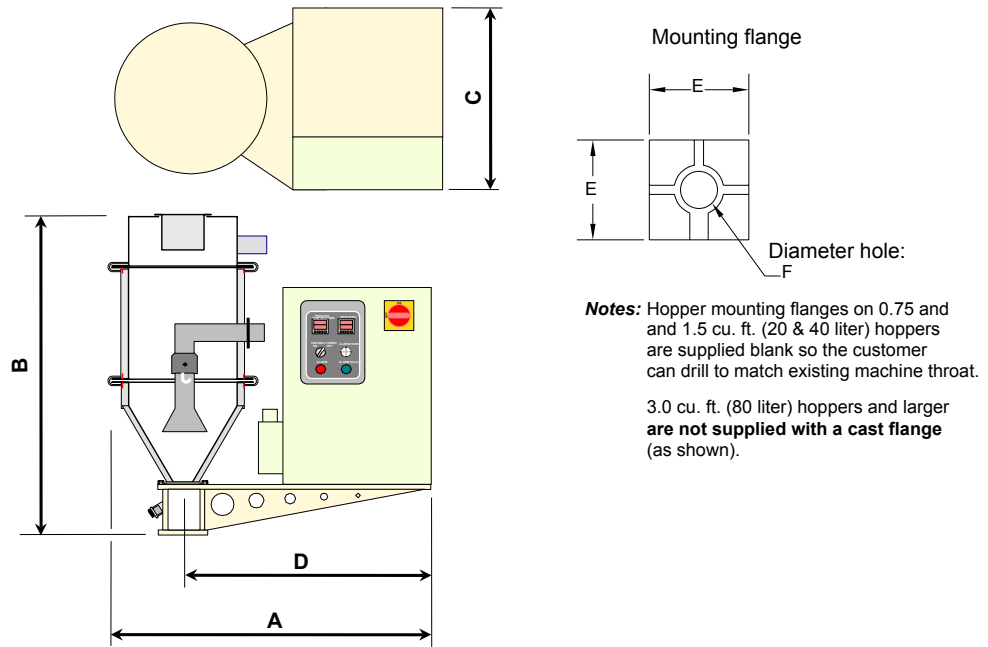

15, 30, 60 cfm machine-mount dimensions in inches/cm												
Dimension	15 cfm				30 cfm				60 cfm			
	0.7 ft. ³ /20 liters		1.5 ft. ³ /40 liters		1.5 ft. ³ /40 liters		3.0 ft. ³ /80 liters		4.0 ft. ³ /120 liters		6.0 ft. ³ /160 liters	
	in.	cm	in.	cm	in.	cm	in.	cm	in.	cm	in.	cm
A	41	104	43	109	43	109	46	117	56.75	144	56.75	144
B	36	91	37	94	37	94	44	112	50	127	62	158
C	30	76	30	76	30	76	30	76	34	86	34	86
D	35	89	35	89	35	89	35	89	45.75	116	45.75	116
E	4	10.2	4	10.2	4	10.2	7	17.8	7	17.8	7	17.8
F	1.5	3.8	1.5	3.8	1.5	3.8	2	5.1	2	5.1	2	5.1

Figure 17: Floor-Mount Dryer Dimensions

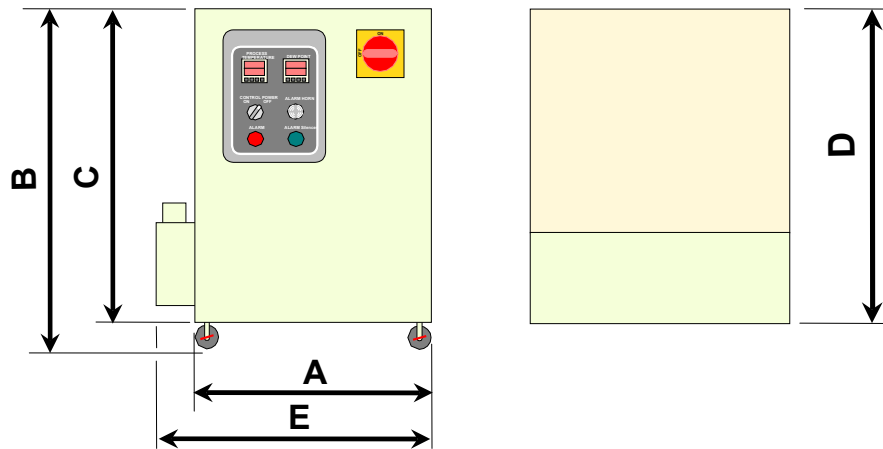

15, 30, 60 cfm floor-mount dimensions in inches/cm						
Dimension	15 cfm		30 cfm		60 cfm	
	in.	cm	in.	cm	in.	cm
A	20	51	20	51	24	61
B	32.5	83	32.5	83	32.5	83
C	30	76	30	76	30	76
D	30	76	30	76	34	86
E	23.75	60	23.75	60	28	71

Figure 1: Suggested Lift Rigging for Cart Mounted Dryers

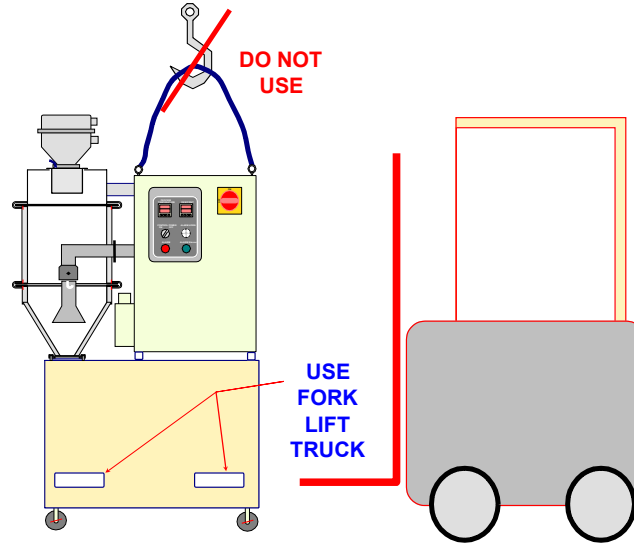

Caution! *Do not use a hoist to move or rig your Dryer when it is mounted on a cart! Moving the Dryer with a hoist will cause it to become unstable and may cause damage to the Dryer and/or injury to personnel!*

Recommended Dryer Lifting Hardware

Item	Quantity	Description	Vendor	Vendor part no.
1	1	Adjustable alloy chain sling	McMaster-Carr	33665T32
2	2	Existing hopper lifting bracket	—	—
3	1	Drop forged steel eye nut	McMaster-Carr	3019T15
4	1	Chain connector	McMaster-Carr	3712T23

Figure 2: Suggested Lift Rigging for Floor Mounted Dryers

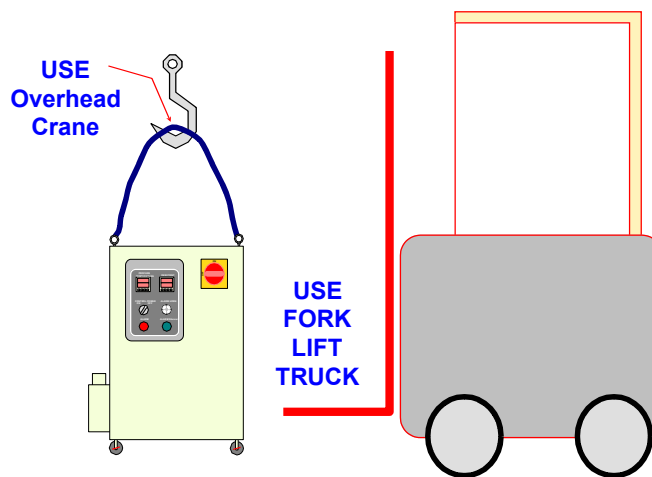

Note: *Floor Mounted Dryers can be lifted by hoist or fork lift.*

Figure 3: Suggested Lift Rigging for Machine Mounted Dryers

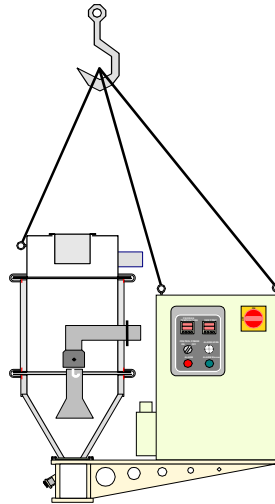

Caution! *When using a hoist to move a machine mounted dryer, ALWAYS attach chains to the three (3) locations/lifting points on the unit! Moving the Dryer without the chains attached to all of the lifting points will cause the unit to become unstable and may cause damage to the Dryer and/or injury to personnel!*

3-3 Electrical Connections

When making electrical connections to your dryer, ensure that you take into consideration and make arrangements for the following:

- A qualified electrician should make all electrical connections.
- Fulfill all national, state, and local safety and electrical code requirements.
- The serial tag lists voltage, phase, and amp draw information:
 - Line voltage must be within plus or minus ten percent ($\pm 10\%$) of the voltage listed on the serial tag, or damage may occur. Phase imbalance must be less than two percent (2%).
- Connect main power to the dryer at the disconnect or terminals in the upper right corner of the control enclosure.
- Install a fused disconnect with a lockout feature in the power main leading to the dryer.
- The power drop must include a ground wire.
- Make sure all electrical connections are tight.

3-4 Setup Procedures

This section provides the procedures necessary for configuring your Dehumidifying Dryer.

Configuration of your dryer includes checking for proper blower rotation, making dryer/drying hopper process air connections and the optional aftercooler (on 60 cfm models). We recommend that you carry out these procedures in the order given here.

Note: *Before carrying out these procedures, install all equipment as described in this section.*

Checking for Proper Blower Rotation

Three-Phase Models

Caution!



*In three-phase models, incorrect phasing of power leads can cause backward rotation of blower motors and **CONTAMINATION OF THE DESICCANT!***

Always check blower rotation before putting material in the drying hopper!

The blower is rotating properly when air flows from the delivery outlet.

Note: *Holding your hand in front of the air return will also indicate if the blower rotates in the proper direction.*

If the three-phase blower rotates improperly, reverse any two wires at the fused disconnect outside the dryer or at the disconnect/terminal in the control enclosure. This assures that the blower rotates in the proper direction.

Making Dryer/Drying Hopper Process Air Connections

Floor Mount Models

When making process air connections to your floor mounted dryer, ensure that you take into consideration and make arrangements for the following:

- Use high-temperature flexible dryer hose or rigid tubing to connect the dryer to the drying hopper.
- Keep the delivery hose to the drying hopper as short as possible to minimize heat loss. We strongly recommend insulated hose for maximum energy savings.
- Do not use insulated hose on the return from the drying hopper.
- The return air to the blower must be 150°F (66°C) or below. If the return air temperature is not below this point, you should purchase and install the optional aftercooler to remove excessive heat. Consult the manufacturer for more information. Aftercooler considerations also apply to machine-mount models.
- Make sure that hoses are not kinked or collapsed.
- Drying hopper air inlet and outlet locations vary, but always connect hoses so the dry process air from the dryer enters the bottom of the drying hopper and flows out the top to return to the dryer inlet.

Drying Hopper Air Trap Considerations

Our exclusive air trap assembly on the top of the drying hopper prevents ambient air from contaminating the material being dried. To ensure that your unit will operate at peak efficiency, do the following:

- Keep the material level at the mid point of the air trap
- This can be achieved by utilizing a hopper loader or vacuum conveying system to supply material to the drying system.

Figure 1: Drying Hopper Air Trap

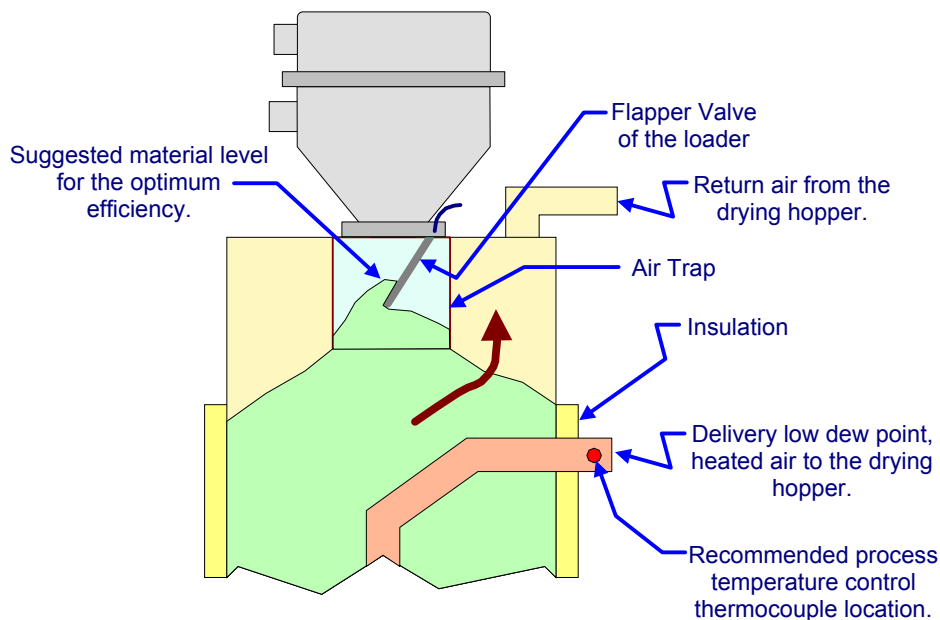

Optional Aftercooler

Water-cooled 15/30/60 cfm models use a water-to-air heat exchanger as an aftercooler. Cooling water is required for this design (3 gpm at 85°F or lower). Return air from the hopper passes through the air filter to trap fines and dust before entering the heat exchanger.

Installing Water Lines

(Hose and Hose Clamp)

When installing the water lines, ensure that the aftercooler utilizes either tower, chilled or city water as warm as 85°F (29°C). Recommended flow rate is three (3 gpm) gallons per minute (11 liters per minute).

3-5 Initial Start-up

Pre-Startup Checks

- Check the process and return hoses for tight connections.
- Check all companion equipment, such as the drying hopper; verify that the loading system is ready for operation.
- Verify that all dryer electrical connections are tight.

Starting Up the Dryer

1. Turn on (energize) the disconnect switch in your power drop, then turn on the one on the dryer.
2. Turn the system **ON/OFF** switch to **ON** to energize the display panel.
3. Close the slidegate at the bottom of the drying hopper.
Make sure that the blowers turn in the right direction.
4. Fill the drying hopper with material.
5. Turn the dryer **ON** switch to **START** to start the dryer.
The process blower starts.
6. If your dryer has a water-cooled aftercooler, make sure that sufficient cooling water (3gpm at 85°F or lower) flows properly through the coil and that you have bled any trapped air from the system. Make sure the aftercooler has the proper supply water temperature.
7. Set the process set point on the temperature controller.
8. After the proper pre-drying time for the initial hopper fill has elapsed, fully open the drying hopper slide gate.
9. Turn on the machine convey **ON/OFF** switch to **ON**, and set the convey timer for the proper conveying time.

Note: *To allow proper residence time during continuous processing, maintain the material level in the hopper at the midpoint of the air trap assembly.*

Auto-Tuning the Dryer

1. For Auto-tuning, press the beige button once. The AT screen will show with the setting OFF.
2. Press the UP arrow to change the setting to ON.
3. Press the beige button again to go back to the Temperature Screen. Your actual temperature will start to flash for about 10-20 minutes with the temperature fluctuating up and down during that period. After the flashing stops, it means auto-tuning has finished.

Shutting Down the Dryer

1. Turn off the conveying system supplying the drying hopper.
2. When processing is complete, close the hopper slide gate and shut down any in-line companion equipment, such as the aftercooler.
3. Turn the Dryer **ON/OFF** selector switch to **OFF**.
4. Turn the system **ON/OFF** switch to **OFF**.
5. If needed, empty the drying hopper.
6. For maintenance or a long term shutdown, open (de-energize) the electrical disconnects at the dryer and at the power drop.

Chapter 4: Operation

4-1 Start-up

1. Turn on (energize) the disconnect switch in your power drop, then turn on the one on the dryer.
2. Turn the system **ON/OFF** switch to **ON** to energize the display panel.
3. Close the slidegate at the bottom of the drying hopper.
Make sure that the blowers turn in the right direction.
4. Fill the drying hopper with material.
5. Turn the dryer **ON** switch to **START** to start the dryer.
The process blower starts.
6. If your dryer has a water-cooled aftercooler, make sure that sufficient cooling water (3gpm at 85°F or lower) flows properly through the coil and that you have bled any trapped air from the system. Make sure the aftercooler has the proper supply water temperature.
7. Set the process set point on the temperature controller.
8. After the proper pre-drying time for the initial hopper fill has elapsed, fully open the drying hopper slide gate.
9. Turn on the machine convey **ON/OFF** switch to **ON**, and set the convey timer for the proper conveying time.

Note: *To allow proper residence time during continuous processing, maintain the material level in the hopper at the midpoint of the air trap assembly.*

4-2 Controller Description and Operation

Identifying Control Panel Indicator Lights and Switches for the Standard Controller

Switches

System OFF/ON/START Switch. This switch energizes or de-energizes control power to the indicator panel and starts the dryer. (The controller can be energized without the dryer running.)

Optional Alarm Silence Switch. Press this switch to silence the horn when a high temperature process/regeneration or blower failure alarm activates.

Indicator Lights

Alarm Light. This feature works in conjunction with the alarm horn to warn the operator of a high bed safety temperature, a regeneration heater fault, or a blower failure. This warning is reset by pressing the alarm silence button.

Figure 4: Typical Dryer Control Panel



Process Air Temperature Controller

Our dryers use a microprocessor-based PID temperature controller for maintaining process air temperature. The controller is a modular, self-contained unit you can remove from the mounting housing. All parameters except for the process air set point are factory set and adjusted; normally, no field adjustment to the internal controls is necessary.

Figure 5: Typical Process Air Temperature Controller

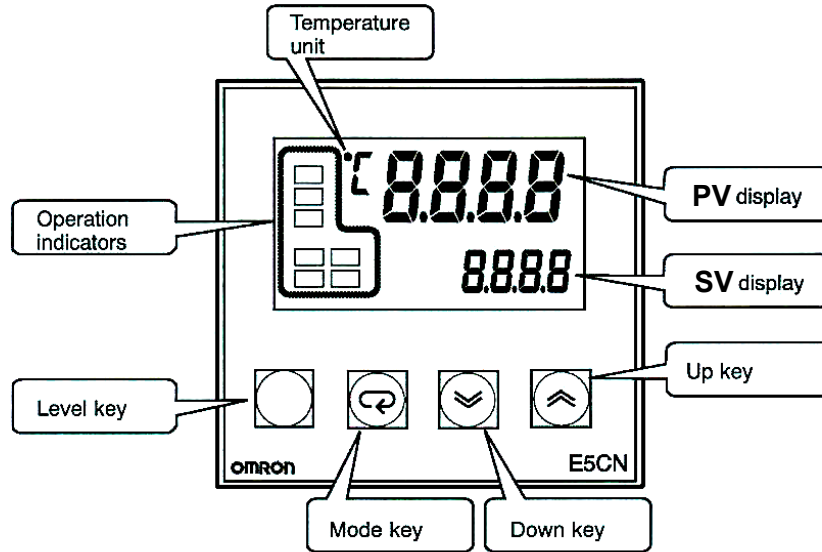

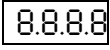
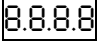

Identifying Process Air Temperature Controller LED Indicators

Indicator	Name	Description
PV 	Process Value Numeric LED	During normal operation, the process value (PV) numeric LED indicator displays the process temperature at the To Process thermocouple. It also lists parameters during setup and error messages if any errors occur.
SV 	Set Value Numeric LED	During normal operation, the set value (SV) numeric LED indicator displays the process set point temperature selected for the dryer. The dryer then maintains this set point temperature. This LED indicator also displays parameter and pre-set function values during configuration setup.
OUT1	Out 1 LED	Lit when Control Output 1 is on. The Out1 indicator lights when the controller signals the process heaters to be energized.
OUT2	Out 2 LED	Lit when Control Output 2 is on. Not used in this application.
AT	AT LED	Flashes during auto-tuning in process value (PV) screen.

Indicator	Name	Description
ALARM1	ALARM 1 LED	Lights in the Operation Indicator Section when the output function assigned to auxiliary output 1 turns on. The ALARM1 indicator lights when the process temperature exceeds the set point temperature by more than the alarm deviation value. Alarm output de-energizes the heaters. Heaters re-energize when the temperature falls within the acceptable range.



Identifying Temperature Controller Keys

Indicator	Name	Description
	Mode Key	Press the Mode key to shift the display to the next set of parameters. The menu screen displays.
	Down Key	Press the Down arrow key to lower the process air set point temperature. During setup, it lets you decrease the value of the parameter displayed on the set point LED readout.
	Up Key	Press the Up arrow key to raise the process air set point temperature. During setup, it lets you increase the value of the parameter displayed on the set point LED readout.

Setting the Process Air Temperature

When setting the process air temperature, consult with the resin manufacture for the recommended drying temperature.

To change the process air temperature set point with the dryer running:

- Press  to raise the set point to the temperature you want.
- Press  to lower the set point to the temperature you want.

Restoring the Process Air Temperature Controller (E5CN) to Factory Settings

If the preset parameters on the controller have been tampered with and it no longer properly controls temperature and displays dew point, you can restore the controllers to the factory setup. *Call the Service Department for detailed instructions.*

E5CN Operating Parameters

The E5CN controller has several mode selections. Within each mode are numerous parameters that can be set.



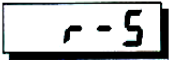
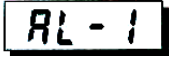

The factory has set the security level to protect the critical parameters from being accidentally changed. Below is an explanation of the operating modes you will have access to and on the following page are the manufacturers' default settings.

Available E5CN Modes

Operation Level

Indicator	Name	Description
	Run/Stop Mode (r-S)	When "RUN" is selected, the control is running. When "STOP" is selected, the control is stopped. When the control is stopped, the STOP display lights. The default is set to "RUN."
	Alarm Value 1 Mode (AL-1)	This setting is used to indicate how many degrees the process temperature will be allowed to exceed the set point temperature. An alarm output will de-energize the heaters.

Adjustment Level

Indicator	Name	Description
	Auto-Tune Mode (At)	See Page 19 of Chapter 3 for instructions on how to Auto-Tune your dryer. Note: <i>Although the controller is calibrated at the factory, the manufacturer recommends that the unit be Auto-Tuned prior to dryer startup.</i>
	Temperature Input Shift Mode (TnS)	This setting is used to offset an error between the set point and the actual temperature. The entire input range is shifted by a set figure preprogrammed by the operator.
	Proportional Band Mode (P)	This setting controls the amount in which the manipulated variable (MV) is proportionate to the deviated value or controller error.
	Integral Time Mode (I)	Setting this feature, gives the control an action that is proportionate to the time integral of the control error. By using this setting, proportional action is used in combination with integral action to offset the control error and the set point will begin to match the control temperature (PV or process value).
	Derivative Time Mode (d)	Setting the derivative control provides the controller with the ability to correct for a future error in the previously set process output.

Entering Operating Parameters to Select Modes

To enter the display:









1. Press the  Mode Display key to view the Run/Stop & Alarm 1 Modes.
2. Press  and  to set the higher or lower the values of the parameter or turn that function On or Off.
The **SV** readout displays the different values for the parameter within a mode.
3. To switch modes within a level, press and hold the  Level Display key for one (1) second.
The **PV** readout will display the different parameters within each mode.
4. Use short presses on the  Mode Display key to display each parameter within a mode.
The **SV** readout displays the different values for the parameter within a mode.
5. Press  and  to set the higher or lower the values of a parameter or turn that function On or Off.
6. Press  Level Key once to return to the Process Temperature Setting.

Figure 6: Settings for Process Temperature Controller (E5CN), Part No. A0555757

Mode	Parameter	Setting range	Default	Manuf. setting
Operation	Run/Stop	Run/Stop	Run	-
	Alarm value 1	-1999 to 9999	0	25
Mode	Parameter	Setting range	Default	Manuf. setting
Adjustment	AT execute/cancel	ON, OFF	OFF	?
	Temperature input shift	-199.9 to 999.9	0.0	-
	Proportional Band	0.1 to 999.9	8.0	?
	Integral Time	0 to 3999	233	?
	Derivative Time	0 to 3999	40	?

Process Air Dew Point Display

Optional

The Process Air Dew Point meter indicates the current process air delivery moisture content. Standard dryers use a microprocessor-based controller for displaying dew point air temperature. The controller is a modular, self-contained unit removable from the mounting housing. All parameters are factory set and adjusted; normally, no field adjustment to the internal controls are necessary.

Figure 7: Typical Dew Point Display Monitor

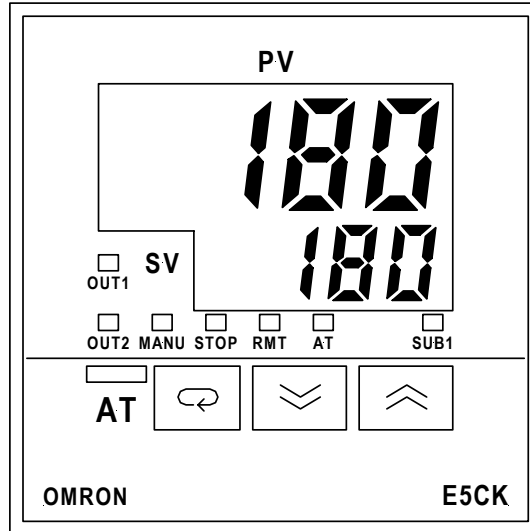

Note: The only functional buttons on this controller are the up and down keys.

Setting the High Dew Point Alarm

The high dew point alarm setting is changed by pressing the up and down keys to input the alarm value. The factory setting for Alarm Value 1 (*AL-1*) is -10°F (-23°C).

Restoring the Process Air Dew Point Meter (E5CK) to Factory Setup

If the preset parameters on the controller have been tampered with and it no longer functions properly, call the Service Department. ***This controller is not meant to be modified.***

Note: The dew point alarm monitors and indicates a deviation from the set point.

Redundant Safety Controller Display

Optional

The Redundant Safety Controller limits the process air temperature from exceeding the upper temperature range set by the E5CN Temperature Controller. Standard dryers use a microprocessor-based controller for limiting the process air temperature. The controller is a modular, self-contained unit removable from the mounting housing. All parameters are factory set and adjusted; normally, no field adjustment to the internal controls are necessary.

Figure 8: Typical Redundant Safety Controller Display

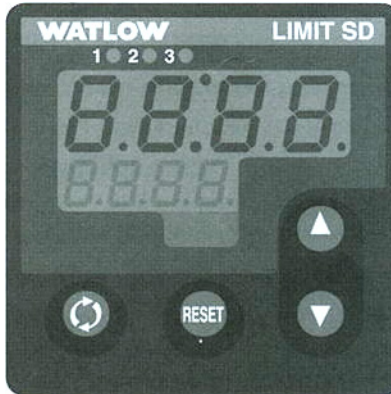

Setting the Redundant Safety Controller

The Redundant Safety Controller alarm setting is changed by pressing the up and down keys to input the alarm value. The upper display reading indicates the Process Value, while the lower display indicates the High Point Setting alarm value. The factory setting for the High Point Alarm Value (*L1-HI*) is 150°F (-23°C).

Restoring the WATLOW Redundant Safety Controller to Factory Setup

If the preset parameters on the controller have been tampered with and it no longer functions properly, call the Service Department. *This controller is not meant to be modified.*

WATLOW Operating Parameters

The WATLOW controller has only one mode selection; ALARM.

The factory sets the security level to protect the critical parameters from being accidentally changed. Below is an explanation of the modes you will have access to and the manufacturer default settings.

Entering Operating Parameters to Select Modes

To enter the display:





1. Press both the Up  and Down  keys for three seconds from the home page. The word **SEE** will appear in the upper display and **PAGE** will appear in the lower display.
2. Press the Advance Key  to move through the parameter prompts.
3. Press the Up  or Down  keys to change the parameter value.
4. Press the RESET Key at any time to return to the Home Page display.

Figure 9: Setting List for Redundant Safety Controller (WATLOW), Part No. A0555757

Mode	Parameter	Setting range	Default	Manf. setting
SEn	Sensor Type	0-3	0	-
Lin	Thermocouple Linearization	0-10	0	H (1)
C-F	Temperature Units	Fahrenheit / Celsius	F	-
S.dEC	Temp. Decimal Places	0 – 0.0	0	-
IS.En	INFOSENSE™	Yes / No	No	-
Sc.Lo	Process Scale Low	4.00 to 20.00 mA 1.00 to 10.00V	4.00 mA 1.00V	0
Sc.hi	Process Scale High	4.00 to 20.00 mA 1.00 to 10.00V	20.00 mA 5.00 V	400
CAL	Calibration Offset	-999 to 999	0	-
Ftr.E	Input Filter	Off, DiSP, Cont, both	OFF	-
Ot 1	Output 1 Function	Limit (2)	(2)	-
LSd1	Output 1 Limit Sides	Both, High, Low	Both	High
hyS1	Limit 1 Hysteresis	0.0 to 999.0	1.0	-
Ot2	Output 2 Function	Off / Process Alarm / Limit (2)	OFF	-
LSd2	Output 2 Sides	Both / high / low	Both	-
UdSP	Upper Display Look	None, Process Value, Limit 1 Low Set, Limit 1 High Set, Limit 2 Low Set, Limit 2 High Set, Alarm 2 Low Set, Alarm 2 High Set, Limit 3 Low Set, Limit 3 High Set, Alarm 3 Low Set, Alarm 3 High Set	Process	-
LdSP	Lower Display Look	None, Process Value, Limit 1 Low Set, Limit 1 High Set, Limit 2 Low Set, Limit 2 High Set, Alarm 2 Low Set, Alarm 2 High Set, Limit 3 Low Set, Limit 3 High Set, Alarm 3 Low Set, Alarm 3 High Set	Limit 1 High Set	-
LOC	Lockout	(0) no lockout, (1) Programming and Setup Page Locked, (2) Limit Set Points are the only Operation Page parameters accesible, (3) Full Lockout.	0	2

4-3 Dryer Operation Procedures

Controller Operation (Without Optional Alarm Horn & Reset Button)

1. Turn the disconnect on the control panel to the **ON** position. Power is applied to the voltage line fuses, line side of the control power switch and the temperature controller.
2. Turn the control power switch to the **ON** position. Power is applied to the programmable relay and dew point controller. The valve will move to the start position as follows:
 - a. The valve motor rotates until the cam switch makes 2 transitions.
 - b. If the cam switch does not make a transition within 10 seconds, a valve motor fault is generated. “**VALVE MTR**” is displayed on the relay screen, the alarm light is activated. The valve motor, heaters, and blower shut off.

To restart the dryer, cycle control power to deactivate the alarm light and restart the valve motor sequence.

Note: *The relay screen which contains the Alarm Display Messages is located inside the controller enclosure. For a list of Alarm Display Messages, see Page 35.*

WARNING! *Do not attempt to check the Alarms on the Controller located within the unit enclosure unless you are a qualified electrician!*



- c. The valve will normally complete one full cycle (revolution).
If the drying process shuts down due to an alarm, the dryer has been setup to have the following operational features:
 - The bed in process at power-down will remain in process.
 - The bed in regeneration at power-down will remain in regeneration.
 - The regeneration timing cycle will restart from the beginning.

3. Once the control power is on and no fault conditions exist, turning the OFF-ON-START switch to the START position will start the dryer as follows:
 - a. The process heater is turned on and controlled by the E5CN controller.
 - b. The process/regen blower is started.
 - c. The regen heater is turned on and the regeneration timing sequence is initiated. The regen heater is controlled by the E5C2 controller. For default timing settings for regeneration, see the table below.

Model	Heating	Cooling
15 cfm	35	30
30 cfm		
60 cfm	35	30

Note: *In a humid environment, you may change the setting to 40 / 25 for better results.*

4. If either the left or right bed safety temperature switch opens, a regen heater fault is generated. **“HIGH TEMP”** is displayed on the relay screen. The alarm light is activated. The process heater, regen heater, and process/regen blower are turned off.
Turn the Off-On-Start switch to the START position to deactivate the alarm light and restart the dryer. If the switch is still open, the dryer will not restart.
5. If the OMRON controller faults, the optional redundant high temperature safety device opens, or the process heater safety switch opens, a heater fault is generated. **“HIGH TEMP”** is displayed on the relay screen. The alarm light is activated. The process heater, regen heater, and process/regen blower are turned off.
Turn the OFF-ON-START switch to the START position to deactivate the alarm light and restart the dryer. If the fault condition still exists, the dryer will not restart.
6. If the process blower overload trips, a process blower fault is generated. **“PROC BLWR”** is displayed on the relay screen. The alarm light is activated. The process heater, regen heater, and process/regen blower are turned off.
Reset the motor overload and turn the Off-On-Start switch to the START position to deactivate the alarm light and restart the dryer.
7. The valve position limit switch enables the right bed heater and provides an input signal to the programmable relay when actuated by the cam lobe. When the cam lobe position is high, the right bed is activated. When the cam lobe position is low, the left bed is activated. Each heater is ON-OFF controlled by the OMRON E5C2 controller.
8. Upon completion of the HEAT portion of the regeneration sequence, the regen heaters are disabled by the programmable relay and the COOL time begins.
9. Once the Cool time has expired, the valve motor is turned on until the cam switch makes a transition. Upon making a transition, the timing sequence is restarted for the new bed.
10. When no fault conditions exist, the display reads **“SYSTEM NORMAL”**.

11. When a dew point fault is generated by the optional dew point controller, the alarm light will activate. The alarm light will flash, indicating a non-critical fault. Press Alarm Reset to deactivate the alarm until the next dew point fault occurs.
12. The top 2 lines of the display show the HEAT and COOL times (in minutes) for the regeneration sequence. Changes to these times can be made by the operator as follows:
 - a. Press the up or down arrow until the cursor is positioned at the number to be changed.
 - b. Press the “+” key to increment the number, or the “-“ key to decrement the number.
 - c. Press the “OK” key to accept the value and write to the relay memory.

OR

 - d. Press the “ESC” key to cancel the changes.

Note: *A change will NOT take effect until step 12-c is done.*

13. The dryer is shut off by turning the control power switch to the OFF position.
14. Refer to Schematic drawing A0566087 enclosed in the control enclosure.

Controller Operation (With Optional Alarm Horn & Reset Button)

1. Turn the disconnect on the control panel to the **ON** position. Power is applied to the voltage line fuses, line side of the control power switch and the temperature controller.
2. Turn the control power switch to the **ON** position. Power is applied to the programmable relay and dew point controller. The valve will move to the start position as follows:
 - a. The valve motor rotates until the cam switch makes 2 transitions.
 - b. If the cam switch does not make a transition within 10 seconds, a valve motor fault is generated. “**VALVE MTR**” is displayed on the relay screen, the alarm horn and light are activated. The valve motor, heaters, and blower shut off. Pressing the ALARM RESET pushbutton will deactivate the alarm horn and light.

Cycle control power to restart the dryer.

Note: *The relay screen which contains the Alarm Display Messages is located inside the controller enclosure. For a list of Alarm Display Messages, see Page 35.*

WARNING!



Do not attempt to check the Alarms on the Controller located within the unit enclosure unless you are a qualified electrician!

- c. The valve will normally complete one full cycle (revolution).

If the drying process shuts down due to an alarm, the dryer has been setup to have the following operational features:

 - The bed in process at power-down will remain in process.
 - The bed in regeneration at power-down will remain in regeneration.
 - The regeneration timing cycle will restart from the beginning.
3. Once the control power is on and no fault conditions exist, turning the Off-On-Start switch to the START position will start the dryer as follows:
 - a. The process heater is turned on and controlled by the E5CN controller.
 - b. The process/regen blower is started.
 - c. The regen heater is turned on and the regeneration timing sequence is initiated. The regen heater is controlled by the E5C2 controller. Default timing for regeneration is 35 minutes for HEATING and 30 minutes for COOLING.
4. If either the left or right bed safety temperature switch opens, a regen heater fault is generated. “**HIGH TEMP**” is displayed on the relay screen. The alarm horn and light are activated. The process heater, regen heater, and process/regen blower are turned off. Pressing the ALARM RESET pushbutton will deactivate the alarm horn and light.

Turn the Off-On-Start switch to the START position to restart the dryer. If the switch is still open, the dryer will not restart.

5. If the OMRON controller faults, the optional redundant high temperature safety device opens, or the process heater safety switch opens, a process heater fault is generated. **“HIGH TEMP”** is displayed on the relay screen. The alarm horn and light are activated. The process heater, regen heater, and process/regen blower are turned off. Pressing the ALARM RESET pushbutton will deactivate the alarm horn and light.

Turn the Off-On-Start switch to the START position to restart the dryer. If the fault condition still exists, the dryer will not restart.

6. If the process blower overload trips, a process blower fault is generated. **“PROC BLWR”** is displayed on the relay screen. The alarm horn and light are activated. The process heater, regen heater, and process/regen blower are turned off. Pressing the ALARM RESET pushbutton will deactivate the alarm horn and light.

Reset the motor overload and turn the Off-On-Start switch to the START position to restart the dryer.

7. The valve position limit switch enables the right bed heater and provides an input signal to the programmable relay when actuated by the cam lobe. Each heater is ON-OFF controlled by the OMRON E5C2 controller.
8. Upon completion of the HEAT portion of the regeneration sequence, the regen heaters are disabled by the programmable relay and the COOL time begins.
9. Once the COOL time has expired, the valve motor is turned on until the cam switch makes a transition. Upon making a transition, the timing sequence is restarted for the new bed.
10. When no fault conditions exist, the display reads **“SYSTEM NORMAL”**.
11. When a dew point fault is generated by the optional dew point controller, the alarm horn and light will activate. The alarm light will flash, indicating a non-critical fault. Press Alarm Reset to deactivate the alarm until the next dew point fault occurs.
12. The top 2 lines of the display show the HEAT and COOL times (in minutes) for the regeneration sequence. Changes to these times can be made by the operator as follows:
 - a. Press the up or down arrow until the cursor is positioned at the number to be changed.
 - b. Press the “+” key to increment the number, or the “-“ key to decrement the number.
 - c. Press the “OK” key to accept the value and write to the relay memory.

OR

- d. Press the “ESC” key to cancel the changes.

Note: *A change will NOT take effect until step 12-c is done.*

13. The dryer is shut off by turning the control power switch to the OFF position.
14. Refer to Schematic drawing A0566087 enclosed in the control enclosure.

Alarm Display Messages

Note: The relay screen which contains the Alarm Display Messages is located inside the controller enclosure.

WARNING! Do not attempt to check the Alarms on the Controller located within the unit enclosure unless you are a qualified electrician!



The following is a list of Alarm Display Messages which can be found on the relay screen:

Temperature Controller Alarm and/or
Regen Heater Temp Switch and/or
Process Heater Temp Switch and/or
Redundant Temp Safety

HIGH TEMP

Blower Overload

PROC BLWR

Valve Motor Time-Out

VALVE MTR

Multiple Alarms

PROC BLWR
HIGH TEMP
VALVE MTR

No Alarms

HEAT 35
COOL 30
SYSTEM
NORMAL

4-4 Auto-Tuning the Dryer

1. For Auto-tuning, press the beige button once. The AT screen will show with the setting OFF.
2. Press the UP arrow to change the setting to ON.
3. Press the beige button again to go back to the Temperature Screen. Your actual temperature will start to flash for about 10-20 minutes with the temperature fluctuating up and down during that period. After the flashing stops, it means auto-tuning has finished.

4-5 Shutting Down the Dryer

1. Turn off the conveying system supplying the drying hopper.
2. When processing is complete, close the hopper slide gate and shut down any in-line companion equipment, such as the aftercooler.
3. Turn the Dryer **ON/OFF** selector switch to **OFF**.
4. Turn the system **ON/OFF** switch to **OFF**.
5. If needed, empty the drying hopper.
6. For maintenance or a long term shutdown, open (de-energize) the electrical disconnects at the dryer and at the power drop.

Chapter 5: Maintenance

5-1 Preventative Maintenance Schedule

The checklist below contains a list of items which should be inspected and/or replaced to keep your Dehumidifying Dryer operating at peak efficiency. Perform each inspection at the regular intervals listed below.

System model #						Serial #							
Every week	Date/By	Date/By	Date/By	Date/By	Date/By	Date/By	Date/By	Date/By	Date/By	Date/By	Date/By	Date/By	Date/By
Inspect all filters for wear, replace/clean if dirty or worn.													
Check to make sure that all hose connections are air tight.													

Every month	Jan	Feb	Mar	Apr	May	Jun	Jul	Aug	Sep	Oct	Nov	Dec
Lock out electrical power and inspect electrical wiring for integrity.												
Lock out electrical power and check heater elements for continuity using an ohmmeter.												
Check dew point and temperature tracking with an external dew point monitor and pyrometer.												
Visually inspect the shifting of the airflow valve during one cycle.												

Every year	Next scheduled inspection	Actual inspection Date/By	Next scheduled inspection	Actual inspection Date/By
Inspect desiccant. Replace if brown or broken.				

Every two years	Scheduled replacement date	Actual replacement Date/Work done by	Scheduled replacement date	Actual replacement Date/Work done by
Replace desiccant.				

- Photocopy this page for your maintenance records -

5-2 Preventative Maintenance

This section describes maintenance procedures which will increase the longevity and efficiency of your dehumidifying dryer. Perform them at the regular intervals listed on the dryer checklist on the previous page.

Servicing Process Air Filters

Caution! *Operating the dryer without the process air filter installed voids your warranty!*

Filter cleaning is an important part of your dryer maintenance program.

Dehumidifying dryers have a single cartridge canister-type filter in the process air loop. The filter protects blowers from plastic fines drawn in from the drying hopper and prevents the desiccant from being contaminated. Regular filter cleaning is essential to keep your dryer operating at peak efficiency.

You can blow or vacuum the dirt out of the filter with compressed air, but remember, it could become damaged from high-pressure blowing.

Recommendations for Cleaning and Replacing Filters

- Turn off and/or lock out electrical power to the dryer.
- Remove the threaded fastener securing the filter access cover, then remove the cover.
- Remove the nut on the center retaining rod to remove the filter cartridge.

Figure 10: Air Filter Location and Disassembly

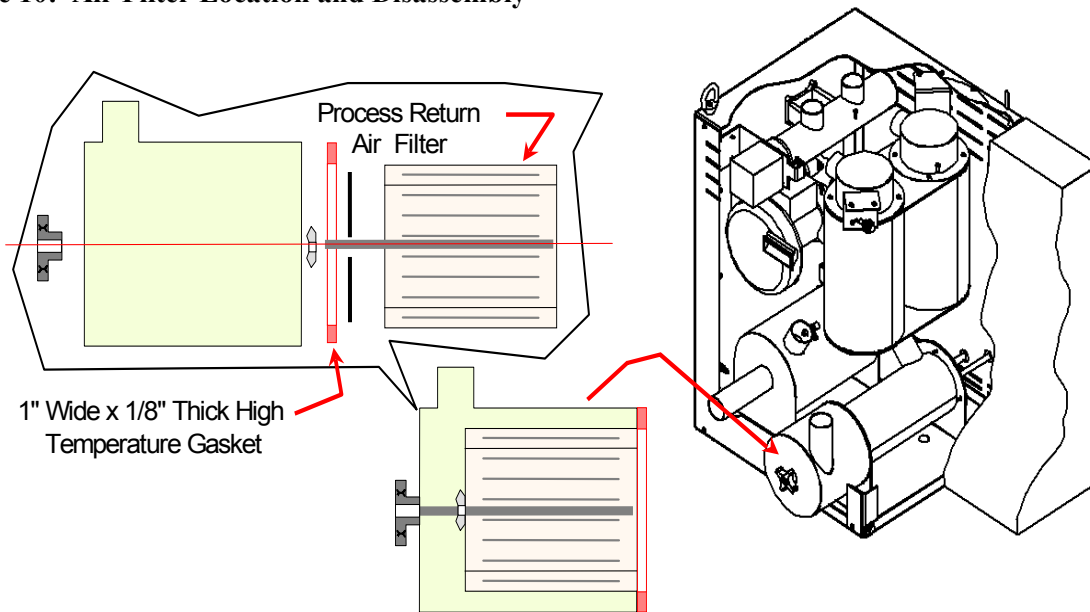

Vacuuming

Try vacuum-cleaning a soiled filter first. Vacuuming removes most large particles and surface contaminants, and may suffice for the first time you clean a filter. Use a commercial-duty (recommended) or household vacuum cleaner. Vacuum the filter from the air intake (dirty) side only.

Cleaning with Compressed Air

Blow clean, dry compressed air up and down the pleats, blowing out the filter from the inside out. Remove loose dirt from the filter with compressed air or vacuum from the outside.



Caution! *DO NOT clean/wash filter with water!*

After each cleaning:

- Inspect the filter element. *Briefly* hold a light bulb behind the element and look for any **fatigued paper** or residual dirt. Inspect for holes and tears by looking through the filter toward a bright light. Check for damaged gaskets or dented metal parts. Do not re-use a damaged filter!
- Check the gasket for damage. A damaged gasket allows contaminants into the process. Replace as needed.

Figure 2: Cooling Coil Location and Disassembly

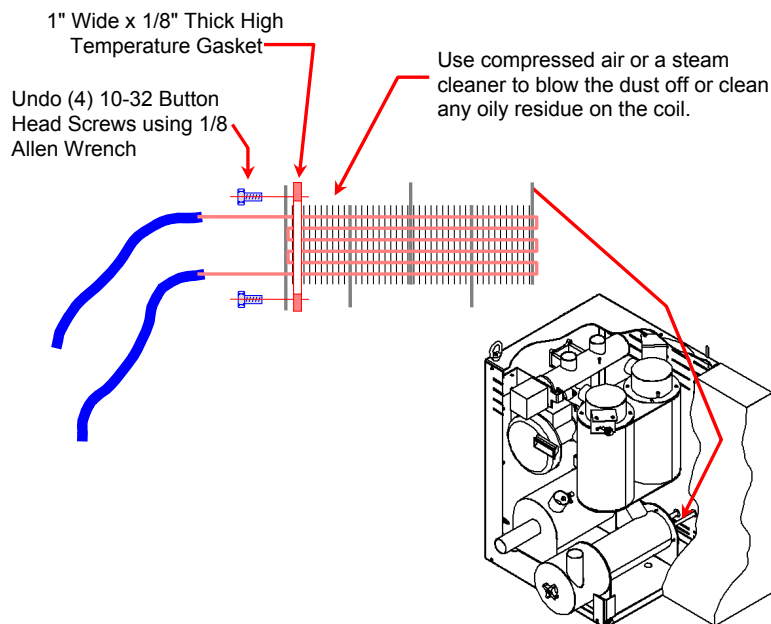

Note: *To clean the cooling coil, use compressed air or a steam cleaner to blow the dust off or clean any oily residue on the coil.*

Servicing the Dew Point Monitor

The accuracy of the dew point monitor on mini dryer systems depends on proper operation of the dew point sensor and the control board. The dew point sensor is in the process air stream and is therefore susceptible to contamination.

Dew point sensor life depends on:

- Air temperature and flow passing over the sensor.
- The amount of fines (dust) in the process air.
- The amount of plasticizer vapor in the process air.

Once every six months, the dryer operator should monitor the initial dew point sensor readings and establish a periodic replacement schedule as needed.

Caution!

Do not attempt to check the continuity or resistance of the dew point sensor.



The sensor will be destroyed!

5-3 Corrective Maintenance

This section provides you with the information necessary to correct or repair any issues which might appear during the normal operation of your dehumidifying dryer. Although we have listed how to perform these procedures, it is recommended that you call the Service Department to have any in-depth maintenance performed.

Symptoms of Worn Desiccant

The moisture absorption capacity of the desiccant used in your dehumidifying dryer degrades after an indefinite period of time. Useful life depends on variables such as material moisture content, plasticizer vapors in the return air, and number of regeneration cycles.

Your dryer may need new desiccant if it exhibits any of the following symptoms:

- The process air dew point measured with a portable dew point monitor is higher than -10°F (-23°C) throughout the process drying cycle.
- Noticeable amounts of desiccant in the beds is a medium-brown color or darker.

If you notice any of these signs, replace the desiccant in the desiccant beds. Desiccant replacement kits are available from the Parts Department. If you want, a technician can repack desiccant beds at your site.

WARNING! *Handling desiccant material is HAZARDOUS.*



Wear an N-100 type safety filter mask or equivalent to avoid prolonged breathing of desiccant dust. Wear safety goggles and gloves to avoid contact with eyes and skin.

- *Handle with adequate ventilation.*
- *Wash hands thoroughly after handling.*

+ FIRST AID +

In case of eye contact, immediately flush eyes with plenty of water for at least 15 minutes.

SEE A PHYSICIAN IMMEDIATELY IF IRRITATION PERSISTS.

Replacing Worn Desiccant

Caution!



DESICCANT BEDS ARE HOT DURING OPERATION.

To avoid burn hazard, make sure desiccant beds are sufficiently cool before replacing worn desiccant.

To access the Desiccant Bed:

1. Disconnect electrical power to the dryer.
2. Using a 1/8" Allen wrench, remove the four (4) 10-32 button head screws holding the Desiccant Cap to the Regeneration Heater.
3. Remove the Desiccant Cap.
4. With a shop vacuum, carefully remove all desiccant from each tower.

Figure 11: Desiccant Bed Location and Disassembly

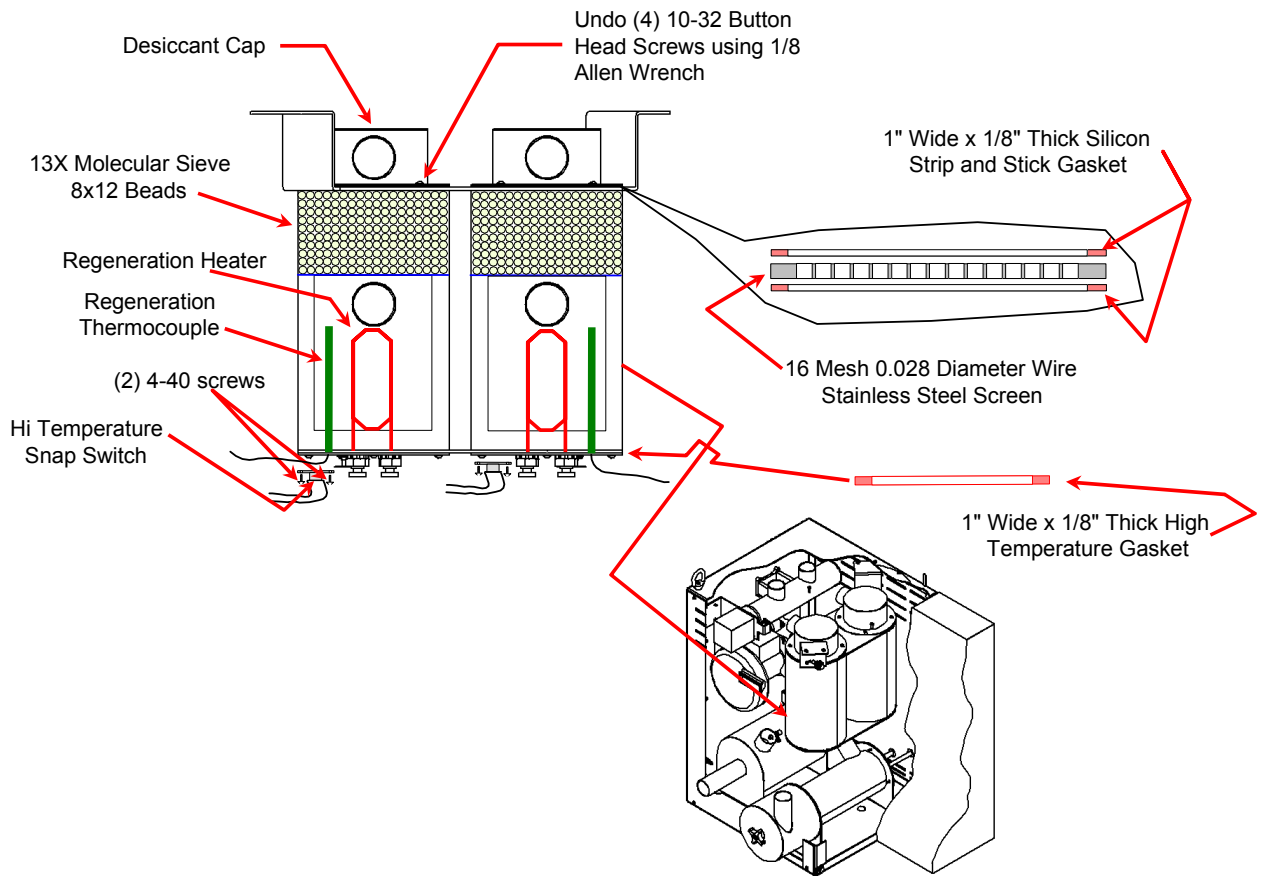

Caution! *You should properly dispose of any discarded desiccant. Consult local disposal regulations for more information.*

Inspect each lower desiccant screen for tears or holes where desiccant burned-through. Replace as needed.

After cleaning each chamber, add a level layer of half the 8 x 12 bead desiccant on top of the screen. Next, carefully add the full amount of bead desiccant specified per bed. Amounts are listed in the Desiccant Amounts Table below. Smooth the top level, and finally add another layer of the remaining bead desiccant to the top. Make sure this layer is level and smooth.

Repeat the previous step for the other bed.

Inspect the gaskets on the valve assembly. Replace if necessary.

Re-install the valve and reconnect actuator wiring.

Figure 12: Required Desiccant Amounts

Dryer model	8 x 12 bead Total		
	Part no.	lbs.	Kg
15 cfm	W00018051	4.75	2.15
30 cfm		12.25	5.56
60 cfm		27.5	12.5

Replacing the Process Heater

The dehumidifying dryers utilize a single-phase Calrod-type heater element. This heater element is mounted in the center compartment below the desiccant beds. Although the replacement procedure is the same for each heater, the wattage varies by model, voltage, temperature range, etc.

WARNING! *Hazardous electrical current present.*



Disconnect and lock out power before you replace heater elements!

Figure 13: Process Heater Location and Disassembly

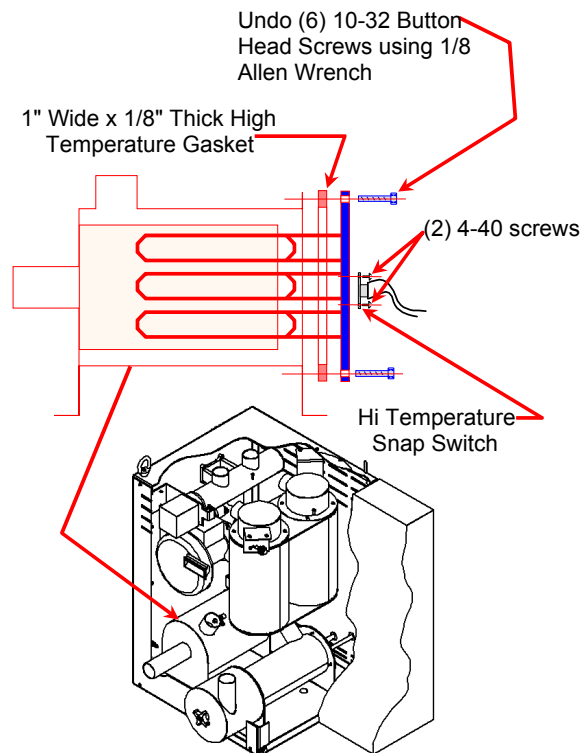

Procedures

1. Remove the six (6) 10-32 button head screws securing the process heater access cover using a 1/8" Allen wrench.
2. Sketch the heater wiring configuration so you can properly re-wire the heater.
3. Remove the wires to the heater plate assembly being removed or replaced.
4. Remove the two (2) 4-40 screws securing the heater plate assembly, and slide out the assembly.
5. Remove the heater from the mounting plate by removing the large brass nuts and washers.
6. Re-install the heater and heater plate assemblies in reverse order. Install new heater gaskets and securely tighten all fasteners.

Caution! *Heater loops should not touch each other.*

"Hot spots" lead to premature heater failure!

7. Reinstall the wires based on the sketch you made earlier.

Chapter 6: Troubleshooting

6-1 Introduction

The utmost in safety precautions should be observed at all times when working on or around the machine and the electrical components. All normal trouble-shooting must be accomplished with the power off, line fuses removed, and with the machine tagged as out of service.

The use of good quality test equipment cannot be over-emphasized when troubleshooting is indicated. Use a good ammeter that can measure at least twice the AC and DC current that can be encountered for the machine. Be sure that the voltmeter has at least minimum impedance of 5,000 OHMS-per-volt on AC and 20,000 OHMS-per-volt on DC scales. Popular combination meters, VOM and VTVM can be selected to provide the necessary functions.

Before making haphazard substitutions and repairs when defective electrical components are malfunctioning, we recommend that you check the associated circuitry and assemblies for other defective devices. It is common to replace the obviously damaged component without actually locating the real cause of the trouble. Such hasty substitutions will only destroy the new component. Refer to wiring diagrams and schematics.

Locating mechanical problems, should they occur, is relatively straightforward. When necessary, refer to the parts catalog section.

Problem	Possible cause	Corrective action
Little or no air coming from the process delivery tube.	Dirty filter.	Clean or replace filter.
	Desiccant beds are contaminated by material or plasticizer leaking into the system.	Replace desiccant. See Page 42 for more information.
	Blower overload has tripped.	Fix the problem and reset the overload.
	Blower fins filled with dust or contaminants.	Remove blower side plate, clean baffles, replace.
Suction in delivery tube, pressure from the return tube.	Phase is reversed on power drop coming into the dryer.	Stop the dryer. If the dryer was connected to the drying hopper, check to see if the desiccant and process air heater has been contaminated with resin. If so, replace the desiccant and remove any resin carry-over. Otherwise, change the phase of two legs of the three-phase power drop.

Problem	Possible cause	Corrective action
Loss or reduction of process air temperature.	Process heaters are faulty.	Check for open heaters. Replace if required.
	Solid-state temperature controller faulty.	Replace.
	Process temperature was adjusted in error by plant personnel.	Make sure that plant personnel are aware of the proper temperature set point. Post an appropriate sign next to the controller.
Loss or reduction in drying capacity.	Process heaters are faulty.	Replace.
	Desiccant beds are contaminated.	Replace desiccant.
	Material being dried differs from material specified at the time of purchase.	Drying systems are designed for the material which was originally specified. Different materials may need a longer residence time or a different drying temperature.
	Break in flex hose to/from drying hopper.	Inspect for air leaks; replace as needed.
	Airflow valve sticking or failing to shift.	Check for proper operation of valve actuators. Repair or replace if necessary.
	Blower fins filled with dust or contaminants.	Remove blower side plate, clean baffles, replace. Replace filter elements.
PLC Regeneration Bed LED indicators both off.	Insufficient power to PLC (Power LED is off).	Check power supply and power wiring to PLC.
	Faulty PLC (PLC Power light is on, Run light is off, and/or Error light is on).	Replace PLC.
PLC Regeneration Heater Left/Right output indicators both off.	Regenerating bed cooldown.	None.
	Blower Input indicator is off.	Verify that blower contactor is on. Check input wiring to PLC.
	Process air in high-temperature condition.	None.
	Insufficient power to PLC (Power light is off).	Check power supply and power wiring to PLC.
	Faulty PLC (PLC Power light is on, Run light is off, and/or Error light is on).	Replace PLC.

Problem	Possible cause	Corrective action
Material in drying hopper cakes, or meltdown occurs.	Process temperature set too high due to operator error.	Check resin manufacturer's data sheet for proper drying temperature. Make sure plant personnel are aware of the correct process temperature set point.
	High temperature alarm not set properly.	Reset high temperature alarm.
	Process set point is out of acceptable range.	Restore temperature controller to factory pre-sets.
	Function set for degrees Celsius (°C), set point at degrees Fahrenheit (°F).	Verify correct Celsius or Fahrenheit settings.
	Process thermocouple not in airflow.	Verify that the thermocouple is properly installed in the inlet tube.
Poor dew point performance.	Burned out regeneration heater.	Repair or replace.
	Contaminated or worn out desiccant.	Replace.
	Leaking process air hoses.	Repair or replace.
	Dryer operates beyond its capacity.	Check dryer and drying hopper sizing.
	Bad dew point sensor.	Replace.
	Fouled dew point sensor manifold.	Clear obstruction. Air should flow freely through sensor.
	Dirty filter.	Clean or replace filter element.
Nothing displays when the controller is turned on.	The internal mechanism is not inserted properly into the housing.	Properly insert the internal mechanism into the housing.
	The power supply is not connected to its terminals properly.	Properly connect the power supply to the power supply terminals.
	No power is supplied, or the supplied power is not within the specified range.	Supply a voltage of 85 to 125 VAC to the power supply terminals of the controller.
	Disconnect switch or Control Power switch not set to ON . Control Power fuse blown.	Check control power fuse for continuity. Turn disconnect switch and control power switch ON .

Problem	Possible cause	Corrective action
No setting change possible on temperature controller.	The key protection switch is set to ON .	Set the key protection switch to OFF .
Process value is abnormal or not obtained.	Input polarity on thermo-couple is wrong or connection is wrong.	Properly wire the terminals.
	Input-type setting is incorrect.	Properly set the input with the input-type selector rotary switch.
	No compensating lead wires used for extension of the thermocouple.	Use proper compensating lead wires and terminals.
	Thermocouple and controller are connected by wires other than proper lead wires.	Use a dedicated thermocouple connector. If a connector is a metal different from the thermocouple and controller, a temperature error may result.
	Process thermocouple not in airflow.	Verify that the thermocouple is properly installed in the inlet tube.
	Sensor is broken or short-circuited.	Replace with a good sensor.
	The controller is influenced by noise or other induction.	Separate input wires as far as possible from the origin of the noise.
	Celsius temperatures used instead of Fahrenheit or vice versa.	Check Mode selector switch 6 : <ul style="list-style-type: none"> • ON - °F • OFF - °C
Process value shifted because the input shift function is used.	Set input shift value to 0 , or set mode selector switch 4 to OFF .	

6-2 Determining Temperature Controller Errors or Sensor Errors

Using a Thermocouple

If the controller displays a temperature that is close to room temperature (70°F/21°C) when you short-circuit controller input terminals, the controller is normal and the sensor is probably broken, short-circuited, or incorrectly wired.

Using a Platinum Resistance Thermometer

If the controller displays a temperature of about 0.0°C (32°F) when you insert a 100-ohm resistor between terminals **A** and **-B** of the controller, and you short-circuit controller terminals **+B** and **-B**, the controller is normal and the sensor is probably broken, short-circuited, or incorrectly wired.

Other service problems or questions can be answered by contacting the Service Department.

Chapter 7: Appendix

7-1 Warranty

Unless otherwise specified, this product includes a Standard ONE YEAR PARTS WARRANTY.

Warranty Specifications

The manufacturer hereby expressly warrants all equipment manufactured by it to be free from defects in workmanship and material when used under recommended conditions, as set forth in the operating manuals for such equipment. THE FOREGOING EXPRESS WARRANTY IS EXCLUSIVE AND IN LIEU OF ALL OTHER WARRANTIES, GUARANTEES, AGREEMENTS, AND SIMILAR OBLIGATIONS OF THE COMPANY AND/OR MANUFACTURER (UNLESS OTHERWISE SPECIFIED IN THE SPECIFIC PRICE PAGE OR LIMITED BY THE MANUFACTURERS' WARRANTY FOR PARTS). The Company's obligation is limited to repair or replace FOB the factory any parts that are returned, prepaid, within one year of equipment shipment to the original purchaser, and which in the Company's opinion, are defective. Any replacement part assumes the unused portion of this warranty.

Warranty Restrictions

This parts warranty does not cover any labor charges for replacement of parts, adjustment repairs, or any other work. This warranty does not apply to any equipment which, in the Company's opinion, has been subjected to misuse, negligence, or operation in excess of recommended limits, including freezing or which has been repaired or altered without the Company's express authorization. If the serial number has been defaced or removed from the component, the warranty on that component is void. Defective parts become the property of the warrantor and are to be returned immediately, without any further use or handling.

Warranty Liabilities

THE COMPANY EXPRESSLY DISCLAIMS ANY AND ALL LIABILITY FOR ANY SPECIAL, CONSEQUENTIAL OR INCIDENTAL DAMAGES OR EXPENSES THAT RESULT FROM THE USE OF THIS PRODUCT. Some states do not allow the exclusion or limitation of special, consequential or incidental damages, so the above limitation may not apply to you. The Company's obligation for parts not furnished as components of its manufactured equipment is limited to the warranty of the manufacturers of said parts. The company neither assumes nor authorizes any other persons to assume for it any liability in connection with the sale of its equipment not expressed in this warranty. No person, agent, manufacturer, distributor, dealer, installer or company is authorized to change, modify or extend the terms of this warranty in any manner whatsoever.

The time within which an action must be commenced to enforce any obligation of the Company's arising under this warranty, or under any statute or law of the United States or any state thereof, is hereby limited to the duration of this warranty. Some states do not permit this limitation, so the above may not apply to you. This warranty gives you specific legal rights and you may also have other rights which vary from state to state. For transactions involving the potential applicability of international law or that of a foreign country, this warranty policy and the procedures hereunder shall be governed by applicable federal and state law, but not by the United Nations Convention on Contracts for the Sale of Goods.

Customer Responsibilities

Any sales, use, or other tax incident to the replacement of parts under this warranty is the responsibility of the purchaser.

7-2 Optional Components

The following is a list of options which your Dehumidifying Dryer may have been equipped with:

- **Dew Point Monitor**
- **Audible Alarm with Silence Button**
- **High Temperature Option (with Aftercooler)**
- **Casters**
- **API PLC Control System**

7-3 Technical Specifications

Annex B Information

The following design information is provided for your reference:

1. No modifications are allowed to this equipment that could alter the CE compliance
2. Ambient temperature: 0 degrees Celsius – Maximum (104 degrees Fahrenheit)
3. Humidity range: 50% relative humidity
4. Altitude: Sea level
5. Environment: Clean, dust-free and non-explosive
6. Radiation: None
7. Vibration: Minimal, i.e. machine mounting
8. Allowable voltage fluctuation: +/- 10%
9. Allowable frequency fluctuation: Continuous +/- 1%
Intermittent +/- 2%
10. Nominal supply voltage: 460/3/60 (Verify on serial number tag)
11. Earth ground type: TN (system has one point directly earthed through a protective conductor)
12. Power supply should include a ground connection.
13. Over-current protection is supplied in the dryer, but additional protection should be supplied by the user.
14. The door-mounted disconnect serves as the electrical disconnect device.
15. Dryer is not equipped with local lighting.
16. Functional identification
17. Dryer is equipped with a CE mark
18. Dryer is supplied with an operating manual in the language of the destination country.
19. Cable support may be required for power cord, depending on final installation.
20. No one is required to be in the interior of the electrical enclosure during the normal operation of the unit. Only skilled electricians should be inside the enclosure for maintenance.
21. Doors can be opened with a screwdriver, but no keys are required.
22. Two-hand control is not required or provided.
23. All dryers should be moved around and set in a place with a lift truck or equivalent.
24. There are no frequent repetitive cycles that require manual control—repetitive functions are automatic while the dryer is operating.
25. An inspection report detailing the functional test is included with the dryer.
26. The machine is not equipped with cableless controls.
27. Color-coded (harmonized) power cord is sufficient for proper installation.

Figure 19: Level 2 & 3 Spare Parts List (Electrical & Mechanical)

MINI DRYER SPARE PARTS LIST AD15, AD30, AD60			15CFM	15CFM	15CFM	15CFM	15CFM	15CFM	30CFM	30CFM	30CFM	30CFM	30CFM	30CFM	30CFM	60CFM	60CFM	60CFM	60CFM	60CFM	60CFM	
			208V 3PH	220V 50 HZ 3PH	230V 3PH	400V 50 HZ 3PH	460V 3PH	575V 60 HZ 3PH	208V 3PH	220V 50 HZ 3PH	230V 3PH	400V 50 HZ 3PH	460V 3PH	575V 60 HZ 3PH	208V 3PH	220V 50 HZ 3PH	230V 3PH	400V 50 HZ 3PH	460V 3PH	575V 60 HZ 3PH		
LEVEL 2 (Electrical Components)																						
PART #	SIZE	Description																				
A0558000		Motor Starter																				
A0530042		Mercury Heater Contactor																				
A0567917		Process Air Temperature Controller																				
A0544089		Regeneration Air Temperature Controller																				
A0558065	*	Dew Point Monitor																				
A0548555	*	Dew Point Circuit Board																				
A0505417		Regeneration T\Couple Relay																				
LEVEL 2 (Mechanical Components)																						
PART #	SIZE	Description																				
A0548621		Ceramic Cap for the End of Heater Elements																				
A0566478		750 Watts Heater element 208/220 Volts																				
A0566479		750 Watts Heater element 230 Volts																				
A0566480		750 Watts Heater element 400 Volts																				
A0566481		750 Watts Heater element 460 Volts																				
A0566482		750 Watts Heater element 575 Volts																				
A0566483		1250 Watts Heater Element 208/220 Volts																				
A0566484		1250 Watts Heater Element 230 Volts																				
A0566485		1250 Watts Heater Element 400 Volts																				
A0566486		1250 Watts Heater Element 460 Volts																				
A0566487		1250 Watts Heater Element 575 Volts																				
A0566601		2500 Watts Heater Element 208/220 Volts																				
A0566602		2500 Watts Heater Element 230 Volts																				
A0566603		2500 Watts Heater Element 400 Volts																				
A0566604		2500 Watts Heater Element 460 Volts																				
A0566605		2500 Watts Heater Element 575 Volts																				
A0568139		Screen Cover for the Desiccant Tanks																				
A0568140		Screen Cover for the Desiccant Tanks																				
A0568141		Screen Cover for the Desiccant Tanks																				
A0566682		1/4" OD Teflon Tube.																				
A0566415		Washer / Gasket for the Heater Elements																				
MINI DRYER SPARE PARTS LIST AD15, AD30, AD60																						
LEVEL 3 (Electrical Components)																						
PART #	SIZE	Description																				
A0567921		Power Disconnect																				
A0566096		Mitsubishi Programmable Relay Logic Controller																				
A0568961		Redundant Temperature Safety Controller																				
LEVEL 3 (Mechanical Components)																						
PART #	SIZE	Description																				
A0534059		2" O.D. by 12 Ft Long Hi Temp Hose.																				
A0534060		2-1/2" O.D. by 12 Ft Long Hi Temp Hose.																				
A0566535		Return Air Cooling Coil																				
A0536628		208/460 Volt Process Blower.																				
A0536629		575 Volt Process Blower																				
A0534079		208/460 Volt Process Blower.																				
A0535351		575 Volt Process Blower																				
A0552439		208/460 Volt Process Blower.																				
A0552440		575 Volt Process Blower																				

7-6 Returned Material Policy

Credit Returns

Prior to the return of any material **authorization** must be given by **the manufacturer**. A RMA number will be assigned for the equipment to be returned.

Reason for requesting the return must be given.

ALL returned material purchased from **the manufacturer** returned is subject to 15% (\$75.00 minimum) restocking charge.

ALL returns are to be shipped prepaid.

The invoice number and date or purchase order number and date must be supplied.

No credit will be issued for material that is not within the manufacturer's warranty period and/or in new and unused condition, suitable for resale.

Warranty Returns

Prior to the return of any material, authorization must be given by **the manufacturer**. A RMA number will be assigned for the equipment to be returned.

Reason for requesting the return must be given.

All returns are to be shipped prepaid.

The invoice number and date or purchase order number and date must be supplied.

After inspecting the material, a replacement or credit will be given, at **the manufacturer's** discretion. If the item is found to be defective in materials or workmanship, and it was manufactured by our company, purchased components are covered under their specific warranty terms.

7-7 Safety Tag Information

Dryer Safety Tags



Hot!



**Read Operation
and Installation
Manual**



**High Voltage
Inside Enclosure**



Earth Ground



Lifting Point



**Protected Earth
Ground**

7-8 Dryer Identification (Serial Number) Tag

(Located on back of Dryer)

Company Logo	
	XXX Series Dryer
Model Number XXX-15	
Max Drying Capacity HR	
460V	Serial Number 060701R
1Ø	Date of Manufacture 06/2003
4.5A	
Over-current Protection Device (s) 4.5A Total	
Frequency 50/60Hz	
Compressed air supply None	
Dryer Mass 400 lbs/(180 KG)	
Electrical Diagrams & Pneumatic Diagram	<input type="text"/>
Street Address	City, State Zip Code
Telephone Number	

7-9 Technical Assistance

Parts Department

Call toll-free 7am–5pm CST [800] 423-3183 or call [630] 595-1060, Fax [630] 475-7005

The ACS Customer Service Group will provide your company with genuine OEM quality parts manufactured to engineering design specifications, which will maximize your equipment's performance and efficiency. To assist in expediting your phone or fax order, please have the model and serial number of your unit when you contact us. A customer replacement parts list is included in this manual for your convenience. ACS welcomes inquiries on all your parts needs and is dedicated to providing excellent customer service.

Service Department

Call toll-free 8am–5pm CST [800] 233-4819 or call [630] 595-1060

Emergencies after 5pm CST, call [847] 439-5655

We have a qualified service department ready to help. Service contracts are available for most products.

Sales Department

Call [630] 595-1060 Monday–Friday, 8am–5pm CST

Our products are sold by a world-wide network of independent sales representatives. Contact our Sales Department for the name of the sales representative nearest you.

Contract Department

Call [630] 595-1060 Monday–Friday, 8am–5pm CST

Let us install your system. The Contract Department offers any or all of these services: project planning; system packages including drawings; equipment, labor, and construction materials; and union or non-union installations.

Free Manuals Download Website

<http://myh66.com>

<http://usermanuals.us>

<http://www.somanuals.com>

<http://www.4manuals.cc>

<http://www.manual-lib.com>

<http://www.404manual.com>

<http://www.luxmanual.com>

<http://aubethermostatmanual.com>

Golf course search by state

<http://golfingnear.com>

Email search by domain

<http://emailbydomain.com>

Auto manuals search

<http://auto.somanuals.com>

TV manuals search

<http://tv.somanuals.com>