

Operating Instructions

Dehumidified Air Dryer STT 800 with Siemens S7 control unit

Please note that our address and phone information has changed. Please reference this page for updated contact information.



These manuals are obsolete and are provided only for their technical information, data and capacities. Portions of these manuals detailing procedures or precautions in the operation, inspection, maintenance and repair of the products may be inadequate, inaccurate, and/or incomplete and shouldn't be relied upon. Please contact the ACS Group for more current information about these manuals and their warnings and precautions.

Parts and Service Department

The ACS Customer Service Group will provide your company with genuine OEM quality parts manufactured to engineering design specifications, which will maximize your equipment's performance and efficiency. To assist in expediting your phone or fax order, please have the model and serial number of your unit when you contact us. A customer replacement parts list is included in this manual for your convenience. ACS welcomes inquiries on all your parts needs and is dedicated to providing excellent customer service.

For immediate assistance, please contact:

- North, Central and South America, 8am – 5pm CST +1 (800) 483-3919 for drying, conveying, heating and cooling and automation. For size reduction: +1 (800) 229-2919.
North America, emergencies after 5pm CST (847) 439-5855
North America email: acsuscanadacustserv@corpemail.com
- Mexico, Central & South America
Email: acslatinamericacustserv@corpemail.com
- Europe, Middle East & Africa +48 22 390 9720
Email: acseuropecustserv@corpemail.com
- India +91 21 35329112
Email: acsindiacustserv@corpemail.com
- Asia/Australia +86 512 8717 1919
Email: acsasiacustserv@corpemail.com

Sales and Contracting Department

Our products are sold by a worldwide network of independent sales representatives. Contact our Sales Department for the name of the sales representative nearest you.

Let us install your system. The Contract Department offers any or all of these services: project planning; system packages including drawings; equipment, labor, and construction materials; and union or non-union installations.

For assistance with your sales or system contracting needs please Call:

North, Central and South America +1 (262) 641-8600 or +1 (847) 273-7700 Monday–Friday, 8am–5pm CST

Europe/Middle East/Africa +48 22 390 9720

India +91 21 35329112

Asia/Australia +86 512 8717 1919

Facilities:

ACS offers facilities around the world to service you no matter where you are located. For more information, please visit us at www.acscorporate.com

United States:

ACS Schaumburg – Corporate Offices

1100 E. Woodfield Road
Suite 588
Schaumburg, IL 60173
Phone: + 1 847 273 7700
Fax: + 1 847 273 7804

ACS New Berlin – Manufacturing Facility

2900 S. 160th Street
New Berlin, WI 53151
Phone : +1 262 641 8600
Fax: + 1 262 641 8653

Asia/Australia:

ACS Suzhou

109 Xingpu Road SIP
Suzhou, China 215126
Phone: + 86 8717 1919
Fax: +86 512 8717 1916

Europe/Middle East/Africa:

ACS Warsaw

Ul. Działkowa 115
02-234 Warszawa
Phone: + 48 22 390 9720
Fax: +48 22 390 9724

India

ACS India

Gat No. 191/1, Sandbhor Complex
Mhalunge, Chakan, Tal Khed,
Dist. Pune 410501, India
Phone: +91 21 35329112
Fax: + 91 20 40147576

Sterling Material Processing

5200 West Clinton Ave.

Milwaukee, WI 53223

Telephone: (414) 354-0970

Fax: (414) 354-6421

www.sterlco.com

Technical service:

Service department

Telephone: (800) 423-3183

Edition: 06/02

Order confirmation number: _____

These operating instructions are for:*

(* Please fill in personally)

Serial number: _____

Built in: _____

Date of delivery: _____

Number of delivery: _____

Date of commissioning: _____

Location: _____

Group of machines: _____

Sterling Material Processing retains all rights to change the information in these operating instructions at any time without notice.

We assume no liability for any errors or direct or indirect damage resulting in context with these operating instructions.

Copying, translation or publication in any form except for personal use of purchaser requires approval from Sterling Material Processing.

All rights reserved.

TABLE OF CONTENTS

1. General Information	1-1
1.1. Warnings and symbols	1-2
1.2. Explanations and information	1-3
1.3. Legal basis	1-3
1.4. Fields of applications	1-3
1.5. Notes on Usage	1-3
2. Safety instructions	2-1
2.1. For your safety	2-2
2.2. For the safety of the devices	2-5
3. Start-up	3-1
3.1. Control system	3-2
3.1.1. Key assignment	3-2
3.1.2. Flow chart	3-3
3.2. Switching on the dryer	3-4
3.2.1. Operation statuses	3-4
3.3. Viewing the software-version	3-5
3.4. Passwords	3-5
3.5. Basic parameters	3-7
3.5.1. Turning the devices on/off	3-7
3.5.2. Entering dryer values	3-9
3.5.3. Entering hopper values	3-11
3.5.4. Observing processing status	3-13
3.5.5. Setting date and time	3-14
3.5.6. Viewing/changing language and contrast	3-15
3.5.7. Changing parameters	3-16
3.5.8. Setting the timer	3-17
3.6. Starting continuous operation	3-18
3.7. Viewing system runtime	3-19
3.8. Switching the dryer off	3-20
4. Error and error correction	4-1

5. Maintenance	5-1
5.1. Maintenance intervals	5-3
5.2. Cleaning/renewing the air filters	5-4
5.3. Tensioning the V-belts	5-8
5.4. Disposing of the drying agent	5-10
5.5. Servicing the accessories	5-10
5.6. Changing the battery of the control system	5-11
5.6.1. Resetting the control values	5-13
6. Functional description	6-1
6.1. Dryer	6-2
6.2. Drying hopper (optional)	6-3
6.3. Return air cooler (optional)	6-4
6.4. Pre air cooler (optional)	6-4
6.5. Hopper heaters (optional)	6-5
6.6. Automatic motor flaps (optional)	6-5
6.7. Connection to a pneumatic conveying system (optional)	6-5
7. Transport, Assembly and Storage	7-1
7.1. Transport and Packing	7-2
7.2. Assembly	7-4
7.3. Storage	7-4
8. Assembly instructions	8-1
8.1. Mounting of the suction device for regeneration exhaust air	8-2
8.2. Connection of the air coolers (optional)	8-2
8.3. Electrical connection	8-3
9. Technical Data	9-1

10. Spare parts list **10-1**

10.1. Switching Cabinet and Operating Unit 10-4

11. Electrical manual **11-1**

Connection diagram no.: _____

Currently not available; will be delivered at a later date!

12. Accessories **12-1**

Entering values on the OP 7 / 17

Flap control with Fuzzy-Logic

Elektror High-pressure blower with frequency converter operation

Elektror High-pressure blower

1. General Information



These operating instructions are addressed to all users of the device.

These operating instructions must be used by every person charged with work on the unit.

1.1. Warnings and symbols

The following warnings and symbols are used in these operating instructions:



This symbol indicates danger to life! Fatal or serious injury is possible if the corresponding instructions, regulations or warnings are not observed.



This symbol indicates that serious injury is possible if the corresponding instructions, regulations or warnings are not observed.



This symbol indicates that extensive damage to equipment is possible if the corresponding instructions, regulations or warnings are not observed.



This symbol indicates information important for becoming familiar with the equipment, i.e. technical correlations.



This symbol indicates that a technical term is explained at this point.

1.2. Explanations and information

Various terms and designations are used in these operating instructions to ensure clarity. Therefore please note that the terms used in the text stand for the corresponding explanations listed below.

- **Equipment**
"Equipment" can mean an individual unit, a machine or an installation.
- **Operating personnel**
The "operating personnel" are persons operating the equipment on their own responsibility or according to instructions.
- **Operator**
The "operator" of the equipment (production manager, foreman, etc.) is the person responsible for all production sequences. The operator instructs the operating personnel of what is to be done.
- **Operating instructions**
The "operating instructions" describe the interaction of the equipment, production sequences or methods. The operating instructions must be compiled by the operator of the equipment.
- **Equipment foreman**
When several operating personnel work on one machine, the "equipment foreman" coordinates the sequences. The equipment foreman must be appointed by the operator.
- **Trained personnel**
"Trained personnel" are persons who, due to their training, are authorized to carry out the required work.

1.3. Legal basis

See "Manufacturer's Certificate" resp. "Certificate of Conformity".

1.4. Fields of applications

For the drying of thermoplastic granules and regrind before processing in order to remove all remaining moisture from the granules both inside and out, independent of climate or ambient air conditions.

1.5. Notes on Usage

- Experienced operators can begin directly with the chapter on "Start-up" if the unit has been properly installed.
- If the unit has not been installed yet, observe the instructions in the chapter on "Assembly Instructions" and "Transport, Assembly and Storage".

2. Safety instructions

These safety instructions apply to all persons within the range of action of the equipment.

Please inform all persons within the range of action of the equipment of the direct and indirect hazards connected with the equipment.

These operating instructions are to be used by all persons assigned activities connected with the equipment.

Knowledge of the English language is prerequisite.

Ensure in each case that the operating personnel are familiar with the operating instructions and the function of the equipment.

2.1. For your safety

General

The operating personnel of this equipment must be at least 16 years old.

Please read these operating instructions carefully before taking into operation for the first time. Contact us should questions arise. This avoids injury and damage to equipment!

These operating instructions must be kept available at all times at the place of operation of the equipment. Improper operation results in danger of accidents!

Please note that, for reasons of clarity, not all conceivable cases regarding operation or maintenance of the equipment can be covered in these operating instructions.

Please observe all safety instructions and warnings on the equipment. This avoids injury and damage to equipment!

All work on the equipment is to be carried out by persons whose qualifications are specified in the pertaining chapters of the operating instructions. Improper operation results in danger of accidents!

The proper working clothes are to be worn during any work on the equipment. This avoids injury!

The local regulations and requirements pertaining to this equipment must be observed.

Disconnect electrical components from the mains supply before work is carried out on these components. Caution: Danger to life through electrical shock!

Compile detailed operating instructions based on these Operating instructions for the sequence of procedures to be carried out on this equipment. Improper operation results in danger of accidents!

Observe that the control system is still under voltage even when the main switch is switched off. Caution: Danger to life through electrical shock!

Assembly

Compare the connected loads with those of the mains supply. Danger of injury through electrical shock!

When using lifting gear, please observe the pertaining regulations. Caution: Danger of accidents!

Do not modify, add other equipment or change the design of the equipment without the approval of the manufacturer. Caution: Danger of accidents!

Attachments not supplied by Sterling must be manufactured in accordance with safety regulation EN 294. Danger of accidents!

The equipment may only be operated when all the associated components are properly connected up and in accordance with the relevant regulations. This avoids injury and damage to equipment!

Operate the device only if all its components are grounded. Danger: accident through electrical shock!

Please note for installation that the equipment is top-heavy. Danger exists that it may topple over!

Take care that the device is not standing on the mains cable. This will prevent danger to people and material!

Operation

Appoint an equipment foreman to be responsible for the equipment.

Ensure that the operating personnel are provided detailed instruction in the operation of the equipment. Improper operation results in danger of accidents!

When the main switch is switched off for reasons pertaining to safety, it must be secured against unauthorized activation. Caution: Danger of accidents!

Repair work may be carried out by trained personnel only. Caution: Danger of accidents!

Never operate the equipment when partially dismantled! Danger! Limbs may be caught in machinery! Electric shock!

In case of malfunction, shut down the equipment immediately. Have malfunctions corrected immediately. Danger of accidents!

The machine is intended only for the drying of granulated plastics. Any other or additional use is contrary to specifications.

This equipment is not suitable for food processing.

The safety instructions of the connected machines must be followed.

Please note that sound levels exceeding 85 db(A) may in the long term damage your health. Use the appropriate ear muffs. This avoids impairment of hearing!

Please note that the drying cells, drying hoppers and air pipings grow hot during use. Avoid touching any of these parts! Danger: Injury through burns!

Never operate the dryer without side panels. Danger: Limbs may be caught in machinery! Injury through burns!

Dehumidified Air Dryer

When drying plastics which emit gases dangerous for human health, take care that the regeneration exhaust air is disposed of without polluting the environment. This will prevent danger to people and material!

Operate the dryer only if there is at least one drying hopper operating. This will prevent damage of material!

Maintenance

Before starting maintenance work, appoint a supervisor.

Inform the responsible personnel before maintenance work on the system is started. Caution: Danger of accidents!

Disconnect the equipment from mains supply before starting maintenance procedures to ensure that it cannot be switched on unintentionally. Caution: Danger of accidents!

All pipes, hoses and screwed connections should be checked regularly for leaks and damage. Any faults which arise should be corrected immediately. Danger of accidents!

Depressurise all compressed air piping before starting maintenance work. Danger of accidents!

The air filters should only be cleaned/replaced when the the main switch is off and the blower has stopped. This avoids injury and damage to equipment!

Any maintenance work on the equipment should only be started when the the main switch is off and the blower has stopped. This avoids injury and damage to equipment!

Check the v-belts of the blower only when the main switch is switched off and the blowers have stopped. Caution: Danger of accidents!

Open drying hoppers only if they are completely empty. Danger of accidents!

Never open drying hoppers while the device is in operation. Danger: Injury through burns!

Open drying hoppers only if they have been cooled down sufficiently. Danger: Injury through burns!

Before starting maintenance work wait until the drying cells, drying hoppers and air pipings have been cooled down sufficiently. Avoid touching any of these parts! Danger: Injury through burns!

Remove any granules remaining on the ground. Danger of accidents!

Arrest the wheels after installation if the dryer is mounted on a movable frame. This will prevent danger to people and material!

2.2. For the safety of the devices

Never change settings without carefully assessing the consequences.

Use only original Sterling spare parts.

Observe the maintenance instructions.

Keep a record of all maintenance works and repairs.

Please note that electronic components can be damaged by static discharge.

Before initial operation and in regular intervals, make sure that no electrical connections are loose.

Never readjust sensors without exactly knowing their functions.

Please ensure that the permitted storage temperature lies between -20 and +55 °C (-4 to +131 °F).

Please ensure that the permitted operation temperature lies between 0 and +45 °C (32 to +113 °F).

Check the direction of rotation of the blowers after the electrical connections have been made (see rotational direction arrow).

Clean the drying hoppers before the first filling.

Note the instructions of the material manufacturer for the maximum drying temperature.

Note the drying instructions of the material manufacturer.

Take care that the drying hoppers are always completely filled and that the retention period is respected if continual removal is taking place.

Note that too large amounts taken from the drying hopper lead to insufficient drying of the material.

Close the air stop valves of drying hoppers which are empty or have not been used.

Note down all data which you have entered into the control system.

The password is to be entrusted to authorised personnel only.

Please note that the temperature of the dryer heating system must always be set lower than that of the supplementary heaters.

When you dispose of drying agents, observe all official rules.

Note that drying cells are replaced or refilled by Sterling only if they are empty.

The material level may not fall below 40 % in the drying hopper, when material is continuously removed from the drying hopper, but no material is continuously fed into the drying hopper (batch drying). Close the throttle valves.

Read the operating manuals of the connected devices.

3. Start-up

Version: 64.10-8270GB01 06/02



This chapter is directed at the operators of the equipment.

This chapter assumes general skills in dealing with drying systems and SPS (PLC) control units.

This chapter assumes that the functional description has been read and understood.

It should be ensured in each and every case that the operators have the relevant skills.



Note down all set values of the control system.

Make sure that the cooling appliance is connected to the mains socket in the electrical cabinet (if present, optional).

Make sure that any condensate penetrating from the cooling appliance (optional) does not get inside the dryer or the control box.



If the inside temperature of the switch cabinet is above +50°C (122°F), the dryer is switched off after 30 minutes if it is operated with a cooling appliance (optional).

3.1. Control system

The control system is switched on at the main switch. The control system is operated via a "selection window" and the keyboard of the operator panel.

The facility's control system is factory-programmed. Nevertheless, you have to set specific values (basic parameters) which are dependent on the processed material, for instance.

The values entered are stored in the control system and remain so, even after the unit is switched off or in the event of a power cut. All messages are displayed in plain text.

In describing this start-up, we have assumed that the various sub-menus are selected from the "table of contents".

This structure of the description has been selected since, in most cases, you will only work on one item in the "submenu".

If you want to work on several "submenu" items in succession, you can select the individual items directly by means of the arrow keys.

3.1.1. Key assignment

F1-key:	Leads to the table of contents.
ENTER-key:	Confirms the entries.
ESC-key:	Goes back one step in the menu.
ACK-key:	Activates an alarm message; to unblock the control system.
Arrow keys:	Move the cursor bar; switch the appliances on or off in combination with the SHIFT key; for scrolling forward or backward in a menu.
SHIFT-key:	Switches on the secondary functions of the keys, when the SHIFT-key has been pushed, the LED "SHIFT" is on.
HELP-key:	Viewing additional texts, when additional texts can be viewed the LED "HELP" is on.
LED "ALARM":	flashes in case of an error; is on if the error has been acknowledged but not yet eliminated; is off if there are no errors



LED = light emitting diode

An additional alarm device (horn or lamp) can be connected (optional).

3.1.2. Flow chart

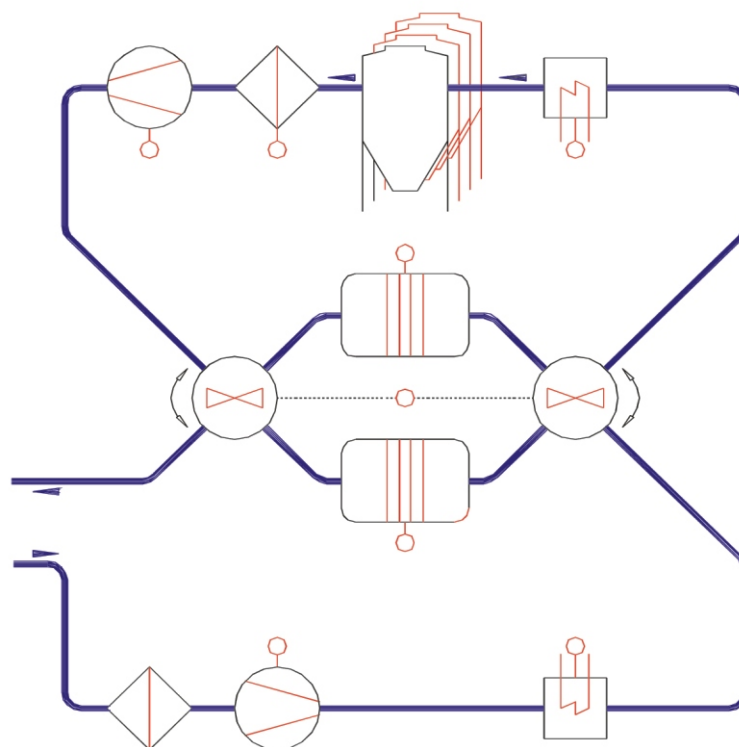

- | | |
|----|-------------------------|
| 1 | Indicator lamp |
| 2 | Valve system |
| 3 | Drying chamber |
| 4 | Drying blower |
| 5 | Return air filter |
| 6 | Drying hopper |
| 7 | Drying heater |
| 8 | Regeneration heater |
| 9 | Regeneration blower |
| 10 | Regeneration air filter |

Indicator lamp messages:

Green continous light:

in process

Red continous light:

alarm

3.2. Switching on the dryer

Switch on the system by means of the main switch.



The control system carries through a self-test; after that, the name of the dryer and the operation status of the unit are displayed.



Unblock the control system:
Keep the ACK key pressed until the LEDs of the keys K1 - K4 light up.

3.2.1. Operation statuses

The following operation statuses can be displayed:

- system is off
- system is on
- blower runs on
- valve block
- regeneration will be finished in x min.

3.3. Viewing the software-version

Press the “±”-key.



The software-version will be displayed.

3.4. Passwords

The entry of a password prevents unauthorised persons from having access to the data entered into the control system. Important data can then be entered or modified only after the password has been entered.

If you make no entries for more than 10 minutes, the access is blocked and you have to re-enter the password.

- password level 6: 79 21 54



Tell the password only to authorised persons.

Press the ”**Shift**”-key and the ”**K4**”-key.

Press 3 x the “↓” key.

Press the ”**F3**”-key.

Login

Press the key "F2".
Enter the password.
Press the ENTER key.



If the password has been entered correctly, the corresponding password level is displayed.

You can now enter data into the control system or modify data which have already been entered.

Press the ESC key.

Logout

Press the key "F3".



Only data for which no password is necessary (= password level 0) can now be entered into the control system or modified.

Press the "↓" key.

Edit

Press the key "F2".



This function is available only for password level 9.
Passwords and password levels can be modified or entered.
Confirm your entries by means of the ENTER key.

Press the "F1"-key.

3.5. Basic parameters

Press the "F1"-key.

3.5.1. Turning the devices on/off

Select "**Main menu**".

Acknowledge with the ENTER-key.

or

Press the "**F2**"-key.

Dryer on/off

"on" = turn dryer on, "off" = turn dryer off.

Acknowledge with the ENTER-key.

Timer on/off

Press the SHIFT-key and choose with the arrow-keys the desired operation:

"internal" = operation with timer (operation at OP7, see chapter timer),

"external" = operation with timer (if present),

"off" = operation without timer.

Acknowledge with the ENTER-key.



The timer is only operating, when the dryer is switched on.

Press the "↓" key.



If the unit operates with a pre air cooler (optional):

Pre air cooler on/off

"on" = operation with pre air cooler, "off" = operation without pre air cooler

Acknowledge with the ENTER-key.

Press the "↓" key.

Hopper X on/off (X = number of the drying hopper)

“on” = releasing drying hopper X, “off” = blocking drying hopper X

Acknowledge with the ENTER-key.

Hopper heater X on/off (X = number of the hopper heater)

“on” = switch on hopper heater X, “off” = switch off hopper heater X

Acknowledge with the ENTER-key.

Press the "F1"-key.

3.5.2. Entering dryer values

Select **"Dryer"**.
Acknowledge with the ENTER-key.

or

Press the **"F3"**-key.

Regeneration Heater Act.

The regenerated heat temperature will be displayed.

Used air Act.

The current temperature of the used air will be displayed.

Press the "↓" key.

Dew point max.

Enter the maximum permissible (worst allowed) dew point temperature (-35 to 28 °C) (-31 to 82.4°F).

Acknowledge with the ENTER-key.

Dew point Act.

The current dew point temperature will be displayed.



If there is a cable break "+0 °C" (32°F) is displayed.

Press the "↓" key.



If the unit operates with a pre air cooler (optional):

Pre air cooler Target

Enter the max. permissible air temperature. Acknowledge with the ENTER-key.

Pre air cooler Act.

The current air temperature will be displayed.



The cooling effect of the pre air cooler is highly dependent on the cooler circuit.

The lower the value chosen for the pre air temperature, the better.



Plan the size of the coolant circuit accordingly.

Press the "F1"-key.

3.5.3. Entering hopper values

Select "**Hopper**".
Acknowledge with the ENTER-key.

or

Press the "**F4**"-key.

Hopper entry X Target

(X = number of the drying hopper)

Enter the drying temperature for hopper flap X (when operating with supplementary heating).

Acknowledge with the ENTER-key.

Hopper entry X Act.

(X = number of the drying hopper)

The current temperature at the feed opening of hopper flap X will be displayed.



If there is a cable break "+0 °C" (32°F) is displayed.



The lowest drying temperature setting of the hopper flap must be the same as or higher than the drying temperature.

Press the "↓" key.



If the unit operates with motor flaps (optional):

Granules X

target: _ % = _ °C (°F)

(X = number of the drying hopper)

Enter the material temperature at which the flap (optional) on the drying hopper X should close. Confirm with the ENTER key.



This value is entered in percent of the temperature on the hopper inlet.

The material temperature calculated by the control system for closing the flap on the drying hopper X is displayed in °C (°F).

Granules X

act.: _ °C(°F)

(X = number of the drying hopper)

The current material temperature in the drying hopper X is displayed in °C (°F) (optional, if there is a flap).

Press the "F1"-key.

3.5.4. Observing processing status

Select **"Status"**.

Acknowledge with the ENTER-key.

or

Press the **"K1"**-key.



The current operation status of individual assembly parts is displayed:

e.g.: valve block moved in/moved out/error

"moved in" = The upper drying cells are within the drying circuit; the lower ones are regenerated.

"moved out" = The upper drying cells are regenerated; the lower ones are within the drying circuit.

"error" = An error has occurred.

Other operation statuses:

"on" = in operation,

"off" = out of operation,

"open" = opened,

"shut" = closed.

Press the **"F1"**-key.

3.5.5. Setting date and time



This function is password protected.

Press the "K3"-key.
Enter the password if requested.

Date

Press the SHIFT key.
By means of the arrow keys, select the desired week-day.
By means of the arrow keys, select the shown date.
Press the SHIFT key.
Enter the desired date.
Press the ENTER key.

Time

Enter the desired time.
Press the ENTER key.

Press the "F1"-key.

3.5.6. Viewing/changing language and contrast



This function is password protected.

Press the "K4"-key.
Enter the password if requested.

Contrast

Press the SHIFT key.
By means of the arrow keys, select the adjustment which suits you best.
Press the ENTER key.



Depending on the outside temperature, the brightness of the screen may vary.

Language

Press the SHIFT key.
By means of the arrow keys, select the desired language (if present).
Press the ENTER key.

Press the "F1"-key.

3.5.7. Changing parameters

Select "**Parameters**".
Acknowledge with the ENTER-key.

or

Press the **SHIFT**-key and the "**K1**"-key.

**Run on time
drying blower
-- 300 sec.**

Standard setting: 300 seconds, changes only after contacting Sterling Service.

Press the "↓" key.

Parameters



The values in this menu may only be changed after contacting Sterling Service.

Press the "F1"-key.

3.5.8. Setting the timer

Select "Timer".

Acknowledge with the ENTER-key.

or

Press the **SHIFT**-key and the "F1"-key.

XX ON 00:00 OFF 00:00 (XX = day Mo-Su)

Enter for each day the switching on time and the switching off time.

Acknowledge with the ENTER-key.



Example:

Fr	ON	08:00	OFF	23:59
Sa	ON	00:00	OFF	23:59
Su	ON	20:00	OFF	08:00
Mo	ON	00:00	OFF	00:00

The dryer starts on Friday at 08:00 in the morning, runs through without interruption until Sunday at 08:00 and switches off. At 20:00 the dryer starts again and switches off on Monday at 00:00.

Press the "F1"-key.

3.6. Starting continuous operation

When you have carried through all basic settings, you can start with continuous operation.



Make sure that hoppers which are not in use are separated from the dehumidified air supply.

Make sure that the set drying temperatures are suited for the materials in the hoppers.

After first filling, do not process the material until after the dwelling time.

If a return air cooler (optional) is installed, switch on the coolant circuit .

If a pre air cooler (optional) is installed, switch on the coolant circuit.

Make sure that the cooling appliance is connected to the mains socket (if present, optional).

Check setting of the timer.

Select "**Main menu**".

Acknowledge with the ENTER-key.

or

Press the "**F2**"-key.

Select "**Dryer on**".

Acknowledge with the ENTER-key.

3.7. Viewing system runtime

Select "**System runtime**".
Acknowledge with the ENTER-key.

or

Press the **SHIFT**-key and the "**F2**"-key.

System runtime

PLC	X.XX h
r.-blwr.	X,XX h
m.-blwr.	X.XX h



The runtime of the blowers and the PLC (SPS) is shown in hours.

3.8. Switching the dryer off

Select "**Main menu**".
Acknowledge with the ENTER-key.
or
Press the "**F2**"-key.

Select "**Dryer off**".
Acknowledge with the ENTER-key.



Wait until the regeneration phase is finished and the blower has come to a standstill.

Switch off the dryer at the main switch.

Disconnect the power supply.



Never switch off the dryer directly at the main switch.

4. Error and error correction



This chapter is directed at the operators of the equipment.

This chapter assumes general skills in dealing with drying systems and SPS (PLC) control units.

This chapter assumes that the “start-up” description has been read and understood.

It should be ensured in each and every case that the operators have the relevant skills.



Alarm messages are displayed in plain language on the screen of the operator device.

The display of alarm messages in the operator device can only be erased by pressing the "ACK" key. The failure is not repaired.

A failure is given by flashing of the LED "alarm". If the alarm message is acknowledged by pressing of the "ACK" key, but the failure is not yet eliminated, the flashing changes to steady light.

If a cooling appliance is present: If the temperature inside the switch box is higher than +50 °C (122°F), the lamp "alarm - temperature inside switch box" goes on. If the temperature is still too high after 30 minutes, the dryer is switched off.



Failures must be repaired immediately.



LED "ALARM":
flashes in case of an error;
is on if the error has been acknowledged but not yet eliminated;
is off if there are no errors

Press the "K2"-key.

View

Press the "F2"-key.

All alarm messages with their numbers (see Texts), date, time and the supplement "K", "G", or "Q" are displayed.



"K" = coming (a failure occurred)
Pressing the "→"-key displays the alarm message in plain text.

"G" = going (the reason for the failure has gone)

"Q" = reset (the display of the alarm message in the operator device has been erased by pressing the "ACK"-key)

Press the ESC-key.

Print (Optional)



This function is password protected.



Make sure that a printer is connected and switched on.

Press the "F3"-key.

The alarm messages are printed.

Press the "↓"-key.

Number

Press the "F2"-key.

Total messages

The number of all alarm messages is displayed.

Waiting messages

The number of current alarm messages is displayed.

Press the ESC-key.

Delete

Press the "F3"-key.



This function is password protected (Sterling service).

Press the ENTER-key for deleting the messages.

Press the ESC-key.

Press the "↓"-key.

Overflow

Press the "F2"-key.



If there are more current alarm messages than can be saved, a warning message (= residual buffer reached) may be given.

This function is password protected (Sterling service).

Overflow warning On/Off

Press the SHIFT-key.

By means of the arrow keys, select "on" if a warning message is to be given.

By means of the arrow keys, select "off" if no warning message is to be given.

Press the ENTER-key.



If the overflow warning message is given, press the ACK-key. Delete the alarm messages.

Press the ESC-key.

Text

Press the "F3"-key.

All possible alarm messages are displayed with their numbers (see Viewing).

For viewing the possible alarm messages, press the arrow keys:

PLC (= SPS) Battery is Empty

Replace the SPS battery.

Main Switch is Off

The main switch has been placed in the off position.

The safety temperature limiter of the drying or the regeneration heater, respectively, has been activated.

The safety temperature limiter of a hopper heater has been activated.

Error valve block.

Check the safety temperature limiter.

Check the position of the valve block.

A Safety Temperature Limiter has been Activated

Check the safety temperature limiter of the drying, regeneration, or hopper heater, respectively.

Filter Door is Open

The side panels to the air filters are open.

Assemble side panels.

The Safety Switch Regeneration Blower Has Been Actuated

Check the blower.

Check the fuses.

Short circuit check of the blower.

Vacuum Regeneration Blower

The regeneration blower does not produce sufficient pressure.

Check the blower.

Vacuum sensor defective.

The Safety Switch Drying Blower Has Been Actuated

Check the blower.

Check the fuses.

Short circuit check of the blower.

Vacuum Drying Blower

The drying blower does not produce sufficient pressure.

Check the blower.
Vacuum sensor defective.

Temperature Measurement Regeneration Heater Defective

Check the cables and the sensor.
Check the power supply.
Short circuit check.

Excess Temperature Regeneration Heater

The regeneration temperature is too high.

Check the safety temperature limiter.
Sterling Service.

Insufficient Temperature Regeneration Heater

The regeneration temperature is too low.

Check the regeneration heater.

The Safety Switch Regeneration Heater Has Been Actuated

Check the heater.
Check the fuses.
Short circuit check of the heater.

Error Bypass Flap

The bypass flap does not close or closes too slowly.

Check the bypass flap.

Error Valve Block

The valve block has not reached the proper position. The main switch is placed in the off position.

Check the position of the valve block. Press the "ACK" key and put the main switch in the on position immediately. If the valve block has not reached the correct position within 1 minute, the main switch is again placed in the off position.

Sterling Service.

Temperature Measurement Outgoing Air Defective

Check cables and sensor.

Temperature Measurement Return Air Defective

Check cables and sensor.

Excess Temperature Return Air

Check cables and sensor.
Check the return air cooler.

Temperature Measurement Drying Heater Defective

Check cables and sensor.
Check the power supply.
Short circuit check.

Excess Temperature Drying Heater

The drying temperature is too high.

Check the safety temperature limiter.
Sterling Service.

Insufficient Temperature Drying Heater

The drying temperature is too low.

Check the drying heater.

Safety Switch Drying Heater

Check the heater.
Check the fuses.
Short circuit check of the heater.

Temperature Measurement Heater Defective Hopper X

(X = number of the drying hopper)
Check cables and sensor.
Check the power supply.
Short circuit check.

Excess Temperature Heater Hopper X

(X = number of the drying hopper)
The temperature of the hopper heater is too high.

Check the safety temperature limiter.
Sterling Service.

Insufficient Temperature Heater Hopper X

(X = number of the drying hopper)
The temperature of the hopper heater is too low.

Check the hopper heater.

Safety Switch Heater Hopper X

(X = number of the drying hopper)
Check the heater.
Check the fuses.
Short circuit check of the heater.

Temperature Measurement Granules Defective Hopper X

(X = number of the drying hopper)

Check cables and sensor.

Check the power supply.

Short circuit check.

Excess Temperature Granules Hopper X

(X = number of the drying hopper)

The material temperature is too high.

Check the heater.

Check the throttle valve.

Valve Error Hopper X

(X = number of the drying hopper)

The throttle valve does not close or closes too slowly.

Check the throttle valve.

Temperature Measurement Pre Air Defective

Check cables and sensor.

Excess Temperature Pre Air

Check cables and sensor.

Check the pre air cooler.

Press the "F1"-key.

5. Maintenance

Version: 64.10-8252GB01 06/02



This chapter is intended for persons with skills in electrical and mechanical areas due to their training, experience and received instructions.

Personnel using the instructions in this chapter must be instructed of the regulations for the prevention of accidents, the operating conditions and safety regulations and their implementation.

Ensure in each case that the personnel are informed.

For maintenance work taking place at heights of over approx. 6 feet (1829 mm), use only ladders or similar equipment and working platforms intended for this purpose. At greater heights, the proper equipment for protection against falling must be worn.

Use only suitable lifting gear which is in proper working order and load suspension devices with sufficient carrying capacity. Do not stand or work under suspended loads!

Ensure that the electric motors/switch cabinets are sufficiently protected against moisture.

Use only suitable workshop equipment.

Before starting maintenance work, appoint a supervisor.

Inform the responsible personnel before maintenance work on the system is started.

Never operate the equipment when partially dismantled.

All maintenance and repair work **not** described in this chapter, may only be carried out by Sterling service personnel or authorized personnel (appointed by Sterling)



Disconnect the equipment from mains supply before starting maintenance procedures to ensure that it cannot be switched on unintentionally.

Depressurize all compressed air piping of the equipment before starting maintenance work.



Please observe the maintenance schedule.

Before starting maintenance work, clean the equipment of oil, fuel or lubricants.

Ensure that materials and incidentals required for operation as well as spare parts are disposed of properly and in an environmentally sound manner.

Use only original Sterling spare parts.

Keep record of all maintenance and repair procedures.

5.1. Maintenance intervals

Daily:	Check warning signs on equipment for good legibility and completeness Clean return air filter and housing (depending on amount of dust collected) Lamp test: if you press the "+/-"-button longer than 2 seconds all LED's must light up
Weekly:	Check function of the main switch Clean filter of the electrical cabinet (depending on amount of dust collected)
Monthly:	Check V-belt tension of blower
Every three months:	Clean filter of the regeneration blower (depending on amount of dust collected)
Every six months:	Exchange return air filter (depending on amount of dust collected) Exchange filter of the electrical cabinet (depending on amount of dust collected) Check all electrical and mechanical connections for tight fit.
Yearly:	Exchange filter of the regeneration blower (depending on amount of dust collected)



This maintenance schedule is calculated for 3-shift operation.



The given maintenance intervals are average values.

Check whether in your individual case the maintenance intervals must be shortened.

5.2. Cleaning/renewing the air filters

Press the "F2"-key.

Select "Dryer off".

Acknowledge with the ENTER-key.



Wait until the blowers have stopped turning.

Switch off the dryer at the main switch.

Disconnect the power supply.



Open the upper panel by means of the provided switch cabinet key.



Clogged filters reduce the volume of circulating air to a substantial degree and result in decreased dryer efficiency. In addition, the heating elements may be damaged due to clogged filters.

Return air filter

Loosen the securing nut on the return air filter housing and remove the housing lid.

Remove the return air filter.

Clean the return air filter with compressed air from inside to out **or** renew the filter. Never knock the return air filter on the floor.

Clean the return air filter housing. Use lint-free cleaning rags.

Re-install the cleaned/new return air filter.

Mount the lid and fasten the securing nut.

Close the panel.

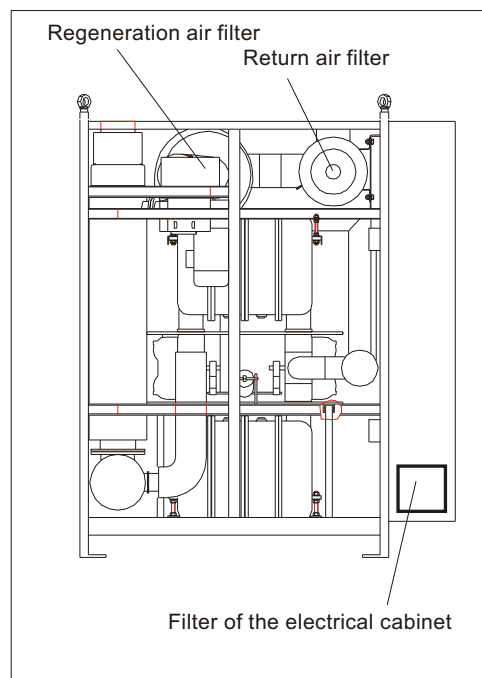

STT 800



Never operate the dryer without return air filter.

The dryer can't be put into operation if the panel is not replaced.



Order number return air filter if operated

with return air cooler: ID 88225

without return air cooler: ID 86783

Regeneration air filter

Loosen the securing nut on lid of the regeneration air filter.

Remove the lid and regeneration air filter housing.

Loosen the two wing nuts.

Remove the circular grid.

Remove the filter mat.

Blow through the filter mat with compressed air from the inside to the outside, **or** renew the filter.

Re-install the cleaned/new filter.

Replace the circular grid.

Fasten the two wing nuts on.

Replace the regeneration air filter housing and the lid of the regeneration air filter.

Fasten the securing nut onto the regeneration air filter.

Close the panel.



Never operate the dryer without regeneration air filter.
The dryer can't be put into operation if the panel is not replaced.



Order number filter mat: ID 93686

Filter of the electrical cabinet

Remove the lid of the filter.

Remove the filter mat.

Blow through the filter mat with compressed air from inside to outside **or** renew the filter mat.

Clean the filter housing. Use lint-free cleaning rags.

Re-install the cleaned/new filter mat.

Replace the lid of the filter.



Never operate the dryer without filter mat.



Order number filter mat: ID 87491

5.3. Tensioning the V-belts

Press the "F2"-key.

Select "Dryer off".

Acknowledge with the ENTER-key.



Wait until the blowers have stopped turning.

Switch off the dryer at the main switch.

Disconnect the power supply.

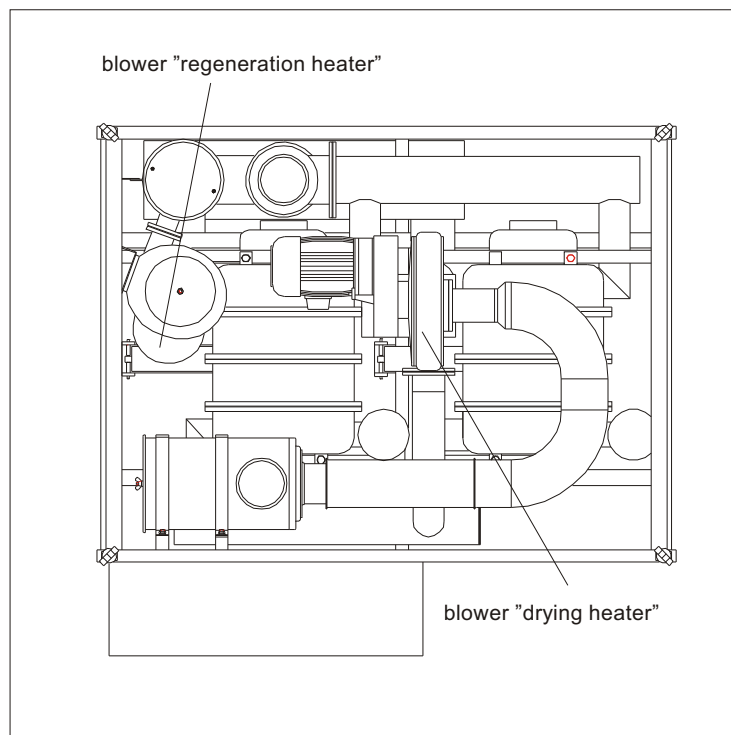

STT 800



Open the upper panel by means of the provided switch cabinet key.



Order number V-belts blower

"regeneration heater": ID 94211

"drying heater": ID 86351

Blower "regeneration heater" / Blower "drying heater"

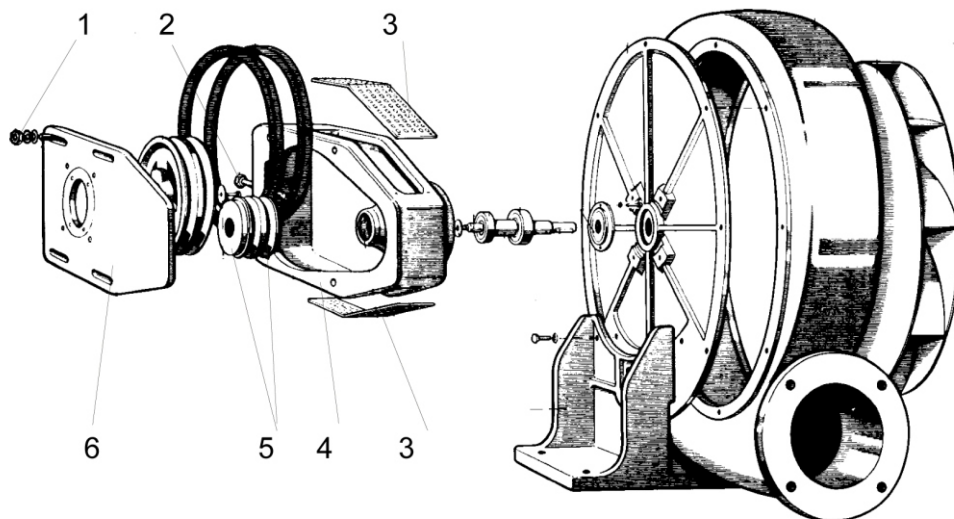

Remove the protective grid of the blower (position 3).

Loosen the nut (position 1).

Loosen and remove the screw (position 2).

Slide motor with carrier flange plate (position 6) towards the carrier flange housing (position 4).

Remove defective V-belts (position 5), put on new ones.



Attention should be given to exact alignment of the V-belt pulleys.

Adjust belt tension by screw (position 2) in accordance with the information sticker.

Tighten the nuts on threaded bolt (position 1) again.

Mount the protective grid of the blower (position 2).

Mount the side panels.

High-pressure blowers with frequency converter operation



Blowers work without V-belts!

5.4. Disposing of the drying agent

Ensure that drying cells are exchanged by Sterling or refilled only when empty.



Drying agents must be disposed of in accordance with all official regulations.

Used drying agents are to be disposed of as hazardous waste, as it may be contaminated with foreign substances from the materials dried in the system.



Used drying agents or drying cells containing used drying agent cannot be returned to Colortronic.

5.5. Servicing the accessories



The operating instructions must be followed.

5.6. Changing the battery of the control system



This work may be carried through only by qualified personnel trained in the field of electrical engineering.



The battery may be changed only with the control system switched on.

Open the control box by means of the control box key which is part of the supply.

Open the front door of the CPU.

Pull the backup battery with cable out of the compartment.

Plug the connector of the new backup battery into the corresponding socket in the battery compartment of the CPU.



The notch on the battery connector must point to the left!

Place the backup battery into the battery compartment on the CPU.

Close the front door of the CPU

Close the control box.

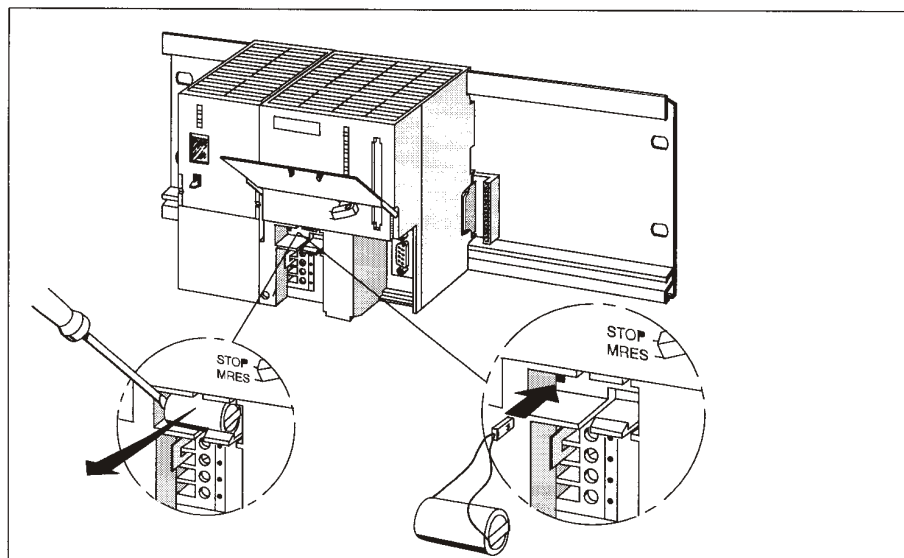



Store backup batteries in a dry and cool place.
Backup batteries can be stored for approx. 5 years.
If backup batteries are not treated properly, they can ignite, explode and cause severe burning.



Order number battery: ID 83809



Batteries must be disposed of in keeping with the relevant national environment protection regulations/guidelines.

5.6.1. Resetting the control values



This electrical work is intended to be carried out only by trained personnel.



After changing the battery or the PLC the control values should be reset.
All control values are set back to the standard settings.

Open the control box with the switch box key which is part of the supply.

Turn the key to the STOP position.

Turn the key to the MRES position.

Hold the key in this position until the STOP-LED comes on for the second time and remains on (this takes 3 seconds).

Turn the key to the STOP position.

Within 3 seconds you must turn the switch back to the MRES position.

Hold the key until the STOP-LED flashes.



When the CPU has completed the reset, the STOP-LED stops flashing and remains lit.

Close the control box.

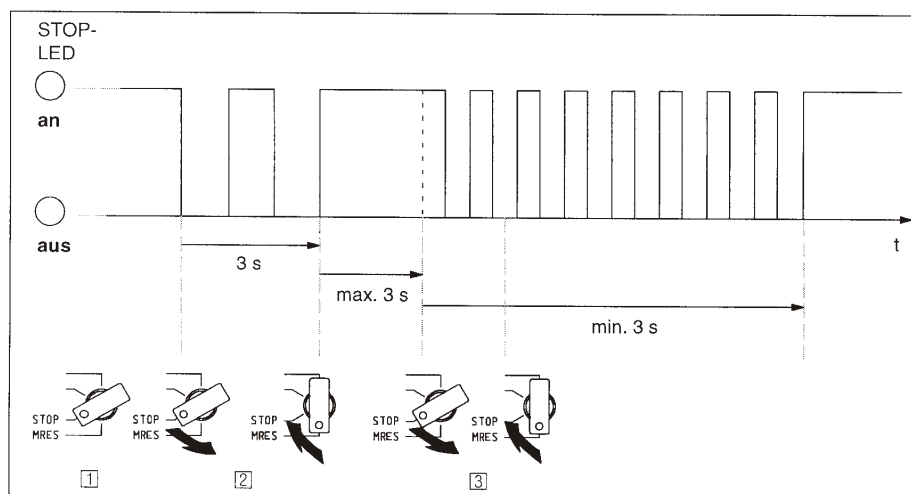

6. Functional description

This functional description is intended for all operating personnel of the equipment.

Prerequisite for this functional description is general knowledge of dryers and SPS (PLC) systems.

Ensure in each case that the operating personnel are sufficiently informed.

6.1. Dryer

The dryer operates with dehumidified air, i.e. the air is not only heated but also dehumidified before flowing into the drying hopper. This principle allows plastic granules to be dried to a residual moisture content as low as 0.002 % (PET granulate).

The dryer operates continuously, i.e. dehumidified and, if necessary, heated air is produced continuously.



The dryer is designed for continuous operation.

The dryer operates with 4 drying cells; two of these cells are always in the drying cycle while the other are being regenerated (max. 60 min.).

If a malfunction occurs in the drying cycle during the program run, regeneration is not interrupted, but continues until the program end has been reached. This guarantees that 2 regenerated drying cells are always available.

The air inside the switch cabinet is cooled by a cooling appliance for the protection of temperature-sensitive components (if present, optional).

With the digital timer the dryer can be switched on and off at set times.

Dew point dependent regeneration switch (optional)

The dew point temperature is monitored continuously. The valve system switches to the freshly regenerated drying cells only after the selected dew point temperature has been reached. The humid drying cells are then regenerated. After the cooling time the drying cells are ready for operation again. The valve system switches to the freshly regenerated drying cells only after the moisture content of the drying cells which are in the drying cycle have reached the setpoint value.

6.2. Drying hopper (optional)

The material is dried in the drying hopper. The dehumidified air is forced through the material in the hopper, collecting moisture in the process. The drying hopper must be dimensioned according to its intended use to ensure that the final moisture content is attained. When the hopper is filled for the first time or at the start of a drying procedure, the material in the hopper must be dried completely before material can be removed from the hopper for the first time.

When material is continuously removed from the hopper, material must also be continuously fed into the drying hopper. The new (moist) material is fed into the drying hopper from the top and slowly moves downward toward the material suction box. As the material moves upward, it is dried until its final moisture content is attained.

To ensure proper continuous drying, we recommend that the drying hopper always is kept completely filled. Automatic conveyors, such as the models included in our delivery program, optimize the automation of the material flow.



When material is continuously removed from the hopper, but no material is continuously fed into the drying hopper (batch drying), the material level may not fall below 40 %.
Close the throttle valves.

6.3. Return air cooler (optional)



A return air cooler is generally required in cases in which the return air temperature is over 65 °C (149°F).

A return air cooler improves the efficiency of the drying cells.

The return air cooler reduces the return air temperature to a defined value. The return air temperature is set at the operation panel.



The lower the value chosen for the return air temperature, the better the efficiency of the drying cells.

The dryer is automatically switched off if temperature exceeds 80 °C (176°F)

Return air temperature is continuously monitored; the return air cooler is activated only when needed. If the return air temperature exceeds the set value (e.g. due to interruption in the cooling water supply or soiling), an alarm message is given.

The return air cooler can be connected to a coolant circuit or to the water mains network.

6.4. Pre air cooler (optional)

The pre air cooler reduces the pre air temperature to a defined value. The pre air temperature is set at the operation panel. Pre air temperature is continuously monitored; the pre air cooler is activated only when needed. If the pre air temperature exceeds the set value (e.g. due to interruption in the cooling water supply or soiling), an alarm message is given.

The pre air cooler can be connected to a coolant circuit or to the water mains network.

6.5. Hopper heaters (optional)

If differing drying temperatures are required in the different drying hoppers, hopper heaters must be installed on the drying hoppers. The drying temperature of each drying hopper can be set centrally at the dryer.

6.6. Automatic motor flaps (optional)

Automatic motor flaps cut off the drying hopper from the drying circuit as soon as the material is completely dried. The supplementary heating system is also switched off. Dehumidified air flows into the drying hopper only after new, moist material is added to the hopper. This ensures that the material is not damaged, and saves a considerable amount of energy.

Temperature probes at the feed opening of the drying hopper and inside the drying hopper enable comparison of feed opening and material temperature, from which the drying degree of the material can be calculated.

If the drying hopper is to be cleaned or blocked, the motor flap can be closed via the dryer. The supplementary heating system is then automatically switched off.

6.7. Connection to a pneumatic conveying system (optional)

The dryer operates most effectively in conjunction with a pneumatic conveying system. This combination of dryer and conveying system ensures that sufficient material is always fed into the drying hopper.

Only the amount of material required for the processing machines used is removed from the hopper. This guarantees that the final drying result remains constant.

Sterling drying hoppers are available equipped with the corresponding flange for connection of a Sterling pneumatic conveyor directly ex works.

Suction boxes can also be delivered with the required number of suction tubes. These suction boxes were developed specially for this hopper to prevent dust and foreign particles from being aspirated into the system.

A device for connection to the dehumidified air supply line is also available. Please note that the function of this combination is different from that of the conventional Sterling suction boxes.

7. Transport, Assembly and Storage



This chapter is intended for all operating personnel of the equipment.

Personnel using these instructions must be instructed in the regulations for the prevention of accidents, the operating conditions and safety regulations and their implementation.

Ensure in each case that the operating personnel are sufficiently informed.

Please inform all persons within the range of action of the equipment of the direct and indirect hazards connected with the equipment.

Please observe all safety regulations for the operation of lifting equipment.

7.1. Transport and Packing



Please ensure adequate carrying capacity of the lifting equipment.
Note that the dryer system is top-heavy. Risk of toppling!

The equipment pass a rigorous operating test in the factory and are packed carefully to avoid transport damage.

Please check packing on delivery for transport damage.

The inlet and discharge flanges are sealed with plugs, so that no dirt can enter during transport. Plugs must be removed before assembly.

Packing materials should be disposed of according to environmental laws or reused.

Only use for transport of the equipment a suitable lifting device (e. g. a fork lift truck or a workshop crane).

Fasten the transport cables to the eyelets of the control cabinets.

Transport must be shock-proofed and free from vibrations.

with a fork lift truck

Push the forks up to the dryer housing.

Check that the forks reach completely under the dryer housing.

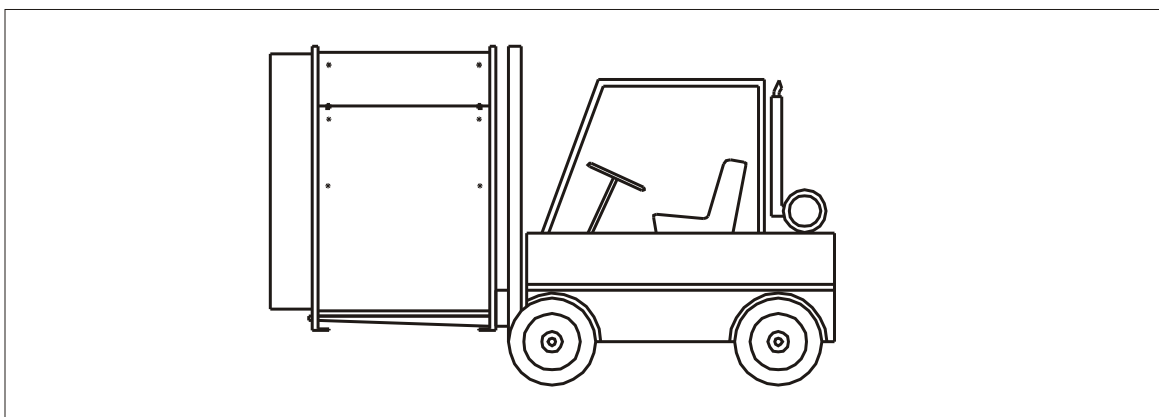

Transport with a fork lift truck

Dehumidified Air Dryer

with a workshop crane

Check if the eyelets are installed on the dryer housing.

If this condition is met, fasten the transport cables to the eyelets.

If this condition is not met, mount the eyelets and then fasten the transport cables to the eyelets.

Disassemble the eyelets after set-up.

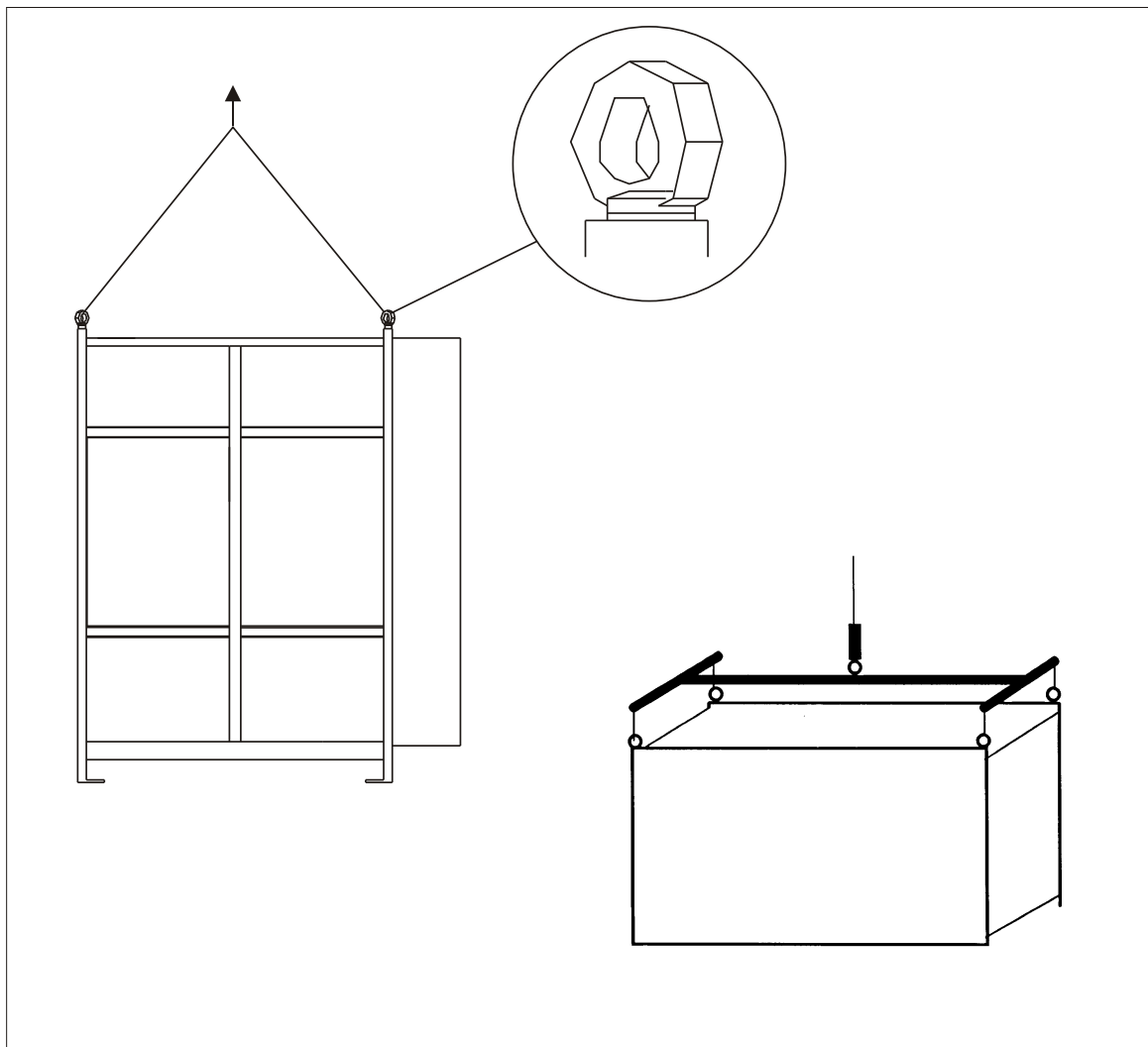

Transport with a workshop crane

7.2. Assembly



- Please ensure adequate carrying capacity of the lifting equipment.
- Check the carrying capacity of the point of installation, particularly if installed on a platform.
- The place selected for installation should be as free of vibrations as possible.
- The main switch must be freely accessible.
- Ground the equipment against electrostatic charging.

A special foundation is not required for installation.

The dryer must be installed on a level surface, and may not be exposed to excessive humidity. Maximum permissible ambient temperature of the control system is 45 °C (113°F).

To facilitate servicing, install the dryer such that it is accessible from 3 sides. Make sure that the air filters can be changed without problems. The rear of the dryer can be placed against a wall.

To conserve energy, keep the distances between dryer, hopper and processing machine as short as possible.

The location of the control unit should be chosen so that a clear view of the separators is guaranteed from the control unit. Thus any malfunctions which arise can be corrected more easily.

Fasten the transport cables to the eyelets of the control cabinets. During transport do not contact or push against other components with the control panels.

7.3. Storage

The control system may only be stored at temperatures from -25 to +55°C (-13 to +131 °F).

Between delivery and machine commissioning the equipment should be stored in a dry, dust-free and vibration-free room.

8. Assembly instructions



These installation instructions are intended for persons with skills in electrical and mechanical areas due to their training, experience and received instructions.

Personnel using these installation instructions must be instructed in the regulations for the prevention of accidents, the operating conditions and safety regulations and their implementation.

Ensure in each case that the personnel are informed.

The installation instructions provided in the corresponding operating instructions apply for all connected equipment.

Observe safety regulations with regard to lifting gear handling

All installation work must be carried out with the equipment disconnected from electrical power and compressed air supply.



For installation work taking place at heights of over approx. 6 feet (1829 mm), use only ladders or similar equipment and working platforms intended for this purpose. At greater heights, the proper equipment for protection against falling must be worn.

Use only suitable lifting gear which is in proper working order and load suspension devices with sufficient carrying capacity. Do not stand or work under suspended loads!

Use suitable workshop equipment.



Install the equipment such that all parts are easily accessible; this facilitates maintenance and repair work.

8.1. Mounting of the suction device for regeneration exhaust air

When plastics are dried which produce hazardous gases, environmentally sound disposal of the regeneration exhaust air must be provided. The throughput of the regeneration blower may not be changed.

It must be taken into consideration when installing a disposal system (e.g. exhaust system) that regeneration exhaust air is extremely humid. This may result in condensation water which must not enter the dryer again under any circumstances.

8.2. Connection of the air coolers (optional)



A return air cooler is generally required in cases in which the return air temperature is over 65 °C (149°F).

The return air cooler can be connected to a coolant circuit or the water mains network.

Observe the water flow with connection to water mains network. The coolant circuit must be dimensioned accordingly.

Remove the side panel of the dryer.

Connect the coolant intake line and coolant return line to the return air cooler.

Observe the flow direction of the coolant through the return air cooler.

Check the connections for leaks.

Mount the side panel.

8.3. Electrical connection



Observe the rules of the local electricity board.

Check that the supply voltage and the power frequency are in accordance with the data on the name plate of the device.

The electrical connection may only be carried through or assigned by Sterling service staff or by qualified staff authorized by Sterling.

Other persons are not permitted to carry through the electrical connection.

The main switch must be freely accessible.

Ground the equipment against electrostatic charging.



Observe that the control system is still under voltage even when the mains switch is switched off.



Regularly make sure that none of the electrical or screw connections are loose.

Immediately after connection, check the direction of rotation of the blowers (see rotational direction arrow on the blowers).

The direction of rotation should be switched in the supply line only.

The operation voltage is 480/3/60.
Special operation voltages are possible.

9. Technical Data

Version: 64.10-8252GB01 06/02

Basic Equipment

- Centrally monitored PLC S7 drying control system with operator panel OP 7
- Central temperature controls for all heating elements to ensure constant temperature levels
- Safety temperature limiter for all heaters
- Designed for optimal regeneration time due to constant monitoring of the moisture level in the drying cells or desiccant beds.
- Maintenance free air valves
- Automatic alarm clock or timer
- Optical alarm indication
- Function control with flow diagram

Optional Equipment

- Dew point display
- Return air cooler for high processing temperatures
- Pre-air filter
- Special color
- Special voltage
- Printer interface
- Fuzzy Logic control for automatic air distribution
- Condensation collection chamber
- High-pressure blowers with frequency converter operation

Performance

- Maximum air drying capacity of 800 m³/h (16,992 cu.ft./hr)
- Operates with 400 V +/-10%, 3AC, 50 Hz voltage 480/3/60
Special voltage possible
- 41,1 kW connected load + max. 48 kW hopper heatings
- Noise level: 83 dB (A)
- Weight approx. 1200 kg (2645.50 lbs.)

Dimension sheet

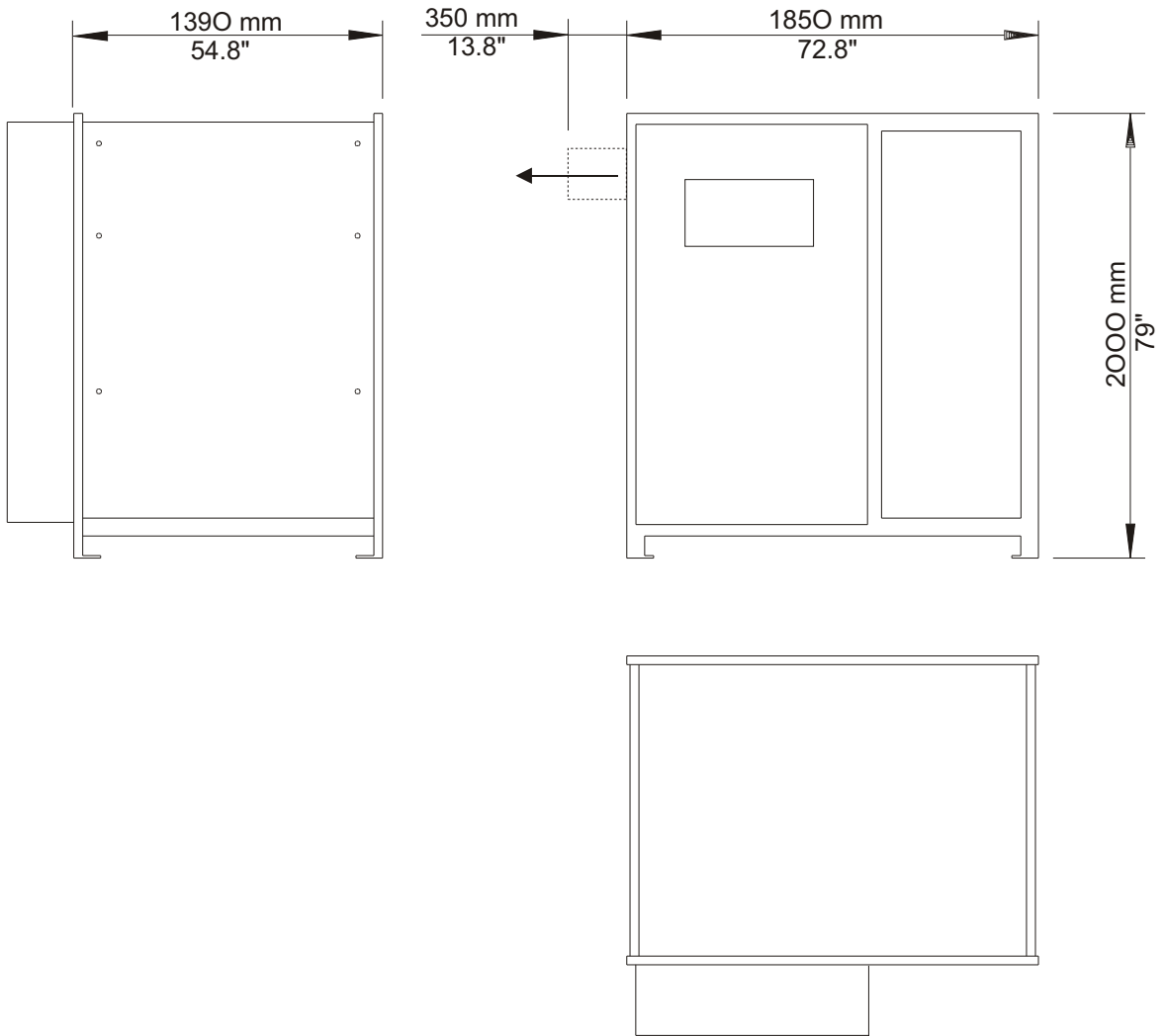

Dimensionsi mm.(in.)Specificationsmaybesub jecttoalterations.

10. Spare parts list



This spare parts list is intended to be used only by trained personnel.
Other persons are not permitted to modify or repair the equipment.



ID-numbers for units with special voltage, for ex. blowers, only on request.

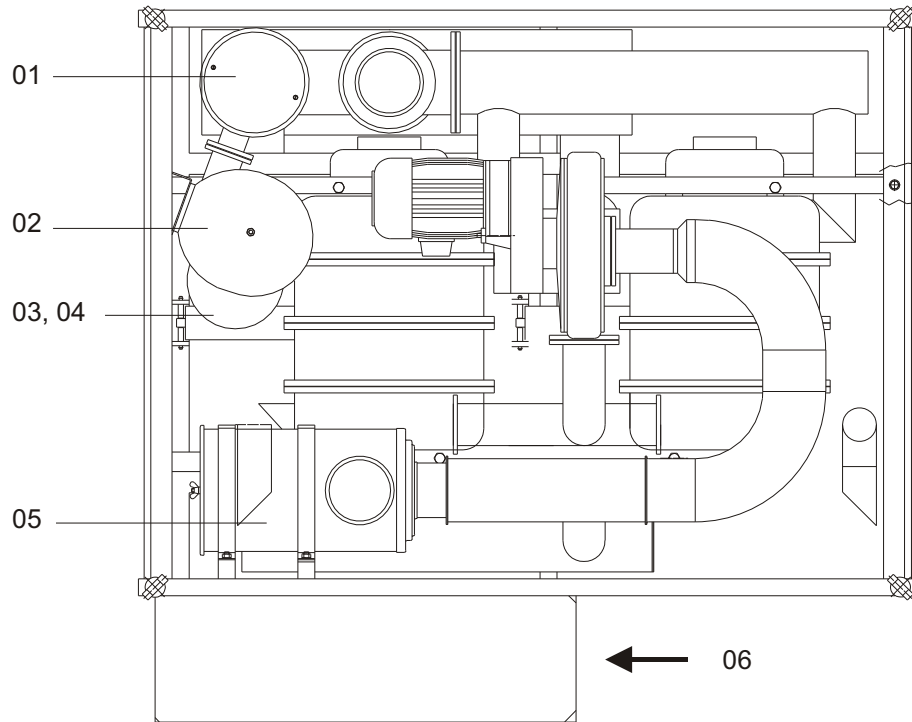

Spare parts list 10-2

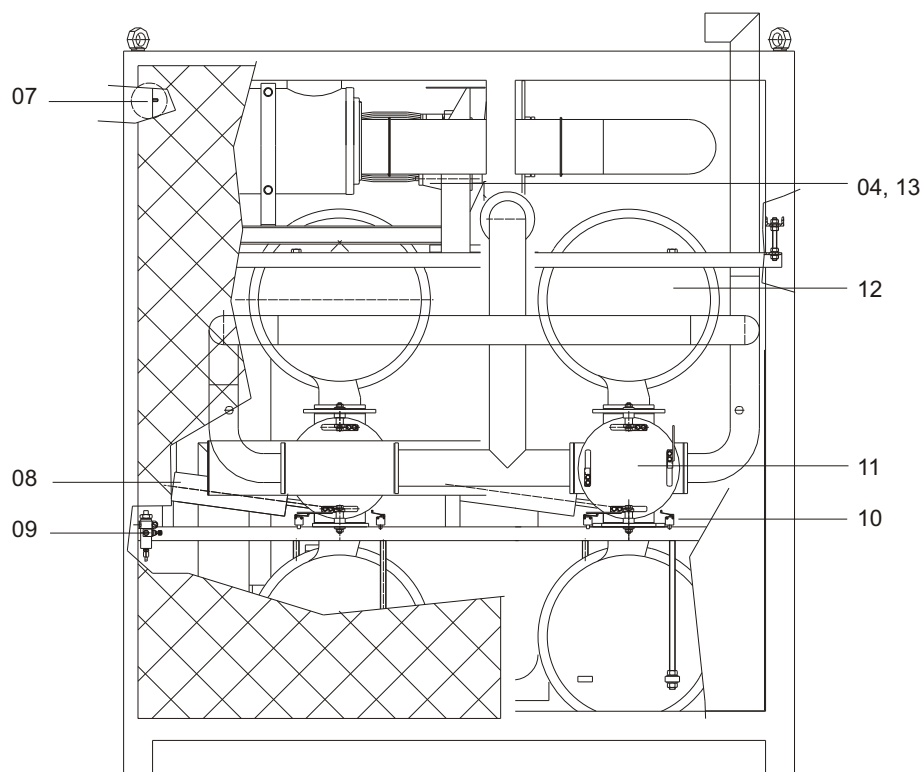

Pos.	ID-number	Description
04	97762	Silicon hose
	95819	Pull-button
07	85266	Field switch
08	86363	Spindle motor 24 V
09	83986	Moisture sensor
10	85682	Micro-switch
11	05190	Valve stem, complete
12	20952	Drying cell, complete
	96196	Drying agent
13	86367	High-pressure blower HRD 2/5T, 3,1 kW, 400 V/50 Hz
	86351	V-belt
Optional:		
	S82518	High-pressure blower HRD 2TFU with frequency converter operation
	83023	Frequency converter
	83022	Operating unit

Accessories

- 86371 Multiplier Pt 100 (3 m) (9.84 ft)
- 89846 Multiplier Pt 100 (6 m) (19.79 ft)
- 93303 Multiplier Pt 100 (9 m) (29.53 ft)
- 86387 Multiplier Pt 100 (12 m) (39.47 ft)
- 83015 Multiplier Pt 100 (15 m) (49.21 ft)

Return air cooler (optional)

- 29789 Return air cooler
- 87099 Solenoid valve 24 V
- 84503 Temperature converter
- 88225 Filter cartridge, temperature-proof (if a return air cooler is in use)

Flaps (optional)

- 16522 Motor flap NW150, complete
- 16517 Motor flap NW80, complete
- 86376 Motor operator 24 V, AD/DC, 50-60 Hz
- 18232 Air control flap
- 84492 Thermometer

Hopper heaters (optional)

- 85343 Radiator (1,5 kW)
- 85338 Radiator (3 kW)
- 85363 Radiator (6 kW)
- 85651 Radiator (9 kW)
- 85652 Temperature limiter STB hopper heaters

10.1. Switching Cabinet and Operating Unit

Observe spare parts list in the electrical manual.

11. Electrical manual



This electrical manual is intended to be used only by Sterling service personnel and trained personnel authorized by Colortronic.

Other persons are not permitted to modify or repair the equipment.

Connection diagram no.: _____

Currently not available; will be delivered at a later date!

12. Accessories





- Entering values on the OP 7 / 17
- Flap control with Fuzzy-Logic
- Elektror High-pressure blower with frequency converter operation
- Elektror High-pressure blower
-
-

Accessories

Entering values on the OP 7 / 17

3.3 Entering Values

General procedure In input fields, values can be entered on the OP and transferred to the PLC. To do this, proceed as follows:

Step	Procedure
1	Branch initially to the screen you require and then to the corresponding screen entry.
2	Using the arrow keys, select the input field you require within the screen entry.
3	Then enter your value. Depending on how the field has been configured, values may be input as inputs of numerical values (refer to section 3.3.1), inputs of alphanumeric values (refer to section 3.3.2), inputs of symbolic values (refer to section 3.3.3).
4	<p>Confirm your input with </p> <p>You can cancel any incorrect input by pressing </p> <p>The original value is then automatically reinserted in the field. Insert the correct value and then enter the corrected value by pressing </p>
5	<p>Position the cursor in the next input field, insert the next value etc.</p> <p>You can also use the arrow keys to move the cursor to the left or right to the previous input field to insert a different value in it.</p>
6	Close the screen by pressing 



3.3.1 Entering Numerical Values

Input using numerical keypad In fields that allow the operator to enter a numerical value, you enter the numerical value character by character using the keypad on the system keyboard.

Changing the value If there is a value in the field already, it is cleared completely from the field when the first character is entered. Once input has been started, you cannot exit from the field until the input has been entered or canceled.

Right-justified input In numerical fields, input initially is normally right-justified. Digits that have already been entered are moved to the left (pocket-calculator format).

Exception:

Input fields for variables in KM format – for instance, when calling the PU functions STATUS/FORCE VAR – are changed to left-justified. When input begins, the old value does not disappear from the display completely but its bit pattern is overwritten one character at a time. You move the cursor in this type of field by pressing  or  with activated Shift Lock mode.



Limit-value check You can configure **limit values** for numerical input fields. In this type of field, a limit-value check takes place, i.e. the entered values are applied only if they lie within the configured limits. If a value outside these limits is entered, a system message is displayed and, after it has been canceled, the old value is restored in the field.

Decimal places If a numerical field has been configured with a certain number of **decimal places** and too many have been entered, they are ignored; if too few have been entered, the field is padded with zeroes.

3.3.2 Entering Alphanumeric Values









Mixed input of digits and letters

With the input of alphanumeric values, digits and letters are mixed.

For the numerical components of the input, proceed as described in section 3.3.1. If, however, you wish to enter a letter at the current cursor position, you must enable the corresponding alphanumeric font. In this instance, you move the cursor with activated Shift Lock mode with  and .

Entering A to F characters













A to F characters can be entered directly with activated Shift Lock mode using numeric keys 1 to 6. If you want to enter digits again after the letters, Shift Lock mode must be de-activated. To enter the alphanumeric string 7FEB53, for example, proceed as follows:

Step	Procedure
1	Press 
2	Press Shift-LED is on. 
3	Press in succession   
4	Press Shift-LED goes out. 
5	Press in succession  
6	Confirm by pressing 

Extended character set

If the characters available on the keypad are not sufficient for the alphanumeric input, you can select additional letters and special characters from the extended character set. The extended character set is available for all KC type fields.



To enter the string 18OKT61, for example, proceed as follows:

Step	Procedure
1	Press in succession  
2	Press  Shift-LED is on. The extended character set is available.
3	Scroll with the arrow keys through the extended character set.  
4	Select O and, using the arrow key, move right one position.  The character you selected is applied by moving the cursor.
5	Select K and, using the arrow key, move right one position. 
6	Select T and, using the arrow key, move right one position. 
7	Press  Shift-LED goes out.
8	Press in succession  
9	Confirm by pressing 

3.3.3 Entering Symbolic Values

Text instead of a value

When you enter a symbolic value, text is displayed instead of the value. If a field has to be filled by entering symbolic values, take the value from a list of options. To do so, proceed as follows:

Step	Procedure
1	In the input field press  Shift LED is on. The list of options with its configured symbolic inputs is activated.
2	Select the value you require using the arrow keys.
3	Enter the value you selected by pressing  Shift Lock mode is de-activated automatically.

Accessories

Flap control with Fuzzy-Logic



Observe that the hopper is not switched off after the flap has closed.
Turning hopper off: see chapter “start-up, turning the devices on/off”.

Control unit “flap”

Switch position:

- 0 = “Quick closing”
flap closes quick
- 1 = “Slow closing”
flap closes controlled
- 2 = “Automatic control”
flap operates pulsed
(opening/closing)

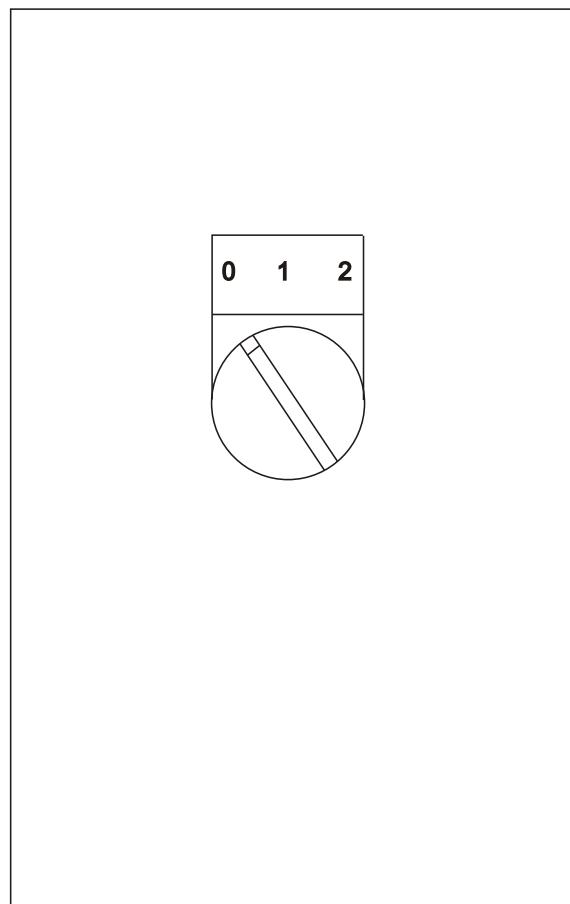

Free Manuals Download Website

<http://myh66.com>

<http://usermanuals.us>

<http://www.somanuals.com>

<http://www.4manuals.cc>

<http://www.manual-lib.com>

<http://www.404manual.com>

<http://www.luxmanual.com>

<http://aubethermostatmanual.com>

Golf course search by state

<http://golfingnear.com>

Email search by domain

<http://emailbydomain.com>

Auto manuals search

<http://auto.somanuals.com>

TV manuals search

<http://tv.somanuals.com>