



SCC 7-Pump 50D & D Plus-Station Controllers

Part Number: 882.00254.00
Bulletin Number: CV3-645
Effective: 2/15/06

Write Down Your Serial Numbers Here For Future Reference:

_____	_____
_____	_____
_____	_____

We are committed to a continuing program of product improvement.
Specifications, appearance, and dimensions described in this manual are subject to change without notice.

DCN No. _____
© Copyright 2006
All rights reserved.

Please note that our address and phone information has changed. Please reference this page for updated contact information.



These manuals are obsolete and are provided only for their technical information, data and capacities. Portions of these manuals detailing procedures or precautions in the operation, inspection, maintenance and repair of the products may be inadequate, inaccurate, and/or incomplete and shouldn't be relied upon. Please contact the ACS Group for more current information about these manuals and their warnings and precautions.

Parts and Service Department

The ACS Customer Service Group will provide your company with genuine OEM quality parts manufactured to engineering design specifications, which will maximize your equipment's performance and efficiency. To assist in expediting your phone or fax order, please have the model and serial number of your unit when you contact us. A customer replacement parts list is included in this manual for your convenience. ACS welcomes inquiries on all your parts needs and is dedicated to providing excellent customer service.

For immediate assistance, please contact:

- North, Central and South America, 8am – 5pm CST +1 (800) 483-3919 for drying, conveying, heating and cooling and automation. For size reduction: +1 (800) 229-2919.
North America, emergencies after 5pm CST (847) 439-5855
North America email: acsuscanadacustserv@corpemail.com
- Mexico, Central & South America
Email: acslatinamericacustserv@corpemail.com
- Europe, Middle East & Africa +48 22 390 9720
Email: acseuropecustserv@corpemail.com
- India +91 21 35329112
Email: acsindiacustserv@corpemail.com
- Asia/Australia +86 512 8717 1919
Email: acsasiacustserv@corpemail.com

Sales and Contracting Department

Our products are sold by a worldwide network of independent sales representatives. Contact our Sales Department for the name of the sales representative nearest you.

Let us install your system. The Contract Department offers any or all of these services: project planning; system packages including drawings; equipment, labor, and construction materials; and union or non-union installations.

For assistance with your sales or system contracting needs please Call:

North, Central and South America +1 (262) 641-8600 or +1 (847) 273-7700 Monday–Friday, 8am–5pm CST

Europe/Middle East/Africa +48 22 390 9720

India +91 21 35329112

Asia/Australia +86 512 8717 1919

Facilities:

ACS offers facilities around the world to service you no matter where you are located. For more information, please visit us at www.acscorporate.com

United States:

ACS Schaumburg – Corporate Offices

1100 E. Woodfield Road
Suite 588
Schaumburg, IL 60173
Phone: + 1 847 273 7700
Fax: + 1 847 273 7804

ACS New Berlin – Manufacturing Facility

2900 S. 160th Street
New Berlin, WI 53151
Phone : +1 262 641 8600
Fax: + 1 262 641 8653

Asia/Australia:

ACS Suzhou

109 Xingpu Road SIP
Suzhou, China 215126
Phone: + 86 8717 1919
Fax: +86 512 8717 1916

Europe/Middle East/Africa:

ACS Warsaw

Ul. Działkowa 115
02-234 Warszawa
Phone: + 48 22 390 9720
Fax: +48 22 390 9724

India

ACS India

Gat No. 191/1, Sandbhor Complex
Mhalunge, Chakan, Tal Khed,
Dist. Pune 410501, India
Phone: +91 21 35329112
Fax: + 91 20 40147576

Shipping Information

Unpacking and Inspection

You should inspect your equipment for possible shipping damage. Thoroughly check the equipment for any damage that might have occurred in transit, such as broken or loose wiring and components, loose hardware and mounting screws, etc.

In the Event of Shipping Damage

According to the contract terms and conditions of the Carrier, the responsibility of the Shipper ends at the time and place of shipment.

Notify the transportation company's local agent if you discover damage

Hold the damaged goods and packing material for the examining agent's inspection. **Do not return any goods before the transportation company's inspection and authorization.**

File a claim with the transportation company. Substantiate the claim by referring to the agent's report. A certified copy of our invoice is available upon request. The original Bill of Lading is attached to our original invoice. If the shipment was prepaid, write us for a receipted transportation bill.

Advise customer service regarding your wish for assistance and to obtain an RMA (return material authorization) number.

If the Shipment is Not Complete

Check the packing list as back-ordered items are noted on the packing list. In addition to the equipment itself, you should have:

- .. Bill of lading
- .. Packing list
- .. Operating and Installation packet
- Electrical schematic and panel layout drawings
- .. Component instruction manuals (if applicable)

Re-inspect the container and packing material to see if you missed any smaller items during unpacking.

If the Shipment is Not Correct

If the shipment is not what you ordered, **contact the shipping department immediately**. For shipments in the United States and Canada, call 1 (630) 595-1060; for all other countries, call our international desk at (630) 595-1060. Have the order number and item number available. *Hold the items until you receive shipping instructions.*

Returns

Do not return any damaged or incorrect items until you receive shipping instructions from the shipping department.

Table of Contents

Shipping Information	2
<i>Unpacking and Inspection</i>	2
<i>In the Event of Shipping Damage</i>	2
<i>If the Shipment is Not Complete</i>	2
<i>If the Shipment is Not Correct</i>	2
<i>Returns</i>	2
Table of Contents.....	3
CHAPTER 1: SAFETY	6
1-1 How to Use This Manual	6
<i>Safety Symbols Used in this Manual</i>	6
1-2 Warnings and Precautions	7
1-3 Responsibility	8
<i>General Responsibility</i>	8
<i>Operator Responsibility</i>	9
<i>Maintenance Responsibility</i>	9
<i>Reporting a Safety Defect</i>	9
CHAPTER 2: FUNCTIONAL DESCRIPTION.....	10
2-1 Models Covered in This Manual.....	10
2-2 General Description.....	10
2-3 Standard Features.....	11
<i>Mechanical Features</i>	11
<i>Electrical Features</i>	11
<i>Controller Features</i>	11
2-4 Optional Features.....	12
2-5 Safety Devices and Interlocks	12
<i>Safety Circuit Standards</i>	12
<i>Fail Safe Operation</i>	12
<i>Safety Device Lock-Outs</i>	13
CHAPTER 3: INSTALLATION	14
3-1 Uncrating.....	14
3-2 Mounting the Control Panel.....	14
3-3 System Installation Overview	14
3-4 Electrical Connections.....	15
<i>Making Control Panel Power Drop Wiring Connections</i>	15
<i>Running KwikLink™ Cables</i>	15
<i>Setting Up and Installing Mounting Plates</i>	17
<i>Terminating Cable Runs</i>	18
<i>Addressing and Installing ArmorBlocks™</i>	20
<i>Installing KwikLink™ Connectors</i>	23
<i>Connecting the Controller to the Network</i>	24
<i>Connecting the Power Supply Enclosure to the Network</i>	26
<i>Connecting Vacuum Receivers to the Network</i>	28
<i>Connecting Vacuum Pumps and Filter Chambers to the Network</i>	30
<i>Connecting Central Alarms to the Network</i>	33

3-5	Setup.....	35
	<i>Setting Up the System</i>	36
	<i>Setting Up Stations</i>	43
	<i>Setting Up Pumps</i>	47
	<i>Finishing Setup: Setting Up Passwords</i>	51
3-6	Initial Startup.....	53
CHAPTER 4: OPERATION		54
4-1	Overview	54
4-2	Starting and Stopping the System.....	54
4-3	Basic Tasks.....	55
	<i>Reviewing Station Status</i>	55
	<i>Reviewing Pump Status</i>	57
	<i>Logging On and Logging Off</i>	59
	<i>Enabling and Disabling Stations and Pumps</i>	60
	<i>Reviewing and Adjusting Basic Station Settings</i>	61
4-4	Advanced Tasks.....	64
	<i>Reviewing and Resetting a Pump Hour Meter</i>	65
	<i>Transferring Stations to a Standby Pump</i>	66
3-5	Alarms	69
	<i>Reviewing Alarms</i>	69
	<i>Clearing the Alarm Log</i>	70
	<i>Silencing Alarms</i>	71
CHAPTER 5: MAINTENANCE		72
5-1	Preventative Maintenance.....	72
5-2	Corrective Maintenance	72
	<i>Network Scanner Module Considerations</i>	72
CHAPTER 6: CONFIGURABLE SETTINGS.....		73
6-1	Memory Module Considerations.....	73
6-2	Options for Station Setup	73
6-3	Options for Pump Setup	78
CHAPTER 7: TROUBLESHOOTING		80
7-1	General Troubleshooting.....	80
7-2	Alarms.....	81
	<i>Station Alarms</i>	81
	<i>Pump Alarms</i>	82
	<i>System Alarms</i>	83
CHAPTER 8: APPENDIX		84
8-1	Warranty.....	84
8-2	Optional Components.....	84
8-3	Drawings and Diagrams	85
8-4	Spare Parts List.....	88
	<i>AC Voltage</i>	88
	<i>DC Voltage</i>	88
8-5	Returned Material Policy	88

	<i>Credit Returns</i>	88
	<i>Warranty Returns</i>	89
8-6	Safety Tag Information	89
	<i>Controller Safety Tags</i>	89
8-7	Controller Identification (Serial Number) Tag	89
8-8	Technical Assistance (Contact Information).....	90
	<i>Parts Department</i>	90
	<i>Service Department</i>	90
	<i>Sales Department</i>	90
	<i>Contract Department</i>	90

Chapter 1: Safety

1-1 How to Use This Manual

Use this manual as a guide and reference for installing, operating, and maintaining your equipment. The purpose is to assist you in applying efficient, proven techniques that enhance equipment productivity.

This manual covers only light corrective maintenance. No other maintenance should be undertaken without first contacting a service engineer.

The Functional Description section outlines models covered, standard features, and optional features. Additional sections within the manual provide instructions for installation, pre-operational procedures, operation, preventive maintenance, and corrective maintenance.

The Installation chapter includes required data for receiving, unpacking, inspecting, and setup of the equipment. We can also provide the assistance of a factory-trained technician to help train your operator(s) for a nominal charge. This section includes instructions, checks, and adjustments that should be followed before commencing with operation of the equipment. These instructions are intended to supplement standard shop procedures performed at shift, daily, and weekly intervals.

The Operation chapter includes a description of electrical and mechanical controls, in addition to information for operating the equipment safely and efficiently.

The Maintenance chapter is intended to serve as a source of detailed assembly and disassembly instructions for those areas of the equipment requiring service. Preventive maintenance sections are included to ensure that your equipment provides excellent, long service.

The Troubleshooting chapter serves as a guide for identification of most common problems. Potential problems are listed, along with possible causes and related solutions.

The Appendix contains technical specifications, drawings, schematics, and parts lists. A spare parts list with part numbers specific to your machine is provided with your shipping paperwork package. Refer to this section for a listing of spare parts for purchase. Have your serial number and model number ready when ordering.

Safety Symbols Used in this Manual

The following safety alert symbols are used to alert you to potential personal injury hazards. Obey all safety messages that follow these symbols to avoid possible injury or death.

Danger! *DANGER indicates an imminently hazardous situation which, if not avoided, will result in death or serious injury.*

Warning! *WARNING indicates a potentially hazardous situation or practice which, if not avoided, could result in death or serious injury.*

Caution! *CAUTION indicates a potentially hazardous situation or practice which, if not avoided, may result in minor or moderate injury or in property damage.*

1-2 Warnings and Precautions

Our equipment is designed to provide safe and reliable operation when installed and operated within design specifications, following national and local safety codes. This may include, but is not limited to OSHA, NEC, CSA, SPI, and any other local, national and international regulations.

To avoid possible personal injury or equipment damage when installing, operating, or maintaining this equipment, use good judgment and follow these safe practices:

- ☑ **Read and follow these operation and installation instructions when installing, operating, and maintaining this equipment. If these instructions become damaged or unreadable, additional copies are available from the manufacturer.**
- ☑ Follow all **SAFETY CODES**.
- ☑ Wear **SAFETY GLASSES** and **WORK GLOVES**.
- ☑ Work only with approved tools and devices.
- ☑ Disconnect and/or lock out power before servicing or maintaining the equipment.
- ☑ Use care when **LOADING, UNLOADING, RIGGING, or MOVING** this equipment.
- ☑ Operate this equipment within design specifications.
- ☑ **OPEN, TAG, and LOCK ALL DISCONNECTS** before working on equipment. You should remove the fuses and carry them with you.
- ☑ Make sure the equipment and components are properly **GROUNDED** before you switch on power.
- ☑ Use extreme caution when working with your conveying system. **HIGH VACUUM** can be dangerous. Keep body parts, tools, clothing, and debris away from vacuum inlets.
- ☑ When welding or brazing in or around this equipment, make sure **VENTILATION** is **ADEQUATE. PROTECT** adjacent materials from flame or sparks by shielding with sheet metal. An approved **FIRE EXTINGUISHER** should be close at hand and ready for use if needed.
- ☑ Do not restore power until you remove all tools, test equipment, etc., and the equipment and related components are fully reassembled.
- ☑ Only **PROPERLY TRAINED** personnel familiar with the information in this manual should work on this equipment.

We have long recognized the importance of safety and have designed and manufactured our equipment with operator safety as a prime consideration. We expect you, as a user, to abide by the foregoing recommendations in order to make operator safety a reality.

1-3 Responsibility

These machines are constructed for maximum operator safety when used under standard operating conditions and when recommended instructions are followed in the maintenance and operation of the machine.

All personnel engaged in the use of the machine should become familiar with its operation as described in this manual.

Proper operation of the machine promotes safety for the operator and all workers in its vicinity.

Each individual must take responsibility for observing the prescribed safety rules as outlined. All warning and danger signs must be observed and obeyed. All actual or potential danger areas must be reported to your immediate supervisor.

General Responsibility

No matter who you are, safety is important. Owners, operators and maintenance personnel must realize that every day, safety is a vital part of their jobs.

If your main concern is loss of productivity, remember that production is always affected in a negative way following an accident. The following are some of the ways that accidents can affect your production:

- Loss of a skilled operator (temporarily or permanently)
- Breakdown of shop morale
- Costly damage to equipment
- Downtime

An effective safety program is responsible and economically sound.

Organize a safety committee or group, and hold regular meetings. Promote this group from the management level. Through this group, the safety program can be continually reviewed, maintained, and improved. Keep minutes or a record of the meetings.

Hold daily equipment inspections in addition to regular maintenance checks. You will keep your equipment safe for production and exhibit your commitment to safety.

Please read and use this manual as a guide to equipment safety. This manual contains safety warnings throughout, specific to each function and point of operation.

Operator Responsibility

The operator's responsibility does not end with efficient production. The operator usually has the most daily contact with the equipment and intimately knows its capabilities and limitations.

Plant and personnel safety is sometimes forgotten in the desire to meet incentive rates, or through a casual attitude toward machinery formed over a period of months or years. Your employer probably has established a set of safety rules in your workplace. Those rules, this manual, or any other safety information will not keep you from being injured while operating your equipment.

Learn and always use safe operation. Cooperate with co-workers to promote safe practices. Immediately report any potentially dangerous situation to your supervisor or appropriate person.

Maintenance Responsibility

Proper maintenance is essential to safety. If you are a maintenance worker, you must make safety a priority to effectively repair and maintain equipment.

Before removing, adjusting, or replacing parts on a machine, remember to turn off all electric supplies and all accessory equipment at the machine, and disconnect and lockout electrical power. Attach warning tags to the disconnect switch.

Be sure that all non-current carrying parts are correctly connected to earth ground with an electrical conductor that complies with current codes. Install in accordance with national and local codes.

When you have completed the repair or maintenance procedure, check your work, remove your tools. Rigging, and handling equipment.

Reporting a Safety Defect

If you believe that your equipment has a defect that could cause injury, you should immediately discontinue its use and inform the manufacturer.

The principle factors that can result in injury are failure to follow proper operating procedures (i.e. lockout/tagout), or failure to maintain a clean and safe working environment.

Chapter 2: Functional Description

2-1 Models Covered in This Manual

This manual provides operation, installation, and maintenance instructions for 7-Pump, 50D & D Plus-Station Conveying Controllers. Model numbers are listed on the serial tag. Make sure you know the model and serial number of your equipment before contacting the manufacturer for parts or service.

The 7-Pump, 50D & D Plus-Station Conveying Controller is a programmable logic controller, with 24 VDC or 115 VAC control circuit, easy-to-use touchscreen operator interface terminal and optional audible/visual alarm.

2-2 General Description

Our material conveying systems create vacuum for the automatic conveying of most free-flowing, dry, pelletized, or granular materials. Material characteristics determine the type of equipment needed to convey the material.

A typical use for our equipment is an in-plant distribution system for plastic processing plants.

Our central vacuum systems are as varied as the applications they service. The tubing and equipment furnished in our system is designed to convey the material(s) specified at the time of purchase at specific rates and distances.

We can advise you on your system capabilities based on system makeup, distance, material, and conveying rates you want.

System capacity is directly affected by the pressure drop in the overall system, such as number of material line bends, pipe length, Y-tubes, T-tubes, etc.

Use the minimum effective amount of vinyl flex hose to maximize material line efficiency. Keep material lines as straight as possible. Refer to the **Mechanical Components Product manual (Part No. A0536580)** for installation recommendations.

Note: Vacuum leaks occurring anywhere in your system reduce capacity.

2-3 Standard Features

Mechanical Features

Time-fill Capability. The length of time allowed for material to drain from the station to its receiver. During this time, the controller does not attempt to deliver any more material to the station.

Volume-fill Capability. The length of time a station's vacuum valve remains open to allow material to be drawn in. The vacuum valve will close when material covers the station's volume-fill proximity sensor or this time elapses, whichever comes first.

Vent Valve Output. The vent valve protects the pump motor from damage during high vacuum conditions if an undetected failure of the vacuum switch should occur. The vent valve limits system vacuum by allowing a plunger in the valve to shift and vent the pump.

Closed-Loop Conveying. This feature allows material to be conveyed and processed without being contaminated by outside influences (such as dust, other materials, etc.).

Common Purge Valve Output Control for Each Pump. This feature allows any remaining material to be cleaned out of the vacuum pump or station.

Local Blowback Filter Cleaning Outputs. When this feature is enabled, the controller periodically sends compressed air backward through the pump's air filter to dislodge accumulated dust and debris.

Electrical Features

- 115/1/60 or 230/1/50/60 supply voltage
- 24 VDC control voltage
- Single-point power and ground connection
- Non-fused disconnect switch, lockable
- Branch circuit fusing
- Fully accessible NEMA 4-style electrical control enclosure

Controller Features

- Allen-Bradley SLC 5/04 programmable controller with 10" color touch screen operator interface
- Diagnostics, operating instructions and parts information are built into the interface
- Controls up to fifty (50) stations and up to seven (7) Vacuum Power Units.
- Controls up to three central alarms
- Allows operator to transfer stations to a standby pump when a pump fails
- Electronic time delay between pump startups to prevent an excessive power demand at your facility

2-4 Optional Features

Options marked with “*” indicate options that can be factory installed or retrofitted in the field.

230/1/60 Operation. Required to operate with a 230/1/60 supply voltage.

Additional audible/visual alarm with silence button. Alarm light and horn assembly that can be remote mounted and wired into the controller to indicate an alarm condition.

Remote Interface.

Central Purge Capability.

Material Line Proofing

CE Package for 220/1/50 Operation. Required in Europe and other areas that need 220/1/50 supply voltage.

2-5 Safety Devices and Interlocks

This section includes information on safety devices and procedures that are inherent to the Controller. This manual is not intended to supersede or alter safety standards established by the user of this equipment. Instead, the material contained in this section is recommended to supplement these procedures in order to provide a safer working environment.

At the completion of this section, the operator and maintenance personnel will be able to do the following:

- Identify and locate specific safety devices.
- Understand the proper use of the safety devices provided.
- Describe the function of the safety device.

Safety Circuit Standards

Safety circuits used in industrial systems protect the operator and maintenance personnel from dangerous energy. They also provide a means of locking out or isolating the energy for servicing equipment.

Various agencies have contributed to the establishment of safety standards that apply to the design and manufacture of automated equipment. The Occupational Safety and Health Administration (OSHA) and the Joint Industrial Council (JIC) are just a few of the organizations that have joined with the plastics industry to develop safety standards.

Every effort has been made to incorporate these standards into the design of the controller; however, it is the responsibility of the personnel operating and maintaining the equipment to familiarize themselves with the safety procedures and the proper use of any safety devices.

Fail Safe Operation

If a safety device or circuit should fail, the design must be such that the failure causes a “Safe” condition. As an example, a safety switch must be a normally open switch. The switch must be held closed with the device it is to protect. If the switch fails, it will go to the open condition, tripping out the safety circuit.

At no time should the safety device fail and allow the operation to continue for example, if a safety switch is guarding a motor, and the safety switch fails, the motor should not be able to run.

Safety Device Lock-Outs

Some safety devices disconnect electrical energy from a circuit. The safety devices that are used in this Controller are primarily concerned with electrical power disconnection.

WARNING! *Always disconnect and lockout all electrical power and pneumatic (i.e. compressed air) sources prior to servicing the 7-Pump, 50D & D Plus-Station Controller. Failure to do so may result in serious injury. No one but the person who installed the lockout may remove it.*



Chapter 3: Installation

3-1 Uncrating

7-Pump, 50D & D Plus-Station Controllers are shipped mounted on a skid, enclosed in a plastic wrapper, and contained in a cardboard box.

1. Pry the crating away from the skid.

Note: *Remove the nails holding the box to the skid and lift the box off carefully; avoiding staples in the 1' x 4' wood supports. Cut the steel banding.*

2. Use a pry bar to remove the blocks securing the unit to the skid.
3. Lift unit from sides, inserting forklift under the base. The forks must be equidistant from the centerline of the unit and the unit must be balanced on the forks. Lift slowly and only high enough to clear the skid. Use a pry bar if necessary to carefully remove the skid from the unit.
4. Lower slowly.

3-2 Mounting the Control Panel

Note: *Before you mount the panel, consider how you run wiring to the KwikLink connectors, ArmorBlocks, vacuum hoppers, the filter chamber atmospheric valve (if so equipped) and the pump motor starter(s), vacuum switch(es), and vent valve(s).*

Mount the control panel on a flat, vertical area. It should be a visible area that gives your operator access to the control. The panel requires a low voltage power drop as listed on the serial tag.

3-3 System Installation Overview

Installing the 7-pump 50-station controller is easy and straightforward. Because the system uses networked distributed I/O modules, you'll only need to run two cables for the entire system.

The following is a typical installation sequence:

1. Run the black power and the grey data KwikLink™ flat cables from the start of the system to the end, attaching them to vacuum tubing with nylon cable ties.
2. Set up mounting plates with tubing clamps; install KwikLink™ connectors and ArmorBlocks onto mounting plates as required.
3. Install KwikLink connectors and ArmorBlock™ cable plates to mounting plates, and install on vacuum tubing at each node location, just before a T-fitting or valve.
4. Install cable terminations.
5. Determine location of network system nodes, and set addresses for ArmorBlocks as required.
6. Set up and connect to the controller and, if purchased, remote display. Connect grey patch cords from controller terminals to KwikLink connectors installed in Step 3.

7. After determining quantity and location(s) of where to install system power supply(ies) (**consult factory**); set up and connect to KwikLink connectors installed in Step 3.
8. Set up and connect vacuum receiver stations to ArmorBlocks installed in Step 3, using yellow patch cords.
9. Set up and connect vacuum pump stations and filter chambers to ArmorBlocks installed in Step 3, using yellow patch cords.
10. Determine location(s) of central alarm(s); set up and connect alarms using yellow patch cords.

The following sections provide detailed information on these installation steps.

3-4 Electrical Connections

Refer to local electrical codes, the schematic and connection diagrams supplied with this unit and the serial tag for wiring considerations. Run all wiring in conduit if codes require it.

Making Control Panel Power Drop Wiring Connections

Hardwire the input power at 115/1/50-60 VAC or 230/1/50-60 VAC, depending on the specifications, which are located on the Control Panel Serial Tag. The control enclosure draws less than five (5) amps during normal operation at 115/1/50-60 VAC. The main power switch is located on the right side of the enclosure.

Caution! *We recommend that you protect PLC memory by providing the control panel with a dedicated circuit, a true earth ground, and a spike/surge protector.*

Running KwikLink™ Cables

About KwikLink Flat Cables

KwikLink flat cable is physically keyed to prevent wiring mishaps. This type of cable is unshielded and contains four conductors. Use a long-jawed straight-bladed cable cutter at least 1½” long to cut KwikLink flat cable.

You’ll install two (2) colors of flat cable: black and grey. The black cable transmits output power, and the grey cable transmits input power and data transmission.

Figure 1: KwikLink Cable Cross-Section, Edge Identification

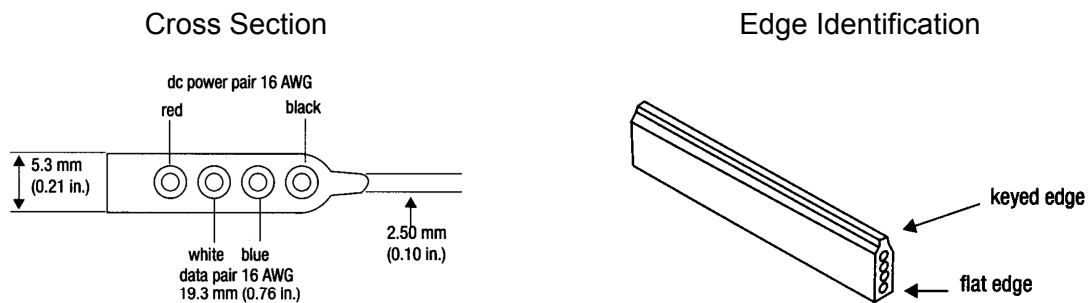

Installing KwikLink Cable

Before you install flat cable, determine how much length you need to install black power cable and grey data cable. Typical installations have equal lengths of each. **This is a good time to plan for the future**, and run these cables to each possible location in the plant. Use a straight-blade cable cutter to make the cut at each end.

To install KwikLink cables:

1. Cut both black and grey cables to the proper length.
2. Use cable ties to attach KwikLink cables, **black cable above grey cable**, on the **vacuum tubing**. Attach cable to the tubing with cable ties at about three-foot (3 ft./ 1 m) intervals. Make sure that cable ties are snug, but not tightened enough to bend the flat cable.

Caution! *Install KwikLink cable on vacuum tubing only. DO NOT install KwikLink cable on material conveying tubing, as static electricity formed at material lines could disrupt system operation.*

Figure 2: Side View of a Typical Power Cable and Data Cable Installation

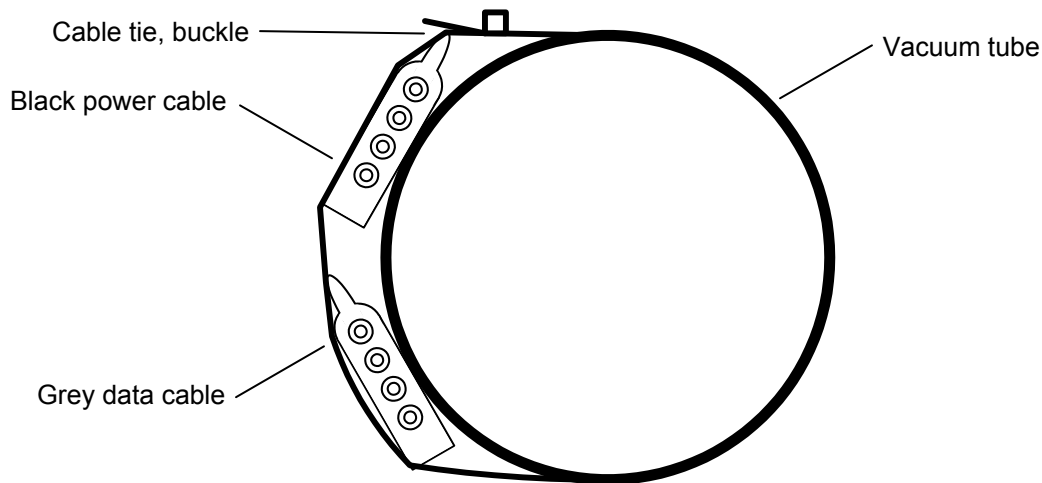

Note: *When approaching a node location, stop the attachment process. Run the cables over the node area (such as a T-valve) and make sure you create a slight amount of slack when continuing the attachment with cable ties. Doing so lets you install KwikLink connectors or ArmorBlocks with greater ease, with less stress on the cable.*

Setting Up and Installing Mounting Plates

Setting Up Mounting Plates

It's a good idea to get all your mounting plates set up with KwikLink connector bases or ArmorBlock cable bases *before* installation, as your system layout determines.

Note: ArmorBlock cable bases are installed on mounting plates perpendicular in orientation to the flat cable runs.

Vacuum hoppers/receiver stations require 8-connector ArmorBlocks; vacuum pumps and central alarm stations require 4-connector ArmorBlocks.

Make sure that each mounting plate has properly attached tube clamps as required. **Each mounting plate requires two (2) tube clamps.** Always use locking washers, especially in high-vibration environments.

Figure 3: Side View of a Typical Mounting Plate Assembly with ArmorBlock Base

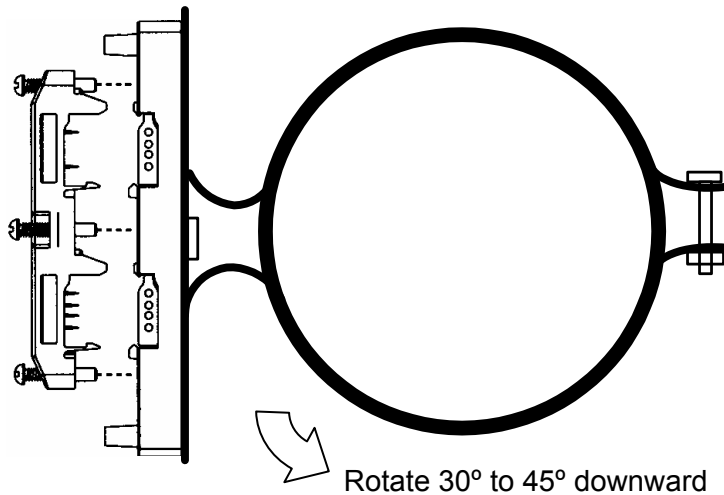

Installing Assembled Mounting Plates

After you've set up the mounting plates:

1. Install them at each node location by clipping the tubing clamps onto the vacuum tube, just before the node area (such as a T-valve).
2. Orient the mounting plate parallel with the flat cables and at a 30° to 45° angle so the KwikLink connector or ArmorBlock faces the operator on the floor; torque the tubing clamp fasteners until tight.

The flat cable will be installed inside KwikLink connectors and ArmorBlocks as described in the following sections of this chapter.

Terminating Cable Runs

After you've run the black and grey network cables, you need to properly terminate the ends of the cables. By doing so, you'll insure that the network runs properly. You will also have the benefit of being able to measure voltage in the system without disrupting operation.

This section lists procedures for terminating these cables. To properly terminate a cable run:

1. Mount three standard KwikLink connectors to a mounting plate in a triangle configuration. See Figure 4 on Page 19 for an illustration.

Make sure that each connector is installed with the hinge side down.

2. Mount the tubing clamps to the mounting plates. Each mounting plate requires two (2) tubing clamps.
3. Mount the **standard resistor cap** from the KwikLink connector kit on the **top center** KwikLink connector for the black power flat cable. ***The standard resistor cap has metal prongs in the center.***

Repeat for the outside end KwikLink connector on the grey data flat cable.

4. For the **inside** KwikLink connector (next to the outside end on the grey cable), mount a separately-packaged **blank cap** on it **instead** of the standard resistor cap in the KwikLink connector kit.

Discard the standard resistor cap to eliminate confusion.

5. Mount the mounting plate assembly on the vacuum line at the end of the cable run. See Page 17 for more information.
6. Using the straight-blade cable cutter, carefully trim each flat cable so it sticks out past the final KwikLink connector by $\frac{1}{4}$ " to $\frac{3}{8}$ ".

Place a dust cap over the end of the trimmed cable.

7. Lay the dust cap and cable into the KwikLink connector so the dust cap tabs engage in the connector slots. ***The dust cap tabs should fit into the connector slots perfectly.***

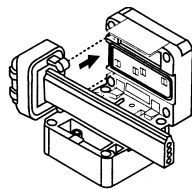

Left

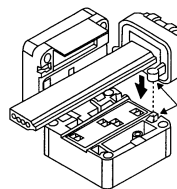

Right

8. Lay the cable in the hinged base, noting the correct keyed profile; flat edge toward the hinge, keyed edge toward the latch. ***Make sure that the cable and dust cap are properly seated inside.***
9. **Making sure that the cable is completely straight**, ***carefully*** close the hinged assembly, and apply firm, even pressure until the first latch locks into place.

Note: Make sure that the flat cable is completely straight before continuing!!

The latch has two catches; the first loosely holds the connector on the cable, the second requires more pressure to close the connector tightly. The cable must be in the correct position for the connector to close properly.

10. Drive the two screws at the center points about halfway down; first on the latch side, then the hinge side.
11. Continue to tighten the screws a little at a time until fully tightened; no more than 15 inch-pounds (5.6 N•m) of torque.

Note: *You can only pierce the cable once. Once pierced, the KwikLock connector must not be removed. This insures that the inner conductors are not exposed to the elements.*

Installing Inside KwikLink Connectors with Blank Caps

Once installed on the grey data cables, these connectors permit you to measure voltage in the system so you can analyze how it is working. **The system cannot work properly unless these inside-mounted connectors have the blank (non-conductor) caps installed.**

1. Lay the cable in the hinged base, noting the correct keyed profile; flat edge toward the hinge, keyed edge toward the latch. **Make sure that the cable is properly seated inside.**
2. **Making sure that the cable is completely straight, carefully** close the hinged assembly, and apply firm, even pressure until the first latch locks into place.

Note: *Make sure that the flat cable is completely straight before continuing!!*

The latch has two catches; the first loosely holds the connector on the cable, the second requires more pressure to close the connector tightly. The cable must be in the correct position for the connector to close properly.

3. Drive the two screws at the center points about halfway down; first on the latch side, then the hinge side.
4. Continue to tighten the screws a little at a time until fully tightened; no more than 15 inch-pounds (5.6 N•m) of torque.

Note: *You can only pierce the cable once. Once pierced, the KwikLock connector must not be removed. This insures that the inner conductors are not exposed to the elements.*

The system should now be properly terminated. You can now continue to install components on the system.

Figure 4: Proper Termination Connections

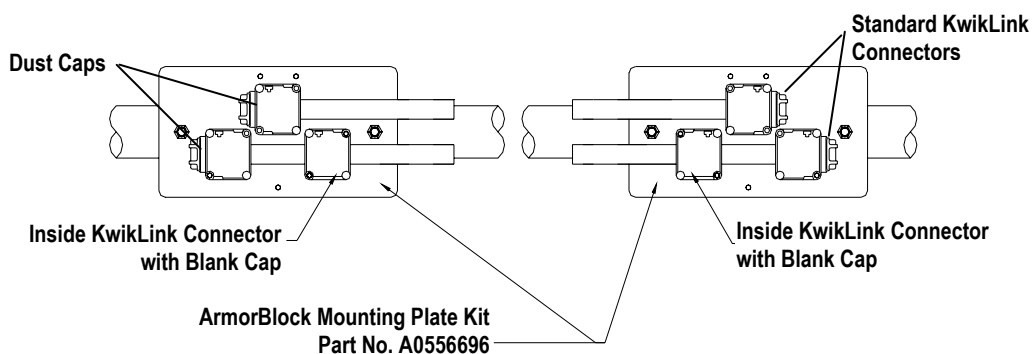

Addressing and Installing ArmorBlocks™

Addressing Armorblocks

An ArmorBlock permits you to give it a number “address” so that the controller network system can recognize its location and function. ArmorBlocks are used at vacuum hopper/receiver, pump, and alarm node locations.

ArmorBlock Address Ranges

The number range of ArmorBlock addresses are as follows:

- **01 to 50** — Vacuum hopper/receiver stations; use a leading zero for numbers 01 to 09.
- **51 to 57** — Pump stations
- **58 to 60** — Alarm stations

Setting Armorblock Addresses

Locate the rotary switches underneath the ArmorBlock. The two switches are:

- **MSD** (most significant digit) for tens
- **LSD** (least significant digit) for units/ones

For example, if you wanted to set an address at **36**, you set the MSD rotary switch at **3** and the LSD rotary switch at **6**. To set an address of **8**, set the MSD rotary switch at **0** (leading zero), then set the LSD rotary switch at **8**.

- Using a permanent black marker, **write the number of the address on the white label** located on the bottom front of the ArmorBlock. We suggest that you **place numbered tags at node locations** to ease installation and reduce any confusion of locations.

To set the node address:

- Use a small straight-bladed screwdriver to rotate the switches. Line up the small arrowhead on the switch with the number you want to select.

The following figure shows that the address is set at **01**; the MSD rotary switch is set at **0** and the LSD rotary switch is set at **1**.

Figure 5: ArmorBlock Address Node Rotary Switches

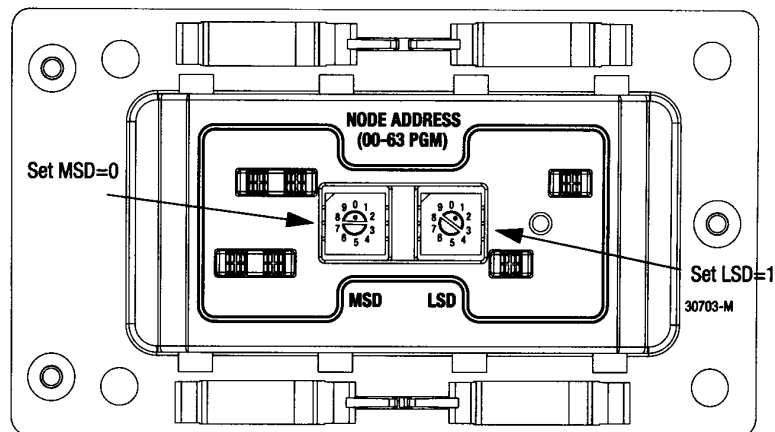

Installing ArmorBlocks

The ArmorBlock cable base should already be attached to the mounting plate, aligned so it is **perpendicular** to the flat cables. If not, reinstall it with its proper alignment.

To install the flat cables in the ArmorBlock cable base:

1. Lay the flat cable into the ArmorBlock cable base, grey data cable on the bottom and the black power cable on the top, making sure that the keyed edge is properly seated toward the top.

Caution! *EXERCISE CARE when handling the seal block.*

Cable contacts are SHARP!

Only ONE attempt to pierce the cable is allowed for proper contact.

Figure 6: Using seal block to pierce cable

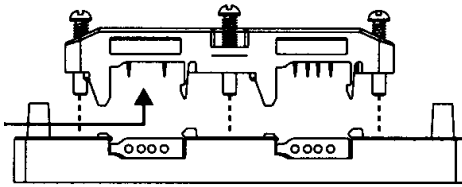

2. Align the seal block so the L-shaped tabs are towards the top, and the arrows are matched on the bottom of the cable base and seal block. Make sure that the arrows and the four captive screws on the seal block are properly aligned. ***Gently press it into place.***

Make sure that you align the seal block properly when you attach it to the base. Doing so maintains the integrity of the sealed base.

Note: *You can only pierce the cable once. Once pierced, the seal block must not be removed. This insures that the inner conductors are not exposed to the elements.*

Figure 7: Securing the Seal Block to the Cable Base

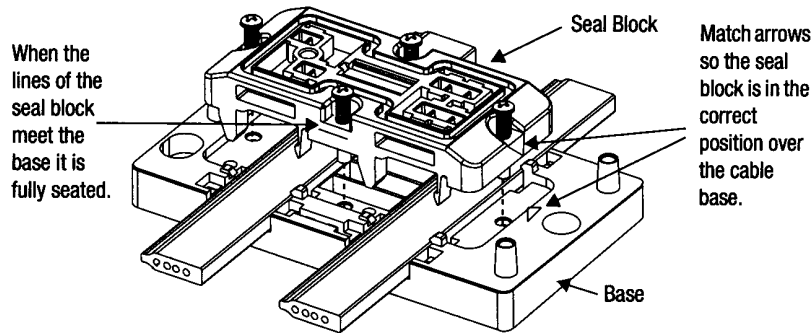

To secure the seal block:

1. Start the threads of each of the four captive screws into the cable base receptacle holes.
2. Drive each of the screws about halfway down, **using the proper torque sequence:** Bottom screw, top screw, left screw, right screw. Doing so insures that the cables are pierced evenly.
3. **Using the proper torque sequence**, tighten each screw, *a little at a time*, until the seal block is fully seated into the cable base. Tighten to no more than 8 to 10 inch-pounds (3.0 to 3.7 N•m) of torque.

The three seat lines on the seal block should meet the cable base, indicating that the seal block is fully seated. The seal block clips should also click into place onto the corresponding cable base slots.

Installing KwikLink™ Connectors

KwikLink connectors let you connect the controller and the power supply to the system. They are also used to electronically terminate power cable and data cable runs.

Just like ArmorBlocks, KwikLink connectors are *insulation displacement connectors* (IDCs).

Caution! *Exercise care when installing Kwiklink connectors.*

IDC blades on KwikLink connectors are SHARP!

Gently push back any protruding IDC blades before installing flat cables inside.

The KwikLink connector should already be attached to the mounting plate, so the **hinge side is down**. If not, reinstall it with its proper alignment, along the correct flat cable. See the installation drawing located in your Customer Information Packet for further details.

To install flat cable inside KwikLink connectors:

1. Lay the cable in the hinged base, noting the correct keyed profile; flat edge toward the hinge, keyed edge toward the latch. **Make sure that the cable is properly seated inside.**

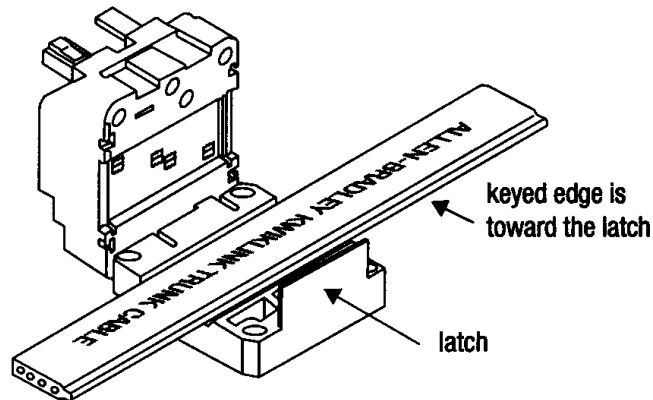

2. **Making sure that the cable is completely straight, carefully** close the hinged assembly, and apply firm, even pressure until the first latch locks into place.

Note: *Make sure that the flat cable is completely straight before continuing!*

The latch has two catches; the first loosely holds the connector on the cable, the second requires more pressure to close the connector tightly. The cable must be in the correct position for the connector to close properly.

3. Drive the two screws at the center points about halfway down; first on the latch side, then the hinge side.
4. Continue to tighten the screws a little at a time until fully tightened; no more than 15 inch-pounds (5.6 N•m) of torque.

Note: *You can only pierce the cable once. Once pierced, the KwikLink connector must not be removed. This insures that the inner conductors are not exposed to the elements.*

Connecting the Controller to the Network

To connect the controller to the network, make sure that the KwikLink connector is properly installed on the flat grey data cable. To connect:

1. Attach the keyed round connector to the terminal of the controller marked **NETWORK NO. 1**. Tighten the cord grip ring until snug.
2. Align the square connector of the grey drop cable so the cable leads down from the connector. Evenly press the square connector onto the top of the KwikLink connector. It should make two audible snaps when properly seated.
3. Dress the excess cable with cable ties so it does not interfere with operation and gives a pleasing appearance.

Connecting the Remote Interface to the Main Controller

After selecting a location and installing the remote interface, connect it to the main controller:

1. Determine the length of blue remote cable you need, and cut it to length.
2. Run the cable from the remote interface to the main controller, neatly dressing the cable with cable ties so it does not interfere with system operation and to give it a neat appearance.
3. Attach connectors at each end, following the connector manufacturer's instructions.
4. Attach one connector to the remote interface terminal marked **REMOTE DISPLAY**. Tighten the cord grip ring until snug.
5. Attach the other connector to the terminal of the controller marked **REMOTE DISPLAY**. Tighten the cord grip ring until snug.

Figure 8: Proper Controller and Remote Interface Connections

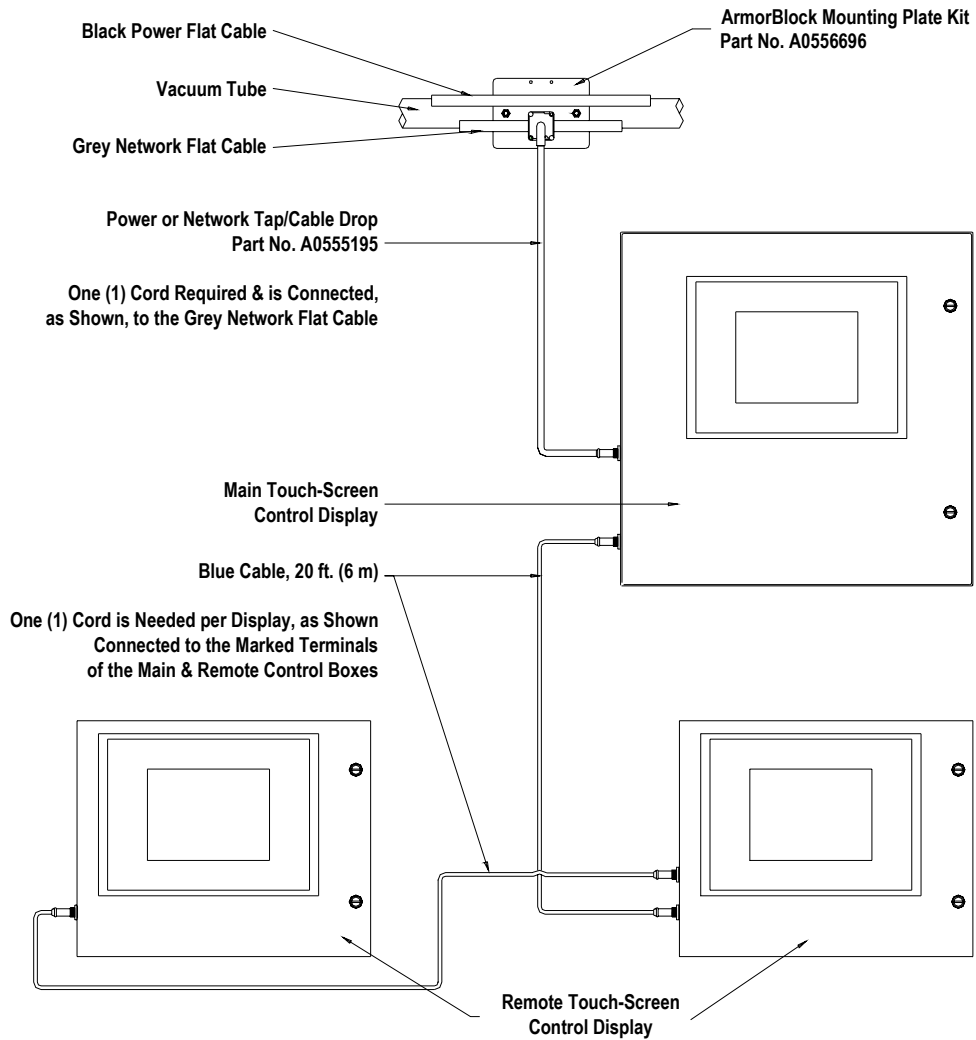

Connecting the Power Supply Enclosure to the Network

The power supply provides electrical power to make the system work. Some network layouts require more than one power supply.

Location is also an important consideration when locating power supply enclosures on your network. Contact the factory for determining how many power supply enclosures your system needs, as well as where they need to be installed.

After you've mounted the power supply enclosure(s), you can connect them to your network. To connect a power supply to the network:

1. Attach a KwikLink connector included in the bag with power cables to the flat cables. One connector is used for the network grey cable and one connector is used for the auxiliary power black cable.
2. Align the square connector of the grey drop cable so the cable leads down from the connector. Evenly press the square connector onto the top of the **bottom** KwikLink connector. It should make two audible snaps when properly seated.
3. Align the square connector of the black drop cable so the cable leads down from the connector. Evenly press the square connector onto the top of the **upper** KwikLink connector. It should make two separate, audible snaps when properly seated.
4. Attach the keyed round connectors to the receptacles on the side of the power supply enclosure marked **24 VDC POWER SUPPLY**. Tighten the cord grip ring until snug.
5. Dress the excess cables with cable ties so they do not interfere with operation and to give a pleasing appearance.

If more than one power supply is required to properly energize the grey network flat cable:

1. Remove the terminal block jumpers on all but the most centrally-located network power supply enclosures.

For locations of jumpers, refer to the drawing shipped inside the power supply enclosure

Note: *Only one power supply should be connected to each section of the black auxiliary power flat cable. Do not remove any jumpers on power supplies that transmit energy to the black flat power cable.*

Figure 9: Proper Power Supply Enclosure Connections

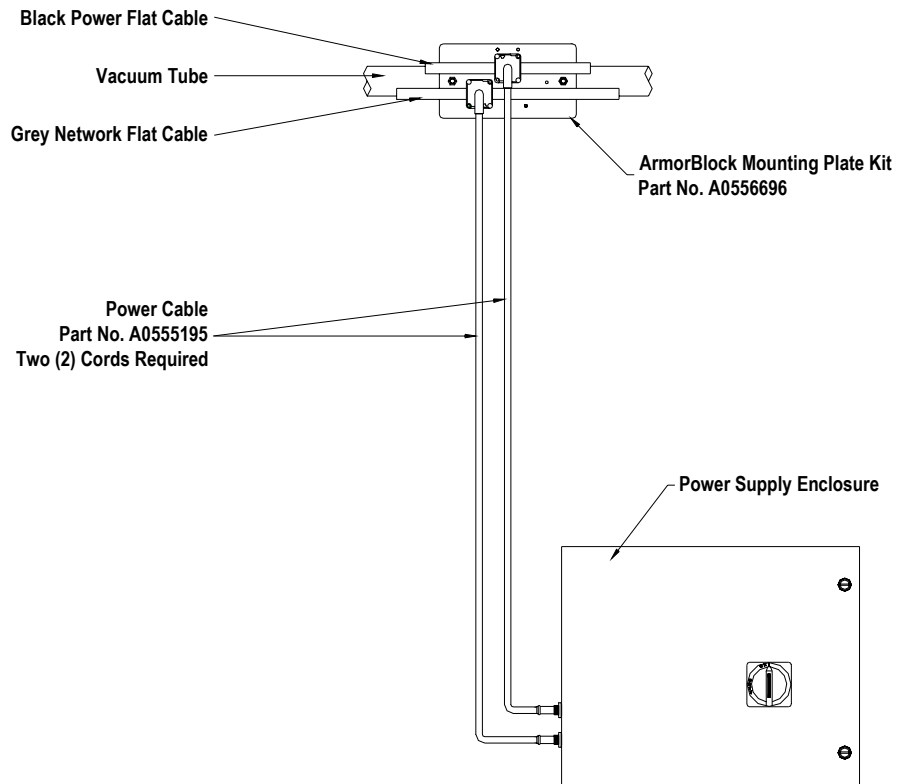

Connecting Vacuum Receivers to the Network

Make sure that all previous installation steps have been done first before starting this task.

To connect a vacuum receiver to the network:

1. Attach one connector of the yellow patch cord to the terminal on the vacuum receiver terminal box. Tighten the cord grip ring until snug.
2. Attach the other connector to the **upper left** terminal of the ArmorBlock. Tighten the cord grip ring until snug.

Note: *Retain the terminal caps from the ArmorBlock. They may be used later.*

***** The installation steps listed above also apply to the 7/50D 4-connector ArmorBlock.**

Note the following illustrations for 4 and 8-connector ArmorBlocks:

Figure 10: 7/50D 4-Connector ArmorBlock Connections

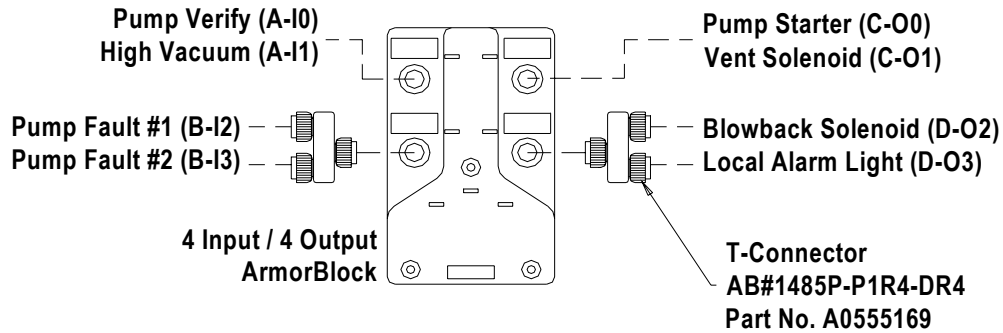

3. Dress the excess patch cord cable with cable ties so it does not interfere with operation and gives a pleasing appearance.

Figure 11: 7/50D Plus 8-Connector ArmorBlock Connections

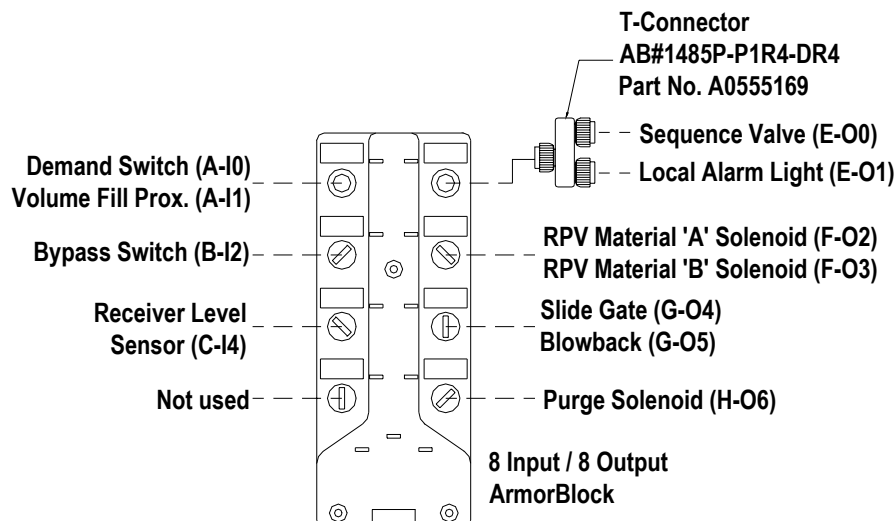

3. Dress the excess patch cord cable with cable ties so it does not interfere with operation and to give a pleasing appearance.

Figure 12: Proper Vacuum Receiver Connections

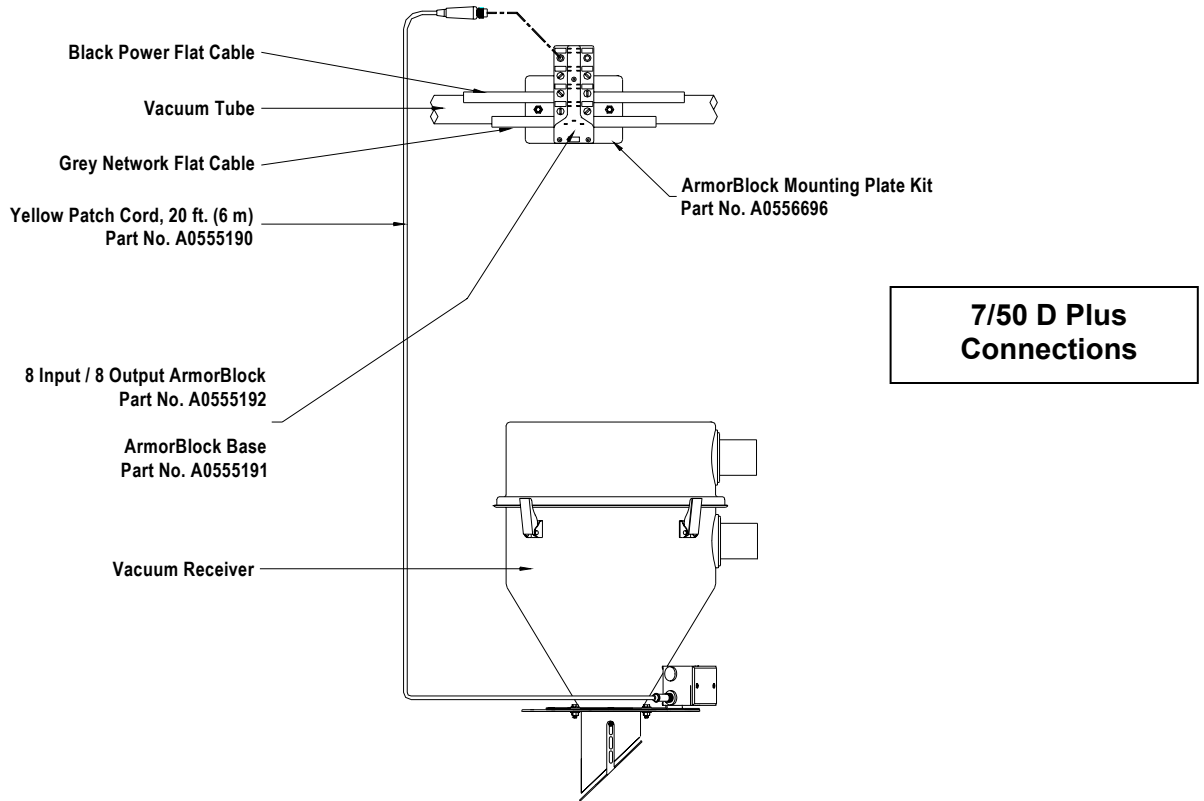

OR

Make the same connections using a 4 input/ 4 output ARMORBLOCK

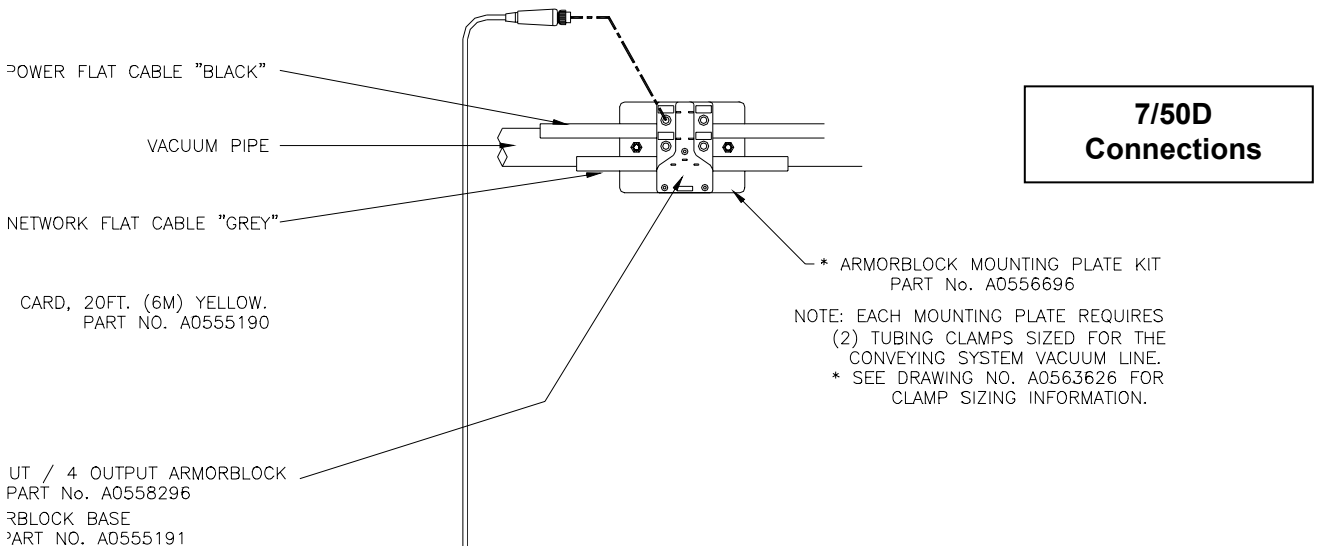

Connecting Vacuum Pumps and Filter Chambers to the Network

Connecting Vacuum Pumps

Make sure that all previous installation steps have been done first before starting this task. You'll use two yellow patch cords to connect.

To connect a vacuum pump to the network:

1. Attach one connector of the first yellow patch cord to the lower terminal on the vacuum pump terminal box. Tighten the cord grip ring until snug.
2. Attach the other connector to the **upper left** terminal of the ArmorBlock. Tighten the cord grip ring until snug.
3. Attach one connector of a yellow patch cord to the upper terminal on the vacuum pump terminal box. Tighten the cord grip ring until snug.
4. Attach the other connector to the **upper right** terminal of the ArmorBlock. Tighten the cord grip ring until snug.

Note: *Retain the terminal caps from the ArmorBlock. They may be used later.*

Note the following illustration for 4-connector ArmorBlocks:

Figure 13: 4-Connector ArmorBlock Connections

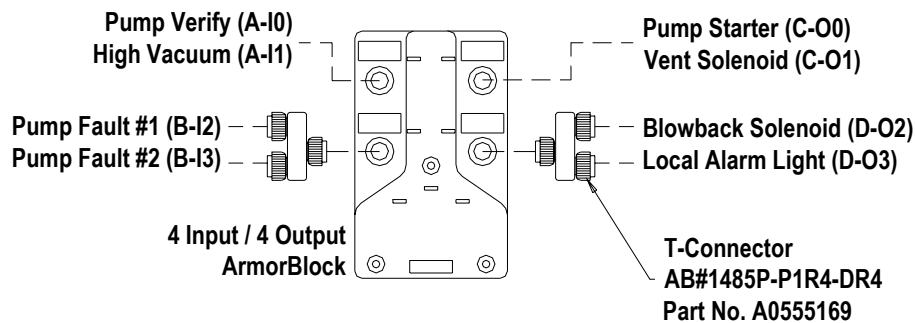

5. Dress the excess patch cord cables with cable ties so they do not interfere with operation and to give a pleasing appearance.

Figure 14: Proper Vacuum Pump Connections

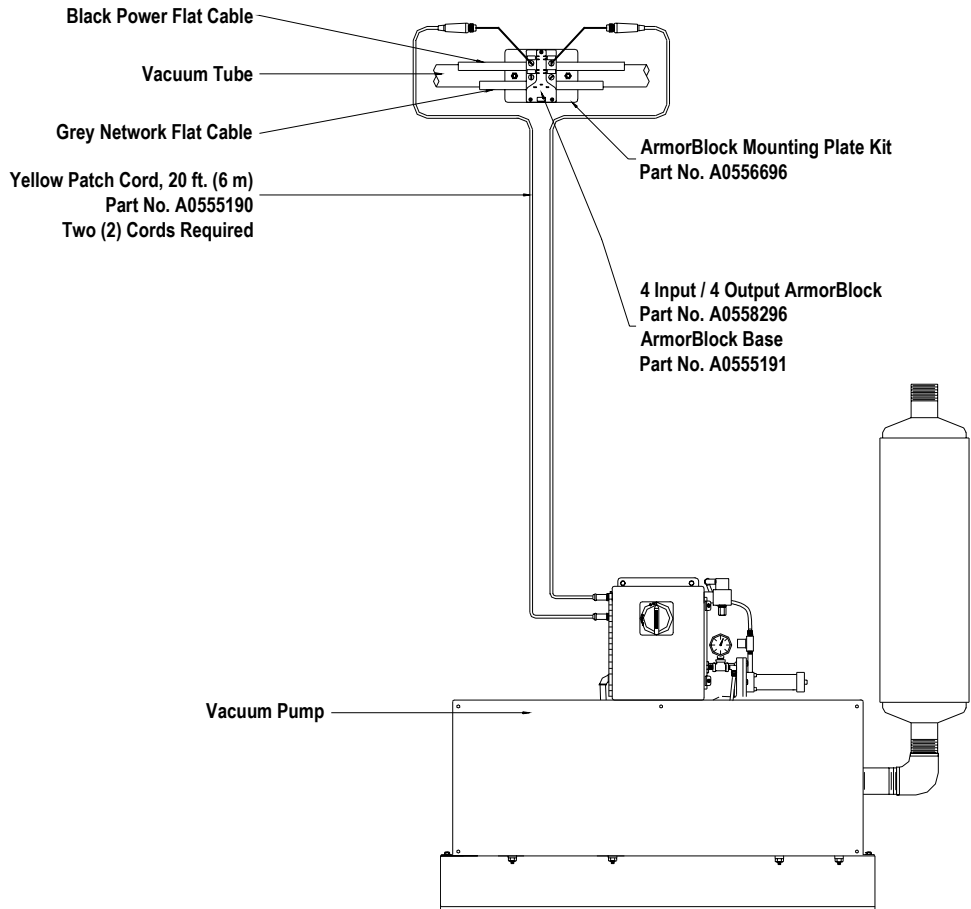

Connecting Filter Chambers

Make sure that all previous installation steps have been done first before starting this task. You'll use one yellow patch cord to connect.

To connect a filter chamber to the network:

1. Attach one connector of the yellow patch cord to the terminal on the filter chamber terminal box. Tighten the cord grip ring until snug.

Figure 15: Proper Filter Chamber Connections

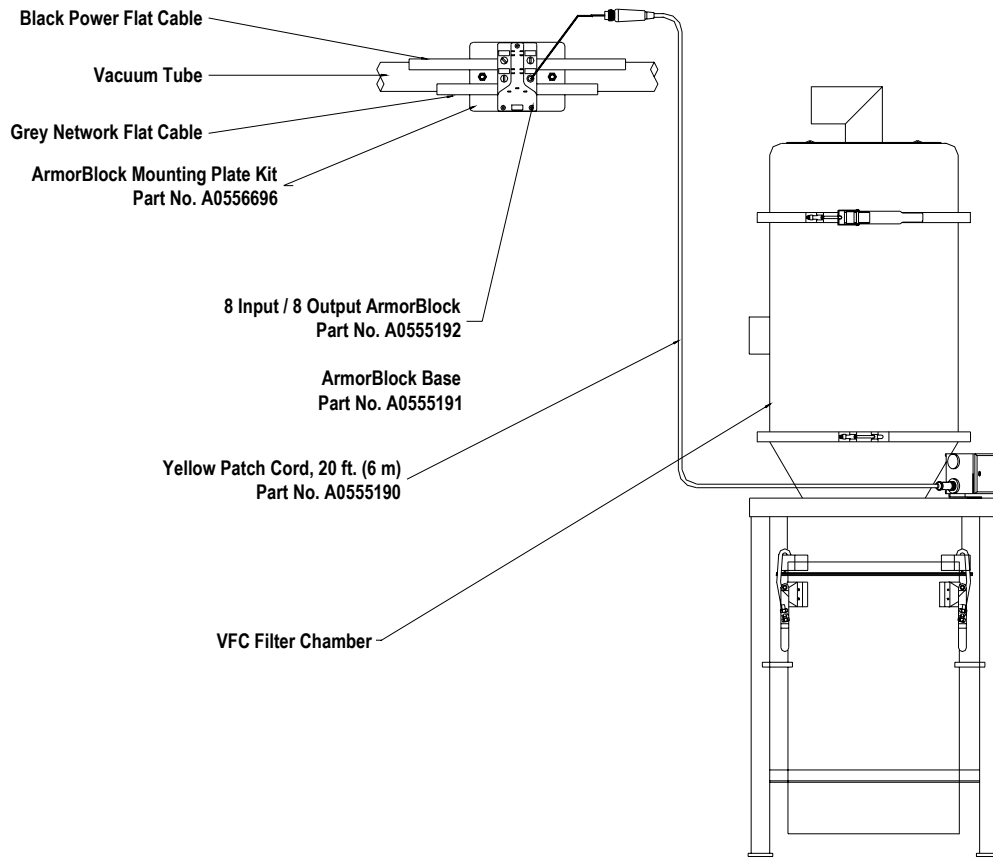

2. Attach the other connector to the **lower right** terminal of the ArmorBlock you used to connect the vacuum pump. Tighten the cord grip ring until snug.

Note: *Retain the terminal caps from the ArmorBlock. They may be used later.*

3. Dress the excess patch cord cables with cable ties so they do not interfere with operation and to give a pleasing appearance.

Connecting Central Alarms to the Network

Make sure that all previous installation steps have been done first before starting this task. First, **determine where the best location for central alarms should be**, and install the alarm module(s) there. You'll use two yellow patch cords to connect.

To connect an alarm module to the network:

1. Attach one connector of the first yellow patch cord to the terminal on the alarm module. Tighten the cord grip ring until snug.
2. Attach the other connector to the **upper right** terminal of the ArmorBlock. Tighten the cord grip ring until snug.

Figure 16: Proper Central Alarm Connections

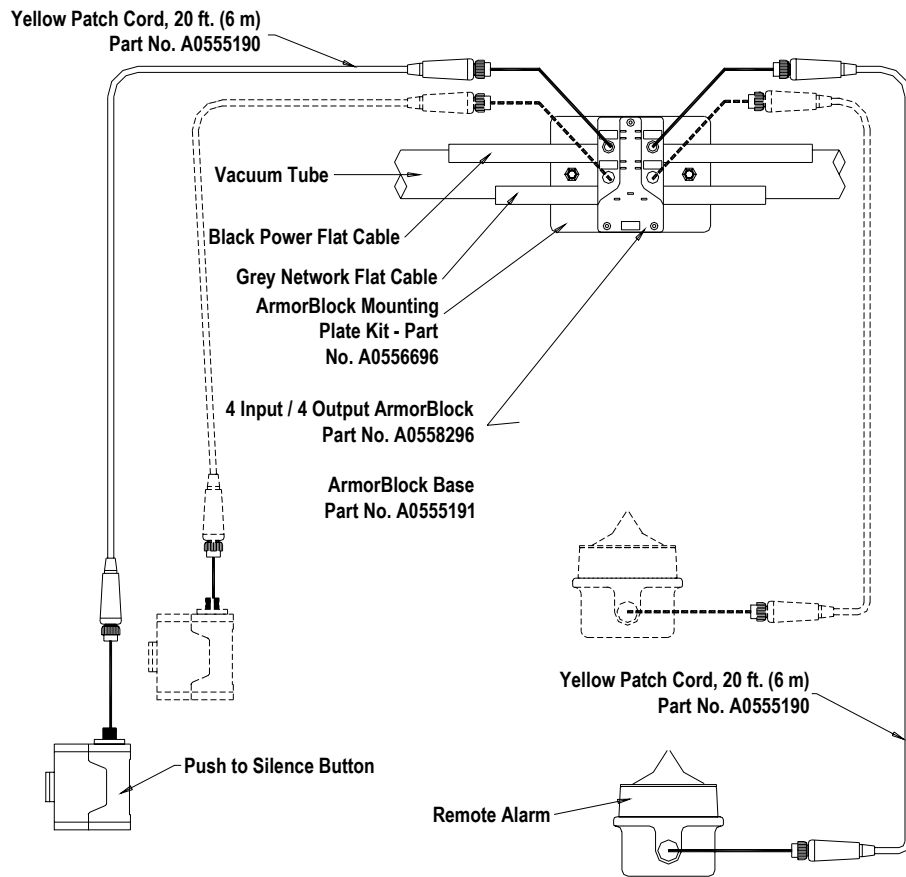

3. Attach one connector of a yellow patch cord to the terminal on the alarm silence switch module. Tighten the cord grip ring until snug.

- Attach the other connector to the **upper left** terminal of the ArmorBlock. Tighten the cord grip ring until snug.

Note: *Retain the terminal caps from the ArmorBlock. They may be used later.*

Note the following illustration for 4-connector central alarm ArmorBlocks:

Figure 17: 4-Connector ArmorBlock Connections for Central Alarms

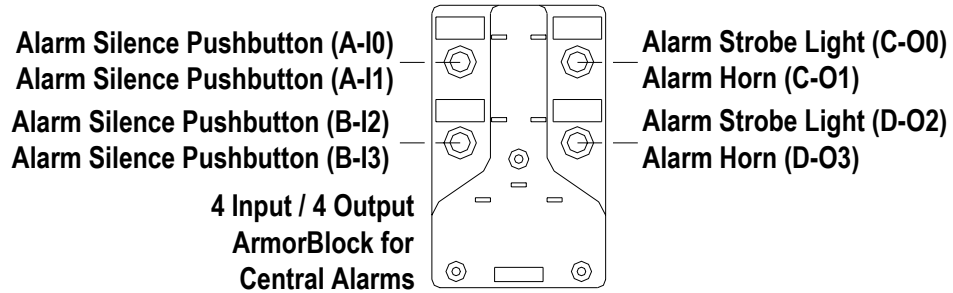

- Dress the excess patch cord cables with cable ties so they do not interfere with operation and to give a pleasing appearance.

3-5 Setup

This section provides the procedures for configuring your 7/50D Plus or 7/50D controller. Configuration of your controller includes setting the number of stations and pumps, setting variables such as convey time and blow-back interval, and setting up passwords. We recommend that you carry out these procedures in the order given here.

Note: *Before carrying out these procedures, install all equipment as described in this section and in the **Mechanical Components manual**.*

Figure 18 below gives an overview of the basic flow between the menus used in setting up the system.

Figure 18: Basic Menu Flow for Setup

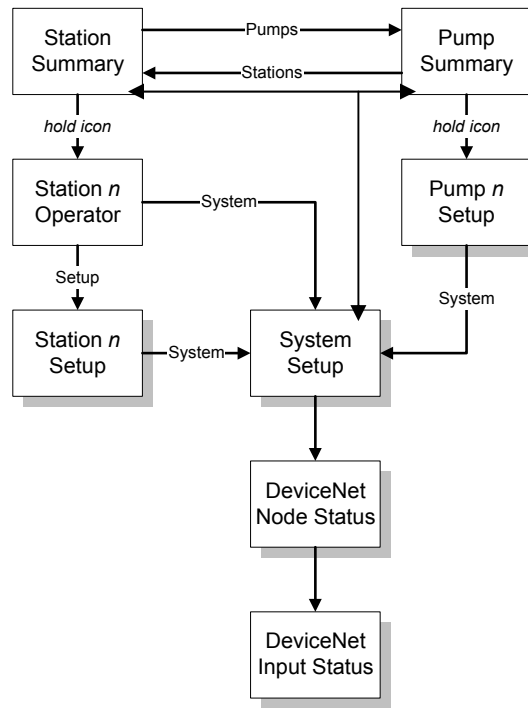

Setting Up the System

Setting the Number of Stations and the Number of Pumps

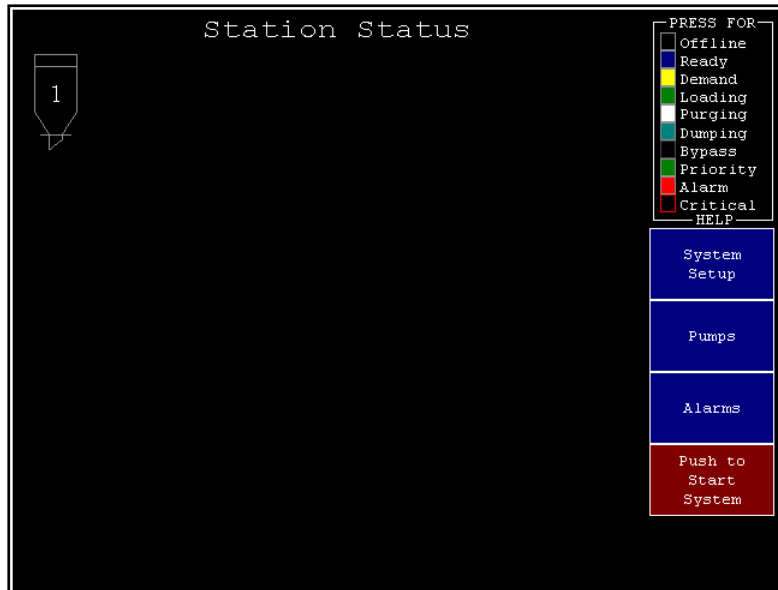

At the Station Summary screen (shown above), or at the Pump Summary screen:

1. Touch the icon for any station (or pump) and hold it for several seconds. (When the controller arrives from the factory, only one icon appears.)

A Station *n* Operator screen similar to the following appears. (If you started at the Pump Summary screen, the Pump *n* Setup screen appears instead.)

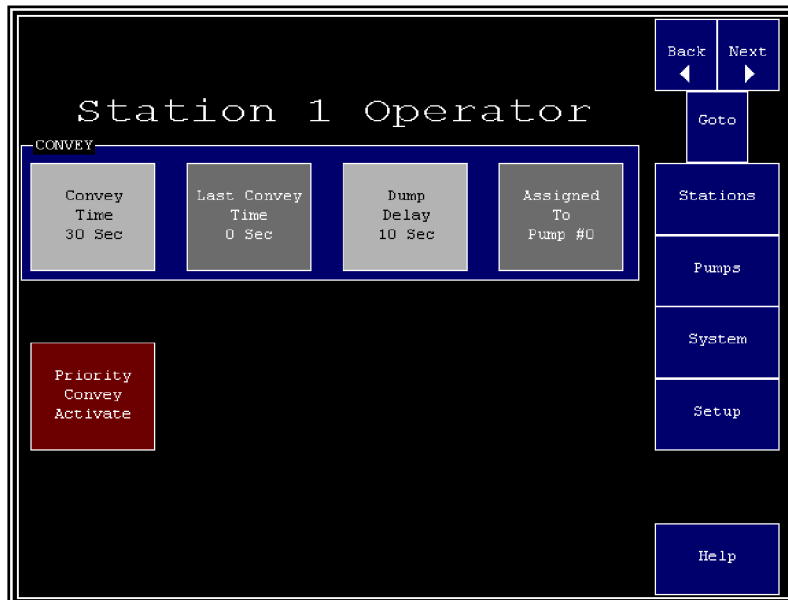

2. Touch **System** at the Station *n* Operator (or Pump *n* Setup) screen.

The System Setup screen appears:

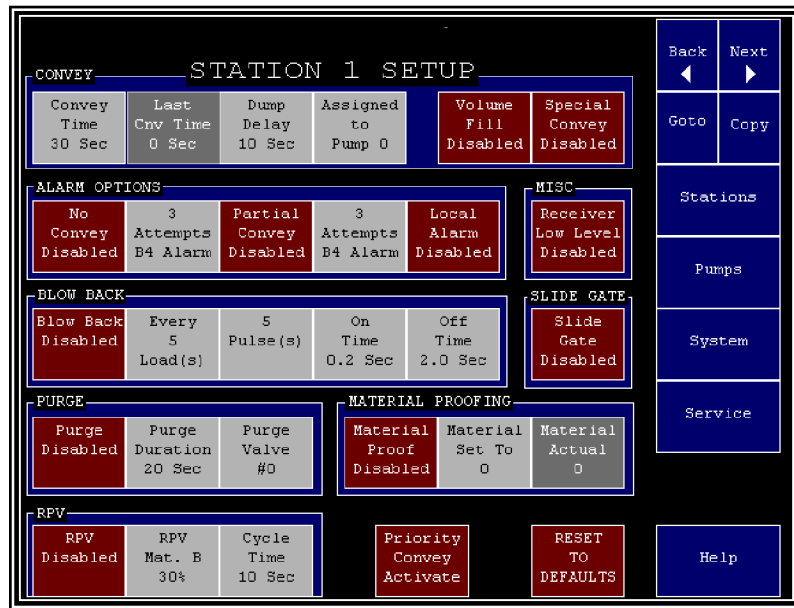

Note: Touching Help in the lower right of this screen gives you a menu of online help for the choices in this screen.

(7/50D Plus Screen shown)

Touching **Return** at the help menu brings you back to the System Setup screen.

3. Touch **Stations Present** in the upper left of the System Setup screen.
A keypad pops up.
4. Enter the total number of stations (1–50) to be controlled by this controller. Use ← to erase any mistakes. Use ↵ to enter the value.
The keypad disappears and the new setting appears under **Stations Present**.
5. Touch **Pumps Present** in the upper part of the System Setup screen.
A keypad pops up.
6. Enter the total number of pumps (1–7) to be controlled by this controller. Use ← to erase any mistakes. Use ↵ to enter the value.
7. The keypad disappears and the new setting appears under **Pumps Present**.

Checking Addressing and Wiring for System Components

Once you have set the number of stations and pumps as described previously, you should verify that the controller is communicating with all stations, pumps, and central alarms, and with the ArmorBlocks for all central purge valves. To do so:

1. At the System Setup screen, touch **DeviceNet Node Status** near the lower right of the screen.

The DeviceNet Node Status screen appears:

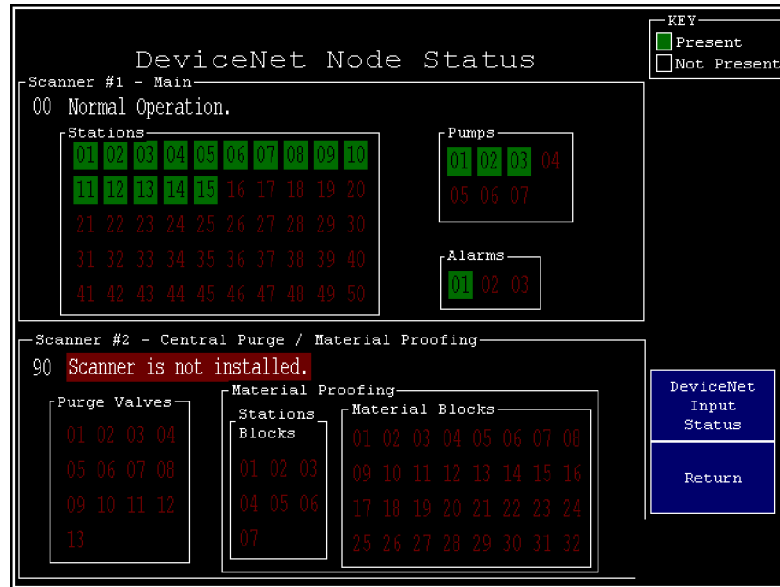

2. Check that the expected components are shown as present (green) and not present (black). (Disregard any error messages.)

For example, if you have 18 stations, boxes **01** through **18** in the **Stations** section should be green and boxes **19** through **50** should be black. For central purge valves, you should see a green box for each ArmorBlock installed.

If the screen display is not as expected, either a component's ArmorBlock has an incorrect address or the ArmorBlock is not correctly wired to the network.

When you have verified that the controller is communicating with the other system components, you should verify that the inputs on all ArmorBlocks for stations and pumps are wired correctly and are working correctly. To do so:

1. At the DeviceNet Node Status screen, touch **DeviceNet Input Status** near the lower right of the screen.

The DeviceNet Input Status screen appears:

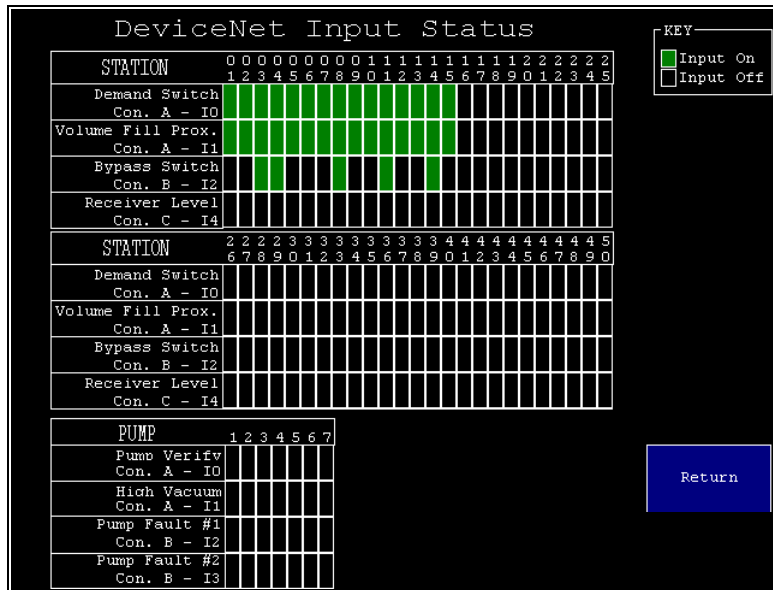

Station numbers are stacked vertically as column headings in this screen.

2. Check that all inputs are on (green) or off (black) as expected and that they switch on and off as required:
 - a. **Station demand switch:** In a new installation, the box labeled **Demand Switch** should be green for every station (vacuum hopper) in the system. (All other boxes for demand switches will be black.) In a retrofit at an existing installation, each station's **Demand Switch** box should be green *unless* the receiver bin under the station is in fact full.
 - b. **Station volume-fill proximity switch:** For each time-fill station, the box labeled **Volume Fill Prox** should be black; no further check is needed for these stations. For each volume-fill station, you should calibrate the sensor now and, at the same time, check this input. To calibrate the sensor, remove the station's cover, extract the volume-fill proximity switch, and place the switch in a container of the material that you will be using at this station. Adjust the sensor according to the procedure given in the manufacturer's documentation for the switch. While you are doing this, check that:
 1. The box on this screen is green when the sensor indicates that *no* material is present, and
 2. The box is black when the sensor indicates that material is present.

Then reinstall the switch in the station.

- c. **Station bypass switch:** For every station, the box labeled **Bypass Switch** should match the state of the switch at the station. Flip the switches at the stations in order to check that:
1. Each station's box is black when its bypass switch is in the "0" position (station ready to convey), and
 2. Each station's box is green when its bypass switch is in the "1" position (station bypassed).

Leave each station with its bypass switch off (in the "0" position).

- d. **Station receiver level:** For each station whose receiver has no low-level switch, the box labeled **Receiver Level** should be black; no further check is needed for these stations. For each station whose receiver has a low-level switch, you should calibrate the sensor now and, at the same time, check this input. To calibrate the sensor, remove the receiver's cover, extract the low-level switch, and place the switch in a container of the material that you will be using at this station. Adjust the sensor according to the procedure given in the manufacturer's documentation for the switch. While you are doing this, check that:
1. The box on this screen is green when the sensor indicates that *no* material is present, and
 2. The box is black when the sensor indicates that material is present.

Note: *You will not see any alarms for "receiver low level" during this procedure. In order to prevent nuisance alarms when the system starts, the controller's software is designed to issue these alarms only after material has been detected in the receiver at least once.*

When you have finished calibration and checking, reinstall the switch in the receiver.

- e. **Pump inputs (verify, high vacuum, fault #1, fault #2):** All boxes for pump inputs should be black. Because these inputs can turn on only when the pump is running, it is not possible to check their operation further at this point.

If any input does not operate as expected, check the wiring on the ArmorBlock. If this does not solve the problem, phone the Service Department for assistance.

Setting Up Alarm Silences

When an alarm occurs, a horn sounds and a strobe light flashes at each installed central alarm. The lower right corner of the controller's screen turns into a button labeled **Alarm Silence**. Touching this button silences the horn(s) and turns off the light(s) for configurable periods of time. You can set different lengths of time for keeping the horn silent and keeping the light turned off. If a new alarm occurs, the horn sounds and the light turns on again.

To set the lengths of time for suppressing the alarm strobe and horn:

1. Go to the System Setup screen.

To reach this screen from the DeviceNet Input Status or DeviceNet Node Status screen, touch **Return** until the System Setup screen appears.

To reach this screen from the Station Summary or Pump Summary screen, touch and hold the icon for any station or pump, until the Station *n* Operator or Pump *n* Setup screen appears. Then touch **System**. The System Setup screen appears:

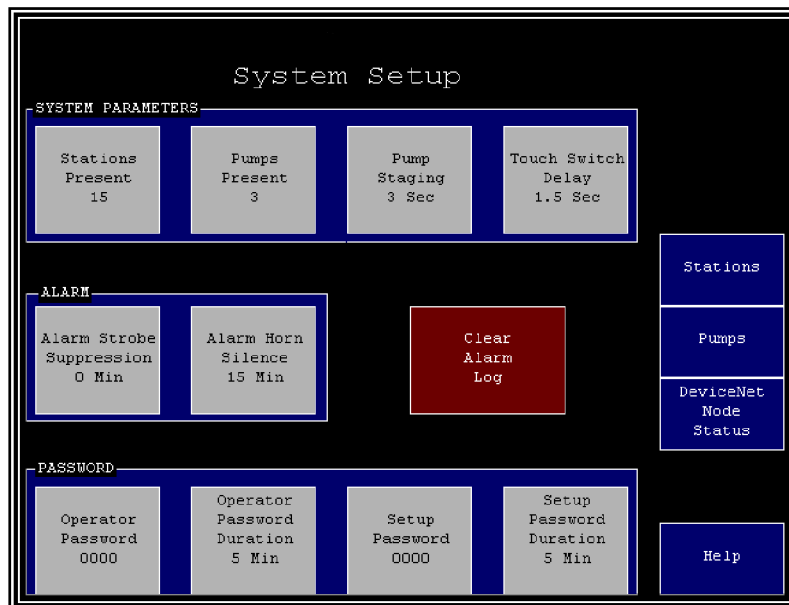

The current settings are displayed under **Alarm Strobe Suppression** and **Alarm Horn Silence**.

2. Touch Alarm Strobe Suppression or Alarm Horn Silence, as appropriate.
A keypad pops up, with an entry of 0.
3. Enter the number of minutes (range: 0–99). If you want the light (or the horn) to stay on as long as the alarm persists, simply leave its entry at 0. If you want the horn (or the light) to stay off until a new alarm occurs, use 99 for its entry. Use ← to erase any mistakes. Use ↵ to enter the value.

The keypad disappears and the new setting appears under **Alarm Strobe Suppression** or **Alarm Horn Silence**.

4. Repeat for the other device (strobe or horn) as appropriate.

Setting Up Pump Staging

To avoid an excessive power demand at your facility when the conveying system starts up, you can stagger the times at which pumps start. Whenever a demand would cause two pumps to start simultaneously, your choice for pump staging sets the delay between the start of one pump and the start of the next. The factory default is a delay of three seconds. You need to change this setting only if this delay is too long or too short for your facility.

To set the delay between the start of one pump and the next:

1. Go to the System Setup screen if needed.

To reach this screen from the Station Summary or Pump Summary screen, touch and hold the icon for any station or pump, until the Station *n* Operator or Pump *n* Setup screen appears. Then touch **System**. The System Setup screen appears.

The current delay is displayed under **Pump Staging**.

2. Touch Pump Staging.

A keypad pops up, with an entry of 0.

3. Enter the number of seconds (range: 1–99). Use ← to erase any mistakes. Use ↵ to enter the value.

The keypad disappears and the new setting appears under **Pump Staging**.

Setting Up Touch Switch Delay

During operation, the controller normally displays the Station Summary screen or the Pump Summary screen, showing the current status of all stations or pumps. Briefly touching the icon for a station or pump toggles between taking it offline (disabling it) and putting it online (enabling it). Touching the icon and holding it takes the user into the controller's menu system. The setting for touch switch delay determines how long the user must keep an icon touched before a menu appears. The factory default is 1.5 seconds. You need to change this setting only if you find that users are having difficulty with the current setting.

To change the touch switch delay:

1. Go to the System Setup screen if needed.

To reach this screen from the Station Summary or Pump Summary screen, touch and hold the icon for any station or pump, until the Station *n* Operator or Pump *n* Setup screen appears. Then touch **System**. The System Setup screen appears.

The current delay is displayed under **Touch Switch Delay**.

2. Touch Touch Switch Delay.

A keypad pops up, with an entry of 0.

3. Enter the number of seconds (range: 0.0–99.0). As with many ATM machines, the first digit you enter initially appears to the right of the decimal point and moves to the left as you enter more digits. You do not need to use the decimal point. Use ← to erase any mistakes. Use ↵ to enter the value.

The keypad disappears and the new setting appears under **Touch Switch Delay**.

Setting Up Stations

Before starting the system, you must define several settings for each station, such as which pump conveys material to it and whether the station has a slide gate. This section first discusses how to use the controller's menu system to configure stations. The table on pp. 73–77 discusses the individual choices.

Setting Up a Single Station

1. Go to the Station Summary screen if needed.

To reach this screen from any other screen, touch **Stations** on the right-hand side of the screen. The Station Summary screen appears:

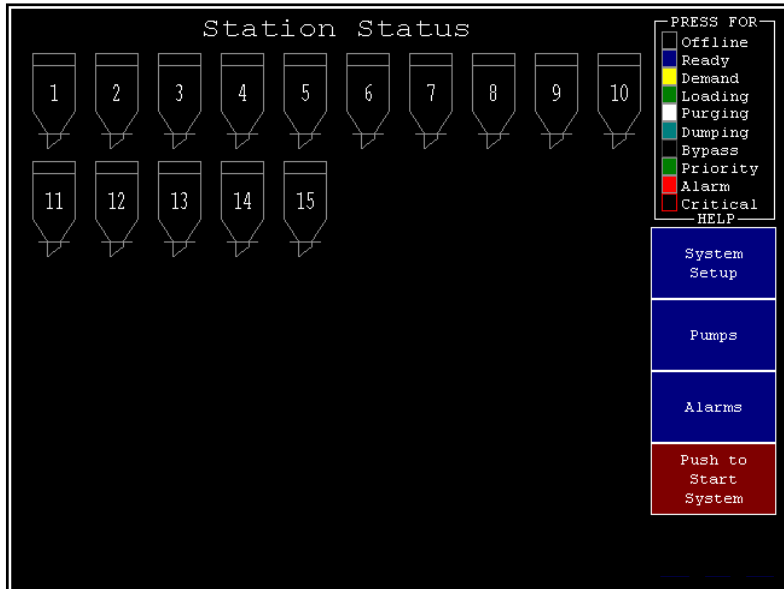

2. Touch the icon for the station you want to set up, and hold it for several seconds.

The Station *n* Operator screen for the selected station appears:

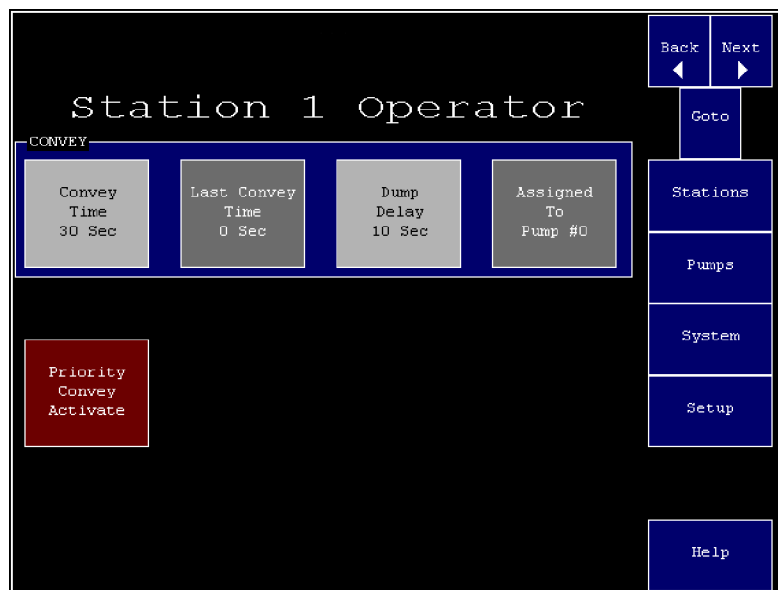

3. Touch **Setup** at the Station *n* Operator screen.

The Station *n* Setup screen appears:

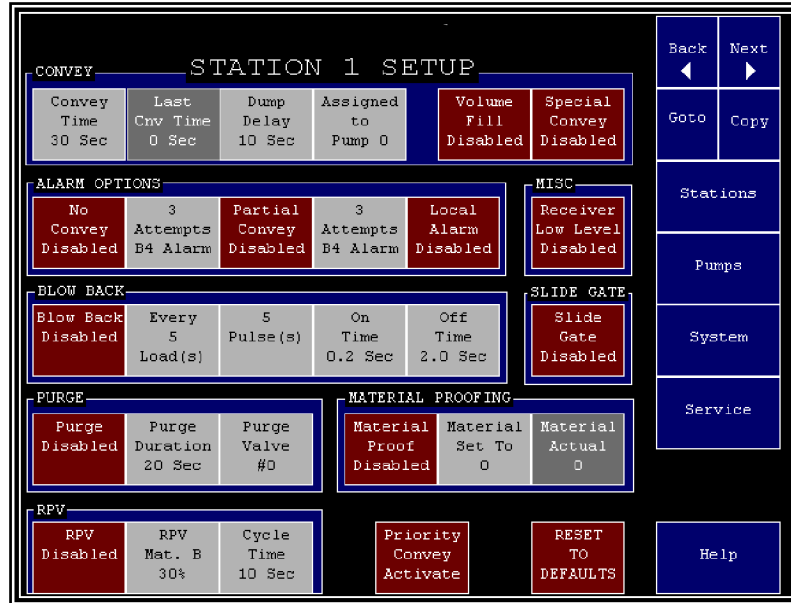

(7/50D Plus shown)

Note: Touching *Help* in the lower right of this screen gives you a menu of online help for the choices in this screen. Touching *Return* at the help menu brings you back to the Station *n* Setup screen.

4. Adjust settings as required. Touching any box that appears in red (for “disabled”) toggles it to green (for “enabled”), and vice versa (except that **RPV** has three settings, as described below). Touching any box that appears in light gray gives you a keypad to enter a new value.

Keypad entry works as with many ATM machines: the first digit you enter initially appears in the rightmost column and moves to the left as you enter more digits. You do not need to use the decimal point. Use ← to erase any mistakes. Use ↵ to enter the value. The keypad disappears and the Station *n* Setup screen shows the new value in the selected gray box.

Touching **RESET TO DEFAULTS** in the lower right of the screen changes all settings for this station back to their factory defaults.

See pp. 73–77 for details on the options and their default settings.

5. As appropriate:
 - a. Copy this station's settings to one or more other stations, as described below

- or -
 - b. Touch **Back** ◀ to go to the Station $n-1$ Setup screen

- or -
 - c. Touch **Next** ▶ to go to the Station $n+1$ Setup screen

- or -
 - d. Touch **Goto** and enter a station number to go to that station's setup screen

Copying Settings from One Station to Others

If other stations at your facility will use the same settings as a station you have already set up, you can copy the settings from this station to the others. To do so:

1. At the Station n Setup screen (for the station you want to copy *from*), touch **Copy** in the screen's upper right.

The Station Copy screen appears, showing the station number for the station you are copying from:

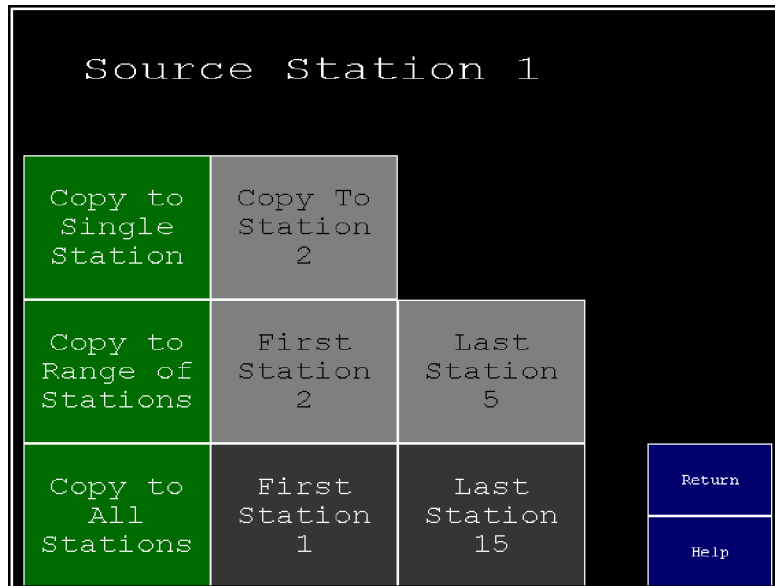

2. Follow the directions on the following pages to copy settings to one other station, a range of stations, or all stations.

To copy the selected station's settings to one other station

1. Touch the gray **Copy to Station** button next to the green button labeled **Copy To Single Station**.

The keypad pops up.

2. Enter the station number for the station you are copying to. Use ← to erase any mistakes. Use ↵ to enter the value.

The keypad disappears and the Station Copy screen shows the station number you entered under **Copy to Station**.

3. Touch the green **Copy to Single Station** button.

“**Complete**” briefly appears at the top of the screen.

4. As appropriate, either continue copying to other stations, or touch **Return** to go back to the Station *n* Setup screen.

To copy the selected station's settings to a range of other stations

1. Touch **First Station** button next to the green button labeled.

The keypad pops up.

2. Enter the station number for the hopper at the lower end of the range you are copying to. Use ← to erase any mistakes. Use ↵ to enter the value.

The keypad disappears and the Station Copy screen shows the station number you entered under **First Station**.

3. Touch **Last Station** button next to the light grey button labeled **First Station**.

The keypad pops up.

4. Enter the station number for the hopper at the upper end of the range you are copying to. Use ← to erase any mistakes. Use ↵ to enter the value.

The keypad disappears and the Station Copy screen shows the station number you entered under **Last Station**.

5. Touch the green **Copy To Range of Stations** button.

“**Complete**” briefly appears at the top of the screen.

6. As appropriate, either continue copying to other stations, or touch **Return** to go back to the Station *n* Setup screen.

To copy the current station's settings to all other stations

1. Touch the green **Copy To All Stations** button.

“**Complete**” briefly appears at the top of the screen.

2. Touch **Return** to go back to the Station *n* Setup screen.

Setting Up Pumps

Before starting the system, you must define several settings for each pump, such as how quickly to shut it down when it is not in use and whether the pump has a local alarm. This section first discusses how to use the controller's menu system to configure pumps. The table on pp. 78–79 discusses the individual choices.

Setting Up a Single Pump

1. Go to the Pump Summary screen.

To reach this screen from any other screen, touch **Pumps** on the right side of the screen. The Pump Summary screen appears:

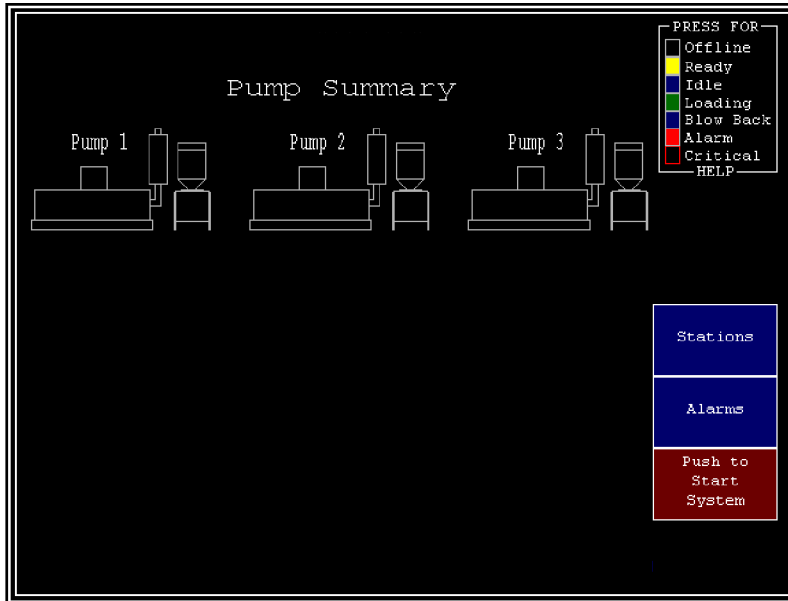

2. Touch the icon for the pump you want to set up, and hold it for several seconds.

The Pump *n* Setup screen appears:

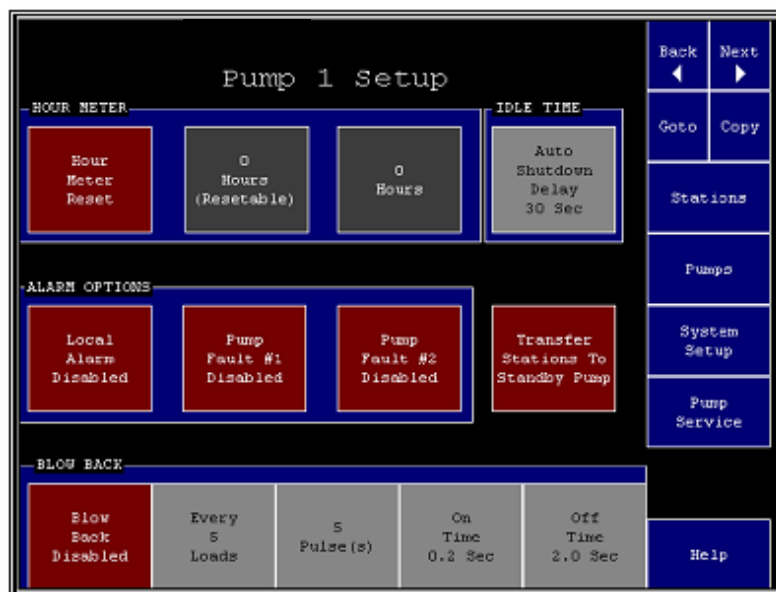

Note: *Touching Help in the lower right of this screen gives you a menu of online help for the choices in this screen. Touching Return at the help menu brings you back to the Pump n Setup screen.*

3. Adjust settings as required. Touching any box that appears in red (for “disabled”) toggles it to green (for “enabled”), and vice versa. Touching any box that appears in light gray gives you a keypad to enter a new value.

Keypad entry works as with many ATM machines: the first digit you enter initially appears in the rightmost column and moves to the left as you enter more digits. You do not need to use the decimal point. Use ← to erase any mistakes. Use ↵ to enter the value. The keypad disappears and the Pump *n* Setup screen shows the new value in the selected gray box.

See pp. 73 –77 for details on the options and their default settings.

4. As appropriate:
 - a. Copy this pump’s settings to one or more other pumps, as described below
—*or*—
 - b. Touch **Back** ◀ to go to the Pump *n*-1 Setup screen
—*or*—
 - c. Touch **Next** ▶ to go to the Pump *n*+1 Setup screen
—*or*—
 - d. Touch **Goto** and enter a pump number to go to that pump’s setup screen

Copying Settings from One Pump to Others

If other pumps at your facility will use the same settings as a pump you have already set up, you can copy the settings from this pump to the others. To do so:

1. At the Pump n Setup screen (for the pump you want to copy *from*), touch **Copy** in the screen's upper right.

The Pump Copy screen appears, showing the pump number for the pump you are copying from:

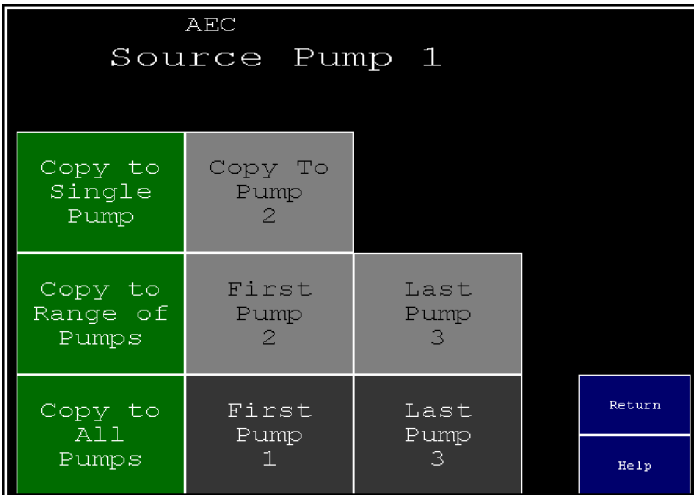

2. Follow the directions below to copy settings to one other pump, a range of pumps, or all pumps.

To copy the selected pump's settings to *one other pump*

1. Touch the gray **Copy to Pump** button next to the green **Copy To Single Pump** button.

The keypad pops up.

2. Enter the pump number for the pump you are copying to. Use ← to erase any mistakes. Use ↵ to enter the value.

The keypad disappears and the Pump Copy screen shows the pump number you entered under **Copy to Pump**.

3. Touch the green **Copy To Single Pump** button.

"**Complete**" briefly appears at the top of the screen.

4. As appropriate, either continue copying to other pumps, or touch **Return** to go back to the Pump n Setup screen.

To copy the selected pump's settings to a *range* of other pumps

1. Touch **First Pump** next to the green button labeled **Copy To Range of Pumps** button.

The keypad pops up.

2. Enter the number for the pump at the lower end of the range you are copying to. Use ← to erase any mistakes. Use ↵ to enter the value.

The keypad disappears and the Pump Copy screen shows the pump number you entered under **First Pump**.

3. Touch **Last Pump** next to the light grey button labeled **First Pump**.

The keypad pops up.

4. Enter the number for the pump at the upper end of the range you are copying to. Use ← to erase any mistakes. Use ↵ to enter the value.

The keypad disappears and the Pump Copy screen shows the pump number you entered under **Last Pump**.

5. Touch the green **Copy** button labeled **Copy To Range of Pumps**.

“**Complete**” briefly appears at the top of the screen.

6. As appropriate, either continue copying to other pumps, or touch **Return** to go back to the Pump *n* Setup screen.

To copy the current pump's settings to *all* other pumps

1. Touch the green **Copy To All Pumps** button.

“**Complete**” briefly appears at the top of the screen.

2. Touch **Return** to go back to the Pump *n* Setup screen.

Finishing Setup: Setting Up Passwords

You can set up passwords for two levels of security: for operators and for setup personnel. The controller comes from the factory with neither password set. This allows every user access to all functions.

Setup Password. If you define a password for setup personnel, then most settings can be changed only after entering the password. The password will be required to display the following screens:

- System Setup (to review and change system-wide settings, clear the alarm log, and go to the network status screens)
- Station Setup (to review and change settings for all station options)
- Pump Setup (to review and change settings for all pump options)

Operator Password. If you define a password for operators, then a password will be required to carry out *any* function (other than reviewing station and pump status, silencing alarms, reviewing the alarm log, and looking at help screens). Entering the operator's password will give the user access to the functions at the following screens:

- Station Summary (to enable or disable a station, and start or stop system)
- Pump Summary (to enable or disable a pump, and start or stop system)
- Station *n* Operator (to adjust a station's convey time and dump delay, activate priority convey, and review the station's last convey time and pump assignment; depending on the options installed, the screen may also enable the operator to adjust the mixture percentage for a remote proportioning valve, review the last purge time and purge valve, and set the intended material line for material proofing)

Entering the setup password will give the user access to all functions.

Note: *If you want to protect the operator's functions with a password, you must also define a setup password. If you leave the setup password undefined, then all users will have access to all functions.*

If you want two different levels of password protection, you must make the passwords different from each other. If the two passwords are the same as each other, then any user who enters the password will have access to all functions.

To set (or remove) password protections:

1. Go to the System Setup screen if needed.

To reach this screen from the Station Summary or Pump Summary screen, touch and hold the icon for any station or pump, until the Station *n* Operator or Pump *n* Setup screen appears. Then touch **System**.

The System Setup screen appears:

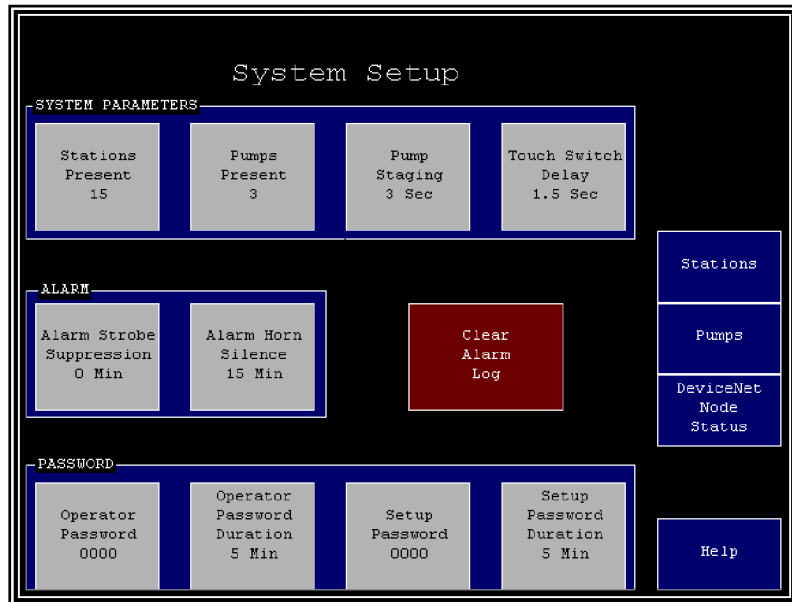

The current passwords are displayed under **Operator Password** and **Setup Password**. A value of **0000** means that no password is required.

2. Touch Operator Password or Setup Password, as appropriate.
A keypad pops up, with an entry of 0.
3. Enter up to four digits. If you want to remove the password protection, simply leave the entry at 0. Use ← to erase any mistakes. Use ↵ to enter the value.

The keypad disappears and the new setting appears under **Operator** (or **Setup**) **Password**. In addition, if you have added a password, a new button appears on the screen, labeled **Log Off Operator** and/or **...Setup**, depending which passwords are now active.

Note: *When entering a password, all four digits must be supplied. For example, if you enter a password of 2 here, you will need to enter 0002 when the controller prompts for the password.*

If desired, you can also change the duration for which a password remains effective. During operation, the password-protected screens are available either until the user logs off or until this time elapses, whichever comes first. This feature prevents the password from remaining active if a user forgets to log off.

Note: *The password timer starts when the user logs on. It expires even if the user is actively using the screens when the chosen time is up. If the timer expires, the system goes to the Station Summary screen. Your password duration should be long enough to allow authorized users to complete their tasks but short enough to provide adequate protection against tampering.*

To change the duration of a password:

1. At the System Setup screen, touch **Operator Password Duration** or **Setup Password Duration**, as appropriate.

A keypad pops up, with an entry of 0.

2. Enter the number of minutes (range: 5–99). Use ← to erase any mistakes. Use ↵ to enter the value.

The keypad disappears and the new setting appears under **Operator** (or **Setup**) **Password Duration**.

3-6 Initial Startup

Once you have finished all the setup described above, you are ready to start the system. To do so:

1. At any screen, touch **Stations** on the right-hand side of the screen.

The Station Summary screen appears.

2. For each station that you want to use, briefly touch its icon.

The icon turns blue, indicating that the station is ready or yellow, indicating that the station needs material.

3. Touch **Pumps**.

The Pump Summary screen appears.

4. For each pump that you want to use, briefly touch its icon.

The icon turns blue, indicating that the pump is ready.

5. Touch **Push to Start System** in the lower right-hand corner of the screen.

The system starts. If any alarm messages appear on the top of the screen, see p. 71.

Chapter 4: Operation

4-1 Overview

Your 7/50D Plus or 7/50D controller electrically controls valves and solenoids to convey material from a central location to individual stations as needed. The controller senses demands for material at the stations and responds to the demands in a timely fashion.

This section gives the procedures for using your controller, and it covers tasks that can be carried out with no password or with an operator's password. The section is divided into four sub-sections:

- Starting and stopping the system
- Basic tasks: tasks normally carried out by a station operator
- Advanced tasks: tasks normally carried out by setup personnel
- Alarms: silencing and clearing alarms

Note: Before you carry out any of the procedures in this chapter, the system must be set up as described in the previous chapter.

4-2 Starting and Stopping the System

Note: In an emergency, you can use the power switch on the upper right-hand side of the controller cabinet if a password is required to stop the system and you do not know the password.

Normally, all the stations and pumps you want to use should be enabled before you start the system. When the system is stopped, icons for enabled stations are blue when full and yellow when they need material. Icons for enabled pumps are yellow. Enabling stations and pumps is described on p. 60.

A button to start and stop the system is located in the lower right of the Station Summary, Pump Summary, and Alarm Log screens. When the system is off, the button is red and reads **Push to Start System**. When the system is on, the button is green and reads **Push to Stop System**. Depending on the setup at your facility, the system may prompt for a password when you touch this button.

Note: If conveying does not begin when you start the system, check to make sure that all needed pumps are enabled. If they are, check that all needed stations are enabled.

4-3 Basic Tasks

This section covers tasks that can be carried out with no password or with an operator's password.

Reviewing Station Status

The starting point for all operations is the Station Summary screen. To reach this screen from any other screen:

1. Touch Stations.

The Station Summary screen appears:

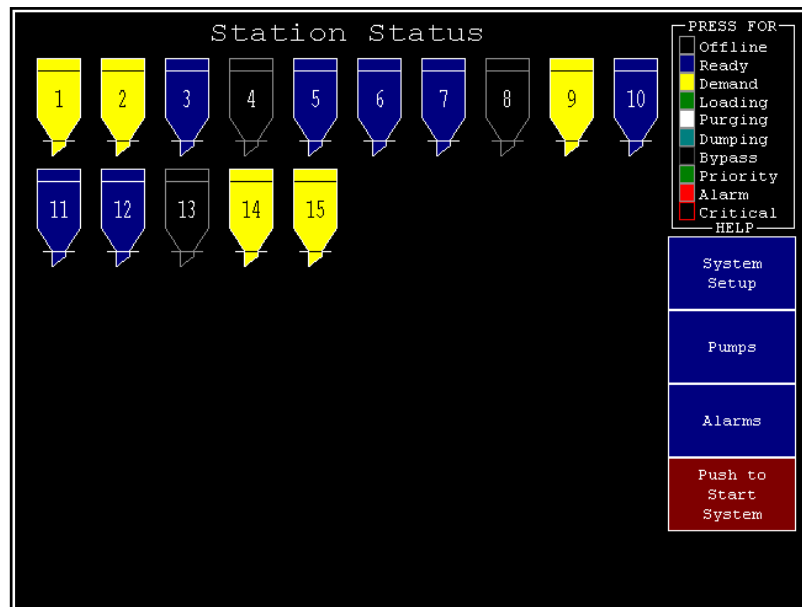

The status of each station is color-coded, as summarized in the upper right of the screen.

You can see an explanation of each status by using the online help. To do so from this screen:

1. Touch anywhere in the rectangle in the upper right of the screen.
The Help Menu appears.
2. In the section of the Help Menu labeled **Screen Symbols/Colors**, touch **Station**.
The Station Symbols help screen appears, explaining the status represented by each color.
3. When you are finished reviewing the information, touch **Return**.
The Help Menu appears.
4. At the Help Menu, touch **Stations** (or **Pumps**).
The Station Summary (or Pump Summary) screen appears.

The following table explains the status represented by each color at the Station Summary screen.

Color	Label	Description
Gray outline	Offline	Station is not enabled. The controller ignores any demands or alarms.
Blue	Ready	Station is enabled and idle (full).
Yellow	Demand	Station requires material.
Green	Loading	Station is being loaded with material or is dumping material into its receiver.
White	Purging	The material line is being purged of material.
Light Blue	Dumping	The station is dumping material into its receiver.
Blue, blinking	Blow Back	Station's air filter is being cleaned by blowing compressed air backward through it.
Black, blinking	Bypass	Bypass switch at the station has been turned on, disabling the station.
Green, blinking	Priority	Station is in priority convey mode. Its pump will be temporarily dedicated to filling it as soon as possible.
Red, blinking	Alarm	Station is in alarm.
Red outline, blinking	Critical	Station is in critical alarm. The controller has disabled the station until the alarm is cleared.

Additional basic information about each station (convey time, dump delay, pump assignment, and, if enabled, RPV setting, purge settings, and material proofing) is available at the Station *n* Operator screen. See p. 61 for details.

Detailed configuration settings for each station are available at the Station *n* Setup screen. See p. 74 for details.

Reviewing Pump Status

The Pump Summary screen is the counterpart of the Station Summary screen. To reach the Pump Summary screen from any other screen:

1. Touch **Pumps**.

The Pump Summary screen appears:

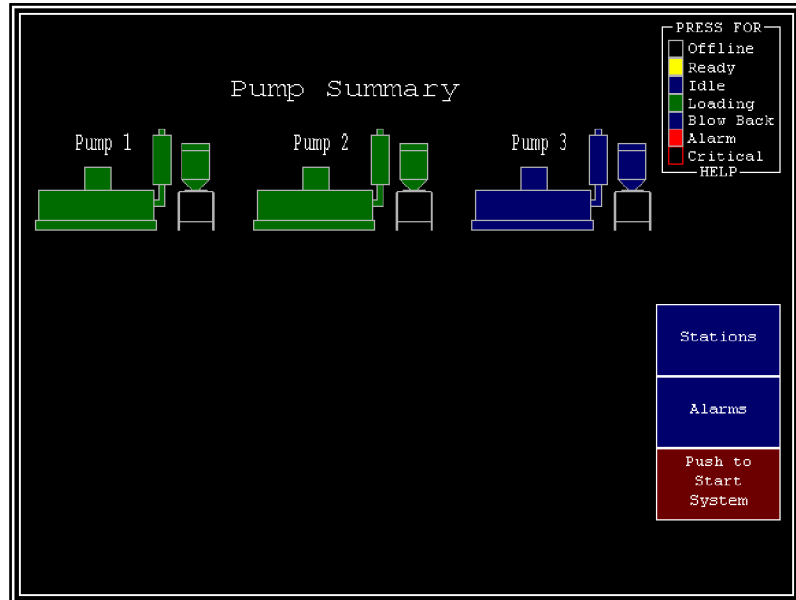

The status of each pump is color-coded, as summarized in the upper right of the screen.

You can see a more detailed explanation of each status by using the online help. To do so from this screen:

1. Touch anywhere in the rectangle in the upper right of the screen.
The Help Menu appears.
2. In the section of the Help Menu labeled **Screen Symbols/Colors**, touch **Pump**.
The Pump Symbols help screen appears, explaining the status represented by each color.
3. When you are finished reviewing the information, touch **Return**.
The Help Menu appears.
4. At the Help Menu, touch **Pumps** (or **Stations**).
The Pump Summary (or Station Summary) screen appears.

The following table explains the status represented by each color at the Pump Summary screen.

Color	Label	Description
Gray outline	Offline	Pump is not enabled. The controller ignores any alarms.
Yellow	Ready	Pump is off, waiting for demand from a station.
Blue	Idle	Pump is on, waiting for demand from a station. If there is no demand before the end of the auto shutdown delay, the pump will turn off.
Green	Loading	Pump is conveying material to a station.
Blue, blinking	Blow Back	Pump's air filter is being cleaned by blowing compressed air backward through it.
Red, blinking	Alarm	Pump is in alarm.
Red outline, blinking	Critical	Pump is in critical alarm. The controller has disabled the pump until the alarm is cleared.

Additional information about each pump, including configuration settings and the number of hours the pump has been running, is available at the Pump *n* Setup screen. For details on configuration settings, see p. 78. For details on the hour meter, see p. 65.

Logging On and Logging Off

Your controller may be set up to require a password for any operation (other than reviewing station and pump status, silencing alarms, reviewing the alarm log, and looking at help screens). If so, a keypad appears when you touch a button for a screen that requires a password:

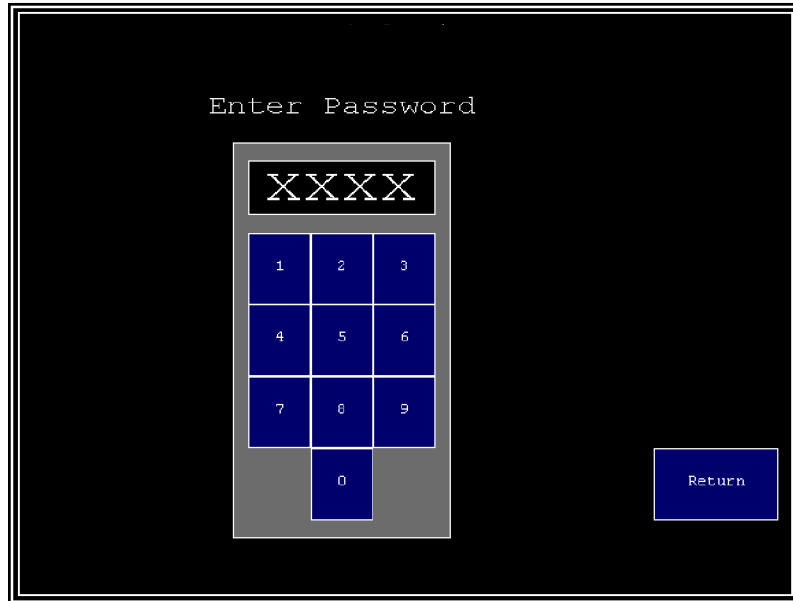

- Enter the four-digit password (including any leading zeros). For example, if the password is 1, enter **0001**.

Each digit appears as an “X” as you touch it. When you touch the fourth digit, the controller carries out your request. For example, it enables or disables the requested pump or station, or it goes to the Station *n* Operator screen. If you did not enter the correct password, the controller erases the entry. You can then try again. To give up, touch **Return**.

Note: *If you have lost the password(s), contact the manufacturer for assistance.*

Once you have logged on, the password remains active until you log off or the password expires. (Setup personnel at your facility control the number of minutes before the password expires.) While the password is active, you can continue to carry out password-protected tasks without reentering the password. If the timer expires, the controller goes to the Station Summary screen and you must reenter the password to continue working.

When you have finished any tasks that require the password, you should log off. (If you forget to do this, the controller will log you off when the password expires.) To log off:

1. Go to a Station Operator screen.
To reach this screen, go to the Station Summary if needed by touching **Stations** at any screen. Then touch and hold the icon for any station until its Station Operator screen appears.
2. Touch **Log Off Operator** near the lower right of the screen.
The Station Summary screen appears.

Enabling and Disabling Stations and Pumps

When a station or pump is disabled, the controller makes no attempt to use it and ignores any alarms that occur for it. Disabling a station or pump at the controller's screen is similar to bypassing a station with its bypass switch. Enabling a station or pump makes it available for use. (For a station to be available for the system, it must be enabled at the controller's screen *and* its bypass switch must be in the "0" position.)

To enable or disable a station (or pump):

1. Go to the Station Summary (or Pump Summary) screen, if needed.

To reach this screen from any other screen, touch **Stations** (or **Pumps**) on the right-hand side of the screen.

Each disabled station (or pump) has an icon with a status of "offline" (black with a gray outline). All other statuses are enabled statuses.

2. Touch the icon for the station (or pump) briefly.

The station (or pump) switches to the new state, as indicated by the color of its icon.

Note: *If the Station n Operator (or Pump n Setup) screen appears when you touch the icon, then you have kept your finger on the screen too long. Touch Stations (or Pumps) to return to the Summary screen and try again. If you find it difficult to touch the icon briefly enough, ask the setup personnel at your facility to lengthen the touch switch delay.*

Reviewing and Adjusting Basic Station Settings

Reaching and Reading the Station Operator Screens

The 7/50D Plus or 7/50D Controller has a Station Operator screen for each station, as shown below. This screen enables you to review and adjust all basic settings for the station.

To reach the Station *n* Operator screen:

1. Go to the Station Summary screen, if needed.
To reach this screen from any other screen, touch **Stations** on the right-hand side of the screen.
2. Touch and hold the icon for the station, until the controller either prompts for the password or displays the Station *n* Operator screen.

Once you have entered the password (if needed), the Station *n* Operator screen appears:

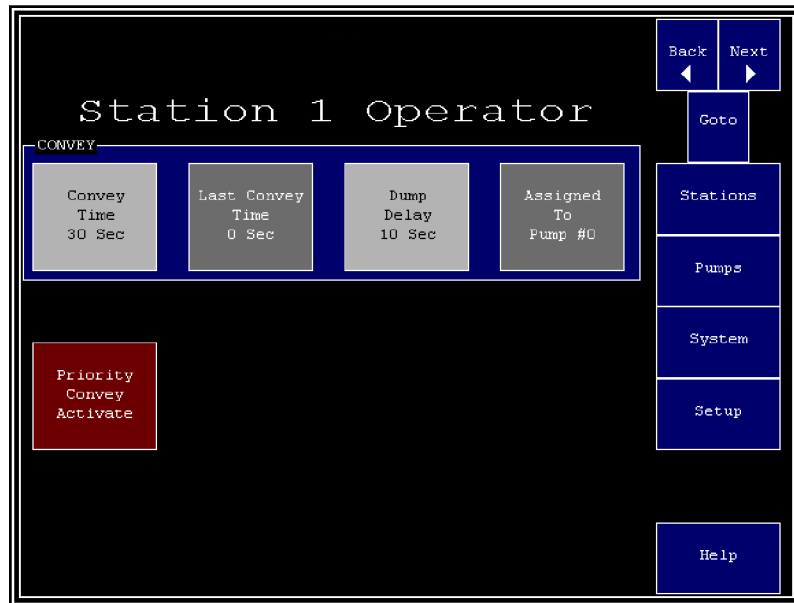

Settings in the box labeled **Convey**, the red **Priority Convey Activate** button, and the menu controls on the right-hand side of the screen appear for all stations. The other options in this screen appear if and only if the station has these features enabled.

Buttons in light gray are settings that you can adjust at this screen. Boxes in dark gray are for display only. If a pump assignment or purge setting needs to be changed, this must be done at the Station *n* Setup screen.

Navigating among the Station Operator Screens

The controls in the upper right-hand corner of the screen enable you to move among the Station Operator screens:

1. To display the screen for the next lower-numbered station (for example, to move from the screen for Station 15 to the screen for Station 14), touch **◀ Back**.
2. To display the screen for the next higher-numbered station (for example, to move from the screen for Station 15 to the screen for Station 16), touch **Next ▶**.
3. To display the screen for a specific station, touch **Goto**. A keypad pops up. Enter the number for the desired station. Use ← to erase any mistakes. Use ↵ to enter the value.
4. To exit to the Station Summary (or Pump Summary) screen, touch **Stations** (or **Pumps**).

Adjusting Convey Time and Dump Delay

Convey time is the length of time the station's vacuum valve remains open to allow material to be drawn in. (For a volume-fill station, the valve closes when material covers the station's volume-fill proximity sensor or this time elapses, whichever comes first.)

Dump delay is the length of time allowed for material to drain from the station into its receiver. During this time, the controller does not attempt to deliver any more material to the station.

The settings for convey time and dump delay should match the times actually required to fill and empty the station. The following problems may occur if these settings are incorrect:

1. Material is backing up and causing "high vacuum" alarms (for time-fill stations only): Convey time is too long.
2. System is not keeping up with the demand for material: Convey time is too short, or dump delay is too long.

For your reference, the Station *n* Operator screen shows the length of time the controller actually spent conveying material during the most recent delivery under **Last Convey Time**.

To adjust a station's convey time (or the dump delay):

1. Go to the Station *n* Operator screen (as described on p. 61), or go to the Station *n* Setup screen.
2. Touch Convey Time (or Dump Delay).
A keypad pops up.
3. Enter the number of seconds desired. Use ← to erase any mistakes. Use ↵ to enter the value.

The new setting appears under **Convey Time** (or **Dump Delay**).

Note: *If you change convey time by more than a few seconds for a station with a remote proportioning valve (RPV), notify the setup personnel at your facility. The setting for the RPV's cycle time should be adjusted to divide evenly into the new convey time (see pp. 43 and 77).*

Activating and Stopping Priority Convey for a Station

Note: *Before activating priority convey, make sure that all other stations using the same pump have adequate material in reserve to continue operation. No material will be conveyed to these stations during priority convey.*

If you want the controller to fill a specific station with material immediately, you can activate “priority convey” for that station. When you do so, the controller temporarily dedicates the station’s pump to it, ignoring demands from other stations assigned to that pump. Once the chosen station is full, normal operation resumes.

You can also use this feature to give one station a “head start” by conveying a few loads to it and then stopping the priority convey.

No more than one station for a given pump can be in “priority convey” at once.

To activate priority convey:

1. Go to the Station *n* Operator screen (as described on p. 61), or go to the Station *n* Setup screen.
2. Touch Priority Convey Activate.

The button changes to **Priority Convey Active** and blinks until the station’s demand has been satisfied (or you stop the priority convey). The controller begins filling the chosen station only (after finishing any convey already in progress).

To stop a priority convey before the station is completely full:

1. Touch the blinking Priority Convey Active.

The button changes to **Priority Convey Activate** and stops blinking. The controller finishes the current convey, if any, and resumes normal operation.

Changing the Mixture for a Remote Proportioning Valve

A remote proportioning valve (RPV) mixes two different materials, typically virgin and regrind materials, during a convey cycle. If present, this valve may be set up so that you control the mix with a timer at the station, or it may be set up so that you control the mix with the controller’s touch screen. The instructions here apply only for controlling the mixture from the touch screen.

The controller refers to the two materials as Material A (primary) and Material B (additive). The system is set up so that, if there are any inaccuracies in the proportions, the mix will contain more Material A and less Material B.

To change the mixture for the remote proportioning valve:

1. Go to the Station *n* Operator screen (as described on p. 61), or go to the Station *n* Setup screen.
2. Touch RPV Material B.
A keypad pops up.
3. Enter the desired percentage for the additive material. Use ← to erase any mistakes. Use ↵ to enter the value.

The new setting appears under **RPV Material B**.

Changing the Line with Material Proofing

When this option is enabled, the controller issues an alarm for the station if the number for “Material set to” does not match that of the actual material. These numbers refer to material lines.

To change the line when using material proofing:

1. Go to the Station Summary screen (if needed) by touching **Stations** on the right-hand side of any other screen.
2. Disable the station (take it offline) by touching its icon briefly.
The icon becomes black with a gray outline.
3. Switch lines physically.
4. At the controller, go to the Station *n* Operator screen (as described on p. 61), or go to the Station *n* Setup screen.
5. Touch **Material Set To**.
A keypad pops up.
6. Enter the number for the new material line. Use ← to erase any mistakes. Use ↵ to enter the value.
The new setting appears under **Material Set To**.
7. Touch **Stations**.
The Station Summary screen appears.
8. Enable the station (put it online) by touching its icon briefly.
The color of the icon changes to show the new status.

4-4 Advanced Tasks

This section describes the procedures carried out during operation that are normally reserved for setup personnel. These procedures require use of the setup password (if your facility has defined one). The procedure for logging on with the setup password is the same as for logging on with the operator password; see p. 59. Logging off is also the same, except that operators can log off only at the Station *n* Operator screen, while most screens accessible to setup personnel offer **Log Off** as an option.

You can also change the setup for stations, pumps, and the system during operation. See Chapter 4, “System Setup,” for information on the procedures and options.

Reviewing and Resetting a Pump Hour Meter

The controller keeps two meters for the length of time a pump has run. One, like a car's odometer, keeps a running total and cannot be reset. The other, like a car's trip odometer, counts the running time since the last reset.

To review and reset the hour meter:

1. At any screen, touch **Pumps**.
The Pump Summary screen appears.
2. Touch and hold the icon for the pump.
The Pump *n* Setup screen appears:

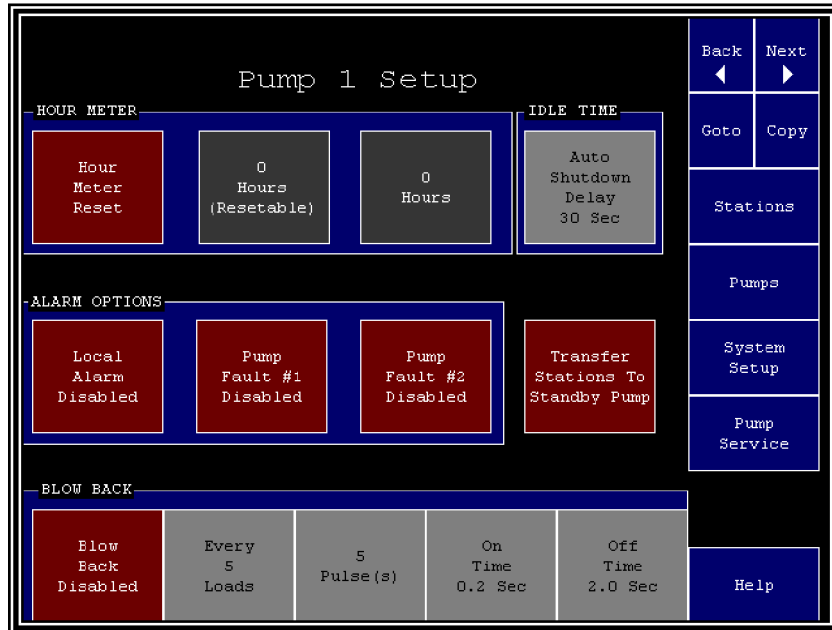

The box labeled **x Hours (Resettable)** shows the running time since the last reset. The box labeled **x Hours (Not Resettable)** shows total running time.

3. To reset the resettable meter, touch **Hour Meter Reset**.
The time above **Hours (Resettable)** changes to 0.

Transferring Stations to a Standby Pump

If a pump fails, you can transfer all of the controller's station assignments for that pump to a standby pump. To do this, you must disable (take offline) both the source pump and the standby pump, and the standby pump must have no stations already assigned to it.

The transfer operation at the controller's touch screen merely changes the pump assignment for every station on the failed pump. It does not transfer any pumps settings for auto shutdown delay, alarms, or blow-back to the standby pump. Mechanical connections must be changed manually.

To transfer stations from a pump to a standby pump:

1. At any screen, touch **Pumps**.

The Pump Summary screen appears.

2. Both the source pump and the standby pump must be offline. If either pump is any other state, disable it by touching its icon briefly.

The icon becomes black with a gray outline.

3. Move the vacuum hose from the failed pump to the standby pump, and carry out any other mechanical procedures needed to use the standby pump.

4. At the Pump Summary screen, touch and hold the icon for any pump until the Pump *n* Setup screen appears.

5. At the Pump *n* Setup screen, touch **Transfer Stations To Standby Pump**.

The Transfer to Standby Pump screen appears:

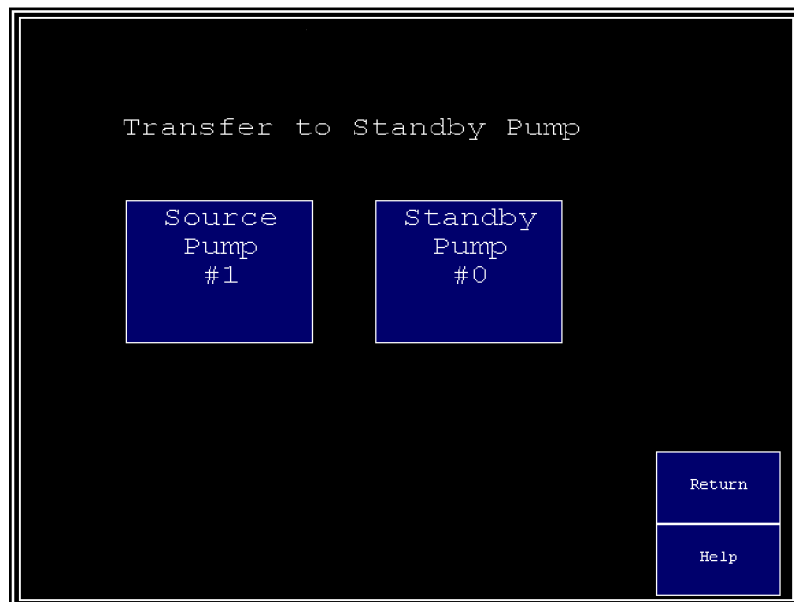

1. Touch Source Pump.
The keypad pops up.
2. Enter the number of the failed pump. Use ← to erase any mistakes. Use ↵ to enter the value.
The number appears under **Source Pump**.
3. Touch Standby Pump.
The keypad pops up.
4. Enter the number of the standby pump. Use ← to erase any mistakes. Use ↵ to enter the value.
The number appears under **Standby Pump**, and a button labeled **Transfer to Standby Pump** appears on the screen:

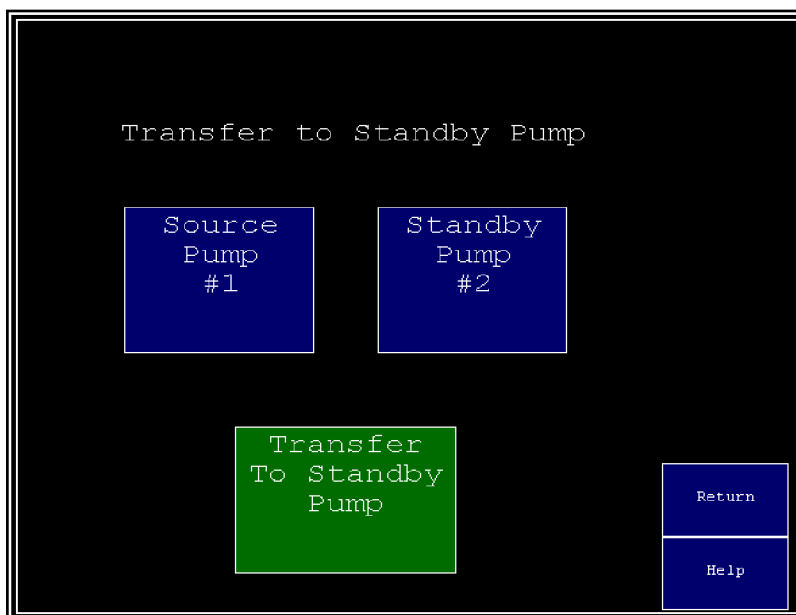

Note: *When you enter the second pump number, the controller checks to make sure that both pumps are offline and that the standby pump has no stations assigned to it. If these conditions are not all met, error messages appear on the screen instead of a Transfer to Standby Pump button. If you get an error message, first check to make sure that you have entered the correct numbers and reenter if necessary.*

If the error message tells you to disable the source pump and/or the standby pump, touch **Return** at this screen, then **Pumps** at the Pump *n* Setup screen. Take the pumps offline and then return to the Transfer to Standby Pump screen.

If the error message tells you that the standby pump has stations assigned, you must either use a different standby pump or you must remove the pump assignment for all stations assigned to the standby pump. To remove the assignments, touch **Return** at this screen, then **Stations** at the Pump *n* Setup screen.

Hold a station icon to go to its Station Operator screen, then touch Setup to go to the Station *n* Setup screen. Use ◀ **Back** and **Next** ▶ to review all pump assignments and, where necessary, choose **Assigned to Pump x** to set station assignments to 0 (unassigned). Then return to the Transfer to Standby Pump screen.

1. Touch Transfer To Standby Pump.

“Transfer in Progress” appears briefly on the screen, followed by “Transfer Complete,” in place of the **Transfer To Standby Pump** button. The controller switches the setting for **Source Pump** to the new pump and switches the setting for **Standby Pump** to 0 (unassigned).

2. Touch **Return**.

The Pump *n* Setup screen appears.

3. Touch **Pumps**.

The Pump Summary screen appears.

4. Put the standby pump online by briefly touching its icon.

The icon changes color to show the new status, and the system begins using the pump. In addition, all Station *n* Operator and Setup screens show the new pump assignment.

When the failed pump is operational again, you can repeat this process, this time using the standby pump’s number as the setting for **Source Pump** the repaired pump’s number as the setting for **Standby Pump**.

3-5 Alarms

Reviewing Alarms

At the Station Summary or Pump Summary screen:

1. Touch **Alarms**.

The Alarm Log screen appears, with the newest alarm listed first:

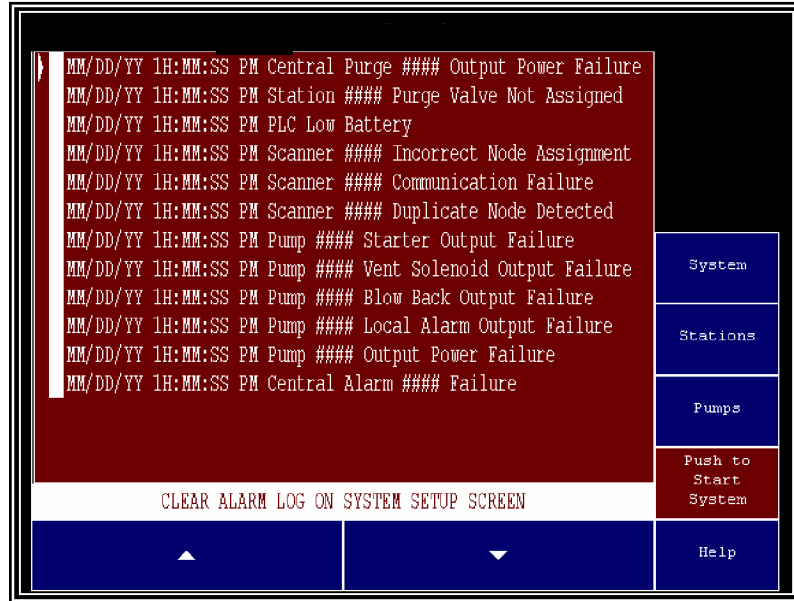

To scroll up and down through the list:

- Touch ▲ and ▼ at the bottom of the list.

Clearing the Alarm Log

The controller saves all alarm messages, together with the date and time the alarm occurred. When you no longer need the history, or when the list becomes too long to manage, you can erase the log. To do so:

1. At the Station Summary or Pump Summary screen, touch **Alarms**.

The Alarm Log appears.

2. Touch **System** on the right-hand side of the screen.

The System Setup screen appears:

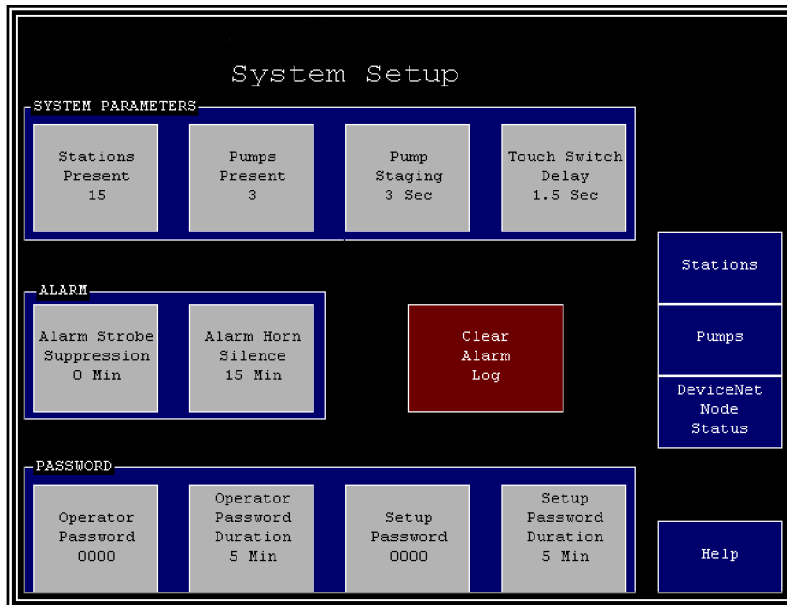

3. Touch Clear Alarm Log.

A warning message pops up, asking for confirmation.

4. Touch **Continue**.

The System Setup screen appears. To confirm that the log has been erased, you can return to the Station Summary or Pump Summary screen and touch **Alarms**.

Silencing Alarms

Whenever a new alarm occurs, your controller sounds the horn and turns on the strobe light at each central alarm. If the alarm is for a specific station or pump, and if the station or pump has a local alarm, the controller also turns on the local alarm light. In addition, the manufacturers' logo on the controller's screen changes to an **Alarm Silence** button.

To silence the alarm:

1. Touch **Alarm Silence** in the lower right-hand corner of the screen.

The horns and lights at the central alarms turn off. (The local alarm light stays on.) The button changes back to the company logo. Your controller has separate, configurable settings for how long the horns should remain silent and how long the lights should remain off. If the alarm condition still exists when either of these times elapses, the corresponding devices (horns or lights) turn on again. If a new alarm occurs, both the horns and the lights turn on.

Chapter 5: Maintenance

5-1 Preventative Maintenance

No preventative maintenance is required on this unit.

5-2 Corrective Maintenance

Network Scanner Module Considerations

The manufacturer includes a network scanner software diskette with your controller; this diskette and instructions are located in your Customer Information Packet. Keep this diskette and the instructions in a safe place.

Should the network scanner module require replacement, use the scanner software to restore the program. You can:

- Purchase a programmed replacement scanner module from the manufacturer
- In extreme cases, you can purchase the module from your local Allen-Bradley dealer and program it yourself with the scanner software diskette; you can also have your A-B dealer do that for you

We suggest that you have a preprogrammed spare network scanner module on hand for such conditions.

Chapter 6: Configurable Settings

This section describes the proper setup of the 7/50D Plus or 7/50D control system parameters. These parameters are operator changeable; however, these items should require setup only during the initial installation. Only authorized personnel should change them.

Many of the variables and setup parameters have been preset at the factory and do not need to be changed. However, this section of the manual will address all of the setup parameters that were available at the time of printing. The purpose of this is to familiarize the reader with all the setup parameters and their usage.

6-1 Memory Module Considerations

The operator interface and the PLC central processing unit use memory modules to store the operating program. The modules are installed in the back of the controller interface chassis and on the PLC CPU card.

The memory module returns the controller to the factory default settings if an electrical fault occurs, or if the hardware is replaced. ***Keep in mind that this condition is extremely rare.*** You will then need to set up the controller once again with the settings you programmed in this chapter.

6-2 Options for Station Setup

Name	Description	Options	Default
Conveying Options			
Convey time	Length of time the station's vacuum valve remains open to allow material to be drawn in. (For a volume-fill station, the valve closes when material covers the station's volume-fill proximity sensor or this time elapses, whichever comes first.) Adjust this value to match the actual time needed to fill the station.	1–999 sec.	30 sec.
(Last convey time)	<i>Display only.</i> Length of time the station's vacuum valve was open for receiving material during the most recent convey. This information is displayed for your reference when adjusting convey time and dump delay.	—	—
Dump delay	Length of time allowed for material to drain from the station into the receiver. The controller will not attempt to deliver more material to the station until this time has elapsed. Adjust this value to match the actual time needed to drain the station. If it is set too short, the controller may attempt to refill the station before it is empty, causing material to back up and/or underusing the station's capacity. If it is set too long, the system may be unable to keep up with your equipment's demand for material.	1–99 sec.	10 sec.

Name	Description	Options	Default
Conveying Options			
Assigned to pump <i>n</i>	Number (address) of the pump to which this station's vacuum line is connected. No more than 20 stations can be assigned to one pump.	0–7 (0 = not assigned)	0
Volume fill	When this option is enabled, the station's vacuum valve closes when material covers the station's proximity sensor or the convey time elapses, whichever comes first. When disabled, the station's vacuum valve remains open until the convey time has elapsed. Enable this option for volume-fill stations and disable it for time-fill stations.	disabled, enabled	disabled
Special convey	When this option is enabled, the station's vacuum valve remains open for the convey time, even if the station is not demanding material and is indicating that it is full. When disabled, the station's vacuum valve opens when there is demand from the station, and it remains open until the convey time has elapsed or material trips the volume-fill proximity switch. Enable this option if and only if the station has no flapper.	disabled, enabled	disabled
Alarm Options			
No convey	When this option is enabled, the controller issues a "no convey" alarm if it has repeatedly attempted to convey material to the station but the flapper never opened during the dump delay. (The number of attempts is controlled by the next setting.) Usually this option should be enabled. At times, you may wish to disable it during operation as a stopgap measure for dealing with an alarm.	disabled, enabled	disabled
# attempts B4 alarm	Number of attempts before alarm: the number of times the controller will attempt to convey material to a station before it issues a "no convey" alarm. The setting for this option depends on (a) how much material your injection mold uses to make each part compared with the capacity of the receiver and (b) how important it is to keep your injection mold from running out of material and shutting down. A higher setting will give you fewer alarms, at the risk of emptying the receiver without warning. A lower setting will give more frequent alarms, at the risk of disrupting operations unnecessarily.	1–99	3

Name	Description	Options	Default
Partial convey	When this option is enabled, the controller issues a “partial convey” alarm if it has repeatedly attempted to convey material to the station, and material has moved from the station into the receiver, but the volume-fill proximity sensor has never signaled that the station is full. (The number of attempts is controlled by the next setting.) For a volume-fill station, this option should usually be enabled. At times, you may wish to disable it during operation as a stopgap measure for dealing with an alarm. For a time-fill station, disable this option.	disabled, enabled	disabled
Alarm Options			
# attempts B4 alarm	Number of attempts before alarm: the number of times the controller will attempt to convey material to a station before it issues a “partial convey” alarm. The setting for this option depends on the same considerations as those given above for number of attempts before a “no convey” alarm.	1–99	3
Local alarm	When this option is enabled, the controller turns on the local alarm light for any alarm at this specific station. Enable this option if and only if your facility has installed a local alarm light for this station.	disabled, enabled	disabled
Miscellaneous Options			
Receiver low level	When this option is enabled, the controller issues a “receiver level” alarm if material in the receiver drains below the level of the receiver’s low-level sensor. Enable this option if and only if your facility has installed a low-level sensor for this station’s receiver. At times, you may wish to disable it during operation as a stopgap measure for dealing with an alarm.	disabled, enabled	disabled
Blow Back Options (Only available on 7/50D Plus systems)			
Blow back	When this option is enabled, the controller periodically sends compressed air backward through the station’s air filter to dislodge accumulated dust and debris. Enable this option if and only if the station has the equipment for compressed-air filter cleaning.	disabled, enabled	disabled
Every <i>n</i> loads	Number of conveying cycles between filter cleanings. Adjust this setting based on experience. The more dust and debris in your material line, the smaller this number needs to be.	1–99	5
# pulses	Number of pulses of compressed air sent through the station’s filter during cleaning. If blow-back is not working as desired, the service department may ask you to change this setting.	1–99	5

Name	Description	Options	Default
On time	Number of seconds that the each air pulse lasts during filter cleaning. If blow-back is not working as desired, the service department may ask you to change this setting.	0.1–99.0 sec.	1.0 sec.
Off time	Number of seconds between air pulses during filter cleaning. If blow-back is not working as desired, the service department may ask you to change this setting.	0.5–99.0 sec.	1.0 sec.
Slide Gate Options (Only available on 7/50D Plus systems)			
Slide gate	When this option is enabled, the controller opens the slide gate between the station and the receiver during the dump delay and during blow-back. Enable this option if and only if the station has a slide gate instead of a flapper and demand switch.	disabled, enabled	disabled
Purge Options			
Purge	When enabled, this option allows the system to empty the material line completely after every convey to this station. The station's pump continues to draw without picking up material for an extra period of time after conveying is finished. Enable this option if and only if you are using a purge valve for this station. This option cannot be used with a volume-fill station.	disabled, enabled	disabled
Purge duration	Number of seconds allowed for purging. The station's vacuum valve remains open for the convey time plus this time. Adjust this setting to the amount of time required for material to travel from the pickup point (purge valve) to the station.	Ø–999 sec.	20 sec.
Purge valve	Number (address) for the purge valve used with this station. Set this to match the number (address) for the purge valve that services this station. If another station has the purge valve that services this station, enter the number of that station (range: 1–50). If a central purge valve services this station, enter the number (address) of that valve (range: 51–154).	1–154	0 (= not assigned)
Material Proofing Options			
Material proofing	When this option is enabled, the controller issues an alarm for the station if the number for "Material set to" does not match the number for the actual material. These numbers refer to material lines. Enable this option if and only if your facility has installed the option of material proofing and you want to check the material line connected to this station.	disabled, enabled	disabled

Name	Description	Options	Default
Material set to <i>n</i>	Number for the material line that should be connected to this station.	Ø –150	0 (= not assigned)
(Material actual)	<i>Display only.</i> Number (address) for the material line that is actually connected to this station. This information is displayed for your reference in troubleshooting.	—	—
RPV Options			
RPV (Remote Proportioning Valve)	This option allows the system to use a remote proportioning valve to mix two different materials, typically virgin and regrind materials, during a convey cycle. Touching RPV repeatedly at the Station <i>n</i> Setup screen steps through the three choices. Enable this option with PLC control if you will be adjusting the mix from the controller's touch screen. Enable this option with local control if the station operator will be adjusting the mix using a timer box at the station.	disabled, enabled PLC, enabled local	disabled
RPV material B	Percentage of the additive material to be included in the mix. This setting applies only when RPV is enabled with PLC control. The system is set up so that, if there are any inaccuracies in the proportions, the mix will contain more Material A and less Material B than specified here.	Ø –99%	30%
Cycle time	Number of seconds for each cycle in depositing Material A and Material B during the convey time. This setting applies only when RPV is enabled with PLC control. <i>Example:</i> If you set convey time to 30 seconds, cycle time to 10 seconds, and Material B to 30% (so Material A is 70%), the system will convey as follows: Material A for 7 seconds Material B for 3 seconds (end cycle 1) Material A for 7 seconds Material B for 3 seconds (end cycle 2) Material A for 7 seconds Material B for 3 seconds (end cycle 3) In a volume-fill station, a cycle will be truncated before completion if the station becomes full. The cycle time should divide evenly into the convey time.	5–999 sec.	10 sec.

6-3 Options for Pump Setup

Several of the items in this screen are not setup options but are instead intended for use during operation. These items (hour meter and transferring stations to a standby pump) are described in Chapter 4, "Operation."

Name	Description	Options	Default
Idle Time Options			
Auto shutdown delay	Length of time the pump continues to run unloaded without demand from any station. After this time has elapsed, the pump shuts down to save power and to prevent wear on the pump. Adjust this setting to fit the needs of your facility in trading off the savings against the costs associated with waiting for a pump to start up when there is a demand for material.	0–999 sec.	45 sec.
Alarm Options			
Local alarm	When this option is enabled, the controller turns on the local alarm light for any alarm at this specific pump. Enable this option if and only if your facility has installed a local alarm light for this pump.	disabled, enabled	disabled
Pump fault #1	The ArmorBlock for each pump has two inputs that you can wire to generate alarms for situations of your choosing. For example, you may have a sensor that turns on when material reaches the top of a filter-chamber waste bin. When this option is enabled, the controller issues an alarm if the sensor wired to the input for Pump Fault #1 turns on. Enable this option if and only if your facility has installed a miscellaneous alarm on the input for Pump Fault #1 for this pump.	disabled, enabled	disabled
Pump fault #2	See the explanation for Pump fault #1 above. Enable this option if and only if your facility has installed a miscellaneous alarm on the input for Pump Fault #2 for this pump.	disabled, enabled	disabled
Blow Back Options			
Blow back	When this option is enabled, the controller periodically sends compressed air backward through the pump's air filter to dislodge accumulated dust and debris. Enable this option if and only if the pump has the equipment for compressed-air filter cleaning.	disabled, enabled	disabled
Every <i>n</i> loads	Number of conveying cycles to stations between filter cleanings. Adjust this setting based on experience. The more dust and debris in your material line, the smaller this number needs to be.	1–99	5
# pulses	Number of pulses of compressed air sent through the pump's filter during cleaning. If blow-back is not working as desired, the service department may ask you to change this setting.	1–99	5

Name	Description	Options	Default
On time	Number of seconds that the air compressor remains on for each pulse during filter cleaning. If blow-back is not working as desired, the service department may ask you to change this setting.	0.1–99.0 sec.	1.0 sec.
Off time	Number of seconds between air pulses during filter cleaning. If blow-back is not working as desired, the service department may ask you to change this setting.	0.5–99.0 sec.	1.0 sec.

Chapter 7: Troubleshooting

7-1 General Troubleshooting

Problem	Possible cause	Solution
The controller panel doesn't light up at all.	The controller panel is not plugged in.	Plug in the controller panel.
	The external disconnect (recommended) in the dedicated circuit is open (off).	Close the switch (on).
	Fuse/circuit breaker in the power drop is blown/tripped.	Replace/reset.
	Broken controller power switch.	Replace.
A pump package doesn't run, even though it is on line and its indicator is lit.	The motor circuit breaker/ overload has tripped.	Reset the circuit breaker and check the motor for the proper amp draw on tag.
	Main fuse in power drop circuit breaker has blown.	Replace the fuse/reset circuit breaker.
	Motor contact is faulty.	Repair or replace as required.
A vacuum hopper is being bypassed in the loading cycle.	The bin below it is full if its amber indicator light is off.	Normal operation. When the level drops, material conveys to the hopper.
	The hopper is off line.	Using the controller, place the hopper on line.
	The field-installed station bypass switch is simulating a Bin Full condition.	Normal operation. Set the switch so the hopper is back in the loading sequence.
	The field-installed station bypass switch is bad or mis-wired.	Repair, replace, or rewire.
Vacuum hoppers are over-filling.	Conveying times are too long (Time Fill mode only).	Time the hopper(s) during loading, and set conveying times to a few seconds less.
	Maximum conveying times are too long and/or the controller does not recognize the Hopper Full proximity switch(es).	Check proximity sensors for proper operation. Repair as needed. Reset the conveying times to a reasonable value, and adjust as needed.
Controller blows fuses.	Power supply shorting out.	Repair shorting circuit.
	Improper fuse installed.	Replace fuse with one that has a proper rating.

7-2 Alarms

The format for all station alarms is “Station *n* [alarm text],” for example, “Station 12 receiver low level.” The format for all pump alarms is “Pump *n* [alarm text].” Any alarm that does *not* start with “Station” or “Pump” is a system alarm.

The following tables list all alarms alphabetically, together with possible causes. A “critical” alarm is one that causes the affected device to stop.

Note: *You can also see a list of alarms and their causes in the controller’s online help. To display this information, touch the color key of statuses in the upper right-hand corner of either the Station Summary or the Pump Summary screen, or touch Help at any other screen. When you are finished reviewing the help, touch Return.*

Station Alarms

Alarm message	Possible cause
Blow back output failure (Critical)	Solenoid patch cord is disconnected.
	Solenoid patch cord has been cut.
	Solenoid valve has malfunctioned.
High vacuum	Material line is blocked.
	Vacuum line is blocked.
	Convey time is too long (time-fill station only).
	Sequence valve has malfunctioned.
	Vacuum switch has malfunctioned.
	Note: After you have corrected the cause of this alarm, the alarm will be cleared when the controller has conveyed a full load to this station.
Local alarm output failure	Local alarm’s light bulb is defective.
	Patch cord for local alarm is disconnected.
	Patch cord for local alarm has been cut.
	Note: As a stopgap measure, you can disable the alarm output for this station until the problem can be remedied. See pp. 43 and 74.
No convey	Material container is empty.
	Material line is disconnected from material source.
	Vacuum line is disconnected from station.
	Take-off compartment is not adjusted properly.
	Convey time is too short.
	Note: As a stopgap measure, you can disable the “no convey” alarm for this station until the problem can be remedied. See pp. 43 and 74.
Not assigned to a pump (Critical)	Station has not been assigned to a pump
Not present (Critical)	ArmorBlock is not installed.
	ArmorBlock is not addressed properly.
	ArmorBlock is defective.
	Base of ArmorBlock is defective.
	Network flat cable is not installed in base properly
Output power failure (Critical)	Power supply is not turned on.
	Power supply is not connected properly
	Power supply’s incoming fuse(s) have failed.
	Power supply’s output circuit breaker has tripped.
	ArmorBlock is defective.
	Base of ArmorBlock is defective.
	Power flat cable for network is not installed in ArmorBlock base properly

Alarm message	Possible cause
Partial convey	Pick-up wand is not positioned properly.
	Convey time is too short.
	Take-off compartment is not adjusted properly.
	Vacuum line has a leak.
	Note: As a stopgap measure, you can disable the “partial convey” alarm for this station until the problem can be remedied. See pp. 43 and 74.
Purge output failure (Critical)	Solenoid patch cord is disconnected.
	Solenoid patch cord has been cut.
	Solenoid valve has failed.
Purge valve not assigned (Critical)	Station has not been assigned to a purge valve
Receiver low level	Conveying system has malfunctioned.
	Station has been disabled at controller’s touch screen.
	Station’s bypass switch is active.
	Note: As a stopgap measure, you can disable the “receiver low level” alarm for this station until the problem can be remedied. See pp. 43 and 75.
RPV material A failure (Critical)	Patch cord for remote proportioning valve is disconnected.
	Patch cord for remote proportioning valve has been cut.
	Solenoid A for remote proportioning valve has malfunctioned.
RPV material B failure (Critical)	Patch cord for remote proportioning valve is disconnected.
	Patch cord for remote proportioning valve has been cut.
	Solenoid B for remote proportioning valve has malfunctioned.
Sequence valve output failure (Critical)	Patch cord for sequence valve is disconnected.
	Patch cord for sequence valve has been cut.
	Solenoid for sequence valve has malfunctioned.
Slide gate output failure (Critical)	Patch cord for slide gate is disconnected.
	Patch cord for slide gate has been cut.
	Solenoid for slide gate has failed.

Pump Alarms

Alarm message	Possible cause
Blow back output failure (Critical)	Patch cord for solenoid for blow back valve is disconnected.
	Patch cord for solenoid for blow back valve valve has been cut.
	Solenoid for blow-back valve has malfunctioned.
Local alarm output failure	Local alarm’s light bulb is defective.
	Patch cord for local alarm is disconnected.
	Patch cord for local alarm has been cut.
	Note: As a stopgap measure, you can disable the local alarm output for this pump until the problem can be remedied. See pp. 47 and 48.
Not present (Critical)	ArmorBlock is not installed.
	ArmorBlock is not addressed properly.
	ArmorBlock is defective.
	Base of ArmorBlock is defective.
	Network flat cable is not installed in base properly
Output power failure (Critical)	Power supply is not turned on.
	Power supply is not connected properly
	Power supply’s incoming fuse(s) have failed.
	Power supply’s output circuit breaker has tripped.
	ArmorBlock is defective.
	Base of ArmorBlock is defective.

Alarm message	Possible cause
Output power failure (Critical)	Power flat cable for network is not installed in ArmorBlock base properly
Pump failure (Critical)	Circuit breaker or overload protector has tripped. Contactor has malfunctioned.
Pump fault #1	(Function determined by your facility.)
Pump fault #2	(Function determined by your facility.)
Pump starter output failure (Critical)	Patch cord for contactor is disconnected. Patch cord for contactor has been cut. Contactor coil is defective.
Vent solenoid output failure (Critical)	Patch cord for vent is disconnected. Patch cord for vent has been cut. Vent solenoid valve has malfunctioned.

System Alarms

Alarm message	Possible cause
Central alarm failure	Patch cord for horn or strobe light is disconnected. Patch cord for horn or strobe light has been cut. All horns and strobe lights for this central alarm are defective.
Centralized purge output power failure (Critical)	Power supply for a centralized purge valve is not turned on. Power supply for a centralized purge is not connected properly. An ArmorBlock for centralized purge valves is defective. Base of an ArmorBlock for centralized purge valves is defective. Power flat cable for network is not properly installed in the base of an ArmorBlock for centralized purge valves.
Centralized purge valve failure (Critical)	Patch cord for a centralized purge valve is disconnected. Patch cord for a centralized purge valve has been cut. Solenoid for a centralized purge valve has malfunctioned. An ArmorBlock for centralized purge valves is defective. Base of an ArmorBlock for centralized purge valves is defective. Network flat cable is not properly installed in the base of an ArmorBlock for centralized purge valves. Note: Once you have found and corrected the cause of this alarm, enable a station (p. 60) that uses the purge valve for which the alarm occurred. (To identify such a station, go to a Station Operator screen (p. 61) and navigate among the stations (p. 62) until you find a station assigned to this purge valve.) Once the system successfully uses this purge valve, it clears the alarm and enables all other stations that use this valve.
PLC low battery	Battery for the controller is defective. Battery for the controller is old and drained.
Scanner communication failure (Critical)	Power supply for network is not turned on. Power supply for network is not connected properly. Main enclosure is not connected properly. DeviceNet scanner is defective.
Scanner duplicate node (Critical)	Two nodes (stations, pumps, central alarms, or centralized purge valves) are assigned the same address.
Scanner incorrect node assignment (Critical)	The ArmorBlock for a pump has an address for a station. The ArmorBlock for a central alarm has an address for a station. The ArmorBlock for a station has an address for a pump.

Chapter 8: Appendix

8-1 Warranty

The manufacturer warrants all equipment manufactured by it to be free from defects in workmanship and material when used under recommended conditions. The company's obligation is limited to repair or replace FOB the factory any parts that are returned prepaid within one year of equipment shipment to the original purchaser, and which, in the company's opinion, are defective. Any replacement part assumes the unused portion of this warranty.

This parts warranty does not cover any labor charges for replacement of parts, adjustment repairs, or any other work. This warranty does not apply to any equipment which, in the company's opinion, has been subjected to misuse, negligence, or operation in excess of recommended limits, including freezing or which has been repaired or altered without the company's express authorization. If the serial number has been defaced or removed from the component, the warranty on that component is void. Defective parts become the property of the warrantor and are to be returned.

The company is not liable for any incidental, consequential, or special damages or expenses. The company's obligation for parts not furnished as components of its manufactured equipment is limited to the warranty of the manufacturers of said parts.

Any sales, use, excise, or other tax incident to the replacement of parts under this warranty is the responsibility of the purchaser.

The company neither assumes nor authorizes any other persons to assume for it any liability in connection with the sale of its equipment not expressed in this warranty.

Many types of the manufacturer's equipment carry an additional one-year service policy. Consult your sales representative for specific details.

8-2 Optional Components

The following is a list of options that your controller may be equipped with:

230/1/60 Operation. Required to operate with a 230/1/60 supply voltage.

Additional audible/visual alarm with silence button. Alarm light and horn assembly that can be remote mounted and wired into the controller to indicate an alarm condition.

Remote Interface.

Central Purge Capability.

Material Line Proofing

CE Package for 220/1/50 Operation. Required in Europe and other areas that need 220/1/50 supply voltage.

8-3 Drawings and Diagrams

Figure 19: 7 pump 50 station Controller with Display

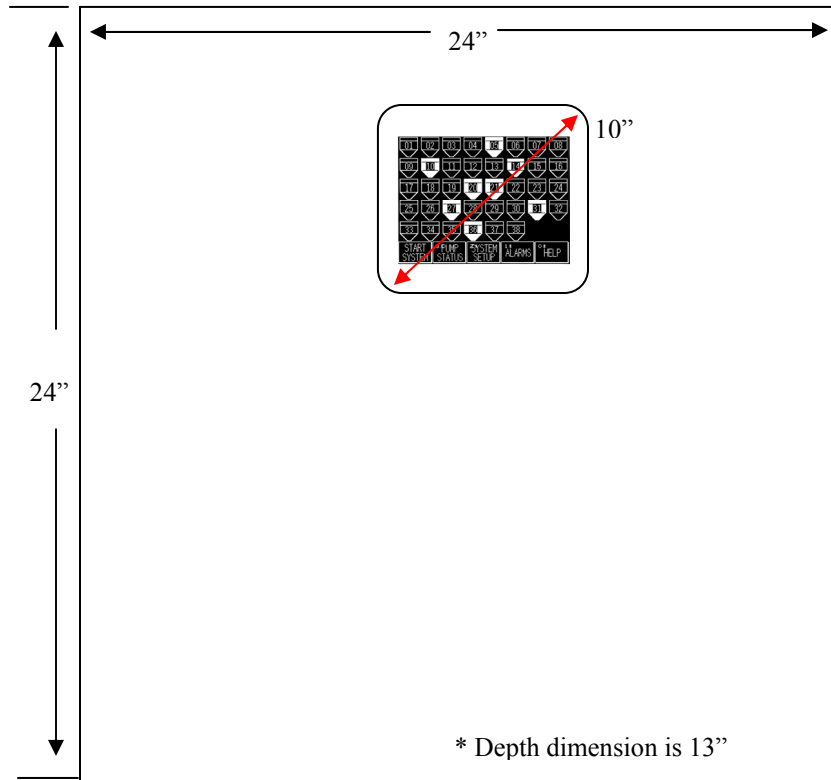

Also, review electrical drawings supplied in the packet with this manual.

Figure 20: Typical System Installation Layout

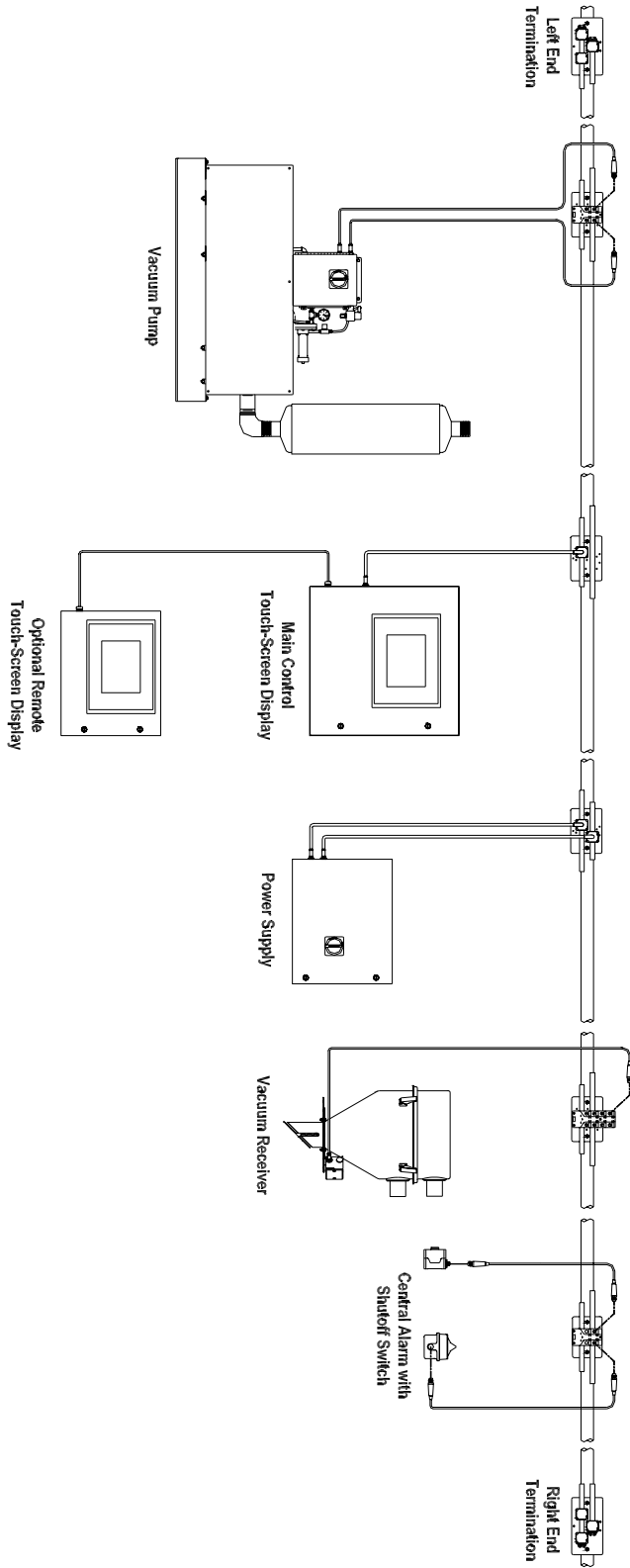

8-4 Spare Parts List

AC Voltage

Quantity	Part Number	Description
1	A0563932	2.1A Power Supply
1	A0569862	Input Card
1	A0572817	Output Card
2	A0569859	Air Grill with Filter
3	A0541611	Fuse, MDL – .75
4	A0540997	Fuse, MDL – 1
1	A0540993	Fuse, MDL – .5
1	A0505812	Fuse, MDL – 1.25

DC Voltage

Quantity	Part Number	Description
1	A0563993	10A Power Supply
1	A0551976	Input Card
1	A0572817	Output Card
2	A0569859	Air Grill with Filter
3	A0540997	Fuse, MDL – 1
4	A0542204	Fuse, MDL – 2.25
1	A0542208	Fuse, MDL – 3.2
1	A0544790	Fuse, MDL - 8

8-5 Returned Material Policy

Credit Returns

Prior to the return of any material, **authorization** must be given by **the manufacturer**. A RMS number will be assigned for the equipment to be returned.

Reason for requesting the return must be given.

All returned material purchased from **the manufacturer** is subject to 15% (\$75.00 minimum) restocking charge.

All returns are to be shipped prepaid.

The invoice number and date or purchase order number and date must be supplied.

No credit will be issued for material that is not within the manufacturer's warranty period and/or in new and unused condition, suitable for resale.

Warranty Returns

Prior to the return of any material, **authorization** must be given by **the manufacturer**. A RMS number will be assigned for the equipment to be returned.

Reason for requesting the return must be given.

All returns are to be shipped prepaid.

The invoice number and date or purchase order number and date must be supplied.

After inspecting the material, a replacement or credit will be given, at **the manufacturer's** discretion, if the item is found to be defective in materials or workmanship. Purchased components are covered under their specific warranty terms.

8-6 Safety Tag Information

Controller Safety Tags



High Voltage Inside
Enclosure



Read Operation and
Installation Manual

8-7 Controller Identification (Serial Number) Tag

(Located on the side of the controller box)

Street Address					
Town, State, Zip Code					
Telephone Number					
Fax Number					
<hr/>					
XXX CONTROL PANEL					
Model No. XXX7-50		Serial No. 31K0182			
<input type="text" value="115"/>	Volt	<input type="text" value="60"/>	Hz	<input type="text" value="1"/>	Ph
Control Voltage 24VDC					
<input type="text"/>					

8-8 Technical Assistance (Contact Information)

Parts Department

Call toll-free 7am–5pm CST [800] 423-3183 or call [630] 595-1060, Fax [630] 475-7005

The ACS Customer Service Group will provide your company with genuine OEM quality parts manufactured to engineering design specifications, which will maximize your equipment's performance and efficiency. To assist in expediting your phone or fax order, please have the model and serial number of your unit when you contact us. A customer replacement parts list is included in this manual for your convenience. ACS welcomes inquiries on all your parts needs and is dedicated to providing excellent customer service.

Service Department

Call toll-free 8am–5pm CST [800] 233-4819 or call [630] 595-1060

Emergencies after 5pm CST, call [847] 439-5655

We have a qualified service department ready to help. Service contracts are available for most products.

Sales Department

Call [630] 595-1060 Monday–Friday, 8am–5pm CST

Our products are sold by a world-wide network of independent sales representatives. Contact our Sales Department for the name of the sales representative nearest you.

Contract Department

Call [630] 595-1060 Monday–Friday, 8am–5pm CST

Let us install your system. The Contract Department offers any or all of these services: project planning; system packages including drawings; equipment, labor, and construction materials; and union or non-union installations.

Free Manuals Download Website

<http://myh66.com>

<http://usermanuals.us>

<http://www.somanuals.com>

<http://www.4manuals.cc>

<http://www.manual-lib.com>

<http://www.404manual.com>

<http://www.luxmanual.com>

<http://aubethermostatmanual.com>

Golf course search by state

<http://golfingnear.com>

Email search by domain

<http://emailbydomain.com>

Auto manuals search

<http://auto.somanuals.com>

TV manuals search

<http://tv.somanuals.com>